

Glitch

Designed by Benoy

8 COLOURS

5 SIZES

3 SURFACES

Glitch is a range of porcelain stoneware tiles developed by Piemme in partnership with one of the biggest international design studios: Benoy. Analysis of trends directed the development of this collection towards “individuality” and the growing desire to “celebrate imperfections”.

CERAMICHE PIEMME
FLOOR AND MORE

Glitch è una gamma di piastrelle in grès porcellanato sviluppata da Piemme in collaborazione con uno dei maggiori studi di design a livello internazionale: Benoy. L'analisi sulle tendenze ha indirizzato lo sviluppo di questa collezione verso "l'individualità" ed il crescente desiderio di "celebrare le imperfezioni".

Glitch ist eine Fliesenserie aus Feinsteinzeug, die Piemme in Kooperation mit dem namhaften Designbüro Benoy entwickelte. Den aktuellen Trends folgend, trug die Gestaltung der Serie dem zunehmenden Wunsch nach „Individualität“ und der „Zelebrierung von Unvollkommenheiten“ Rechnung.

Glitch est une collection de carreaux en grès cérame imaginée par Piemme en collaboration avec l'un des plus prestigieux bureaux de design sur la scène internationale : Benoy. Après une analyse des tendances, le développement de cette collection a été orienté vers « l'individualité » et vers l'envie de « célébrer les imperfections ».

Glitch



Spazi Pubblici
Public Areas

P. 5

Spazi Residenziali
Residential Spaces

P. 27

Informazioni Tecniche
Technical Information

P. 55

Glitch si propone di valorizzare le caratteristiche disomogenee presenti nel calcestruzzo e tutte quelle piccole imperfezioni che caratterizzano questa superficie, come crepe, patine, graffi ed i segni lasciati nel tempo dagli agenti atmosferici; il tutto armonizzato e reinterpretato in chiave ceramica.

Glitch brings out and highlights the heterogeneous nature of concrete, and all those little imperfections characteristic of this surface, such as cracks, patinas, scratches and weathering, all harmonised and reinterpreted as ceramic tiles.

Glitch bringt die Betonoberfläche in ihrer Unvollkommenheit, samt all ihren kleinen Makeln wie Risse, Ablagerungen, Kratzer und Verwitterungserscheinungen zur Geltung und interpretiert sie keramisch in einer stimmigen, zeitgemäßen Optik.

Glitch veut mettre en valeur les hétérogénéités du béton, ainsi que toutes les petites imperfections distinctives de cette surface, comme les craquements, les patines, les rayures et les signes que les agents atmosphériques laissent au fil du temps ; le tout harmonisé et interprété dans une optique céramique.

Spazi Pubblici

Public Areas
 Öffentliche Räumlichkeiten
 Espaces Publics



COLORI / COLOURS

AMBIENTI / AMBIENT

PAGINA / PAGE

Flint / Graphite	Reading Area	6
Fault Carbon / Ash	Hall	8
Sand / Gravel	Conference Room	13
Fault Flint / Carbon	Waiting Room	17
Graphite	Common Room	20
Flint / Carbon	Bathroom	24







Sand / Gravel

A huge range of tones, formats, surface textures and three-dimensional decorative tiles allow designers to offer customisation with even greater individuality.

Ein umfassendes Spektrum an Nuancen, Formaten, Oberflächen und 3D-Dekoren ermöglicht dem Planer individuelle Raumgestaltungen.

Une grande variété de tonalités, formats, trames de surface et décors tridimensionnels laisse carte blanche au designer qui peut ainsi personnaliser la déco en mettant l'accent sur l'individualité.

Una vasta gamma di toni, formati e superfici tridimensionali, consente al progettista di personalizzare il design degli ambienti creando ulteriore individualità.

60×120 - 24"×48" Fault Sand Naturale Rettificato / 60×120 - 24"×48" Sand Naturale Rettificato
120×120 - 48"×48" Gravel Naturale Rettificato



Glitch
Public Areas



Fault Flint / Carbon

Beauty is therefore increasingly sought out in imperfections: the knots in wood, the veining in marble, scratches in leather. These imperfections create a random effect, lending more character and soul to a product compared to the engineered, uniform monotony of standardised products.

So gestaltet sich die Suche nach dem Schönen zunehmend als Suche nach Unvollkommenheiten, etwa nach Aststellen im Holz, Äderungen im Marmor, Kratzern im Leder. Diese Unvollkommenheiten erzeugen Zufalloptiken, die dem Erzeugnis im Gegensatz zum eintönigen, gleichförmigen Standardprodukt einen Charakter verleihen und eine Seele einhauchen.

Autrement dit, c'est maintenant davantage dans l'imperfection que l'on recherche la beauté : les nœuds du bois, les veines du marbre, les éraflures du cuir. Ces imperfections génèrent hasard, apportent caractère et âme au produit, par rapport à la monotonie « manufacturée » et uniforme du produit standard.

La bellezza si ricerca sempre più spesso nell'imperfezione: i nodi nel legno, le venature nel marmo, i graffi nel pellame. Queste imperfezioni creano casualità, donando carattere e anima alle superfici rispetto alla monotonia ingegnerizzata e uniforme del prodotto standard.

60x120 - 24"x48" Fault Flint Naturale Rettificato

60x120 - 24"x48" Carbon Naturale Rettificato



Glitch
Public Areas





Graphite

The 'anti-slip' version of the outdoor surface makes it possible to coordinate outdoor spaces with interior design, creating a very harmonious effect.

Der Flächenbelag für den Außenbereich in trittsicherer Ausführung ermöglicht stimmige Gestaltungslösungen mit harmonischen Übergängen zwischen Innen- und Außenraum.

La surface pour extérieur en version « antidérapante » permet de coordonner les espaces en plein air avec les espaces intérieurs, apportant ainsi une grande harmonie au projet.

La superficie per esterni in versione “antislip” consente di coordinare gli spazi all’aperto con il design degli interni, per una grande armonia progettuale.

60×60 - 24”×24” Graphite Antislip Rettificato



Glitch
Public Areas



Spazi Residenziali

Residential Spaces
Wohnanlagen
Espaces Résidentiels



COLORI / COLOURS

AMBIENTI / AMBIENT

PAGINA / PAGE

Fault Sand / Salt	Living	28
Fault Salt / Salt	Living	33
Clay / Sand	Kitchen	37
Sand / Gravel	Bedroom	41
Gravel / Mix Warm	Bathroom	43
Ash / Fault Ash	Bathroom	47
Salt / Gravel	Terrace	51





Fault Salt / Salt

Floor and wall coverings can be coordinated in many different ways thanks to the vast range of shades and surfaces designed by Benoy for rooms with a discreet, contemporary character.

Vielfältige Kombinierbarkeit zwischen Boden- und Wandbelägen dank der breiten Auswahl an Farben und Oberflächen, die Benoy für Räume mit schlichtem, zeitgemäßem Charakter entwickelte.

La vaste gamme de nuances et de surfaces conçues par Benoy offre une ample coordination des revêtements de sol et de mur, pour créer des espaces au caractère sobre et contemporain.

Ampia coordinabilità fra pavimenti e rivestimenti, grazie alla vasta disponibilità di tonalità e superfici studiate da Benoy per ambienti dal carattere sobrio e contemporaneo.

60×120 - 24"×48" Fault Salt Naturale Rettificato

120×120 - 48"×48" Salt Naturale Rettificato



Glitch
Residential Spaces



Clay / Sand

The result is a contemporary look which can be applied equally to residential environments and to commercial locations.

So entsteht eine zeitgemäße Ästhetik, die sich ebenso gut für den Wohnbereich wie für den Objektbereich eignet.

Le résultat est une esthétique contemporaine qui sied aux applications résidentielles comme commerciales.

Il risultato della collezione Glitch è un'estetica contemporanea che può essere applicata allo stesso modo tanto agli ambienti residenziali quanto a quelli commerciali.

60x120 - 24"x48" Clay - Sand Naturale Rettificato / 60x120 - 24"x48" Fault Clay Naturale Rettificato



Glitch
Residential Spaces



Sand / Gravel

30x60 - 12"x24", 60x60 - 24"x24" Sand Naturale Rettificato
60x120 - 24"x48" Fault Gravel Naturale Rettificato



30x60 - 12"x24", 60x60 - 24"x24" Sand Naturale Rettificato
60x120 - 24"x48" Fault Gravel Naturale Rettificato / 60x120 - 24"x48" Mix Warm Naturale Rettificato



Gravel

The decorative range borrows from the imperfections present in the digital world – hence the name Glitch – and melds them with the tones of concrete both on flat and three-dimensional bases.

Die Dekorationen bedienen sich der Unvollkommenheiten aus der digitalen Welt (der englische Begriff „glitch“ steht nämlich für Bildschirmflimmern), die sie mit den Betonnuancen in der Fläche wie im Relief verknüpfen.

La gamme des décors emprunte ses imperfections à l'univers du digital (« glitch », en effet, est le terme anglo-saxon indiquant le « scintillement » de l'image sur l'écran) en les mélangeant aux nuances du ciment, tant sur fond plat que sur fond tridimensionnel.

“Glitch” è il termine anglosassone che indica lo “sfarfallio” dell’immagine sul monitor. La gamma decorativa prende in prestito le imperfezioni che si verificano nel mondo digitale, fondendole ai toni del cemento sia su base piana che tridimensionale.

60×120 - 24”×48” Gravel Naturale Rettificato

60×120 - 24”×48” Mix Warm Naturale Rettificato



Glitch
Residential Spaces



Ash / Fault Ash

Individuality and imperfection are ever-more desirable in the modern world of mass production, in which everything is type approved and homogenised. Glitch fully expresses this trend thanks to the random movement of the background shades and three-dimensional surfaces designed by Benoy.

Denn in einer Welt der Massenproduktion von Einheitsware wächst immer mehr das Verlangen nach Individualität und Unvollkommenheit. Glitch bringt diesen Trend auch dank des unregelmäßigen Wechselspiels der Grundnuancen und der von Benoy entworfenen Reliefs voll zum Ausdruck.

Individualité et imperfection sont deux caractéristiques de plus en plus recherchées dans le monde actuel de la production de masse, où tout est uniformisé. Glitch exprime pleinement cette tendance, appuyée aussi par le mouvement aléatoire des nuances du fond et des surfaces tridimensionnelles conçues par Benoy.

Individualità e imperfezione sono sempre più desiderabili nell'attuale mondo della produzione di massa in cui tutto è omologato. Glitch esprime in pieno questa tendenza grazie anche al movimento casuale delle sfumature di fondo e delle superfici tridimensionali disegnate da Benoy.

30×60 - 12"×24", 60×60 - 24"×24" Ash Naturale Rettificato
60×120 - 24"×48" Fault Ash Naturale Rettificato



Glitch
Residential Spaces



Salt / Gravel

The ability to easily coordinate interiors and exteriors is one of the strengths of Glitch by Benoy, together with the wide range of special pieces and furnishing elements that can fully enhance the design of any room.

Die Vielzahl an abgestimmten Lösungen für den Innen- und Außenbereich ist eine der Stärken von Glitch by Benoy; dazu gehört auch die umfassende Palette an Formteilen und Einrichtungselementen, die jedem Raumdesign Wertigkeit verleihen.

Glitch by Benoy présente deux points forts : une grande coordination entre intérieur et extérieur, associée à une offre étendue de pièces spéciales et d'objets d'ameublement et de décoration à même de valoriser de façon optimale la conception de chaque pièce et de chaque espace.

La grande coordinabilità di interni ed esterni è uno dei punti di forza di Glitch by Benoy; così come l'ampia disponibilità di pezzi speciali ed elementi d'arredo in grado di valorizzare al massimo il design di ogni ambiente.

60×60 - 24"×24" Salt - Gravel Antislip Rettificato / 60×120 - 24"×48" Salt Naturale Rettificato





Informazioni Tecniche

8

Colori
Colours
Farben
Couleurs

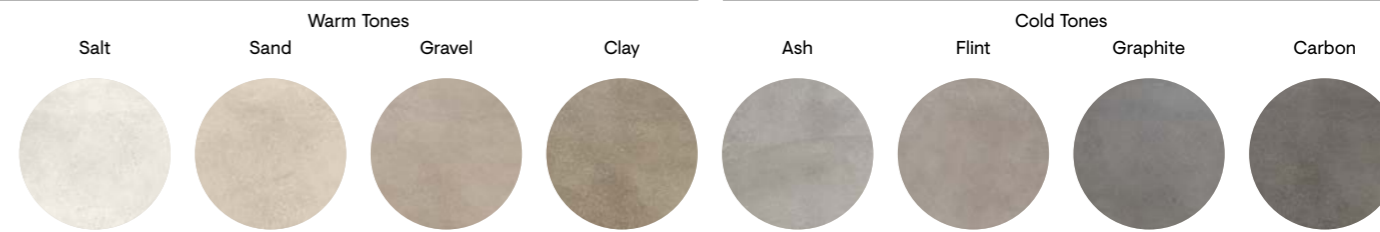

5

Formati
Sizes
Formate
Formats

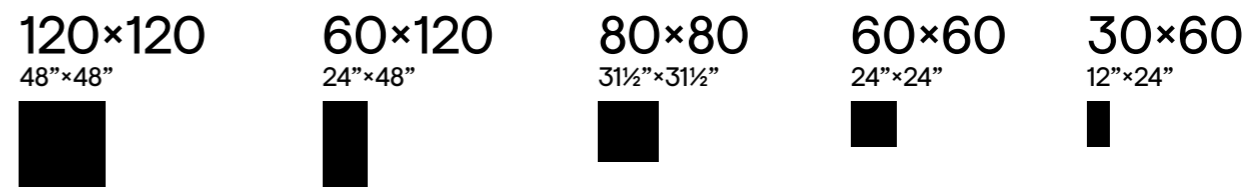

3

Spessori
Thickness
Stärke
Épaisseur

±9 ±9,5 ±20

2

Superfici
Surfaces
Oberflächen
Surfaces

Naturale Antislip Grip

1

Strutture 3D
3D structures
Strukturen
Décorations en relief



i

Effetto Cemento Cement Look Beton Optik Effet Béton	Rivestimento Wall Tiles Wandfliesen Revêtement	Pavimento Floor Tiles Bodenfliesen Sol	Gres fine porcellanato ad impasto colorato Coloured-body fine porcelain stoneware Feinsteinzeug aus farbiger Masse Grès cérame fin à pâte colorée	Tecnologia digitale Digital technology Digital technologie Technologie numérique
--	---	---	--	---

Ripresa grafica tra le diverse lastre rettificate contenute entro le tolleranze previste dalla norma. Per un corretto allineamento si consiglia di utilizzare una fuga di 2 mm.
Graphic representation between the rectified tiles is contained within the tolerances provided by the standard. For a correct alignment it is recommended to use a 2 mm joint.
Grafische Darstellung zwischen den verschiedenen rektifizierten Platten innerhalb der in der Norm vorgesehenen Toleranzen. Für eine korrekte Anpassung wird eine Fuge von 2mm empfohlen.
Reproduction graphique entre les différents carreaux rectifiés dans les limites des tolérances prévues par la norme. Pour un alignement correct, il est recommandé d'utiliser joints de 2 mm.



Salt

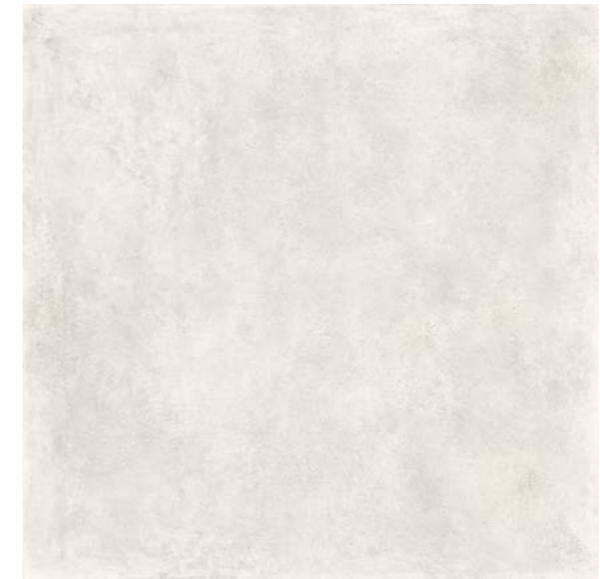

± 9

120×120 - 48"×48"

03292A | Glitch Salt Nat/Ret



± 9,5

80×80 - 31½"×31½"

05288 | Glitch Salt Nat/Ret

U3 P3 E3 C2



± 9,5

60×60 - 24"×24"

03285A | Glitch Salt Nat/Ret

U3 P3 E3 C2

03465A | Glitch Salt Antislip/Ret U3 P3 E3 C2



± 9,5

60×120 - 24"×48"

03267A | Glitch Salt Nat/Ret

U3 P3 E3 C2



60×120 - 24"×48"

03298A | Glitch Fault Salt Nat/Ret

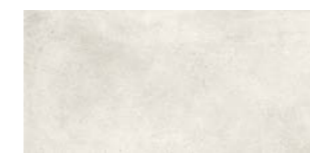

± 9,5

30×60 - 12"×24"

03276A | Glitch Salt Nat/Ret

U3 P3 E3 C2



60×120 - 24"×48"

03304A | Glitch Mix Warm Nat/Ret

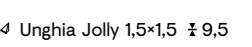
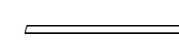
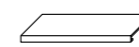
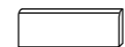



Sand



± 9,5

60x120 - 24"x48"

03266A | Glitch Sand Nat/Ret

U3 P3 E3 C2



± 9,5

± 20*

60x60 - 24"x24"

03284A | Glitch Sand Nat/Ret

U3 P3 E3 C2

03891A | Glitch Sand Grip/Ret*

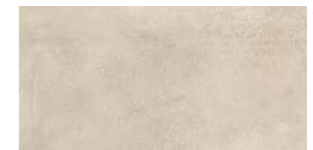

± 9,5

30x60 - 12"x24"

03275A | Glitch Sand Nat/Ret

U3 P3 E3 C2



60x120 - 24"x48"

03297A | Glitch Fault Sand Nat/Ret



60x120 - 24"x48"

03304A | Glitch Mix Warm Nat/Ret

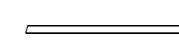
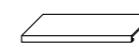
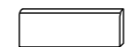

Gravel

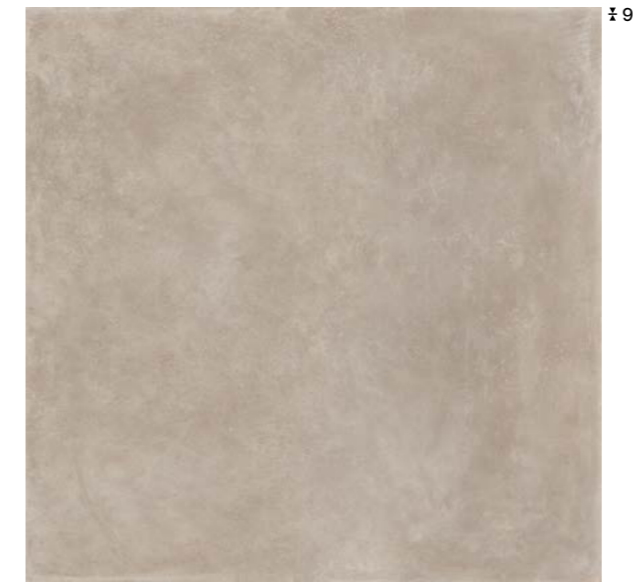

± 9

120x120 - 48"x48"

03291A | Glitch Gravel Nat/Ret



± 9,5

80x80 - 31½"x31½"

05287 | Glitch Gravel Nat/Ret U3 P3 E3 C2



± 9,5
± 20*

60x60 - 24"x24"

03283A | Glitch Gravel Nat/Ret U3 P3 E3 C2
03464A | Glitch Gravel Antislip/Ret U3 P3 E3 C2
03889A | Glitch Gravel Grip/Ret*

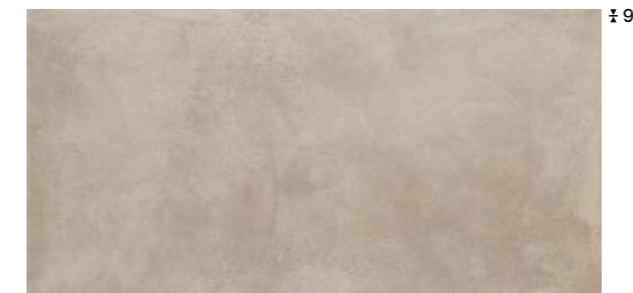

± 9,5

60x120 - 24"x48"

03265A | Glitch Gravel Nat/Ret

U3 P3 E3 C2



60x120 - 24"x48"

03296A | Glitch Fault Gravel Nat/Ret

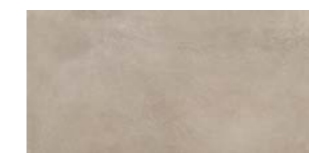

± 9,5

30x60 - 12"x24"

03274A | Glitch Gravel Nat/Ret U3 P3 E3 C2



60x120 - 24"x48"

03304A | Glitch Mix Warm Nat/Ret

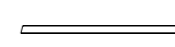
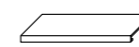
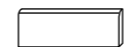



Clay



± 9,5

60x120 - 24"x48"

03264A | Glitch Clay Nat/Ret

U3 P3 E3 C2



± 9,5

60x60 - 24"x24"

03282A | Glitch Clay Nat/Ret

U3 P3 E3 C2



± 9,5

30x60 - 12"x24"

03273A | Glitch Clay Nat/Ret

U3 P3 E3 C2



60x120 - 24"x48"

03295A | Glitch Fault Clay Nat/Ret



60x120 - 24"x48"

03304A | Glitch Mix Warm Nat/Ret

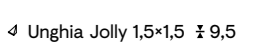
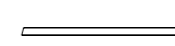
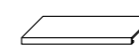



Ash



120x120 - 48"x48"
03293A | Glitch Ash Nat/Ret



80x80 - 31½"x31½"
05289 | Glitch Ash Nat/Ret U3 P3 E3 C2



60x60 - 24"x24"
03286A | Glitch Ash Nat/Ret U3 P3 E3 C2
03466A | Glitch Ash Antislip/Ret U3 P3 E3 C2
03892A | Glitch Ash Grip/Ret

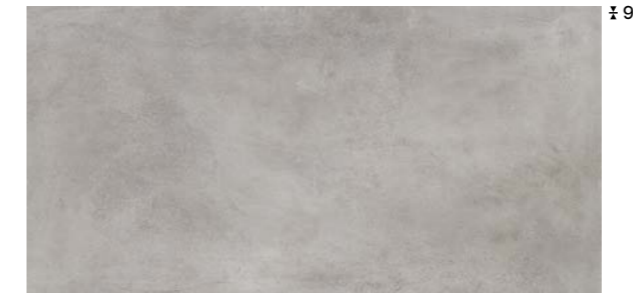

60x120 - 24"x48"
03268A | Glitch Ash Nat/Ret U3 P3 E3 C2



60x120 - 24"x48"
03299A | Glitch Fault Ash Nat/Ret



30x60 - 12"x24"
03277A | Glitch Ash Nat/Ret U3 P3 E3 C2



60x120 - 24"x48"
03305A | Glitch Mix Cold Nat/Ret

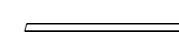
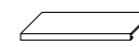
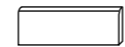



Flint



± 9,5

60×120 - 24"×48"

03269A | Glitch Flint Nat/Ret

U3 P3 E3 C2

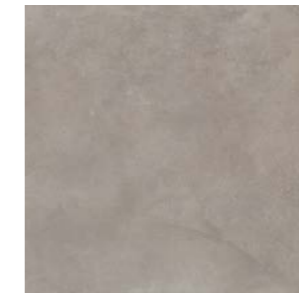

± 9,5

60×60 - 24"×24"

03287A | Glitch Flint Nat/Ret

U3 P3 E3 C2



± 9,5

30×60 - 12"×24"

03278A | Glitch Flint Nat/Ret

U3 P3 E3 C2



60×120 - 24"×48"

03301A | Glitch Fault Flint Nat/Ret



60×120 - 24"×48"

03305A | Glitch Mix Cold Nat/Ret

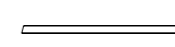
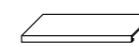
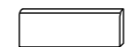

Graphite



120x120 - 48"x48"
03294A | Glitch Graphite Nat/Ret



80x80 - 31½"x31½"
05291 | Glitch Graphite Nat/Ret U3 P3 E3 C2



60x60 - 24"x24"
03288A | Glitch Graphite Nat/Ret U3 P3 E3 C2
03467A | Glitch Graphite Antislip/Ret U3 P3 E3 C2

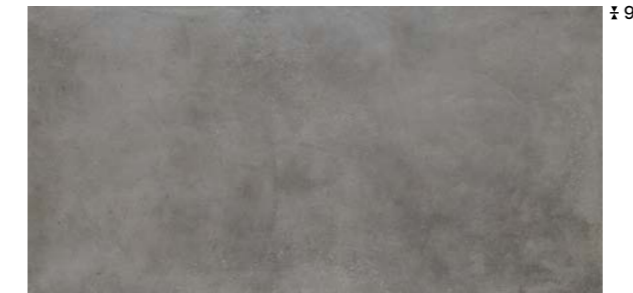

60x120 - 24"x48"
03271A | Glitch Graphite Nat/Ret U3 P3 E3 C2

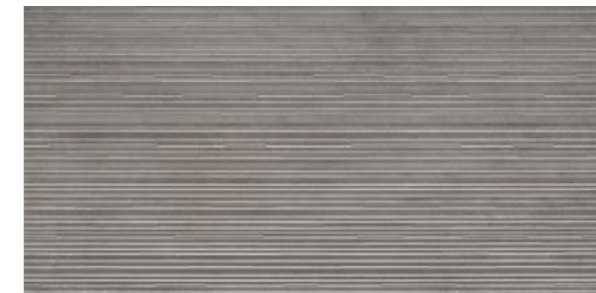

60x120 - 24"x48"
03302A | Glitch Fault Graphite Nat/Ret



30x60 - 12"x24"
03279A | Glitch Graphite Nat/Ret U3 P3 E3 C2



60x120 - 24"x48"
03305A | Glitch Mix Cold Nat/Ret



Gres fine porcellanato ad impasto colorato
Tecnologia Digitale

Coloured-body fine porcelain stoneware
Digital Technology

Feinsteinzeug aus farbiger Masse
Digital Technologie

Grès cérame fin à pâte colorée
Technologie Numérique

Carbon



± 9,5

60x120 - 24"x48"

03272A | Glitch Carbon Nat/Ret

U3 P3 E3 C2



± 9,5

60x60 - 24"x24"

03289A | Glitch Carbon Nat/Ret U3 P3 E3 C2



± 9,5

30x60 - 12"x24"

03281A | Glitch Carbon Nat/Ret U3 P3 E3 C2



60x120 - 24"x48"

03303A | Glitch Fault Carbon Nat/Ret



60x120 - 24"x48"

03305A | Glitch Mix Cold Nat/Ret

Pezzi speciali
Special pieces

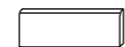

Battiscopa 4,5x60 ± 9,5

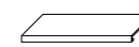

Gradino Costa Retta 33x120 ± 9,5

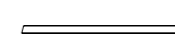

Bacchetta Jolly 1,5x120 ± 9,5

Unghia Jolly 1,5x1,5 ± 9,5

Riepilogo Gamma

Collection
Serie
Gamme

Formati Sizes		120x120 48"x48"	80x80 31½"x31½"	60x120 24"x48"	60x60 24"x24"	60x60 24"x24"	30x60 12"x24"	DIN 51130	DIN 51097	DCOF	BS EN 7976-2	AS 4586 2013	
		± 9	± 9,5	± 9,5	± 9,5	± 20	± 9,5						
Warm Tones	Nat/Ret	03292A	05288	03267A	03285A		03276A	V2	R10	A+B		wet, dry >36	P3
	Antislip/Ret				03465A				R11	A+B+C	> 0,42	wet, dry >36	P4
Salt	Nat/Ret			03266A	03284A		03275A	V2	R10	A+B		wet, dry >36	P3
	Grip/Ret					03891A			R11	A+B+C	> 0,42		
Sand	Nat/Ret	03291A	05287	03265A	03283A		03274A	V2	R10	A+B		wet, dry >36	P3
	Antislip/Ret				03464A				R11	A+B+C	> 0,42	wet, dry >36	P4
	Grip/Ret					03889A			R11	A+B+C	> 0,42		
Gravel	Nat/Ret			03264A	03282A		03273A	V2	R10	A+B		wet, dry >36	P3
	Antislip/Ret								R11	A+B+C	> 0,42		
Clay	Nat/Ret							V2	R10	A+B		wet, dry >36	P3
	Antislip/Ret								R11	A+B+C	> 0,42		
	Grip/Ret								R11	A+B+C	> 0,42		
Cold Tones	Nat/Ret	03293A	05289	03268A	03286A		03277A	V2	R10	A+B		wet, dry >36	P3
	Antislip/Ret				03466A				R11	A+B+C	> 0,42	wet, dry >36	P4
	Grip/Ret					03892A			R11	A+B+C	> 0,42		
Ash	Nat/Ret			03269A	03287A		03278A	V2	R10	A+B		wet, dry >36	P3
	Antislip/Ret								R11	A+B+C	> 0,42		
Flint	Nat/Ret							V2	R10	A+B		wet, dry >36	P3
	Antislip/Ret								R11	A+B+C	> 0,42	wet, dry >36	P4
Graphite	Nat/Ret	03294A	05291	03271A	03288A		03279A	V2	R10	A+B		wet, dry >36	P3
	Antislip/Ret				03467A				R11	A+B+C	> 0,42	wet, dry >36	P4
Carbon	Nat/Ret			03272A	03289A		03281A	V2	R10	A+B		wet, dry >36	P3
	Antislip/Ret								R11	A+B+C	> 0,42		







Riepilogo Gamma

Collection
Serie
Gamme

				Pezzi Speciali Special Pieces			
Formati Sizes		Fault 60x120 24"x48"	Mix 60x120 24"x48"				
		± 9,5	± 9,5	± 9,5	± 9,5	± 9,5	± 9,5
Warm Tones	Nat/Ret	03298A	03304A	03321A	03313	03329A	03338
	Salt						
Sand	Nat/Ret	03297A	03304A	03320A	03312	03328A	03337
	Sand						
Gravel	Nat/Ret	03296A	03304A	03731A	03311	03327A	03336
	Gravel						
Clay	Nat/Ret	03295A	03304A	03318A	03310	03326A	03335
	Clay						
Cold Tones	Nat/Ret	03299A	03305A	03732A	03314	03331A	03339
	Ash						
Flint	Nat/Ret	03301A	03305A	03323A	03315	03332A	03341
	Flint						
Graphite	Nat/Ret	03302A	03305A	03324A	03316	03333A	03342
	Graphite						
Carbon	Nat/Ret	03303A	03305A	03325A	03317	03334A	03343
	Carbon						

Imballi

Packing
Verpackung
Emballage

Formati Sizes		± MM	 Pezzi Scatola Pieces/Box Stck/Karton Carreaux/Boîte	 Mq/Scatola Sqmt/Box Qm/Karton M2/Boîte	 Kg/Scatola Kgs/Box Kg/Karton Kg/Boîte	 Scatole/Paletta Boxes/Pallet Karton/Palette Boîte/Palette	 Mq/Paletta Sqmt/Pallet Qm/Pallet M2/Palette	 Kg/Paletta Kgs/Pallet Kg/Pallet Kg/Palette	 Formato Paletta Size Pallet Format Pallet Dim. Palette
120x120 (48"x48") Nat/Ret	P	9	2	2,88	58,00	22	63,36	1276	143x126x67
80x80 (31½"31½") Nat/Ret	P	9,5	2	1,28	27,50	50	64,00	1375	124x80x96
60x120 (24"x48") Nat/Ret	P	9,5	2	1,44	31,00	30	43,20	930	122x80x96
60x60 (24"x24") Nat/Ret	P	9,5	4	1,44	29,00	32	46,08	928	120x80x75
60x60 (24"x24") Antislip/Ret	P	9,5	4	1,44	29,00	32	46,08	928	120x80x75
60x60 (24"x24") Grip/Ret	P	20	2	0,72	31,40	40	28,80	1256	120x80x75
30x60 (12"x24") Nat/Ret	P	9,5	7	1,26	25,30	40	50,40	1012	120x80x75
60x120 (24"x48") Fault Nat/Ret	P	9,5	2	1,44	31,00	30	43,20	930	122x80x75
60x120 (24"x48") Mix Nat/Ret	P	9,5	2	1,44	31,00	30	43,20	930	122x80x75

Pezzi Speciali / Special Pieces

33x120 (13"x48") Gradino Costa Retta Nat/Ret	P	9,5	2	0,792	18,50	20	-	-	-
4,5x60 (1¾"x24") Battiscopa Nat/Ret	P	9,5	14	0,378	8,00	80	-	-	-
1,5x120 (¾"x48") Bacchetta Jolly Nat/Ret	P	9,5	6	0,108	2,50	48	-	-	-
1,5x1,5 (¾"x¾") Unghia Jolly Nat/Ret	P	9,5	6	0,001	0,50	48	-	-	-

Pezzi Speciali

Special pieces
Formstücke
Pièces spéciales

Battiscopa Nat/Ret 4,5x60 - 1¾"x24" ± 9,5

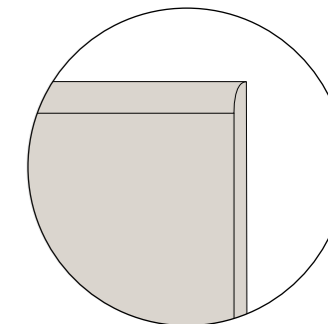
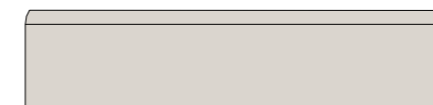

Gradino Costa Retta Nat/Ret 33x120 - 13"x48" ± 9,5
(costa retta ottenuto per taglio e incollaggio - obtained by cutting and gluing)

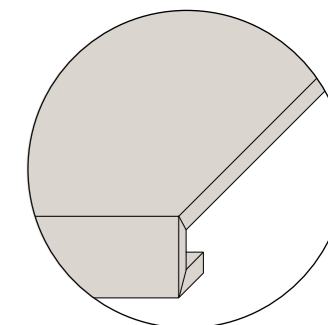
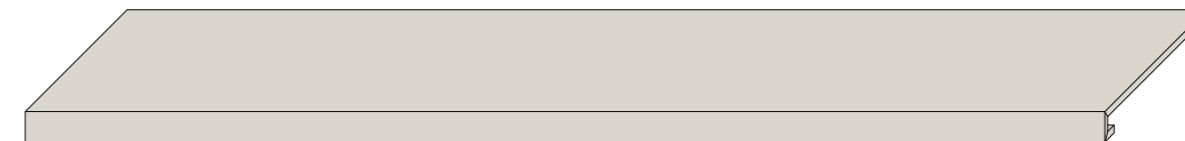

Pezzi Speciali

Special pieces
Formstücke
Pièces spéciales

Bacchetta Jolly Nat/Ret 1,5x120 - 5/8"x48" ± 9,5

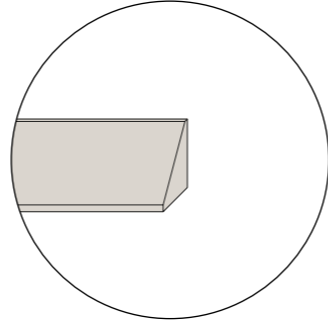
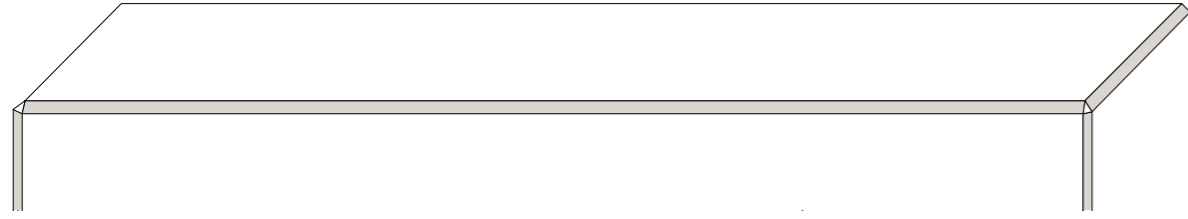

Unghia Jolly Nat/Ret 1,5x1,5 - 5/8"x5/8" ± 9,5

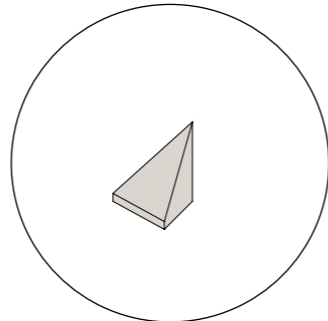
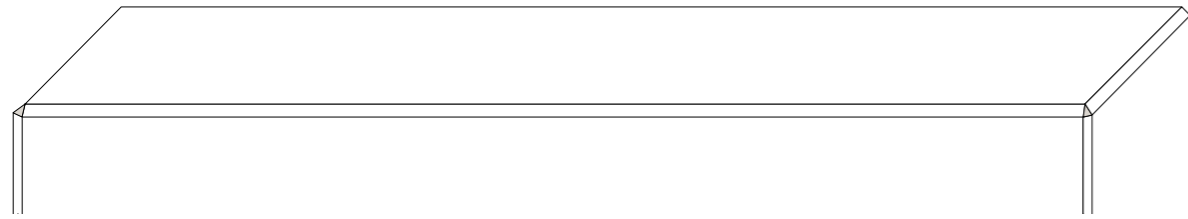

Elementi di Raccordo Bacchetta e Unghia Jolly

Universal Bevel Filler Strip and Corner Filler Chip
Verbindungselemente Universalleiste und -aussenecke
Éléments de raccord baguette et onglet Jolly



Angoli Muretti / Wall Bevel Corners /
Ecke für Zwischenwände / Angles murets



Spigoli Scale / Staircase Bevel Edge /
Kanten für Treppen / Arêtes escaliers

Caratteristiche Tecniche

Technical characteristics
Technische daten
Caracteristiques techniques

CLASSIFICAZIONE SECONDO NORME EN 14411 BI_A - ISO 13006 - CLASSIFICATION IN ACCORDANCE WITH EN 14411 BI_A - ISO 13006
KLASSIFIZIERUNG GEMÄSS NORMEN EN 14411 BI_A - ISO 13006 - CLASSIFICATION SELON LES NORMES EN 14411 BI_A - ISO 13006

CARATTERISTICA TECNICA TECHNICAL CHARACTERISTIC TECHNISCHE DATE CARACTÉRISTIQUE TECHNIQUE	NORMA NORM NORM NORME	VALORE PRESCRITTO VALUE REQUIRED NORMVORGABE VALEUR PRESCRIPTE	VALORE MEDIO MEAN VALUE MITTELWERT VALEUR MOYENNE CERAMICHE PIEMME FLOOR AND ROOF	NORMA NORM NORM NORME	VALORE MEDIO MEAN VALUE MITTELWERT VALEUR MOYENNE CERAMICHE PIEMME FLOOR AND ROOF
LUNGHEZZA E LARGHEZZA LENGHT AND WIDTH / LÄNGE UND BREITE / LONGUEUR ET LARGEUR		±0.6% (±2.00 MM)			
SPESSORE THICKNESS / STÄRKE / ÉPAISSEUR		±5% (±0.5 MM)			
RETTILINEITÀ LATI WARPAGES OF EDGES / GERADHEIT DER KANTEN / RÉCTITUDE DES ARÊTES	ISO 10545.2	±0.5% (±1.5 MM)	CONFORME IN ACCORDANCE ERFÜLLT CONFORME	ASTM C-499 ASTM C-485 ASTM C-502	IN ACCORDANCE
ORTOGONALITÀ WEDGING / RECHTWINKLIGKEIT / ORTHOGONALITÉ		±0.5% (±2.00 MM)			
PLANARITÀ FLATNESS / PLANITÄT / PLANIMÉTRIE		±0.5% (±2.00 MM)			
ASSORBIMENTO % D'ACQUA WATER ABSORPTION WASSERANNAHME % ABSORPTION D'EAU %	ISO 10545.3	≤ 0.5%	CONFORME IN ACCORDANCE ERFÜLLT CONFORME	ASTM C-373	IN ACCORDANCE
RESISTENZA ALLA FLESSIONE BENDING STRENGTH BIEGEZUGFESTIGKEIT RÉSISTANCE À LA FLEXION	ISO 10545.4	Modulus of rupture (average): R ≥ 35N/mm ² Breaking strength for thickness ≥ 7.5 mm S > 1300 N	CONFORME IN ACCORDANCE ERFÜLLT CONFORME	ASTM C-648 250 LBS OR GREATER	IN ACCORDANCE
DILATAZIONE TERMICA LINEARE TRA 20° E 100° C LINEAR THERMAL EXPANSION BETWEEN 20° AND 100° C LINEARE WÄRMEAUSENDENUNG ZWISCHEN 20° UND 100° C DILATATION THERMIQUE LINEAIRE ENTRE 20° ET 100° C	ISO 10545.8	SECONDO I DATI DEL COSTRUTTORE ACCORDING TO BUILDERS SPECIFICATIONS LAUT ANGABEN DES HERSTELLERS SELON LES ELEMENTS DU COSTRUCTEUR	≈ 7X10 ⁻⁶ C ⁻¹		
RESISTENZA AGLI SBALZI TERMICI THERMAL SHOCK RESISTANCE TEMPERATURWECHSELBESTÄNDIGKEIT RÉSISTANCE AUX ÉCARTS DE TEMPÉRATURE	ISO 10545.9	RICHIESTA REQUEST BITTE DEMANDE	RESISTENTE RESISTANT WIDERSTEHEND RÉSISTANT		
RESISTENZA AL GELO FROST RESISTANCE FROSTBESTÄNDIGKEIT RÉSISTANCE AU GEL	ISO 10545.12	RICHIESTA REQUEST BITTE DEMANDE	RESISTENTE RESISTANT WIDERSTEHEND RÉSISTANT	ASTM C-1026	IN ACCORDANCE
RESISTENZA ALL'ATTACCO CHIMICO RESISTANCE TO CHEMICAL ATTACK BESTÄNDIGKEIT GEGEN CHEMIKALIEN RÉSISTANCE À L'ATTAQUE CHIMIQUE	ISO 10545.13	SECONDO I DATI DEL COSTRUTTORE ACCORDING TO BUILDERS SPECIFICATIONS LAUT ANGABEN DES HERSTELLERS SELON LES ELEMENTS DU COSTRUCTEUR	RESISTENTE RESISTANT WIDERSTEHEND RÉSISTANT	ASTM C-650	IN ACCORDANCE
RESISTENZA DEI COLORI ALLA LUCE COLOURS RESISTANCE TO LIGHT LICHTBESTÄNDIGKEIT RÉSISTANCE DES COULEURS À LA LUMIÈRE	DIN 51094	NESSUNA ALTERAZIONE NO ALTERATION KEINE VERÄNDERUNG AUCUNE ALTERATION	CONFORME IN ACCORDANCE ERFÜLLT CONFORME		
RESISTENZA ALLE MACCHIE STAIN RESISTANCE FLECKENFESTIGKEIT RÉSISTANCE AUX TACHES	ISO 10545.14	≥ CLASSE 3 METODO DI PROVA DISPONIBILE TEST METHOD AVAILABLE VERFÜGBARE PRÜFMETHODE METHODE D'ESSAI DISPONIBILE	CONFORME IN ACCORDANCE ERFÜLLT CONFORME		
RESISTENZA ALLO SCIVOLAMENTO SLIPPAGE RESISTANCE RUTSCHSICHERHEIT RÉSISTANCE AU GLISSEMENT	DIN 51130 *	9 ≤ R ≤ 13	NATURALE R10 ANTISLIP R11 GRIP R11	ASTM C-1028 * COF ≥ 0.6 DRY ≥ 0.6 WET	NATURALE ANTISLIP GRIP
	DIN 51097 *	A,B,C	NATURALE A+B ANTISLIP A+B+C GRIP A+B+C	ANSI * 137.1-2012 DCOF > 0.42 WET	NATURALE ANTISLIP GRIP > 0.42
	BS EN 7976-2*	> 36 DRY > 36 WET	NATURALE Dry/Wet > 36 ANTISLIP Dry/Wet > 36 GRIP	AS 4586: 2013 CLASS	NATURALE P3 ANTISLIP P4 GRIP

*TRATTANDOSI DI NORMATIVE NAZIONALI, I METODI DI PROVA, I REQUISITI E LE CLASSIFICAZIONI VARIANO DA PAESE A PAESE. IL VALORE ATTESO DALLA RESISTENZA ALLO SCIVOLAMENTO DELLA PRODUZIONE DI INDUSTRIE CERAMICHE PIEMME S.P.A., PUÒ VARIARE IN BASE AL LOTTO PRODUTTIVO. SPECIFICA DOCUMENTAZIONE È DISPONIBILE SU RICHIESTA. ELENCO DELLE SERIE CERTIFICATE E CLASSIFICAZIONI DISPONIBILI A RICHIESTA. TEST METHODS, REQUIREMENTS AND CLASSIFICATIONS DIFFER FROM COUNTRY TO COUNTRY, ACCORDING TO THE NATIONAL REGULATIONS. THE EXPECTED VALUE OF SLIPPAGE RESISTANCE OF PRODUCTS BY INDUSTRIE CERAMICHE PIEMME S.P.A. MAY VARY DEPENDING ON THE PRODUCTION BATCH. SPECIFIC DOCUMENTS ARE AVAILABLE UPON REQUEST. LIST OF CERTIFIED SERIES AND CLASSIFICATIONS AVAILABLE UPON REQUEST. PRÜFVERFAHREN, ERFORDERNISSE UND KLASSIFIKATIONEN SIND VERSCHIEDEN VON LAND ZU LAND, GEMÄSS DER NATIONALEN VORSCHRIFTEN. DER ERWARTUNGSWERT DER RUTSCHSICHERHEIT DER PRODUKTE VON INDUSTRIE CERAMICHE PIEMME S.P.A. KANN SICH - JE NACH DER PRODUKTIONSPARTIE - VERÄNDERN. SPEZIFISCHE UNTERLAGEN SIND AUF VERLANGEN ZUR VERFÜGUNG. LISTE DER GEPRÜFTEN SERIE UND KLASSIFIZIERUNGEN AUF ANFRAGE ERHÄLTICH. LES MÉTHODES D'ESSAI, LES RÉQUISITIONS ET LES CLASSIFICATIONS CHANGENT DE PAYS À PAYS, SELON LES RÉGLEMENTATIONS NATIONALES. LA VALEUR ATTENDUE DE RÉSISTANCE AU GLISSEMENT DES PRODUITS DE INDUSTRIE CERAMICHE PIEMME S.P.A. PEUT VARIER EN FONCTION DU LOT DE PRODUCTION. UNE DOCUMENTATION SPÉCIFIQUE EST DISPONIBLE SUR DEMANDE. LISTE DES SERIES CERTIFIÉES ET DES CLASSEMENTS DISPONIBLES SUR DEMANDE. CONCERNANT LA NORME UPEC, VEUILLEZ SVP VÉRIFIER DIRECTEMENT SUR INTERNET EN TAPANT "UPEC PIEMME" LES RÉFÉRENCES ET/OU FINITIONS ÉVENTUELLEMENT PAS ENCORE À CE JOUR CERTIFIÉES.



CERAMICHE PIEMME
FLOOR AND ROOF



Norme per la posa e la manutenzione

Installation and maintenance instructions

Verlegung, reiningung und pflege

Guide a la pose et l'entretien

Verlegung, reiningung und pflege

Guide a la pose et l'entretien

Verlegung, reiningung und pflege

Guide a la pose et l'entretien

Verlegung, reiningung und pflege

Guide a la pose et l'entretien

Verlegung, reiningung und pflege

Guide a la pose et l'entretien

Verlegung, reiningung und pflege

Verlegung, reiningung und pflege

Verlegung, reiningung und pflege

Verlegung, reiningung und pflege

Verlegung, reiningung und pflege

Verlegung, reiningung und pflege

Verlegung, reiningung und pflege

Verlegung, reiningung und pflege

Verlegung, reiningung und pflege

Verlegung, reiningung und pflege

Verlegung, reiningung und pflege

Verlegung, reiningung und pflege

Verlegung, reiningung und pflege

Verlegung, reiningung und pflege

Verlegung, reiningung und pflege

Verlegung, reiningung und pflege

Verlegung, reiningung und pflege

Verlegung, reiningung und pflege

Verlegung, reiningung und pflege

Verlegung, reiningung und pflege

Verlegung, reiningung und pflege

Verlegung, reiningung und pflege

Verlegung, reiningung und pflege

Verlegung, reiningung und pflege

Verlegung, reiningung und pflege

Verlegung, reiningung und pflege

Verlegung, reiningung und pflege

Verlegung, reiningung und pflege

Verlegung, reiningung und pflege

Verlegung, reiningung und pflege

Verlegung, reiningung und pflege

Verlegung, reiningung und pflege

Verlegung, reiningung und pflege

Verlegung, reiningung und pflege

Verlegung, reiningung und pflege

Verlegung, reiningung und pflege

Verlegung, reiningung und pflege

Verlegung, reiningung und pflege

Verlegung, reiningung und pflege

Verlegung, reiningung und pflege

Verlegung, reiningung und pflege

Verlegung, reiningung und pflege

Verlegung, reiningung und pflege

Verlegung, reiningung und pflege

Verlegung, reiningung und pflege

Verlegung, reiningung und pflege

Verlegung, reiningung und pflege

Verlegung, reiningung und pflege

Verlegung, reiningung und pflege

Verlegung, reiningung und pflege

Verlegung, reiningung und pflege

Verlegung, reiningung und pflege

Verlegung, reiningung und pflege

Verlegung, reiningung und pflege

Verlegung, reiningung und pflege

Verlegung, reiningung und pflege

Verlegung, reiningung und pflege

Verlegung, reiningung und pflege

Verlegung, reiningung und pflege

Verlegung, reiningung und pflege

Verlegung, reiningung und pflege

Verlegung, reiningung und pflege

Verlegung, reiningung und pflege

Verlegung, reiningung und pflege

Verlegung, reiningung und pflege

Verlegung, reiningung und pflege

Verlegung, reiningung und pflege

Verlegung, reiningung und pflege

Verlegung, reiningung und pflege

Verlegung, reiningung und pflege

Verlegung, reiningung und pflege

Verlegung, reiningung und pflege

Verlegung, reiningung und pflege

Verlegung, reiningung und pflege

Verlegung, reiningung und pflege

Verlegung, reiningung und pflege

Verlegung, reiningung und pflege

Verlegung, reiningung und pflege

Verlegung, reiningung und pflege

Verlegung, reiningung und pflege

Verlegung, reiningung und pflege

Verlegung, reiningung und pflege

Verlegung, reiningung und pflege

Verlegung, reiningung und pflege

TIPO DI SPORCO	INDICAZIONI PER LA PULIZIA
Birra, Caffè, Gelato, Vino Gomma Pneumatico, Grassi vegetali e animali, Inchiostri, Lampostil Olii Meccanici, Residui di scotch Olio di lino, PennarelloResine Smalti, Tintura per capelli	Prodotti a Base Alcalina
Cera protettiva anti-abrasione, Depositi calcarei, Macchie di ruggine	Prodotti a Base Acida
Cera di candela, Residui di scotch	Solventi
Per ulteriori informazioni specifiche consultare l'area tecnica sul sito Piemme: www.ceramichepiemme.it	

TYPE OF STAIN	CLEANING SUGGESTIONS
beer, coffee, wine, ice cream vegetable and animal fats, rubber, remains of scotch tape, grease from machines, linseed oil, felt tip pens, paints, inks, hair dye	Alkaline-based detergent
protective anti-abrasion wax, calcareous residuals, rust stains	Acid-based detergent
candle wax, remains of scotch-tape	Solvents
For further specific details please visit the technical area on Piemme website: www.ceramichepiemme.it	

VERSCHMUTZUNGSART	REINIGUNGSHINWEISE
Bier, Wein, Eis, Kaffee Tierische oder pflanzliche Fette Gummi, Kleberbandresten Schmieröl, Tinte, Leöl, Filzstift, Harz oder Lack, Haarfarbe	Alakalische Reinigungsmittel
Kratzenschutz-Wachs, Kalkablagerunge, Rostflecken	Säure-Reinigungsmittel
Kerzenwachs Kleberbandresten	Lösungsmittel
Weitere Einzelheiten finden Sie in dem technischen Bereich des Piemme website: www.ceramichepiemme.it	

TYPE DE TACHE	NETTOYAGE CONSEIL
Bière, Vin, Glace, Café, Graisses végétales et animales, Encres, Résidus de scotch, Huile de graissage, Hile de lin Crayon feutre Émaux, Teinture pour cheveux, Caoutchouc pour pneus	Détergents à base alcaline
Cire de protection anti abrasion, Dépôts de calcaire, Tache de rouille	Détergents à base d'acide
Cire de bougie Résidus de scotch	Solvant
Pour d'ultérieures Information spécifiques consulter le département technique du site Piemme: www.ceramichepiemme.it	

Guida alla Lettura

Reading Guide

Leseanleitung

Guide à la lecture

Reading Guide

Leseanleitung

Reading Guide

Leseanleitung

Reading Guide

Leseanleitung

Reading Guide

Leseanleitung

Reading Guide

Leseanleitung

Reading Guide

Leseanleitung

Reading Guide

Leseanleitung

Reading Guide

Leseanleitung

Reading Guide

Leseanleitung

Reading Guide

Leseanleitung

Reading Guide

Leseanleitung

Reading Guide

Leseanleitung

Reading Guide

Leseanleitung

Reading Guide

Leseanleitung

Reading Guide

Leseanleitung

Reading Guide

Leseanleitung

Reading Guide

Leseanleitung

Reading Guide

Leseanleitung

Reading Guide

Reading Guide

Leseanleitung

Reading Guide

Leseanleitung

Reading Guide

Leseanleitung

Reading Guide

Leseanleitung

Reading Guide

Leseanleitung

Reading Guide

Leseanleitung

Reading Guide

Leseanleitung

Reading Guide

Leseanleitung

Reading Guide

Leseanleitung

Reading Guide

Leseanleitung

Reading Guide

Leseanleitung

Reading Guide

Leseanleitung

Reading Guide

Leseanleitung

Reading Guide

Leseanleitung

Reading Guide

Leseanleitung

Reading Guide

Leseanleitung

Reading Guide

Leseanleitung

Reading Guide

Leseanleitung

Reading Guide

Leseanleitung

Reading Guide

Leseanleitung

Reading Guide

Leseanleitung

Reading Guide

Leseanleitung

Reading Guide

Leseanleitung

Reading Guide

Leseanleitung

Reading Guide

Leseanleitung

Reading Guide

Leseanleitung

Reading Guide

Leseanleitung

Reading Guide

Leseanleitung

Reading Guide

Leseanleitung

Reading Guide

Leseanleitung

Reading Guide

Leseanleitung

Reading Guide

Leseanleitung

Reading Guide

Leseanleitung

Reading Guide

Leseanleitung

Reading Guide

Leseanleitung

Reading Guide

Leseanleitung



Ceramics of Italy rappresenta la volontà dell'industria italiana delle piastrelle di ceramica nel diffondere e promuovere una nuova valenza della piastrella di ceramica: non più solo un prodotto per l'industria delle costruzioni, ma punto di riferimento per stile e creatività per lo sviluppo di una nuova cultura dell'abitare Made in Italy.

Ceramics of Italy represents the willingness of the Italian ceramic tile industry to spread and promote a new concept of ceramic tile: no longer just a product for the construction industry, but a focal point for style and creativity in the development of a new culture of living Made in Italy.

Project Management
Mktg Piemme

Febbraio 2023
February 2023

Una storia tutta italiana

Piemme dal 1962, anno della sua fondazione, è protagonista indiscussa del vero Made in Italy, quello fatto di eccellenza, passione e creatività. Oggi tutti i materiali Piemme sono prodotti con tecnologia d'avanguardia come la decorazione digitale inkjet HD, la cottura in forni ad energia pulita a recupero di calore, la rettifica e levigatura in linea "one roof" e la verifica elettronica dello standard qualitativo.

An all-Italian story

Since 1962, the year of its foundation, Piemme has been the undisputed protagonist of real Made in Italy, that which consists of excellence, passion and creativity. Today, all Piemme materials are made using cuttingedge technology such as HD inkjet digital decoration, firing in heat-recycling cleanenergy kilns, "one roof" grinding and polishing line and electronic quality standard control.

Eine ganz italienische Geschichte

Seit dem Gründungsjahr 1962 ist Piemme ein unangefochtener Hauptakteur des echten Made in Italy: jenem, das auf Exzellenz, Leidenschaft und Kreativität gründet. Alle Piemme Erzeugnisse werden heute unter Einsatz von Spitzentechnologie mit der digitalen Inkjet-Dekoration, dem Brennen in Öfen mit grüner Energie und Wärmerückgewinnung, dem Schleifen und Polieren in der Linie „unter einem Dach“ sowie der elektronischen Prüfung des Qualitätsniveaus.

Une histoire toute italienne

Depuis 1962, l'année de sa fondation, Piemme est la protagoniste indiscutée du Made in Italy, basé sur l'excellence, la passion et la créativité. Aujourd'hui toutes les phases du cycle de fabrication Piemme sont issues d'une technologie à l'avant-garde comme la décoration numérique inkjet HD, la cuisson dans des fours à énergie propre et à récupération de chaleur, la rectification et le polissage en en ligne "one roof" et la vérification électronique de la qualité.

CERAMICHE PIEMME

FLOOR AND MORE

INDUSTRIE CERAMICHE PIEMME S.P.A.
VIA DEL CROCIALE 42/44, 41042 FIORANO (MO) - ITALY
T. +39 0536.849111 - F. +39 0536.849402
WWW.CERAMICHEPIEMME.IT - INFO@CERAMICHEPIEMME.IT