

norstar

GHUbXUFXHY`Y'Wta



3X8 DR5.1
Owner's Handbook

GHUbXUfXHY`Y'Vta

Norstar and Meridian are trademarks of Northern Telecom
© Copyright Northern Telecom 1997

Contents

Welcome to Norstar 1

- Customizing your system 1
 - Assisting your co-workers 2
 - Your Customer Service representative 2
 - Call Display services 3
 - Call Display Information 3
 - Call Log 6
 - Message Waiting 11
-

What's New with 3X8 DR5.1? 13

- ATA Answer Timer 13
 - Auxiliary Ringer 13
 - Do Not Disturb on Busy 13
 - Last Number Redial 13
 - Page Timeout 14
 - Page Tone 14
 - Saved Number Redial 14
-

Programming 15

- How to do programming 15
 - Planning 15
 - Programming tools 17
 - Using the Overlay 18
 - The Norstar display buttons 20
 - Programming details 21
 - Administration overview 23
 - Administration headings 23
 - Entering Administration 25
 - Exiting Administration 25
 - Moving through Administration 26
 - System Speed Dial 27
 - Names 31
 - Time and date 34
 - Direct-Dial 37
 - Capabilities 38
 - Dialing Filters 38
-

- Telephone (Set) abilities 43
- Line abilities 51
- Class of Service (COS) passwords 51
- Service Modes 54
- Password 58
- Log Defaults 59
- Call Services 60
 - Auto Call Info 60
 - Telephone (Set) Services 61
 - Voice Message Center telephone numbers 62
 - Voice Message Center lines 62
- Copying settings 63
 - Line programming 63
 - Telephone programming 63
 - Capabilities programming 63
- Programming reminders 64
 - Norstar telephones 65
 - Prime telephone 65
 - Page zones 65
 - Line Pools 65
 - Miscellaneous programming 65
 - Call Pickup Groups 66
 - System Speed Dial 67
 - Service Modes 68

Telephone features 69

- Using Norstar features 70
- Answering the telephone 74
 - What line indicators mean 76
 - Rings you may hear 76
 - Prime telephone displays 79
- Autodial 81
- Call Forward 84
- Call Information 87
- Call Log 89
- Call Park 99
- Call Pickup 101
- Call Queuing 104
- Camp-On 105
- Conference 107

- COS Password 112
- Customizing your telephone 113
- Dialing 120
- Do Not Disturb 126
- Feature programming 128
- Group Listen 131
- Handsfree/Mute 132
- Hold 134
- Host System Signaling 136
 - Host system signaling codes 136
- Line Pools 139
- Line Redirection 141
- Long Tones 146
- Messages 147
- Norstar Telephones 153
 - Buttons 153
 - Headset 155
 - Hearing aid compatibility 156
 - Wall mounting 156
- Page 157
- Priority Call 160
- Service Modes 162
- Special Telephones 164
- Speed Dial 167
- System features 170
- Time features 175
- Transfer 176
- Voice Call 181

User cards 183

Glossary 205

Index 225

Welcome to Norstar

In addition to basic telephone service, your Norstar digital key system has many extra features that will greatly improve your office communications.

When a telephone system is first installed, it takes a bit of time to settle into using new equipment. Norstar minimizes this orientation by providing straightforward features and simple instructions.

You can maximize the benefits of Norstar by selecting one individual in your office to administer the system. This individual aids in the customization of the system and acts as a resource for co-workers by developing a broad knowledge of Administration programming and feature operations. This Guide serves as a reference for such an individual.

Please take the time to read this Guide. It will help you, as the person chosen to administer the system, to learn the various tasks which you should perform.

Customizing your system

You play an important role in customizing Norstar to suit the organization and updating information as the office grows and changes.

Norstar can be customized at three levels:

Personal programming

Personal programming is done by individual telephone users who wish to personalize their Norstar telephones by programming features and telephone numbers onto specific memory buttons.

Administration programming

You do Administration programming when you want to change various system-wide settings, as well as some specific settings for each line or telephone.

Configuration programming

Configuration programming is usually done for you by the person who installs the system or by your Customer Service representative when Norstar is being installed. Specific system-wide parameters are set up in Configuration.

Assisting your co-workers

It is human nature to ask someone how to do something rather than read a user guide. You may be asked to demonstrate to co-workers how to select and use Norstar features. To help you prepare for that possibility:

- Familiarize yourself with the procedures for using Norstar features. Examine the components of your Norstar system, identifying the buttons on the different types of Norstar telephones. Read the Telephone User Cards chapter of this Guide for more information on each telephone.
- Familiarize yourself with the various programming reminders provided at the end of the Programming chapter of this Guide. Distribute copies of these reminders to your co-workers after filling in information such as Call Pickup group numbers and members.

It is important for everyone in the office to know that you are knowledgeable about the system and that you are available for consultation. You may wish to schedule sessions for small groups or provide individual assistance to co-workers for programming features on their Norstar telephones.

Your Customer Service representative

Ask your Customer Service representative for the service department's telephone number, and write it down. If you have problems with your Norstar equipment, telephone your Customer Service representative. If you have problems with programming or using any of the features, first read the appropriate section of this Guide and try again before calling your Customer Service representative.

Call Display services

Some public telephone companies offer Call Display services which provide information about an incoming call. The caller's name, telephone number and in some cases, long distance indication, can be shown on a telephone with a display. Your Norstar 3X8 DR5 system uses this information so that you can:

- view incoming call information as well as the Norstar line name that receives the call,
- keep a log of incoming call information and,
- view an integrated display that appears when you have received a message from either an internal Norstar user or a Voice Mail message from an external caller.

Note: You can access Call Display information only if you subscribe to the services offered by your public telephone company. Contact your Customer Service representative for more information.

Call Display Information

Call Display information may be shown on your telephone display when you answer an incoming call. In addition to the caller's name, telephone number and long distance indicator, if available, your Norstar system can display the name of the line that received the call.

In the case where several users share a line, only one telephone can be designated to automatically receive Call Display information when a call is alerting on that line. If the call is transferred or camped to another telephone, the Call Display information is automatically available to that telephone.

If a line is not administered to automatically deliver Call Display information to a telephone, the user can invoke the Call Information feature (see Telephone features chapter) or answer the call to view the information.

Depending on your requirements, Call Display information presents several convenient options.

- When a caller is identified before the call is answered, you can answer using a personal greeting. You can also prepare yourself prior to answering the call by retrieving any relevant documents, or otherwise orienting yourself to the expected discussion.
- The Long Distance indicator alerts you that an incoming call is long distance and may therefore have higher priority.
- If you are unable to immediately attend to an incoming call, you can use the calling information to make a quick note.
- You can shorten the interruption time of a call from a recognized person. For instance, you can quickly answer the call and let the party know that you are busy but will return the call soon.
- A telephone can be programmed to first view either the caller's name or number or line name. For example, an attendant might wish to see the calling number and area code first in order to transfer the call according to sales region. The salesperson's telephone could display the caller's name first so they can answer with a personal greeting.

- Call Display information allows you to answer calls on a priority basis. For example:
 - If several calls are alerting at your telephone at the same time, you can request information about the calls to decide which one may be more important.
 - If you are already on a call, information about a second call starting to alert at your telephone can help you to decide whether to answer the second call or remain connected to the first call.
 - If you are in a meeting, the information associated with an incoming call can help you determine if the call is important enough to interrupt the meeting.
 - If you have several calls on hold and wish to identify the callers, you can view the Call Display information associated with each of the calls to help you determine which one you will respond to first.

Programming tips

In order for the designated telephone to automatically receive Call Display information, it must be programmed to ring for incoming calls on that line.

Before programming Call Display information you may wish to consider the following:

- which individual would benefit the most from automatically receiving Call Display information on an alerting line?
- how are calls routed and what information is the most important to know before a call is answered? For instance, if certain lines are private to individuals, an attendant might wish to first view the line name to determine who the incoming call is for.

Call Log

The Norstar Call Log feature uses incoming Call Display information to make a record of call details for follow-up. Call Log also records several other useful facts such as the time and date of the log entry, the number of repeated calls by the same caller and which telephone answered the call if it was subsequently rerouted and handled by someone else in the Norstar system.

When the volume of incoming calls exceeds the ability of employees to handle all calls, or when staff are unavailable to answer calls, Call Log provides a convenient means of capturing information about missed calls.

When connected to a call that has Call Display information, the Logit feature of Call Log can be used to provide a quick and accurate means of recording the caller's information for future use (see the Telephone features chapter for more information).

Programming tips

Call Log space can be assigned to individual telephones according to how much space you wish to allocate to each user.

In order to maximize the value of Call Logs and avoid confusion for the end user and their customers, it is important to consider the following when configuring Call Log:

— Application of Call Log

Does the user want to return customer calls, track the numbers of calls unanswered, keep a record of most commonly called numbers, etc.?

— Who is most interested in logging calls on a particular line?

For instance, dentists working in a clinic may have an individual line assigned to them but prefer that the receptionist handle all of the calls logged on their line.

We strongly recommend that you limit the number of users logging calls for the same line, as this would be confusing. For example, if two users are logging calls for the same line, they do not know who the call was originally intended for, nor are both Call Logs updated when one of the users returns a customer's call. Potentially a customer could be called back twice.

There are few situations where the same call needs to be logged at more than one set.

Recommended configuration 1

All lines appear at the Attendant Position. Incoming calls are first answered on the Attendant's set and then transferred to the required destination.

The Attendant wants to track all calls unanswered on the system, during working hours and after hours. All users want to capture in their Call Log, any calls which they did not answer at their set and be able to return those calls from the log.

The Attendant Position logs *No one answered* on all lines and the users log calls *Unanswered by me*. In this configuration the users will log calls transferred to them via intercom (I/C) from the attendant or another user, even though the administration setting is (Logging set: N). Thus the entries in their Call Log are specifically meant for them.

Call Logs with an Attendant Position

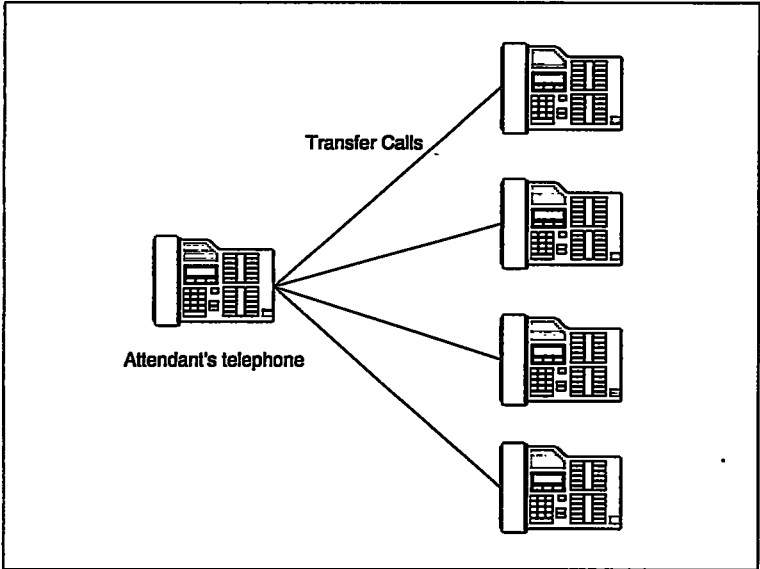

Programming:

Attendant Position

Configuration: Administration:

Line Access

Line assignment
(all lines to appear at
the Attendant's set)

Ringing:
(Ring for all lines)

Log Defaults

Space/Log: (assign log space
to all sets, for example 10.)

Call Services

Set services
Logging set: Y
(for all lines)

Set Programming:

Feature * 8 4 (No one answered)

Set Users

Administration:

Call Services

Set services
Logging set: N
(no lines assigned)

Set Programming:

Feature * 8 4
(Unanswered by me)

Recommended configuration 2

Each Norstar user who will log calls has an individual line appearing at their set. The users have a variety of requirements in terms of logging calls. Using **Feature * 8 4** the users can program logging capabilities specifically for their sets.

Call Logs with individual lines

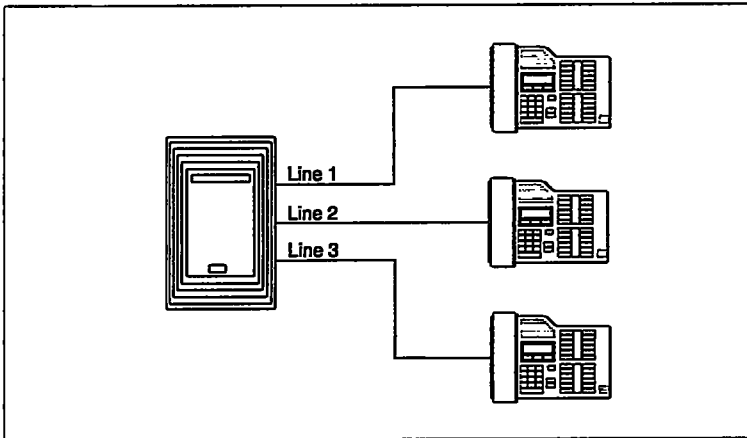

Programming:

Configuration:

Line Access

Line assignment
(unique line at each set)

Ring: (Ring for assigned line)

Administration:

Log Defaults

Space/Log: (assign log space to sets)

Call Services

Set services
Logging set: Y
(for assigned line)

Set Programming:

Feature * 8 4 (No one answered, Unanswered by me, Log all calls, No autologging)

Recommended configuration 3

The Norstar system has lines 01 and 02 appearing on all sets. The supervisor wants to log all calls for lines 01 and 02 at his/her set in order to analyze call traffic. Two users have been selected to return unanswered customer calls. To avoid confusion when logging and sharing lines, one user logs No one answered calls on line 01 and a second user logs No one answered calls on line 02. This clearly identifies who is responsible for returning calls for each line and ensures that only one person calls the customer back.

Call Logs with shared lines

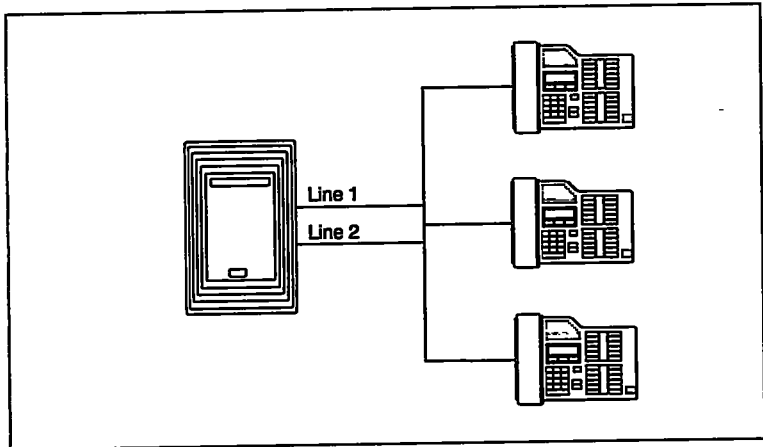

Programming:

Configuration:

Line Access

Line assignment
(lines 01 and 02 on all sets)

Ringing:
(Ring for lines 01 and 02)

Administration:

Log Defaults

Space/Log: (assign log space to sets)

Call Services

Set services

Show set: 21 (supervisor's)

Logging set: Y
(for lines 01 and 02)

Show set: 22

Logging set: Y (for line 01)

Show set: 23

Logging set: Y (for line 02)

Set programming:

Set 21 * 8 4 (Log all calls)

Set 22 and 23 * 8 4 (No one answered)

Note: For more information, see the *Call Log Feature Card*. This card is available in a separately orderable Call Display Key Cap Kit. Please contact your Customer Service representative.

Message Waiting

Norstar Message Waiting allows you to send and receive internal messages as well as maintain a record of your messages. If you have subscribed to Voice Mail Messaging (provided by your public telephone company), and visual message waiting indication is available, Message Waiting also informs you if you have messages at your Voice Message Center and allows you to:

- receive a visual indication that you have messages waiting,
- call your Voice Message Center to hear your messages and,
- clear the message waiting indication from your display.

Programming tips

In order for a telephone to use this feature, it must have a line appearance and Message Waiting must be activated for that line by your public telephone company.

It is possible for two or more telephones to share a line appearance. You must determine if one, some or all of the users sharing a line will receive Message Waiting notification. If it is a sub-group, such as a sales team within a company, it may be appropriate to share the feature providing that the users have an agreed upon procedure for retrieving and deleting messages.

For further information on Call Information, Call Log and Messages, see the Telephone features chapter. Programming actions are described in further detail in the Programming chapter.

What's New with 3X8 DR5.1?

ATA Answer Timer

The Norstar system allows you to administer a delay between the last digit you dial on a device connected to an analog terminal adaptor (ATA) and when the KSU is ready to receive DTMF tone from the far end analog device. Up until now there was a fixed seven-second delay. Now you can shorten or lengthen the delay depending on the requirements of the device attached to the ATA. Facsimile machines and credit card sets, for example, require a three second delay.

Auxiliary Ringer

To resolve the problem of an auxiliary ringer indicating internally transferred calls, the Auxiliary ringer can be set by line and by telephone. The telephone setting when combined with the line setting allows you to chose if the Auxiliary Ringer (if installed) will ring when a call is sent to a specific telephone or on a specific line. For example, an incoming call on a line programmed to yes will ring the auxiliary ringer. Once the call is answered and transferred within the system, the auxiliary ringer will not ring for a call sent to a telephone that has auxiliary ringer set to no.

Do Not Disturb on Busy

When you are busy on a call and a second call comes in, your telephone rings softly to alert you to the second call. If you find this second ring distracting, you can have the system prevent a second call from disturbing you by assigning Do Not Disturb (DND) on Busy to your extension.

Last Number Redial

Up to now Last Number Redial was available for all telephones on a system wide basis. Now you can change the ability of a particular telephone to use Last Number Redial. This helps to ensure that only authorized users can view access codes or passwords.

Link Feature

You can change a telephone's ability to use Link (a host system signaling option).

Page Tone

The tone preceding a Page Announcement up to now was always on. Now it is possible to turn the Page tone off for all users. This is convenient if the office environment is often busy with Page Announcements.

Page Timeout

You can now specify the amount of time required before a Page Announcement session expires. Longer announcements can be completed without having to re-page the other party. This feature enhancement appears in Configuration programming under Call Handling.

Saved Number Redial

Up to now Saved Number Redial was available for all telephones on a system wide basis. Now you can change the ability of a particular telephone to use Saved Number Redial. This helps to ensure that only authorized users can view access codes or passwords.

Programming

The system comes programmed with default settings that may be sufficient initially. Administration programming lets you change system-wide settings that probably have to be updated regularly because of staff turnover or new business contacts. You can also assign some features to individual lines and telephones. This provides you with real flexibility in making your telephones work together.

This chapter contains detailed procedures for programming System Speed Dial codes, Names for lines and telephones, and Time and Date information. If you are new to Administration programming, you may want to get comfortable with these three procedures before attempting other procedures.

Personal programming does not follow the same procedures as Administration programming. Personal programming allows you to assign a particular function to some of the keys, and is unique to each telephone. For more information on Personal programming, see the Feature programming description in the Telephone features chapter.

How to do programming

- The system is programmed using a M7208, M7310 or M7324 Telephone. Use the buttons on the telephone to program a setting or to request a specific programming action.

Norstar guides you step-by-step on the telephone display while you enter programming, select and change what you want, and exit programming.

Planning

Only one Norstar telephone can access Administration programming at a time. While programming a telephone, you cannot use it to make or receive calls. While you are programming, other users of the Norstar system may use their telephones, but cannot program any memory keys.

Determine programming requirements

Read about the available programming settings in this chapter, then determine how your co-workers would like the features programmed.

Get the following information:

- the numbers of the installed lines,
- the internal telephone numbers of installed Norstar telephones,
- the telephone numbers to be programmed into System Speed Dial,
- the names for lines and telephones,
- the lines and internal numbers that are subject to Line abilities and Set abilities programming,
- the required Filters,
- the Set Abilities to be assigned to individual telephones,
- how the system should be programmed to optimize the Service Modes feature,
- whether a new Administration password is required, and
- whether Class of Service passwords are required.

Programming tools

A Norstar telephone

System programming can be performed on an M7208, M7310 or M7324 Telephone.

The Norstar Programming Overlay

The *Norstar Programming Overlay* is a paper cutout that labels telephone buttons used during programming. This makes it easier for you to recognize the button that you want.

The *Norstar Programming Overlay* for the M7208 Telephone is placed over all of the eight memory buttons. The Programming Overlay for the M7310 and M7324 Telephones is placed over the top four memory buttons with indicators. The *Norstar Programming Overlays* are provided at the end of this Guide.

The 3X8 DR5.1 Programming Record

The *3X8 DR5.1 Programming Record* provides a convenient way to record what you have programmed. It also helps you to plan your programming. Settings are grouped according to their function.

Pages from the Record may be photocopied as necessary for programming many telephones.

The Norstar Telephone User Cards

Each Norstar telephone has a *Norstar Telephone User Card* that describes button placement and lists the most commonly used features.

The 3X8 DR5.1 Telephone Feature Card

The *3X8 DR5.1 Telephone Feature Card* lists the features that can be accessed with the button.

Using the Overlay

The indicators show which buttons can be used at a particular programming step. The functions on these buttons allow you to move through the headings and sub-headings of Norstar programming.

- | | |
|----------------|--|
| Heading | moves up in the hierarchy of headings and sub-headings. |
| Show | moves down in the hierarchy of headings and sub-headings, or to begin programming settings under a heading or sub-heading. |
| Next | moves to the next heading, sub-heading, or programmable setting. |
| Back | moves to the previous heading, sub-heading, or programmable setting. |

Some of the functions identified on the Programming Overlay for the M7208 Telephone are available on display buttons on M7310 and M7324 Telephones. For information about the additional functions on the M7208 Telephone Overlay, see the section in this chapter entitled The Norstar display buttons.

Programming Overlay for the M7208 Telephone (top) and for the M7310 and M7324 Telephones (bottom)

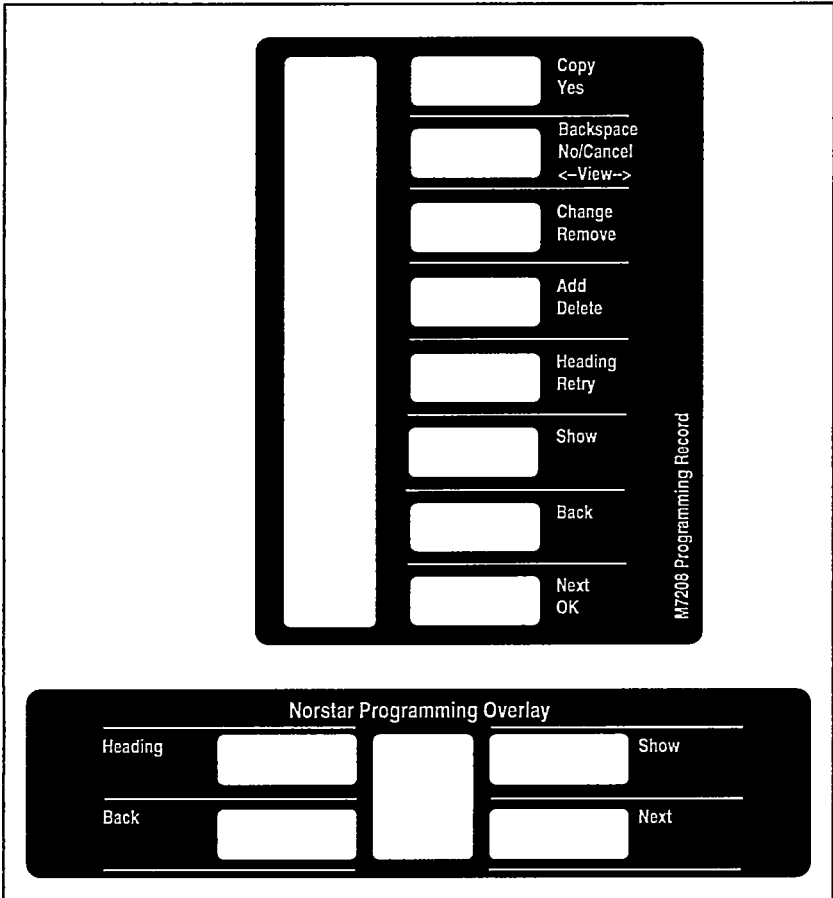

The Norstar display buttons

If you are programming on an M7310 or M7324 Telephone you can perform many functions using display buttons. Depending on where you are in programming, one, two, or three display buttons may be available at any one time. Press one of the display buttons to select the function that you want.

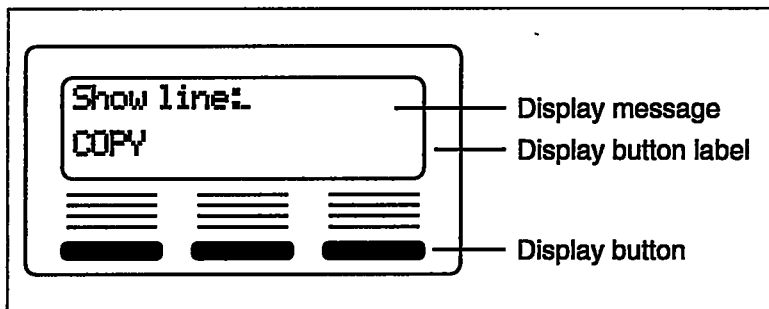

The most common display button labels are:

- | | |
|---------------|---|
| <u>CHANGE</u> | changes a programmable setting. |
| <u>BKSP</u> | moves the cursor one space backward (backspace) and deletes a character, allowing you to re-enter a number or letter. |
| <u>COPY</u> | copies line or telephone programming. |
| <u>VIEW→</u> | shows the last part of a displayed message longer than 16 characters. |
| <u>←VIEW</u> | shows the first part of a displayed message longer than 16 characters. |
| <u>→</u> | moves the cursor one position to the right when programming a name. |
| <u>←</u> | moves the cursor one position to the left when programming a name. |

Programming instructions in this Guide refer to display buttons. If you are programming on an M7208 Telephone, use the M7208 Programming Overlay to select the button that corresponds to the referenced display button.

Programming details

Entering numbers

Numbers are entered from the Norstar telephone dial pad. The **BKSP** display button may be used to edit the number.

Line numbers must always be entered as a two-digit number with a leading zero. Internal telephone numbers, also referred to as Directory Numbers (DNs), are always two-digits long.

Viewing long telephone numbers

External telephone numbers can be up to 24 digits, but the telephone display is only 16 character spaces long. If you wish to see a previously programmed number that is longer than 16 digits, you must do the following:

Begin, for example, with 123456789012345...

The display shows only the first 15 digits. The three dots (...) at the end of the display indicate that more digits remain to be displayed for the external number.

1. To see the remaining digits, press **VIEW**.
2. To see the first 15 digits again, press **←VIEW**.

Entering names

Letters and numbers can be entered as part of a name for various settings. The method of entering a name is always the same.

Begin with a setting that prompts you to enter a name. The display shows a cursor (_) to indicate where you can enter the next character. To enter a name:

1. Press the button on the dial pad with the printed letter or number that you want.

Each time that you press the button, a new character is shown on the display. For example, the button for the number 3 has the letters D, E, and F, where:

D is shown after the first press

E is shown after the second press

F is shown after the third press

3 is shown after the fourth press

D is shown again after the fifth press.

(Letters are always shown in upper case.)

2. When the character that you want is displayed, press **→** or **#** to move the cursor to the next character position.

OR

If you want to correct a character entered by mistake, press **←** or ***** until the cursor is positioned beneath the character that you want to correct.

OR

If you want to move the cursor back and delete a character, press **BACKSP**.

3. Repeat steps 1 and 2 for the remaining characters.

Administration overview

Administration programming lets you change settings for the entire Norstar system, as well as settings for individual telephones and external lines.

Pre-programmed default settings may initially be sufficient for your needs. You can use Administration programming to customize your Norstar system by changing these default settings. In this section, default options are shown in **bold** type.

The defaults correspond to those assigned during Norstar installation. The option you see while programming may be different if that setting has been changed. If the display shows a line number or internal number during programming, an example is shown in the Administration procedures.

Administration headings

Headings and sub-headings in Administration programming help you to keep track of where you are. An example of a heading is **1.5ys speed dial** for programming System Speed Dial. When you program a System Speed Dial number, **Display digits** is displayed as a sub-heading.

Administration programming has nine headings:

ADMINISTRATION CODE



Password:



1. Sys speed dial



2. Names



3. Time and date



4. Direct-Dial



5. Capabilities



6. Service Modes



7. Password



8. Log Defaults



9. Call Services

System Speed Dial assigns a two-digit code (01-70) for fast dialing of up to 70 telephone numbers from any Norstar telephone.

Names identifies external lines and telephones by name.

Time and Date adjusts the time and date displayed on each Norstar telephone.

Direct-Dial designates the telephone that can be reached by dialing a single digit.

Capabilities defines dialing filters, line abilities and telephone abilities. It assigns restrictions and capabilities to Class of Service (COS) passwords, to telephones, to lines and to line/telephone combinations.

Service Modes controls how the Norstar system responds to calls, depending on the time of day.

Password changes the password that controls access to Administration programming.

Log Defaults reallocates the Call Log space for all telephones in the system.

Call Services customizes the use of Call Display information for telephones.

Entering Administration

When your system is first installed, there is a default password stored in the Norstar system. Your Customer Service representative may change or clear the default password after installation. You are not prompted to enter a password as you enter Administration for the first time if your Customer Service representative has cleared the default password.

1. Release all calls on your telephone.
2. Enter the Administration access code:
 * * 2 3 6 4 6
 which is the same as
 * * A D M I N .
3. If the display changes to **Password:**, enter the Administration password that is recorded on the *3X8 DR5.1 Programming Record*. (The password is not shown on the display as you enter it.)

If the password is correct, the display shows **1.Sys speed dial**, and three triangular indicators ► are shown on the vertical display.

OR

If the password is incorrect, the display does not change. Check the password. Press **RETRY** and re-enter the password.

4. Place the *Norstar Programming Overlay* over the buttons.

See the Password section in this chapter for information on how to program your own password after entering Administration.

Exiting Administration

Norstar stores your changes automatically as soon as you alter any settings; you do not need to "save" your changes.

1. Press .
 The display briefly shows **End of session**.

Moving through Administration

To program a setting, you must first locate the correct heading. To do this, scan through the headings of Administration using the and buttons.

To move through Administration headings:
After entering Administration, the display shows
1.Sys speed dial.

1. Press .
The display shows 2. Names.
2. Press .
The display shows 3. Time and date.
3. Press .
The display shows 4. Direct-Dial.
4. Press .
The display shows 5. Capabilities.
5. Press .
The display shows 6. Service Modes.
6. Press .
The display shows 7. Password.
7. Press .
The display shows 8. Log Defaults.
8. Press .
The display shows 9. Call Services.
9. Press .
The display shows 1.Sys speed dial.

System Speed Dial

The System Speed Dial programming section allows you to set the Speed Dial codes for external telephone numbers which the people in your office use most often. Use the Personal Speed Dial feature to program numbers used by only one or two people.

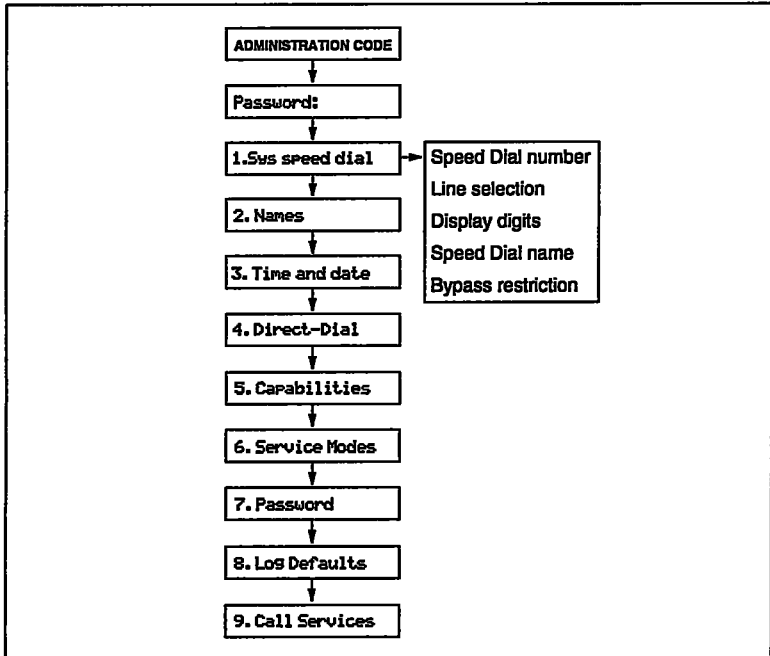

You can program 70 System Speed Dial codes ranging from #01 to #70.

System Speed Dial Number

System Speed Dial Number lets you assign a System Speed Dial telephone number to a two-digit code. The System Speed Dial Number may contain a maximum of 24 digits.

Begin with the display showing **1.5ys speed dial.**

1. Press **Show**.

The display shows **Speed dial #:..**

2. Select the Speed Dial code you want to program:

Press **Next** until the display shows the correct code.

OR

Enter the two-digit Speed Dial code on the dial pad.

Note: To assign default settings, press **DEFAULT** and then press **Next** to go to the next Speed Dial code.

3. Press **Show**.

4. Press **CHANGE**.

For example, the display may show **#05:..**

5. Enter the new telephone number from the dial pad, including all digits such as an initial **6** or an area code that must be dialed to call the number manually. If you need to move the cursor back, press the **BKSP** display button.

For example, press **6 5 5 1 2 3 4**.

The display shows **5551234..**

6. Press **OK** to store the System Speed Dial number.

Programming hints

A Host System Signaling feature code may be inserted into the System Speed Dial number. Run/Stop and Pause each use one character position; Link and Programmed Release each use two positions.

For more information on using these features in System Speed Dial programming, see the Host System Signaling section in the Telephones features chapter.

Line Selection

Line Selection allows you to specify the external line that is used for a System Speed Dial number. The options are the **Prime line**, an external line, or a line pool.

After you have programmed a System Speed Dial number, press and the display shows:

Use Prime line

OR

Use line: 02, for example, if a line is already assigned

OR

Pool code: 42, for example, if a line pool access code is already assigned.

1. To change the setting, press CHANGE until the display shows the option to be programmed.
2. If you select a line number or a line pool access code, enter the digits from the dial pad. A line pool access code can be from one to four digits long.

Display Digits

Display Digits determines whether the telephone number is displayed when a System Speed Dial number is used, or whether a name associated with that number is displayed.

After you have programmed a line selection for a System Speed Dial number, press and the display shows **Display digits:Y** or **Display digits:N**.

1. Press CHANGE to change the setting. Options are **Y (Yes)** and **N (No)**.

System Speed Dial Name

System Speed Dial Name allows you to assign a name to the stored System Speed Dial number. When the Display Digits setting is "No", the programmed name is shown on the Norstar display when the System Speed Dial feature is used.

The name can be up to 16 characters long. The default name is the System Speed Dial number; for example, *Sys Spd Dial 02* for System Speed Dial code 02.

After programming Display digits to N, press and the display shows Name.

1. Press .
The display shows the assigned or default name.
2. Press CHANGE.
3. Enter the first character of the name by pressing the appropriate dial pad button one, two, three, or four times.
4. To move the cursor to the next position, press \rightarrow or .
Continue entering characters. For more information, see the Entering names heading in the Programming details section of this chapter.

Programming hints

You can program System Speed Dial Name only if Display Digits is set to No.

Bypass Restrictions

Bypass Restrictions allows the System Speed Dial number to bypass any restrictions in applied Dialing filters. Dialing filters are programmed in the Capabilities section of Administration programming.

After programming the System Speed Dial Name, press and the display shows *BYPASS restr'n:Y* or *BYPASS restr'n:Y*.

1. Press CHANGE to change the setting. Options are N (No), and Y (Yes).

Names

You can assign names to identify external lines and your co-workers' telephones. During a call, the name (if programmed) is shown on the telephone display instead of the external line number or internal telephone number of the caller.

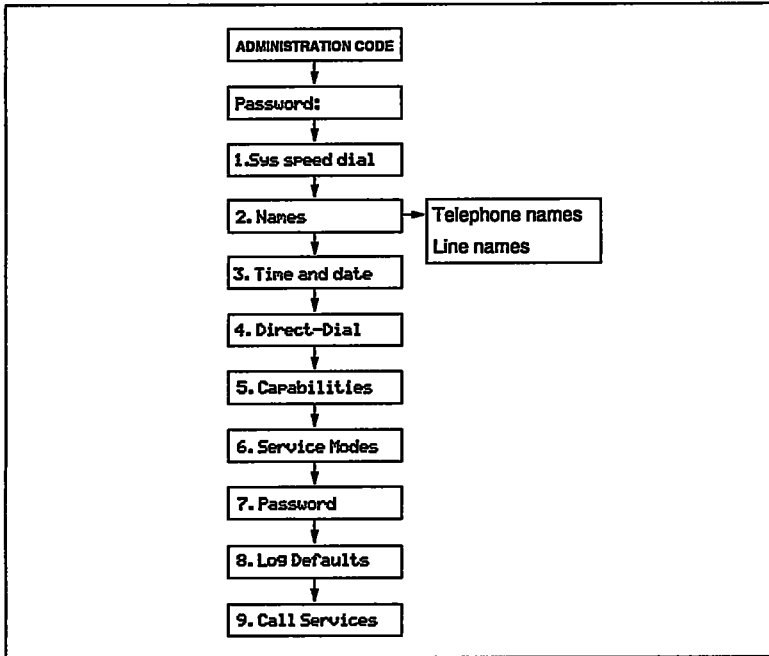

Programming hints

Telephone names and line names can contain both letters and numbers, but cannot be longer than seven characters. The # and * symbols cannot be used.

You can give the same name to two or more telephones, or to a telephone and a line in your system. To avoid confusion, you should avoid such duplication. Use initials, abbreviations, or even nicknames to give each telephone a unique name.

Two lines cannot have the same name. If you enter a line name which has already been used, you hear an error tone, and the display shows *Use unique name*.

Telephone Names

Personalize your office communication by assigning names to the telephones in the Norstar system. A telephone's default name is its internal number, for example, 27.

Begin with the display showing **1.Sys speed dial.**

1. Press **Next** .
The display shows **2. Names.**
2. Press **Show** twice.
The display shows **Show set:..**
3. Enter the two-digit internal number of the telephone.
OR
Press **Next** for the name of the telephone with the first internal number.
4. Press **CHANGE**.
The name is removed from the display, and a cursor is shown.
5. Enter the first character of the name by pressing the appropriate dial pad button one, two, three, or four times.
6. To move the cursor to the next position, press **→** or **#** .
Continue entering characters. For more information, see the **Entering names** heading in the **Programming details** section of this chapter.

Programming hints

If Automatic Telephone Relocation is turned on, the name and internal number of a telephone are saved if the telephone is moved within your system.

Line Names

Line Names allows you to assign a name to an external line. The default name is the line number, for example, Line 02.

Begin with the display showing 1.Sys speed dial.

1. Press .
The display shows 2. Names.
2. Press .
The display shows Set names.
3. Press .
The display shows Line names.
4. Press .
The display shows Show line: ..
5. Enter the two-digit line number from the dial pad.
OR
Press to program the name of line 01.
6. Press **CHANGE**.
The name is removed from the display, and a cursor is shown.
7. Enter the first character of the name by pressing the appropriate dial pad button one, two, three, or four times.
8. To move the cursor to the next position, press **→** or .
Continue entering characters. For more information, see the Entering names heading in the Programming details section of this chapter.

Time and date

Time and date programming allows you to set the time and date that is shown on the display when a telephone is not in use. As with any clock, this needs to be done every time that your office has a power failure.

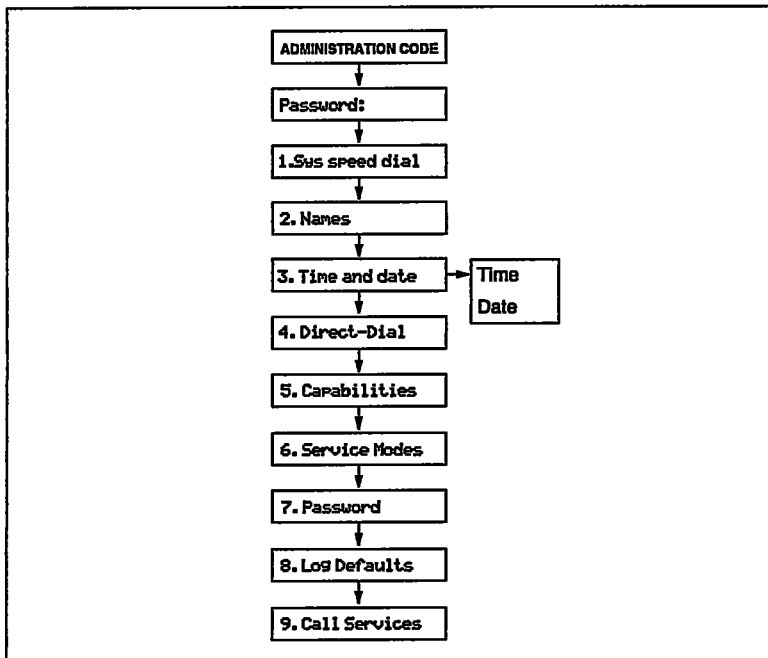

Changing the time and date is easy, but there are a couple of things to remember:

- All times and dates must be entered using numerals. For example, February would be entered as "02".
- The time may be entered in either 12- or 24-hour format. If the display is in English, and the hour entered is less than thirteen, the display prompts you to specify "AM" or "PM".
- The year is not shown on the telephone display, but make sure that it is set correctly. Norstar is programmed to allow for leap years.

- English language displays always show the time in 12-hour format, while the alternate language displays always use the 24-hour format.

Setting the time

Begin with the display showing 1.Sys speed dial.

1. Press **Next** twice.
The display shows 3. Time and date.
2. Press **Show**.
The display shows the time, for example, Time 1:00.
3. Press **CHANGE**.
The display shows the hour, for example, Hour: 01.
4. Set the hour.
 - a. Press **CHANGE**.
A cursor replaces the number on the display.
 - b. Enter the hour using the dial pad.
For example, press **0** **9**.
 - c. Press **Next**.
The display shows the minutes, for example, Minutes: 00.
5. Set the minutes.
 - a. Press **CHANGE**.
A cursor replaces the number on the display.
 - b. Enter the minutes using the dial pad.
For example, press **1** **5**.
 - c. Press **Next**.
If the hour entered in step 4 is less than thirteen, the display shows AM.
6. To switch the message to PM, press **CHANGE**.
To switch it back to AM, press **CHANGE** again.

Setting the date

Begin with the display showing 1.Sys speed dial.

OR

After having set the time, press and go to step 4.

1. Press twice.
The display shows 3. Time and date.
2. Press .
3. Press .
4. Press CHANGE. The display shows Year: 92.
5. Set the year.
 - a. Press CHANGE.
A cursor replaces the number on the display.
 - b. Enter the year using the dial pad.
For example, press to enter the year 1993.
 - c. Press .The display shows the month, for example Month: 01.
6. Set the month.
 - a. Press CHANGE.
A cursor replaces the number on the display.
 - b. Enter the month using the dial pad.
For example, press to enter April.
 - c. Press .The display shows the day, for example Day: 01.
7. Set the day.
 - a. Press CHANGE.
A cursor replaces the number on the display.
 - b. Enter the day using the dial pad.
For example, press .

Direct-Dial

Direct-Dial programming allows you to call the Direct-Dial telephone assigned to your telephone by dialing a single digit. Use the **Direct-Dial** heading to specify the telephone directory number (DN) designated as the Direct-Dial telephone.

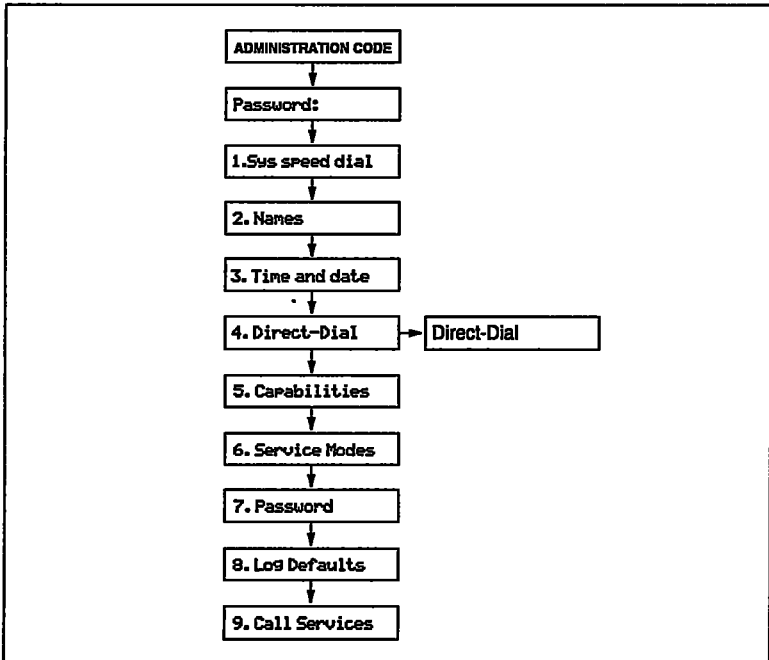

Use the button, the **CHANGE** display button and the dial pad to enter the internal number of the telephone to be designated as the Direct-Dial telephone.

Programming hints

To complete Direct-Dial telephone programming, assign a Direct-Dial telephone to each telephone in the system using the Capabilities section of Administration programming.

The digit you dial in order to get the Direct-Dial telephone to ring can be programmed by your Customer Service representative.

Capabilities

Capabilities programming assigns restrictions and exceptions to Class of Service (COS) passwords, telephones, and lines.

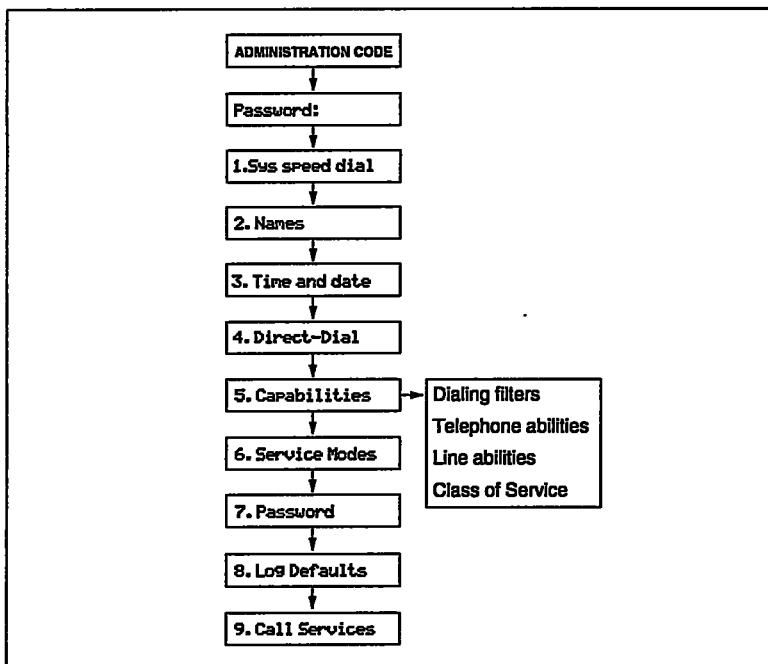

Dialing Filters

A dialing filter is made up of restrictions and exceptions. These specify the external numbers which can or cannot be dialed from a telephone or on a line.

After dialing filters are defined, they may be used as telephone (set) filters, line filters and line/set filters to manage outgoing calls.

Use the **Show** button, the **ADD** display button, the dial pad, and the **OK** display button to program the restrictions and exceptions for each dialing filter.

Press the **ANY** display button to enter a • wild card character that represents any digit in a sequence of numbers.

For example

You may need filters for three different types of users:

- Managers may require unrestricted dialing.
- Secretaries may need to be limited to calling the West coast office on line 03 only.
- Clerks may need to be limited to calling specific area codes and the West coast office.

Dialing filters are most commonly used to prevent unauthorized long-distance calls, without restricting local calls. Dialing filters restrict the numbers that an internal user can dial on external lines.

If a line/set filter has been defined for the line selected at the user's telephone, it overrides any line filters or telephone filters which might otherwise apply.

If no line/set filters have been defined, dialed digits are filtered through (and may be rejected by either of) the telephone filter (if defined) and the line filter (if defined).

Programming hints

- Norstar can have up to 20 dialing filters (00 to 19).
- Filter 00 cannot be changed.
- Each programmable filter can have up to 48 restrictions; there is no limit on the number of exceptions that can be allocated to any restriction.
- There is a maximum of 200 restrictions and exceptions allocated to the 24 programmable filters. For example, notice the reduction in the number of available restrictions and exceptions after each filter has been programmed.

Filter	User type	Rest'n	Excpt'n	Remaining
00	manager	— — —	— — —	200
01	secretary	5	5	190
02	clerk	7	12	171
Total		12	17	(200 - 12 - 17 = 171)

- The maximum length for a restriction is 15 digits; for an exception, the maximum is 16 digits.

- The ● is a "wild card" character that stands for any digit.
- You can use an asterisk * in a sequence of numbers in either a restriction or an exception. This character is often used as part of feature codes for other systems or for features provided by your central office.

Note: If you are using an earlier version of KSU software, the asterisk * is used as the "wild card".

- When restricting the dialing of a central office feature code, do not forget to create separate restrictions for the codes used for DTMF and pulse lines. For example, *67 and 1167.
- Do not string together a central office feature code and a dialing sequence that you want to restrict. Create a separate restriction for each.
- You can use COPY and the dial pad to copy restrictions and overrides from one dialing filter to another.
- Any restriction or exception can be used in any number of filters. Each time it is used, it counts as one entry. For example, if restriction 411 exists in filters 01, 02 and 03 it uses up three of the 200 entries available.
- Removing a restriction also removes the exceptions associated with it, and changes the identifying number of the remaining restrictions. For example, removal of restriction 01 renumbers restrictions 01 to 48 as 01 to 47.

Note: The removal of a restriction from one dialing filter has no effect on the contents of other filters into which the restriction was copied.

- You cannot delete a filter. Removing the restrictions programmed on a filter makes it an unrestricted filter but the filter is not removed.

Filter descriptions

- Filter 00 permits unrestricted dialing, and cannot be changed.
- Filter 01 is pre-programmed with five restrictions and some associated exceptions.

Filter	Restrictions	Exceptions
00	Unrestricted dialing	
01	0	
	1	1800 1555 1•1•555 1•0•555
	911	911
	411	
	976	
02 - 24	None	

- Filters 02 and 03, although not pre-set with restrictions and exceptions, are the default filter settings used later in programming:

Filter	Where the filter is programmed as a default setting in Capabilities programming	
02	Set abilities	Set filter:
03	Line abilities	Line filter:

Telephone (Set) abilities

Telephone (Set) abilities programming assigns dialing filters and specific settings to telephones. Telephone abilities include:

Telephone (set) filters	Direct-Dial telephone
Line/telephone filters	Call Forward On Busy
Telephone Administration Lock	Call Forward No Answer
Full Handsfree	Forward No Answer delay
Automatic Handsfree	Allow redirect
Handsfree Answerback	Redirect ring
Call Pickup Group	Receive tones
Paging	Hotline
Page Zone	Priority Call
Auxiliary Ringer	

Telephone (Set) filter

A Telephone filter is a collection of restrictions and exceptions defined in Dialing filters. These filters are applied to telephones through Set filter programming.

Use the button, the **CHANGE** display button and the dial pad to enter the number of the Dialing filter to be assigned as the Telephone filter. Filter 02 is the default set filter.

Line/telephone (Line/set) filter

A Line/telephone filter is applied to the appearance of a line at a specific telephone. This type of filter replaces any Line or Telephone filters which might otherwise apply.

Line/set filters control the numbers that may be dialed on specific external lines from specific telephones.

For example, a Line/set filter can permit a call to a specific long-distance number on line 03 from a specific telephone, but no other long-distance numbers, and on no other line.

Use the button, the **CHANGE** display button and the dial pad to enter the number of the Dialing filter to be assigned as the Line/telephone filter.

Programming hints

- A maximum of 255 Line/telephone dialing filters may be applied to lines at telephones across the entire system.

Telephone Administration Lock (Set Lock)

Telephone Administration Lock limits the types of features that may be used or programmed at a telephone. Use the **CHANGE** display button to select one of the three options: **None**, **Partial** and **Full**.

None allows you to access any feature on your telephone.

Partial prevents:

- programming Autodial buttons
- programming Personal Speed Dial numbers
- programming feature buttons
- moving line buttons
- changing the display language
- changing Dialing Modes (Automatic Dial, Pre-Dial, and Standard Dial)
- using Voice Call Deny
- using Administration programming
- saving a number with Saved Number Redial

Full, in addition to the restrictions outlined for Partial lock, prevents:

- changing Background Music
- changing Privacy
- changing Do Not Disturb
- using Ring Again
- using Call Forward all calls
- using Send Message
- using Trunk Answer
- activating Service Modes

Full Handsfree

Full Handsfree allows you to make or receive calls without picking up the receiver, and allows a headset to be used with the Norstar telephone. Use the **CHANGE** display button to select the setting: **N (No)** or **Y (Yes)**.

Programming hints

A  button is automatically assigned to a telephone that is programmed with Full Handsfree. Full Handsfree is always disabled for an M7100 Telephone.

Automatic Handsfree

Automatic Handsfree activates the Handsfree microphone and speaker when you make or receive calls by pressing a line button. Use the CHANGE display button to select the setting: **N (No)** or **Y (Yes)**.

Programming hints

You can program Automatic Handsfree only if the telephone has Full Handsfree set to Yes.

Handsfree Answerback

Handsfree Answerback allows you to answer a Voice Call without lifting the receiver. Use the CHANGE display button to select the setting: **Y (Yes)** or **N (No)**.

Programming hints

Handsfree Answerback is always disabled for an M7100 Telephone.

Call Pickup (Group)

Each telephone can be assigned to one of up to four Call Pickup groups. Members of a Call Pickup group can answer any calls ringing at a telephone in the group. Use the CHANGE display button to select the setting: **NO**, **1**, **2**, **3**, or **4**.

Programming hints

You cannot pick up a call that is on a Private line, or a call that is ringing only the Auxiliary Ringer.

Paging

This setting determines whether a telephone has access to the Page feature. Use the CHANGE display button to select the setting: **Y (Yes)** or **N (No)**.

Page zone

Each telephone can be assigned to one of three zones for receiving Page messages. A zone is any selection of Norstar telephones you want to group together, regardless of location. Use the CHANGE display button to select the setting: 1, 2, 3, or NO.

Programming hints

The Page zone setting has no effect if the telephone has Paging set to No.

Auxiliary Ringer

This setting causes the Auxiliary Ringer (if installed) to ring when the telephone rings. An Auxiliary Ringer is important in noisy environments where a Norstar telephone might otherwise not be heard. Use the CHANGE display button to select the setting: N (No) or Y (Yes).

Programming hints

To ensure that the auxiliary ringer does not ring for internally transferred calls, your Installer should program the line setting for auxiliary ringer to yes under configuration programming. Under the heading Capabilities in administration programming, set auxiliary ringer to no. An incoming call on a line programmed to yes will ring the auxiliary ringer. Once the call is answered and transferred within the system, the auxiliary ringer will not ring for a call sent to a telephone that has auxiliary ringer set to no.

Direct-Dial telephone

A telephone can be assigned to call the Direct-Dial telephone when you dial a single digit. Use the CHANGE display button to select the setting: Set1 or None.

Programming hints

Any number of telephones can be assigned to call a particular Direct-Dial telephone.

The digit you dial in order to get the Direct-Dial telephone to ring can be programmed by your Customer Service representative.

Call Forward On Busy

Call Forward On Busy redirects an incoming call to another telephone on your Norstar system when you are busy on a call, or when you have Do Not Disturb activated at your telephone.

Use the button, the CHANGE display button, and the dial pad to program the internal number of the telephone that your calls are to be directed to.

Programming hints

Line Redirection takes precedence over Call Forward On Busy.

Call Forward No Answer

Call Forward No Answer lets you redirect an incoming call to another telephone on your Norstar system when the call is not answered at your telephone.

Use the button, the CHANGE display button, and the dial pad to program the internal number of the telephone that your calls are to be directed to.

Programming hints

Line Redirection takes precedence over Call Forward No Answer.

Forward No Answer delay

If you assign another telephone to receive your calls, you can also assign the number of times that the incoming call rings before the call is forwarded. To estimate the delay time in seconds, multiply the number of rings by six. Use the CHANGE display button to select the setting: 2, 3, 4, 6, or 10 rings.

Do Not Disturb on Busy

When you are busy on a call and a second call comes in, your telephone rings softly to alert you to the second call. If you find this second ring distracting, you can have the system prevent a second call from disturbing you by assigning Do Not Disturb (DND) on Busy to your extension.

When DND on Busy is turned on for the set, internal and private network callers hear a busy tone instead of ringing when you are on the telephone. External callers are transferred to the prime set used in your system.

Press CHANGE to toggle the setting on (Y) or off (N).

Programming hints

If you use DND on Busy, the line indicator for an external incoming call still flashes, but your telephone does not ring.

Forward on busy takes priority over DND on busy.

Allow redirect

Allow redirect enables you to identify whether a telephone is allowed access to the Line Redirection feature. Use the CHANGE display button to select the setting: Y (Yes) or N (No).

See the explanation of Line Redirection in the Telephone features chapter for more information on redirecting lines.

Programming hints

The Allow redirect setting has no effect if Disconnect Supervision is unavailable or was not enabled by your Customer Service representative. See the System features section of the Telephone features chapter for more information on Disconnect Supervision.

Redirect ring

The Redirect ring setting causes a telephone to ring briefly (a 200 millisecond burst) when a call is redirected on one of its lines. Each telephone with a ringing appearance of that line also rings briefly for the redirected call if the Redirect ring setting for them is 'Y' (the default). Use the CHANGE display button to select the setting: Y (Yes) or N (No).

A user enters the Line Redirection feature code to redirect calls. See the explanation of Line Redirection in the Telephone Features chapter for more information on redirecting lines.

Programming hints

The Redirect ring setting has no effect if Disconnect Supervision is unavailable or was not enabled by your Customer Service representative. See the System features section of the Telephone features chapter for more information on Disconnect Supervision.

Receive tones

The Receive tones setting allows the system to accept and relay tones to the internal lines. Tones are required if you want to connect an answering machine or a fax on an internal line. Use the **CHANGE** display button to select the setting: **N (No)** or **Y (Yes)**.

Hotline

Hotline automatically calls a pre-assigned number when you lift the receiver or press at your telephone. Hotline has three options: **None**, internal (**Intrn1**), and external (**Extrn1**).

Internal assigns an internal number.

External assigns an external number. If you select an external number, you can also select the line on which the call is made: the Prime line, an external line, or a line pool. You will have to specify the Line Pool Access code for a line pool.

Use the **CHANGE** display button to select the Hotline setting. If you select **Intrn1**, use the button, the **CHANGE** display button, and the dial pad to program the internal number of the telephone that Hotline calls are to be directed to.

If you select **Extrn1**, use the button, the **CHANGE** display button, and the dial pad to program the external telephone number that Hotline calls are to be directed to, and to program the line Hotline calls are to be made on.

Programming hints

The telephone should be labeled to inform anyone using it that Hotline is active.

A telephone's Prime line, line pool access codes, and access to a line pool can be programmed by your Customer Service representative.

Priority Call

This feature lets you call from your Norstar telephone and interrupt calls or override Do Not Disturb on another Norstar telephone. Use the CHANGE display button to select the setting: N (No) or Y (Yes).

Programming hints

Apply this feature only to telephones from which such interruptions can be justified.

Allow Last Number Redial

A telephone's ability to use Last Number Redial can be turned on or off. Press CHANGE to select the setting: N (No) or Y (Yes).

Allow Saved Number Redial

A telephone's ability to use Saved Number Redial can be turned on or off. Press CHANGE to select the setting: N (No) or Y (Yes).

Allow Link

The ability of a telephone to use Link (a host system signaling option) can be turned on or off. Press CHANGE to select the setting: N (No) or Y (Yes).

ATA Answer Timer

A timer can be used to administer a delay between the last digit you dial on a device connected to an analog terminal adaptor (ATA) and when the system begins to send out tones (DTMF for modem) on the outgoing line without capturing and interpreting them. To change the delay time, press CHANGE to select the setting (in seconds): ATA Ans timer: 3, 5, 7, or 10.

If the DN you are programming is the internal analog terminal adaptor (I-ATA), you may also select **Use ringback**. When this setting is selected, the system's built-in ringback detection will be used to regulate the connection between analog devices.

Programming hints

To accommodate the device attached to the ATA, you may want to lengthen or shorten the delay. If a modem or fax machine is attached to the ATA you will want to keep the delay short. If a call to a fax machine or modem cannot be connected, try shortening the delay. If an individual is dialing the number for a fax machine or modem, you may want to make the delay a little longer.

Line abilities

Line abilities programming assigns dialing filters to lines.

Line filter

A Line filter is a collection of restrictions and exceptions defined in a Dialing filter, and applied to an outgoing line. A Line filter on an outgoing line may be used to limit the capabilities of that line to carry calls made to specific area codes or destinations.

Use the CHANGE display button, and the dial pad to program the Line filter. **Filter 03** is the default Line filter.

Class of Service (COS) passwords

Class of Service (COS) passwords permit controlled access to a system's resources. Class of Service programming defines passwords, their associated dialing filters and user filters.

A Class of Service can be associated with a telephone, a line or a COS password. It determines the dialing capabilities that apply to internal telephones and any lines used for external calls.

Users have a Class of Service associated with their telephones, in the sense that there are dialing filters associated with telephones, as well as line pool assignments. Use of a COS password affects only the telephone's dialing capabilities.

The ability to change the COS internally means that someone using another person's telephone can temporarily change the restrictions that would normally be applied.

Password security

- Class of Service passwords for a system should be determined randomly, and should be changed on a regular basis.
- System users should memorize their COS passwords instead of writing them down.
- Employees' COS passwords should be deleted when they leave the company.

Programming hints

- A system can have a maximum of 20 six-digit COS passwords (00 to 19).
- You can copy the data from one COS password to another COS password using the COPY display button in the same way that telephone and line data can be copied.
- COS passwords must be unique.

Programming COS passwords

Use the button, the CHANGE display button, and the dial pad to program the six-digit sequences for each password. Use the BKSP display button to edit digit sequences you have entered.

User filter

The COS User filter replaces the telephone (set) filter or the line/set filter that would otherwise apply to a specific call.

Use the button, the CHANGE display button, and the dial pad to program the two-digit User filter. The default setting (Def1t), means that any other filters in place (telephone (set) filter or line/set filter) still apply.

Line filter

The COS Line filter replaces the line filter that would otherwise apply to a specific call.

Use the CHANGE display button, and the dial pad to program the two-digit Line filter. The default setting (Def1t), means that any Line filter already programmed still applies.

Service Modes

Using Service Modes, you can control how the Norstar system responds to calls, depending on the time of day. Up to three different Service Modes can be programmed, each with unique ringing arrangements.

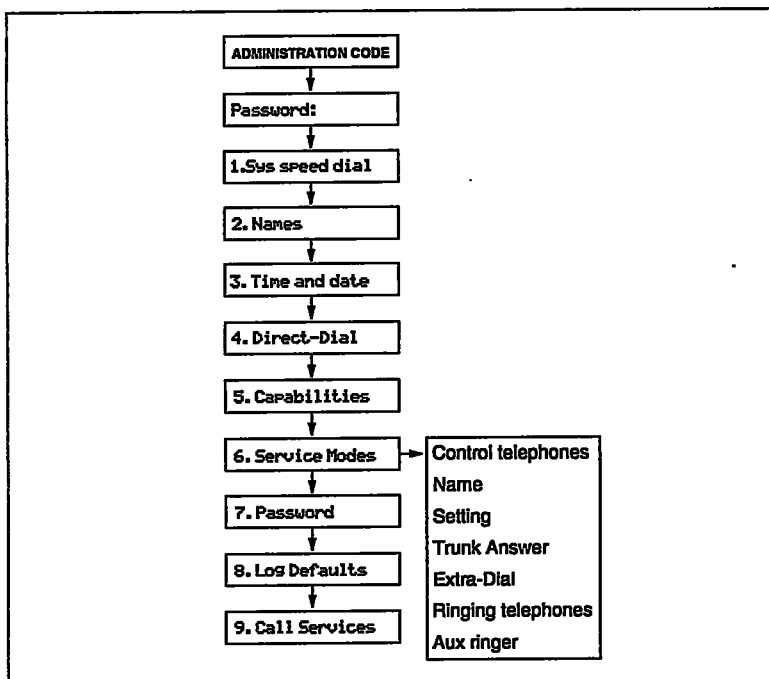

Control telephones

Control telephones are assigned to each external line and are used to control the Service Mode by allowing you to turn the Service Mode on or off for that line.

Use the button, the **CHANGE** display button, and the dial pad to program the internal number of the Control telephone for each line.

Programming hints

Only the Control telephone programmed for an external line can place that line into a Service Mode.

You can assign a Control telephone to more than one external line, but a line cannot be assigned to more than one Control telephone.

Only one Service Mode applies at any one time to all external lines controlled by a given Control telephone.

The default Control telephone for all lines is 21.

Service Modes

The three Service Modes are programmed in the same way.

Service Mode Name

The Service Mode Name identifies the active Service Mode, and is shown on the display of the Control telephone when the Service Mode is turned on.

Use the button, the CHANGE display button, and the dial pad to program the Service Mode name. For information on entering names, see the information in this chapter entitled Entering names.

Programming hints

The default names of the three possible Service Modes are only suggestions, and may be changed to any other name.

A Service Mode name can be one to seven characters.

Service Mode setting

The Service Mode setting controls how the Service Mode is activated and deactivated. Use the CHANGE display button to select the setting: **Manual**, **Automatic**, or **Off**.

Manual allows you to turn the Service Mode on and off at any time from a Control telephone. The Service Modes feature code must be entered at the telephone to access this feature.

Automatic allows you to pre-assign a stop and start time during which the Service Mode is active. You are still able to start and stop the Service Mode by entering the Service Modes feature code at a Control telephone. If you select this setting, you will have to program start and stop times. See the section in this chapter on Time and Date for information on programming times.

Off prevents the Service Mode from being activated.

Programming hints

You can only program start and stop times when the Service Mode is set to Automatic.

Overlapping times may be assigned. For example, if Service Mode 1 is assigned from 9:00 am to 4:00 pm and Service Mode 2 is assigned from 1:00 pm to 5:00 pm, then the start time of the second Service Mode is treated as a stop time for the first Service Mode. This is also true if two Service Modes have the same start time but different stop times.

If one Service Mode starts and stops within the times of another Service Mode, the first service temporarily ends when the second service starts. The first service then resumes when the second service has ended.

Default stop and start times correspond to typical hours which may be required for a night Service Mode.

Default Service Mode times

Service Mode	Start time	Stop time
Service Mode 1: Night	23:00	07:00
Service Mode 2: Evening	17:00	23:00
Service Mode 3: Lunch	12:00	13:00

Trunk Answer

Trunk Answer allows you to answer, from any telephone, an external call which is ringing at another telephone in your office. This is useful if the other telephones have not been assigned the same lines as the telephone you are using to answer the call.

You can change the Trunk Answer setting only if the Service Mode is set to Manual or Automatic.

Use the CHANGE display button to select the setting: **Y (Yes)** or **N (No)**.

Extra-Dial telephone

A telephone normally in service as a Direct-Dial telephone, can be programmed in Service Modes to allow internal calls to the Direct-Dial telephone to also ring at the Extra-Dial telephone.

Use the CHANGE display button and the dial pad to enter the internal telephone number of the Extra-Dial telephone.

Programming hints

The Extra-Dial telephone provides the option of assigning one more Direct-Dial telephone in the Norstar system for each operational Service Mode.

Ringling telephones (sets)

You can assign additional telephones to ring for incoming calls on each external line. Use the button, the ADD display button and the dial pad to enter the internal telephone numbers of the Ringling telephones for each line.

Programming hints

The default ringing telephone is **21**. This means that all lines ring at telephone **21**, when Service Modes are activated. Ringling telephones can be assigned to more than one Service Mode.

Auxiliary ringer

You can indicate whether the Auxiliary Ringer (if installed) also rings when a Service Mode is activated. Use the CHANGE display button to select the setting: **Y (Yes)** or **N (No)**.

Password

The Administration password allows access to Administration programming. This prevents unauthorized or unintentional changes to settings. To ensure security, distribute the password only to selected personnel, record your password in the *3X8 DR5.1 Programming Record*, and change the password periodically.

The password is a one to six-digit number. The default Administration password is which is the same as .

Use the button, the **CHANGE** display button and the dial pad to enter the new Administration password. Use the **OK** display button to accept the programmed password.

Programming hints

The password is easier to remember if the digits correspond to the letters in a word.

If you forget the Administration password, you are not able to access Administration programming. Call your Customer Service representative to assign a new Administration password.

Log Defaults

If you subscribe to Call Display services, external calls can be tracked in a Call Log. Log Defaults programming customizes how log space is allocated to telephones throughout the system.

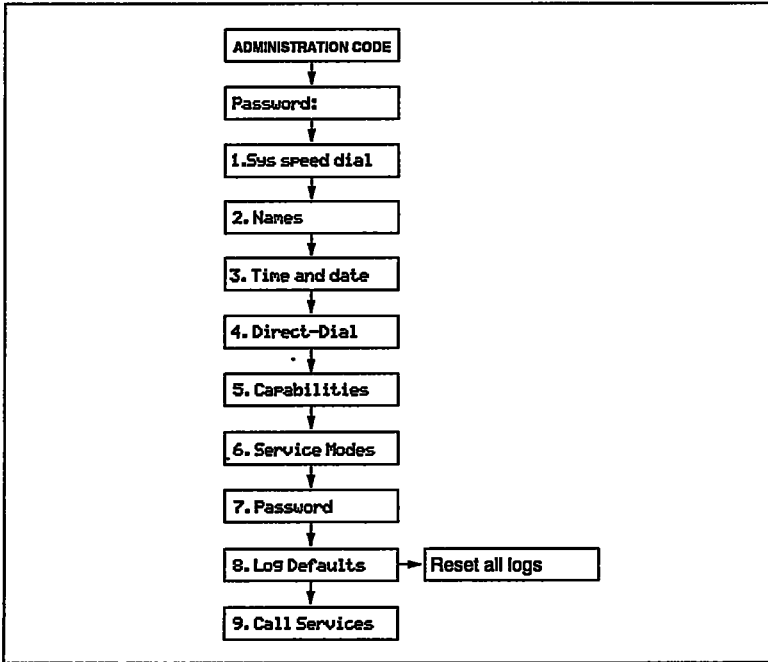

Reset All Logs

Use the button and the dial pad to enter the space allocation for the Call Log at each telephone. Use the OK display button to accept the settings and end Administration programming. The system automatically reallocates Log space.

Note: Reallocation of Call Log space may destroy Call Log data at telephones that lose space.

There are 80 Call Log spaces available in the system. There are no spaces allocated by default. Changing the space allocation using Log Defaults will define the log space available to every telephone in the system. Unassigned log space is available in a Log Pool and can be re-allocated in Call Services programming.

Call Services

If you subscribe to Call Display services, external calls are identified on the display. Call Services programming allows you to customize how this information is used.

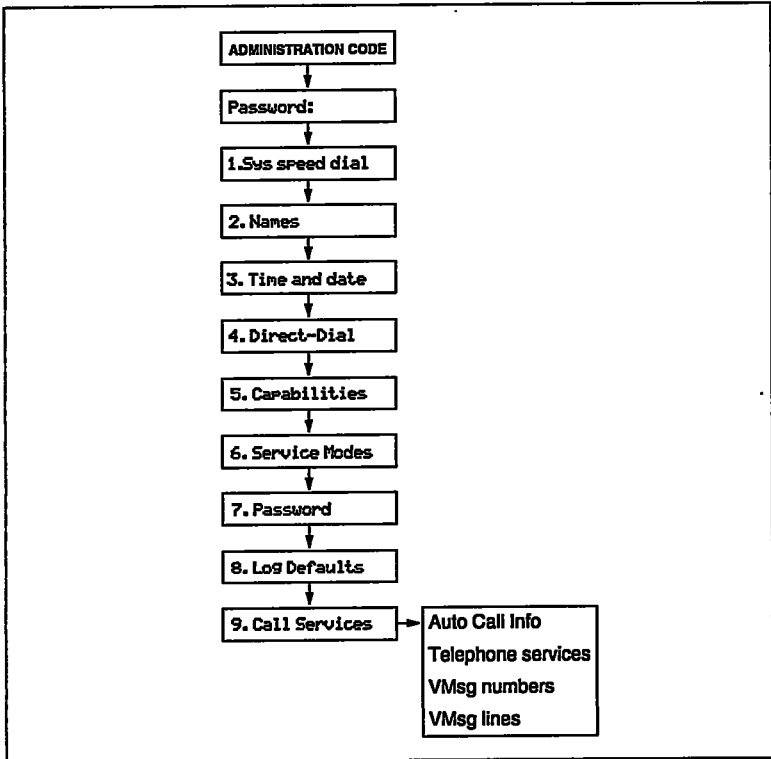

Auto Call Info

Automatic Call Information allows you to specify which telephone displays the Call Display information when a call is ringing on an external line. (After the call is answered, Call Display information is always shown at the telephone that answered the call.) Use the **CHANGE** display button and the dial pad to enter the internal number of the telephone to display Call Display information.

Note: In order for a telephone to display the Call Display information for calls on an external line, that telephone must also be programmed to ring for that line.

Telephone (Set) Services

Telephone Services programming allows you to customize how Call Display information is used at each telephone.

Autolog/Show Voice Message

Logging telephone (set)

Logging telephone allows you to specify the telephone that automatically logs Call Display information for calls on an external line. The line must appear on that telephone but it does not have to be a ringing line. Use the CHANGE display button to select the setting: N (No) or Y (Yes).

Show External Voice Message

If you subscribe to a Voice Message service, you can access that service through your Norstar system. Show External Voice Message controls the display of the External Voice Message Waiting indication for each line at each telephone. The telephone must have an appearance of that line. Use the CHANGE display button to select the setting: N (No) or Y (Yes).

Log Space

Log Space changes the number of items that can be stored in the Call Log for each telephone. Use the button, the ADD display button and the REMOVE display button to redistribute the log space. There is no log space assigned by default.

Programming hints

Space must be available in the Log Pool before any space can be added to a current Call Log space.

System-wide allocation of space is performed from Log Defaults programming. If you are performing extensive changes, it may be appropriate to use the Log Defaults programming mechanism instead.

Log Password

Log Password allows you to clear any Call Log password programmed with the Call Log feature. Use the CHANGE display button to clear the password programmed by the user. The setting is **None** until the user programs a password.

First Display

Depending on the services you subscribe to, Call Display information may contain up to three parts; the name of the caller, the number of the caller, and the name of the line in your Norstar system that the call is on. Use the **CHANGE** display button to select the setting to be shown first for each telephone: Name, Number or Line.

Programming hints

The Call Information feature is used to display and scroll through all of the Call Display Information: the caller name, number and line number. See the Telephone features chapter for more information.

You may see **Unknown name** or **Unknown number** on the display if the information is not available from your telephone company. You may see **Private name** or **Private number** on the display if the caller blocks that information.

Voice Message Center telephone numbers

If you subscribe to a Voice Message service, you can access that service through your Norstar system. This setting specifies the external telephone number that is automatically dialed by the Message feature to retrieve voice messages. Use the **CHANGE** display button and the dial pad to enter the external telephone number for each Voice Message Center.

Programming hints

The display does not show that external messages are waiting unless the Show External Voice Message prompt is set to Yes.

Five Voice Message Center numbers can be programmed, but most systems require only one.

Voice Message Center lines

If you subscribe to a Voice Message service, you can specify which Voice Message Center is used for each external line that can receive Message Waiting Indication. Use the **CHANGE** display button to select the setting: 1, 2, 3, 4, 5, or N (None).

Copying settings

Programmed settings for lines, telephones, and certain Capabilities can be copied to other lines or telephones. If many lines or telephones require the same settings, program one line or telephone, and then copy those settings.

Line programming

Line programming can be copied for Line abilities in the Capabilities section of Administration programming, and Ringing telephones in the Service Modes section of Administration programming.

Use the COPY display button and the dial pad to identify the source and destination of the copied information.

Telephone programming

Norstar telephone programming can be copied for Set Abilities in the Capabilities section of Administration programming.

Use the COPY display button and the dial pad to identify the source and destination of the copied information.

Capabilities programming

In addition to Line abilities and Set abilities, Norstar Capabilities programming can be copied for:

- Dialing filters
- COS passwords

Use the COPY display button and the dial pad to identify the source and destination of the copied information.

Programming reminders

The Programming reminders are a record of programmable settings which Norstar users may need to know on a day-to-day basis.

Fill out whatever sections are programmed and must be known. Not all of the programmable features may be required information.

Programmed settings can be determined from a review of the *3X8 DR5.1 Programming Record* .

Photocopy and distribute the Programming reminders to each desk that has a Norstar telephone, or post them on the wall next to the telephone.

Norstar telephones

User name/location	Internal number	Page zone
	__	__
	__	__
	__	__
	__	__
	__	__
	__	__
	__	__
	__	__

Prime telephone

Prime Telephone operator		
Internal number		__
Lines answered at the Prime telephone	__	__

Page zones

Page zone	Description
1	
2	
3	

Line Pools

Pool	Access code	Use
A	_____	
B	_____	
C	_____	

Miscellaneous programming

Direct-Dial telephone	__
Direct-Dial digit	__
Call Park Prefix digit	__
Dial first to make external calls	__

Call Pickup Groups

Pickup Group	Names of members of the group
—	<hr/> <hr/> <hr/> <hr/> <hr/> <hr/> <hr/> <hr/>
—	<hr/> <hr/> <hr/> <hr/> <hr/> <hr/> <hr/> <hr/>
—	<hr/> <hr/> <hr/> <hr/> <hr/> <hr/> <hr/> <hr/>
—	<hr/> <hr/> <hr/> <hr/> <hr/> <hr/> <hr/> <hr/>

Service Modes

Service Mode 1	Service Mode 2	Service Mode 3
Name _____	Name _____	Name _____
Start Time Stop Time _ : _ _ : _	Start Time Stop Time _ : _ _ : _	Start Time Stop Time _ : _ _ : _
Control telephone __	Control telephone __	Control telephone __
Extra-Dial telephone __	Extra-Dial telephone __	Extra-Dial telephone __

Service Mode 1: Ringing telephones								
Line	Internal number							
01								
02								
03								

Service Mode 2: Ringing telephones								
Line	Internal number							
01								
02								
03								

Service Mode 3: Ringing telephones								
Line	Internal number							
01								
02								
03								

Telephone features

Answer a call
Answering the telephone 74
Call Information 87
Call Pickup 101

Bring another person into a telephone conversation
Conference 107
Group Listen 131
Handsfree/Mute 132
Privacy 107
Unsupervised Conference† 107

Change your telephone defaults
Button Inquiry 128
Class of Service 112, 171
Contrast Adjustment 113
Customizing your telephone 113
Dialing Modes 122
Do Not Disturb 126
Feature programming 128
Language Choice 115
Line appearance 173
Line buttons 116
Lines 139
Norstar Telephones 153
Prime line 175
Private lines 174
Ring Type 118
Ring Volume 118
Telephone Admin. Lock 118

Check the length of a call
Call Duration Timer 176
Show Time 176

Communicate within your office
Dialing 120
Direct-Dial 121, 165
Page 157
Priority Call 160

Ring Again 121
Voice Call 181
Handle many calls at once
Answer buttons 153
Call Queuing 104
Hold 134
Prime telephone 74, 127

Have your calls answered at another telephone
Call Forward 84
Line Redirection† 141
Service Modes 162

Log your incoming calls
Autobumping 91
Call Log 89

Make calls quickly without having to dial the whole number
Autodial 81
Hotline telephone 165
Last Number Redial 121
Messages 147
Saved Number Redial 121
Speed Dial 167

Make calls to numbers outside your Norstar system
Dialing 120
External line access code 120
Host System Signaling 136
Line Pools 139

Transfer a call to another person
Call Park 99
Camp-On 105
External Transfer† 176
Transfer 176

† Some external lines may not support this feature. See the Availability of features heading in the Using Norstar features section.

Using Norstar features

To use a Norstar feature, enter the feature code and watch your telephone display for instructions. Different displays come up at different times, depending on how you invoke the feature and the choices you make while using the feature. If you want more information about a display, look it up in the Displays section of each feature listing.

Availability of features

Some features work only in certain circumstances. For example, Disconnect Supervision must be available and assigned to a line on your telephone to allow you access to the following features:

- Line Redirection of an external call to an external number
- Unsupervised Conference between two external calls
- Transfer between two external calls

Disconnect Supervision is available when an Open Switch Interval (OSI) message is provided on a line by the public telephone system.

If Disconnect Supervision is available, your Customer Service representative assigns Disconnect Supervision to lines in Configuration programming. When Disconnect Supervision is assigned to a line, the Norstar system monitors the length of the OSI on that line to determine when an external caller hangs up. This allows the system to release the line for other uses.

The Notes section of each feature listing contains information concerning any restrictions affecting the availability of the feature.

One-line and two-line displays

All Norstar telephones have LCD displays that give you information about your calls and guide you through Norstar features. The M7100 and M7208 Telephones have a one-line display. The M7310 and M7324 Telephones have a two-line display. The second line of a two-line display shows the functions of the three buttons directly below it. If you have a telephone with a two-line display, you can use these display buttons. Some display buttons, such as TRANSFER and ALL, are simply shortcuts. If you have a telephone with a one-line display, these shortcuts are not available. Other display buttons, such as OK and SHOW, perform essential functions. If your telephone has a one-line display, you can use the following buttons in place of these display buttons:

<u>OK</u>	<input type="text" value="Hold"/>	<u>CANCEL</u>	<input type="text" value="#"/>
<u>QUIT</u>	<input type="text" value="Rls"/>	<u>VIEW</u>	<input type="text" value="#"/>
<u>ADD</u>	<input type="text" value="*"/>	<u>OVERRIDE</u>	<input type="text" value="#"/>
<u>SHOW</u>	<input type="text" value="#"/>	<u>BKSP</u>	<input type="text" value="←"/>

All displays listed in this Guide are shown as they appear on the two-line display, except those that appear only on telephones with a one-line display. If you are using a telephone with a one-line display, ignore both the second line of the display shown in this Guide, and the instructions for using display buttons.

Common feature displays

You may see the following displays when you use a feature.

Someone is using Configuration or Administration programming. You cannot use programming features. Try again later.

You have taken more than 15 seconds to press a button in response to a display.

Invalid code

You have entered an invalid feature code.

Not available

You have tried to use a feature that is not available in the present set-up of your Norstar system.

Set locked

You cannot use the feature you have chosen because your telephone is locked. See Telephone Administration Lock in Customizing your telephone.

Dialing and answering the telephone

Many Norstar features require you to dial telephone numbers. The displays associated with dialing are listed in the Dialing section. If you see a display that is not listed with the feature you are using, look for it in the Dialing section. All the displays that appear when you are receiving a call are listed in the Answering the telephone section.

One button access

You can program most Norstar feature codes onto telephone memory buttons so that you can use the feature by pressing a single button. See the procedures in the Feature programming section.

Whenever the instructions tell you to enter a feature code, you can do so either by pressing the buttons shown in the feature description or by pressing a memory button on which the feature code has been programmed. You can also enter a telephone number by pressing an Autodial button, rather than entering it manually.

Canceling a feature

Some features change the way your telephone works. To make your telephone work normally again you must cancel the feature. To cancel a feature, press , then and the feature code. For example, to cancel Call Forward, which you activate by pressing , press .

If a feature code is programmed onto a memory button, you may be able to cancel the feature by pressing the memory button while the feature is active.

If you change your mind in the middle of using a feature, you can back out by pressing **Feature** or **Rls**. **Be aware that pressing **Rls** disconnects any active call.**

M7100 Telephone

Because the M7100 Telephone does not have any line buttons it sometimes works slightly differently from other Norstar telephones. Where other telephones may require you to select a line button to answer a call, on the M7100 Telephone you simply pick up the receiver. Where other telephones require you to select a line button to take a call off hold, you press **Hold** on the M7100 Telephone. The M7100 Telephone cannot have a **Handsfree** button. You will find special instructions for the M7100 Telephone in some feature descriptions.

Answering the telephone

Answering

Your Norstar telephone can receive many different types of calls. Your telephone's display tells you what type of call you are receiving. The usual way to answer a call is to pick up the receiver, but there are several other possible methods, depending on how your system is set up and the type of call that is ringing.

Callback

When you direct a call you have answered to another telephone, the system monitors the call to make sure someone answers it. If no one answers a call within a programmable length of time, the system directs it back to you. Callback generates a variety of displays. Most occur after a programmable delay and are listed in this section. Some occur immediately, if the telephone to which you are directing a call is out of service or otherwise unavailable. These are listed with the descriptions of the features in which they occur.

Delayed Ring Transfer (DRT)

If no one answers a call within a programmable length of time, the system transfers the call to the Prime telephone.

Call Display information

If you have subscribed to Call Display services from your local telephone company, one line of information about an external caller is displayed after you answer. If your telephone has been programmed to receive Call Display information automatically, that information is shown before you answer. If your telephone has not been programmed to receive Call Display information automatically, you can use the Call Information feature (Feature) to view the information before you answer.

Depending on the setting in Administration Programming and the external information available, either the caller's name or telephone number is displayed. When you transfer an external call to another Norstar user, this information is displayed on the recipient's telephone.

There will be a delay between the time your telephone first rings and when Call Display information is available. If you answer a call before the Call Display information arrives, that information is not available for the call. Since Call Display information arrives by the second ring, you can ensure that Call Display information is available by answering the call after the second ring.

Related features

Call Pickup

Call Pickup lets you use your telephone to answer a call that is ringing at someone else's telephone.

Call Queuing

Call Queuing allows you to choose the call with the highest priority when you have more than one call ringing at your telephone.

Do Not Disturb

Feature 8 5

If you do not wish to receive calls, turn on Do Not Disturb.

Handsfree/Mute

Handsfree
Mute

You can answer calls without picking up the receiver using Handsfree/Mute.

Prime telephone

A Prime telephone receives calls that go unanswered at other telephones. For more information, see Special telephones.

Retrieving a Parked Call

You can retrieve a parked call at any telephone in the system.

Voice Call Deny

Feature 8 8

If you do not wish to receive voice calls, turn on Voice Call Deny.

What line indicators mean

- | | |
|---|---|
| ▶ Flashing on and off for equal lengths of time | There is an incoming call on the line. |
| ▶ Flashing on and off more quickly | You have placed a call on hold. |
| ▶ Flashing on for longer than off | Someone else has put a call on hold on that line. |
| ▶ On, not flashing | You are connected to the call on that line or the line is in use elsewhere. |
| Off | The line is free. |

Rings you may hear

- | | |
|---------------------------------|--|
| A double beep every ten seconds | A call has been camped to your telephone. |
| A long single ring | There is an external call on the line for you. |
| A shorter double ring | There is an internal call on the line for you or a call is being transferred to you. |
| A brief single ring | A call is being redirected on one of your redirected lines. You cannot answer this call. See Line Redirection. |
| Three beeps descending in tone | You are receiving a priority call. |

Displays

You will see one or more of the following displays when you receive a call on your telephone and while you are answering that call. See Messages for a full explanation of the Messages feature. See Dialing for a full explanation of Ring Again.

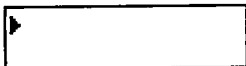

This indicates a long distance call.

21
TRANSFER

You are connected to an internal call. You can press TRANSFER to transfer the call.

22>21

Either you are receiving an internal call from telephone 22 forwarded by telephone 21 or you have an Answer button for telephone 21 and an internal call from 22 is ringing on 21.

21 calling

You are receiving a call from telephone 21.

Call 21?
YES NO

You have received a Ring Again offer for a call to an internal telephone. To call the number again, press YES or the flashing internal line button. On the M7100 Telephone, just lift the receiver. Otherwise, press NO or wait 30 seconds for the Ring Again offer to expire. For an explanation of Ring Again, see Dialing.

Camped: 21
CALLBACK

The person to whom you camped the call did not answer it. The call has come back to you. Press the CALLBACK button or the line button to reconnect to the call.

Line 01
TRANSFER

You are connected to an external call. You can press TRANSFER to transfer the call.

Line 01 transfer

The call on line 01 is being transferred to you by someone else in your Norstar system.

Line 01>21

Either you are receiving an external call forwarded from telephone 21 or you have an Answer button for telephone 21 and an external call is ringing on that telephone.

No calls waiting

You tried to use Call Queuing but no call was ringing at your telephone.

No line selected

There is no call ringing at your telephone. If you have a flashing line button but your telephone is not ringing, you must press the line button to answer the call on that line.

Not in service

The telephone to which you have directed a call is not in service or is otherwise unavailable. The call is returned to your telephone.

Parked call
CALLBACK

Nobody answered the call you parked. The call has come back to you.

Pick up receiver

You have used the Call Queuing feature without picking up the receiver and Auto Handsfree has not been assigned to your telephone. You must use the receiver or **Handsfree Mode** to answer a ringing call.

Priority Call
BLOCK

You are receiving a Priority Call. If you are on another call, inform the person you are speaking to that the call is about to be put on hold. Press the flashing line indicator of the Priority Call or wait till the call connects automatically (in eight seconds). The Priority Call goes through when you hear the next beep. Your active call is placed on Exclusive Hold. It will be reconnected automatically when the priority call ends unless you transfer the priority call. If you transfer the priority call you must press the line button of your original call to reconnect. (For the M7100 Telephone you must hang up the receiver to complete the transfer and then pick up the receiver and press **Hold** to reconnect.) To reject a Priority Call, use DND (**Feature** **8 5**) or press **BLOCK**.

Release a call

You have no free line buttons on which to receive a call. Release one of your current calls and try again to answer the incoming call.

Use line pool?
YES NO

You have received a Ring Again offer for a line pool. To use the line pool, press YES or the flashing internal line button. On the M7100 Telephone, just lift the receiver. Otherwise, press NO or wait 30 seconds for the Ring Again offer to expire. For an explanation of Ring Again, see Dialing.

Prime telephone Displays

If yours is a Prime telephone, you may see the following displays:

DND from 23

The person at telephone 23 has forwarded an external call to you using Do Not Disturb.

DND transfer

The system has transferred an external call to you from a telephone in Do Not Disturb mode.

DRT Line 01

Nobody answered this call on line 01, so the system transferred it to you.

Held by KAREN

Karen has held a call for too long, so the system has passed it to you.

Line 01 callback
CALLBACK



Someone has camped, parked or transferred a call on line 01, but no one has answered it. Press the CALLBACK button or the line button to connect to the call.

Line 01 to Prime

There is no telephone that can receive a call on line 01, so the system has transferred it to you.

Notes

There are three indications of an incoming call: ringing, a line button flashing, and a message on the display. You will not necessarily receive all three indications for any particular call. You may have a line that has been set up not to ring at your telephone. If so, you will see only a flashing line button. If someone makes a voice call to you, you will hear a beep followed by their voice. There are many possible combinations, depending on how your system is set up. See Lines in the System features section for more information on the use of lines.

There are many ways to answer a call. Many of them depend on settings in Administration programming. Depending on various settings and the type of call you are receiving, you may be able to answer a call by: picking up the receiver, picking up the receiver and pressing a line button, pressing , pressing  and pressing a line button, pressing a line button, or simply speaking.

If you receive a Priority Call and your telephone has no free internal line buttons, you cannot transfer the call or do anything else with it, except release it.

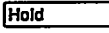
On M7100 Telephones, you may answer a second call by pressing . Your active call is put on hold and you are connected to the waiting call. You can have no more than two calls at a time.

Autodial

You can program memory buttons for one-touch dialing of internal or external telephone numbers.

External Autodial

Feature * 1

1. Press * 1.
2. Select the button you want to program. This is not necessary for the M7100 Telephone.
3. If you want this autodialer to use a particular line or line pool, select that line or line pool button. On the M7100 Telephone, you can only select a line pool button.
4. Enter the number.
5. Press **OK** or .

Internal Autodial

1. Press * 2.
2. Select the button you want to program. This is not necessary for the M7100 Telephone.
3. Enter the number.

Displays

You will see some of the following displays while programming an Autodial button. See Dialing for displays that may occur while using an Autodial button.

987.
QUIT BKSP OK

Continue to enter digits until the number is complete. Press **BKSP** or ⇒ to erase an incorrect digit. Press **OK** or when you are finished.

Autodial full

The memory allotted to Autodial numbers in your Norstar system is full.

Button erased

While programming External Autodial, you pressed **OK** or **Hold** before entering any digits. This erases the button.

Enter digits
QUIT OK

Enter the number you wish to program exactly as you would if you were dialing it yourself.

Hold or release

You cannot program an Autodial button while you are on a call. Finish your call or place it on hold before programming an Autodial button.

Intercom #: .
QUIT

Enter the internal telephone number you wish to program.

Press a button
QUIT

Press the memory button you want to program.

Program and HOLD

This display pertains only to the M7208 Telephone. Enter the number you want to program onto the button, then press **Hold**. You may include a line or line pool selection in an autodial sequence by selecting the line before entering any digits.

Program and OK
QUIT OK

Enter the number you want to program onto the button, then press **Hold** or **OK**. You may include a line or line pool selection in an autodial sequence by selecting the line before entering any digits.

Programmed

The number is stored on the button.

Notes

If the power to your Norstar system is off for more than three days, Autodial numbers may be lost from the memory.

Autodial numbers must be programmed onto memory buttons. They can not be programmed onto external or internal line buttons, the Handsfree/Mute button, or Answer buttons.

You can program Host System Signaling codes as part of a number on an External Autodial button. See Host System Signaling.

If you do not include a line selection in an autodialer, the call will use your Prime line, if you have one. If you select a line before pressing the Autodial button, any line selection programmed onto the button will be ignored.

You can copy the telephone number from a Last Number Redial button or Saved Number Redial button onto an Autodial button. Simply enter the Last Number Redial feature code or Saved Number Redial feature code when the Autodial feature asks you to enter a number.

You can use the Button Inquiry feature to check the numbers programmed on your autodial buttons.

Call Forward

Feature 4

Forward your calls

You can have all your calls forwarded to another telephone in the Norstar system.

1. Press Feature 4.
2. Enter the number of the internal telephone to which you want your calls forwarded.

Forwarding remains in effect until you enter the Cancel Call Forward feature code.

Cancel Call Forward

Feature # 4

You can start to receive calls again.

1. Press Feature # 4.

Call Forward on Busy

Call Forward on Busy redirects calls to another telephone when you are busy with a call. Call Forward on Busy is set up in Administration programming.

Call Forward (No Answer)

Call Forward (No Answer) forwards unanswered calls to another telephone. Call Forward (No Answer) is set up in Administration programming.

Call Forward Override

You can call someone and ask them to stop forwarding their calls to you.

1. Dial that person's number and ask them to cancel call forwarding. Your call will ring at that person's telephone even though they are forwarding their calls.

Related features

Do Not Disturb

Feature 8 5

You can use the Do Not Disturb feature to forward your calls to the Prime telephone.

Line Redirection

Feature 8 4

Note the differences between Line Redirection and Call Forward. Call Forward forwards all calls that arrive at a particular telephone to another telephone within the Norstar system. Line Redirection redirects only the lines you specify, no matter which telephones they appear on, to a telephone outside the Norstar system.

Displays

You will see some of the following displays while forwarding your calls. See Do Not Disturb for a full explanation of that feature. See Answering the telephone for displays that occur when a telephone receives a call forwarded by another telephone.

Forward denied

You cannot forward calls to the number you have chosen. There are several reasons why this can happen. For instance, you cannot forward your calls to a telephone that has been forwarded to your telephone.

Forward to:

Dial the internal number or press the Internal Autodial button of the telephone to which you want your calls to be forwarded.

Forward>21
CANCEL

Your calls are being forwarded to telephone 21. Press the **CANCEL** button or 7 4 when you want to stop forwarding your calls.

Not in service

Two or more telephones are linked in a forwarding chain, and one of them is out of service or is being used to program the system.

Notes

When a call is forwarded, it does not ring but its line indicator still flashes on your telephone. You can answer the call by pressing the button next to the flashing indicator.

If the telephone to which you forwarded your calls does not have the same external lines as your telephone, the forwarded calls appear on internal line buttons.

Telephones that have Call Forward on Busy active can still receive Priority calls.

Call Forward on Busy does not forward camped calls.

You cannot forward your prime line if it is in a line pool.

When Call Forward is active, all calls go to the Call Forward destination, regardless of the Call Forward on Busy and Call Forward no Answer settings.

Calls that are redirected by Line Redirection are not affected by any of the Call Forward features.

Call Information

Feature 8 1 1

Call Information allows you to display information about incoming calls. This information is more detailed than the Call Display information you automatically receive. See the Answering the telephone section in this chapter for details. For external calls, you can display the caller's name, telephone number, and the line name. For an internal call, you can display the name of the caller and their internal number. You can obtain information about ringing, answered, or held calls.

Note: Names and numbers for external callers are displayed only if you have subscribed to Call Display services from your local telephone company.

Display Call Information before or after answering

1. To find out who is calling or to obtain information about your current call, press Feature 8 1 1.
2. If the call is an internal call, the caller's name and the internal number are displayed.
OR
If the call is an external call, incoming call information may be available.

To obtain more information about an external call:

For a one-line display, press # repeatedly to display more information about the call.

OR

For a two-line display, continue to press VIEW to display more information about the call.

Display Call Information for a call on hold

1. To obtain information about your held call, press

.

2. The display shows **F**Select a call.
3. Select the line on hold.
4. If the call is an internal call, the caller's name and internal number are displayed.

OR

If the call is an external call, the caller's name is displayed.

To obtain more information about an external call:

For a one-line display, press repeatedly to display more information about the call.

OR

For a two-line display, continue to press VIEW to display more information about the call.

Related features

Call Log

Call Log displays the same information as Call Information, along with the date and time of the call, and the number of times the caller called.

Displays

You would see this display if you were on an active call with a caller at 555-1234.

You would see this display if you were on an active long distance call with a caller at 555-1234.

Note

Call Display information becomes available between the first and second ring of an alerting call. If you answer before the Call Display information is available on your display, and you press

, you will only see the line number or line name.

Call Log

Call Log creates a list of records of incoming external calls. The log could contain the following information for each call:

- sequence number in the Call Log,
- name and number of caller,
- indication if call was long distance,
- indication if call was answered (and identification of who answered it),
- time and date of the call,
- number of repeated calls from the same source, and
- name of the line that the call came in on.

Call Log has many benefits. For example, you may find it helpful to :

- keep track of abandoned or unanswered calls,
- call back a customer who was unable to reach anyone,
- track patterns for your callers (for example volume of calls and geographical location of calls),
- record caller information quickly and accurately, and
- build a personal telephone directory from log items.

Note: Names and numbers for external callers are displayed only if you have subscribed to Call Display services from your local telephone company.

Choose Logging Options

Feature * 8 4

You can select the type of calls that will be stored in your Call Log.

1. Press Feature * 8 4 .
2. If the default has not changed, the display shows **No one answered**. If you want to log calls that were not answered, press **OK** or Feature .
OR
 Press **NEXT** or # to display the next selection.
3. The display shows **Unanswered by me**. If you want to log calls that were unanswered at your telephone but answered elsewhere in the system, press **OK** or Feature .
OR
 Press **NEXT** or # to display the next selection.
4. The display shows **Log all calls**. If you want to log all calls, answered and not answered at your telephone, press **OK** or Feature .
OR
 Press **NEXT** or # to display the next selection.
5. The display shows **No autologging**. If you do not want information to be automatically logged, press **OK** or Feature .
OR
 Press **NEXT** or # to return to the first selection.
6. To exit, press **Fls** .

Use Logit (manually log a call)

Feature 8 1 3

If your calls are not automatically logged, Logit lets you manually log call information when you are connected to an external call. Being able to store information for your current call can be helpful in many situations. For example, you may want to:

- record a caller's information without using paper and pencil,
- record only selected calls that you personally choose, as opposed to using Call Log automatically, and
- quickly record caller information before a caller hangs up.

To manually log an external call:

1. Press **Feature** **8** **1** **3**.

OR

Press a memory key programmed with this feature code.
(See the Feature programming section in this chapter.)

Use Autobumping

Feature **8** **1** **5**

Since your log has a set number of entries that it can hold, Autobumping is a feature that lets you tell Norstar what to do when your log becomes full. When Autobumping is on, a new log entry causes the first entry to be deleted. If Autobumping is off, your Norstar system will not log new calls when your log is full.

1. To turn Autobumping on, press **Feature** **8** **1** **5**.

OR

To turn Autobumping off, press **Feature** **#** **8** **1** **5**.

Enter Call Log

Feature **8** **1** **2**

You can enter your Call Log to view stored information. The Log may display special characters. These are described in detail in the description of Displays, later in this section. To view your log:

1. Press **Feature** **8** **1** **2**.

2. The display shows the number of previously read items (Old) and the number of new, unread items (New) in the log.

3. To view old items, press **OLD** or *****.

OR







To view new items, press **NEW** or **#**.

OR

To return to the item being viewed when you last exited the log, press **RESUME** or **0**.



Navigate within Call Log

You can navigate within your Call Log to view a particular log entry. You can also scroll within an entry itself.



1. To scroll through an entry, press MORE or    ←
OR
To view the next entry, press NEXT or .
OR
To go back to the previous entry, press .
2. To exit, press .

Erase Log Items

It is necessary to routinely erase read log items to make space for new items in your log.

1. Navigate to the item you want to erase.
2. Press ERASE or .
3. To exit, press .

If you accidentally erase an item, you can undo the erasure.

1. Immediately after accidentally erasing an item, press UNDO or .
2. To exit, press .

Call from Call Log

You may find it helpful to place calls from within your Call Log. Each stored caller number may vary according to the information associated with that particular call. If the caller number involves a Centrex or PBX system, the first few digits may need to be "trimmed" to make the caller number dialable. If the number that you want to call is long distance or uses line pool access, digits may need to be added to the beginning of the number.

Place a call



1. Navigate to the log item for the number that you want to dial.
2. Display the number and edit it if necessary to make it dialable (the instructions for adding or trimming digits follow).
3. Press an external line or line pool button.
4. Lift the receiver. This is not necessary if Handsfree is programmed at your telephone.
5. The displayed number is dialed.

Trim a number involving Centrex or PBX

To trim the caller number:

1. Press **TRIM** or ⇒   , once for every digit that you want to remove.

Add digits for long distance or line pool access

1. Add digits to the number by pressing the appropriate dial pad digits, just as you would do to dial.
2. To remove digits you have added, press **BKSP** or ⇒   , once for every digit that you want to remove.

Optional Password

You have the option of accessing your Call Log through a password. If you forget your password, there is a facility in Administration programming to clear it (and then you could enter a new password from your telephone).

Assign a password to your Call Log

1. Press **Feature** ***** **8** **5**. The display shows **New Password:..**
2. Enter your four-digit password. The display shows **Repeat New:..**
3. Re-enter your four-digit password. The display shows **Password changed**, which confirms that your password has been assigned.

Using your Password to enter Call Log

1. Press **Feature** **8** **1** **2** to enter Call Log.
2. If you have programmed a password, **Password:..** appears.
3. Enter your four-digit password.

Change your password

1. Press **Feature** ***** **8** **5**. The display shows **Old Password:..**
2. Enter your old password. The display shows **New Password:..**
3. Enter your new four-digit password. The display shows **Repeat New:..**
4. Re-enter your password. The display shows **Password changed**, which confirms that your password has been changed.

Delete an assigned password

After assigning a password to your Call Log, you may later decide that you do not want to use a password at all.

1. Press **Feature** ***** **8** **5**. The display shows **Old Password:..**
2. Enter your old password. The display shows **New Password:..**
3. Press **OK** or **Hold** . The display shows **No Pswd assigned**, which confirms that your password has been deleted.

Related features

Call Information

The same Call Display information as in Call Log is displayed, but it is not recorded in a log.

Displays

You will see some of the following displays as you use Call Log.

12:KATE SMITH
NEXT ERASE MORE

This is a Call Log item with its sequence number. When the first digit is underlined, it is a new item.

12▶KATE SMITH
NEXT ERASE MORE

This indicates that the call was answered.

12▶KATE SMITH
NEXT ERASE MORE

This indicates a long distance call.

49/1234567890123
NEXT ERASE MORE

The "slash" symbol (/) indicates that the displayed information for a call has been truncated. Press **MORE** to display the remaining digits

Jan 4 9:00a 3X
NEXT ERASE MORE

This is the repeat call counter, shown along with time and date display. It indicates the number of calls you have received from the same caller.

Autobump ON	The Autobumping feature is active.
Autobump OFF	The Autobumping feature is deactivated.
Call(s) bumped	One or more calls have been autobumped.
Call for you	There is one new item in the Call Log.
Calls for you	There are two or more new items in the Call Log.
Call logged	The call was successfully logged with Logit.
Hold or release	Your active call must be held or released before entering Call Log.
In use: SETNAME	The external line is in use.
Item erased OK UNDO	The item was erased from the Call Log.
LINE 01 21 NEXT ERASE MORE	This display shows that this call was answered at telephone 21.
LINE 01 Logit NEXT ERASE MORE	This display shows that this call was manually logged.
LINE 01 NEXT ERASE MORE	This display shows that this call was not answered.
Log is empty	Your Call Log is empty.
Log is full	No additional calls can be logged until you either turn Autobumping on, or you delete some items in your log.
Messages & Calls MSG CALLS	This indicates that there are one or more items in your Message Waiting List, and that there are one or more new entries in your Call Log.

New calls begin

This appears before the first "New" item when navigating from the "Old" items to the "New".

No free lines

All lines in the pool are in use.

No info to log

No information is available on the call.

No log assigned

No log space has been assigned to the telephone.

No new items

There are no new calls in the Call Log.

No old items

There are no old or "viewed" items in the Call Log.

No resume item

The resume item is no longer in the Call Log due to Autobumping, repeat call update, or log reallocation.

Private name

The caller's name is private.

Private number

The caller's number is private.

Release calls

On an M7100 Telephone, the active call must be released before entering Call Log.

1:Unknown call

The caller's name and number are unknown.

1:Unknown name

The caller's name is unavailable.

1:Unknown number

The caller's number is unavailable.

Notes

You may want to use the punch-out overlay, which is provided in the *Call Log Feature Card*. This card is available in a separately orderable Call Display Key Cap Kit. Please contact your Customer Service representative.

The default log size is zero items. This size can be changed in Administration programming.

The long distance indicator may not be shown in the log, depending on the Call Display services provided by your local telephone company.

For tips on programming Call Logs, see the Call Display services section in the Welcome to Norstar chapter.

Call Park

Feature

Park a call

You can suspend a call so that it can be retrieved from any telephone in your system.

1. Press .
2. Use the Page feature to announce the retrieval code displayed by your telephone.

Retrieving a parked call

1. Select an internal line.
OR
If you have an M7100 Telephone, pick up the receiver.
2. Dial the call park retrieval code.

Displays

You will see some of these displays while parking a call. You may see some of these displays while retrieving a parked call.

Already parked

The person you were talking to has already parked your call. You cannot park the same call.

Get call first

You have attempted to park a call with no active call on your telephone. If the call you wish to park is on hold, you must reconnect to it before you can park it.

Invalid number

You have entered an invalid retrieval code.

No call on: 102

There was no call on the retrieval code you entered.

No call to park

You have attempted to park a call, but there are no calls at your telephone.

Park denied

You have tried to park a conference call. Split the conference and park the calls separately. The person who retrieves the calls can reconnect the conference.

Parked on: 102
PAGE EXIT

Record the code shown. Use Page (**Feature**) or press **PAGE** to announce the call and its retrieval code.

Parking full

Both available retrieval codes are in use. Transfer the call or take a message instead.

Notes

When you park a call, the system assigns one of two codes for the retrieval of the call. These codes consist of the Call Park prefix, which may be any digit from 0 to 9, and a two-digit call number 01 or 02. For example, if the Call Park prefix is 1, the second parked call is assigned the call park retrieval code 102.

Your Customer Service representative sets the Call Park prefix in Configuration programming. If the Call Park prefix is set to None, parking is disabled.

Your Customer Service representative also sets the Call Park Callback delay in Configuration programming. External calls parked for longer than the program delay are returned to your telephone.

Call Pickup

You can pick up a call that is ringing at another telephone.

Directed Pickup

Feature

You can answer any telephone that is ringing in your Norstar system

1. Press .
2. Enter the internal number of the ringing telephone.

Group Pickup

Feature

Your Norstar system can be divided into as many as four pickup groups. If you are a member of a pickup group, you can pick up a call that is ringing at any telephone in your pickup group.

1. Press .

Trunk Answer

Feature

The Trunk Answer feature allows you to answer an external call that is ringing at any other telephone in your office.

Trunk Answer works only with calls that are ringing on lines for which a Service Mode is active and if Trunk Answer is on in Administration programming.

1. Press .

Displays

You may see some of these displays while using a Call Pickup feature.

Already joined

You are already connected to the telephone that made the call you are trying to pick up. This can happen if you are on a call to a co-worker, your co-worker dials the number of a telephone in your pickup group, and you attempt to pick up that call.

Denied in admin

Your telephone is not a member of a pickup group.

No button free

You have tried to pick up a call when you have no line button available.

Pickup denied

(Pickup) There is no call that you can pick up or the call that was ringing has already been answered.

(Trunk Answer) The call that is ringing is on a line that is not in a Service Mode.

You have attempted to pick up a call on someone else's private line.

Pickup:

Enter the internal number of the telephone that is ringing. (You may use an Internal Autodial button to do this.)

If you decide not to answer a ringing call once you have activated Directed Pickup, press . The call will continue to ring.

Notes

Call Pickup cannot be used on private lines.

To use Directed Pickup, the telephone must be ringing. If, for example, the auxiliary ringer is ringing, but the call is not ringing at a telephone, the call cannot be answered using Directed Pickup. It must be answered normally at a telephone that has a flashing indicator for the call, or by using Trunk Answer.

If a call is ringing on an Answer button, you can use Directed Pickup to answer the call by entering the internal number of any member of the Answer group.

If there is more than one incoming call at a telephone in a pickup group, a call ringing on the Prime line is answered first followed by calls on external lines and, finally, calls on internal lines.

If there is more than one incoming call on lines in a Service Mode, the Trunk Answer feature picks up the external call that has been ringing the longest.

Telephones can be assigned to one of four pickup groups in Administration programming.

Call Queuing

Feature 8 0 1

When you have more than one call ringing at your telephone, you can choose the call that has the highest priority.

1. Press Feature 8 0 1 .
2. The system connects you to the call that has the highest priority.

Notes

Call Queuing answers external incoming calls before callback calls, and answers callback calls before camped calls.

Call Queuing can be programmed onto a memory button.

Camp-On

 Feature

Camp a call

You can send an external call to another telephone, even if all its lines are busy.

1. Press .
2. Dial the number of the telephone you want to camp the call on.

Related features

Transfer

 Feature

Camp-On is a variation of the Transfer feature.

Displays

You will see some of the following displays while camping a call.

21 Camp max
CALLBACK

You tried to camp a call to a telephone that already has a camped call. The call has come back to you. Press the CALLBACK button or the line button to reconnect to the call. On the M7100 Telephone, just pick up the receiver.

21 DND
CALLBACK

The person to whom you redirected a call has Do Not Disturb active on the telephone. The call has come back to you. Press the CALLBACK button or the line button to reconnect to the call. On the M7100 Telephone, just pick up the receiver.

Camp denied

You have tried to camp an internal call. You can only camp external calls.

Camp to:
CANCEL

Dial the number of the internal telephone to which the call will be sent.

Camped: 21
CALLBACK

The telephone to which you camped a call did not answer the call. The call has come back to you. Press **CALLBACK** or the line button to reconnect to the call. On the M7100 Telephone, just pick up the receiver.

Line 01 hung up

A call you camped has come back to you, but the caller hung up before you could reconnect.

Make call first

You have no call to camp. If the call you want to camp is on hold, take it off hold and then camp it.

Not in service
CALLBACK

The telephone to which you have camped a call is out of service or is being used for Configuration or Administration programming. The call has come back to you. Press **CALLBACK** or the line button to reconnect to the call. On the M7100 Telephone, just pick up the receiver.

Release a call

The line that the camped call is on is in use or that line does not appear at your telephone. Release the line or release an internal line.

Notes

To answer a camped call, use Call Queuing or select a line if the camped call appears on your telephone.

If you use Call Queuing to answer a camped call, external calls and callback calls are answered before the camped call.

Camped calls appear on a line button on the receiving telephone, if one is available. If not, there is just a message on the display and Camp tones.

Conference

Feature 3

Create a conference

You can talk to two people at once.

1. Make sure you have two calls, one active and one on hold.
2. Press Feature 3.
3. Take the held call off hold (this is automatic on the M7100 Telephone).

Conference using Privacy

Feature 8 3

Normally your calls are private; no one else can pick up your line and join in your conversation. You can turn Privacy off for a call allowing another person with the same line to press the line button and join in your conversation, forming a conference.

1. Press Feature 8 3.
2. Tell the other person to press the line button and join your conversation.

Disconnect one party

You can disconnect one party from a conference and continue talking to the other.

1. Press the line button of the call that you want to disconnect. The call that you want to keep is automatically put on hold.

OR

For the M7100 Telephone, press Feature # 3, which places one party on hold. Press Hold again if necessary, to put on hold the party that you want to keep.

2. Press Rls. The call is disconnected.
3. To speak to the remaining party, press the line button of the held call, or for the M7100 Telephone, press Hold .

Independently hold two calls

For all Norstar telephones except the M7100 Telephone, you can put the two people on hold independently so that they cannot talk to each other.

1. Press the line button of one person. The other person is automatically put on hold.
2. Press . The second person is put on hold.

You can re-establish the conference.

1. Take one call off hold.
2. Press .
3. Take the other call off hold.

Put a conference on hold

You can put a conference on hold, allowing the other two people to continue speaking to each other.

1. Press . The indicators beside the held line buttons flash, or for the M7100 Telephone, the display shows Conf. on hold.

You can reconnect to the conference.

1. Press either of the held line buttons, or for the M7100 Telephone, press . You are reconnected.

Split a conference

You can talk with one person while the other person is on hold.

1. Press the line button of the person you want to speak to. The other person is automatically put on hold.

OR

For the M7100 Telephone, press , which puts the first party on hold. Press again if necessary to switch parties.

You can reestablish the conference.

1. Press .
2. Take the held call off hold. This is not necessary for the M7100 Telephone.

Related feature

Unsupervised Conference

Feature

You can permanently disconnect yourself from the conference and leave the other two people talking by pressing (). However, if both of the other people are outside the system, there are some restrictions: at least one of the outside callers must have called you and that call must be on a disconnect supervised line.

Displays

You will see some of these displays while using the Conference feature.

You are trying to add a fourth party to your conference call, or to join two conferences together. Release one call from the conference before adding another, or keep the two conferences separate.

Privacy control cannot be used on internal or conference calls.

You have put a conference call on hold on an M7100 Telephone.

You have tried to make a conference call, but your system is already handling its maximum number of conference calls.

You are on a conference with the two lines or telephones shown. You can drop out of the conference and leave the other two parties connected (Unsupervised Conference) by pressing TRANSFER or entering the Transfer feature code.

You have tried to set up a conference call, without having made the calls that are to be connected. Make both calls first.

Notes

Only the person who established the conference can process the conference in any of the ways just described.

The Conference feature supports only three people.

If you are using an M7100 Telephone:

- Your conference is connected as soon as you enter the Conference feature code. There is no need to take the second call off hold.
- To split a conference, press . Then, press to change from one caller to the other.
- You cannot independently hold two calls.
- You cannot join an existing two-party call to establish a Privacy conference although you can use the Privacy feature for calls at your telephone.

You cannot split a conference that was set up using Privacy. When a third person joins a conversation on a line that has Privacy turned off, the call becomes a conference. All the rules applicable to a conference apply except that there is only one-line in use, instead of the normal two.

In certain situations, you may experience lower volume levels when using the Conference feature with two external calls.

COS Password

Feature 6 8

Change your Class of Service

A Class of Service password is a six-digit code that lets you switch from your current Class of Service to one that lets you dial numbers prohibited by your current Class of Service.

1. Press Feature 6 8 .
2. Enter your COS password.

Displays

You will see the first of these displays when entering a COS password, you may also see the second.

(Blank display) Enter your password. It will not be shown on the display.

You have entered a password that is not programmed into your system.

Notes

You must enter a Class of Service password each time you wish to make a call using a Class of Service not normally available on your line or telephone.

Norstar allows up to 20 Class of Service Passwords.

Class of Service passwords are defined in Administration programming.

Customizing your telephone

You can change the way a telephone works in several ways. Some of the following features are assigned to telephones in Administration programming. You can turn other features on and off at individual telephones.

Automatic Handsfree

Automatic Handsfree lets you make or answer a call without having to pick up the receiver or press the  button. The telephone's internal microphone and speaker turn on automatically when you make or answer a call.

Automatic Handsfree capability is assigned to a telephone in Administration programming. Full Handsfree capability must be assigned to a telephone before Automatic Handsfree capability can be assigned to it. This is also done in Administration programming.

This feature is not available on M7100 Telephones.

Contrast Adjustment

 * 7

You can set the contrast level of your telephone display.

1. Press  * 7.
2. Choose the contrast level you like best. The number of contrast levels available varies from one Norstar telephone to another.

This is the display you will see in Contrast adjustment.



Contrast level 2
DOWN UP OK

Press a number for the contrast level you want or press UP or DOWN. Press  or OK to set the new contrast level.

Dialing Modes

Feature * 8 2

You can set the dialing mode of your telephone.

1. Press Feature * 8 2 .
2. Choose the dialing mode you want.

Norstar supports three dialing modes: Automatic Dial, Pre-Dial, and Standard Dial. All three modes support on-hook dialing. (On-hook dialing means dialing a call without picking up the receiver.) The special features of the Automatic and Pre-Dial modes are available only when you dial on-hook.

The Dialing Modes feature code cannot be programmed onto a memory button.

Standard Dial

In Standard Dial mode, you make a call by selecting a line and dialing the number. If you have a Prime line, it is selected automatically when you lift the receiver or press **Handsfree Line**.

Standard Dial does not support on-hook dialing on an M7100 Telephone. If you have an M7100 Telephone, use the Automatic Dial or Pre-Dial mode for on-hook dialing.

Automatic Dial

If you have a Prime line assigned to your telephone, Automatic Dial allows you to dial a number without selecting a line. Your Prime line is selected as soon as you start dialing a number. Automatic Dial does not work if your Prime line is in use.

Telephones connected to an Analog Terminal Adapter (ATA) cannot use Automatic Dialing.

Pre-Dial

Pre-Dial allows you to enter a telephone number, check it, then change it before actually making the call. The call is not dialed until you select a line or line pool, or pick up the receiver.

You can pre-dial both external and internal numbers. You must, however, select the correct type of line (external or internal) for the type of number you have entered.

If all the lines on your telephone are busy, you will not be able to enter a telephone number.

If your telephone starts ringing while you are pre-dialing a number, you can stop the ringing by turning on Do Not Disturb (Feature). This does not affect numbers you are entering.

This is the display you will see when selecting a Dial mode.

Standard dial
NEXT OK

The current dial mode is shown. Press or NEXT until the dial mode you want appears. Press or OK to select the displayed dial mode. If Automatic Dial is not available it is because you have no Prime line.

Language Choice

English

Feature *

You can select English as the language of your telephone display.

1. Press Feature * .

Alternate Language

Feature *

You can select the alternate language as the language of your telephone display.

1. Press Feature * .

Each Norstar system supports English and one alternate language. Norstar systems are available with either French or Spanish as the alternate language. Button caps are available in both alternate languages.

You can select either English or the alternate language at each telephone. When your system is first installed, all telephones will use English.

You can program a memory button for one-touch switching between languages. Program **Feature** * 5 0 1 onto the button. Pressing the button will switch you back and forth between English and the alternate language.

Feature * 5 0 2 cannot be programmed onto a memory button.

One of the following displays will appear when you enter a language choice feature code.

En français...

Telephone display messages will be in French.

En español...

Telephone display messages will be in Spanish.

In English...

Telephone display messages will be in English.

Move Line buttons

Feature * 8 1

You can move external lines to different buttons on your telephone. You can use this feature to arrange your lines in the way that makes the most sense to you.

1. Press **Feature** * 8 1 .
2. Press the button you want to move the line from.
3. Press the button you want to move the line to.

You will see some of these displays while moving lines.

Invalid location

You have tried to move a line to a button that cannot be used as a line button, such as a Handsfree/Mute button, or an Answer button.

Move line from:
QUIT

Press the button of the line you want to move. Press **QUIT** or **Feature** when you have finished moving lines.

Move line to:
QUIT

Press the button you want to move the line to. Neither of the buttons is erased. The lines, or the line and feature, simply switch places.

Press a line

The button you are trying to move is not a line button. If you are trying to switch a line and a feature, move the line to the feature button and not vice versa.

Pulse/Tone Dialing

Each external line is set to either pulse or tone dialing. Pulse dialing is the traditional method of dialing used by rotary dial or push button single-line telephones. Tone dialing allows telephones to communicate with other devices such as answering machines. Tone dialing is required to access the features that PBX systems may offer.

Your Customer Service representative sets your lines to pulse or tone dialing in Configuration programming.

To switch from pulse to tone dialing

If your external lines are programmed for pulse dialing, you can switch your telephone temporarily to tone dialing.

1. Press **#** while on an active line. Once you hang up, your telephone returns to pulse dialing.

Ring Type Feature * 6

You can choose one of four distinctive rings for your telephone. This makes it easier to identify your telephone in an open office.

1. Press **Feature * 6**.
2. Choose the ring type you want.

This is the display you will see when choosing a ring type.

Ring type: 1
NEXT OK

Press [1], [2], [3], [4] or NEXT. You hear the selected ring for two seconds. Repeat until you hear the ring you prefer, then press [Hold] or OK.

Ring Volume

[Feature] * [8] [0]

You can set the volume at which your telephone rings.

1. Press [Feature] * [8] [0]. The telephone will ring.
2. Press [Left] [Right] to adjust the volume.

This is the display you will see while setting Ring Volume.

Press VOLUME bar

Press either side of the volume bar ([Left] [Right]) to adjust the volume.

Telephone Administration Lock

Telephone Administration Lock limits the ways in which you can customize your telephone. There are three types of Telephone Administration Lock: Full, Partial, and None.

Full Administration Lock lets you change the contrast of your telephone's display, your Ring Type, your Ring Volume, use Button Inquiry, and control the volume of your speaker.

Partial Administration Lock allows you to forward your calls, turn on Do Not Disturb and Service Modes, and use the Background Music, Send Message, Ring Again, Privacy, and Trunk Answer features.

None (No Administration Lock) allows you to access all features that are programmed for your telephone. Administration Lock is assigned to each telephone in Administration programming.

Telephone Administration Lock does not affect call handling features.

Related features

Autodial

Feature * 1 / Feature * 2

You can program your telephone's memory buttons to dial frequently used numbers with the Autodial feature.

Feature programming

Feature * 3

You can program feature codes onto your telephone's memory buttons using the Feature programming feature.

Speed Dial programming

Feature * 4

You can program Personal Speed Dial numbers onto Speed Dial codes 71 to 94 using the Personal Speed Dial programming feature.

Dialing

One of the most important features of your telephone system is the ability to dial telephone numbers. Many features require you to dial telephone numbers. The displays associated with dialing are listed here.

Note:

When dialing telephone numbers keep in mind that if there is a 10 second pause between dialing one digit and the next, the call will be cancelled by the system. You must reenter the dialing sequence from the beginning.

Direct-Dial

You can dial a Direct-Dial telephone with a single digit. The Direct-Dial telephone is usually in a central location, such as a receptionist's or secretary's desk. It is usually a Prime telephone with a Central Answering Position (CAP) module.

Your Customer Service representative assigns the Direct-Dial digit in Configuration programming.

External line access code

The external line access code is the number you dial to get an external line. You will need to use an external line access code if your Prime line is an internal line. The code will connect you to a line pool through your internal line.

If your Prime line is an external line, or if you select an external line on your telephone, you will not need an external line access code. You will always need an external line access code on an M7100 Telephone.

Your Customer Service representative assigns the external line access code in Configuration programming.

Last Number Redial

Feature 5

You can redial the last external number you dialed.

1. Press Feature 5.

Last Number Redial is enabled in Capabilities programming.

Ring Again

Feature 2

If you can't get through to someone on your Norstar system because their telephone is busy or there is no answer, you can have the Norstar system tell you when they hang up or next use their phone.

1. Press Feature 2 before you hang up.

You can also use Ring Again to tell you when a busy line pool becomes available.

Using Ring Again cancels any previous Ring Again requests at your telephone.

Cancel Ring Again

Feature # 2

You can cancel a ring again request by entering the Cancel Ring Again feature code.

Saved Number Redial

Feature 6 7

You can save the number of the external call you are on (providing you dialed the call) so that you can call it again later.

1. Press Feature 6 7 while you are still on the call.

You can dial a saved number.

1. Press Feature 6 7 when you are not on a call.

Saved Number Redial is enabled in Capabilities programming.

Related features

Autodial

Feature * 1 / Feature * 2

The autodial feature lets you program telephone numbers onto memory buttons for one-touch dialing.

Dialing modes

 Feature * 8 2

Norstar supports three different methods of dialing. They are described in the Customizing your telephone section under the heading Dialing Modes.

Line Pools

Line pools give you access to many external lines.

Priority Call

 Feature 6 9

If you get a busy signal when you call someone in your office, you can interrupt them using Priority Call.

Speed Dial

 Feature 0

The Speed Dial feature lets you dial programmed numbers by entering Speed Dial codes.

Displays

You will see some of these displays while selecting lines and dialing telephone numbers and in response to the numbers you dial.

9.
QUIT BKSP

You are dialing using Pre-Dial. To erase an incorrect digit, press **BKSP** or \Rightarrow . When the number is complete, select a line or lift the receiver.

21 busy
PRIORITY LATER

The telephone you have called has no internal lines available. You may press **LATER** to use the Ring Again or Message features or press **PRIORITY** to make a Priority Call.

95551234
TRANSFER

This prompt remains on your display as long as you are on a call you have dialed. You may transfer the call by pressing **TRANSFER**.

Already joined

Your telephone is already connected to the telephone you are trying to call. Check your active line buttons, and return to that call.

Calling 21
LATER

Wait for the telephone to be answered, or press LATER to use the Ring Again or Messages features.

Calling 21
PRIORITY LATER

Wait for the telephone to be answered. If no one answers, you may press LATER to use the Ring Again or Messages features, or press PRIORITY to make a Priority Call.

Can't ring again

You cannot use Ring Again on your current call. You can only use Ring Again while you have a busy signal on an internal call or line pool request or while an internal call is ringing.

Do not disturb
PRIORITY LATER

The telephone you are calling is in Do Not Disturb mode. Press LATER to use the Ring Again or Messages features, or press PRIORITY to make a Priority Call.

In use: 21

The line you have chosen is in use at another telephone. Use a different line, or wait until the line is free.

Invalid number

You have entered a number that does not exist.

Line denied

You have attempted to use someone else's private line.

Line in use

The line you have chosen is in use. Try another. If the line remains in use and never seems to clear, it may be hung. See Lines in the System features section for information on hung lines.

Line 01
TRANSFER

Enter the digits of the number you want to dial.

No button free

You have tried to make or receive a call when no line button was available.

No last number

You have not dialed an external telephone number since the last power interruption or system reset.

No line selected

Either you have no Prime line or your Prime line is busy. Select a line manually before dialing.

No number saved

You have tried to save the number of an incoming call. You can only save numbers that you have dialed yourself.

No saved number

You have tried to use Saved Number Redial, but have not first saved a telephone number. The Saved Number Redial memory is empty.

Not in service

You have entered the number of a telephone that is not in service.

On another call
PRIORITY LATER

The telephone you have called is on another call. Press LATER to use the Ring Again or Messages features, or press PRIORITY to make a Priority Call.

Restricted call

The call you are trying to make is not allowed for your Class of Service. Make your call on a line or telephone that is not restricted, or use a Class of Service password to bypass the restriction.

Ring Again?
YES NO EXIT

Press YES to use Ring Again. Press NO if you prefer to send a message. See Message and Ring Again.

Select a line

Either you have no Prime line, or the Prime line is in use, or the line programmed onto an Autodialer, Speed Dialer, or Hotline is in use. Select a line and dial again.

Send message?
YES NO

Press YES to send a message. See Messages.

Your number

You have dialed your own number.

Notes

The maximum number of digits that Last Number Redial or Saved Number Redial records is 24.

You can copy the telephone number from a Last Number Redial or Saved Number Redial button onto an Autodial button. Simply enter the Last Number Redial or Saved Number Redial feature code when the Autodial feature asks you to enter a number.

Each telephone can save only one number at a time with Saved Number Redial, not one number for each line.

Do Not Disturb

Feature 8 5

Do Not Disturb

You can stop calls from ringing at your telephone.

1. Press Feature 8 5.

Only Priority Calls will ring at your telephone. A line button will flash when you receive a call, but the call will not ring.

You can refuse to answer a particular call when it is ringing at your telephone. You can also refuse a Priority Call if all of the lines on your telephone are busy.

1. Press Feature 8 5.

Cancel Do Not Disturb

Feature # 8 5

You can cancel Do Not Disturb.

1. Press Feature # 8 5.

Do Not Disturb on Busy

When you are busy on a call and a second call comes in, your telephone rings softly to alert you to the second call. If you find this second ring distracting, you can have the system prevent a second call from disturbing you by assigning Do Not Disturb (DND) on Busy to your extension in Administration programming.

When DND on Busy is turned on for the set, internal and private network callers hear a busy tone instead of ringing when you are on the telephone. External callers are transferred to the prime set used in your system.

Displays

Do not disturb

Your telephone is in Do Not Disturb mode. To cancel Do Not Disturb, press **Feature** **#** **8** **5**.

Allow calls

Your telephone is receiving calls normally.

Note

If you use Do Not Disturb while an external call is ringing, the call will be forwarded to the Prime telephone. It may also be answered by anyone whose telephone shares the line it is on. Once you turn Do Not Disturb on, calls will be forwarded to the Prime telephone only if there is no other telephone on which the line appears. (The Delayed Ring Transfer feature transfers all unanswered calls to the Prime telephone after a specified time.)

Feature programming

Feature * 3

Program a button

You can program a feature code onto a memory button.

1. Press Feature * 3.
2. For all telephones other than the M7100 Telephone, select the button you want to program.
3. Enter the feature code you want to program onto the button.

Erase a button

Feature * 1

You can erase a memory button.

1. Press Feature * 1. This is actually the External Autodial feature code.
2. For all telephones other than the M7100 Telephone, select the button you want to erase.
3. Erase the button by pressing **OK** or **Hold**.

You cannot erase Answer, Handsfree/Mute, Intercom, or line buttons.

Button Inquiry

Feature * 0

You can check the function of any line, Intercom, or memory button on your Norstar telephone.

1. Press Feature * 0.
2. For all telephones other than the M7100 Telephone, press the button you want to know about.
3. Read the display.

When you are labeling or replacing a button cap, activate Button Inquiry so that you won't accidentally activate a feature.

Displays

You will see some of the following displays while programming, erasing, or checking buttons. A variety of displays appear in Button Inquiry. See the appropriate feature description in this chapter for a list of displays pertaining to the use of a feature programmed onto a memory button.

123456789012345_
VIEW→ OK

Press **[#]** to move either right or left, or press **VIEW→** or **←VIEW** to view a number that is too long to fit on the display. Press **[Hold]** or **OK** when you are finished.

<Feature name>
SHOW OK

The name of the feature assigned to a button is displayed when you press the button. **SHOW** appears when there is more information available. Press **[#]** or **SHOW** for additional information.

Enter code:

If you are checking a Speed Dial button, enter the two-digit Speed Dial code that you want to check.

Enter digits

This display pertains only to the M7100 Telephone. To erase the button, press **[Hold]**.

F_
QUIT CLEAR

While entering a feature code you can press **[Feature]** or **QUIT** to quit programming or **CLEAR** to clear out the characters you have entered. The system will accept the entry as soon as you enter a valid feature code.

Feature code:
QUIT

Press **[Feature]** and enter the feature code you want to program onto the button. Invalid codes cannot be entered.

Feature moved

You have programmed a button with a feature that was already programmed onto another button. The feature has moved to the button you just programmed. Its original button is blank.

Hold or release

You cannot program a feature button while you are on a call.

Press a button
QUIT

Press the button you want to program the feature onto.

Press a button
EXIT

Press the button you want to check. Press or **EXIT** when you are finished.

Program and **HOLD**

This display pertains only to the M7208 Telephone. To erase a button, press .

Program and **OK**
QUIT **OK**

To erase a button, press or press **OK**.

Release calls

You have tried to use Button Inquiry while you were on a call or had calls on hold.

Notes

When this Guide tells you to enter a feature code, you can do so by pressing a memory button programmed with that feature code. In some cases, pressing the button a second time cancels the feature.

On the M7100 Telephone, Button Inquiry shows your internal number followed by the function assigned to your single memory button.

Any memory button not programmed as an external or internal line, Answer button, or Handsfree/Mute button, is available for programming features.

The following feature codes cannot be programmed onto a memory button: any code beginning with except Language Choice and Contrast Adjustment.

Group Listen

Feature 8 0 2

Group Listen

You can let people in your office listen in on a call.

1. Press Feature 8 0 2. You will hear the caller's voice through your telephone's speaker.
2. Continue to speak to the caller through the telephone receiver. The caller will not hear people in your office.

Cancel Group Listen

Feature # 8 0 2

You can cancel Group Listen for the current call.

1. Press Feature # 8 0 2.

Group Listen is canceled automatically when you hang up the Group Listen call.

Displays

You may see one of these displays with Group Listen.

Make call first

You have tried to use Group Listen when you are not on a call.

Pick up receiver

You have tried to use Group Listen without picking up the receiver.

Notes

Keep the receiver away from the speaker, or you may hear feedback. The higher the volume, the more the feedback. Press the Rls button to prevent feedback when hanging up.

You can switch a Group Listen call to Handsfree by pressing

Handsfree Mic . To switch back to Group Listen, enter the Group Listen feature code again.

Handsfree/Mute



Make calls without lifting the receiver

You can make calls without lifting the receiver. However, you must have a Prime line assigned to your telephone.

1. Press . The telephone's internal microphone and speaker are automatically turned on.
2. Dial your call.
3. Speak normally.

Answer calls without lifting the receiver

You can answer calls without lifting the receiver.

1. When your telephone rings, press . The telephone's internal microphone and speaker are automatically turned on if you have a Prime line assigned to your telephone.
2. Speak normally.

Mute Handsfree

You can switch off the telephone microphone so that you can speak privately to someone in your office while you are on a handsfree call.

1. Press . The microphone is turned off.

You can turn the microphone back on again and continue your handsfree call.

1. Press .

Regular call to Handsfree

You can turn any regular call into a handsfree call.

1. Press  and hang up the receiver.

Handsfree to regular call

You can turn a handsfree call into a regular call.

1. Lift the receiver.



Notes

The indicator next to  is solid when you are in Handsfree mode. It flashes when you mute the microphone.

In open-concept environments, use the receiver or a headset when Handsfree communication is not necessary, or when you need privacy during a call. Always tell the person you are speaking to that you are using Handsfree, and let them know who else is listening to the conversation.

Direct your voice toward the telephone. The closer you are to the telephone, the easier it is for the microphone to transmit your voice clearly to your listener.

Wait for your caller to finish speaking before you speak. The microphone and speaker cannot both be on at once. Your caller's voice may be cut off if you both speak at the same time. Noises such as a tapping pencil could be loud enough to turn on your microphone and cut off your caller's speech.

To prevent a possible echo, keep the area around your telephone free of paper and other objects that might screen your microphone. Turning down the microphone's volume (using   ) also prevents echo.

Place the telephone so that any unavoidable local noise (such as an air conditioner) is behind it. This limits the amount of disruptive background noise.

Handsfree is assigned to a telephone in Administration programming.

The Handsfree/Mute feature is not available on M7100 Telephones.

Hold

Hold

Put a call on hold

You can temporarily suspend a call.

1. Press .

When a call is on hold, its indicator flashes on all telephones that have access to the line. The call can be retrieved from any of these telephones.

Retrieve a held call

You can connect to a call on hold.

1. Press the flashing line button of the held call.

Automatic Hold

You can switch from one call to another.

1. Press the line button of the caller you want to speak to. Your current caller is put on hold automatically.

Listen on Hold

If you have been put on hold, you can hang up the receiver while you wait for the other person to return.

1. Press .
2. Hang up the receiver.
3. Press the line button of the call. (For the M7100 Telephone press). You may hear indications from the far end that you are on hold (for example, tones or music).
4. When the person you were talking to returns you will hear them through your telephone speaker. Lift the receiver and talk.

Exclusive Hold

Feature 7 9 **OR**Feature Hold

You can put a call on Exclusive Hold so that it can be retrieved only at your telephone.

1. Press Feature 7 9 or Feature Hold . The line appears busy on all other telephones, and the call cannot be picked up by anyone else in the office.

Music/Tones/Silence on Hold

External callers can hear either music, a periodic tone, or silence while they are on hold. In order for your caller to hear music, your company must have installed a music source.

WARNING

In accordance with U.S. copyright law, a license may be required from the American Society of Composers, Authors and Publishers, or a similar organization, if radio or TV broadcasts are transmitted through the Music on Hold feature of this telecommunication system.

Northern Telecom Inc. hereby disclaims any liability arising out of the failure to obtain such a license.

Your Customer Service representative sets this feature to music, tones, or silence in Configuration programming.

Notes

On the M7100 Telephone, Hold alternates between two lines: one active, one on hold. The M7100 Telephone cannot retrieve a call placed on hold by another telephone.

If the Automatic Handsfree feature has been assigned to your telephone, use the Handsfree/Mute feature instead of Listen on Hold.

Host System Signaling

You can access Host systems, such as Private Branch Exchanges (PBX) from Norstar by using Host System Signaling features (also known as End-to-End Signaling). These features either send a special signal to the host system or allow you to program delays required by host systems onto External Autodial buttons or Speed Dial codes.

Host system signaling codes

Link

Feature 7 1

If your Norstar system is connected to a Private Branch Exchange (PBX), you can use a Link signal to access special features.

The Link signal can also be included as part of a longer stored sequence on an External Autodial button or in a Speed Dial code. The Link symbol (☎) uses two of the 24 spaces in a dialing sequence.

Allow Link is enabled in Capabilities programming.

Pause

Feature 7 8

The Pause feature enters a 1.5 second delay in a dialing sequence on an external line. This is often required for signaling remote devices, such as answering machines, or when reaching through to PBX features or Host systems.

You can obtain a Pause with one button press if you program the feature code onto a memory button. More than one Pause can be programmed onto an External Autodial button.

The Pause symbol (⏸) uses one of the 24 spaces in a dialing sequence.

For Pulse Dialing, (*) inserts a 1.5 second pause into the dialing sequence.

Programmed Release

Feature *

The Programmed Release feature performs the function of the button in a programmed dialing sequence. When the system encounters a Programmed Release at the end of a programmed dialing sequence, it hangs up the call after the numbers are dialed. The Programmed Release symbol (☐☐) takes up two of the 24 spaces in a programmed dialing sequence.

Run/Stop

Feature *

Run/Stop inserts a break point into a sequence of dialed numbers or characters used for automatic dialing. This may be necessary when you are connecting to a PBX or similar Host system.

For example, you may call a company with an automated attendant that instructs you to dial the internal number you need. You can program the company number, a Run/Stop, then the internal number on one External Autodial button. Press the autodialer once to dial the company number. When you hear the automated attendant, press the autodialer again to dial the internal number.

The Run/Stop symbol (☐) uses one of the 24 spaces in an External Autodial or Speed Dial sequence.

Displays

You may see this display while entering Host System Signaling codes.

Invalid code

You have entered a code that can only be used in a programmed Autodial or Speed Dial sequence, not on a call you dial directly. Programmed Release and Run/Stop are for use in programmed dialing sequences only.

Note

If your external telephone lines are programmed for Pulse dialing, you can temporarily switch to Tone dialing by pressing **#** after selecting the line. Tone dialing lets your Norstar telephone communicate with devices and services that respond to tone signals, such as automatic switchboards, and fax or answering machines.

Line Pools

 Feature 6 4

Use a line pool

A line pool is a group of external lines that can be shared by many telephones. You can use a line in a line pool to make an external call.

1. If you have a free internal line, dial a line pool access code on an internal line. (You do not need the Line Pool feature code.)

OR

If you have no free internal line, press Feature 6 4 and then a line pool access code.

Everyone in the office should have a list of the line pool access codes for the line pools their telephones can use. See the Programming reminders section in the Programming chapter.

Displays

You may see some of the following displays while using a line pool. For displays associated with dialing telephone numbers, see the Dialing section.

 Code:

Enter a line pool access code.

 Denied in admin

Access to the line pool you requested is denied in Configuration programming.

 Invalid code

You have entered an invalid line pool access code.

 Line in use

The line chosen by the system for your line pool request became active before connecting with your call. Retry the line pool request.

 No button free

There is no free button on which the line pool line can appear.

No free lines

You have tried to access your line pool, but there are no lines in the line pool or all the lines are busy. Use Ring Again or call again later.

Notes

You do not usually need to enter the Line Pool feature code to use a line pool. Simply dial the line pool access code on an internal line. If you have no free internal lines, you will need to use the feature code to get a line pool. You will also need it to program access to a specific line pool onto a memory button.

You can program a button to access a line pool by programming the Line Pool feature code and a line pool access code onto a memory button in Feature programming (Feature *). When all the lines in a line pool are busy, the indicator for the Line Pool button turns on. The indicator turns off when a line becomes available.

Your Norstar system can have three line pools, and a telephone can be programmed to access any number of them.

You can use a line pool only to make external calls.

If no lines are available in the line pool, you can use Ring Again at the busy tone. You will be notified when a line in the line pool becomes available. See Ring Again.

Your Customer Service representative gives telephones access to line pools in Configuration programming. Each line pool is assigned a line pool access code in Configuration programming.

Line Redirection

Feature 8 4

Redirect a line

Line Redirection lets you send your external calls to a telephone outside the office. You may choose to redirect all your external lines or only some of them.

1. Press Feature 8 4 .
2. Select the outgoing line to be used for redirected calls.
3. Enter the number to which calls will be redirected and press **OK** or Hold .
4. Select the lines to be redirected and press **OK** or Hold .

Cancel Line Redirection

Feature # 8 4

You can cancel Line Redirection.

1. Press Feature # 8 4 .
2. Select the lines for which redirection is to be canceled and press **OK** or Hold .

Related features

Call forward

Feature 4

Note the differences between Line Redirection and Call Forward. Call Forward forwards all calls that arrive at a particular telephone to another telephone within the Norstar system. Line Redirection redirects only the lines you specify, no matter which telephones they appear on, to a telephone outside the Norstar system. Line Redirection takes precedence over Call Forward.

Displays while redirecting lines

You will see some of the following displays while programming Line Redirection. The displays you see while canceling redirection are listed after this chart. See the Dialing section for displays that occur while entering telephone numbers.

Access denied

You cannot perform line redirection on an M7100 Telephone.

Denied in admin

You have tried to redirect calls, but your telephone is not allowed access to this feature. See the Allow redirect section in the Programming chapter.

Enter digits
QUIT OK

Enter the telephone number to which you wish to redirect calls using one of the following methods:

- Press an External Autodial button.
- Enter an external telephone number of no more than 24 digits. Then, press **Hold** or **OK**.
- Press **Hold** or **OK** if the line you have chosen as the outgoing line is a private network line that does not require you to dial digits.

In use: 21

You have tried to program redirection while someone else is programming redirection. Only one person can program Line Redirection at a time.

Line Redirection
QUIT ADD REMOVE

Press **#** or the **ADD** button to begin redirection. Press **REMOVE** or **#** to cancel a previous redirection.

No line to use

You have one external line on your telephone, but you need a second line to perform line redirection. Redirect your external line using a line pool as the outgoing line.

Outgoing line

You are attempting to redirect a line and the line you have chosen is the outgoing line you have selected as a destination. You cannot redirect a line to itself. Select another line.

Pool code: .
QUIT

Enter a valid line pool access code.

Programmed

This message appears when you have successfully redirected a line or successfully canceled redirection of a line.

Redir by 21
OVERRIDE

You have attempted to redirect a line, but someone else has already redirected that line. You may press OVERRIDE or ***** to override the previous redirection and redirect the line as you wish.

Restricted call

The destination you have chosen for line redirection is restricted.

Select line out
QUIT

Select the line that will be used to redirect calls out of the system, using one of the following methods:

- Press an external line button.
- Press an internal line button and dial a line pool access code.
- Press a line pool memory button.
- Press an External Autodial button if it has a line selection programmed.

Select line(s)
QUIT ALL

Press the lines that are to be redirected. To deselect a line, press it again. You may press ALL to redirect all your lines.

Select line(s)
ALL OK

Continue to press the lines that are to be redirected. Press OK or **Hold** when you are finished.

Unequipped line

The line you are attempting to redirect cannot be redirected because it is not a disconnect supervised line. Your Customer Service representative assigns disconnect supervision to lines.

Displays while canceling redirection

You will see the following displays while canceling Line Redirection.

Redir by 21
OVERRIDE

This line is redirected by someone else. Press OVERRIDE or ***** to cancel redirection of the line.

Select line(s)
QUIT ALL

Press the lines that are no longer to be redirected. The lines light up as you press them. Once you cancel redirection for a line you cannot restore it by pressing the line again. You may press ALL to cancel redirection for all your lines.

Select line(s)
ALL OK

Continue to press the lines that are no longer to be redirected. Press OK or **Hold** when you are finished.

Notes

The Line Redirection feature is not available on the M7100 Telephone.

You can answer the telephone if it rings while you are in the middle of programming Line Redirection, but none of the Norstar call handling features will be available until the feature times out. If you need to use a Norstar feature to process the call, you must quit Line Redirection programming by pressing the **Feature** button. **Do not press **Rls** or you will disconnect the call you are trying to process.**

While you are programming Line Redirection you will only receive an indication of calls that actually ring at your telephone.

The system does not check that the number you give for line redirection is a valid one. If you redirect to an invalid number, redirection will fail. Using an External Autodialer to enter the redirection number helps avoid this possibility. An External Autodialer used for line redirection must have a specific line programmed onto it.

If you use the ALL button to redirect all your lines, it is important that you wait until all the lines on your telephone light up before pressing Hold or OK. If you press Hold or OK before all the lines light up, those lines not lit will not be redirected.

Be aware of the consequences of redirecting your lines. If you redirect your line to your home, for instance, and someone calls you from home, they will get a busy signal when the system tries to call the telephone they are using. Companies with offices in different time zones should avoid situations in which the lines from the eastern office are redirected to the west and those from the west are redirected to the east. This could result in a costly long distance redirection loop.

The system can be set up so that redirected calls give a brief ring on telephones in the Norstar system as they are redirected. These calls cannot be answered within the system until you cancel redirection.

The line chosen for redirecting calls on other lines can still be used normally when it is not busy on a redirected call. To avoid redirection failing because the chosen line is in use, choose a line pool with several lines in it.

When redirecting an external call to an external number, note the following restriction: the incoming call must be on a disconnect supervised line.

In certain situations, callers may experience lower volume levels when you use Line Redirection.

Long Tones

Feature 8 0 8

The Long Tones feature lets you control the length of a tone so that you can signal devices such as fax or answering machines which require tones longer than the standard 120 milliseconds.

1. While on a call, press Feature 8 0 8 .
2. Press the dial pad buttons to produce the appropriate tones. Each tone will sound for as long as you hold down the button.

Long Tones is canceled automatically when the call is released.

Displays

You will see some of the following displays while using Long Tones.

Long Tones:

At the appropriate time, press any dial pad button. Hold each button down for as long as necessary. You can cancel Long Tones by pressing Feature .

Make call first

You have tried to use Long Tones when you are not on a call.

Tones denied

The person you are calling has pressed Hold , canceling your long tones.

Note

Long Tones can be used on any call except a conference call. You can use internal lines of the Norstar system to activate a device connected to an Analog Terminal Adapter (ATA) in another area of your office, or external lines to access devices outside the Norstar system.

Messages

The Messages feature allows you to send a message to another Norstar user, and lets you know if you have any messages waiting. As well, the Messages feature uses a Message Waiting List to keep a record of your internal messages and your (external) voice mail messages, if the service is provided by your telephone company. From your Message Waiting List, you can:

- view your messages,
- call back the internal caller who left a message,
- erase an internal message,
- call your Voice Message Center that left a message(s), and,
- clear a message sent by your Voice Message Center (the message still remains at the Center until it is erased there).

Send a message

Feature 1

You can leave a message on the display of another telephone in your Norstar system.

1. Press .
2. A one-line display shows **Message to:**
OR
 A two-line display shows **Message list.** Press **ADD** to display **Message to:**
3. Enter the internal number that is to receive your message. Your recipient's display identifies that the message has arrived.

Show your sent messages

Feature 1

On a telephone with a two-line display, you can show and scan the messages you have sent.

1. Press . The display shows **Message list.**
2. Press **SHOW** to display your first sent message.

Cancel a sent message

Feature [] # 1

You can cancel a message that you have sent to someone.

1. Press Feature [] # 1. The display shows **Cancel for:**
2. Enter the internal number for the message that you want to cancel.

Notification of message(s)

If another user in your Norstar system or your Voice Message Center has sent you a message, your display reads **Message for you** or **Messages for you**. If you also have items in your Call Log, your display reads **Messages & Calls**.

Enter your Message Waiting List

Feature [] 6 5

To enter your Message Waiting List:

1. Press Feature [] 6 5. The display shows the first item.

Navigate through your Message Waiting List

To navigate forward through your list, press **NEXT** or [#]. To navigate backward, press [*].

Call from your Message Waiting List

From your Message Waiting List, you can call the person (or your Voice Message Center) who sent the message. First, you may want to view your messages and decide if you want to reply to them.

1. Press Feature [] 6 5. The display shows the first message.
2. Press **NEXT** or [#] to scroll through the list of messages.
3. To call a particular number, press **CALL** or [0]. The telephone number that is dialed to access your Voice Message Center is programmed in Administration programming. This telephone number is dialed automatically when you press **CALL** or [0].

If you wish to use a line other than the programmed line, exit from the Message Waiting List and dial the Voice Message Center telephone number using normal dialing methods.

Remove items from your List

Feature # 6 5

You can erase an internal message or clear a message you have received from your Voice Message Center. When you clear this message from your Message Waiting List, it still exists at your Voice Message Center until you erase it there. To erase a voice message, refer to your Voice Message Center documentation.

1. From an idle telephone, press Feature # 6 5 to erase or clear the first message (either an internal message or a message from your Voice Message Center).

OR

From within your Message Waiting List, press CLEAR or ERASE or Hold for the item that you want to remove.

Related features

Call Log

The status display for the Message Waiting List shares the same display with the Call Log status display.

Displays

You will see some of the following displays while sending messages.

1.21
NEXT ERASE EXIT

When reviewing the messages you have sent, press NEXT to view the next message or ERASE to erase the message on the display.

21 called
NEXT CALL ERASE

This is the Message Waiting List display for internal messages. Press NEXT to see the next message. Press CALL to reply to the message. Press ERASE to erase the message.

Can't send msg

You have tried to send a message to a Norstar Analog Terminal Adapter. The Norstar Analog Terminal Adapter does not have a display so it cannot show a message.

Cancel denied

You have entered an invalid number when attempting to cancel a message.

Cancel for:

Dial the internal number to which you sent the message you wish to cancel.

Cleared)LINENAM
NEXT

You have cleared an external message from your Message Waiting List. The message itself still exists in your Voice Message Center until you erase it there.

Erased) 21
NEXT

You have erased an internal message.

Hold or release

This message does not pertain to M7100 Telephones. If you try to access your Message Waiting List while on an active call, this display advises you to hold or release the present call.

In use: 21

You are trying to call from your Message Waiting List. The line that you are trying to use is being used by the identified Norstar user.

L01:LINENAM UMsg
NEXT CALL CLEAR

This is the Message Waiting List display. For that particular voice message, it tells you the line the call came in on, and the name of that line.

Message denied

You have tried to send a message to an invalid internal number or to a telephone that is out of service.

Message for you
MSG

You have a one item in your Message Waiting List, and you have no new entries in your Call Log. Press MSG to review the message.

Message list
SHOW ADD EXIT

The SHOW display button appears only if you have outstanding messages. Press SHOW to review or erase messages you have sent. Press ADD to send a new message.

Message to:

Enter the internal number of the telephone to which you would like to send a message.

Messages & Calls
MSG CALLS

This indicates that there is more than one item in your Message Waiting List, and there are one or more new entries in the Call Log.

Messages for you
MSG

You have more than one item in your Message Waiting List, and you have no new entries in your Call Log. Press MSG to review the messages.

No button free

You have no line button free with which to reply to a message.

No messages

You don't have any messages to cancel or there are no messages to scan through.

No number stored

There has been no number programmed for the Voice Message Center. To program the number, see the Programming chapter.

Release calls

If you have an M7100 Telephone, this is displayed when you try to reply to a message while on an active call. You must release your call before entering your Message Waiting List.

Their list full

You are trying to send a message to a telephone whose message waiting list is full.

Your list full

You have tried to send a message but your telephone's list of sent messages is full. Cancel one of the messages you have sent, if possible, or wait until you have received a reply to one of those messages.

Notes

You can send up to four messages to different telephones, including your Voice Message Center. If your telephone is a Direct-Dial telephone, you can send up to 30 messages.

You can receive up to four messages from different telephones, including your Voice Message Center. The single message from your Voice Message Center may pertain to several voice messages.

Any message can be canceled either by the person who sent it or by the person who received it.

If your reply to a message is forwarded or is answered at another telephone using the Call Pickup feature, the message remains on your telephone until you cancel it or successfully contact the telephone that sent the message.

Norstar Telephones

This section covers the basic features of your Norstar telephone and optional equipment that may be attached to it.

Buttons

Feature button

Feature

You use the Feature button to invoke Norstar features. See the Using Norstar features section.

Hold button

Hold

You use the Hold button to put calls on hold. See the Hold section. It is also used in place of the OK display button on telephones with one-line displays.

Memory buttons

Memory buttons are the buttons with indicators on the M7208, M7310, and M7324 Telephones, and the dual buttons without indicators on the M7310 Telephone. There is also a single memory button, without an indicator, on the M7100 Telephone. Memory buttons can be used as any of the following buttons, except that lines and Answer buttons must appear on buttons with indicators.

Answer buttons

You can use an Answer button to monitor calls on another person's telephone. All calls to the monitored telephone appear on the Answer button. Such calls may also ring at the telephone with the Answer button, depending on how the system is configured. Answer buttons are most useful for a secretary who monitors incoming calls for one or several managers.

If more than one call is ringing at the manager's telephone, the first call appears on the secretary's Answer button. Any subsequent calls appear on Intercom buttons if they are available.

More than one secretary may have an Answer button for a single manager. This allows two or more secretaries to handle calls for a busy manager.

Similarly, one person can handle calls for up to four other people, using separate Answer buttons for each person.

A secretary's telephone should have a memory button with an indicator programmed as the Internal Autodial button for the manager's telephone. This allows the secretary to call the manager and to deal efficiently with incoming calls.

You cannot make calls using Answer buttons.

Answer buttons are set up by your Customer Service representative.

Autodial buttons

Autodial buttons let you dial numbers by pressing a single button. See the Autodial section.

Line buttons

You have one line button for each line assigned to your telephone. You press the line button to select the line you want to answer or use to make a call. Having several line buttons allows you immediate access to more than one line so you can handle and monitor calls easily. The M7100 Telephone does not have line buttons and can have a maximum of two lines. You can switch between its two lines, one active and one on hold, by pressing .

Line buttons are set up by your Customer Service representative.

Programmed Feature Buttons

Programmed feature buttons allow you to invoke Norstar features by pressing a single button. See the Feature programming section.

Release button



Pressing **Rls** ends a call. You do not have to put the receiver down. **Rls** also ends feature programming.

While you are on a call, do not press **Rls** to end a feature you are using (such as Show Message). If you do, you will disconnect the call. Use **Feature** instead.

Volume bar



The volume bar controls the volume of the receiver, telephone ring, Handsfree speaker, headset and background music. Press either end of the volume bar (**←**  **→**) to adjust the volume.

Headset

A headset lets you keep both hands free while you are on a call without others overhearing your telephone conversations.

If you plug a headset into your telephone while you are on a call, your telephone's microphone and speaker (or your receiver if you are on a regular call) are turned off and your headset microphone and earpiece are turned on.

You must have the Handsfree/Mute feature assigned to your telephone if you wish to use a headset.

While you are using the headset, the receiver and the switch in the telephone cradle do not work.

A headset cannot be used on an M7100 Telephone.

Using a headset

While on a call using the headset, press **Handsfree Mute** to turn your headset on and off.

To answer a call, press **Handsfree Mute**.

To adjust the volume, press the appropriate side of the volume bar (**←**  **→**).

To change to a Handsfree call while you are on a call using your headset, unplug your headset. Your telephone's microphone and speaker turn on and the call becomes a Handsfree call. (It is a good idea to put the call on hold while you do this.)

You may see this prompt when you try to use a headset.

Need Handsfree

You are attempting to use a headset, but Handsfree/Mute is not programmed for your telephone. If you are not using a headset, you have accidentally plugged your telephone receiver into the headset jack on the bottom of the telephone.

Hearing aid compatibility

The receivers on all Norstar telephones are compatible with hearing aids as defined in the FCC rules, Part 68, section 68.316.

Note: Not all hearing aids are optimized for use with a telephone.

Wall mounting

Most Norstar telephones can be mounted on a wall. Contact your Customer Service representative if you wish to have any telephones in your system wall-mounted.

Page

 Feature

Make a page announcement

You can make announcements over the Norstar system. The tone preceding a page announcement up to now was always on. Now it is possible to turn the page tone off for all users in Configuration programming. This is convenient if the office environment is often busy with Page Announcements.

1. Press .
2. Choose a page type.
3. If necessary, choose a zone.
4. Make your announcement.
5. Press .

Page types are :

- through the telephone speakers (Internal Page)
- through an external speaker (External Page)
- both Internal and External (Combined Page)

Paging shortcuts

Instead of entering the Page feature code followed by the page type, you can enter the following shortcut codes.

Internal and zone (0 to 3)

External (code 2 has no zones)

Combined and zone (0 to 3)

Related features

Voice Call

 Feature

You can make an announcement to one person by placing a voice call to their telephone.

Displays

You will see some of these displays while making a Page announcement.

Denied in admin

Your telephone has not been programmed to allow paging.

Enter zone:
ALL

Enter the desired zone number (0-3) or press **ALL** to page to all zones. (0 equals all zones.)

Invalid zone

You have entered a page zone code that is not between 0 and 3.

Page choice:
SETS SPKR BOTH

Select the type of page you want by pressing:

- or **SETS** — Internal Page
- or **SPKR** — External Page
- or **BOTH** — Combined Page

Page timeout

The time allotted for paging has expired.

Paging ALL

The prompt appears while you are paging and shows the page zone you have chosen. Press **Feature** or **Ris** when you are finished paging.

Paging busy

A page is already being made in the page zone you have requested.

Notes

Page zone 0 equals all zones.

When making an announcement using External Page or Combined Page, the Long Tones feature is automatically activated for the external paging system only. This allows you to control optional equipment with the Long Tones feature.

Each Norstar telephone can be assigned access to Paging and is assigned to one of three page zones, or to none, in Administration programming.

Make sure that everyone who needs to make page announcements has a list showing who is in each page zone. See the Programming reminders section in the Programming chapter.

Priority Call

Feature

If you get a busy signal when you call someone in your office, you can interrupt them. If the Do Not Disturb feature is on at the telephone of the person that you are trying to reach and that telephone is idle, you can override Do Not Disturb. Use this feature for urgent calls only.

1. Press .
2. Wait for a connection, then speak.

A person who receives a Priority Call while on another call has eight seconds to accept or reject the call. If the person does nothing, the Priority Call feature puts the active call on Exclusive Hold and connects your call.

Displays

You will see some of these displays while making a Priority Call.

Call blocked

You tried to place a Priority Call to another Norstar telephone. The person you called has blocked your call. Try to call later.

Denied in admin

You have tried to make a Priority Call, but this feature has not been assigned to your telephone.

Make call first

You have attempted to use the Priority Call feature with no ringing or busy tone on the line. Use Priority Call only when you hear ringing or a busy signal.

Please wait

The party you are calling has eight seconds to decide whether to accept or reject your Priority Call.

Priority denied

The telephone you are calling is already in a Priority Call or is unable to receive Priority Calls.

Notes

You can make a Priority Call only while your telephone display shows one of the following prompts:

Do not disturb
PRIORITY LATER

On another call
PRIORITY LATER

Calling 21
PRIORITY LATER

21 busy
PRIORITY LATER

If Call Forward is active at the telephone you are trying to reach, your call will be forwarded.

If the telephone receiving the Priority Call is in a conference call, the other two parties are automatically put on hold when the Priority Call is accepted.

Permission to make Priority Calls from a telephone is given in Administration programming.

Service Modes

 Feature # 8 7

Switch to a Service Mode

You can use Service Modes to make your Norstar system behave differently at different times of day. For instance, all incoming external calls can be directed to a security guard's telephone during the night, or calls to one receptionist can be directed to another receptionist during lunch.

You can activate a manual Service Mode or override an automatic Service Mode.

1. Press Feature # 8 7 on a Control telephone. (See Special telephones for information on Control telephones.)
2. Select the Service Mode you want.

Cancel Service Modes

 Feature # 8 7

You can return to normal operation or cancel the manual override of an automatic mode. You cannot cancel an automatic mode.

1. Press Feature # 8 7.

Displays

You will see some of the following displays when selecting a Service Mode.

Night Service
 QUIT OK NEXT

The name of the current Service Mode ("Night Service", in this case) is displayed. Press or **NEXT** to see other Service Mode options. Press Hold or **OK** to select the desired mode.

Denied in admin

You are trying to activate a Service Mode from a telephone that is not a Control telephone or Direct-Dial telephone, or else all Service Modes are disabled in Administration programming.

Notes

A Service Mode allows you to change which lines ring at which telephone, to activate or deactivate the auxiliary ringer for certain lines, and to have calls to the Direct-Dial telephone ring at the Extra-Dial telephone. Service Modes can be programmed to begin automatically at certain times or they can be turned on and off at the Control telephone. Service Modes are set up in Administration programming.

Automatic Service Modes are indicated by an asterisk (*) before the name of the Service Mode on the display. You can neither manually activate nor cancel automatic Service Modes, although you can override them with manual modes.

The Control telephone can override automatic Service Modes at any time by entering the Service Modes feature code (Feature), and selecting a different Service Mode; this override will remain in effect until it is canceled by means of . Note that if you selected a Service Mode with an asterisk (*), the next automatic Service Mode will come into effect at the programmed time.

Calls to a Direct-Dial telephone will ring at the Extra-Dial telephone (designated in Administration programming) only when the Service Modes feature code (Feature) is entered at that Direct-Dial telephone. Note that only the Extra-Dial telephone will be activated, not the actual Service Mode (unless that Direct-Dial telephone is also a Control telephone).

Norstar provides three Service Modes named "Night", "Evening", and "Lunch". You can change these names to suit yourself. In addition, there is normal service when no Service Modes are active.

Special Telephones

You can assign several special functions to the telephones in your Norstar system. Except where noted, you do not need special hardware. A special function is assigned to a telephone either by your Customer Service representative in Configuration programming or by you in Administration programming.

Control telephone

The Control telephone lets you place the external lines for which it has responsibility into and out of Service Modes. See Service Modes.

Direct-Dial telephone

You can dial a Direct-Dial telephone with a single digit. The Direct-Dial telephone is usually in a central location, such as a receptionist's or secretary's desk. It is usually a Prime telephone with a Central Answering Position (CAP) module.

There may be none or one Direct-Dial telephone in your system. Each telephone in the system can be assigned to the Direct-Dial telephone. There is a single Direct-Dial digit for the whole system that lets each assigned telephone call the Direct-Dial telephone.

Each Norstar Direct-Dial telephone can send up to 30 messages and each can invoke Service Modes to activate the Extra-Dial telephone. (It cannot activate the entire Service Mode unless it is also the Control telephone.)

Your Customer Service representative programs the Direct-Dial digit in Configuration programming. The Direct-Dial telephone is identified and assigned to telephones in Administration programming.

Extra-Dial telephone

In Service Modes, a second telephone can be assigned to ring on calls made to the Direct-Dial telephone. There may be one Extra-Dial telephone for the Direct-Dial telephone, and it may be a different telephone in each Service Mode.

Hotline telephone

You can call a programmed internal or external telephone number simply by picking up the receiver of the Hotline telephone (or by pressing ).

A Hotline telephone can be set up to dial an operator or an emergency number. You should put a notice by the Hotline telephone to let people know which number will be dialed when they lift the receiver.

If the Hotline telephone is set up to dial an external number using the Prime line, there must be an external Prime line assigned to the telephone. If not, the Hotline call will fail.

The Hotline telephone, the telephone number it dials, and the line on which that number is dialed, are set up in Administration programming.

To bypass a Hotline

Press a line button, or use the Pre-Dial or Automatic Dial feature before you pick up the receiver or press .

The following displays may occur at a Hotline telephone.

 Line in use

The line assigned to the Hotline is in use. Make the call using normal methods or wait until the Hotline line is free.

No line selected

The Hotline has been set up to dial an external number on a Prime line but the Hotline telephone does not have a Prime line. This must be corrected in Configuration or Administration programming.

No free lines

The Hotline has been set up to dial an external number on a Prime line but the Hotline telephone has an internal Prime line and no access to line pools. This must be corrected in Configuration or Administration programming. This message may also appear if the line pool assigned to the telephone is busy.

Prime telephone

Each line in a Norstar system can have a telephone assigned to it as a Prime telephone. Calls not answered at their normal destinations are transferred to the Prime telephone. The Prime telephone is usually the telephone on the receptionist's desk and it is often the Control telephone. The Prime telephone often has a Central Answering Position module attached to it as well. A Prime telephone is assigned to a line in Configuration programming.

See the Answering the telephone section for the displays that may occur at a Prime telephone.

Speed Dial

Feature 0

Make a Speed Dial call

You can quickly dial external telephone numbers that have been programmed onto Speed Dial codes.

1. Press Feature 0.
2. Enter the appropriate two-digit Speed Dial code.

Norstar supports two types of Speed Dial codes, Personal and System. System Speed Dial codes are from 01 to 70. You can assign numbers to System Speed Dial codes for the entire system in Administration programming. Personal Speed Dial codes are from 71 to 94 and may have different numbers assigned to them on each telephone. Users can program their own Personal Speed Dial numbers.

Program Personal Speed Dial

Feature * 4

You can add or change a Personal Speed Dial number on your telephone.

1. Press Feature * 4.
2. Enter the code that you want to associate with a telephone number.
3. If you want to include a line selection for this number, select the line or line pool button. For the M7100 Telephone, you can select a line pool button only.
4. Enter the number you want to program.
5. Press OK or Hold .

Displays

You will see some of these prompts while using or programming Speed Dial.

9.
QUIT BKSP OK

Continue entering the number you wish to program. You can change the number by pressing the left side of the volume bar or by pressing **BKSP**. When you are finished, press **Hold** or **OK**.

Access denied

You have tried to program a Personal Speed Dial number while someone else on the system is in Configuration or Administration programming.

Autodial full

You have tried to enter a new Personal Speed Dial Number, but the memory for these numbers in your Norstar system is full.

Enter code:

Enter a two-digit code between 71 and 94 for the Personal Speed Dial number you want to program.

Enter digits
QUIT OK

Enter the telephone number you wish to program exactly as you would if you were dialing it normally. When you are finished, press **Hold** or **OK**.

Invalid code

You have entered a code outside the code range (01-94).

Line in use

The line associated with the Speed Dial number you are trying to use is busy.

No number stored

There is no number stored on the Speed Dial code you have dialed.

Program and HOLD

This display pertains only to the M7208 Telephone. If you want to program a line or line pool selection for this Speed Dial, select the line or line pool button. Otherwise, enter the telephone number you wish to program exactly as you would if you were dialing it normally. When you are finished, press .

Program and OK
QUIT OK

If you want to program a line or line pool selection for this Speed Dial, select the line or line pool button. Otherwise, enter the telephone number you wish to program exactly as you would if you were dialing it normally. When you are finished, press or **OK**.

Select a line

There is no line associated with the Speed Dial number you are trying to use. Select a free external line or line pool and enter the Speed Dial feature code again.

Speed dial>

Enter a two-digit Speed Dial code (01-94). You must enter the zero for codes 01 to 09.

Notes

There is no difference between using Personal Speed Dial and using System Speed Dial. They differ only in how you program them.

Speed Dial numbers may include line choices and Host System Signaling codes.

Speed Dial numbers are subject to the same Class of Service as regularly dialed numbers. System Speed Dial numbers can be programmed to bypass dialing restrictions.

Normally, Speed Dial numbers are shown on the display while they are being dialed. System Speed Dial numbers may be programmed to show a Speed Dial name instead of the number, keeping the actual number confidential.

System features

The following system features are available for the entire Norstar system, with the exception of **Disconnect Supervision**. The availability of Disconnect Supervision is dependent on the presence of an Open Switch Interval (OSI) message.

Accidental Disconnect Protection

If you accidentally drop the receiver back into the telephone cradle while answering a call, you can quickly retrieve the call.

1. Pick up the receiver again or press . You are connected to your call.

Automatic telephone relocation

If Automatic telephone relocation is enabled, you can move your telephone from one Norstar jack to another without it losing any of its custom programming. Your Customer Service representative enables Automatic telephone relocation in Configuration programming.

Background Music

You can listen to music through your telephone speaker.

1. Press .

WARNING

In accordance with U.S. copyright law, a license may be required from the American Society of Composers, Authors and Publishers or a similar organization if radio or TV broadcasts are transmitted through the Background Music feature of this telecommunication system.

Northern Telecom Inc. hereby disclaims any liability arising out of the failure to obtain such a license.

The music stops automatically if you make or answer a call.

Your Customer Service representative makes this feature available to all telephones in Configuration programming. You will need to supply a music source, such as a radio, attached to your KSU.

Cancel Background Music

Feature # 8 6

You can cancel Background Music.

1. Press # 8 6.

Class of Service

The Class of Service for a call consists of all the Norstar features and lines available to you for that call. This is determined by the features assigned to the telephone in Administration programming, including all Dialing Filters.

Users who need to dial numbers not permitted by the Class of Service of the line or telephone that they are using, can switch to a different Class of Service by entering a Class of Service Password.

Internal numbers

Each telephone in the Norstar system has its own internal number. The length of internal numbers in your system is 2 digits. Your Customer Service representative assigns internal numbers in Configuration programming.

To find out your internal number, use the Button Inquiry feature (* 0) on an internal line button. On the M7100 Telephone, Button Inquiry shows your internal number followed by the function assigned to your single memory button.

Lines

The following features and characteristics are associated with the use of lines.

Disconnect Supervision

Disconnect Supervision is available when an Open Switch Interval (OSI) message is provided on a line by the public telephone system.

If Disconnect Supervision is available, your Customer Service representative assigns Disconnect Supervision to lines in Configuration programming. When Disconnect Supervision is assigned to a line, the Norstar system monitors the length of the OSI on that line to determine when an external caller hangs up. This allows the system to release the line for other uses.

You can determine if a line is disconnect supervised by referring to the *3X8 DR5.1 Programming Record*.

Line appearance

Any of the lines in your system may appear at any of your telephones. Your Customer Service representative assigns lines to telephones in Configuration programming.

Usually, only the lines that are appropriate for a particular person appear at that person's telephone. When a line is assigned to a telephone it is automatically given a line button on that telephone, if a button is available. The M7100 Telephone has no line buttons for its lines.

Normally, you cannot answer a call that is ringing on a line that does not appear on your telephone. To pick up such a call, use Call Pickup, Call Park, or Transfer.

Hung lines

A line that has been redirected using Line Redirection may remain busy after a call is over. If this happens, the outgoing line for the redirection will also remain busy. These are hung lines and you must clear them.

A line indicator that has been solid for a long time is the only real indication that a line is hung. However, the solid line indicator may also indicate a genuine call in progress. Make reasonably sure that the line is indeed hung before clearing it or you may cut off a real conversation.

You can clear a hung line only at the telephone that was used to redirect the line.

1. Press **Feature** ***** **0** at the telephone that was used to redirect the line.
2. Press the button of the redirected line.
3. Press **SHOW** or **#**.
4. Press **DROP** or *****. The hung line is cleared.

Clearing the redirected line clears the outgoing line for the redirection as well.

Line Pools

A line pool allows each telephone access to external lines from a group (or "pool") of external lines. You can access such lines by pressing an Intercom button and entering a line pool access code, by entering the feature code and entering a line pool access code, or by pressing a memory button programmed with the line pool feature code and a line pool access code.

Your Customer Service representative gives telephones access to Line Pools and assigns line pool access codes in Configuration programming.

Private lines

A Private line is exclusive to a particular telephone. Calls that are put on hold or left unanswered on a Private line cannot be picked up at any telephone except the Prime telephone.

Your Customer Service representative assigns private lines in Configuration programming.

Prime line

Your telephone can be programmed to select an internal or external line or a line pool automatically whenever you lift the receiver or press . This is your Prime line.

Your Customer Service representative assigns your prime line in Configuration programming.

Ringling Line Preference

Each telephone in the Norstar system can be programmed by your Customer Service representative to ring or remain silent for incoming calls on any external lines that appear on the telephone.

For example, a telephone may have buttons assigned for lines 01 to 03, but have only lines 01 and 02 programmed to ring. An incoming call on any of the three lines causes a line button indicator to flash, and the telephone can be used to answer the call. This is especially useful for people who monitor other telephone lines, but want only their own lines to actually ring.

If a telephone has an external line as a Prime line, that line is usually made to ring.

System Speed Dial

Speed Dial codes 01 to 70 are the same for the entire system. See the Speed Dial section for details.

Time features

The Time features let you check the present time and how long you have spent on a call.

Call Duration Timer

Feature

You can see how long you spent on your last call or how long you have been on your present call.

1. Press .
2. Read the display.

Show Time

Feature

You can see the present date and time while you are on a call.

1. Press .
2. Read the display.

Displays

One of the following displays will occur when you use a Time feature.

Make call first

You have not made a call since your telephone's clock was last reset.

21 02:47

The display shows the last call you made, or the current call, and the total elapsed time in minutes and seconds.

Apr 9 9:54 am

The display shows the present time.

Transfer

Feature 7 0

Transfer a call

You can transfer a call to a telephone in your Norstar system or external to Norstar.

1. Make a call, answer a call or take a call off hold.
2. Press Feature 7 0 or **TRANSFER** (or Transfer if programmed).
3. To transfer within the Norstar system: dial an internal telephone number or press an Internal Autodial button.
OR
To transfer external to Norstar: press a line button and dial the number of the person to whom you want to transfer the call, or press an External Autodial button.
4. Announce the call after the called party answers and complete the transfer as follows.
OR
If you do not want to announce the call, complete the transfer as follows.
5. Press **Rls** or **JOIN** , or a programmed Call Queuing button if you wish to answer another call.
6. The call is immediately transferred.

Note: When transferring an external call to an external number, note the following restrictions: at least one of the external calls must have been an incoming call, and that call must be on a disconnect supervised line.

Unsupervised Conference

You can create an Unsupervised Conference by dropping out of a conference you established, leaving the other two to talk to each other. If both parties are external, certain restrictions apply. See Notes at the end of this section.

1. Establish a Conference call as described in Conference.
2. Press or **TRANSFER** (or if programmed).

If you are unable to establish an unsupervised conference, you can put the conference on hold. See the Conference section.

Transfer using Hold

Transfer using Hold can only be used to transfer an external call to another internal telephone that has a button for the line that the external call is on.

Call the person you want to transfer the call to and tell them there is a call on hold for them. **Do not enter the Transfer feature code.** To accept the call, your co-worker presses the line button with the flashing indicator.

An M7100 Telephone can transfer a call using Hold but it cannot receive a call transferred in this way.

Displays

You will see some of the following displays while transferring calls.

21 busy CANCL RETRY

The telephone of the person to whom you tried to transfer a call already has the maximum number of calls that it can handle. Press **RETRY** to enter a new internal number. On the M7100 telephone, you will automatically be returned to the **Transfer to:** prompt.

21 DND
CALLBACK

The person to whom you transferred an external call has Do Not Disturb active on their telephone. Press **CALLBACK** or the flashing line button to reconnect to the call. On the M7100 Telephone, lift the receiver.

21 hung up

The internal caller you were trying to transfer hung up before the transfer was complete.

23 hung up
CANCL RETRY

The internal user to whom you were trying to transfer the call hung up before the transfer was complete.

21 no reply
CALLBACK

The person to whom you transferred an external call did not answer. Press **CALLBACK** or the flashing line button to reconnect to the call. On the M7100 Telephone, lift the receiver.

21>22
CANCL RETRY JOIN

Press **RETRY** if, after talking to the person at internal number 21, you decide to transfer the call to someone else. Press **Fls** or **JOIN** to transfer the call from internal number 21 to 22.

Call transferred

Transient message to indicate that the transfer was successfully completed.

Do not disturb
CANCL RETRY JOIN

The person to whom you tried to transfer an internal call has Do Not Disturb active on their telephone. Press **CANCL** or the flashing line button to reconnect to the call. On the M7100 Telephone, enter the transfer cancellation code (**Feature** **#** **7** **0**) to reconnect to the call.

Invalid number
CANCL RETRY

An invalid DN has been entered, or the transfer feature has been invoked before the complete DN has been entered.

Line 01 hung up

The external caller you were trying to transfer has hung up before the transfer was complete.

Line 01>21
CANCL RETRY JOIN

Press JOIN to transfer the call on line 01 to telephone 21. Press RETRY if, after talking to the person at internal number 21, you decide to transfer the call to someone else.

Make call first

You have tried to use the Transfer feature when you have no call to transfer.

Not in service
CANCL RETRY

The telephone to which you are trying to transfer a call is out of service.

On another call
CANCL RETRY JOIN

The person to whom you tried to transfer a call is on another call. Press RETRY to enter a new internal number. Press RLS or JOIN to complete the transfer.

Restricted call
CANCL RETRY

You cannot transfer the call because of telephone or line restrictions.

Still in transfer
CANCL RETRY

Once you have invoked the Transfer feature you must complete the transfer actions before you can access a new feature, answer another alerting call or select an outgoing line.

Transfer denied
CANCL RETRY

Your transfer cannot be completed for one of these reasons:

- All the internal resources needed to perform a transfer are in use. Try again later.
- You have tried to transfer an external call to another external party. Some restrictions apply. See Notes at the end of this section.
- An Unsupervised Conference is not possible for your call. See Notes at the end of this section.

Transfer to:
CANCL

Dial the internal telephone number of the person to whom you want to transfer the call. If you are already connected to that person, press the line button of their call.

Notes

If an external call is transferred to a busy telephone, or not answered after a few rings, the call automatically rings you back and the display indicates that the telephone was busy or that no one answered. Callback doesn't apply when an external call is transferred to an external number.

You can establish an Unsupervised Conference whether the other two people are inside or outside the Norstar system. However, if both of the other people are outside the system there are some restrictions: at least one of the outside callers must have called you and that call must be on a disconnect supervised line.

When transferring an external call to an external number, note the following restrictions: at least one of the external calls must have been an incoming call, and that call must be on a disconnect supervised line.

In certain situations, you may experience lower volume levels when using external Transfer and Unsupervised Conference with two external calls.

Voice Call

Feature 6 6

Make a voice call

You can make an announcement or begin a conversation through the speaker of another telephone in the system.

1. Press Feature 6 6.

Mute Voice Call tones

When a Voice Call begins at your telephone, you hear a beep every 15 seconds as a reminder that the microphone is on. You can stop it beeping.

1. Pick up the receiver or press Handsfree Mute .

Handsfree Answerback

If Handsfree Answerback is assigned to your telephone, you can respond to a Voice Call without touching the telephone.

1. When someone makes a Voice Call to you, simply start talking. Your telephone's microphone picks up your voice.

Your telephone will beep periodically to remind you the microphone is on. You can stop it beeping.

1. Pick up the receiver or press Handsfree Mute .

Voice Call Deny

Feature 8 8

You can prevent your telephone from receiving Voice Calls.

1. Press Feature 8 8. Voice Calls will ring like regular internal calls. Your other calls will proceed normally.

Cancel Voice Call Deny

Feature # 8 8

You can cancel Voice Call Deny.

1. Press Feature # 8 8.

Displays

You will see some of these displays while making a Voice Call.

Dial voice call

Dial the internal number or press the internal Autodial button of the person to whom you want to speak.

No voice call

The telephone receiving the call cannot accept Voice Calls for one of the following reasons: it is active or ringing with another call; it is in Call Forward mode; it is in Do Not Disturb mode; it has Voice Call Deny turned on; it is not a Norstar telephone.

Your call proceeds automatically as a regular ringing call.

Voice call

The line is open for you to speak.

Notes

Once you have answered a Voice Call, you can put it on hold, transfer it, or otherwise treat it as a normal call.

When you have Handsfree Answerback assigned to your telephone, and you are using an on-hook Dialing Mode, the microphone and speaker are both activated for external calls.

Handsfree Answerback is assigned to a telephone in Administration programming. You can not assign Handsfree Answerback capability to the M7100 Telephone.

If you do not have Handsfree Answerback assigned to your telephone, you can answer a Voice Call by picking up the receiver.

User cards

This chapter includes reproductions of the *3X8 DR5.1 Telephone Feature Card* and the *Norstar Telephone User Cards*. To best assist your co-workers, you should use these cards to familiarize yourself with general Norstar feature operation and with the specific operation of each Norstar Telephone model.

Using Norstar features

Using a Norstar* feature

1. Press **[Feature]**, and enter the desired feature code on the dial pad.
OR
Press the programmed memory button.
2. Follow the display messages.

Note: On M7310 and M7324 Telephones, some features are also available on the display buttons.

Programming a Norstar feature on a memory button

1. From an idle telephone, or with your calls on hold, press **[Feature]** **[*]** **[5]**.
2. Press the memory button that you want to program. (This step is not required on the M7100 Telephone.) See your telephone user card for the location of the memory buttons.
3. Enter the feature code you want to program.

Personalizing your telephone

Autobumping

[Feature] **[8]** **[1]** **[5]**

Allows the oldest log entry to be deleted from a full Call Log when a new item is logged, so that the new log entry can be stored. For more information, see Call Log.

Cancel **[Feature]** **[#]** **[8]** **[1]** **[5]**

Background Music

[Feature] **[8]** **[6]**

Allows you to listen to music (provided by your office) through your telephone speaker when you are not on a call.

Cancel **[Feature]** **[#]** **[8]** **[6]**

Button Inquiry

[Feature] **[*]** **[0]**

Checks what is programmed on any button. Use this feature when labeling memory buttons.

Call Log Password

[Feature] **[*]** **[8]** **[5]**

Programs a password for your Call Log. If you forget your password, see the person who administers your system.

Class of Service Password

[Feature] **[8]** **[8]**

Overrides the Class of Service on a telephone to allow you to make a call from that telephone. The Class of Service determines which numbers you can dial. Switch from one Class of Service to another using this feature code and a password provided by the person who administers your system.

Contrast Adjustment

[Feature] **[*]** **[7]**

Adjusts the contrast of your telephone display. Press **[1]** through **[9]** (depending on your telephone).

Dialing Modes

[Feature] **[*]** **[8]** **[2]**

Changes the on-hook Dialing Modes. The three Dialing Modes are:

Automatic Dial: If you have a Prime line, dial a telephone number without pressing a line button. A line is selected automatically.

Pre-Dial: Dial a telephone number. Edit it by pressing **BACKSP.**, or the left side of **[#]** **[0]**. Press a line button or a line pool button to place the call.

Standard Dial: Select a line, then dial a telephone number.

Do Not Disturb

[Feature] **[8]** **[5]**

Prevents incoming calls from ringing at your telephone.

Cancel **[Feature]** **[#]** **[8]** **[5]**

* Meridian and Norstar are trademarks of Northern Telecom.

186 / 3X8 Telephone Feature Card

Language Choice	Feature <input type="text"/> * <input type="text"/> 5 <input type="text"/> 0 <input type="text"/> 1	Selects the English language for the telephone display.
	Feature <input type="text"/> * <input type="text"/> 5 <input type="text"/> 0 <input type="text"/> 2	Selects the alternate language for the telephone display.
Moving Line Buttons	Feature <input type="text"/> * <input type="text"/> 6 <input type="text"/> 1	Changes the position of a line button. Remember to switch the button caps after the line button is moved. Lines cannot be moved to positions occupied by <input type="text"/> Intercom <input type="text"/> , <input type="text"/> Handsfree <input type="text"/> <input type="text"/> , or <input type="text"/> Answer <input type="text"/> buttons. This feature is not available on the M7100 Telephone.
Programming Call Log	Feature <input type="text"/> * <input type="text"/> 6 <input type="text"/> 4	Select the type of calls that will be automatically stored in your Call Log.
Programming memory buttons	Feature <input type="text"/> * <input type="text"/> 1	External Autodial: Stores a line (optional) or a line pool (optional) and an external telephone number onto a memory button for one-button access to that number.
	Feature <input type="text"/> * <input type="text"/> 2	Internal Autodial: Stores an internal telephone number onto a memory button for one-button access to that telephone number.
	Feature <input type="text"/> * <input type="text"/> 3	Program Features: Stores a feature onto a memory button for one-button access to that feature.
Note: <input type="text"/> Line <input type="text"/> , <input type="text"/> Intercom <input type="text"/> , <input type="text"/> Answer <input type="text"/> , or <input type="text"/> Handsfree <input type="text"/> <input type="text"/> cannot be programmed.		
Programming a feature button:		
<ol style="list-style-type: none">1. Press Feature <input type="text"/> * <input type="text"/> 3 . (For M7100 Telephones, go to step 3.)2. Press the memory button you want to program.3. Enter the feature code of the feature you want to program.4. If you entered the Line Pool feature code in step 3, enter the access code for a line pool immediately following the feature code.		
Ring Type	Feature <input type="text"/> * <input type="text"/> 6	Selects a distinctive ring to help differentiate between your telephone and others nearby. Enter the feature code and press NEXT or <input type="text"/> 1 through <input type="text"/> 4 to select the new Ring Type. Press <input type="text"/> Hold <input type="text"/> or OK to store the new ring.
Ring Volume	Feature <input type="text"/> * <input type="text"/> 6 <input type="text"/> 0	Makes your telephone ring so you can adjust the volume, even while you are on a call.
Run/Stop	Feature <input type="text"/> * <input type="text"/> 6	When using the External Autodial programming feature, inserts a break point between two or more numbers stored on a memory button. Press the memory button once to dial the first number; a second time to dial the second number, and so on.

Speed Dial **Feature** * **Personal:** Programs a telephone number into a Personal Speed Dial code (from 71 to 94).

Programming a Personal Speed Dial code:

1. Press **Feature** * to enter Personal Speed Dial codes.
2. Enter a two-digit code (from 71 to 94).
3. To program a line as part of the Speed Dial code, press a line button or a line pool button.
4. Enter the telephone number to be assigned to that code. Telephone numbers cannot exceed 24 digits.
5. Press **Hold** or **OK** to finish programming.

Voice Call Deny **Feature** Prevents your telephone from receiving Voice Calls, permits only ordinary ringing calls.
Cancel **Feature** *

Remote system signaling

Link **Feature** Generates a Link signal (also called flash or recall) on an active line to access other systems or carriers.

Long Tones **Feature** Permits communication with devices (such as fax or answering machines) on an active line that use longer tone signals. The tone lasts as long as a dial pad button is held down, and only for the current call.

Pause When programmed in an External Autodial sequence, inserts a 1.5-second delay in a number being dialed.

Feature For Pulse and Tone Dialing
* For Pulse Dialing only

Programmed Release **Feature** * When programmed at the end of an External Autodial sequence, performs the same function as **RS**.

System features

Call Duration Timer Feature Briefly displays the length of your current call. If your telephone is idle, the length of your most recent call is displayed.

Call Log Feature Opens your Call Log to view stored caller information. The Call Log displays use special characters.

- ⓪ A new item in the Call Log is underlined.
- ⓪ Answered calls are identified.
- ⓪ Long distance calls are identified.
- ⓪ The displayed information has been truncated.

Note: Call Log is only available if you have subscribed to Call Display services from your local telephone company.

Calling from your Call Log:

1. Navigate to the appropriate log item, and display the number.
2. Edit the number, if required. The leading digits may need to be trimmed, or digits may need to be added for Long Distance or line pool access. See the person who administers your system if you require assistance when editing a call log number.
3. Press a line button or a line pool button.
4. Lift the receiver.

Message Feature **Reply to Message:** Review your list of external and internal display messages, and return calls.

Cancel Feature

Feature

Send Message: Leave a message on a co-worker's telephone display to call you back.

Cancel Feature

Page Feature Allows you to make announcements through either the internal or external speakers, or both. Enter the feature code, the page code (1 for internal, 2 for external, or 3 for both), and the zone (0 to 3).

Feature

External: Allows you to make announcements through your office's loudspeaker system (if connected).

Feature

External/Internal: Allows you to make announcements through both your Norstar telephone speakers and your office's loudspeaker system. Enter the feature code, and the zone (0 to 3).

Feature

Internal (Zone): Allows you to make announcements, through the Norstar telephone speakers, to a group of Norstar telephones. Enter the feature code, and the zone (0 to 3). 0 pages all zones

Service Modes Feature Activates one of up to three different telephone answering options, eliminating the need to forward all your calls. Only an assigned Control Telephone can turn on Service Modes. See the person who administers your system.

Cancel Feature

Show Time Feature Briefly displays the date and the time while you are on a call.

Handling calls

Call Forward **Feature** 4 Sends your calls to another telephone in your Norstar system.
 Cancel **Feature** 4 4
Feature 8 2 **Camp-On:** Re-routes a call to another telephone even if all its lines are busy.

Call Information **Feature** 8 1 1 Briefly displays the name, number and line name of a ringing or held call. Press 1 or **VIEW** repeatedly to cycle through the three displays of information.

Note: Names and numbers for external callers are displayed only if you have subscribed to Call Display services from your local telephone company.

Call Park **Feature** 7 4 Automatically puts a call on hold so that it can be retrieved from any telephone in your Norstar system. The display shows a retrieval code, X01 or X02. The retrieval code is made up of a programmable Call Park prefix (0 to 9), followed by a call number (01 or 02).

Intercom X 0 1 or **Call Park Retrieval:** Answers a parked call from any telephone in your Norstar system by pressing **Intercom** and entering the retrieval code. On the M7100 Telephone, enter just the retrieval code.
 X 0 2

Conference **Feature** 3 *Setting up a three person call:*

1. Make or answer the first call.
2. Put the first call on hold.
3. Make or answer the second call.
4. Press **Feature** 3 (or press **Conf/Trans** if programmed).
5. Press the line button of the first held call. (This step is not required on the M7100 Telephone.)
6. Press **Ris** to end the conference.

Splitting a conference: To speak privately to one of the callers, or to drop one call and stay connected to another, or to hold both parties as separate calls, you must first split the conference.

1. Press the line button for one of the calls. The other call is put on hold. To re-establish the conference, press **Feature** 3.

Removing yourself from the conference temporarily:

1. Press **Hold**; the other two callers can still speak to each other.

Removing yourself from the conference permanently (Unsupervised Conference †):

1. Press **Feature** 7 0 (or **Transfer** if programmed). The other two parties remain connected.

Do Not Disturb **Feature** 8 5 Blocks alerting calls at your telephone. Also blocks a Priority Call when all lines on your telephone are busy.

Exclusive Hold **Feature** 7 9 or **Temporarily suspends an external call and prevents other telephones from picking it up.**
Feature Hold **Exclusive Hold Retrieval:** Press **Line** of the held call. (Press **Hold** on the M7100 Telephone.)

† Some external lines may not support this feature. See the person who administers your system for more information.

190 / 3X8 Telephone Feature Card

Group Listening

Feature

Allows you to use both the receiver and your speaker at the same time while you are on a call. Use the Mute feature on the button to disable the telephone microphone. If you experience feedback, turn the volume down, and before hanging up, press .

Cancel

Line Redirection†

Feature

Redirects one or more lines on your telephone so that calls coming in on the line(s) are directed to one or more locations outside the Norstar system. This feature is not available on the M7100 Telephone.

Cancel

Logit

Feature

Store caller information for the current active call in your Call Log.

Note: Names and numbers for external callers are displayed only if you have subscribed to Call Display services from your local telephone company.

Privacy

Feature

When Privacy is on, other Norstar users with the same line are prevented from joining your current external call. If Privacy is off, other Norstar users with the same line can join in on your external call by pressing that line button. Enter the feature code a second time to restore the original setting.

Transfer

Feature

Sends a call to another telephone in your Norstar system or external to Norstar.

Using Transfer †

1. Make a call, answer a call or take a call off hold.
2. Press (or if programmed).
3. To transfer within the Norstar system: dial an internal telephone number or press an Internal Autodial button.

OR

To transfer external to Norstar: press a line button and dial the number of the person to whom you want to transfer the call, or press an External Autodial button.

4. Announce the call after the called party answers and complete the transfer as follows.

OR

If you do not want to announce the call, complete the transfer as follows.

5. Press or , or a programmed Call Queuing button if you wish to answer another call.
 6. The call is immediately transferred.
-

External Transfer using Unsupervised Conference †

You can also do an external transfer using Unsupervised Conference:

1. Establish a Conference call as described in Conference.
 2. Press (or if programmed). The other two parties remain connected.
-

Note: If an external call is transferred to a busy internal line, or not answered after a few rings, the call automatically rings you back and the display indicates that the line was busy or that no one answered.

† Some external lines may not support this feature. See the person who administers your system for more information.

Answering and making calls

Call Pickup	Feature <input type="text"/> 7 <input type="text"/> 6	Directed Pickup: Answers a selected telephone in your system.
	Feature <input type="text"/> 7 <input type="text"/> 5	Group Pickup: Answers a call that is ringing at another telephone in the same pickup group. The external call that has been ringing longest is answered first.
	Feature <input type="text"/> 8 <input type="text"/> 0 <input type="text"/> 0	Trunk Answer: Answers an external call that is ringing on a line that has been placed into Service Modes from any telephone in the Norstar system. This feature does not work on private lines.
Call Queuing	Feature <input type="text"/> 8 <input type="text"/> 0 <input type="text"/> 1	Answers a call when several calls arrive at the same time. The external call that has been ringing longest is answered first.
Last Number Redial	Feature <input type="text"/> 5	Automatically redials the last external telephone number that you dialed. This feature is available on the <input type="text"/> Last No. <input type="text"/> memory button on most telephones.
Line Pools	Feature <input type="text"/> 6 <input type="text"/> 4	Telephones can share several external lines for making outgoing calls without requiring each telephone to have a button for every line.

Using a Line Pool:

- Press Intercom and enter the access code for one of the Line Pools assigned to your telephone.
OR
If you have no free internal line, enter the feature code and then a Line Pool access code or press Line pool (if programmed).
- If you are using a line pool which connects you to the public network, dial the telephone number of the person you want to call.
OR
If you are using a line pool which automatically connects you to a system other than Norstar, follow the procedure for using that system. Ask the person who administers your system.

Note: See the person who administers your system for your Line Pool access code.

Priority Call	Feature <input type="text"/> 6 <input type="text"/> 0	Interrupts a call at another telephone, or overrides Do Not Disturb at a telephone. See the person who administers your system.
Ring Again	Feature <input type="text"/> 2	When another telephone or Line Pool within the Norstar system is busy, Ring Again signals you to call back when the telephone or Line Pool becomes available. Cancel <input type="text"/> Feature <input type="text"/> 2 <input type="text"/> 2
Saved Number Redial	Feature <input type="text"/> 6 <input type="text"/> 7	When you are active on a call, this feature stores the external telephone number of a call you have dialed. When you are not active on a call, this feature redials the number previously stored.
Speed Dial	Feature <input type="text"/> 0	Dials the number stored for a Speed Dial code. After entering the feature code, enter the two-digit System Speed Dial code (01 to 70) or the two-digit Personal Speed Dial code (71 to 94) for the number you want. For an explanation of the differences between System Speed Dial and Personal Speed Dial see the person who administers your system.
Voice Call	Feature <input type="text"/> 6 <input type="text"/> 6	Begin a conversation through the speaker of another telephone without first making the other telephone ring. To answer a Voice Call, speak, pick up the receiver, or press <input type="text"/> Handfree <input type="text"/> <input type="text"/> .

Your Norstar M7100 telephone

Release button _____
cancels active calls.

Display _____
shows the time, date, call information and guides you while using Norstar™ features.



Your Norstar M7100 telephone

Memory button _____
is programmable to store a feature or to automatically dial internal or external number.

Dial pad _____

Feature button _____
starts or ends a feature.

Volume control _____

Hold button _____

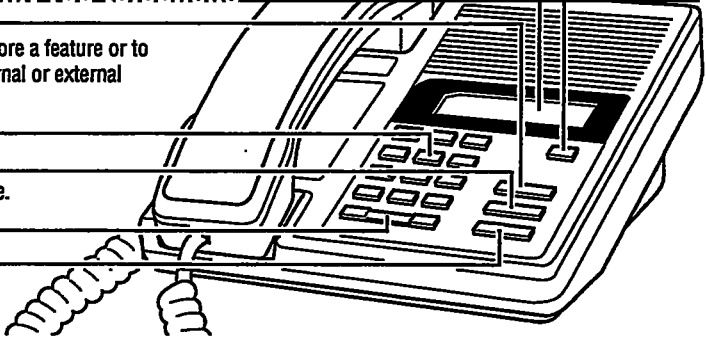

Button inquiry

Confirm that your memory button has the correct snap-on cap by checking its programming.

1. Release all calls and open lines with dial tone.
2. Press **Feature** * 0 .
3. Read the display.
4. Press **Feature** when finished.

Adjusting display contrast

1. Press **Feature** * 7 .
2. Press 1 to 9 for the level you want.

Selecting a ring type and volume

1. Press **Feature** * 8 .
2. Press 1 , 2 , 3 or 4 to hear the different types of rings.
3. While the telephone is ringing, press to adjust the volume.
4. Press **Feature** to store the ring. softer louder

Adjusting receiver or telephone speaker volume

1. Press when using the receiver or the speaker.
softer louder

Making calls

Internal calls

1. Pick up the receiver.
2. Dial the internal number.

External calls

1. Pick up the receiver.
2. Dial  (or your system's external line access code).
3. Dial the external telephone number.

Note: Internal numbers and the external access code are supplied by your System Coordinator.

Making and answering a second call

The M7100 telephone allows you to have two calls active at the same time. By using  you can switch between calls.

To answer a second call while on another call

1. Press  to put the first call on hold.
The second call automatically comes onto the line.

To hold a call and make a second call



1. Press  to put the first call on hold.
2. Dial the telephone number for the second call.

To return to the first call

1. Press  again to return to the first call on hold.
The second call is automatically put on hold.



To hold a call

1. Press .
2. Press  again to return to the call on hold.
Check the display for confirmation or additional information.

Programming the memory button

About the memory button

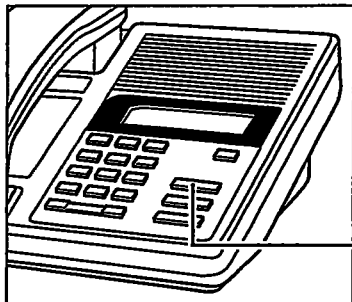

The memory button can store a telephone number or feature code to give you one touch dialing or feature activation. You can change the memory button by programming it with a new number or feature code.

Memory button

Remember: Press **Feature** ***** **0** to check the memory button.

Programming memory buttons

External autodial

1. If you are on a call or an open line with dial tone, press **Hold** or **Rls**.
2. Press **Feature** ***** **1** .
3. Dial the external number.
4. Press **Hold** to store the number.
5. Label your new button.

Internal autodial

1. If you are on a call or an open line with dial tone, press **Hold** or **Rls**.
2. Press **Feature** ***** **2** .
3. Dial the internal number.
4. Label your new button.

Features

1. If you are on a call or an open line with dial tone, press **Hold** or **Rls**.
2. Press **Feature** ***** **3** .
3. Press **Feature** and the feature code.
4. Label your new button.

Erasing memory buttons

1. If you are on a call or an open line with dial tone, press **Hold** or **Rls**.
2. Press **Feature** ***** **1** .
3. Press **Hold** to erase the button.

Your Norstar M7208 telephone

Display

shows the time, date, call information and guides you while using Norstar® features.

Indicators

appear beside active lines and features.

Feature button

starts or ends a feature.

Release button

cancels active calls.

Hold button

Dial pad

Volume control

Memory and line buttons

are buttons with indicators for one touch dialing, feature operation or line access.

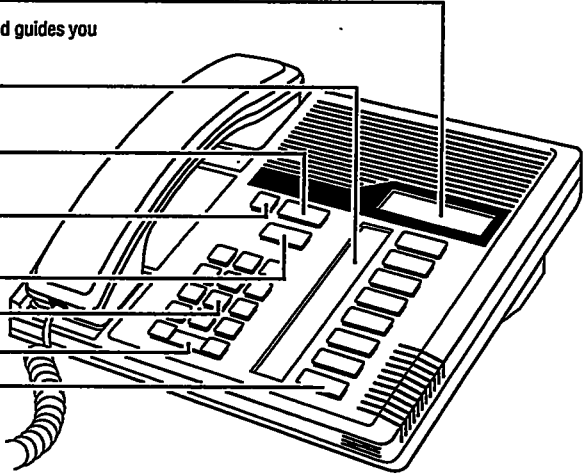

Button Inquiry

Confirm that your memory and line buttons have the correct snap-on caps by checking their programming.

1. Release all calls and open lines with dial tone.
2. Press **Feature** * **0**.
3. Press the button you want to check.
4. Read the display.
5. Press **Feature** when finished.

Adjusting display contrast

1. Press **Feature** * **7**.
2. Press a number on the dial pad for the contrast level you want, the higher the number the higher the contrast level.

Selecting a Ring Type and volume level

1. Press **Feature** * **6**.
2. Press **1**, **2**, **3** or **4** to hear the different types of rings.
3. While the telephone is ringing, press **softer** **louder** to adjust the volume.
4. Press **Feature** to store the ring.

Adjusting receiver or telephone speaker volume

1. Press **softer** **louder** when using the receiver or the speaker.

Making calls

About line buttons

Norstar systems can have different types of line buttons. Match the line buttons on your telephone with the ones below for instructions on how to use them.

Intercom

Line 1

Internal calls using Intercom buttons

1. Pick up the receiver.
2. If ► appears beside an Intercom button, then dial.
OR
Press an Intercom button without ►, then dial.

External calls using numbered Line buttons

1. Pick up the receiver.
2. When ► appears beside a numbered Line button, then dial.
OR
Press a numbered Line button without ►, then dial.

Note: Internal numbers are supplied by your System Coordinator.

4321

Internal calls using extension buttons

1. Pick up the receiver.
2. When ► appears beside an extension button, then dial.

External calls using extension buttons

1. Pick up the receiver.
2. When ► appears beside the extension button, dial [] (or your system's external line access code) and the number.

Hold

Holding Calls

1. Press [Hold] . The ► flashes beside the line on hold.
2. Press the line button with the flashing ► to return to the call.
Check the display for confirmation or additional information.

Automatic hold

Calls are put on hold automatically when you switch from one line to another.

Handsfree
Mute

This button operates the telephone's built-in microphone and speaker in place of the receiver. Your System Coordinator can program Handsfree to your telephone.

Making calls

1. Press [Handsfree Mute] instead of picking up the receiver.

Switching between Handsfree and handset

1. Press [Handsfree Mute] and replace the handset to switch to Handsfree.
2. Pick up the receiver to switch back.

Using Mute

1. Press [Handsfree Mute] to turn the microphone OFF.
2. Press [Handsfree Mute] again to turn the microphone ON.

Dialing without lifting the handset

1. Press a line button without ►, then dial your call.
2. When answered, pick up the receiver, or press [Handsfree Mute] .
3. If the call is not answered, or the line is busy, press [Ris] .

Programming memory buttons

About memory buttons

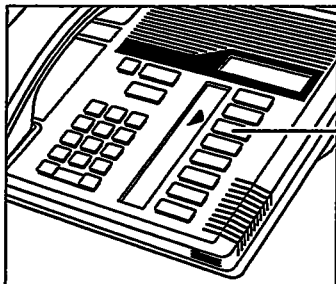

Memory buttons are the buttons with indicators other than line or Handsfree buttons. Memory buttons store telephone numbers or feature codes to give you one touch dialing or feature activation. You can change what a memory button does by just programming it with a new number or feature. You cannot program a line or Handsfree button.

Remember: Press **Feature** ***** **0** to check a memory or line button.

Programming memory buttons

External autodial

1. If you are on a call or an open line with dial tone, press **Hold** or **Rls**.
2. Press **Feature** ***** **1**.
3. Press a memory button.
4. Dial the external number.
5. Press **Hold** to store the number.
6. Label your new button.

Internal autodial

1. If you are on a call or an open line with dial tone, press **Hold** or **Rls**.
2. Press **Feature** ***** **2**.
3. Press a memory button.
4. Dial the internal number.
5. Label your new button.

Features

1. If you are on a call or an open line with dial tone, press **Hold** or **Rls**.
2. Press **Feature** ***** **3**.
3. Press a memory button.
4. Press **Feature** and the feature code.
5. Label your new button.

Erasing memory buttons

1. If you are on a call or an open line with dial tone, press **Hold** or **Rls**.
2. Press **Feature** ***** **1**.
3. Press the memory button you want to erase.
4. Press **Hold** to erase the button.

Your Norstar M7310 telephone

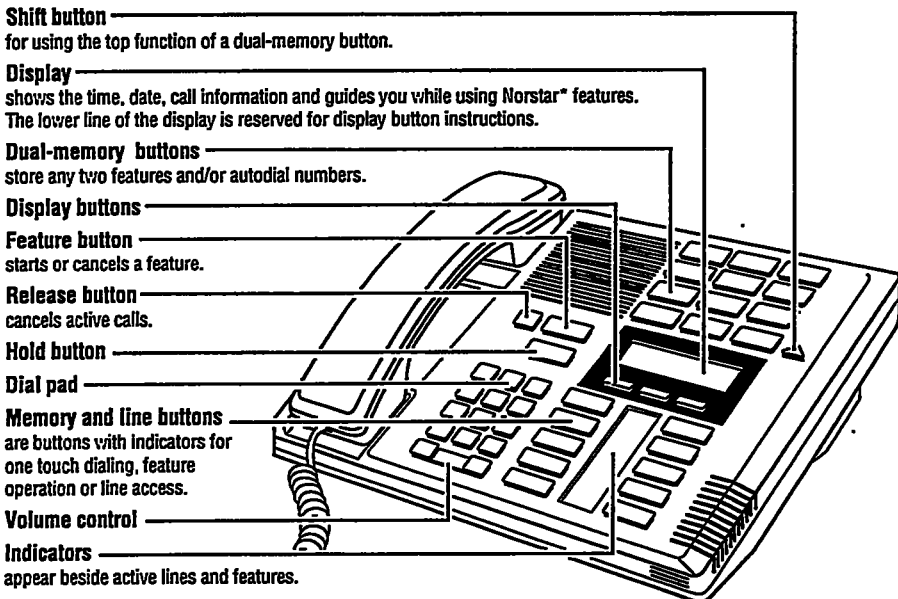

Using display buttons

Display buttons change with each feature you use. The labels for display buttons appear in capital letters directly above them on the second line of the display. A display button with an "OK" label above it is represented as **OK** in this card.

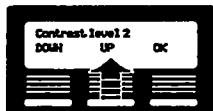

Button Inquiry

Confirm that your memory and line buttons have the correct snap-on caps by checking their programming.

1. Release all calls or open lines with dial tone.
2. Press **Feature** * **0**.
3. Press the button(s) you want to check and read the display.
4. Press **Feature** when finished.

Adjusting display contrast

1. Press **Feature** * **7**.
2. Press **UP** or **DOWN** for the level you want.
3. Press **OK** when finished.

Selecting a ring type and volume level

1. Press **Feature** * **6**.
2. Press **1**, **2**, **3** or **4** to hear the different types of rings.
3. While the telephone is ringing, press **softer** or **louder** to adjust the volume.
4. Press **OK** to store the ring.

* Meridian and Norstar are trademarks of Northern Telecom.

Making calls

About line buttons

Intercom

Line 1

Norstar systems can have different types of line buttons. Match the line buttons on your telephone with the ones below for instructions on how to use them.

Internal calls using Intercom buttons

1. Pick up the receiver.
2. If ► appears beside an Intercom button, then dial.
OR
Press an Intercom button without ►, then dial.

External calls using numbered Line buttons

1. Pick up the receiver.
2. When ► appears beside a numbered Line button, then dial.
OR
Press a numbered Line button without ►, then dial.

Note: Internal numbers are supplied by your System Coordinator.

4321

Internal calls using extension buttons

1. Pick up the receiver.
2. When ► appears beside an extension button, then dial.

External calls using extension buttons

1. Pick up the receiver.
2. When ► appears beside the extension button, then dial [] (or your system's external line access code) and the number.

Hold

Holding Calls

1. Press [Hold]. The ► flashes beside the line on hold.
2. Press the line button with the flashing ► to return to the call.
Check the display for confirmation or additional information.

Automatic hold

Calls are put on hold automatically when you switch from one line to another.

Handsfree
Mute

This button operates the telephone's built-in microphone and speaker in place of the receiver. Your System Coordinator can program Handsfree to your telephone.

Making calls

1. Press [Handsfree Mute] instead of picking up the receiver.

Switching between Handsfree and handset

1. Press [Handsfree Mute] and replace the handset to switch to Handsfree.
2. Pick up the receiver to switch back.

Using Mute

1. Press [Handsfree Mute] to turn the microphone OFF.
2. Press [Handsfree Mute] again to turn the microphone ON.

Dialing without lifting the handset

1. Press a line button without ►, then dial your call.
2. When answered, pick up the receiver, or press [Handsfree Mute].
3. If the call is not answered, or the line is busy, press [RIS].

Programming memory buttons

About memory buttons

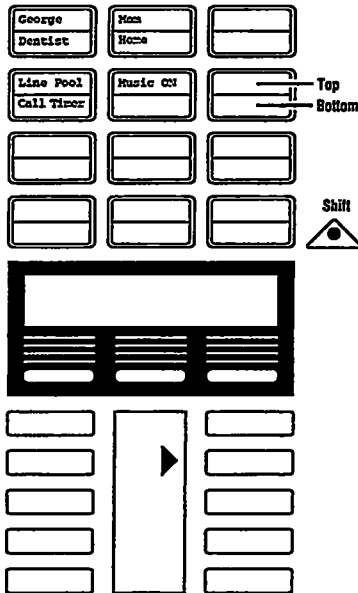

There are two types of memory buttons: single-memory and dual-memory. Memory buttons store telephone numbers or feature codes to give you one touch dialing or feature activation.

Dual-memory buttons

To use the **bottom** function, press the dual-memory button. To use the **top** function, press the shift button, then press the dual-memory button.

Single-memory buttons

Single-memory buttons are the buttons with indicators other than line or Handsfree buttons.

Remember: Press **Feature** **#** **0** to check a memory or line button.

Programming memory buttons

External autodial

1. If you are on a call or an open line with dial tone, press **Hold** or **Ris**.
2. Press **Feature** **#** **1**.
3. Press a memory button.
4. Dial the external number.
5. Press **OK** to store the number.
6. Label your new button.

Internal autodial

1. If you are on a call or an open line with dial tone, press **Hold** or **Ris**.
2. Press **Feature** **#** **2**.
3. Press a memory button.
4. Dial the internal number.
5. Label your new button.

Features

1. If you are on a call or an open line with dial tone, press **Hold** or **Ris**.
2. Press **Feature** **#** **3**.
3. Press a memory button.
4. Press **Feature** and the feature code.
5. Label your new button.

Erasing memory buttons

1. If you are on a call or an open line with dial tone, press **Hold** or **Ris**.
2. Press **Feature** **#** **1**.
3. Press the memory button you want to erase.
4. Press **OK** to erase the button.

Your Norstar M7324 telephone

Memory and line buttons

are buttons with indicators for one touch dialing, feature operation or line access.

Display

shows the time, date, call information and guides you while using Norstar™ features. The lower line of the display is reserved for display button instructions.

Display buttons

Dial pad

Volume control

Feature button

starts or ends a feature.

Hold button

Release button
cancels active calls.

Indicators

appear beside active lines and features.

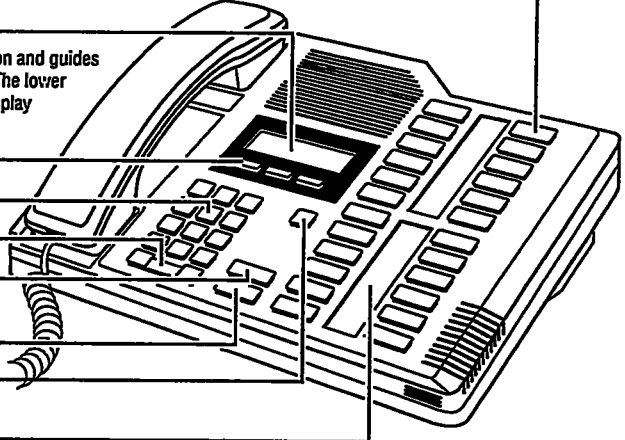

Using display buttons

Display buttons change with each feature you use. The labels for display buttons appear in capital letters directly above them on the second line of the display. A display button with an "OK" label above it is represented as OK in this card.

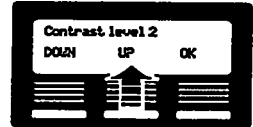

Button inquiry

Confirm that your memory and line buttons have the correct snap-on caps by checking their programming.

1. Release all calls or open lines with dial tone.
2. Press **Feature** ***** **0**.
3. Press the button(s) you want to check and read the display.
4. Press **Feature** when finished.

Adjusting display contrast

1. Press **Feature** ***** **7**.
2. Press **UP** or **DOWN** for the level you want.
3. Press **OK** when finished.

Selecting a ring type and volume level

1. Press **Feature** ***** **6**.
2. Press **1**, **2**, **3** or **4** to hear the different types of rings.
3. While the telephone is ringing, press **(4)** **(4)** to adjust the volume.
softer louder
4. Press **OK** to store the ring.

* Mendian and Norstar are trademarks of Northern Telecom.

Making calls

About line buttons

Norstar systems can have different types of line buttons. Match the line buttons on your telephone with the ones below for instructions on how to use them.

Intercom

Internal calls using Intercom buttons

1. Pick up the receiver.
2. If ► appears beside an Intercom button, then dial.
OR
Press an Intercom button without ►, then dial.

External calls using numbered Line buttons

1. Pick up the receiver.
2. When ► appears beside a numbered Line button, then dial.
OR
Press a numbered Line button without ►, then dial.

Line 1

Note: Internal numbers are supplied by your system coordinator.

4321

Internal calls using extension buttons

1. Pick up the receiver.
2. When ► appears beside an extension button, then dial.

External calls using extension buttons

1. Pick up the receiver.
2. When ► appears beside the extension button, then dial (or your system's external line access code) and the number.

Hold

Holding Calls

1. Press . The ► flashes beside the line on hold.
2. Press the line button with the flashing ► to return to the call.
Check the display for confirmation or additional information.

Automatic hold

Calls are put on hold automatically when you switch from one line to another.

Handsfree
Mute

This button operates the telephone's built-in microphone and speaker in place of the receiver. Your System Coordinator can program Handsfree to your telephone.

Making calls

1. Press instead of picking up the receiver.

Switching between Handsfree and handset

1. Press and replace the handset to switch to Handsfree.
2. Pick up the receiver to switch back.

Using Mute

1. Press to turn the microphone OFF.
2. Press again to turn the microphone ON.

Dialing without lifting the handset

1. Press a line button without ►, then dial your call.
2. When answered, pick up the receiver, or press .
3. If the call is not answered, or the line is busy, press .

Programming memory buttons

About memory buttons

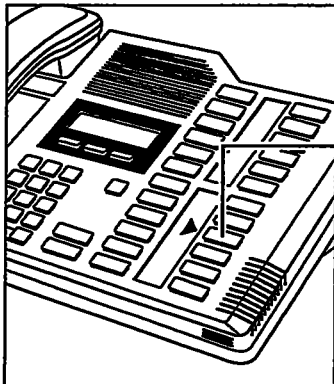

Memory buttons are the buttons with indicators other than line or Handsfree buttons. Memory buttons store telephone numbers or feature codes to give you one touch dialing or feature activation. You can change what a memory button does by just programming it with a new number or feature.

If you have programmed a memory button with an internal number the indicator comes on when the number is busy.

Remember: Press **Feature** ***** **0** to check a memory or line button.

Programming memory buttons

External autodial

1. If you are on a call or an open line with dial tone, press **Hold** or **Ris**.
2. Press **Feature** ***** **1**.
3. Press a memory button.
4. Dial the external number.
5. Press **OK** to store the number.
6. Label your new button.

Internal autodial

1. If you are on a call or an open line with dial tone, press **Hold** or **Ris**.
2. Press **Feature** ***** **2**.
3. Press a memory button.
4. Dial the internal number.
5. Label your new button.

Features

1. If you are on a call or an open line with dial tone, press **Hold** or **Ris**.
2. Press **Feature** ***** **3**.
3. Press a memory button.
4. Press **Feature** and the feature code.
5. Label your new button.

Erasing memory buttons

1. If you are on a call or an open line with dial tone, press **Hold** or **Ris**.
2. Press **Feature** ***** **1**.
3. Press the memory button you want to erase.
4. Press **OK** to erase the button.

Glossary

A

Access code: A sequence of characters used to gain entry into any type of Norstar system programming.

Administration: A program that lets one person in your office assign and maintain certain settings for the Norstar system.

Administration access code: A code required to access Administration programming. You may be asked for an Administration password.

Administration password: A one to six-digit password that prevents unauthorized access to Administration programming. The Administration password can be assigned and changed in Administration programming.

Allow redirect: A setting in Administration programming that enables you to identify whether a telephone is allowed access to the Line Redirection feature. Allow redirect has no effect if Disconnect Supervision is unavailable or was not enabled by your Customer Service representative.

Analog Terminal Adapter (ATA): A device that permits the connection of analog telecommunication devices such as fax machines, answering machines, and single line telephones to the Norstar system. Programmed defaults for the ATA are automatically assigned by the Norstar system.

Answer button: A telephone button with an indicator that is used to monitor another telephone. The Answer button indicates incoming calls destined for the other telephone. Someone working at a telephone with Answer buttons (a receptionist, for example) can receive all ringing and visual indication of incoming calls for other telephones, and answer those calls when necessary. One telephone can have up to four Answer buttons. An Answer button is automatically assigned to a telephone when that telephone is assigned an Answer DN.

Answer DN: A Directory Number (DN) of a telephone that is monitored by an Answer button. Up to four Answer DNs can be assigned to a telephone by the Customer Service representative.

Autobumping: A setting that determines what the system does with new Call Log items when your Call Log is full. When Autobumping is on, a new log entry causes the oldest entry to be deleted. If Autobumping is off, your Norstar system does not log calls when your log is full.

Autodial button: A memory button that, if programmed, provides one-touch dialing of external or internal numbers.

Automatic Dial: A feature that allows you to dial without having to pick up the receiver or select a line. You must have a Prime line to use Automatic Dial.

Automatic Handsfree: A feature that automatically activates Handsfree operation when you make or answer a call. Automatic Handsfree is assigned in Administration programming.

Automatic Hold: A feature that automatically places an active call on hold when you select another line. Automatic Hold is programmed by your Customer Service representative.

Automatic Privacy: See Privacy.

Automatic Telephone Relocation: A feature that lets a telephone retain its personal and system programming when it is plugged into a different Norstar modular jack. Automatic telephone relocation is enabled by your Customer Service representative.

Auxiliary ringer: A separate external telephone ringer or bell that can be programmed to ring when a line or a telephone rings. An auxiliary ringer may be programmed to ring only when the system is in a particular Service Mode. Programming of an auxiliary ringer is done in Administration programming after the feature has been enabled by your Customer Service representative.

B

Background Music: A feature that lets you hear music from the speaker of your Norstar telephone. It is available only if a music source has been attached to the KSU and the feature has been enabled by your Customer Service representative.

Busy Lamp Field (BLF): A device with a liquid crystal display (LCD) panel of indicators that shows the status of up to 24 telephones in the Norstar system. The BLF shows a telephone as busy if it is active on a call, has Do Not Disturb turned on, or is being used for programming. The BLF attaches to the M7310 Telephone.

Button caps: Interchangeable plastic caps that fit over the buttons of Norstar telephones. They are used to indicate the features programmed onto each programmable memory button. Button caps are either pre-printed or have clear windows that allow you to label the buttons.

Button Inquiry: A feature that allows you to check the function of each programmable button on your Norstar telephone.

Bypass Restrictions: A setting that allows you to override any Call Restrictions applied to specific System Speed Dial numbers. Bypass Restrictions can be turned on in Administration programming.

C

Call Forward: A feature that forwards all the calls arriving at your telephone to another telephone in your Norstar system. To have calls forwarded outside the system, use Line Redirection.

Call Forward No Answer: A feature that forwards all calls arriving at your telephone to another designated telephone in your Norstar system after a specific number of rings. Call Forward No Answer is assigned in Administration programming.

Call Forward On Busy: A feature that forwards all calls at your telephone to another designated telephone if your telephone is busy. This feature is assigned in Administration programming.

Call Forward Override: A feature that allows you to call someone and ask them to stop forwarding their calls to you.

Call Information: A feature that allows you to display information about incoming calls. For external calls, you can display the caller's name, telephone number and the line name. For an internal call, you can display the name of the caller and their internal number. You can obtain information about ringing, answered, or held calls.

Call Log: A feature that accesses a record of incoming calls. The log could contain the following information for each call: sequence number in the Call Log, name and number of caller, long distance indication, indication if the call was answered, time and date of the call, number of repeated calls from the same source, and name of the line that the call came in on. See Autobumping, Enter Call Log, Logit, and Logging Options for further information.

Call Park: A feature that allows you to place a call on hold so that someone can retrieve it from any telephone in the Norstar system by selecting an internal line and entering a retrieval code. The retrieval code appears on the display of your telephone when you park the call. You can park up to two calls on the system at one time.

Call Park Callback: See Callback.

Call Park prefix: The first digit of the retrieval code of a parked call. The default Call Park prefix digit is "1". It may be set to none, in which case Call Park is disabled. Call Park prefix is assigned by your Customer Service representative.

Call Pickup Directed: A feature that lets you answer a call ringing at any Norstar telephone by entering the internal number of that telephone before taking the call. Call Pickup Directed is activated by your Customer Service representative.

Call Pickup group: See Pickup group.

Call Queuing: A feature that allows you to answer calls in order of priority if you have several calls waiting at your telephone. Priority is given to external incoming calls, followed by callback and camped calls.

Callback: A feature that returns parked, camped or transferred calls to your telephone if they are not answered at another telephone. How long the system will wait before Callback occurs is set by your Customer Service representative.

Camp-On: A feature that lets you re-route a call to a telephone even if all the lines on that telephone are busy. To answer a camped call, use Call Queuing or select a line if the camped call appears on your telephone. Priority is given to queued external incoming calls over camped calls.

Camp timeout: The length of a delay before a camped call is returned to the telephone that camped the call. This delay is set by your Customer Service representative.

Capabilities: A section heading in Administration programming, that covers the dialing filters, set abilities, and line abilities that can be assigned to Norstar lines, telephones, or Class of Service passwords.

Central Answering Position (CAP) module: A CAP module is connected to an M7324 Telephone and provides 48 additional buttons which can be used as Autodial buttons or Feature buttons.

Class of Service (COS): A set of Norstar features and lines available to the user for a call. The Class of Service for a call is determined by the Dialing Filters assigned to the telephone in Administration programming. The Class of Service for a call can be changed by entering a six-digit Class of Service password. Class of Service and Class of Service passwords are assigned in Administration programming.

Class of Service password: A six-digit code that lets you switch from your current Class of Service to one that lets you dial numbers prohibited by your current Class of Service.

Conference: A feature that allows you to establish a three-person call at your Norstar telephone.

Conference using Privacy: A feature that allows you to turn Privacy off for a call allowing another person with the same line to press the line button and join in your conversation, forming a conference. Normally your calls are private; no one else can pick up your line and join in.

Contrast Adjustment: A feature that allows you to set the contrast level of your telephone display.

Control telephone: A telephone that can place the lines for which it has responsibility in or out of a Service Mode. A telephone is programmed as a Control telephone and has lines assigned to it in Administration programming.

COS: See Class of Service.

Cursor: A short horizontal line that appears on the Norstar telephone display to indicate that characters can be entered using the dial pad.

D

Data Communications

Interface: A Norstar device that lets you attach an RS-232 data device to your Norstar system.

Data terminal: A device, such as a modem, that can be used to transfer data instead of sound over a telephone network. You cannot use Norstar programming to set up such devices. See the documentation that accompanies the device.

Date: See Show Time or Time and Date.

DCI: See Data Communications Interface.

Defaults: The settings for all Norstar features when the system is first installed. Settings are changed from their defaults in Administration programming and by your Customer Service representative. In this manual, default settings are shown in bold text.

Delayed Ring Transfer (DRT) to Prime: A feature that transfers an unanswered call on an external line to the Prime Telephone associated with that line after a specified number of rings. This feature is activated by your Customer Service representative.

Dialing mode: The dialing mode of a line can be either tone or pulse. Pulse is traditionally used by rotary dial telephones. Tone is also referred to as dual-tone multi frequency (DTMF) tones. Dial mode can be programmed by your Customer Service representative.

Dialing filter: A feature that prevents certain telephone numbers from being dialed through a combination of restrictions and exceptions. Dialing filters can be applied to telephones (set filters), to lines (line filters), to specific lines on a telephone (line/set filters), and to Class of Service passwords. The Norstar Compact system can handle up to 25 dialing filters.

Direct-Dial: A feature that lets you dial a designated telephone in your Norstar system with a single digit. The Direct-Dial telephone is established in Administration programming. Telephones are assigned to a Direct-Dial telephone in Administration programming.

Direct-Dial number: A digit used system wide to call a Direct-Dial telephone. The digit is programmed by your Customer Service representative.

Directed Pickup: See Call Pickup Directed.

Directory Number (DN): A unique number that is assigned to each telephone or data terminal by your Customer Service representative. The DN, also referred to as an internal number, is often used to identify a telephone when settings are assigned during programming.

Disconnect Supervision: A setting which enables the Norstar system to detect if an external caller hangs up. Once an external caller hangs up, the Norstar system can disconnect its line. Disconnect Supervision is enabled by your Customer Service representative. If Disconnect Supervision is unavailable or is not enabled the following features are not available: Line Redirection of an external call to an external number, Transfer between two external calls and Unsupervised Conference between two external calls.

Display: A liquid crystal display (LCD) on the Norstar telephone that guides you through feature operation and programming.

Display button: One of three buttons located directly beneath the display on M7310 and M7324 Telephones. During feature operation or programming, some or all of these buttons may be used to provide further options. If an option is available, it is shown in the bottom line of the two-line display, directly above the corresponding display button. Display buttons are represented in this Guide as underlined capitals, e.g. OK.

Display digits: A sub-heading in Administration programming that allows you to set whether an assigned name or the actual number is displayed when someone uses a System Speed Dial code.

DN: See Directory Number.

DRT delay: The number of rings before a Delayed Ring Transfer occurs. This is assigned by your Customer Service representative.

DRT to Prime: See Delayed Ring Transfer to Prime.

E

Exceptions: A component of a Dialing filter. Exceptions are numbers you can dial even if they are forbidden by a more general restriction. See Restrictions.

External call: A call to a destination outside the Norstar system.

External Call Forward: See Line Redirection.

External code: The number you dial to get an external line. The default is 9, but this can be changed by your Customer Service representative. You do not always need an external code. It is primarily to support the M7100 Telephone and single-line telephones using an Analog Terminal Adapter (ATA).

External line: A line on your Norstar telephone used for making calls to destinations outside the Norstar system.

External music source: See Music source.

External paging: A feature you can use to make voice announcements over an externally-mounted loudspeaker connected to the Key Service Unit. The external speaker is not a Norstar component and must be supplied by the customer.

Extra-Dial telephone: A heading in Administration programming that allows you to assign an extra Direct-Dial telephone when a Service Mode is active. You can have one Extra-Dial telephone for each of the three Service Modes.

F

Feature button: A button that activates many Norstar features when it is pressed and followed by a feature code. The Feature button is also used to exit a feature.

Feature code: A number that is used to activate a particular feature.

Forward: See Call Forward.

Forward delay: The number of rings before an unanswered call is forwarded to another telephone when the Call Forward No Answer feature is on. Forward delay is assigned in Administration programming.

Forward No Answer: See Call Forward No Answer.

Forward On Busy: See Call Forward On Busy.

Full Autohold (on idle line): When this feature is activated, selecting an available line and then selecting another line, puts the first line on hold. Full Autohold is activated by your Customer Service representative.

Full Handsfree: See Handsfree.

G

Group Listen: A feature that allows you to have others in your office hear a caller through your phone's speaker. The caller hears you only when you speak into the receiver and cannot hear other people in the office.

H

Handsfree: A feature you can use to make calls without using the telephone receiver. Full Handsfree is activated in Administration programming. When it is activated, a Handsfree/Mute button is automatically assigned to the telephone.

Handsfree (HF) Answerback: A feature that automatically turns on the microphone at a telephone receiving a Voice Call so that the person receiving the call can respond without lifting the receiver. Handsfree Answerback is activated in Administration programming.

Handsfree/Mute button: See Handsfree.

Headset: A head-mounted or ear-mounted telephone receiver that is used instead of the hand-held receiver. Headsets are not Norstar components and must be supplied by the customer.

Held (line) Reminder: An indication that an external call has been placed on hold for a certain period of time. Your Norstar telephone beeps and displays the message On hold: LINENAM. The Held (line) Reminder feature and Remind delay are programmed by your Customer Service representative.

HF Answerback: See Handsfree Answerback.

Hold button: A button used to suspend calls so that the person using the telephone can perform another task without disconnecting the caller.

Hookswitch Flash: See Link time.

Host System Signaling: (Also referred to as End-to-End Signaling.) Norstar telephones can access a remote system or dial a number on an alternate carrier by means of Host feature activation, such as Link, Pause and Run/Stop.

Hotline: A feature that automatically calls a pre-assigned number when the telephone's receiver is lifted or the Handsfree/Mute button is pressed. A Hotline number can be an internal or external number. Hotline is programmed in Administration programming.

Hung line: A line that remains busy after a redirected call is over. A hung line is indicated when a line indicator is solid for a long time and a call is not in progress. Hung lines can be cleared at the telephone that was used to redirect the line.

I

I/C: An abbreviation of Intercom button.

Intercom button: A button that provides access to internal lines used for calls within a Norstar system and access to external lines through a Line Pool or external code. A telephone may be assigned zero, one or two Intercom buttons. This is done by the Customer Service representative.

Intercom keys: See Intercom button.

Internal line: A line on your telephone dedicated to making calls to destinations inside your Norstar system. An internal line may still connect you with an external caller if you use it to access a line pool or to pick up a call using Norstar call handling features such as Call Park or Call Pickup Directed.

Internal number: A number (also referred to as a Directory Number or DN) that identifies a Norstar telephone or device.

Internal user: A person using a Norstar telephone within a Norstar system.

K

Key Service Unit (KSU): The central hardware component in the Norstar system. The KSU has its own processor and memory, and provides a physical point of connection for the various types of devices and telephones used in Norstar. The KSU supports 8 Norstar telephones and 3 external lines.

L

Line: The complete path of a voice or data connection between one telephone (or other device) and another.

Line abilities: The heading in Administration programming under which you assign Line filters to lines.

Line filter: See Dialing filter.

Line names: The sub-heading in Administration programming that allows you to assign names to external lines.

Line number: A 2-digit number that identifies an external line. Three external lines are supported by the KSU.

Line Pool: A group of lines used for making external calls. Line Pools provide an efficient way of giving a telephone access to external lines without taking up many line buttons. A line is assigned to be a member of a Line Pool by your Customer Service representative.

Line Pool access code: A number that gains access to a specific Line Pool if you are a member of that Line Pool. Line Pool access codes are assigned by your Customer Service representative.

Line Redirection: A feature that allows you to redirect all external calls on an incoming line to a destination outside the Norstar system. Once a line is redirected it cannot be answered within the Norstar system. The system may be set up to give a brief ring when a call comes in on a redirected line. Line Redirection must be assigned to your telephone in Administration programming. When redirecting an external call to an external number, the incoming call must be on a disconnect supervised line. See Allow Redirect, Call Forward, Disconnect Supervision and Redirect Ring.

Link time: A specific time delay that allows access to PBX features through a Norstar system. Link time is also referred to as a "Hookswitch Flash" or "Recall". Link time is assigned by your Customer Service representative.

Logging Options: A feature that allows you to select the type of calls that are stored in your Call Log. You can choose to log calls that were not answered by anyone within the system, to log calls that were unanswered at this telephone but answered elsewhere in the system, to log all calls answered and not answered at this telephone, or to not have calls automatically logged.

Logit: A feature that allows you to manually log call information when you are connected to a call.

Long Tones: A feature that lets you control the length of a tone so that you can signal devices such as fax or answering machines which require tones longer than the standard 120 milliseconds.

M

M7:100 Telephone: A telephone that has a one-line display and one programmable memory button without an indicator.

M7208 Telephone: A telephone that has a one-line display and eight programmable memory buttons with indicators.

M7310 Telephone: A telephone that has a two-line display, 3 display buttons, 10 programmable memory buttons with indicators, and 12 dual-memory programmable buttons without indicators. An M7310 Telephone can be equipped with a Busy Lamp Field.

M7324 Telephone: A telephone with a two-line display, 3 display buttons, and 24 programmable memory buttons with indicators. An M7324 Telephone can be equipped with a CAP module.

M7900 Telephone: A telephone with a touch-screen display that replaces the display and memory buttons of other Norstar telephones. It provides simplified access to Norstar Features and an interface to computer driven applications.

Memory buttons: The buttons that can be programmed to dial frequently used features or numbers automatically. See M7100, M7208, M7310, M7324 and M7900 Telephone entries for their exact memory button configurations.

Message: A feature that allows you to indicate to another internal user that you would like them to call you.

Music source: A radio or other source of music that can be connected to the Key Service Unit to provide music for the Music on Hold and Background Music features. A music source is not part of the Norstar system and must be supplied by the customer.

N

Names: A feature that allows you to assign names to System Speed Dial numbers, external lines, telephones, and Service Modes in Administration programming. You can use up to sixteen characters to name a System Speed Dial number, and seven characters to name a telephone, line, or Service Mode. If a Name has not been assigned, the line number or DN appears on the display instead of a Name.

Night Service: See Service Modes.

Norstar Programming

Overlay: A paper template that is placed over the buttons of the Norstar telephones during programming. The overlay for the M7310 and M7324

Telephones is placed over the top four memory buttons with indicators. The overlay for the M7208 Telephone is placed over all of the eight memory buttons. The overlay labels indicate the special function that each of the buttons takes on during programming.

O

On hold: A setting that controls whether external callers hear music, periodic tones, or silence when they are placed on hold. This setting is programmed by your Customer Service representative.

Open Switch Interval (OSI): A public telephone system feature that indicates when an external line is open. Norstar monitors the length of the OSI to detect when an external caller hangs up. OSI must be provided by the public telephone system in order for Disconnect Supervision to function. See Disconnect Supervision.

Overlay: See Norstar Programming Overlay.

P

Page: A feature you can use to make announcements over the Norstar system. You can choose Internal Page (announce over the telephone speakers), External Page (announce over an externally-mounted, customer-supplied loudspeaker), or both Internal and External Page.

Page Zone: An area in the office that receives internal Page announcements independently of the rest of the office. Each Page Zone is identified by a number. Telephones are assigned to Page Zones in Administration programming.

Park prefix: See Call Park prefix.

Park timeout: A delay before an unanswered parked call returns to the telephone that parked it. Park timeout is set by your Customer Service representative. See Call Park.

Password: A specific sequence of digits that you enter to gain access to Norstar programming or to override dialing restrictions. Passwords are also required for System Startup and Administration programming. See Class of Service password.

Pause: A system feature that allows you to set a 1.5-second delay in a dialing sequence programmed on an External Autodial.

Personal Speed Dial: A two-digit code (71-94) that can be programmed to dial external telephone numbers. Personal Speed Dial numbers are programmed for each telephone, and can be used only at the telephone on which they are programmed.

Pickup group: A group of telephones. A telephone can be placed into one of four Call Pickup groups. A call ringing at a telephone within a Pickup group can be picked up at any other telephone within the same Pickup group. A telephone is assigned to a Pickup group in Administration programming.

Pool: See Line Pool.

Pre-dial: A feature that allows you to enter a number and check it on your telephone display before it is actually dialed. If the number is incorrect, you can edit it. The number is dialed only when you pick up the receiver or select a line.

Prime line: A line on your telephone that is automatically selected when you lift the receiver, press the Handsfree/Mute button or use an external dialing feature. A Prime line is assigned to a telephone by your Customer Service representative.

Prime telephone (Prime set): A telephone that provides backup answering for incoming calls on external lines. The Prime telephone for a line will ring for any unanswered calls on that line. A Prime telephone is assigned to a line by your Customer Service representative.

Priority Call: A feature you can use to interrupt calls or override Do Not Disturb on another Norstar telephone. This feature is enabled for a telephone in Administration programming.

Privacy: A feature that determines whether a Norstar user may select a line in use at another telephone and join an established call. Privacy is set by your Customer Service representative, but can be turned on and off by users during individual calls.

Private line: See Private to.

Private network: A telephone network consisting of owned or leased telephone lines used to connect different offices of an organization independently of the public network.

Private to: A line assigned to one telephone as a Private line by your Customer Service representative. The line cannot appear on any other telephone, except the Prime telephone for that line. Private lines cannot be placed into Line Pools.

Programming: A series of procedures that set the way the Norstar system works. Programming includes system-wide settings and individual telephone and line settings.

Programming Overlay: See Norstar Programming Overlay.

Programming reminder: A chart on which you can record some commonly-used settings to distribute to all Norstar telephone users.

Public line: An external line that can be assigned to any telephone and to many telephones. A line is assigned as Public by your Customer Service representative.

Public network: The regular telephone network that connects most homes and businesses.

R

Recall: See Link time.

Receiver: The handset of a telephone.

Redirect ring: A setting in Administration programming that allows you to set whether a line that has been redirected using Line Redirection gives a short ring on those telephones on which the line has a ringing appearance.

Remind delay: A feature that causes a telephone to beep and display the message

On hold: LINENAM when a call has been on hold for a programmable period of time. This period is the Remind delay, and is programmed by your Customer Service representative.

Restrictions: A component of a Dialing filter. Restrictions are numbers you cannot dial when that Dialing filter is in effect. See Exceptions.

Ringng: A programming function done by your Customer Service representative that assigns a line to ring or not ring at a telephone. If a line has been assigned as "No ring", an incoming call is shown only by a flashing indicator.

Ringing Telephone (Ringing Set): A telephone that has been assigned to ring when a line has been placed into a Service Mode. The Ringing Telephone is assigned in Administration programming.

RIs button: A button that ends a call in the same way that hanging up the receiver does. It may also be used to end Startup, Administration programming, Configuration programming and feature operations.

Run/Stop: A character that creates a breakpoint in a programmed external dialing sequence. When you press a programmed key, the system dials the number up to the Run/Stop. When you press it again, the system dials the digits following the Run/Stop.

S

SAPS: See Station Auxiliary Power Supply.

Selective Line Redirection: See Line Redirection.

Service Modes: A feature that provides special ringing and telephone access after normal office hours, or when there are few people available to answer calls. Certain features become active when one or more lines are placed into a Service Mode. Service Modes settings are assigned in Administration programming.

Set: A telephone.

Set ability: A sub-heading in Administration programming under which set filters, line/set filters, and a variety of system features are assigned to individual telephones.

Set Copy: A programming section that allows your Customer Service representative to copy programmable settings from one telephone to another of the same type. Set Copy provides two options: duplicating System Data and User Data, or duplicating System Data only. Set Copy does not provide the same copy capability as the COPY display button, which is more selective of the settings that can be duplicated.

Set filter: See Dialing filter.

Set Names: A sub-heading in Administration programming that allows you to assign Names of up to seven characters to telephones.

Set Relocation: See Automatic Telephone Relocation.

Shift button: A small triangular button beside the dual-memory buttons on the upper half of the M7310 Telephone. Press the shift button to store or access features on the top half of the dual-memory buttons.

Show Time: A feature that allows you to see the current date and time on the Norstar telephone display while you are on a call.

Station Auxiliary Power Supply (SAPS): A device which provides power to a Norstar telephone that is connected more than 305 m (1000 ft) and less than 760 m (2500 ft) from the Key Service Unit, or to a CAP module.

Supervised line: A line for which disconnect supervision is enabled. If an external caller hangs up, the Norstar system detects the disconnection and hangs up its line also. See Disconnect Supervision.

System Data: An option in Set Copy programming. System Data refers to the system settings that apply to all telephones and lines. System Data consists of the programmable settings from Administration programming and also includes the settings programmed by your Customer Service representative.

System Speed Dial Code: A two-digit code (01 to 70) that can be programmed to dial a telephone number up to 24 digits long. System Speed Dial codes are programmed for the entire Norstar system in Administration programming.

System Speed Dial Name: A sub-heading in Administration programming under which you can assign a name to a System Speed Dial number.

System Speed Dial: A heading in Administration programming under which you can assign up to 70 numbers as System Speed Dial numbers.

System Startup: A procedure that initializes the system programming to defaults. When a Norstar system is first installed and powered up, System Startup must be performed before any programming can be done.

T

TCM line (Time Compression Multiplexing line): A two-wire digital station loop joining the cross-connect at the Key Service Unit to a telephone.

Telephone lock (Set lock): A feature that allows you to limit the number of features that may be used or programmed at a telephone. Full telephone lock allows very few changes or features, Partial telephone lock allows some changes and features, and No telephone lock allows any change to be made and any feature to be used. Telephone lock is assigned in Administration programming.

Time and Date: A display description. The current time and date appear on the display of idle Norstar telephones. The time and date can be changed in Administration programming.

Transfer: A feature that lets you send a call to another telephone in your Norstar system or external to Norstar. You can also create an Unsupervised Conference to do an external transfer. When transferring an external call to an external number, at least one of the calls must have been an incoming call, and that call must be on a disconnect supervised line. See Unsupervised Conference and Disconnect Supervision.

Transfer Callback: A feature that returns a transferred call if it is not answered after a specific number of rings. The number of rings is programmed by your Customer Service representative. Transfer Callback does not apply to calls transferred externally.

Trunk: A physical connection between the Norstar system and the outside world using either the public telephone system or a private network.

Trunk Answer: A feature you can use to answer a call on any line that has an active Service Mode, even if that line does not appear on your telephone. Trunk Answer is activated in Administration programming.

U

Unsupervised Conference: A conference that you have dropped out of leaving the other two parties connected. When both other parties are external to Norstar, at least one of the outside callers must have called you, and that call must be on a disconnect supervised line. See Disconnect Supervision.

Unsupervised line: A line for which disconnect supervision is disabled. If an external caller hangs up, the Norstar system does not detect the disconnection and does not hang up its line. See Disconnect Supervision.

User Filter: See Dialing filter.

V

Voice Call: A feature you can use to make an announcement or begin a conversation through the speaker of another telephone in the Norstar system. The telephone you call does not ring. Instead, the person you call hears a beep and then your voice. Their telephone beeps periodically to remind them that their microphone is on.

Index

A

- Access Code
 - External line 120
- Access denied
 - Conference 109
 - Speed Dial 168
- Accidental Disconnect
 - Protection 170
- Administration
 - Dialing filters 38
 - Direct-Dial 37
 - entering 25
 - exiting 25
 - headings 23
 - moving through 26
 - Names 31
 - overview 23
 - Programming reminders 64
 - Service Modes 54
- Administration programming 1
- Allow redirect
 - programming 48
- Already joined
 - Dialing 122
- Already parked
 - Call Park 99
- Answer button 102, 153, 205
- Answerback (see Handsfree
 - Answerback)
- Autobumping
 - feature description 91

- Autodial
 - buttons 154
 - feature description 81
 - Host System Signaling 83
 - losing data after power failure 83
 - Autodial full
 - Autodial 81
 - Speed Dial 168
 - Automatic Call Information 60
 - Automatic Dial 114
 - Automatic Handsfree 113, 206
 - programming 45
 - Automatic telephone relocation
 - 170, 206
 - Auxiliary Ringer 13, 206
 - programming 46
 - Service Modes 57
- ## B
- Background Music 170, 206
 - Button
 - Answer 153
 - Autodial 154
 - erasing programming 128
 - Feature 153
 - Hold 153
 - indicators 76
 - Line 154
 - Memory 153
 - Programmed feature 154
 - Release 155
 - Volume 155
 - Button erased
 - Autodial 82
 - Button Inquiry
 - feature description 128

C

- Call Display information 3, 74
- Call Display services 3
- Call Duration Timer 175
- Call Forward
 - feature description 84
 - No Answer 47, 84
 - On Busy 47, 84
 - Override 84
- Call Identification 59, 60, 61
- Call Information
 - before or after answering 87
 - feature description 87
 - for a call on hold 88
- Call Log 6
 - add digits to a number 93
 - call from 93
 - choose logging options 90
 - entering 91
 - erase log items 92
 - feature description 89
 - navigating within 92
 - optional password 94
 - space 59
 - trim a number 93
- Call Park 75, 208
 - feature description 99
- Call Pickup 75
 - assigning groups 103
 - feature description 101
 - priority of alerting calls 102
- Call Pickup (group)
 - programming 45
- Call Queuing 75, 208
 - feature description 104
 - queuing priorities 104
- Callback 74, 208
- Calls
 - incoming indicators 80
- Camp-On
 - answering camped call 106
 - feature description 105
 - ringing 76
- Camp denied
 - Camp-On 105
- Can't ring again
 - Dialing 123
- Can't send msg
 - Message 149
- Cancel
 - feature 72
- Cancel denied
 - Message 149
- Cancel for
 - Message 150
- Capabilities
 - Dialing filters 38
 - Line filter 53
 - User filter 53
- Class of Service 171
- Class of Service password (see COS Password)
- Conference
 - disconnect one party 107
 - feature description 107
 - independently hold two calls 108
 - on M7100 telephone 111
 - put on hold 108
 - split 108
 - Transferring 109
 - Unsupervised 109
 - with Privacy 107
- Conference busy
 - Conference 109
- Configuration programming 2
- Contrast Adjustment 113
- Control telephone 164

- assigning to lines 54
- Copy
 - Capabilities programming 63
 - line programming 63
 - telephone programming 63
- COS Line filter (see Line filter)
- COS Password 51
 - changing 112
 - copying data 52
 - feature description 112
 - Line filter 53
 - number of 52
 - User filter 53
- Customizing Norstar 1, 23
- Customizing the telephone
 - Automatic Handsfree 113
 - Contrast Adjustment 113
 - Dialing Modes 114
 - Language 115
 - moving line buttons 116
 - Pulse/Tone dialing 117
 - Ring Type 117
 - Ring Volume 118
 - Telephone Administration
 - Lock 118

D

- Defaults
 - Dialing filters 42
- Delayed Ring Transfer 74
- Denied in admin
 - Line Redirection 142
 - Service Modes 162
- Dial-0 telephone (see Direct-Dial telephone)

- Dialing
 - Direct-Dial 120
 - Pulse or Tone 117
 - unrestricted 42
- Dialing filters
 - defaults 42
 - deleting 41
 - number of 40
- Dialing Modes
 - Automatic 114
 - Pre-Dial 114
 - Standard 114
- Direct-Dial telephone 164
- Directed Pickup
 - feature description 101
- Directory Numbers 171, 211
- Disconnect Protection (see Accidental Disconnect Protection)
- Disconnect Supervision 70, 172
 - Display
 - one-line 71
 - Prime telephone 79
 - two-line 71
- DND (see Do Not Disturb)
- Do Not Disturb 75, 85
 - feature description 126
- Do Not Disturb on Busy 13, 47
 - feature description 126
- DRT delay 211
- DRT to Prime 211

E

- Emergency calls
 - Priority Call 160
- Enter code
 - Speed Dial 168
- Enter zone
 - Page 158
- Exceptions

- in a Dialing filter 42
 - removing 41
- Exclusive Hold
 - feature description 135
- Extension numbers (see Directory Numbers)
- External Autodial 81
- External call
 - ringing 76
- External line
 - Line/telephone filter 43
- External line access code 120
- Extra-Dial telephone 165
 - additional Direct-Dial 57

F

- Feature
 - availability 70
 - cancelling 72
 - overview 70
 - restrictions 44
- Feature button 153, 212
 - programmed 154
- Feature programming 128
- Filter
 - Line 51
 - Line with COS 53
 - Line/telephone 43
 - Telephone 43
 - User 53
- Forward denied
 - Call Forward 85
- Forwarding (see Call Forward)
 - Call Forward No Answer 47
 - Call Forward On Busy 47
- Full Handsfree
 - programming 44

G

- Get call first

- Call Park 99
- Group Listen
 - feature description 131
- Group Pickup
 - feature description 101

H

- Handsfree
 - Automatic 45
 - etiquette 133
 - Full Handsfree 44
- Handsfree Answerback 45
- Handsfree/Mute 75
 - feature description 132
- Headset
 - answering a call 155
 - Full Handsfree 44
 - operating 155
- Hold
 - feature description 134
 - Listen on Hold 134
 - Music, Tones or Silence 135
 - on M7100 telephone 135
- Hold button 153, 213
- Hold or release
 - feature programming 130
- Host System Signaling 136, 213
 - Link 136
 - Pause 136
 - Programmed Release 137
 - Run/Stop 137
- Hotline
 - programming 49
- Hotline telephone 165
- Hung lines
 - releasing 172

I

- Indicators 80
- Internal Autodial 81

Internal call
 ringing 76
Internal numbers (see Directory
 Numbers)

Invalid zone
 Page 158

L

Language choice 115
Last Number Redial
 feature description 13, 121
Line
 appearance 172
 Hung 172
 indicators on telephones 76
 moving line buttons 116
 Names 33
 Prime 174
 Private 173
 Ringing preference 174
 supervision 172
Line Abilities
 Line filter 51
Line button 154
Line filter
 (COS) defaults 53
 (COS) programming 51
 defaults 51
 programming 51
Line in use
 Hotline 165
Line Pool 173, 215
 feature description 139
 Hotline 49
 Ring Again 140
 System Speed Dial 29

Line Redirection 85
 Allow redirect 48
 Call Forward No Answer 47
 Call Forward On Busy 47
 feature availability 70
 feature description 141
 Redirect ring 48
Line/telephone filter
 number of 44
Link
 feature description 136
Listen on Hold 134
Logit
 feature description 90
Long Tones
 feature description 146

M

M7100 telephone
 Conferencing 111
 Hold 135
 no display buttons 71
 selecting lines 73
M7208 telephone
 no display buttons 71
M7310 telephone 216
M7324 telephone 216
Make call first
 Camp-On 106
Make calls first
 Conference 109
Memory button 216
 erasing 128
 programming 128
Message denied
 Message 150
Message Waiting 11
Message Waiting List
 calling from 148

- Messages
 - feature description 147
 - Message Waiting List 148
 - Voice Message Center 152
- Music on Hold 135

N

- Names
 - entering letters 22
 - for lines 33
 - for telephones 32
 - length 31
 - moving telephones 31
 - programming 31
 - System Speed Dial 30
 - valid characters 31
- Need Handsfree
 - Headset 156
- Night Service
 - Service Modes 162
- No button free
 - Dialing 123
 - Message 151
- No calls waiting
 - answering the telephone 77
- No last number
 - Last Number Redial 124
- No line selected
 - answering the telephone 78
 - Dialing 124
 - Hotline 166
- No line to use
 - Line Redirection 142
- No number saved
 - Saved Number Redial 124
- No saved number
 - Saved Number Redial 124
- No voice call
 - Voice Call 182

- Not in service
 - Camp-On 106
- Numbers
 - entering 21
 - viewing 21

O

- On-hook dialing 114
- Open Switch Interval (see OSI)
- OSI 70, 172, 217
- Outgoing line
 - Line Redirection 143

P

- Page
 - feature description 157
 - selecting a zone 157
- Page timeout
 - Page 158
- Page Tone 14, 157
- Page zone 157, 217
 - programming 46
- Paging
 - programming 45
 - zones 46
- Paging busy
 - Page 158
- Park denied
 - Call Park 100
- Parking full
 - Call Park 100
- Password
 - Administration 58
 - Class of Service (COS) 112
- Pause
 - feature description 136
- Personal programming 1
- Personal Speed Dial 167, 218
- Pick up receiver
 - Call Queuing 78

- Pickup (see Call Pickup)
 - Pickup denied
 - Call Pickup 102
 - Pool code
 - Line Redirection 143
 - Pre-Dial 114, 218
 - Prime line 174, 218
 - Hotline 47
 - Prime telephone 75, 166, 218
 - Priority Call
 - feature description 160
 - ringing 76
 - Priority denied
 - Priority Call 160
 - Privacy
 - creating a Conference 107
 - Private line 173
 - Call Pickup 45, 102
 - Program and HOLD
 - feature programming 130
 - Programmed Release
 - feature description 137
 - Programming
 - Allow redirect 48
 - Automatic Handsfree 45
 - Auxiliary Ringer 46
 - Call Forward No Answer 47
 - Call Forward On Busy 47
 - Call Pickup (group) 45
 - Capabilities 38
 - COS Line filter 53
 - Do Not Disturb on Busy 47
 - features 128
 - Full Handsfree 44
 - Handsfree Answerback 45
 - Hotline 49
 - Names 31
 - Page zone 46
 - Paging 45
 - preparing for 16.
 - purpose 15
 - Redirect ring 48
 - reminders 64
 - Service Mode name 55
 - Service Modes 54
 - Telephone filter 43
 - tools 17
 - Trunk Answer 57
 - using display buttons 20
 - Programming Overlay 17, 219
 - Programming Record 17
 - Pulse dialing 117
- ## R
- Receive tones 49
 - Redirect
 - Line Redirection 143
 - Redirect ring
 - programming 48
 - ringing 76
 - Release a call
 - answering the telephone 79
 - Release button 155
 - Restricted call
 - Dialing 124
 - Line Redirection 143
 - Restrictions
 - bypassing 30
 - in a Dialing filter 42
 - number of 40
 - removing 41
 - Ring Again
 - feature description 121
 - Ring Type 117
 - Ring Volume 118
 - Ringling
 - changing the type 117
 - changing the volume 118
 - Line preference 174

- Service Modes 57
- Run/Stop
 - feature description 137
- S**
- Saved Number Redial
 - feature description 14, 121
- Selective Line Redirection (see Line Redirection)
- Service Modes 54, 220
 - activate and deactivate 55
 - Auxiliary Ringer 57
 - canceling 162
 - Control telephone 54, 162
 - default start and stop times 56
 - Extra-Dial telephone 57, 163, 165
 - feature description 162
 - programming 54
 - Ringling 57
 - Trunk Answer 57
- Signaling
 - Host System 136
- Speaker
 - Page 157
 - telephone 45
- Speed Dial
 - Class of Service 169
 - feature description 167
 - personal programming 167
- Standard Dial 114
- Supervision (see Disconnect Supervision)
- System Speed Dial 174, 221
 - bypassing restrictions 30
 - changing name 30
 - Display Digits 29
 - programming 27

- T**
- Telephone
 - Administration Lock 118
 - Control 164
 - Customizing 113
 - Direct-Dial 37, 46, 164
 - Extra-Dial 165
 - Hotline 165
 - Names 31
 - Prime 75, 166
 - relocation 170
- Telephone Abilities
 - Allow last number redial 50
 - Allow Link 50
 - Allow redirect 48
 - Allow saved number redial 50
 - ATA answer timer 50
 - Automatic Handsfree 45
 - Auxiliary Ringer 46
 - Call Forward No Answer 47
 - Call Forward On Busy 47
 - Call Pickup (group) 45
 - Direct-Dial telephone 46
 - Full Handsfree 44
 - Handsfree Answerback 45
 - Hotline 49
 - Line/telephone filter 43
 - Page zone 46
 - Paging 45
 - Priority Call 50
 - Redirect ring 48
 - Telephone Administration Lock 44
- Telephone buttons
 - Norstar Telephones 153
- Telephone Feature Card 17
- Telephone User Cards 17
- Their list full
 - Messages 151

- Time
 - call duration 175
 - display while on a call 175
 - feature description 175
 - Time and Date
 - setting the date 36
 - setting the time 35
 - Tone dialing 117
 - Tones
 - Long 146
 - Receive 49
 - Tones denied
 - Long Tones 146
 - Transfer
 - feature availability 70
 - feature description 176
 - using Hold 177
 - using Unsupervised Conference 177
 - Transfer denied
 - Transfer 179
 - Trunk Answer
 - feature description 101
 - programming 57
- U**
- Unequipped line
 - Line Redirection 144
 - Unsupervised Conference 109
 - feature availability 70
 - Transfer 177
- V**
- Voice Call 157, 223
 - deny 181
 - feature description 181
 - Handsfree Answerback 45, 181
 - muting tones 181
 - Voice Call Deny 75
 - feature description 181
 - Voice Message Center
 - lines 62
 - telephone numbers 62
 - Volume button 155

Y

- Your list full
 - Messages 151

GhUbxUfXHY`Y'Vta

