

Le manège des quatre saisons

Imprimez la page avec les différents éléments des saisons ainsi que le manège et distribuez aux enfants :

- soit uniquement les éléments correspondant à un thème (une saison particulière ou les animaux, par exemple) ;
- soit l'ensemble des éléments, pour leur permettre d'effectuer eux-même le tri de ceux qu'ils colleront sur leur manège, librement ou selon une consigne précise.

Demandez aux enfants de choisir quatre éléments, de les découper et de les coller sur le manège. Ils peuvent ensuite tout colorier !

Sur le site Internet www.editions-sesames.com, **téléchargez également les ressources gratuites de tous nos kamishibais sur les saisons !**

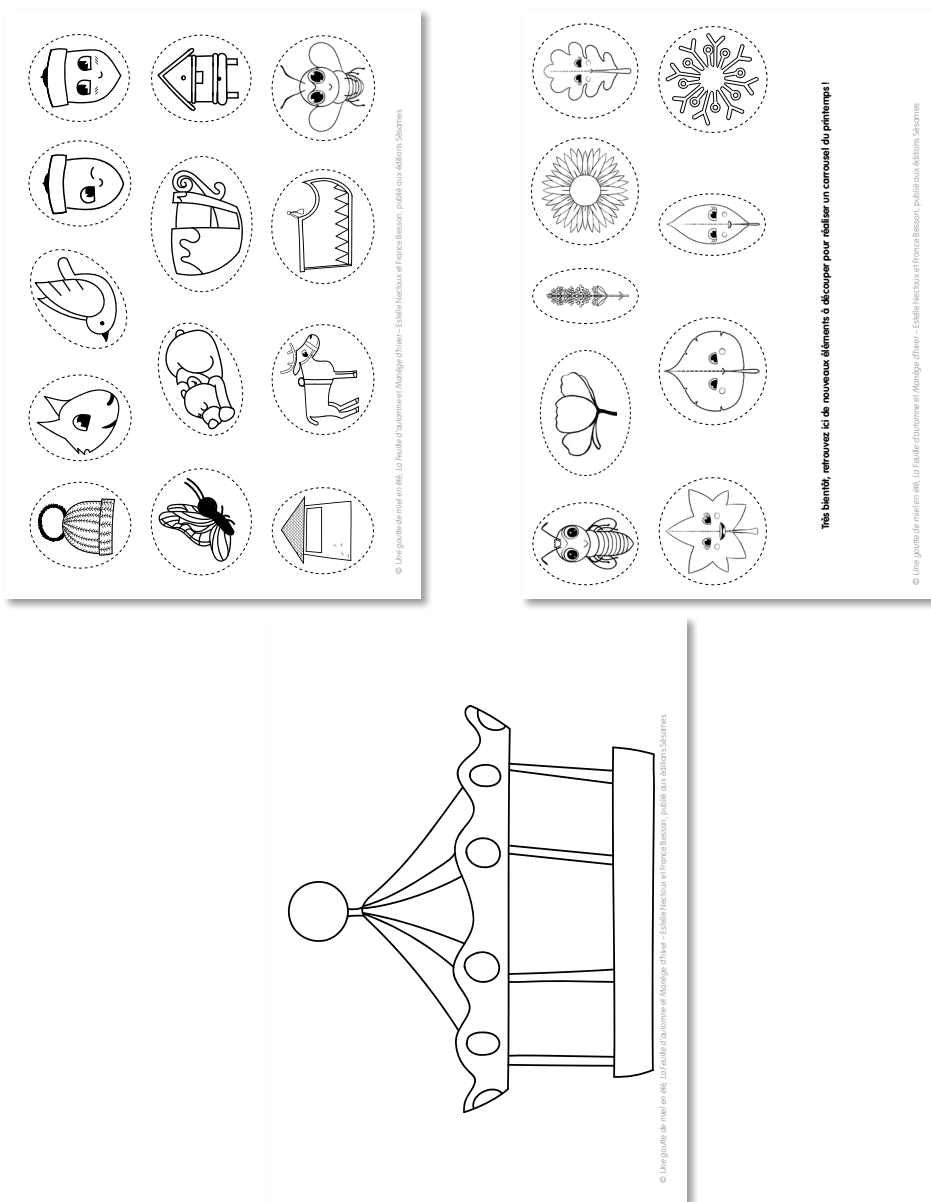

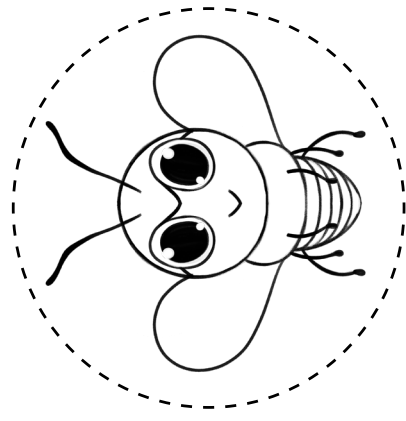
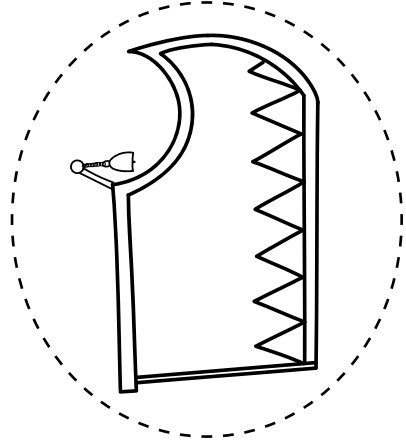
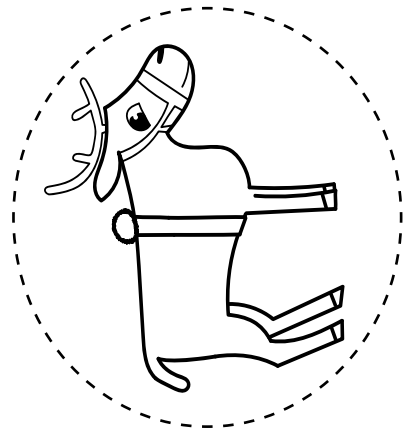
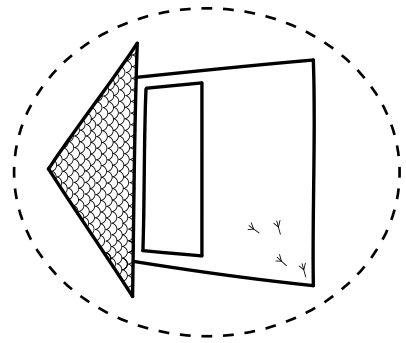
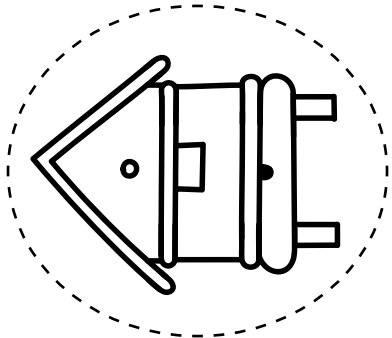
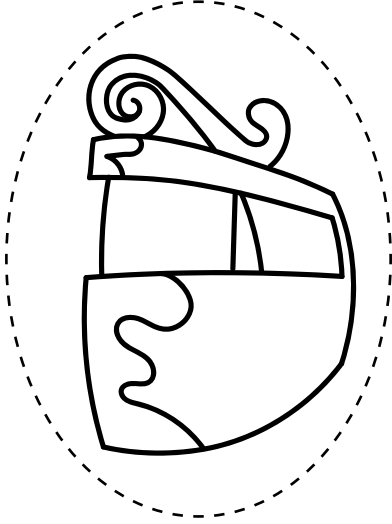
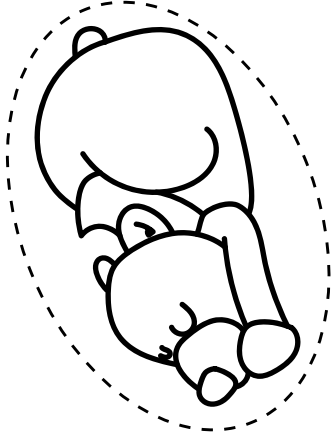
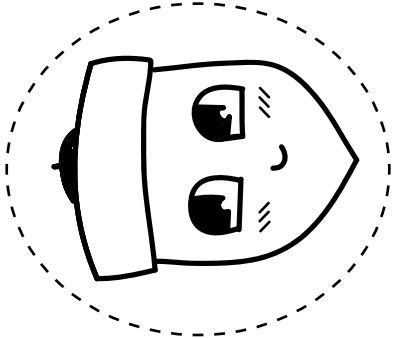
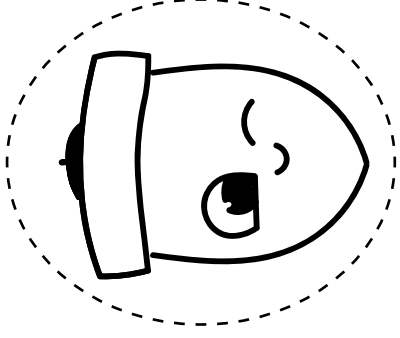
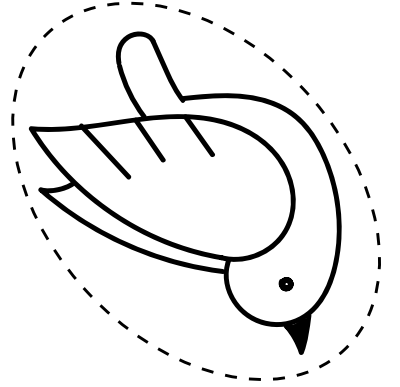
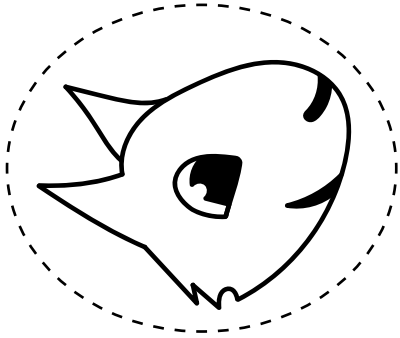
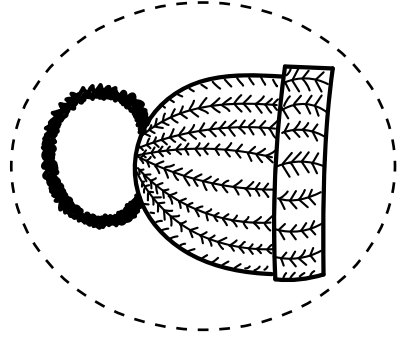

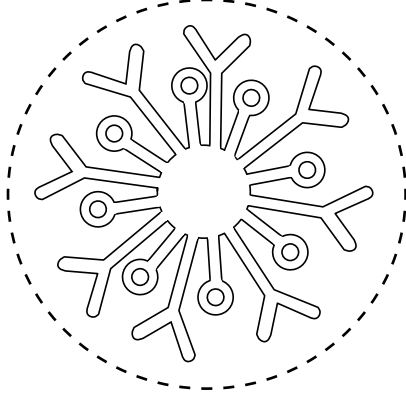
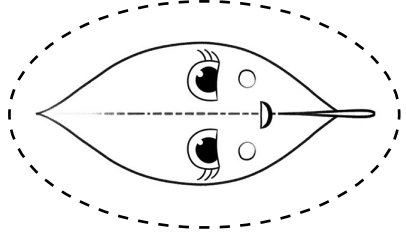
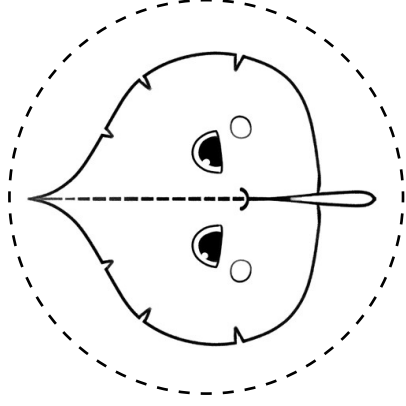
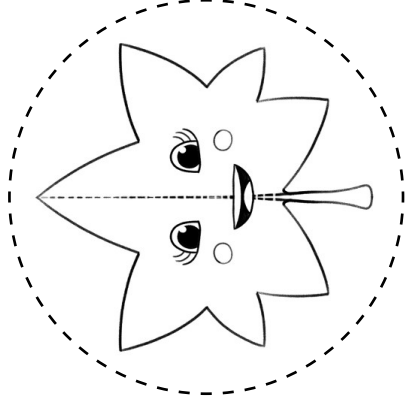
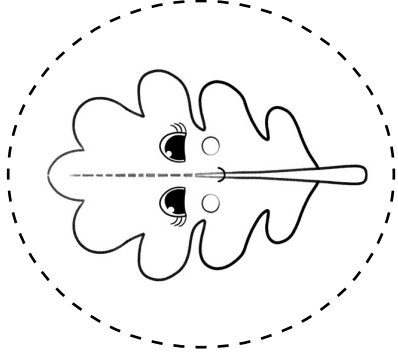
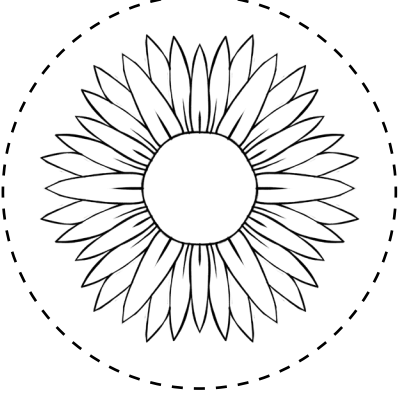
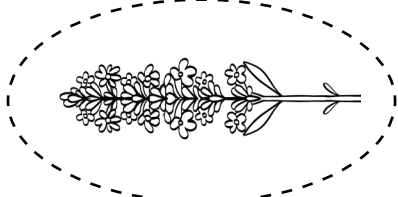
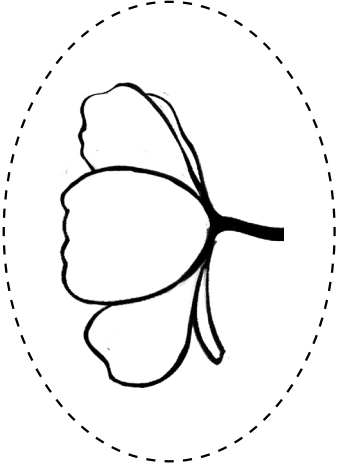
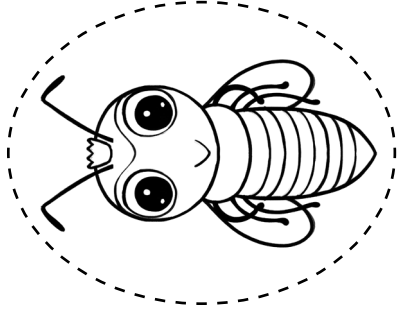

Très bientôt, retrouvez ici de nouveaux éléments à découper pour réaliser un carrousel du printemps!

