



Wine Cellar Cooling Systems Cabinet Cooling Systems Installation, Operation and Maintenance Guide

60Hz Models CAB018
50Hz Models CAB25

Manufactured by:



Wine Guardian reserves the right, without notice, to make changes to this document at its sole discretion. Please visit our web site for the most current version of the Wine Guardian manual and other literature.

Wine Guardian is a registered trademark (US 2,972,262, EU #005108675) of Air Innovations, Inc.

Wine Guardian Through-the-Wall U.S. Pat. No. D634,760S,

Edition 011-2020

© Air Innovations, 2020

Part No.
15H0307-00

TABLE OF CONTENTS

Directory of Terms	5
Receiving, Inspecting and Unpacking the Wine Guardian System	6
General Description	7
Wine Guardian Controls	8
Wine Guardian Controls	9
Standard Specifications	10
The Wine Guardian Cabinet System Contains.....	10
Serving Temperature Option	10
Accessories and Optional Equipment	11
Extended Compressor Warranty---U.S. and Canada only	11
Duct Collar Adapter	11
Remote Temperature/Humidity Controller	11
Remote Temperature/Humidity Sensor	11
Heater Option	11
Humidity Option.....	12
Overview of the Wine Guardian Unit.....	12
Overview	13
Safety	16
Safety Message Conventions.....	16
Danger	16
Warning.....	16
Caution.....	16
Lockout/Tagout Procedure	17
Safety Considerations.....	17
Safety Hazards.....	17
Electrical Hazards	17
Electrical Shock Hazards.....	17
Hot Parts Hazards	17
Moving Parts Hazards.....	18
Equipment Safety Interlocks.....	18
On/Off Switch	18
Installation	20
Pre-installation Test.....	20
Air Flow Illustration	20
Planning the Installation.....	21
Performing a Pre-installation Check.....	22
Locating the system	22
Power cord location.....	22

Evaporator Connections	22
Condenser Connections	23
Turning on system.....	24
Wiring the System for Power	24
Electrical Plug Configuration 60Hz Models Only	25
Starting-up and Operating the Wine Guardian	26
Control Settings	26
Controller Functions.....	26
Standard Controller Functions	27
<i>Alarm Codes</i>	34
Installing the Optional Remote Interface Controller and Communication Cable	36
Controller Specification	37
Mounting the Optional Remote Interface Controller (Wired).....	38
Mounting the Optional Remote Interface Controller (Wireless)	40
Installation of the Optional Wine Guardian Remote Sensor	41
Mounting the Wired Remote Sensor (Wired)	41
Mounting the Remote Sensor (Wireless)	43
Remote Sensor Pairing Instructions – Multiple Sensors (Wireless).....	44
Regulating the Cabinet Temperature.....	45
Maintenance	45
Maintenance Schedule	46
Monthly	46
Yearly.....	46
High Pressure Switch Has Shut the System Down	47
Instructions to Reset High Pressure Switch	47
Alarm Annunciation.....	47
Troubleshooting.....	48
Typical Start-up Problems	48
Unit Does Not Start-up.....	48

Unit is Operating and Blows Evaporator Air, but the Supply Air is not Colder than the Return Air from the Cellar.....	49
Problems Controlling Cellar Temperature.....	49
Problems Controlling Cellar Humidity	50
Problems Controlling Cellar Humidity	51
Other Miscellaneous Problems.....	51

Manufacturer’s Warranty – U.S. and Canada only Error! Bookmark not defined.

Cabinet Unit Return Policy for U.S. and Canada only.. **Error! Bookmark not defined.**

Contact InformationError! Bookmark not defined.

Note: This equipment has been tested and found to comply with the limits for a Class B digital device, pursuant to part 15 of the FCC Rules. These limits are designed to provide reasonable protection against harmful interference in a residential installation. This equipment generates, uses and can radiate radio frequency energy and, if not installed and used in accordance with the instructions, may cause harmful interference to radio communications. However, there is no guarantee that interference will not occur in a particular installation. If this equipment does cause harmful interference to radio or television reception, which can be determined by turning the equipment off and on, the user is encouraged to try to correct the interference by one or more of the following measures:

- Reorient or relocate the receiving antenna.
- Increase the separation between the equipment and receiver.
- Connect the equipment into an outlet on a circuit different from that to which the receiver is connected.
- Consult the dealer or an experienced radio/TV technician for help.

RSS GEN (English)

This device contains licence-exempt transmitter(s)/receiver(s) that comply with Innovation, Science and Economic Development Canada’s licence-exempt RSS(s). Operation is subject to the following two conditions:

1. This device may not cause interference.
2. This device must accept any interference, including interference that may cause undesired operation of the device.

RSS GEN (French)

L’émetteur/récepteur exempt de licence contenu dans le présent appareil est conforme aux CNR d’Innovation, Sciences et Développement économique Canada applicables aux appareils radio exempts de licence. L’exploitation est autorisée aux deux conditions suivantes :

1. L’appareil ne doit pas produire de brouillage;
2. L’appareil doit accepter tout brouillage radioélectrique subi, même si le brouillage est susceptible d’en compromettre le fonctionnement.

Directory of Terms

Ambient Air – The surrounding area outside the cellar such as a room, basement, garage or outdoors.

CFM – Cubic feet per minute. A unit of measurement for the amount of air handled by the fan.

Condensate / Condensation – The water formed out of the air when it is cooled below a certain temperature (called dew point). Often referred to as “sweating” on pipes and cold surfaces. This water collects at the bottom of the evaporator or cooling coil and drains out of the unit through the drain line.

Condenser (Heat Rejection) Section / Coil – The Condenser Section uses the compressor, condenser coil and fan to remove heat from the refrigerant to the ambient air *outside* the wine cellar. The word condenser refers to the condensation of the refrigerant from gas to liquid phase.

CSA/ETL – Canadian Standard Association/Electric Testing Laboratory

CE – Certificate of European conformity

Exhaust Air – The air leaving the evaporator or condenser section of the Wine Guardian unit.

Evaporator (Cooling) Section / Coil – The Evaporator Section uses the cooling coil and the fan to remove heat from the air *inside* the wine cellar to the refrigerant, cooling the air and condensing moisture out of the air. The word evaporator refers to the evaporation of the refrigerant from liquid to gas phase in the coil. The Evaporator Section is connected to or inside the wine cellar.

Flexible Duct – Round ducts with steel reinforced plastic liners, a layer of insulation and an outer plastic layer used to convey the air from the unit to the cellar or ambient space.

Grille or Diffuser – Inlet or outlet plates to direct the airflow or protect the inside of the unit.

Heat Gain / Loss – The amount of cooling or heating expressed in watts transferred between the wine cellar and the ambient space. The Wine Guardian must offset this load.

Inlet Air – The air entering the evaporator and condenser sections of the Wine Guardian unit.

NEC – National Electrical Code

Recovery – The amount of cooling the unit does to return the cellar to its set point temperature after some new load is introduced, such as people or new cases of warm wine entering the cellar.

Return Air - The air leaving the cellar and returning to the inlet of the evaporator coil.

SP – Static pressure. Unit of measurement (inches of water column) of the pressure of the air handled by the fan.

Set Point – The desired temperature or humidity set on the thermostat or humidistat.

Supply Air - The air entering the cellar from the discharge of the evaporator coil.

Receiving, Inspecting and Unpacking the Wine Guardian System

NOTE: Wine Guardian systems are factory assembled and tested prior to shipment.

Wine Guardian systems are shipped individually in corrugated boxes specially designed to protect the equipment during shipment.

- ✓ Before opening the container, inspect the packing crates or boxes for obvious signs of damage or mishandling.
- ✓ Write any discrepancy or visual damage on the bill of lading before signing.
- ✓ Inspect all equipment for any sign of damage caused during transit.
- ✓ Report all visual or concealed damage to the carrier and file a claim immediately.

IMPORTANT

If this procedure is not followed, the shipping company may reject the claim and the consignee may suffer the loss. Do not return the shipment to the factory.



WARNING



****THE UNIT SHOULD BE LIFTED FROM UNDERNEATH ITS BASE AT BOTH ENDS OF THE SYSTEM.**

Review the Packing Slip to Verify:

- ✓ Model number
- ✓ Factory-installed options
- ✓ System accessories

If any items listed on the packing slip do not match your order information, contact the place of purchase immediately.

Check the unit for:

- ✓ An electrical power cord
- ✓ Foam gasket for seal between Wine Guardian unit and cabinet
- ✓ Accessories such as condenser air duct collar or duct collar kit, and optional controls, if ordered.

General Description

The Wine Guardian Cabinet cooling system is a professional grade, self-contained climate control system designed specifically for the storage of wine at cellar temperatures. It is designed for easy installation and operation. Wine Guardian uses digital electronic controls and environmentally friendly R-134a refrigerant. The entire system is run-tested at the factory and shipped as a single package. All components are of a high quality standard commercial grade. The entire system is approved by ETL (Equipment Testing Lab) according to UL (Underwriters Laboratory) 484 and CSA (Canadian Standard Association) safety standards. All wiring complies with NEC (National Electrical Code). All 50Hz Wine Guardian equipment is CE certified. Each system is factory installed with a sealed, UL-approved power cord and plug. Wine Guardian products are made in the USA.

The Wine Guardian Cabinet system is completely self-contained and includes an integral air cooled condenser. The system is functionally divided into two sections, the evaporator or cooling section, and the condenser or heat rejection section. Each section contains a coil to add or remove heat and a fan to move the air through the coil and into our or out of the cellar or adjacent space.

Air from the cabinet first enters the cooling coil. Air passes through the cooling coil and is cooled by the refrigerant inside the coil. This causes any excess humidity in the air to condense and be captured in the drain pan and internally evaporates as it comes in contact with the integral condensate removal coil. Air then enters the fan where it is pressurized and discharged out of the system. The thermostat (remote interface controller) turns the cooling on and off as needed to maintain its set point.

The compressor and condenser section are activated whenever the system is cooling. The condenser fan draws air from the surrounding or ambient space. The airflows through the condenser coil where it absorbs heat from the refrigerant in the coil. The air is finally discharged out of the system by the condenser fan, and can be ducted outside or to an unused space through optional duct collars.



THE AIR EXHAUST FORM THE CONDENSER FAN IS WARM AND CAN BE 20 DEGREES F ABOVE THE ENTERING AIR TEMPERATURE.

Wine Guardian Controls

Wine Guardian's digital electronic control system offers a versatile solution for controlling and monitoring your cabinet temperature and humidity. This system consists of three controls; a main control board; a remote user interface; and a remote temperature and humidity sensor. The system only requires the use of the main control board and the remote user interface to function. However, users have the following options to customize the control capabilities for their application: (See pg. 8 for description of control boards and optional sensors).

The Wine Guardian's digital electronic controls are designed to control the operation of the compressor, condenser fan, evaporator fan, and optional humidifier. There also is pressure switch monitoring with a dry contact alarm output that will energize in the event of a pressure switch fault or a high/low temperature or humidity alarm. The remote user interface controls employ user-friendly, menu-driven programming features that can easily be accessed by holding the mode button on the control for five seconds. Once in the program menu, the user can scroll through the settings by pressing the mode button and can adjust each setting by using the up and down arrows. The programming mode allows the user to customize features such as °F or °C temperature scale, high/low temperature and humidity alarm set points, an adjustable 0-10 minute compressor anti-short cycle delay, sensor averaging options, enable or disable the defrost feature, differential and dead band adjustments, room temperature calibration, enable or disable the humidifier, and automatic or continuous fan option. To exit the programming mode the user may either hold the mode button for 5 seconds or the control will automatically store the settings and exit the programming mode after 10 seconds of inactivity. Each remote user interface control will also employ an ON/OFF button that turns the system on or off respectively.

Wine Guardian Controls

Main Control: Performs all switching functions and interfaces with inputs and outputs. It can connect to local or remote user interface, as well as remote temperature/humidity sensor.



One-way communication: remote temp/humidity sensor reports temp and humidity readings to main control.



Temperature/Humidity Sensor: Can be used in conjunction with the Main Control to report temp/humidity from inside the wine cellar without requiring a user interface to be located inside the wine cellar.

Two way communications: remote user interface reports settings back to main control, main control energizes outputs and reports alarms and temp/humidity readings to remote user interface.



Default to 13 Deg C for 50Hz models

Remote User Interface: Can be used with Main Control for adjusting settings, reading temp/humidity, and reading fault codes in a remote location away from the unit.

Standard Specifications

IMPORTANT

Design and specifications are subject to change without notice

The Wine Guardian Cabinet System Contains

- ✓ A capillary tube expansion to control the flow of refrigeration into the evaporator coil
- ✓ A filter dryer to keep the refrigerant clean and free of contaminants
- ✓ A manually reset, high-pressure switch on the condenser discharge to protect the compressor from high pressures
- ✓ Environmentally friendly-134a refrigerant
- ✓ An internally/externally mounted digital electronic control with many user-controlled settings
- ✓ Multi-panel evaporator/condenser return/intake connections

All exterior framing of the Wine Guardian is 0.063" gauge aluminum to prevent rust and corrosion. All coils are aluminum tubes with aluminum fins. The system uses an internal drain system to remove excess moisture and does not reintroduce it back into the cabinet.

Each system is provided with a pre-wired and tested remote user interface as standard, an optional temperature and humidity sensor (up to three) are available as options. The thermostat has multiple control functions for the fan, operation, cooling, and maintaining humidity (if equipped).

Compressors are self-lubricating, permanently sealed, hermetic reciprocating type compressors, with internal overload protection and capacity start with a minimum of one-year manufacturer's warranty and an optional five-year warranty. Compressors are mounted on rubber-in-shear isolators to reduce noise and vibration.

Electric power is supplied by a single, factory-furnished cord and plug.

Serving Temperature Option

The factory configured serving-temperature option allows a Wine Guardian unit to control to an extended temperature range from 42° F to 64° F (5°C - 18°C). Perfect for single to multiple cabinet applications and small wine rooms in which consumption-temperature cooling is preferred. It also allows the user to rotate wine stock and change the set point from season to season, making it ideal for restaurants, wine bars, clubs, etc.

Accessories and Optional Equipment

Extended Compressor Warranty---U.S. and Canada only

The Wine Guardian uses only the best commercially available compressors on the market. However, since the compressor is the single most expensive component in the system, it is recommended that you purchase the extended, five-year warranty option.

Duct Collar Adapter

Optional duct collar adapters are available for ease in directing the warm condenser air away from the cabinet or for directing cold conditioned air to the cabinet from the cooling unit.

Remote Temperature/Humidity Controller

The remote temperature/humidity controller (Remote Interface Controller) is intended to provide a means for user interface at a remote location. The controller can be used as a remote sensor/controller mounted within the cabinet. The controller can also be used as a remote indicator (without sensor) mounted directly outside of the cabinet. The Remote Interface Controller includes a backlit face for temperature and humidity indication along with controller set-up and operational functions. Up to two (2) remote interface controllers can be used on one Wine Guardian Cabinet unit.

Remote Temperature/Humidity Sensor

The remote temperature/humidity sensor is intended to provide a means of sensing one or more locations within the wine cellar and designed to work in conjunction with the Remote Interface Controller or Local Interface Controller integral to the Wine Guardian Cabinet system. Multiple sensor readings are averaged and controlled to a single point. The sensors do not have any temperature or humidity indication and must be mounted within the cabinet.

Heater Option

The electric heat option includes an integral electric heating element, thermal overload protection device and controls. The Wine Guardian will either cool or heat the air, but it is not designed to do both at the same time. The Wine Guardian electric heat option must be specified at time of order and installed at our factory.

Humidity Option

NOT AVAILABLE

Overview of the Wine Guardian Unit

Refer to illustrations on page 14

Cabinet – The cabinet is constructed of aluminum for corrosion protection and maintenance-free appearance. Areas in contact with cold temperatures are lined with insulation to prevent condensation.

Condensing Section - Ambient air is circulated through the condenser section by a direct drive, permanently lubricated, motorized impeller blower. This section also contains the compressor and the electrical controls.

Evaporator Section – Cabinet air is circulated through the evaporator section by a direct drive, permanently lubricated motorized impeller blower. The large evaporator coil face area eliminates condensate carry-over, reduces air pressure drop and optimizes heat transfer. A drain pan is located directly below the coil to capture condensate and is fabricated from aluminum to prevent rust and corrosion.

Electrical Controls –All solid state electronic controls are connected internally and/or externally through an RJ9 phone cord-type connection. There is no need to open the chassis to access the factory mounted and wired control. All internal wiring is in accordance with the National Electrical Code. Wires are numbered and color coded to match the wiring diagrams.

Factory Tested – All Wine Guardian units are factory run-tested and checked for operational performance.

Internal Drain – Condensate from the evaporator coil is directed to the condensate removal system at the condenser end of the unit. This allows the drain pan to drain freely.

Refrigerant Circuit –The factory-charged circuit includes a capillary tube expansion device, a filter dryer, and a manual reset high pressure switch.

Overview

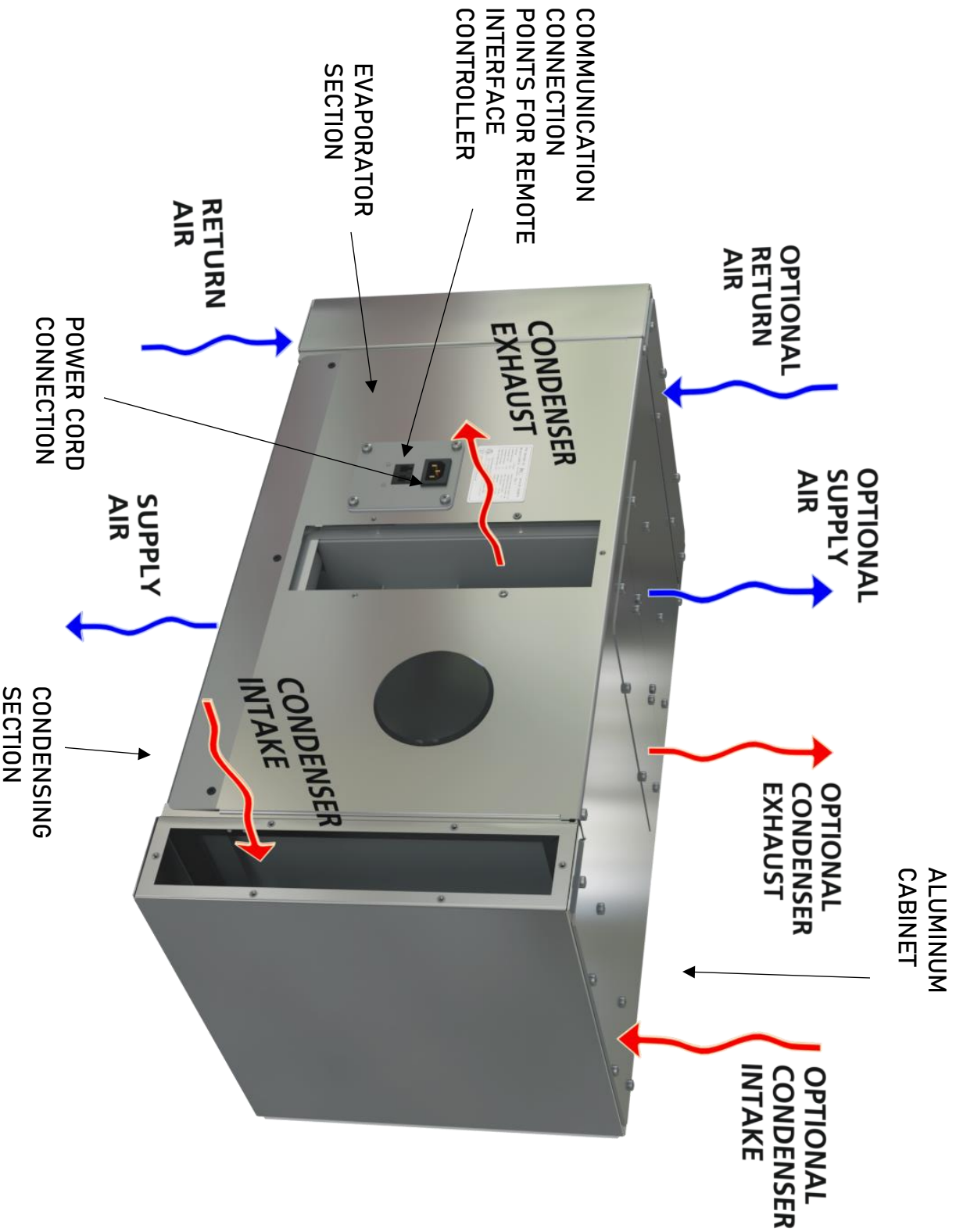

CAB018

4

3

2

1

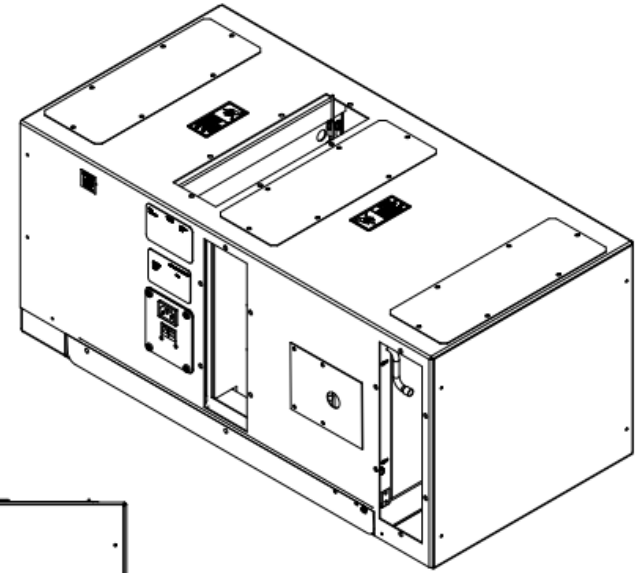
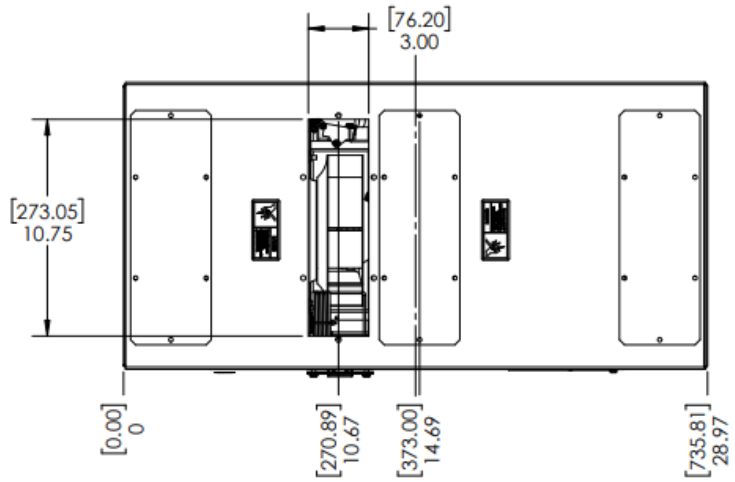

B

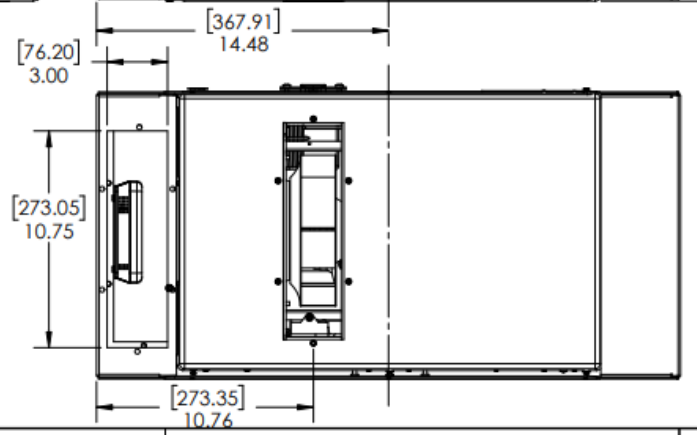
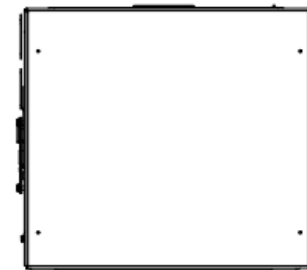
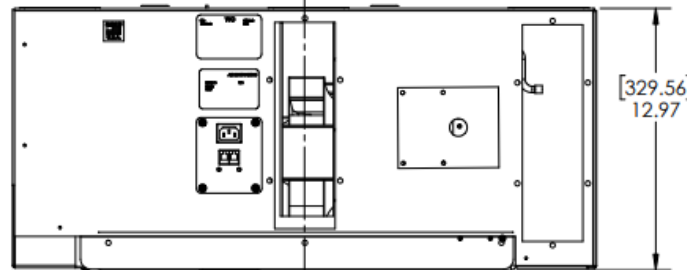
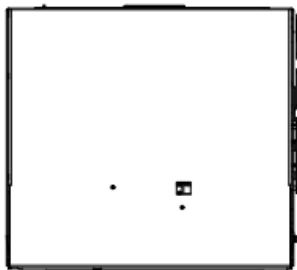

4

3

2

1

A

UNLESS OTHERWISE SPECIFIED:		NAME	DATE
DIMENSIONS ARE IN INCHES		JRT	1/26/21
TOLERANCES:			
FRACTIONAL ± 1/16			
ANGULAR: MACH ± BEND ± 2			
TWO PLACE DECIMAL ± .03			
THREE PLACE DECIMAL ± .015			
INTERPRET GEOMETRIC TOLERANCING PER:			
MATERIAL:		COMMENTS:	
FINISH:			
DO NOT SCALE DRAWING			
Cleanroom Systems / Floratech 7000 PERFORMANCE DRIVE, SYRACUSE, NY 13212-4527-400			
TITLE: CABINET UNIT, CAB25			
SIZE	DWG. NO.	REV	
B	99H0381-00 CAB	-	
			SHEET 1 OF 2

CAB018 and CAB25

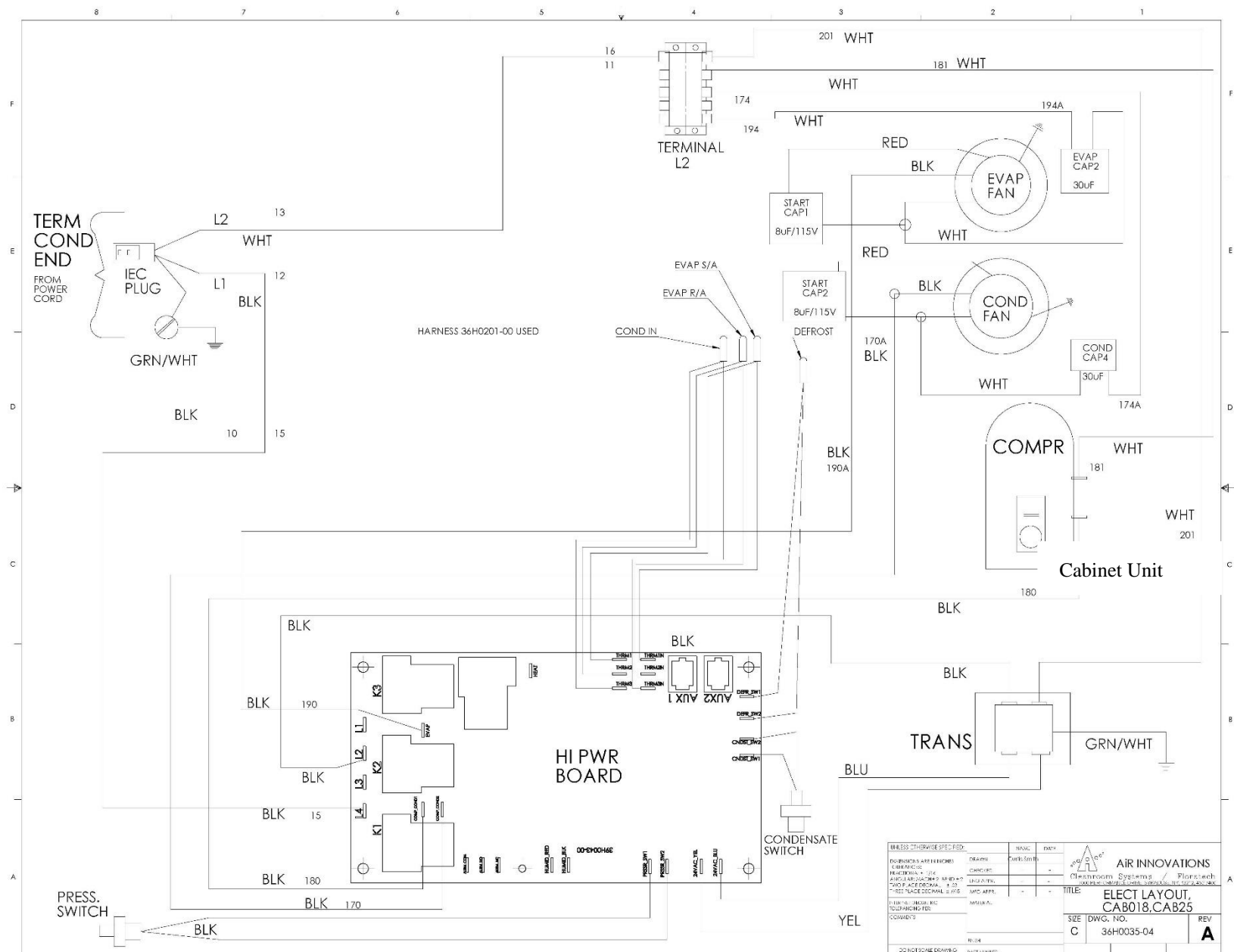

UNLESS OTHERWISE SPECIFIED:		UNLESS OTHERWISE SPECIFIED:	DATE:
CONDUCTORS AND RIGID	COMP. TO	DATE	
WIRING	DATE		
REVISIONS	BY	DATE	
<p>AIR INNOVATIONS 2025/05/08 CHESTERMOUNT SYSTEMS / FLORESTWEB</p>			
TITLE: ELECT LAYOUT, CAB018.CAB25			
SIZE: C	DWG. NO. 36H0035-04	REV: A	

Safety

The following is suggested before installing or maintaining the Wine Guardian System:

- 1) Read these instructions
- 2) Keep these instructions
- 3) Heed all warnings
- 4) Follow all instructions

Safety Message Conventions

Safety messages contained in this manual, DANGER, WARNING, and CAUTION are bold and highlighted in red for quick identification.

Danger

A **DANGER** message indicates an imminently hazardous situation which, if not avoided, results in death or serious injury. Messages identified by the word **DANGER** are used sparingly and only for those situations presenting the most serious hazards.



HIGH VOLTAGE - RISK OF SERIOUS INJURY OR DEATH
High voltages are present in the cabinets
TURN OFF ALL POWER BEFORE OPENING PANELS
USE THE LOCKOUT/TAGOUT PROCEDURE

Warning

A **WARNING** message indicates a potentially hazardous situation which, if not avoided, could result in death or serious injury.

Following is a typical example of a **WARNING** message as it could appear in the manual:



RISK OF PERSONAL INJURY OR DAMAGE TO EQUIPMENT Modification to the equipment may cause injury.

Caution

A **CAUTION** message indicates a potentially hazardous situation which, if not avoided, could result in minor or moderate injury. It may also be used to alert against unsafe practices.

Following is a typical example of a **CAUTION** message as it could appear in the manual:



RISK OF PERSONAL INJURY OR DAMAGE TO EQUIPMENT
Improper installation may result in the equipment malfunctioning and a safety hazard. Read all of the installation instructions before installing the Wine Guardian.

Lockout/Tagout Procedure

- 1) Turn the system to off at the remote interface controller (the display will indicate the system is off).
- 2) Unplug the unit from the electrical outlet and cover the outlet to prevent accidentally plugging in the system.

Safety Considerations

The equipment covered by this manual is designed for safe and reliable operation when installed and operated within its designed specifications. To avoid personal injury or damage to equipment or property when installing or operating this equipment, it is essential that qualified, experienced personnel perform these functions using good judgment and safe practices. See the following cautionary statements.

Installation and maintenance of this equipment is to be performed only by qualified personnel who are familiar with local codes and regulations, and are experienced with this type of equipment.

Safety Hazards

Exposure to safety hazards is limited to maintenance personnel working in and around the system. When performing maintenance, always use the Lockout/Tagout procedure, which is described in this chapter. Observe the maintenance safety guidelines in the Wine Guardian manual.

IMPORTANT
The equipment described in this manual uses electricity. When using this equipment, be sure to follow the safety procedures outlined in the Wine Guardian manual.

Electrical Hazards

Working on the equipment may involve exposure to dangerously high voltage. Make sure you are aware of the level of electrical hazard when working on the system. Observe all electrical warning labels on the system.

Electrical Shock Hazards

All power must be disconnected prior to installation and servicing this equipment. More than one source of power may be present. Disconnect all power sources to avoid electrocution or shock injuries.

Hot Parts Hazards

Electric Resistance heating elements (if equipped) must be disconnected prior to servicing. Electric heaters may start automatically, disconnect all power and control circuits prior to servicing the system to avoid burns.

Moving Parts Hazards

The Motor and Blower must be disconnected prior to opening access panels. The motor can start automatically. Disconnect all power and control circuits prior to servicing to avoid serious injuries or possible dismemberment.

The fans are free-wheeling after the power is disconnected. Allow the fans to stop completely before servicing the system to avoid cuts or dismemberment.

Rotating Fan Blades are present in the Wine Guardian system. Sticking a hand into an exposed fan while under power could result in serious injury. Be sure to use the Lockout/Tagout procedure when working in this area or remove the power cord.

Equipment Safety Interlocks

There are no electrical safety lockouts installed within the system. The power cord attached to the control box must be disconnected from the power sources prior to working on any part of the electrical system.

On/Off Switch

To shut down all high volt power internally, the power cord must be removed from power outlet.

Energy Type

Voltage

Hazard.....	Electrocution, electrical burns and shock
60Hz Magnitude	120 Vac and 230 Vac, 1 phase, 60 cycles
50Hz Magnitude	220/240 Vac, 1 phase, 50 cycles
Control Method.....	Disconnect power cord and On/Off Switch



- **Never** reach into the system while the fan is running.
- **Avoid** risk of fire or electric shock. **Do not** expose the system to **rain** or **moisture**.



- All supports for the system **must** be capable of safely supporting the equipment's weight and any additional live or dead loads encountered.
- All supports for the system **must** be designed to meet applicable local codes and ordinances.
- **Do not** remove access panels until fan impellers have completely stopped. Pressure developed by moving impellers can cause excessive force against the access panels.
- Fan impellers continue to turn (free-wheel) after the power is shut off.



- **Do not** block any supply or return air opening. Install in accordance with the instructions in the Wine Guardian manual.

- **Protect the power cord** from being walked on or pinched, particularly at the outlet plug, convenience receptacles, and the point where it exits the system.
- **Only** use attachments/accessories specified by the manufacturer.
- **Always** operate this equipment from a 120Vac, 1 phase **60Hz power sources only. For 50Hz equipment 220/240Vac, 1 phase 50Hz power sources only.**
- **Always ground the outlet** to provide adequate protections against voltage surges and built-up static charges (see Section 810 of the National Electric Code).
- **Refer all servicing to qualified service personnel.** Servicing is required when the system has been damaged in any way, such as:
 - ✓ Power supply cord or plug is damaged
 - ✓ Liquid has been spilled or objects have fallen into the system
 - ✓ The system has been exposed to rain or moisture
 - ✓ The system does not operate normally
 - ✓ The system has been dropped

Installation

 **CAUTION** 
SHARP EDGES
RISK OF SERIOUS INJURY

Sharp edges are present inside the Wine Guardian system.

Pre-installation Test

Test the system before installing it to check for non-visible shipping damage.

To test the system:

- ✓ Set the system on the floor or a sturdy level surface
- ✓ Plug in the system
- ✓ Plug the control cable into either COM1 or COM2 at the unit
- ✓ Press the on/off button at the remote user interface
- ✓ **The built in timer prevents short cycling and keeps the system from turning on right away.** The system comes on and runs as long as the temperature of the space is above the thermostat set point. After several minutes, cold air comes out of the system from the evaporator section side and hot air comes from the condenser section. Listen for any unusual noise or vibration.

Air Flow Illustration

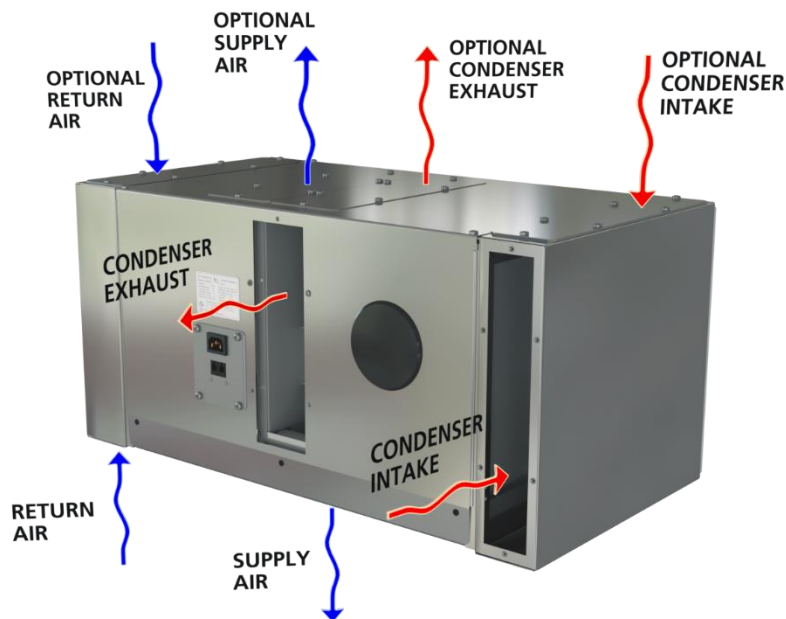



WARNING



RISK OF PERSONAL INJURY OR DAMAGE TO EQUIPMENT

Modification to the equipment may cause injury or damage to the equipment



DANGER



- ✓ **This equipment is heavy. Place the unit on the floor or on a level and stable surface that can support the full weight of the unit.**
- ✓ **Do not modify the equipment, it may cause damage to the equipment and voids the warranty.**
- ✓ **Never place anything on top of the unit.**
- ✓ **Never block or cover any of the openings or outlets to the unit.**
- ✓ **Never allow anything to rest on or roll over the power cord.**
- ✓ **Never place the unit where the power cord is subject to wear or abuse.**
- ✓ **Do not use extension cords.**
- ✓ **Never overload wall outlets.**
- ✓ **Do not remove or open any cover unless the unit is turned off and the power cord is plugged in.**
- ✓ **Use only dedicated power outlet boxes of the correct capacity and configuration for the unit model.**



CAUTION



RISK OF PERSONAL INJURY OR DAMAGE TO EQUIPMENT

Improper installation may result in the equipment malfunctioning and a safety hazard. Read all of the installation instructions before installing the Wine Guardian unit

Planning the Installation

Tools required



- ✓ Where to locate the unit? *Above the cabinet or below the cabinet.*
- ✓ How to mount above or below the unit? *Where the supply/return opening are located.*
- ✓ Locate the electrical power outlet close to the unit, above cabinet or below. **Do not use an extension cord!**
- ✓ Does the condenser heat exhaust need to be ducted away? *An optional duct collar is available.*
- ✓ Where to locate the remote interface control? *Remote interface controls should be located midpoint on a wall within the wine cabinet and provide sufficient access and exposure to airflow.*
- ✓ Are all the parts here to complete the installation? *Gasket, duct collars, fasteners*

Performing a Pre-installation Check

- ✓ Check for the properly sized breaker as dictated by the system rating plate data.
- ✓ Is the cabinet built with adequate insulation and vapor barriers?

Locating the system

The Wine Guardian cabinet system can be mounted either above or below the cabinet. Coordinate supply and return air openings on the Wine Guardian System with that of the cabinet so that air is directed as needed in and out of the system without obstruction. Multiple condenser intake and exhaust locations provides flexibility in directing warm air in and out of the unit from ambient spaces. Gasket material is provided with the unit to assist in sealing the system to the cabinet enclosure.

Power cord location

The power cord is located at the side of the unit adjacent to the com port area. The Wine Guardian system ships complete with six (6) feet of 120 volt, 1phase, 6hz. removable power cord.

Evaporator Connections

Step 1 – locate supply and return opening penetrations at the cabinet ceiling (or floor if mounting unit below) and ensure the Wine Guardian system will fit location and match to the openings provided. If locations do not match to the openings at the Wine Guardian system then you may be required to install optional duct collars and ductwork to connect to the appropriate supply/return locations.

Step 2 - Top mount – place the foam gasket pad above the cabinet (on top of the ceiling) and position the openings in the gasket so that they coincide with the supply and return openings of the cabinet.

Bottom mount – re-locate the solid panels that cover the supply and return air openings on the top of the unit to the bottom of the unit. Next place the foam gasket on top of the Wine Guardian unit and align the two openings in the gasket with the supply and return openings on the unit.

Step 3 – Top mount – place the Wine Guardian system on top of the gasket and position the supply and return openings over the corresponding openings in the gasket so the penetrations line up with the cabinet. Please note that you may need to adjust the position of the gasket and Wine Guardian system so that openings line up with each other and the cabinet structure.

Bottom mount – place the unit beneath the cabinet and adjust the position of the unit and gasket so that it lines up with the openings in the wine cabinet. Add shims or wooden supports under the unit so that the top of the Wine Guardian system is tight to the bottom of the cabinet and the gasket is compressed for a tight seal.

You may need to duct tape the inside of the opening between the wine cabinet, gasket and Wine Guardian unit so that the air way is sealed. This can be accomplished by applying the tape from inside of the cabinet.

Step 4 – Determine the ideal location to mount the Wine Guardian Remote Interface Controller within the wine cabinet and mark its mounting hole locations for future reference.

Step 5 - Route the RJ9 control cable provided with the Wine Guardian system from the cooling unit into the cabinet and to the location determined in step 4. Depending upon the construction of the cabinet you may need to drill a hole within the top or bottom of the cabinet to route the control wire to its controller location. Minimum hole diameter is 7/6" (2 cm) and the hole should be sealed once the wire has been installed. You may wish to hide the wire behind trim or in areas that are covered with lighting or racking.

Step 6 – install two screws at the mounting location of the Remote Interface Controller. Connect the RJ9 control wire to the back of the Remote Interface Controller and attach the controller to the cabinet at the screw locations by inserting them into the back of the controller and sliding the controller down so that it is seated.

Condenser Connections

Step 1 – Determine locations within the cabinet (front, side(s), top or back) where condenser air intake and exhaust will be connected. Optional duct collars and ductwork may be required for proper venting.

Step 2 – Condenser air intake can be connected at the top, front or back of the Wine Guardian cabinet system. Connect optional duct collar to one (1) of these three locations.

Step 3 – Connect 6" (15.24 cm) round ductwork to the duct collar and position the ductwork to the desired air intake location on the cabinet.

Step 4 – Condenser air exhaust can be connected at the top, front or back of the Wine Guardian cabinet system. Connect optional duct collar to one (1) of these three locations.

Step 5 - Connect 6” (15.24 cm) round ductwork to the duct collar and position the ductwork to the desired air exhaust location on the cabinet.

Turning on system

Step 1 - Plug the female end of the power cord into the connection at the Wine Guardian unit and the receptacle end into a 120 volt, 1 ph, 60 hz, (220 volt, 1 ph, 50 hz. for WGCAB25) dedicated circuit.

Step 2 – Turn the system on at the Remote Interface Controller by touching the on/off button once. You should hear the system turn-on and start to deliver cold air to the cabinet.

Step 3 – Visually inspect the installation for any air leaks at the supply and return locations.

Step 4 – Check system set point at Remote Interface controller by touching the any button on the touch screen to wake the system up. Once the display is bright touch the up arrow button to display the temperature set point. Adjust as needed to your preference.

Step 5 – The Wine Guardian cabinet system is now installed and should cool the cabinet to your desired set point. Please note that initial run time may vary depending upon the loading of wine and its initial temperature. Once the cabinet and wine is brought to set point normal run time should be 15 to 20 minutes per hour.

Wiring the System for Power



ELECTRICAL SHOCK HAZARD

The electrical outlet and wiring installation must meet the national and local building codes.

DO:

- ✓ Match the electrical outlet to the plug provided on the Wine Guardian.
- ✓ Provide dedicated circuit and wiring for the system.
- ✓ Match the wiring and breaker size to the rated load as shown on the serial plate and in this guide. See sample serial plate illustration below.

P/N: 99H0381-00	WG	Serial #: 20-06-152
Model #: CAB018	<small>WINE GUARDIAN</small>	Rev: A
Electrical	115/1/60	Electrical Heat Amps (w/opt) 4.35
Locked Rotor Amps	28.2	Crankcase Htr Amps (w/opt) N/A
Compressor RLA	3.92	Min. Circuit Amps (w/opt) 6.3
Condenser Fan Amps	0.7	Test Pressure 275 psi
Evaporator Fan Amps	0.7	Refrigerant R-134A
Total Unit Amps (w/opt)	5.32	System Charge 10 oz
7000 Performance Dr. North Syracuse NY 13212 help.wineguardian.com		
<small>U.S. Pat. No. D634,760 S / Mexico Reg. No. 33191 / Canada 130465</small>		
<small>Intertek Conforms to UL STD 1995 59373 Certified to CAN/CSA STD C22.2 NO. 236</small>		

DO NOT:

1. DO NOT MODIFY THE PLUGS IN ANY WAY!
2. Do not use extension cords.

IMPORTANT

The electrical power supply must be 115-volt AC 1 phase 60 cycle (240-volt AC 1 phase 50 cycle), depending on the model of the system, and cannot vary more than +/- 4% or damage may occur to the unit.



Plug the system into the wall outlet. Gently pull on the cord to ensure it is tight.

Electrical Plug Configuration 60Hz Models Only



Detachable UL/CSA 120 volt/1ph/60 hz. power cord rated for 15 amp service with NEMA 5-15P type plug and IEC 60320 C-13 Connector type at Wine Guardian unit. Power cord is 80" long and includes an SJT 3 wire 14-gauge cable. Color: Black. RoHS compliant.

Electrical Plug Configuration 50Hz Models Only



Detachable 250 volt/1ph/50 hz. power cord rated for 10 amp service with CEE 7 Sheet VII type plug and IEC 60320 C-13 Connector type at Wine Guardian unit. Power cord is 80" long and includes an H05VV-F 3 wire 1.00 sq.mm cable. Color: Black. RoHS compliant.

Starting-up and Operating the Wine Guardian

Control Settings



The control has been wired and set up in the factory for testing with default settings. It is an electronic digital thermostat for one-stage cooling. No additional adjustments should be necessary except adjusting the cellar temperature to your preference. If additional adjustments or changes are necessary, please refer to the configuration settings section in this manual.

Controller Functions

ON/OFF – The ON/OFF button will be used to turn the system on or off. When set to the off mode the control will not allow any of the outputs to energize effectively locking the system out. It will not allow any outputs to energize until the system is turned on with the ON/OFF button. It should be noted that high voltage will still be present at the main control board when the system is set to off even though the control will not allow it to switch to the outputs.

UP Arrow – The UP arrow will allow the user to increase settings.

DOWN Arrow – The DOWN arrow will allow the user to decrease settings.

SETTINGS – The setting button will be used to select between HEAT, COOL and AUTO MODE, as well as entering the configuration settings. Holding the SETTINGS button for 5 seconds will enter configuration mode. Once in configuration mode the user can adjust settings by pressing the UP or DOWN arrows. Pressing the SETTINGS button once will advance to the next configuration settings. Holding the SETTINGS button for 5 seconds while in configuration mode will store all changes and exit configuration mode.

For cooling operation only: Cooling for **60Hz models** is set at 55°F from the factory and 13°C for **50Hz models**. This can be changed by hitting the UP or DOWN arrow, but please refer to configuration settings # 2 and # 3 for limitations in comparison to the High and Low temperature alarm settings.

For units with optional humidifier controlled by TTW WG: The RH% is factory set at 55%. This can be changed by referring to configurations setting # 6. If no humidifier is attached, the control will read RH%, but will not be controlling it.

Changing fan operation: The default setting from the factory is “AUTO” fan. If desired it can be changed to fan “ON” by accessing configuration setting # 7.

~WARNING~





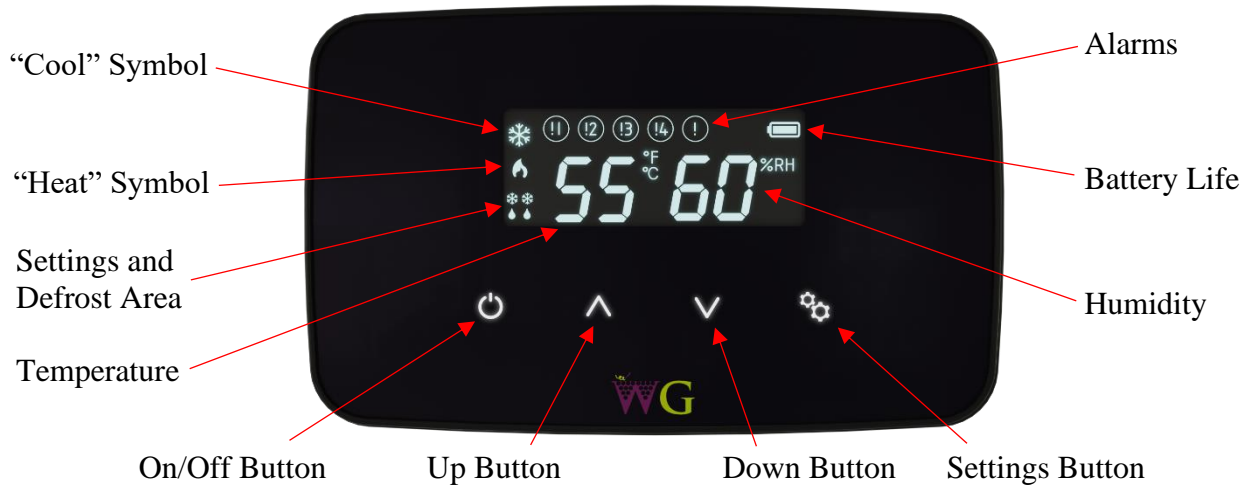

Air movement though an unsealed opening in the wall will cause condensation damage to the controller. Use durable tape to seal the opening in the wall after applying insulation around the wire in the opening.



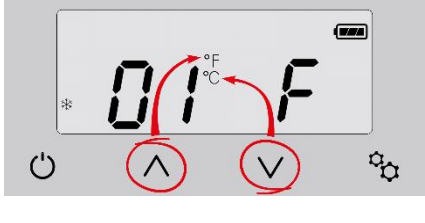

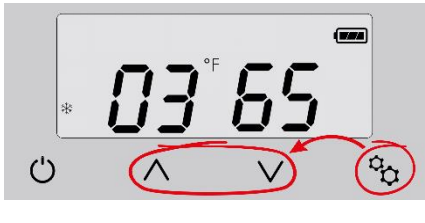
Standard Controller Functions

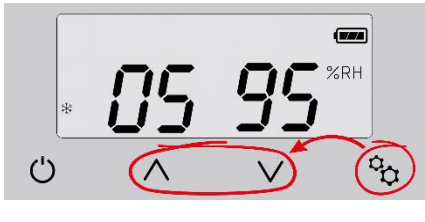



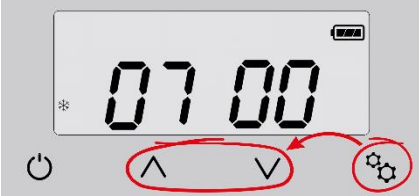



<i>How to:</i>		
Turn system on/off		<ul style="list-style-type: none"> Press the “On/Off” button once. <p>Note: There is a five (5) minute time delay before the system turns on or turns off.</p>
Change temperature		<ul style="list-style-type: none"> Press the “Up” arrow once. The display will show the existing temperature setpoint. Press the up or down arrow buttons to adjust the temperature to the desired set point.
Change humidity		<ul style="list-style-type: none"> Press the “Up” arrow once. This display will show the existing temperature setpoint. Press the “Settings” button once to display the “Humidity” setpoint. Press the “Up” or “Down” arrows to adjust the humidity to the desired set point. <p>Note: A Wine Guardian humidifier must be installed and Setting 6 set to “1” or “2” before the controller will let you change percent humidity.</p>
Change Settings Cooling/ Heating / Auto		<ul style="list-style-type: none"> Press the Setting button once to display the setting function at the bottom of the screen. Press the Settings button again to scroll through settings for cool only, heat only or heat/cool only – auto mode.

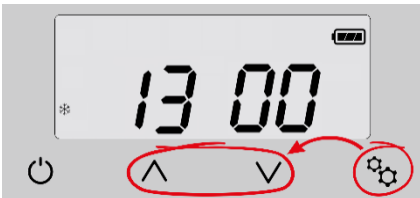

Settings – Press and hold the “Settings” button for five (5) seconds to access the following settings.



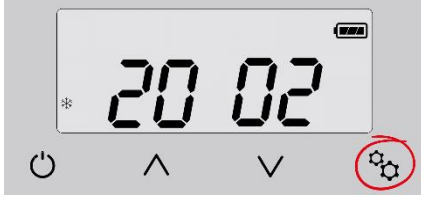

<p>Degrees F or Degrees C</p>		<p>Setting 1</p> <ul style="list-style-type: none"> • Press the “Up” arrow to change temperature from °F to °C. • Press the “Down” arrow to change temperature from °C to °F.
<p>Low temperature alarm setpoint</p>		<p>Setting 2</p> <ul style="list-style-type: none"> • Press “Settings” button to advance to Setting 2. • Press the “Up” or “Down” arrow buttons to adjust to the desired setpoint. Factory default is 50°F (10°C).
<p>High temperature alarm setpoint</p>		<p>Setting 3</p> <ul style="list-style-type: none"> • Press “Settings” button to advance to Setting 3. • Press the “Up” or “Down” arrow buttons to adjust to the desired setpoint. Factory default is 65°F (18°C).
<p>Low humidity alarm set point</p>		<p>Setting 4</p> <ul style="list-style-type: none"> • Press “Settings” button to advance to Setting 4. • Press the “Up” or “Down” arrow buttons to adjust to the desired setpoint. Factory default is 5%.
<p>High humidity alarm setpoint</p>		<p>Setting 5</p> <ul style="list-style-type: none"> • Press “Settings” button to advance to Setting 5. • Press the up or down arrow buttons to adjust to the desired setpoint. Factory default is 95%.
<p>Add or remove humidifier</p>		<p>Setting 6</p> <ul style="list-style-type: none"> • Press “Settings” button to advance to Setting 6. • Press the “Up” or “Down” arrow buttons to adjust to the desired setpoint. Factory default is zero (0). <p>Zero (0) = No humidifier One (1) = Integral Wine Guardian mounted humidifier Two (2) = Stand-alone remote mounted humidifier</p>

<p>Fan AUTO or ON</p>		<p>Setting 7</p> <ul style="list-style-type: none"> • Press “Settings” button to advance to Setting 7. • Press the “Up” or “Down” arrow buttons to adjust number to the desired set point. Factory default is zero (0). <p>Zero (0) = Auto–fan only turns on when there is a call for cooling or heating One (1) = Fan On–fan remains on continuously</p>
<p>Compressor anti-short cycling</p>		<p>Setting 8</p> <ul style="list-style-type: none"> • Press “Settings” button to advance to Setting 8. • Press the “Up” or “Down” arrow buttons to adjust to the desired time in one-minute increments. Maximum is 10 minutes, minimum is 3 minutes. Factory default is 5 minutes. <p>Compressor anti-short cycling time is the amount of allowable time between compressor stop and restart. Rapid start/stop of compressors can cause premature failure.</p> <p>WINE GUARDIAN DOES NOT RECOMMEND SETTINGS LOWER THAN FACTORY DEFAULT.</p>
<p>Defrost sensor enable/disable</p>		<p>Setting 9</p> <ul style="list-style-type: none"> • Press “Settings” button to advance to Setting 9. • Press the “Up” or “Down” arrow buttons to adjust to the desired setpoint. <p>1 will equal enabled and a 0 (zero) will equal disabled.</p>
<p>Defrost cut-in temperature</p>		<p>Setting 10</p> <ul style="list-style-type: none"> • Press "Settings" button to advance to Setting 10. • Press the “Up” or “Down” arrow buttons to adjust to the desired setpoint. This setting is adjustable from 25°F to 40°F. Factory default is 39°F. <p>There must be at least a 1°F difference between defrost cut-in and cut-out set points.</p>

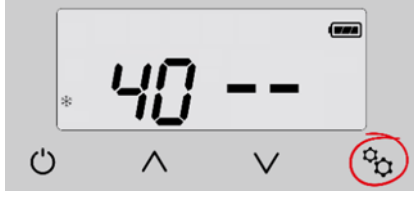
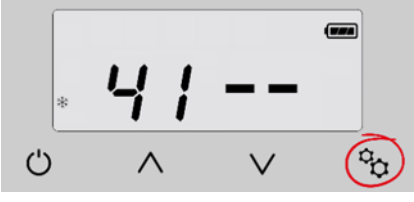
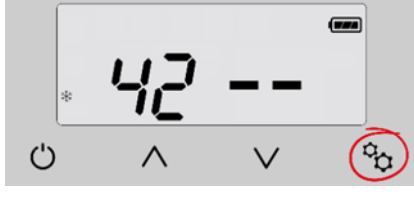

<p>Defrost cut-out temperature</p>		<p>Setting 11</p> <ul style="list-style-type: none"> • Press "Settings" button to advance to Setting 11. • Press the "Up" or "Down" arrow buttons to adjust to the desired setpoint. This setting is adjustable from 35°F to 50°F. Factory default is 40°F. <p>Note: This setpoint must be 1°F/°C higher than setting 10.</p> <p>Note: If °C is selected and then switched back to °F the default cut-out will change to 41°F.</p>
<p>Defrost check interval</p>		<p>Setting 12</p> <ul style="list-style-type: none"> • Press "Settings" button to advance to Setting 12. • Press the "Up" or "Down" arrow buttons to adjust to the desired setpoint. This setting is adjustable from 30 min at 0 (zero), 1 hour at 1, and then in 1 hour increments up to a maximum of 12 hours at 12.
<p>Room temperature offset</p>		<p>Setting 13</p> <ul style="list-style-type: none"> • Press "Settings" button to advance to Setting 13. • Press the "Up" or "Down" buttons to adjust to the desired set point. Maximum setting is +5°F, minimum setting is -5°F. Factory default is zero (0). <p>Room temperature offset changes the actual display reading (temperature only) by the value of this setting.</p> <p>Example: Sensor reading = 55°F (13°C) Setting 13 set to +4 Display reading = 59°F (15°C)</p>
<p>RH offset</p>		<p>Setting 14</p> <ul style="list-style-type: none"> • Press "Settings" button to advance to Setting 14 • Press the "Up" or "Down" buttons to adjust to the desired setpoint. This setting allows the adjustment of %RH reading by +/-10%. Factory default is 0%RH.

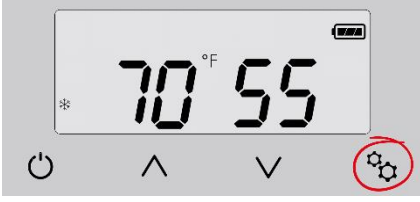
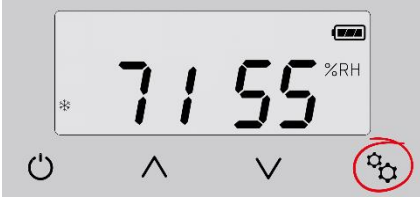
Differential temperature adjustment		Setting 15 <ul style="list-style-type: none"> • Press “Settings” button to advance to Setting 15 • Press the “Up” or “Down” buttons to adjust to the desired setpoint. This setting changes the system/compressor turn-on temperature above setpoint. Factory default is 1°F. <p>Example: Sensor reading = 55°F (13°C) Setting 15 set to +3°F System/compressor turns on at 58°F (14°C)</p>
Temperature deadband		Setting 16 <ul style="list-style-type: none"> • Press “Settings” button to advance to Setting 16. • Press the “Up” or “Down” buttons to adjust to the desired setpoint. This setting is the minimal allowable temperature difference between heating and cooling setpoints. Maximum is 5°F (3°C), minimum is 1°F (1°C). Factory default is 2°F (1°C).
Condensate switch		Setting 17 <ul style="list-style-type: none"> • Press “Settings” button to advance to Setting 17. • Press the “Up” or “Down” buttons to adjust to the desired setpoint. This setting disables or enables the Condensate switch. 0 (zero) is disabled, 1 is enabled. Factory default is 0.
Reserved		Settings 18 & 19 Reserved for additional fields.
System type defaults		Setting 20 System setting. DO NOT CHANGE.
Reserved		Settings 21-29 Reserved for additional fields.

<p>Define remote user interface</p>		<p>Setting 30</p> <ul style="list-style-type: none"> • Press “Settings” button to advance to Setting 30 • Press the “Up” or “Down” buttons to adjust to the desired setpoint. <ul style="list-style-type: none"> 1 = Remote User interface #1 mounted within the wine room space and enabled 2 = Remote User interface #2 mounted within the wine room space and enabled 3 = Remote User Interface #1 disabled - will display only and can be mounted outside of wine room 4 = Remote User Interface #2 disabled - will display only and can be mounted outside of wine room
<p>RF channel select</p>		<p>Setting 31</p> <ul style="list-style-type: none"> • Press “Settings” button to advance to Setting 31. • Press the “Up” or “Down” buttons to adjust to the desired setpoint. Each system needs all devices to be on the same RF channel. <ul style="list-style-type: none"> 0 = RF disabled - system must be hardwired 1 through 12 = RF enabled and 12 channels available
<p>Reserved</p>		<p>Settings 32-39 Reserved for additional fields.</p>
<p>Thermistor 1 N/A</p>		<p>Setting 40 NOT AVAILABLE Reserved for thermistor</p>
<p>Thermistor 2 N/A</p>		<p>Setting 41 NOT AVAILABLE Reserved for thermistor</p>
<p>Thermistor 3 N/A</p>		<p>Setting 42 NOT AVAILABLE Reserved for thermistor</p>

Thermistor 4		Setting 43 <ul style="list-style-type: none"> Press “Settings” button to advance to Setting 43. No setting adjustment. Displays the defrost sensor temperature.
Reserved		Setting 44-49 Reserved for additional fields.
Output test		Setting 50 <ul style="list-style-type: none"> Press “Settings” button to advance to Setting 50. Press the “Up” or “Down” buttons to adjust to the desired setpoint. Steps through relays as output test. 0 = Disabled 1 = Enabled
Reserved		Setting 51-69 Reserved for additional fields.
Default temperature		Setting 70 <ul style="list-style-type: none"> Press “Settings” button to advance to Setting 70. No setting adjustment. Initial temperature set point. Will revert to this setting upon loss of power.
Default %RH		Setting 71 <ul style="list-style-type: none"> Press “Settings” button to advance to Setting 71. No setting adjustment. Initial relative humidity set point. Will revert to this setting upon loss of power.
Default mode		Setting 72 <ul style="list-style-type: none"> Press “Settings” button to advance to Setting 72. Press the “Up” or “Down” buttons to adjust to the desired setpoint. Initial mode set point. Will revert to this setting upon loss of power. 1 = Auto 2 = Cool 3 = Heat

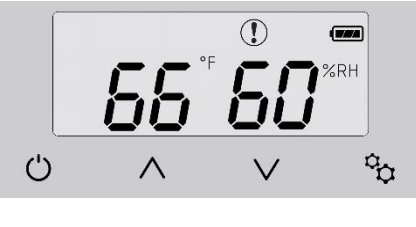
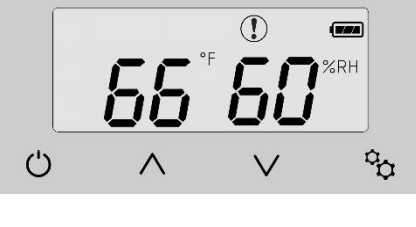
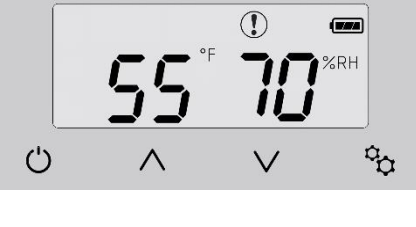
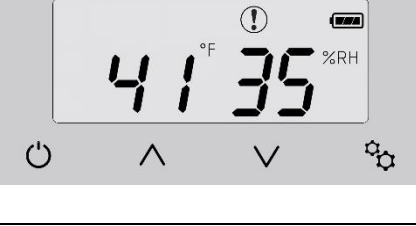
Alarm Codes

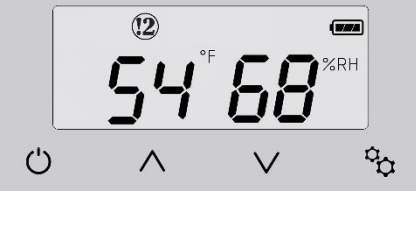
<p>High temperature alarm Flashing temperature number</p>		<p>Flashing temperature number along with (!) symbol will remain on screen until temperature falls below the High Temperature Alarm set point (Setting 3).</p>
<p>Low temperature alarm Flashing temperature number</p>		<p>Flashing temperature number along with (!) symbol will remain on screen until temperature rises above the Low Temperature Alarm set point (Setting 2).</p>
<p>High humidity alarm Flashing humidity number</p>		<p>Flashing humidity number along with (!) symbol will remain on screen until humidity falls below the High Humidity Alarm setpoint (Setting 5).</p>
<p>Low humidity alarm Flashing humidity number</p>		<p>Flashing humidity number along with (!) symbol will remain on screen until humidity rises above the Low Humidity Alarm set point (Setting 4).</p>
<p>!1 = High Pressure Switch Fault</p>		<p>THIS ALARM FORCES THE SYSTEM TO SHUT DOWN (!1) will remain on screen until the High Pressure reset switch has been reset. See the trouble shooting guide page 57 for “Instructions to Reset High Pressure Switch”.</p>
<p>!2 = CS (Condensate Switch Fault)</p>		<p>THIS ALARM FORCES THE SYSTEM TO SHUT DOWN (!2) will remain on screen until the CS (condensate switch) fault is resolved and reset.</p>

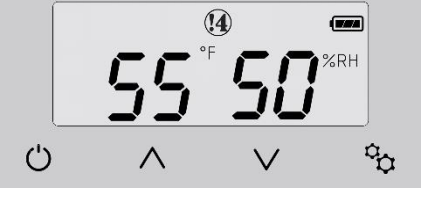
<p>!3 = Defrost Sensor Fault</p>		<p>THIS ALARM FORCES THE SYSTEM TO SHUT DOWN</p> <p>Defrost sensor has been shorted, disconnected or open. (!3) will remain on screen until the defrost sensor issue has been resolved.</p>
<p>!4 = Communication loss</p>		<p>THE SYSTEM REMAINS OPERATIONAL DURING THIS ALARM</p> <p>Bad or no data transfer between sensing device and main control board. “!4” will remain on screen until communication is re-established.</p>

!WARNING!

Only one Unit can be set up at a time. Ensure other units are unplugged while pairing a unit to ensure there are no communication issues between Wine Guardian Units

Installing the Optional Remote Interface Controller and Communication Cable



The Wine Guardian Wireless-to-base Remote Interface Controller is a combination temperature and humidity controller with single stage cooling, heating and humidity control. It's capacitive touch screen incorporates an on/off switch, adjustment arrows and settings buttons for ease of use and programming. The controller can be installed one of two

ways:

Wired (recommended) – wired directly to the Wine Guardian unit through an RJ-9 communication cable. 50' (15.25 meters) of control cable is included with each controller with longer lengths available as an option.

IMPORTANT

Whenever possible we strongly suggest wiring the Remote Interface Controller directly to the Wine Guardian unit to avoid periodic battery changes and uninterrupted service.

Wirelessly - connects wirelessly to the Wine Guardian unit by Radio Frequency connectivity through one of twelve selectable channels.

IMPORTANT

Wireless installation may result in limited communication range and connectivity issues depending upon building construction and distance between Wine Guardian unit and Remote Interface Controller and/or Remote Sensors.

The Wine Guardian Wireless-to-base Remote Interface Controller is a configurable device that can be fine-tuned through a series of individual settings. The controller incorporates eight (8) key temperature, humidity and system alarm points. Remote alarm indication is possible through terminal point connections at our main control board.

In most applications, the remote interface controller will be mounted within the wine cellar. The remote interface controller can also be mounted directly outside of the wine cellar or in any other room of the home or building. When mounted outside of the wine cellar, a remote sensor kit or a second wireless remote interface must be purchased and installed within the wine cellar.

IMPORTANT

Regardless of wired or wireless each, Wine guardian System can have a maximum of two (2) Remote Interface Controllers and three (3) Remote Sensors.

~WARNING~

Air movement through an unsealed opening in the wall will cause condensation damage to the controller. Use durable tape to seal the opening in the wall after applying insulation around the wire in the opening.

Additional Remote Interface:

If adding more than one remote interface to the system, you will have to change setting 30 at each remote user interface controller to define its use. Refer back to page [27](#) for instructions on how to access the interface Settings, and get to Setting 30 (shown on page 32).

Controller Specification

Application	WG only, single stage cooling or heating Humidification
Programmable	No
Change over	Auto or manual, Fan ON or AUTO
Color	Black (only)
User interface	Touch screen
Auto defrost control	Yes, with Serving temp option
Connection	Communicating – RJ-9 cable
Wireless-to-base communication range	40' line of site
Wireless-to-base channels	12
Remote sensors	Yes, wired or wireless
Temperature adjustment	34 to 97 Deg F (1 to 36 Deg C)
Temperature tolerance	+/- 2 Deg F (+/- 1.1 Deg C)
Humidity adjustment	2% to 93% RH
Humidity tolerance	+/- 10% RH
System temperature diagnostics	Not available
Alarms	High temp, low temp. High humidity, low humidity. High pressure fault. Condensate, Defrost and Communication error

Mounting the Optional Remote Interface Controller (Wired)



Fig. 1



Fig. 2



Fig. 3



Fig. 4



1. Disconnect the communication cable from the Wine Guardian unit and the remote interface controller. (Fig. 1)
 - a. Route the communication cable within the wall and/or ceiling structure of the wine cellar to the desired controller mounting location.
 - b. Plan on mounting the remote interface controller on a solid surface away from doors, corners, air outlets, drafts or heat generating equipment. Do not mount the remote interface controller directly on an outside wall, a wall adjacent to a boiler room, or other hot area. Use a piece of foam insulation behind the sensor to insulate it from a hot or cold surface. The recommended height is four to five feet above the finished floor.
2. Remove the back plate of the controller (Fig. 2) by removing two (2) screws that hold it in place on the remote interface. Place the back plate against the wall and mark the location of the two mounting points (Fig. 3). Also mark the location of the penetration for the communication cable as this area will require sufficient clearance for the cable to exit the wall and attach to the back of the controller.
3. Drill two one-eighth inch holes and insert anchors at the marked locations. Anchors may not be required if securing to a wall stud or racking system. Insert the screws into the holes and test fit the backing plate to ensure it mounts easily onto the two screws and slides down onto the slotted opening freely (Fig. 4).
4. Re-install plastic face plate on to backing plate.
5. Plug in the communication cable to the back of the remote interface controller backing plate. (Fig. 5)
 - a. If using multiple Remote Interfaces either connect each Sensor to each other in series using RJ-9 cable or purchase a RJ-9 Splitter to be used on the unit.
6. Attach the Controller to the wall

Mounting the Optional Remote Interface Controller (Wireless)



Fig. 1



Fig. 2



Fig. 3



Fig. 4

1. Disconnect the controller wire from the side of Wine Guardian unit and save for future use.
2. Plan on mounting the remote interface controller on a solid surface away from doors, corners, air outlets, drafts or heat generating equipment. Do not mount the remote interface controller directly on an outside wall, a wall adjacent to a boiler room, or other hot area. Use a piece of foam insulation behind the sensor to insulate it from a hot or cold surface. The recommended height is four to five feet above the finished floor.
3. Unscrew and remove the back plate from the Remote Interface Controller (Fig. 1)
4. Place the back plate against the wall and mark the mounting points at the desired location. (Fig. 2)
5. Drill two one-eighth inch holes and insert anchors within the mounting surface. Anchors may not be required if securing to a wall stud or racking system. Insert the screws into the holes and test fit the backing plate for mounting to ensure it mounts easily onto the two screws and slides down onto the slotted openings freely (Fig. 3)
6. Reattached the back plate to the Remote Interface Controller. (Fig. 4)
7. Insert the three AA batteries.
(only applicable with wireless installations)
8. The system will automatically acknowledge a wireless device (Remote Interface or Remote Sensor). Go to Setting “30” to define the Remote User Interface use.
9. Attach controller to the wall.

Installation of the Optional Wine Guardian Remote Sensor



The wireless remote sensor is a combination temperature and humidity sensor only. It is designed to be mounted within the wine cellar and can be used in combination with the remote interface controller or up to two additional remote sensors to read and control multiple areas within the wine cellar.

For a wired application you will require a RJ-9 communication cable.

Mounting the Wired Remote Sensor (Wired)



Fig. 1



Fig. 2

1. Disconnect the communication cable from the back of the Wine Guardian unit and the remote sensor. Route the communication cable within the wall and/or ceiling structure of the wine cellar to the desired controller mounting location.
2. Plan on mounting the remote sensor on a solid surface away from doors, corners, air outlets, drafts or heat generating equipment. Do not mount the remote sensor directly on an outside wall, a wall adjacent to a boiler room, or other hot area. Use a piece of foam insulation behind the sensor to insulate it from a hot or cold surface. The recommended height is four to five feet above the finished floor.
3. Remove the remote sensor's face plate (Fig. 1) and mark the mounting points at the desired location within the wine cellar (Fig. 2). Also, mark the location of the communication cable connection as this area will require sufficient clearance, for the cable to exit the wall and attach to the back of the sensor.



Fig. 3



Fig. 4



Fig. 5

4. Drill two one-eighth inch holes and insert anchors within the mounting surface. Anchors may not be required if securing to a wall stud or racking system. Insert the screws into the holes and test fit the backing plate for mounting to ensure it mounts easily onto the two screws and slides down onto the slotted openings freely. (Fig. 3)
5. Plug in the communication cable to the remote sensor and mount the Remote Sensor to the wall. (Fig. 3)
6. Reattach the sensor's faceplate (Fig. 4)
7. If multiple sensors are being used either connect each Sensor to each other in series using RJ-9 cable or purchase a RJ-9 Splitter (Fig. 5) to be connected to the unit.

NOTE: Remote Sensor's will always be treated as "enabled" when hardwired. Their temperature and humidity readings will always be calculated towards the average by the system.

Mounting the Remote Sensor (Wireless)



Fig. 1



Fig. 2



Fig. 3



Fig. 4



Fig. 5

1. Disconnect the controller wire from the side of Wine Guardian unit and save for future use.
 2. Plan on mounting the remote sensor on a solid surface away from doors, corners, air outlets, drafts or heat generating equipment. Do not mount the remote sensor directly on an outside wall, wall adjacent to a boiler room, or other hot area as this runs the risk of influencing its temperature readings. The recommended height is four to five feet above the finished floor.
 3. Remove the sensor face plate (Fig. 1). Mark the mounting points at the desired location within the wine cellar (Fig. 2).
 4. Drill two one-eighth inch holes and insert anchors within the mounting surface. Anchors may not be required if securing to a wall stud or racking system. Insert screws to secure the sensor to the wall to ensure it mounts easily onto the two screws and slides down onto the slotted openings freely.
 5. Input the three AA batteries. (Fig. 3)
(only applicable with wireless installations)
 6. Pair the sensor with the unit
(See Page 46 for Pairing Instructions)
- NOTE: Once Paired the Remote Interface's readings will be included into the system's temperature and humidity averages.***
7. Mount the Remote Sensor on the wall (Fig. 4)
 8. Reattach the sensor's faceplate (Fig. 5)

Remote Sensor Pairing Instructions – Multiple Sensors (Wireless)



Fig. 1



Fig. 2

If using multiple remote temperature/humidity sensors in your application, refer to the figures and the procedure below to change each remote sensor's device number (Three Remote Sensors maximum). Each Remote Sensor must have its own device number and must also be on the same RF channel (Setting 31) as the system they are being paired with.

1. To change the remote sensor's device number, see the following instructions:
 - a. Use a pin to press the button for about half a second and release (Fig. 1).
 - b. Observe the LED on the side of the remote sensor (Fig. 2). The LED will flash once for a Device #1, twice for a #2, three times for a #3. At any time, while in this mode press the button once to change the device number. Once each remote sensor has its own unique device number simply wait for the LED to stop flashing and the setting will be saved.
2. To change the remote sensor's RF channel, see the following instructions:

NOTE: Check what RF Channel the System is set to using Setting 31 to more easily connect your Remote Sensors.

- a. Use a pin to press the red button at the back of the Remote Sensor for 5 seconds until the LED blinks rapidly then release the button.
- b. The LED will flash a number of times to portray which RF channel it is set to and repeat a total of 3 times.
- c. To change the RF channel, press the button once to increment the RF channel. There are 12 possible RF channels. All Remote Sensors will need to be on the same channel for the system to detect them. To save the RF channel setting simply wait for the mode to time out by not pressing the button.

Regulating the Cabinet Temperature

To keep the entire cabinet at the same temperature, set the thermostat to run the supply fan continuously, and not just when there is a call for cooling. Set Fan switch to ON instead of AUTO, by accessing configuration setting # 7.

Maintenance



BEFORE PERFORMING MAINTENANCE ON THE SYSTEM, READ AND UNDERSTAND THE SAFETY INFORMATION CONTAINED WITHIN THE SAFETY CHAPTER OF THE WINE GUARDIAN MANUAL.



HIGH VOLTAGE - RISK OF SERIOUS INJURY OR DEATH

High voltages are present in the cabinets. Turn off all power. Use the Lockout/Tagout procedure before removing end panels or cover.



SHARP EDGES RISK OF SERIOUS INJURY

SHARP EDGES ARE PRESENT ON THE FAN WHEELS, HOUSING, INS AND COILS.

Maintenance on Wine Guardian system requires working with high voltage and sheet metal with possible sharp edges. Only qualified personnel should perform maintenance. Some tasks require knowledge of mechanical and electrical methods. Make sure you are familiar with all hazards, general safety related procedures, and safety labels on the system



EXPOSURE TO MICROBIAL GROWTH (MOLD) CAN CAUSE SERIOUS HEALTH PROBLEMS

Standing water in drain pans promote microbial growth (mold) that cause unpleasant odors and serious health-related indoor air quality problems. If mold is found, remove it immediately and sanitize that portion of the system.

The Wine Guardian is designed for minimum maintenance. The refrigerant system is hermetically sealed and requires no maintenance. The fans are permanently lubricated and require no maintenance. Some maintenance to the system may be required due to dust or dirt in the air stream.

Maintenance Schedule

Monthly

(Or quarterly depending on experience with individual cellar)

- ✓ Check for noise or vibration.
- ✓ Check for short-cycling of the system – a turning on and off of the compressor unit more than eight (8) times/hour.

Yearly

(In addition to monthly)

- ✓ Check evaporator and condenser coils for dirt – use a vacuum with a brush attachment to clean the coils.
- ✓ Clean condensate pan under the evaporator coil by flushing. Be careful to keep the drain pans clear of any and all debris.
- ✓ Inspect cabinet for corrosion or rusting – clean and paint.
- ✓ Inspect for dirt buildup on or inside the unit. Clean system by vacuuming or wiping it down.
- ✓ Check for loose insulation, fasteners, gaskets or connections.
- ✓ Check the wiring connections and integrity of cords.
- ✓ Examine condenser duct (if option is used) for any cracks or breach.

High Pressure Switch Has Shut the System Down

Every Wine Guardian system has a manual reset high pressure switch in the refrigeration system. This switch shuts the compressor and condenser down if the head pressure in the system is too high. It is intended to protect the compressor. Restricted airflow through the condenser is the most common reason for the pressure to become too high. This can be caused by dust covering the coil or an obstruction blocking the airflow in the duct or grille.

Possible Cause

Head pressure in unit is too high because an obstruction is restricting air flow through the unit.

Solution

Remove the obstruction in the duct or grille or clean the coil. Then restart the system after resetting the high-pressure switch.

Instructions to Reset High Pressure Switch

- ✓ Turn the Wine Guardian system off at the remote interface controller.
- ✓ Locate the high pressure reset switch behind the circular black plastic cove at the condenser side of the system. The switch has a red push button and is accessible by removing the plastic cover.
- ✓ Locate red push and push in the button until it locks into position.
- ✓ Replace circular black plastic cover.
- ✓ Restart the unit at the control panel remote interface controller.

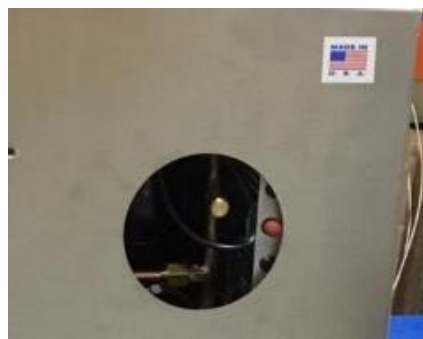

Alarm Annunciation



When an alarm condition occurs, the control will flash the backlight on the display in addition to annunciating the actual fault on the screen. The user can make the backlight flashing stop by pressing a button on the local user interface. However, the alarm annunciation will not actually clear on the display until the fault is corrected.

Troubleshooting



BEFORE PROCEEDING, READ AND UNDERSTAND THE SAFETY INFORMATION CONTAINED IN THE SAFETY SECTION OF THE WINE GUARDIAN MANUAL.

IMPORTANT

This section is intended as a diagnostic aid only. For detailed repair or parts replacement procedures, contact a qualified service company. Check the following table for some solutions before calling a service technician.

Typical Start-up Problems

<i>Possible Cause</i>	<i>Solution</i>
Incorrect thermostat or humidistat	Check the thermostat and humidistat setup for the application. Read the thermostat troubleshoot guidelines in the Thermostat Installation and Operating Instructions.
Changed settings on the thermostat	A common problem is not waiting long enough for the internal timers to complete their timed delay. Allow 5 minutes for compressor to start.

Unit Does Not Start-up

<i>Thermostat light is off</i> <i>Possible Cause</i>	<i>Solution</i>
No power to outlet Unit not plugged in	Check circuit breaker and wiring Plug in the unit
<i>Thermostat light is on</i> <i>Possible Cause</i>	<i>Solution</i>
Remote interface controller is not set up properly	Check remote interface controller set up in the guide

Unit is Operating and Blows Evaporator Air, but the Supply Air is not Colder than the Return Air from the Cellar

Possible Cause	Solution
Remote interface controller not set up properly	Check remote interface controller setup in the manufacture's remote interface controller guide
Compressor not operating	High pressure switch open (button up) (see below)
Condenser airflow is blocked	Remove blockage Clean coil (if needed)
Head Pressure (HP) switch is open	Reset HP switch – <i>see reset instructions on page 45</i>

Problems Controlling Cellar Temperature

***Problems are occurring even though the unit seems to be fully operational – evaporator fan blows air into the cellar and compressor and condenser fans run*

Cellar temperature is low (below 51° when unit is running) Possible Cause	Solution
Remote interface controller set too low on cooling	Reset remote interface controller to higher cooling temperature
Remote interface controller not controlling temperature	Wiring integrity compromised (shorted), replace wiring
Cellar temperature is too cold (below 51°) when unit is not running) Possible Cause	Solution
Too much heat loss to adjacent spaces	Increase insulation around the ductwork and doorways - Add heater
Cellar temperature is too high, but supply air is cold) Possible Cause	Solution
Not enough evaporator airflow	Remove blockage in supply or return Check and clean coil Coil frozen – shut off unit for two hours
Cellar heat loads are too high	Install additional insulation Replace with larger sized unit

Problems Controlling Cellar Humidity

<p><i>Humidity too low or supply air is too cold, without optional Standalone humidifier</i></p> <p><i>Possible Cause</i></p>	<p><i>Solution</i></p>
<p>Not enough evaporator airflow</p> <p>Defective or incorrect expansion device or coils</p>	<p>Remove blockage in supply or return ductwork Check and clean coil Coil frozen – shut off system for two hours</p> <p>Call factory for service</p>
<p><i>Humidity too low, without optional humidifier</i></p> <p><i>Possible Cause</i></p>	<p><i>Solution</i></p>
<p>No moisture being added to cellar</p>	<p>Add Wine Guardian humidifier or room humidifier</p>
<p><i>Humidity too low with optional humidifier –</i></p> <p><i>Possible Cause</i></p>	<p><i>Solution</i></p>
<p>Humidifier not operating</p> <p>Humidifier operating</p>	<p>Check wiring for loose, broke or frayed connections Check humidistat set up Check for water flow & solenoid valve operation</p> <p>Check for water being hot Check drop pad – replace if scaled No vapor barrier installed around cellar</p>
<p><i>Humidity too high when unit is running, but not cooling</i></p> <p><i>Possible Cause</i></p>	<p><i>Solution</i></p>
<p>Compressor not operating</p> <p>Ambient temperature is too high</p>	<p>Check and reset high limit switch Clear blockage of condenser airflow</p> <p>Reduce temperature or draw condenser air from another space</p>

Problems Controlling Cellar Humidity

<i>Humidity too high when unit is not running</i> <i>Possible Cause</i>	<i>Solution</i>
System needs to run to dehumidify	Lower room temperature setpoint. Seal openings around doors (gasket and sweep)
<i>Humidity too high when unit is running and cooling</i> <i>Possible Cause</i>	<i>Solution</i>
Too much moisture in cellar	Poor vapor barrier installation Humidifier malfunction refer to the humidifier instructions Add dehumidifier to surrounding space

Other Miscellaneous Problems

<i>System is leaking water</i> <i>Possible Cause</i>	<i>Solution</i>
Condensate pan plugged	Remove blockage and clean
Unit not level	Level with shims
<i>System is running properly, but the sounds of unit is objectionable</i> <i>Possible Cause</i>	<i>Solution</i>
Noise is from airflow	Duct airflow from condenser to outdoors

Warranty

2 years parts 1 year labor

GENERAL

Wine Guardian warrants, to the original buyer, its goods, and all parts thereof to be free from defects in material and workmanship for a period of two (2) years from the date of invoicing assuming NORMAL USE AND SERVICE.

LIABILITY

Wine Guardian liability shall be limited to the repair or replacement (at its option) of any part, which, at our sole discretion, is determined to be defective. The purchaser shall pay all transportation costs. Additionally, if a malfunction occurs within the first year from the date of invoice, Wine Guardian will reimburse the reasonable cost of labor required for the repair or replacement provided authorization is obtained from one of our authorized representatives prior to incurring any labor charges.

LIMITATIONS OF LIABILITY

THESE WARRANTIES ARE MADE IN LIEU OF ALL OTHER WARRANTIES EXPRESSED OR IMPLIED, INCLUDING ANY IMPLIED WARRANTY OF MERCHANTABILITY OR FITNESS FOR A PARTICULAR PURPOSE AND IN LIEU OF ANY OTHER OBLIGATION OR LIABILITY, INCLUDING LIABILITY FOR ANY INCIDENTAL OR CONSEQUENTIAL DAMAGES. Wine Guardian will not be responsible for any costs or liabilities whatsoever resulting from improper installation or service of its equipment. In the event that Wine Guardian or its distributors are found liable for damage based on any defect or nonconformity in the products, their total liability for each defective product shall not exceed the purchase price of such defective products. No person or representative is authorized to change these warranties or assume any other obligations or liabilities for Wine Guardian in connection with the sale of its systems.

INDEMNIFICATION

Purchaser agrees to indemnify, hold harmless and defend seller and its officers, directors, agents, and employees from and against any and all claims, liabilities, costs and expenses arising out of or related to Purchaser's use of the goods, or in any way involving injury to person or property or accident occasioned by the goods sold by Wine Guardian to Purchaser.

FOREIGN GOVERNMENT AND INDIAN NATIONS

If Purchaser is a foreign government or an Indian nation, Purchaser hereby expressly waives its defense of sovereign immunity in the event of a dispute between Purchaser and Wine Guardian regarding this invoice and Purchaser expressly acquiesces to the jurisdiction of the federal and state courts of the United States.

SEVERABILITY

If one or more of the provisions contained in this contract shall for any reason be held to be invalid, illegal, or unenforceable in any respect, such invalidity, illegality, or unenforceability shall not affect any provision of this contract, but this contract shall be construed as if such invalid, illegal or unenforceable provision had never been contained.

ADDITIONAL REQUIREMENTS

If a defect covered by the Warranty occurs, contact Wine Guardian for authorization to proceed with corrective action. Do not return any parts or incur any charges for which you expect to be reimbursed under this Warranty without receiving this authorization. If parts are replaced under this Warranty, the defective parts must be returned prepaid within 30 days. This warranty shall be null and void in its entirety if the Serial Number on the air conditioner or compressor is altered, removed, or defaced.

Contact Information

Wine Guardian
7000 Performance Drive
North Syracuse, NY, 13212

Web sites: wineguardian.com
Help.wineguardian.com

Email: info@wineguardian.com

Warranty

The Wine Guardian unit serial number is noted on all packing lists and bills of lading and, along with shipping date, is kept on file at Wine Guardian for warranty purposes.

All correspondence regarding warranty must include the model number and serial number of the unit involved. **Note:** that the warranty is null and void if the serial number on the unit or compressor is altered, removed, or defaced. All Inquiries or correspondence regarding warranty should be handled in accordance with the "Warranty" and directed to:

Wine Guardian
7000 Performance Drive
North Syracuse, New York, 13212
Attn: Service Department

This procedure includes but is not limited to

- Obtaining authorization from Wine Guardian prior to incurring any charges for repair or replacement under warranty.
- Or returning prepaid within 30 days any and all defective parts.