



ALMOST HEAVEN
SAUNAS

KIP Heater Installation & Owner's Manual



In addition to reading this manual through to the end before proceeding with assembly,
you may find our instruction video helpful.

You can find it at: [youtube.com/user/almostheavensauna](https://www.youtube.com/user/almostheavensauna)

Read this entire manual through to the end before proceeding with the installation.

HEATER INSTRUCTIONS

Your Almost Heaven Sauna is paired with a genuine Finnish heater manufactured by Harvia Oy, the world leader in sauna heaters. Refer to this guide for installation and operation instructions. **Please note, a licensed electrician should perform all electrical work**, and Almost Heaven Saunas staff is available to assist with any questions you or your electrician may have. Please call us at 888-355-3050 for technical assistance.

PERFORMANCE EXPECTATION

Based on its cubic footage, your sauna kit has been paired with an appropriately sized heater to achieve optimal sauna temperatures. Properly installed, you should expect your KIP heater to consistently heat your sauna to at least 170 F at approximately head height when sitting on the bench. This temperature should be achieved in 45-60 minutes, although this timeframe can be longer depending on the ambient temperature outdoors.

Please note, saunas at elevations greater than 5,000' above sea level may not perform as efficiently as they would at sea level. If you are above this threshold and are not achieving the aforementioned expectations, please contact Almost Heaven Saunas technical support.

HEATER WARRANTY

Your Harvia heater comes with a 1 year warranty on the heating elements, and a 5 year warranty on the other components.

Information for your electrician:

4.5kW and 6.0kW KIP Heaters

- 30-amp double pole breaker
- 240 volts
- 1 Phase
- 10/2 wire. If the distance is greater than 90 feet from the power source, we recommend using an 8/2 wire to accommodate for voltage drop.
- Do not use GFCI with this heater
- Use copper wire with 90C insulation

8.0kW KIP Heaters

- 40-amp double pole breaker
- 240 volts
- 1 Phase
- 8/2 wire
- Do not use GFCI with this heater
- Use copper wire with 90C insulation

POSITIONING YOUR HEATER

Unpack your heater, setting aside the trim pieces and bag with placards and screws (1).



Image 1

Remove the hardware bag from the baggie with the safety placards (2), selecting the two longer lag screws (1.5"). You will secure these into the sauna wall so that 1/4" of the screw protrudes from the wall (3, 4).



Image 2



Image 3



Image 4

a. For **barrel saunas**, the 1 1/2" lag screws should be mounted approximately 20" off the lowest point of the barrel and spaced 15 1/4" apart and centered above the vent holes. **Note:** The heater will conceal a portion of the LED light. This is normal. (5).

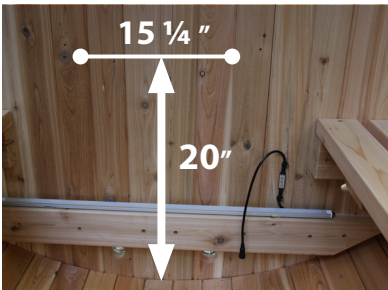

Image 5

b. For **indoor saunas**, the screws should be mounted 20" off the floor, and spaced 15 1/4" apart approximately centered above the vent holes (if present). It is fine that the heater is covering the holes as ventilation still occurs (6).



Image 6

Hang the heater on the mounting screws to ensure it is level and that its base sits 5-7" off the floor of the sauna.

If these criteria are met, make a mark on the wall of the sauna directly behind one of the rubber gaskets on the lower back of the heater (7); this will be where the power enters the sauna. Take the heater off the wall and remove the rubber gasket, exposing the cutout. It does not matter which gasket is removed (8).

NOTE: While this location is the most common, the power can enter the sauna at any location. It is **not** recommended you use the pre-drilled vent holes as an entrance for the conduit.

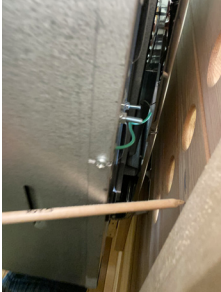

Image 7



Image 8

REMOVING THE STONE GUARD AND BOTTOM COVER

Remove the two screws holding the stone guard in place. Pry the guard back and lift up to remove it. Clip the ziptie holding the metal sensor housing from the elements and set it aside for later installation (9 – 11).



Image 9



Image 10



Image 11

Flip the heater on its back and remove the bottom cover. Locate the 4" temperature sensor, uncoiling the filament and wiring it out the small notch at the base of the heater. Set the sensor aside for later installation (12 – 14).



Image 12

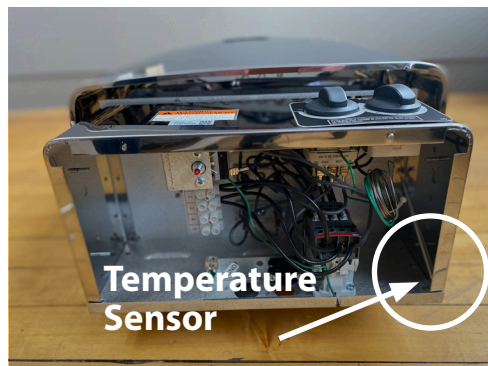

Image 13

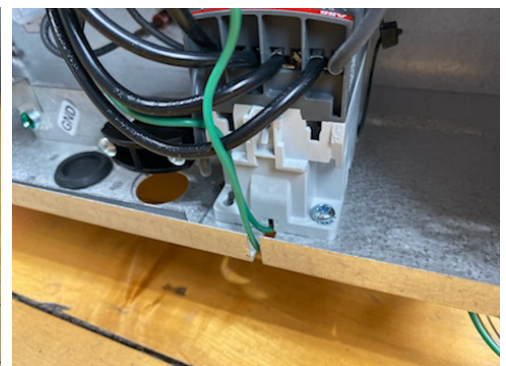

Image 14

CONNECTING TO POWER

All wiring should be done by a licensed electrician.

Bore a hole at the mark you made in step 2, being sure it is wide enough to accommodate the wire (15). Feed the wire through this hole and then through the cutout at the base of the heater (16). Being sure the breaker is off, connect your heater to power according to the diagram below. The only connections that should be made are two hot lines to L1 and L2, and the ground line to the ground screw (17). Replace the bottom cover once wiring is complete, and rehang the heater on the screws (18). Turn the breaker on.



Image 15

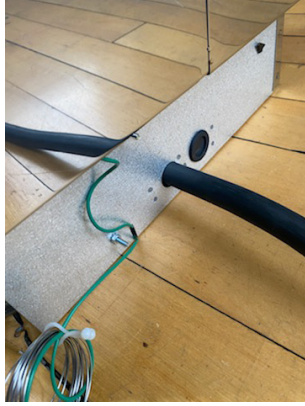

Image 16



Image 17

L1 L2 GND

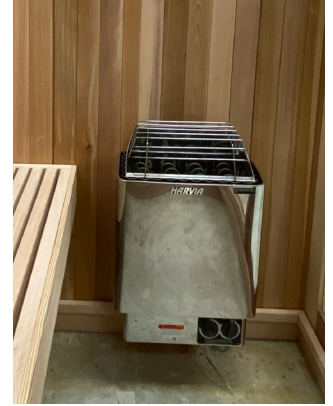

Image 18

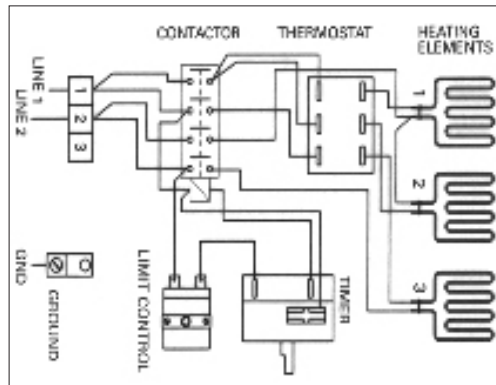
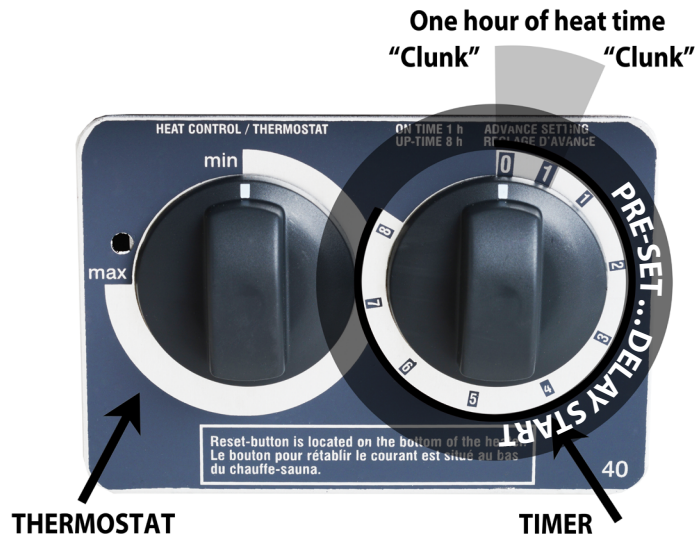

Image 19

NOTE: The power should **not** enter the heater through the cutout on the bottom cover – this cutout is to allow access to the high-limit reset button (19).



OPERATING THE HEATER

This heater is operated using two dials – the thermostat and the timer.

Thermostat (left) controls the temperature of the sauna. Set it according to your personal preference.

Timer (right) turns the heater on and off, and has the ability to delay the start.

If the heater has power, you should hear a loud “clunk” at both the 0 and the large 1. In between these “clunks” is one hour of heat time.

To immediately turn the heater on, we recommend turning the dial past the two clunks to number 1 or 2. Turn the timer back until one loud “clunk” is heard, immediately stopping the turn. This will begin the one hour of heat time.

The heater will automatically shut off after one hour. You may have to restart your heater while you are in the sauna.

The smaller numbers 1-8 refer to the number of hours for the delay start. For example, if you turn the timer to 5, your heater will begin heating in five hours.

With your sauna door open, turn on your heater for five minutes to allow the non-toxic protective coating on the heating elements to “burn off”. It is normal to see some light smoke as this coating burns off.

PLACING THE STONES

While the heater is cooling, rinse your sauna stones to prepare them for placement.

Place the smaller stones in between and around the three heating elements *being sure that the heating elements stay in their original vertical position and do not touch each other*. **The stones should touch the elements, but not bend them.** Reserve the larger stones for placement on top of the heating elements, covering them completely. Replace the stone guard (21, 22).

NOTE: Packing stones in too tightly will restrict airflow and affect the efficiency of your heater. Loosely position the stones around and above the heating elements. It is common to have 5-10 stones left over.



Image 21



Image 22

TEMPERATURE SENSOR PLACEMENT

Mount the sensor housing (the metal component zip tied to the elements in step 1) vertically, 14" to the side of the heater and 14" below the highest point of the sauna. If it is too high on the wall or too close to the heater, it will sense that the sauna is hotter than it actually is, triggering a premature shut off (23).



Image 23

Place the sensor pin in the housing with the bulb upright and close the wings of the housing over the sensor pin (24, 25). Conceal the sensor housing and pin with the sensor cover and provided screw (26).



Image 24



Image 25



Image 26

Conceal the sensor wire with the grooved trim pieces from step 1 (27). You will likely have to cut several trim pieces to fit the distance between your heater and the sensor pin. Mount them with the screws provided in the hardware baggie you removed in step 1.



Image 27

INSTALLING THE (OPTIONAL) HEATER GUARD

Please refer to the separate instructions for details on how to install the heater guard around your heater.

USING YOUR SAUNA HEATER

Your sauna has been paired with an appropriately sized heater to consistently achieve temperatures of 175°-185°F. You should expect your sauna to be at a useable temperature in 45-60 minutes.

You have the option to pour water onto the stones to generate steam. Please note, little water is required to achieve this. For most sauna users, a ladle full of water is sufficient. If too much water is poured onto the stones, it will drip out the base of the heater and should be wiped up with a towel after the sauna session.

If you'd like to continue the sauna session after the automatic one hour shutoff, simply restart the heater.

Consult your sauna manual for the typical sauna routine, and enjoy!

TROUBLESHOOTING

If the sauna heater does not operate after the initial installation:

Check the breaker to be sure it is on

Verify with your electrician that 240 volts is reaching the heater

Double check that the timer is being operated correctly (refer to instructions in step 5)

If the sauna heater operates but the sauna room does not come to temperature:

Verify the timer has not timed out. If it has, restart it.

Assess how the stones are placed around the heating elements. If they are packed too tightly, it will restrict airflow and affect the efficiency of your heater. Reposition the stones if needed.

Check the position of the temperature sensor (refer to step 7a). If it is too high in the sauna or too close to the heater, it will trigger a premature shutoff in your heater.

If your heater no longer makes the loud "clunking" noise when turning the timer, turn off your breaker and use a small screwdriver to press the reset button under the heater. You can find this button in the cut-out on the bottom plate (33).



Image 33

If none of the above recommendations get your heater working, please call Almost Heaven Saunas at 888-355-3050 to diagnose further.



KIP Heater Installation & Owner's Manual

almostheaven.com