



SAFETY IS EVERYONE'S RESPONSIBILITY. ALL DACOR APPLIANCES ARE DESIGNED AND CONSTRUCTED TO GIVE YOU MANY YEARS OF SAFE OPERATION. THE OPERATION WILL BE FURTHER ENHANCED IF PROPER CARE AND JUDGEMENT ARE EXERCISED IN THE USE AND MAINTENANCE OF THIS APPLIANCE.



WARNINGS:

Must be followed carefully to avoid personal injury or damage.



NOTES:

Contains helpful hints and tips.

IMPORTANT INFORMATION

- Operating Instructions
- Care and Cleaning Instructions
- Safety Tips

Please Read Before Using Your Range

Place Serial Number Label Here



Dear DACOR Consumer,

Congratulations! You have purchased the very latest in kitchen appliances. Your new DACOR product offers features, styling and performance not found in any other appliance.

Please read this manual before operating your new appliance. It is imperative that you read the IMPORTANT INSTRUCTIONS section and become familiar with the controls and procedures to understand the full potential of this product.

All DACOR appliances are designed and manufactured to meet the highest quality standards. Each unit is thoroughly tested. Should you have a problem, however, please first check the PROBLEM SOLVING section in this manual. This section contains a checklist of possible problems and solutions that may save you the time and expense of an unnecessary service call.

If you cannot readily find the solution to the problem, please contact your nearest DACOR Authorized Service Representative. In the unlikely event they are unable to solve your problem to your satisfaction, please contact DACOR Customer Service.

Web site: www.dacor.com
For a Dealer/Service: (800) 772-7778
Corporate Phone: (800) 793-0093
Fax: (626) 441-9632
Business Hours: 7:30 A.M. to 4:00 P.M. Pacific Time

DACOR Customer Service
1440 Bridge Gate Dr.
Diamond Bar, CA 91765

Thank you for selecting DACOR for your home. We are dedicated to you and ensure that this appliance in your home will bring years of outstanding performance for your family and friends.

Sincerely,

S. Michael Joseph
Chairman/CEO

TABLE OF CONTENTS	1
Purpose of this Manual	1
Product Registration	1
IMPORTANT INSTRUCTIONS	2
What To Do	2
What Not To Do	2
OVEN OPERATION	3-7
Getting Started	3
What is Pure Convection™?	4
Setting the Time of Day	4
Oven Modes	4
Oven Racks & Supports	4
Oven Mode Selection	5
Preheating the Oven	5
Using the Minute Timers	5
Securing the Controls	6
Baking	6
Roasting	6
Multiple Rack Baking	6
Delay Timed Cooking	6-7
Dehydrating/Defrosting	7
Broiling	7
COOKTOP OPERATION	7-8
Selecting the Proper Cookware	7
Burner Controls	7
Setting the Burner Flame Height	8
Using the Simmer Plate	8
CARE AND CLEANING	8-12
Cleaning Tips	8-9
Control Panel	9
Door Handle & Control Housing	9
Door Glass	9
Stainless Steel Surfaces	9
Porcelain Surfaces	9
Brass and Chrome Surfaces	9
Broiler Pan	9
Oven Racks	9
Convection Fan Filter	9
Top Frame	9
Oven Exhaust Cover	9
Knobs and Spill Protector rings	10
Burner Bases	10
Burner Rings	10
Burner Ignitors	10
Self-Cleaning	10-11
Adjusting the Oven Temperature	11
Replacing the Oven Light	11-12
PROBLEM SOLVING	12-14
Troubleshooting	12-13
Product Maintenance	14
If You Need Service	14
PRODUCT WARRANTY	14
What Is Covered	14
What Is Not Covered	14

Purpose of This Manual

This **Use & Care Manual** is designed to enable you to properly operate and maintain your new range. Please keep this manual handy for easy access and quick reference.

Additional information may be requested by e-mailing, writing or phoning the DACOR Customer Service Department. The address and phone number of this department are listed on the inside front cover of this manual.

What to Do

1. Begin by ensuring proper installation and grounding of the appliance by a qualified technician according to the accompanying Installation Instructions. Have the installer show you where the fuse or junction box and gas valve are located so that you know how and where to turn off the utilities. If you smell gas, do not use the range. Immediately turn off the gas supply at the shut off valve, disconnect electrical power to the unit at the fuse or junction box, and contact the gas supplier or qualified appliance technician.
2. Ensure that the range is used only by those individuals who are able to operate it properly.
3. Use the range only for cooking tasks expected of a home oven as outlined in this manual.
4. Properly clean and maintain the range as recommended in this manual.
5. Use only dry potholders to avoid steam burns when removing hot cookware.
6. Exercise caution when opening the oven door. Let hot air or steam escape before looking or reaching into the oven.
7. Allow the oven cool air intake (located at the door handle) to remain unobstructed at all times.
8. Position oven racks in desired locations when the oven is cool. (If a rack must be repositioned after the oven is already hot, be certain that the potholder does not contact a hot heating element in the oven.)
9. Before Self-Cleaning the oven, remove the broiler grill and pan, oven racks, convection fan filter and any other utensils.
10. Clean only those parts listed in this manual.
11. In the event that a burner flame goes out and gas escapes, turn off the gas control and open a window or door. Wait at least 5 minutes before attempting to use the cooktop.

12. Select utensils of the proper size, material, and construction for the particular type of cooking being done. Select utensils that are large enough to contain the desired quantity of food without boil-overs or spill-overs. Choose pans with easy to hold handles that will stay cool while cooking. Do not use utensils with loose handles. Avoid using pans that are too heavy to lift safely. Use cookware only for its intended purpose. Certain types of glass, ceramic, and earthenware utensils are suitable for use only in an oven and not in cooktop applications.
13. When cooking, set the burner controls so that the flame heats only the bottom of the utensil and does not lick at the sides of the utensil.
14. When deep fat frying, be certain that the pan is large enough to contain the desired volume of food without overflow caused by bubbling of the fat. Never leave a deep fat fryer unattended. Avoid deep fat frying of moist or frost-covered foods, as foods with high water content may cause spattering or spilling of the hot fat. Heat fat slowly, and stir together any combinations of oils and fats prior to applying heat. Utilize a deep fat frying thermometer to avoid heating the fat to temperatures above the flash point.
15. Always turn pan handles to the side or back of the range. Do not turn handles towards the room where they are easily hit. Handles should not extend over adjacent burners.
16. Always check the positions of the control knobs to make sure the cooktop is off when you are finished cooking.
17. Before performing any service, turn off the gas supply by closing the gas shut-off valve and turning off electrical power supply.
18. Always light each burner prior to placing a utensil on the burner grate. Also, turn the control knob to the "off" position before removing a utensil from the burner grate.
19. Always clean the cooktop cautiously. If using a damp sponge or cloth, wait until the cooktop has cooled sufficiently to prevent steam burns. Also, some cleaners can produce harmful or unpleasant fumes if applied to hot surfaces.
20. Keep any ventilation filters clean to avoid grease fires.

If you received a damaged product, immediately contact your dealer or builder. Do not install or use a damaged appliance.

Product Registration

 Please enter the information requested in the spaces provided below. This information will be required in the unlikely event that a service call becomes necessary:

Model No. _____ Serial No. _____

Date Purchased _____ Date Installed _____

Purchased From _____

Address _____

Phone _____

- Always set utensils gently onto the grates and center them so that they are well-balanced.
- Always keep the cooktop surface clean and dry.

What Not to Do

- Do not use the range for warming or heating the room.
- Do not leave children alone or unattended in the area where the range is in use. Never allow children to sit or stand on any part of the oven. Do not let children play with the range.
- Do not store items of interest to children above the range. Children could be burned or injured while climbing on the appliance.
- Do not wear loose or hanging apparel while using the range.
- Do not store combustible, flammable or explosive materials in the range or in adjacent cabinets.
- CAUTION: DO NOT LEAVE FOOD OR COOKING UTENSILS, ETC., IN THE OVEN DURING THE SELF-CLEAN CYCLE.**
- Do not repair or replace any part of the range unless specifically recommended in literature accompanying this appliance. All other service should be referred to a qualified technician.
- Do not use water on grease fires. A violent steam explosion may result. Smother any flames with a lid, cookie sheet or flat tray. Flaming grease can be extinguished with baking soda or foam extinguisher.
- Do not allow potholders to touch hot surfaces or gas burners. Do not use towels or bulky cloth as potholders.
- Do not use commercial oven cleaners or oven liner protective coatings on any part of the oven.
- Do not clean the door gasket, because rubbing, moving or in any way damaging the gasket, may eliminate the required tight door seal.
- DO NOT TOUCH INTERIOR SURFACES OF THE OVEN.** During and after use, do not touch or let clothing or other flammable materials contact heating elements or interior surfaces of the oven until they have had sufficient time to cool.
- Do not block or obstruct the holes below the control knobs. Blocking these holes may affect burner operation and may result in a hazard.
- When using the cooktop, do not touch the grates, burner caps, burner bases, or any other parts in proximity to the flame. These components may be hot enough to cause burns.
- If the cooktop is near a window, do not use long curtains as a window treatment. The curtains could blow over the cooktop and create a fire hazard.
- Do not cover the burners and grates with anything except properly selected utensils. Decorative covers should not be used.
- Do not heat unopened food containers, such as baby food jars and cans. Pressure build-up may cause the container to burst and cause injury.

- Do not use abrasive or caustic cleaners or detergents on this appliance. They may cause permanent damage. Do not use aerosol cleaners. They may be flammable or cause corrosion of metal parts.
- Do not use or attempt to use this appliance in the event of a power failure.
- Do not touch the oven exhaust cover on the cooktop when the oven is in use.
- Do not slide cookware across the grates. Sliding may damage the finish of the grates. Lift utensils to reposition them.
- Do not allow acids (citrus juices, tomato sauces, etc.) to remain on the oven cell surfaces. The porcelain finish may stain.
- Do not touch the range top or backguard with your bare hands during all cooking and self cleaning modes. Venting from the oven may cause the cooktop and backguard to become hot.

user to cancel the selection of an oven mode or Delay Timed program, or disable the control panel by pressing and holding the pad for approximately three (3) seconds. Once the control panel is in the "SECURE" mode, "OFF" will be displayed on the clock. The "LIGHT" touch pad turns the interior oven light "on" and "off." The "LIGHT" touch pad will remain functional if the control panel has been disabled. The "COOK TIME" touch pad is used to select the length of time for a cooking process in Delay Timed cooking mode.

Clock functions are selected by pressing the touch pads located below the clock display and oven mode touch pads. Oven functions are chosen by pressing the touch pad for the desired mode. Once a clock or oven function has been chosen, a description of the selection will flash in the clock display area.

Getting Started

Before using your range, become familiar with the features and control panel layout.

Below the oven mode touch pads are three touch pads labeled "CANCEL•SECURE," "LIGHT" and "COOK TIME". The "CANCEL•SECURE" touch pad enables the

IMPORTANT:

After choosing a clock function or oven mode, you have six seconds to perform the next programming step. If the next step is not completed within six (6) seconds, the program selection displayed on the clock will disappear. Should this occur, just repeat the initial function selection

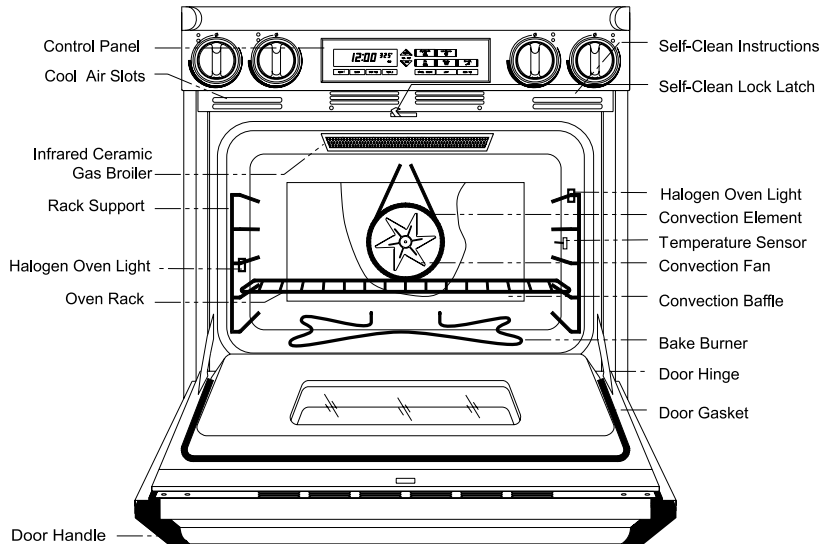

ERD30/36/60 Oven Features
(Convection Screen Not Shown)

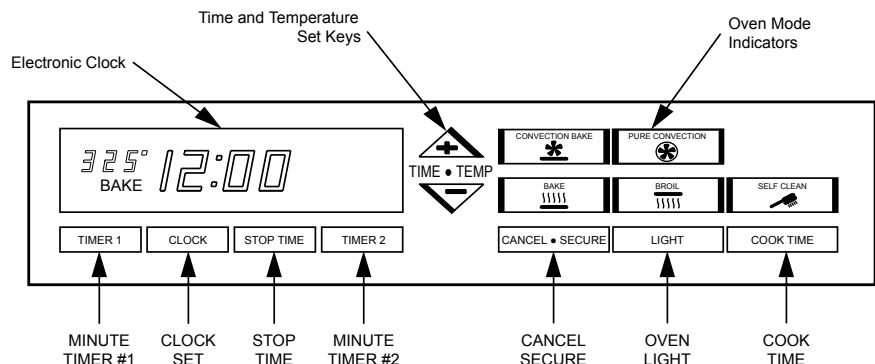

ERD30/36/60 Control Panel

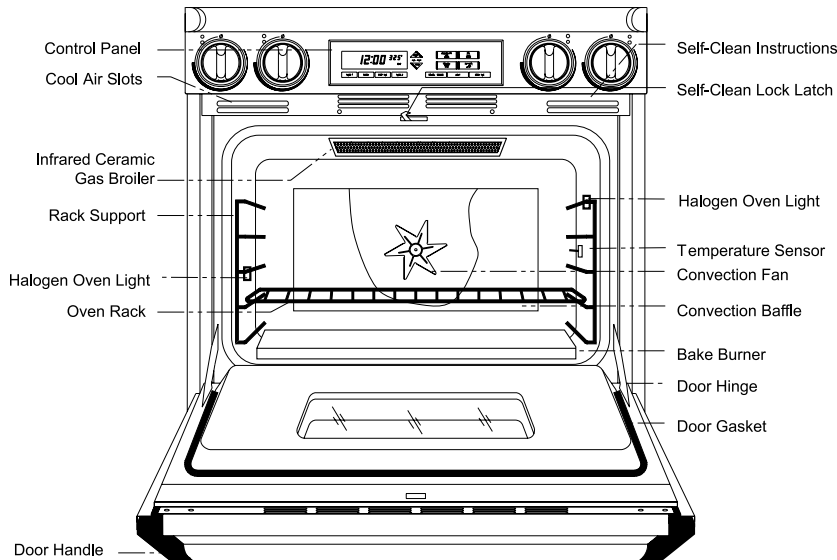

ERG30 Oven Features
(Convection Screen Not Shown)

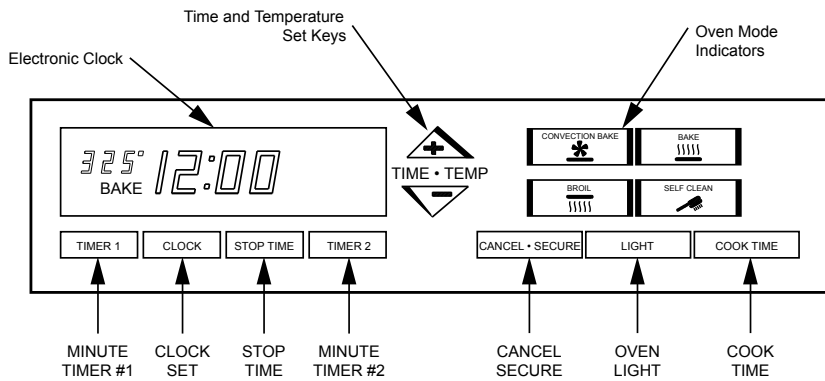

ERG30 Control Panel

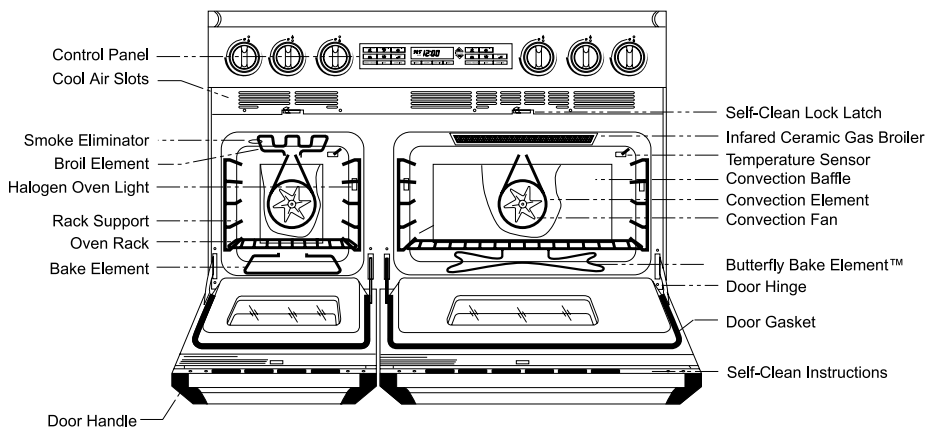

ERD48 Oven Features
(Convection Screen Not Shown)

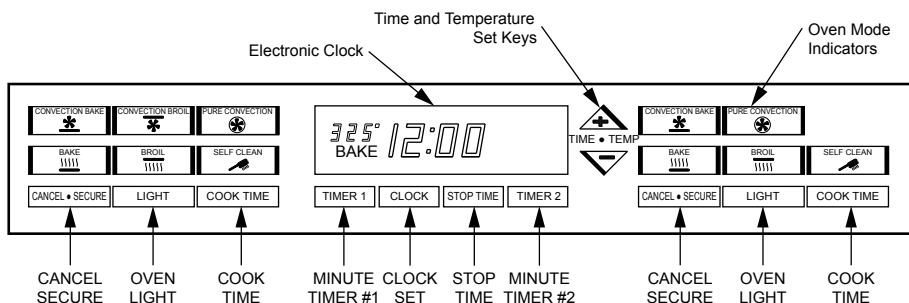

ERD48 Control Panel

What is Pure Convection™?

Your new oven has the best cooking system available today, "Pure Convection™". Pure Convection™ is a total system approach to cooking. The heat source is a third element outside the cooking cell behind a "baffle." Not only does the baffle separate the food from the heat source, it channels the air from the "Convection Fan" evenly into the cell eliminating any hot or cool spots in the oven. This system is what allows multi-rack cooking while achieving even results from one rack to another.

The other component in Pure Convection™ is the "Filter." The filter eliminates the transference of flavors when cooking entire meals and also keeps the oven cleaner

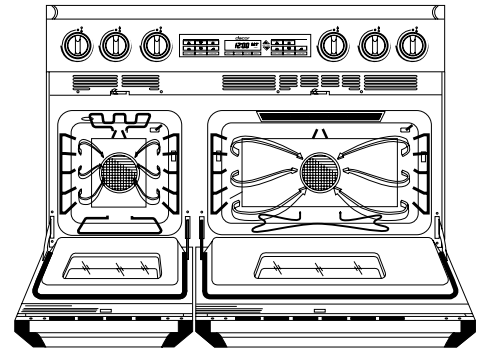

Heated Air Circulation Pattern in Convection Modes

Setting the Time of Day

Follow these two steps to set the correct time of day:

1. Press the "CLOCK" touch pad. The time of day will flash, "AM" or "PM" will be displayed, and "TIME" will flash in the display.
2. Press the touch pad "+" or "-" until the correct time of day is displayed and release.

Oven Modes

All oven modes are described below:

 **STANDARD BAKE** (Selected Models Only) – In Standard Bake mode, the bottom heat element provides conventional baking heat. Temperatures may be set from 135° to 555° F in 5° F increments. Use Standard Bake for single rack baking and roasting.

 **STANDARD BROIL** – The Infrared Ceramic Gas Broiler supplies the heat in Broil mode. The high wattage, top heating element supplies the heat in Broil mode in the ERD48 left oven only. The broil temperature is adjustable from 135° F, to the "HI" setting (equivalent to 555° F) for greater cooking flexibility. **Broiling is performed with the door closed.**

 **CONVECTION BROIL** (ERD48 left oven only) – The high wattage, top heating element supplies the heat in Broil mode in combination with the convection fan for better heat distribution. The broil temperature is adjustable from 135°F to the “HI” setting (equivalent to 555°F) for greater cooking flexibility. **Broiling is performed with the door closed.**

 **PURE CONVECTION™** (ERD models only) – In Pure Convection™ mode a third heating element, encircling the convection fan located in the rear of the oven chamber, acts as the heat source. The convection fan draws air from the oven chamber, then forces it across the hot convection heating element. The heated air is directed back into the oven chamber through the convection baffle. The baffle distributes the heated air evenly to ensure uniform results. Temperatures may be set from 135° to 555° F in 5° F increments. Use this mode for single rack baking, multiple rack baking, roasting, and preparation of complete meals.

 **CONVECTION BAKE** – In this combination convection-radiant mode, the lower element provides the heat. As in Pure Convection™ mode, the convection fan and baffle combine to circulate heated air evenly throughout the oven chamber. Temperatures may be set from 135°F to 555°F in 5°F increments. Use this mode for single rack baking, multiple rack baking and roasting.

 **SELF-CLEAN** – In the pyrolytic Self-Clean mode, the oven reaches extreme high temperatures, thereby burning off oven soil automatically. The Self-Clean time is adjustable up to four hours so that varying degrees of oven soil can be successfully removed. Also, the Self-Clean cycle can be delayed to start at a later time if desired

Oven Racks and Supports

Three chrome-plated oven racks are provided. Always remember to position the racks prior to heating the oven. Also, remove the oven racks prior to self-cleaning to prevent permanent discoloration of the racks

The porcelain rack supports provide five (5) heights for positioning of the oven racks.

To install a rack, align the left and right edges of the rack with the horizontal guide rails of the rack supports, then slide the rack into the oven

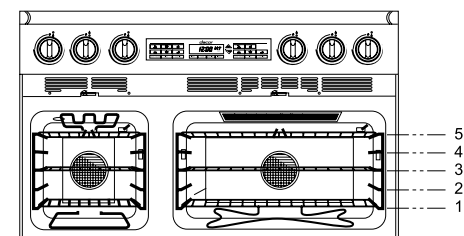

Oven Rack Positions
(ERD48 Shown)

Oven Mode Selection

Follow these steps to operate the oven modes:

1. Position oven rack(s) at the proper height(s).
2. Press the touch pad for the modes of your choice. The oven will beep once, the selected cooking mode will flash, and “— —” will be displayed.
3. Press either the “+” or “-” pad. The default temperature will be displayed.
4. To adjust the default temperature for baking, press and hold the “TIME•TEMP” pad. (Press “+” key to increase the temperature setting, “-” to decrease.) “PRE” and “ON” will appear in the clock display, and the oven will begin to heat. If in a convection mode, the convection fan will turn on. Also, the clock display will change from the desired cooking temperature to the actual oven temperature, starting with 135°F. The temperature display will increase in 5°F increments until the desired temperature is reached. The cooling fan will turn on when the oven temperature reaches 200°F.

NOTE:

Do not place food inside the oven until the Preheat cycle is complete.

When the desired temperature is attained, the Preheat cycle is complete. The clock will beep once and “PRE” and “ON” will disappear from the display. (From this time forward, the “ON” display will cycle on and off with the heating elements.)

5. Carefully place the food onto the desired rack(s) within the preheated oven.
6. It is recommended that a Minute Timer be set to time the cooking process.
7. When the time expires and/or the food is done cooking, press the “CANCEL•SECURE” pad to turn off the oven.

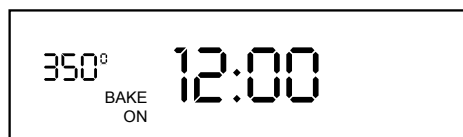

Clock Display
in Standard Bake



Clock Display
in Pure Convection™



Clock Display
in Convection Bake

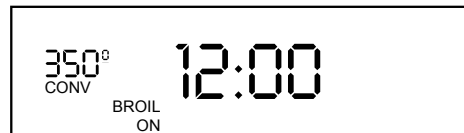

Clock Display
in Convection Broil
(ERD48 left oven only)

Preheating the Oven

The oven features an automatic Preheat cycle that rapidly brings the oven chamber up to temperature. Simply by choosing a cooking mode and setting a temperature, the oven will automatically perform the Preheat function. The Preheat cycle operates in Standard Bake, Pure Convection™ and Convection Bake modes. There is no Preheat cycle for the Broil or Convection Broil modes.

NOTE:

Allowing the oven to completely pre-heat prior to placing food in the oven will avoid excessive browning of the food. After the oven signals that the pre-heat is complete, allow 3-5 more minutes for the heat patterns to normalize in the oven and then place your food inside.

Minute Times

The clock features two timers that may be used for time cooking or other processes up to 11 hours, 50 minutes in length.

To use the Minute Timer function, follow these steps:

1. Press the touch pad labeled “TIMER 1”, or “TIMER 2”. The clock will display “00:00”, and “TIMER 1”, or “TIMER 2” will flash.
2. Press the “+” pad until the desired time is displayed on the clock.
3. After “TIMER 1” has expired, the clock will sound off with one second beeps and “TIMER 1” will appear in the display. After the “TIMER 2” minute timer has expired, the clock will sound alternating one and two second beeps and “TIMER 2” will appear in the display. The beeper can be silenced by pressing the “TIMER” touch pad while the beeper is sounding.

IMPORTANT:

Cancellation of the Minute Timer does not turn off the oven if it is operating. You must manually shut the oven off by pressing the “CANCEL-SECURE” touch pad. (See the Delay Timed Cooking section on page 7 for automatic oven turn on and turn off.)

NOTES:

1. To view the current time of day rather than the remaining time on the Minute Timer, just press the “CLOCK” touch pad. To change back to a Minute Timer display, press the “TIMER 1” or “TIMER 2” touch pad.
2. To cancel the Minute Timer while in progress, press the “TIMER 1 or 2” touch pad two times. The clock display will return to the time of day.
3. The Minute Timers may be used at the same time as Delay Timed Cooking or Self-Clean.
4. The Minute Timers will beep for 2 minutes (if not cancelled) before automatically shutting off.
5. Pressing the “CANCEL-SECURE” pad when the beeper is sounding will cancel both the beeper and the cooking function.

Securing Controls

To avoid accidentally turning the oven on, activate the “SECURE” feature. Press and hold the “CANCEL-SECURE” pad for approximately three seconds. This will disable the control panel and allow cleaning the controls without accidentally starting any functions. Three beeps will sound and “OFF” will appear in the display when the control panel has been secured.

To re-activate the control panel, again push and hold the “CANCEL-SECURE” pad for three seconds. Three beeps will sound and the “OFF” will disappear from the display.

Baking

Your DACOR range offers two convection baking modes: Pure Convection™ or Convection Bake.

As a general rule, a convection mode will allow preparation of most foods at reduced temperatures for shorter periods of time, while also producing superior results. Typically you can reduce standard temperature by 25°F and cook for 10% less time. Baked goods will have golden-brown crusts with flaky textures, and meats will have crispy exteriors with succulent juices sealed inside.

1. To convert Conventional Bake recipes to our convection recipes, reduce temperature by 25°F and the cooking time by approximately 10%.

2. Some recipes, especially those that are homemade, may require adjustment and testing when converting from standard to convection modes. If unsure how to convert a recipe, begin by preparing the recipe in Bake mode. After achieving acceptable results this way, follow the Convection guidelines listed. If the food is not prepared to your satisfaction during this first Convection trial, adjust only one recipe variable at a time (such as cooking time, rack position or temperature) and repeat the convection test. If necessary, continue adjusting one recipe variable at a time until satisfactory results are achieved.
3. Do not open the oven door frequently during baking. Look through the door window to check the progress of baking whenever possible.
4. Use the Minute Timers to time baking functions.
5. Wait until the shortest recommended baking time before checking food. For baked goods, a wooden pick placed in the center should come clean when the food is done.
6. Measure ingredients carefully and follow tested recipes for best baking results.
7. Bakeware Tips:
 - Use the pan size and type recommended by the recipe to ensure best results.
 - Cakes, quick breads, muffins and cookies should be baked in shiny, reflective pans for light, golden crusts.
 - Medium gauge aluminum sheets with low sides should be used when preparing cookies, biscuits and cream puffs.
 - Bake most frozen foods in their original foil containers placed on a flat cookie sheet. Follow the package recommendations.
 - When using glass bakeware, reduce the recipe temperature by 25°F, except when baking pies or yeast breads. Follow the standard recipe baking time for pies and yeast breads.
 - Avoid the use of old, darkened pans.
 - Warped, dented, stainless steel and tin-coated pans heat unevenly and will not give uniform baking results.
8. Tips for Pan Placement:
 - Place pans carefully on the oven racks. Turn pans on the racks so that the long sides run left to right, parallel to the door.
9. Adjustments to recipe times and temperatures will have to be made when baking at high altitudes. Consult a cookbook on high-altitude cooking or contact the Home Economics Departments at your state university for specific recommendations.

NOTE:

For common baking problems refer to your Dacor cookbook. Your complimentary cookbook was packed with your range. If you did not receive your cookbook, please contact Dacor at (800) 793-0093 or at www.dacor.com

Roasting

All baking modes can be used to successfully roast in your oven. However, the Convection mode is recommended to produce meats that are deliciously seared on the outside and succulently juicy on the inside in record time. Foods that are exceptional, when prepared in a Convection mode, include: beef, pork, ham, lamb, turkey, chicken, and cornish hens.

1. To convert conventional Bake recipes to Convection recipes, reduce the temperature by 25°F and the cooking time by approximately 10%.
2. Using a roasting rack, always roast meats fat side up in a shallow pan. Always use a pan that fits the size of the food being prepared. The broiler pan and grill, accompanying the oven, can be used in most cases. No basting is required when the fat side is up. Do not add water to the pan. It will cause a steamed effect. Roasting is a dry heat process.
3. Poultry should be placed breast side up on a rack in a shallow pan that fits the size of the food. Again, the broiler pan and grill accompanying the oven can be used. Brush poultry with melted butter, margarine, or oil before and during roasting.
4. For Convection roasting, do not use pans with tall sides. They interfere with the circulation of heated air over the food.
5. When using a meat thermometer, insert the probe halfway into the center of the thickest portion of the meat. (For poultry, insert the thermometer probe between the body and leg into the thickest part of the inner thigh.) To ensure an accurate reading, the tip of the probe should not touch bone, fat or gristle. Check the meat temperature 2/3 of the way through the recommended roasting time.
6. After reading the meat thermometer once, insert it 1/2 inch further into the meat, then take a second reading. If the second temperature registers below the first, continue cooking the meat.
7. Remove meats from the oven when the thermometer registers 5° to 10°F below the desired temperature. The meat will continue to cook after removal.
8. Allow roasts to stand 15 to 20 minutes after roasting in order to make carving easier.
9. If using a cooking bag, foil tent, or other cover, use Bake Mode (ERDE models only) or Convection Bake Mode (ERD models only). The recipe time and temperature will have to be adjusted as well.
10. Roasting times always vary according to the size, shape and quality of meats and poultry. Less tender cuts of meat are best prepared in Bake and may require moist cooking techniques. Follow your favorite cookbook recipes.
11. Reduce spatter by lining the bottom of the roasting pan with lightly crushed aluminum foil.

Multiple Rack Baking

The uniform air circulation provided by Convection™ cooking enables the more oven capacity to be utilized. Many foods, such as pizzas, cakes, cookies, biscuits, muffins, rolls and frozen convenience foods can be successfully prepared on either two or three racks at the same time. Additionally, complete meals can be prepared by using multiple racks.

See below for specific recommendations. Follow the steps in the **Oven Modes** section, to manually operate the oven, or refer to the **Delay Timed Cooking** section below for automatic operation.

MULTIPLE RACK BAKING TIPS

1. Typically, when baking on two racks, rack positions #1 and #4 or #2 and #4.
2. When adapting a single rack recipe to multiple rack baking, it may be necessary to add to the baking time. This is due to the extra mass of food in the oven.

Oven GlideRack™

Dacor's Oven GlideRack™ is designed to install effortlessly and glide at a full extension. Especially when using Dacor's pizza stone (model number ABS20), the full extension of the rack allows you to slide the pizza on and off the stone with great ease. It is also great for large roasts in large roasting pans. This easy- slide rack will allow you to baste more easily and check temperatures of the food more safely and quickly.

Proper Installation of the Easy slide Oven Rack:

1. Fully extend the two side guides. Align two small clips on the bottom at the rear of the Oven GlideRack™ with the black porcelain rack guides in the oven.
2. Begin to slide the rack in, then lift up. The Oven GlideRack™ must be in between the two clips on the upper and lower side of the rack rear.
3. Push the rack all the way to the back.
4. Grasp the rack in the front center and pull. The rack should come forward while the side guides remain in place.

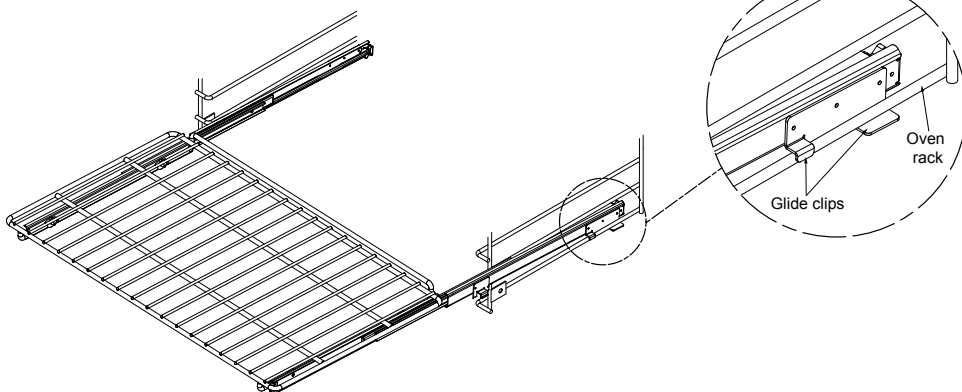

Oven GlideRack™

Helpful Hints When Using Your Oven GlideRack™:

1. This rack works particularly well with heavier items, although you can use it during any baking, broiling or roasting in your Dacor oven.
2. These racks will need to be spaced out when using more than one in the oven at a time. For instance, the racks should be used on rack positions 1,3, & 5 or 2 & 4, counting up from the bottom, instead of using racks 2,3, & 4.
3. When using the rack with Dacor's ABS20 baking stone, use rack position 1 for best results.
4. Heavier roasting pans and dishes will also cook better on Rack position 1.
5. Do not leave the rack in during self- clean. The rack will become difficult to slide in and out if it is self- cleaned. Remove all the racks and the filter in the back of the oven before self- cleaning..
6. To clean the rack, use hot, soapy water and the rough side of a sponge.

Delay Timed Cooking

This function allows the user to start and finish a cooking cycle automatically. It is especially useful for preparing meals in advance, cooking while you are at work or play. Delay Timed Cooking can only be used with Standard Bake (ERD model only), Convection Bake, or Pure Convection modes. It will not function in Broil mode.

⚠ WARNING:

Food safety is an important consideration when using delayed cooking modes. To avoid potential sickness and spoiling of food, take the following steps:

1. **Avoid using foods that will spoil while waiting for the cooking cycle to begin. Typical foods to avoid include those containing eggs and dairy products, cream soups, and cooked or uncooked meats, poultry and fish.**

2. **If cooking will not begin immediately, place only very cold or frozen food into the oven. Most unfrozen foods should never stand in the oven for more than two hours before cooking begins.**
3. **Do not allow foods to remain in the oven more than one hour after completion of the cooking cycle. When the temperature drops below 140°F, bacteria can develop.**



Setting the Oven for Delay Timed Cooking

To use Delay Timed Cooking, follow these steps:

1. Position oven rack(s) at the proper height(s).
2. Place the food onto the center of the oven rack(s).
3. Select the desired cooking mode and temperature.
4. Press the "COOK TIME" pad and "TIME" will appear in the clock display. Press the "TIME•TEMP" "+" pad to set the length of time that the food will be cooked. The "COOK TIME" can be set from 5 minutes to 11 hours, 50 minutes.
5. The oven can be set to start now or later in the day. To start cooking now, do not perform any more programming steps. After six seconds "PRE", "ON" and "TIMED" will appear in the clock display, and the oven will begin heating. After the "COOK TIME" has expired, the clock will beep three times, and "Hold" will be displayed. The cooling fan will continue to run, depending upon the length and temperature of the cooking process.
6. Press the "STOP TIME" touch pad, and "STOP" will appear in the clock display. Press the "TIME•TEMP" "+" pad to enter the time of day that you wish the oven to shut off. "DELAY" will now be displayed. The oven will calculate the correct "START TIME." After the "COOK TIME" has expired, the clock will beep three times, and "Hold" will be displayed. If cooking in a convection mode, the convection fan will also turn off at this time. While in "Hold" mode, the oven temperature will be maintained at 150°F for a period of two hours. "Hold" mode can be cancelled by pressing the "CANCEL•SECURE" touch pad. The cooling fan will continue to run depending upon the length and temperature of the cooking process.

DELAY TIMED COOKING TIPS

1. Do not use foods containing baking powder or yeast in Delay Timed Cooking. These foods will not rise properly.
2. Remember that "COOK TIME" refers to the length of the cooking cycle. It does not refer to the start time!

- The time required to preheat the oven must be included in the "COOK TIME." Thus, the "COOK TIME" should be increased by about 8 to 12 minutes depending upon the temperature setting. The broiler does not come on to preheat in the Delay Mode, so you will not pre-maturely brown foods.

NOTE:

The gas broilers (ERD model only), or Electrical Glass Broilers (ERDE model only), are not activated for Pre-heat in the Delay-Time cooking mode, so Pre-Heat times are increased - but dishes will not pre-maturely brown.

Dehydrating/Defrosting

The range can be used to dehydrate or defrost foods at low heat settings in "Pure Convection™" mode (ERD models only).

Follow these steps to dehydrate or defrost foods:

- Position oven rack(s) at the proper height(s).
- Place the food onto the center of the oven rack. (For dehydrating, prepare food as recommended then place food onto a drying rack.)
- Press the "PURE CONVECTION™" pad.
- Set the temperature to 135°F. This is the minimum temperature that can be set. (For dehydrating, a higher temperature setting may be required. Follow the recommended temperature for the type of food being prepared.)
- It is recommended that the user set the Minute Timer(s) to time the process.

Broiling

Broiling is a quick and flavorful way to prepare many foods, including steaks, chicken, chops, hamburgers and fish. **Broiling in the oven is completed with the oven door completely shut.** It is normal and necessary for some smoke to be present to give the food a broiled flavor. The broil temperature may be adjusted in 5°F increments from 135°F up to the maximum setting of "HI". The "HI" setting is equivalent to 555°F.



Clock display in Broil (ERD48 & ERDE48 Only)



Clock display in Broil (ERD30, ERG30, ERD36, ERDE36 and ERG36)

Follow these steps to operate the oven in Standard Broil (all models) or Convection Broil (ERD48/ERDE48 left oven only) modes:

- Close the door tightly.
- Press the "BROIL" or "CONVECTION BROIL" (ERD48 left oven only) pad.
- Press the "TIME•TEMP" "+" or "-" pad and the default temperature setting "HI" will be displayed. "HI" is equivalent to 555°F.
- If a temperature other than "HI" is desired, press the "TIME•TEMP" "-" pad to reduce the temperature. Six seconds after setting the temperature, the "ON" indicator will light up in the clock display, the broiler element will begin heating, and the cooling fan will turn on.
- It is recommended that the user set the Minute Timer(s) to time the broiling process.
- When the Minute Timer expires and/or the food is cooked, press the "CANCEL•SECURE" touch pad to turn off the oven. The cooling fan will continue to run for 30 to 45 minutes depending upon the length and temperature of the broiling process.

NOTE:

For broiling and top grill tips refer to your Dacor cookbook. Your complimentary cookbook was packed with your range. If you did not receive your cookbook, please contact Dacor at (800) 793-0093 or at www.dacor.com

Selecting the Proper Cookware

Utensils will affect the overall safety and performance of cooktop cooking, so it is important to select them carefully. An improperly selected utensil will not cook efficiently or evenly. For best results, follow these guidelines:

- Use medium to heavy-gauge metal cookware with flat and smooth bottoms for greatest efficiency.
- Use utensils with tight fitting lids to retain heat, odors, and steam.

Burner Controls

Indicators have been placed on the control housing, next to each control knob, to clearly identify the burner controlled by each knob. To indicate whether the knob controls burners on the left or right, the knobs are grouped accordingly. The burner being controlled is indicated by a blue indicator light, while the adjacent burner is illustrated by a flame icon on the control panel.

To light a particular burner, press in on the corresponding control knob, then immediately rotate the knob counterclockwise from the off (Ø) position to the "HIGH" position (larger flame icon). All ignitors will spark continuously until the gas ignites on the selected burner. Ignition should occur within four seconds of turning to this position. The ignitors will stop sparking as soon as the burner ignites.

Once the burner is lit, reduce the flame height by rotating the control knob further counterclockwise, then place the utensil on the grate. Progressively lower flame heights are achieved as the knob is turned toward the small flame icon (counterclockwise).

IMPORTANT:

- If the gas does not ignite within four seconds, then turn off the valve. Allow at least five minutes for any gas to dissipate, then repeat the lighting procedure.
- Burner ignitors must always be kept clean and dry to function properly. Due to the Perma-Flame re-ignition feature, dirty or wet ignitors will result in constant sparking, even if there is a flame present. Additionally, ignitors will spark automatically if the flame is distorted by a draft or by a ventilation system. Eliminate the draft or reduce the ventilation blower speed in this case.
- Do not touch any burner cap, burner base, or ignitor while the ignitors are sparking. An electrical shock could result.
- When the cooktop is cool and/or more than two burners are in use, the ignitors may continue to spark if the control knob is set to the "LOW" position. This is normal until the burner warms up. The tendency to spark under these conditions can be reduced by operating the burner at a higher flame setting for a short period of time (normally 60 seconds or less), then adjusting the control knob down to the "LOW" setting. The burner will also warm up faster if a utensil is placed on the grate.
- The flame should be steady and blue in color. Foreign material in the gas line, especially in new construction, may cause an orange flame during initial operation. This will disappear with further use.
- The flame should burn evenly around the perimeter of the burner, except underneath each grate support finger, where the flame height is reduced by the Smart-Flame feature. If the flame is uneven, ensure that the brass burner ring and porcelain burner cap are properly positioned, then check for any foreign material in the burner ring or on the burner cap. Remove any foreign material with a straightened paper clip, wire, or needle. Do not damage the brass or distort the shape of the burner ring ports.
- Never light the burners with a match or other open flame. If a burner does not ignite, consult the Troubleshooting section of this manual.

Setting the Burner Flame Heights

Epicure™ Range burners are all rated at a maximum output of 15,000 BTU/HR.

All burners are sealed to the cooktop by gaskets around the underside of the burner bases, thereby preventing any liquid spills from getting below the cooktop frame.

Setting the proper burner flame height for the desired cooking process and selected utensil will result in superior cooking performance, while also saving time and energy. Follow these recommendations for best results:

1. Use low or medium flame heights when cooking in utensils that are poor conductors of heat, such as glass, ceramic, and cast iron cooking vessels. Reduce the flame height until it covers approximately 1/3 of the utensil diameter. This will ensure even heating within the utensil and reduce the likelihood of burning or scorching of food.
2. Reduce the flame if it is extending beyond the bottom of the utensil. A flame that licks along the sides of the utensil is potentially dangerous.
3. Reduce the flame height, to the minimum level necessary, to perform the desired cooking process. Remember that food cooks just as quickly at a gentle boil as it does at a vigorous, rolling boil. Maintaining a higher boil than is necessary wastes energy, cooks away moisture, and causes a loss in food flavor and nutrient level.

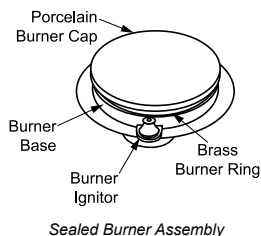

Using the Simmer Plate

The Simmer Plate has been specifically designed for simmering and holding food at the lowest safe temperature. **The Simmer Plate is to be used by setting the burner to its lowest setting.** The Simmer Plate has been specifically designed for simmering only. **The Simmer Plate must be removed when cooking.**

To install your Simmer Plate locate the five feet on the bottom, align with the five longest fingers on the cooktop grate then set the plate on top of the grate. When correctly installed, the Simmer Plate will rest about 1/2 inch above the top surface of the grate and will be locked in place to prevent turning.

Your Simmer Plate has a non-stick coating for easy cleaning. Take care in using abrasives on the non-stick coating, as it will scratch. Some wearing may occur on top of the Simmer Plate offset fingers, this is normal with use.

NOTE:

Non-stick coatings if used at high temperatures can be harmful to birds. Avoid keeping pets (birds) in your kitchen during cooking.

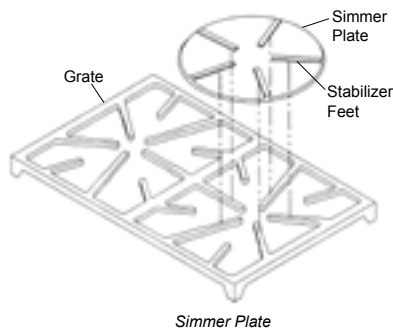

WARNING:

To avoid electrical shock or burns, turn off all controls and ensure the cooktop is cool before cleaning.

IMPORTANT:

Do not use harsh or abrasive cleaning agents, waxes, polishes, or commercial cooktop cleaners to clean the cooktop.

Read and follow the **CARE AND CLEANING INSTRUCTIONS** to ensure that proper cooktop operation and appearance will be maintained throughout the lifetime of the product. Several materials and finishes are used in the cooktop. Each material and finish must be properly cleaned according to the following recommendations. Failure to follow these recommendations may result in permanent damage to the cooktop.

Cleaning Tips

WARNINGS:

1. **Before cleaning the cooktop, ensure that all burners are turned off and that all components are cool enough to safely touch.**
2. **After cleaning, reassemble all components before attempting to operate the cooktop.**

Proper cleaning is necessary to maintain cooktop performance and appearance, while also ensuring safe operation. The cleaning effort necessary to maintain the cooktop varies according to the type and amount of cooking. For example, more frequent cleaning is required if the cooktop is used often for frying or other high temperature operations.

Clean the cooktop thoroughly prior to operating it the first time. For initial and everyday cleaning, use a soft cloth or sponge lightly dampened with a solution of warm water and hand dishwashing liquid to clean all components.

IMPORTANT:

1. **To keep the cooktop looking its best, clean it after every use as soon as all components are cool enough to safely touch. Also, quickly wipe up spills that occur while cooking, being careful not to touch any hot areas. Spills that remain on hot burner components will be very difficult to clean, especially if allowed to burn on. Spills of certain foods, such as tomatoes, citrus juices, vinegar, alcohol, and milk, are very harmful if allowed to stand for any length of time. Therefore, save time while also maintaining a new appearance by cleaning regularly and shortly after spills occur.**
2. **Use the mildest cleaner or procedure available to perform the cleaning operation.**
3. **Use only a sponge, soft cloth, fibrous or plastic brush, and nylon pad for cleaning. Avoid the use of abrasive cleaners such as steel wool.**
4. **Always dry components completely before using the cooktop.**
5. **The use of brand names is intended only to indicate a type of cleaning agent or cleaning implement. All products listed by name must be used in accordance with the manufacturer's recommendations. Use of a brand name does not constitute an endorsement, nor does omission of a particular brand imply that a product is inferior.**

Recommendations for cleaning specific cooktop components are summarized below:

IMPORTANT:

The grates, burner caps, and spill-over areas on the cooktop, unlike other porcelain enamel appliances in your home, are exposed to extremely high temperatures in a matter of seconds. In addition to this extreme thermal shock, the grates are subjected to mechanical shock when utensils are placed on or slid across them. Finally, spillovers introduce foods with high acidity to all of the porcelain components. Due to these severe operating conditions, all porcelain enamel components on the cooktop will undergo an inevitable change in appearance with use. Meticulous care and cleaning will slow but not eliminate this natural and expected aging process.

Treating the porcelain components with care will slow the natural deterioration that takes place with cooktop use. Please follow these guidelines to keep the porcelain parts looking their best:

1. **Do not use utensils having rough bottoms, as this can result in permanent damage to the top surfaces of the porcelainized grates.**
2. **Do not drop utensils onto the grates or drag heavy pots across the tops of the grates.**

- Set the grates into the locating dimples gently. Do not drop the grates into place.
- Use caution when cooking to avoid spills as much as possible. Porcelain is acid-resistant but not acid-proof, so some foods can cause permanent damage if allowed to remain on porcelain surfaces.

Daily cleaning of the grates and burner caps is best accomplished with a soft cloth or sponge dampened in a solution of warm water and hand dishwashing liquid. Grates and burner caps should not be cleaned in the dishwasher.

Stubborn stains may be removed by applying full-strength sprays such as Simple Green, Ajax All-Purpose Cleaner, Formula 409, or Scotch Guard. Metal polishing compounds such as Luneta or Flitz may also be used. (If you are unable to locate these cleaning compounds, please phone the DACOR Customer Service Department for a referral.)

Mildly abrasive cleaners or applicators, such as S.O.S. Pads, soap-filled steel wool pads, Soft Scrub, or Bon-Ami may be used with extreme care on occasion to remove the most serious stains. **Exercise caution – extensive use of abrasives will eventually damage the porcelain enamel surface.**

Control Panel

To avoid accidentally turning the oven on while cleaning the control panel, activate the "Secure" feature. Press and hold the "CANCEL•SECURE" pad for approximately three seconds. This will disable the control panel and allow cleaning the controls without accidentally starting any functions. "OFF" will appear in the display when the control panel has been secured.

To re-activate the control panel, again push and hold the "CANCEL•SECURE" pad for three seconds. "OFF" will disappear from the display.

IMPORTANT:

Clean the control panel with a solution of mild detergent and warm water. DO NOT USE ABRASIVE CLEANERS OR SCRUBBERS. THEY WILL PERMANENTLY DAMAGE THE FINISH. Dry the control panel completely with a soft, lint-free cloth.

Door Handle & Control Housing

IMPORTANT:

Clean the door handle and control panel housing with a solution of mild detergent and hot water. Rinse and dry with a soft cloth. DO NOT USE ABRASIVE CLEANERS OR SCRUBBERS. THEY WILL PERMANENTLY DAMAGE THE FINISH.

Door Glass

Clean all glass surfaces with a solution of mild detergent and hot water. Use a mild glass cleaner to remove fingerprints or smears. Dry completely with a soft, lint-free cloth.

Stainless Steel Surfaces

The control panel, door(s) bullnose and side panels are covered with stainless steel. Clean these surfaces with the provided Elco Stainless Steel Cleaner. Rinse and dry with a soft, lint-free cloth.

IMPORTANT:

If commercially available stainless steel cleaners are used, it is important to read the labels for chlorine compounds. Chlorine is a corrosive substance. If these compounds are present, rinse thoroughly and dry with a soft, lint-free cloth.

Always wipe stainless steel surfaces with the grain.

Porcelain Surfaces

IMPORTANT:

The oven interior and inner door liners are finished in porcelain enamel. Clean these surfaces with a solution of mild detergent and hot water. Rinse and dry with a soft cloth. Do not use abrasives or commercial oven cleaners. Always remove excess grease and soil from the oven interior and door prior to using the Self-Cleaning cycle. Clean these surfaces with a solution of mild detergent and warm water. Rinse, dry and polish with a soft, lint-free cloth.

Brass, Chrome & Copper Surfaces

IMPORTANT:

If a commercially available polish is used, it is important to read the label for chlorine compounds. Chlorine is a corrosive substance and is not recommended for use with brass or chrome finishes. If these compounds are present, rinse surface thoroughly and dry with a soft, lint-free cloth. Follow manufacturer's instructions for application of polish.

Broiler Pan

The oven broiler pan is finished in porcelain enamel. Clean both components in a solution of detergent and hot water. For heavy soil conditions, use a scouring pad such as steel wool with plenty of water. Rinse well after cleaning.

Oven Racks

Oven racks are chrome-plated. For everyday cleaning, apply a solution of detergent and hot water. To clean heavy soil, use a scouring pad such as steel wool with plenty of water, or use a solution of 1 cup ammonia to 2 gallons of water. Remove racks during Self-Cleaning. **If racks are left in the oven during self-cleaning, they will permanently discolor.**

Convection Fan Filter

WARNING:

Remove the filter only when it is cool.

The convection fan filter is made of stainless steel. Remove the filter regularly for cleaning, as a clogged filter will reduce the effectiveness of convection cooking modes. Soak the filter in hot soapy water according to the package directions. Dry the filter completely before re-installing. Remove the filter during Self-Cleaning. If the filter is left in the oven during Self-Cleaning it will permanently discolor.

Re-install the filter before cooking in the oven again. Failure to do so will expose the convection fan blade that rotates at high speed during convection modes.

Step 1: Orient the filter so that the two mounting tabs are towards the rear, open end down.

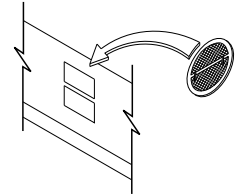

*Removing and Installing the Convection Fan Filter
Step 1*

Step 2: Hook the two mounting tabs over the center horizontal bar.

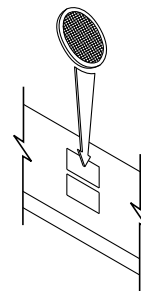

*Removing and Installing the Convection Fan Filter
Step 2*

Top Frame

Everyday cleaning of the cooktop surface is best accomplished with a soft cloth or sponge dampened in a solution of warm water and hand dishwashing liquid.

Stubborn stains may be removed by applying full-strength sprays such as Simple Green, Ajax All-Purpose Cleaner, Formula 409, or Scotch Guard.

IMPORTANT:

- Never use the cooktop surface as a cutting board.**
- Do not use abrasive cleaners or applicators on the cooktop.**
- Do not try to remove heavy spills with a sharp object such as a knife or metal spatula. Sharp objects may scratch the cooktop.**
- A small amount of baby oil may be applied to stainless steel tops to restore lustre.**

Open Exhaust Cover

(On Selected Models Only)
Cleaning is best accomplished with a soft cloth or sponge dampened in a solution of warm water and hand dishwashing liquid

Knobs and Spill Protector Rings

The control knobs provided with these ranges are designed for ease of use and longevity. The “D” shaped design of the knob shaft ensures proper orientation when re-installing the knob. Beneath each knob, a spill protector ring prevents liquid spills from entering the control panel.

▼ WARNING:

Never block the holes in the control panel below the knobs. This will impair the flow of combustion air and adversely affects burner operation, possibly creating a hazardous condition.

The knobs should be washed regularly in warm, soapy water. Hand dishwashing liquid is excellent for this task. Knobs should be removed by gently pulling them straight off of the valve shafts. The spill protector rings should be cleaned in place. Use caution to avoid introduction of moisture into the control panel. To replace knobs, align the “D-shaped” opening at the bottom of the knob with the “D-shaped” valve shaft, then carefully press the knob onto the valve shaft.

▼ IMPORTANT:

1. Turn the knobs to the “OFF” position prior to removing them from the valve stems.
2. The cooktop should never be operated without the knobs and spill protector rings in place.
3. Do not soak the knobs and spill protector rings in water or place them in the dishwasher.
4. Do not expose the knobs or spill protector rings to direct flame, hot utensils, or other sources of heat.
5. Do not use abrasive or corrosive cleaners or applicators. They could cause permanent damage.

Burner Bases

The brass burner rings spread the flame evenly around the burner perimeters. The burner rings must seat properly in the burner bases to enable proper cooktop operation. To ensure proper seating, five positioning tabs have been placed on the bottom of each burner ring to slide into corresponding notches in the fixed burner base.

Burner Rings

The burner rings are made of brass. To remove the burner ring, first lift off the porcelain burner cap. The burner ring may then be removed from the burner base. Soak the burner ring in a warm solution of hand dishwashing liquid and water, then rinse well with clean water. Dry the burner ring thoroughly before placing it back on the burner base.

Stubborn stains may be removed by applying a metal polishing compound.

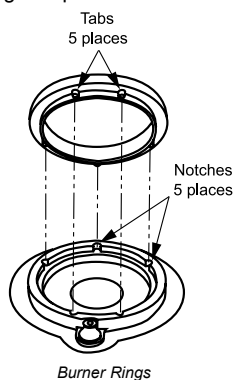

Burner Igniters

Under certain cooking or cleaning conditions, your cooktop igniters may become coated with or corroded by food deposits, splattered grease or cleaning agents. This condition can cause erratic or continuous sparking. Keeping the igniters clean and dry will help to reduce this problem.

To avoid unnecessary and costly service calls, the homeowner should perform periodic cleaning of the igniters.

An Ignitor Cleaning Brush is enclosed for your use in cleaning the cooktop igniters.

To clean the igniters:

1. Be sure burners are cool to the touch. Remove the grate, burner cap and burner rings.
2. Brush completely around the ignitor, including over and under the edge of the metal cap and base. Use care while cleaning here. The ignitor is porcelain and can be fragile.
3. DO NOT USE WATER when cleaning the igniters. If a liquid must be used to clean the ignitor effectively, use a small amount of rubbing alcohol.
4. After cleaning, reinstall the burner ring, burner cap and grate. Make sure the brass burner ring is properly seated into the burner base.
5. Test the burners. If erratic clicking is still present, make sure the ignitor is completely dry. If the unit still exhibits problems after drying, call your local DACOR Authorized Servicer.

Self-Cleaning

The electric door latch is a convenient safety feature. The door latch is automatically activated after selecting the Self-Clean mode. The latch ensures that the oven door cannot be opened while the interior oven temperatures are unsafe to the user.

The oven features an automatic pyrolytic Self-Cleaning cycle to eliminate the need for difficult and time-consuming manual scrubbing of interior surfaces. During this cycle, the oven reaches extreme high temperatures to burn off soil and deposits. A powder ash residue is left in the bottom of the oven after completion of the Self-Clean cycle.

The Self-Clean time is variable from 2 to 4 hours to offer flexibility in handling various soil conditions. A 2-hour cycle normally handles a moderately soiled oven, whereas a 4-hour cycle is recommended for a heavily soiled condition. The Self-Clean cycle can also be delayed to start at a later time if desired.

▼ IMPORTANT:

1. It is normal for some smoke to be emitted during the first few Self-Clean cycles.
2. Popping sounds are normal during Self-Clean cycles. These sounds are caused by the expansion and contraction of metal surfaces during heat-up and cool-down.
3. Do not line the oven with aluminum foil or other materials. These items can melt or burn during a Self-Clean cycle, causing permanent damage to the oven.

▼ WARNINGS:

1. DO NOT OPERATE THE OVEN LIGHTS IN THE SELF-CLEAN MODE.
2. Do not touch the outside surfaces of the oven during the Self-Clean cycle.
3. Do not use commercial oven cleaners inside the oven. Use of these cleaners can produce hazardous fumes or can permanently damage the porcelain finishes.

Prepare the oven for Self-Cleaning by following these steps:

1. Clean soil from the oven front frame area and the oven door outside of the door gasket. Cleaning the door gasket by hand can cause it to bend or move. A tight door seal is essential for proper baking and Self-Cleaning. Rinse surfaces well with a solution of vinegar and water, then wipe dry. Heavily soiled areas may be cleaned with a non-scratching scouring pad.
2. Remove the broiler pan, all cookware, utensils and other loose items from the oven chamber. Also, remove all oven racks and the convection fan filter to prevent them from permanently discoloring. However, to clean stubborn particles in the convection filter you may elect to simply leave it in place during self-clean. The filter will discolor due to the high heat, but this will not harm the filtering capabilities.

▼ IMPORTANT:

If racks are left in the oven during a Self-Clean cycle, it will affect their ability to slide in and out easily. Polish the rack edges with a soapy steel wool pad, then apply a small amount of vegetable oil to the edges so that the racks will slide more easily.

- Wipe up excess grease and other food spills with a damp cloth. This will minimize smoke and increase the efficiency of the Self-Clean cycle.
- Turn on kitchen fans or vents to help remove odors during the Self-Clean cycle.

Follow these steps to Self-Clean the oven:

- Complete all steps listed above for preparing the oven for Self-Cleaning.
- Close the oven door completely.
- Press the "SELF-CLEAN" touch pad. The oven will beep once, "CLEAN" will flash, and "--:--" will be displayed.
- Press the "TIME•TEMP" "+" pad and the default time of "2:00" hours will be displayed.
- Increase the self-clean time up to 4 hours (depending upon the amount of oven soil) by holding the "TIME•TEMP" "+" pad.
- To delay the self-clean start to a more convenient time, press the "STOP TIME" touch pad. Then, press the "TIME•TEMP" "+" pad to set the time of day for the cycle to be complete. "DELAY TIMED" will appear in the clock display. The cycle can be delayed up to 11 hours and 50 minutes.
- Approximately 30 to 60 seconds after selecting Self-Clean, the automatic door latch will lock the door. "LOCK" and "ON" will appear in the clock display. The oven will begin heating. The "ON" indicator will cycle on and off with the burner.

NOTE:

If Delay Timed mode has been set, the "ON" display and the oven heat will not turn on until the programmed time has been reached.

IMPORTANT:

If the door is not closed completely, the automatic door latch will not be able to lock the door when the Self-Clean mode is selected. In this case, "door" will flash in the clock display. If this occurs, press the "CANCEL•SECURE" pad and wait approximately 1 minute. Repeat the Self-Clean steps from the beginning, being certain to close the door completely. Do not try to force the door open after it is locked, as the automatic latch can be damaged. If you need to unlock the door, turn off the Self-Clean cycle by pressing the "CANCEL•SECURE" pad. After approximately 1 minute, "LOCK" will disappear from the clock display, and the door will unlock. The door will remain locked until the oven temperature falls below 390°F. Do not select any cooking function until the oven door is unlocked.

- About 50 to 60 minutes will be required for the oven to reach the Self-Clean temperature.
- The Self-Clean cycle can be stopped at any time by pressing "CANCEL•SECURE."

- After completion of the Self-Clean cycle, the oven will stop heating and the "ON" and "CLEAN" indicators will disappear from the clock display. Press the "CANCEL•SECURE" pad.
- After the interior oven temperature falls below 390°F, the door latch will release and "LOCK" will disappear from the clock display. The door can now be opened.
- Open the door. After ensuring that the oven has cooled sufficiently to be safe, use a damp cloth or sponge to wipe out the powder residue found in the bottom of the oven. If white spots remain in the oven, remove them with a non-scratch scouring pad before using the oven again. These spots are normally salt that cannot be removed by a Self-Clean cycle.
- Re-install the oven racks and convection fan filter before cooking in the oven.

IMPORTANT:

With the oven at room temperature, if the Self-Clean mode is accidentally selected and the oven enters Self-Clean mode (indicated by "LOCK" and "ON" in the clock display), the user must cancel out of this mode before attempting to select a different mode. To cancel, press the "CANCEL•SECURE" pad. Wait at least 60 seconds before attempting to select another mode. This allows the door latch time to unlock. The user may find the temperature in their new oven to be different from that of their previously-owned appliance. Familiarity with the old appliance sometimes makes it difficult to get used to a new oven. If you feel that the oven temperature is consistently high or low, the temperature of the new oven can be adjusted. The adjustment needs to be done only once. (Refer to Adjusting the Oven Temperature)

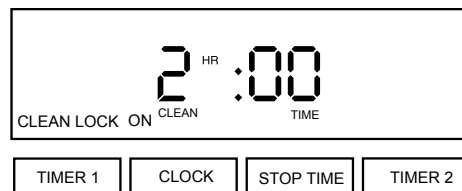

Clock Display in Self-Cleaning Mode

SELF-CLEANING TIPS

- If any soil remains in the oven after completion of a Self-Clean cycle, repeat the cycle if desired. Increase the cleaning time during future cycles.
- Clean the oven regularly to prevent excessive soil build-up. This will increase the efficiency of the Self-Clean cycle and reduce the amount of smoke and odors generated.
- Self-Clean in the cooler evening hours after cooking is complete and when electricity rates are lower.
- In the 48 inch model Ranges, if one oven is in the Self-Clean mode the second oven is inoperable.

Adjusting the Oven Temperature

The oven temperature may be adjusted (calibrated) by following these steps:

- Press "BAKE" selector pad.
- Press the "TIME•TEMP" "+" pad to set a temperature of 500°F or higher.

- Press and hold the "BAKE" selector pad. After approximately 5 seconds the temperature display is replaced by "00". The "BAKE" pad can now be released. The calibration mode has been accessed.
- Press the "TIME•TEMP" "+" or "-" pad to set the amount of temperature adjustment. The temperature can be changed a maximum of 35°F higher or lower. Set the adjustment to positive (+) numbers to increase the oven temperature; set the adjustment to negative (-) numbers to reduce the oven temperature. Temperatures can be adjusted in increments of 5°F.
- After setting the desired temperature adjustment, press the "CANCEL•SECURE" pad to exit the calibration mode and to reset the clock display.



Clock Display When Adjusting (Calibrating) the Oven Temperature

NOTES:

- If "CANCEL•SECURE" is not pressed after setting the adjustment, the clock display will automatically reset in 6 seconds.
- The amount of temperature adjustment may be changed again by repeating the calibration procedure. The oven will only retain the amount of the most recent temperature adjustment.
- The temperature adjustment is not affected by an electrical power failure.
- The temperature adjustment only affects Bake and Convection modes. Broil and Self-Clean temperatures cannot be adjusted.

Replacing the Oven Lights

Your new range has halogen oven lights to enhance the view into the oven. The light assembly consists of a removable lens cover and 10-watt 120VAC halogen bulb, as well as a light fixture housing. Light bulb replacement is considered to be a homeowner maintenance operation.

WARNINGS:

To prevent electrical shock and/or personal injury:

- Make certain that the oven and light bulb are cool and that power to the oven has been turned off before replacing the light bulb.
- Always ensure that the lens cover is in place when using the oven. The lens cover protects the bulb from breakage caused by high oven temperatures or mechanical shock.

To replace a light bulb, follow these steps:

1. Turn off the power at the main power supply.
2. Remove the lens cover from the housing by pulling straight out.

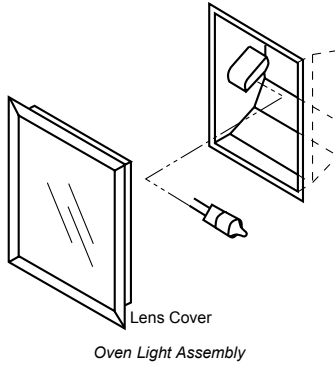

NOTE:

In some cases the lens cover may be tight enough to require the use of your light lens pry stick. This tool was packed inside of your broiler pan along with the Use & Care Manual. This prying tool should be used with

caution. Do not cause uneven stress on the lens cover. Gently insert the point end of the pry stick under the center edge of the lens cover on the side facing the oven door. Hold your hand under the lens for support then pry out to remove the lens cover.

3. Pull the light bulb out and replace it with a special 10-watt halogen bulb rated for use in a Self-Cleaning oven. Use DACOR Part No. 86364 available from any authorized DACOR parts distributor or service agency.
4. Reinstall the lens cover by aligning the cover over the opening and gently pressing it into its original position.
5. Turn the power back on at the main power supply.
6. Reset the time of day. (Refer to the Setting the Time of Day.)

NOTES:

EGR30 Model Only:

To replace a light bulb, follow these steps:

1. Turn off the power at the main power supply.

2. Remove the threaded lens cover from the housing by rotating counter-clockwise.
3. Pull the light bulb out and replace.
4. Reinstall the threaded lens cover by rotating clockwise.
5. Turn the power back on at the main power supply.
6. Reset the time of day. (Refer to the Setting the Time of Day.)



Troubleshooting

Unnecessary service calls may be expensive, frustrating and time-consuming. Before you call for service, please review the potential problems, possible causes and remedies shown in the table below. Failure Codes will appear where the temperature is normally displayed.

IMPORTANT:

If a Failure Code is displayed, the oven will beep continuously until the user presses the "CANCEL•SECURE" button. The oven will not heat after a failure. Call a qualified appliance technician to repair the oven.

Problem	Possible Cause	Remedy
Nothing works.	Oven is not connected to electrical power.	Have oven connected to a properly sized electrical power supply by a qualified technician.
	Power supply is not energized.	Have an electrician check power supply, including the house circuit breaker, wiring and fuses.
Oven will not heat.	Oven settings are not correct.	Follow mode selection and clock settings as specified in OVEN OPERATION.
	Oven is set for Delay Timed Cooking,	Oven will turn on automatically at present time. If desired, press "CANCEL•SECURE" touch pad to cancel out of Delay Timed Cooking
Clock displays incorrect time of day.	Time of day is not set.	Press "CLOCK" touch pad, then press "TIME•TEMP" pad to set correct time of day.
	Power supply has been interrupted.	Reset time of day.
Foods over-cook.	Incorrect cooking time, temperature.	Adjust time, temperature or rack position.
	Oven temperature calibration differs from your previous oven.	Adjust oven temperature as per ADJUSTING THE OVEN TEMPERATURE.
Foods under-cook.	Incorrect cooking time, temperature.	Adjust time, temperature or rack position.
	Oven temperature calibration differs from your previous oven.	Adjust oven temperature as per ADJUSTING THE OVEN TEMPERATURE.
Oven does not Self-Clean.	Door is not shut tight, so automatic door latch will not lock.	Close door tightly.
	Oven settings are not correct.	Follow mode selection and clock settings as specified in SELF-CLEANING.

	Oven is set for Delay Timed Cleaning	Oven will turn on automatically at preset time. If desired, press "CANCEL•SECURE" touch pad to cancel out of Delay Timed Cleaning
Oven will not work.	Light bulb is burned out.	Follow REPLACING THE OVEN LIGHT.
Door will not open.	Oven is in Self-Clean mode.	If oven is hot, door latch will release automatically when oven temperature falls below 390°F at end of cycle. If Self-Clean was just selected and the oven is still cool, press "CANCEL•SECURE" to turn off Self-Clean. The door will open in about 30 seconds.
Oven will not heat after Self-Clean.	Time of day is not set due to power failure.	Press "CLOCK" touch pad, then press "TIME•TEMP" pad to set correct time of day.
	Oven settings are not correct.	Follow mode selection and clock settings as specified in OVEN OPERATION.
	Oven is set for Delayed Time mode.	Oven will turn on automatically at present time. If desired, press "CANCEL•SECURE" button to cancel out of Delay Timed mode.
Igniters do not spark.	Circuit breaker is tripped.	Reset circuit breaker.
	House fuse is blown.	Replace house fuse.
	Power outage in local area.	Contact power company.
Sparking but no flame ignition.	Gas shut-off valve is in "off" position.	Turn shut-off valve to "on" position.
	Gas supply is interrupted.	Contact gas company.
Burners ignite but flame is extremely large, distorted or yellow.	Burner ring ports are clogged.	Clean burner ring ports with straightened paper clip, needle or wire.
	Burner ports or burner caps are not positioned properly.	Remove and carefully re-install burner rings and caps.
	Cooktop is being operated on the wrong type of gas.	Ensure that the type of cooktop matches the gas supply (natural gas or L.P. gas).
	Regulator is not installed, is faulty or is set for the wrong type of gas.	Check installation, replace regulator, or set regulator for proper gas.
Burner flame goes out at low setting.	Low gas supply pressure.	Contact gas company.
	Air intake holes around knobs are obstructed.	Remove obstruction.
Igniters spark continuously after flame ignition.	Power supply is not grounded.	Have power supply properly grounded.
	Power supply polarity is reversed.	Have polarity corrected.
	Igniters are wet or dirty.	Dry or clean igniters.

Troubleshooting Guide (Continued)

Clock Display	Cause
F0	Touch pad is stuck in a depressed position.
F1	Relay circuit failure.
F2	Oven temperature exceeded the clean runaway temperature (Self-Clean mode only) or the cooking runaway temperature (cooking modes only).
F3	Short circuit in the oven temperature sensor.
F4	Open circuit in the oven temperature sensor.
F6	Failure in the EEPROM check comparison. (Only time of day and timer will operate.)
F7	Failure of the Self-Clean automatic door latch circuit.
F8	Failure of the door latch motor.

Oven Failure Codes

Product Maintenance

No maintenance, other than the **CARE AND CLEANING INSTRUCTIONS** identified in this **Use & Care Manual**, should be attempted by the owner/operator. All other maintenance and service must be performed by a qualified appliance technician.

If You Need Service...

First, review the recommended checks listed in the preceding **Troubleshooting Guide**. Then, be certain that the appliance has been installed properly and is being operated correctly. Familiarize yourself with the warranty terms and conditions listed in the **PRODUCT WARRANTY** section.

If the above checks have been completed and the problem has not yet been remedied, call your local authorized DACOR service representative. Your dealer can normally provide the name and telephone number of the nearest service company.

DACOR works diligently to ensure your satisfaction when service is necessary. However, if you are not completely satisfied with the service provided, contact the company that performed the service and express why you are not pleased. Normally, they will be willing and able to resolve the problem.

If the service agency is not able to respond effectively, call or write the DACOR Customer Service Department. The phone number and address of this department are listed on the inside front cover of this manual. Please include your telephone number if you choose to write. We will then do our utmost to assure your happiness and satisfaction.

What Is Covered

CERTIFICATE OF WARRANTIES
DACOR RANGES

WITHIN THE FIFTY STATES OF THE U.S.A., THE DISTRICT OF COLUMBIA AND CANADA*:

FULL ONE-YEAR WARRANTY

If your DACOR product fails to function within one year of the original date of purchase, due to a defect in material or workmanship, DACOR will remedy the defect without charge to you or subsequent users. The owner must provide proof of purchase, upon request, and have the appliance accessible for service.

* Warranty is null and void if non-CSA approved product is transported from the U.S.

OUTSIDE THE FIFTY STATES OF THE U.S.A., THE DISTRICT OF COLUMBIA AND CANADA:

LIMITED FIRST YEAR WARRANTY

If your DACOR product fails to function within one year of the original date of purchase, due to a defect in material or workmanship, DACOR will furnish a new part, F.O.B. factory, to replace the defective part. All delivery, installation and labor costs are the responsibility of the purchaser. The owner must provide proof of purchase, upon request, and have the appliance accessible for service.

What Is Not Covered

- Service calls to educate the customer in the proper use and care of the product.
- Failure of the product when used for commercial, business, rental or any application other than for residential consumer use.
- Replacement of house fuses or fuse boxes, or resetting of circuit breakers.
- Damage to the product caused by accident, fire, flood or other acts of God.
- Breakage, discoloration or damage to glass, metal surfaces, plastic components, trim, paint, or other cosmetic finish, caused by improper usage or care, abuse, or neglect.

THE REMEDIES PROVIDED FOR IN THE ABOVE EXPRESS WARRANTIES ARE THE SOLE AND EXCLUSIVE REMEDIES. THEREFORE, NO OTHER EXPRESS WARRANTIES ARE MADE, AND OUTSIDE THE FIFTY STATES OF THE UNITED STATES, THE DISTRICT OF COLUMBIA AND CANADA, ALL IMPLIED WARRANTIES, INCLUDING BUT NOT LIMITED TO, ANY IMPLIED WARRANTY OF MERCHANTABILITY OR FITNESS FOR A PARTICULAR USE OR PURPOSE, ARE LIMITED IN DURATION TO ONE YEAR FROM THE DATE OF ORIGINAL PURCHASE. IN NO EVENT SHALL DACOR BE LIABLE FOR INCIDENTAL EXPENSE OR CONSEQUENTIAL DAMAGES. NO WARRANTIES, EXPRESS OR IMPLIED, ARE MADE TO ANY BUYER FOR RESALE.

Some states do not allow limitations on how long an implied warranty lasts, or do not allow the exclusion or limitation of inconsequential damages, so the above limitations or exclusions may not apply to you. This warranty gives you specific legal rights, and you may also have other rights that vary from state to state.

NOTES:

NOTES:

fold here

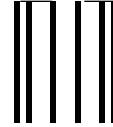

NO POSTAGE
NECESSARY
IF MAILED
IN THE
UNITED STATES

BUSINESS REPLY MAIL
FIRST-CLASS MAIL PERMIT NO. 4507 DIAMOND BAR CA

POSTAGE WILL BE PAID BY ADDRESSEE

ATTN: WARRANTY PROCESSING DEPT
DACOR
1440 BRIDGEGATE DR STE 200
PO BOX 6532
DIAMOND BAR CA 91765-9861

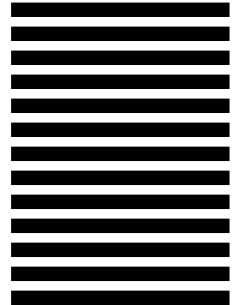



Please visit www.dacor.com to activate your warranty online.

WARRANTY INFORMATION



IMPORTANT:

Your warranty for this product **CANNOT BE ACTIVATED** until this form has been returned to Dacor. If you have purchased more than one Dacor product, Please return all forms in one envelope.

Please rest assured that under no conditions will Dacor sell your name or any of the information on this form for mailing list purposes. We are very grateful that you have chosen Dacor products for your home and do not consider the sale of such information to be a proper way of expressing our gratitude!

(Please Print or Type)

Owner's Name: _____
Last First Middle

Street: _____

City: _____ State: _____ Zip: _____

Purchase Date: _____ Email: _____ Telephone: _____

Dealer: _____

City: _____ State: _____ Zip: _____

Your willingness to take a few seconds to fill in the section below will be sincerely appreciated. Thank you.

1. How were you **first** exposed to Dacor products? (Please check one only.)

- A. T.V. Cooking Show
- B. Magazine
- C. Appliance Dealer Showroom
- D. Kitchen Dealer Showroom
- E. Home Show
- F. Builder
- G. Architect/Designer
- H. Another Dacor Owner
- I. Model Home
- J. Other _____

2. Where did you buy your Dacor appliances?

- A. Appliance Dealer
- B. Kitchen Dealer
- C. Builder Supplier
- D. Builder
- E. Other _____

3. For what purpose was the product purchased?

- A. Replacement **only**
- B. Part of a Remodeled
- C. New Home
- D. Other _____

4. What is your household income?

- A. Under \$75,000
- B. \$75,000 – \$100,000
- C. \$100,000 – \$150,000
- D. \$150,000 – \$200,000
- E. \$200,000 – \$250,000
- F. Over \$250,000

5. What other brands of appliances do you have in your kitchen?

- A. Cooktop _____
- B. Oven _____
- C. Dishwasher _____
- D. Refrigerator _____

6. Would you buy or recommend another Dacor product?

- Yes
- No

Comments: _____

Thank you very much for your assistance. The information you have provided will be extremely valuable in helping us plan for the future and giving you the support you deserve.

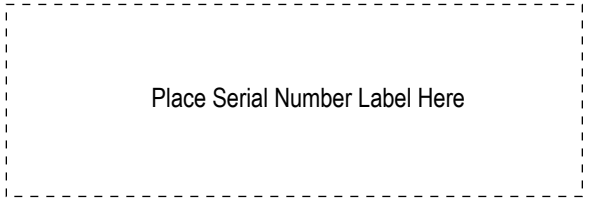

cut here

cut here