

SAFETY IS EVERYONE'S RESPONSIBILITY. ALL DACOR APPLIANCES ARE DESIGNED AND CONSTRUCTED TO GIVE YOU MANY YEARS OF SAFE OPERATION. THE OPERATION WILL BE FURTHER ENHANCED IF PROPER CARE AND JUDGEMENT ARE EXERCISED IN THE USE AND MAINTENANCE OF THIS APPLIANCE.



WARNINGS:

Must be followed carefully to avoid personal injury or damage.



NOTES:

Contains helpful hints and tips.

IMPORTANT INFORMATION

- Operating Instructions
- Care and Cleaning Instructions
- Safety Tips

Please Read Before Using Your Wall Oven

Place Serial Number Label Here



Dear DACOR Consumer,

Congratulations! You have purchased the very latest in kitchen appliances. Your new DACOR product offers features, styling and performance not found in any other appliance.

Please read this manual before operating your new appliance. It is imperative that you read the IMPORTANT INSTRUCTIONS section and become familiar with the controls and procedures to understand the full potential of this product.

All DACOR appliances are designed and manufactured to meet the highest quality standards. Each unit is thoroughly tested. Should you have a problem, however, please first check the PROBLEM SOLVING section in this manual. This section contains a checklist of possible problems and solutions that may save you the time and expense of an unnecessary service call.

If you cannot readily find the solution to the problem, please contact your nearest DACOR Authorized Service Representative. In the unlikely event they are unable to solve your problem to your satisfaction, please contact DACOR Customer Service.

Web site: www.dacor.com
For a Dealer/Service: (800) 772-7778
Corporate Phone: (800) 793-0093
Fax: (626) 441-9632
Business Hours: 7:30 A.M. to 4:00 P.M. Pacific Time

DACOR Customer Service
1440 Bridge Gate Dr.
Diamond Bar, CA 91765

Thank you for selecting DACOR for your home. We are dedicated to you and ensure that this appliance in your home will bring years of outstanding performance for your family and friends.

Sincerely,

S. Michael Joseph
Chairman/CEO

TABLE OF CONTENTS	1
Purpose of this Manual	1
Product Registration	1
IMPORTANT INSTRUCTIONS	1
What To Do	1
What Not To Do	1
OVEN OPERATION	2-7
Getting Started	2-3
What is Pure Convection™?	3
Setting the Time of Day	3
Oven Modes	3
Oven Racks & Supports	3
Oven Mode Selection	4
Preheating the Oven	4
Using the Minute Timers	4
Securing the Controls	4
Baking/Roasting	4-5
Multiple Rack Baking	5
Oven GlideRack	5
Using the Temperature Probe	6
Timed/Delay Timed Cooking	7
Dehydrating/Defrosting	7
Broiling	7
CARE AND CLEANING	7-10
Control Panel	7
Door Handle & Control Housing	8
Door Glass	8
Stainless Steel Surfaces	8
Porcelain Surfaces	8
Brass and Chrome Surfaces	8
Broiler Pan and Grill	8
Oven Racks	8
Convection Fan Filter	8
Self-Cleaning	8-9
Adjusting the Oven Temperature	9
Replacing the Oven Light	10
PROBLEM SOLVING	10-12
Troubleshooting	10-11
Product Maintenance	12
If You Need Service	12
ACCESSORIES	12
PRODUCT WARRANTY	12
What Is Covered	12
What Is Not Covered	12

Purpose of This Manual

This **Use & Care Manual** is designed to enable you to properly operate and maintain your new cooktop. Please keep this manual handy for easy access and quick reference.

Additional information may be requested by e-mailing, writing or phoning the DACOR Customer Service Department. The address and phone number of this department are listed on the inside front cover of this manual.

What to Do

1. Begin by ensuring proper installation and grounding of the appliance by a qualified technician according to the accompanying Installation Instructions. Have the installer show you where the fuse or junction box is located so that you know how and where to turn off power.
2. Ensure that the oven is used only by those individuals who are able to operate it properly.
3. Use the oven only for cooking tasks expected of a home oven as outlined in this manual.
4. Properly clean and maintain the oven as recommended in this manual.
5. Use only dry potholders to avoid steam burns when removing hot cookware.
6. Exercise caution when opening the oven door. Let hot air or steam escape before looking or reaching into the oven.
7. Allow the oven cool air intake (located below the door handle) to remain unobstructed at all times.
8. Position oven racks in desired locations when the oven is cool. (If a rack must be repositioned after the oven is already hot, be certain that the potholder does not contact a hot heating element in the oven.)
9. Before Self-Cleaning the oven, remove the broiler grill and pan, oven racks, convection fan filter and any other utensils.
10. Clean only those parts listed in this manual.

What Not to Do

1. Do not use the oven for warming or heating the room.
2. Do not leave children alone or unattended in the area where the oven is in use. Never allow children to sit or stand on any part of the oven. Do not let children play with the oven.

3. Do not store items of interest to children above the oven. Children could be burned or injured while climbing on the appliance.
4. Do not wear loose or hanging apparel while using the oven.
5. Do not store combustible, flammable or explosive materials in the oven or in adjacent cabinets.
6. **CAUTION: DO NOT LEAVE FOOD OR COOKING UTENSILS, ETC., IN THE OVEN DURING THE SELF-CLEAN CYCLE.**
7. Do not repair or replace any part of the oven unless specifically recommended in literature accompanying this appliance. All other service should be referred to a qualified technician.
8. Do not use water on grease fires. A violent steam explosion may result. Smother any flames with a lid, cookie sheet or flat tray. Flaming grease can be extinguished with baking soda or foam extinguisher.
9. Do not allow potholders to touch hot surfaces. Do not use towels or bulky cloth as potholders.
10. Do not use commercial oven cleaners or oven liner protective coatings on any part of the oven.
11. Do not clean the door gasket, because rubbing, moving or in any way damaging the gasket, may eliminate the required tight door seal.
12. **DO NOT TOUCH INTERIOR SURFACES OF THE OVEN.** During and after use, do not touch or let clothing or other flammable materials contact heating elements or interior surfaces of the oven until they have had sufficient time to cool.
13. Do not heat unopened food containers, such as baby food jars and cans. Pressure build up may cause the container to burst and cause injury.
14. Do not use abrasive or caustic cleaners or detergents on this appliance, as these may cause permanent damage. Do not use aerosol cleaners, as these may be flammable or cause corrosion of metal parts.
15. Do not allow acids (citrus juices, tomato sauces, etc.) to remain on the oven cell surfaces. The porcelain finish may stain.

If you received a damaged product, immediately contact your dealer or builder. Do not install or use a damaged appliance.

Product Registration

 Please enter the information requested in the spaces provided below. This information will be required in the unlikely event that a service call becomes necessary:

Model No. _____ Serial No. _____

Date Purchased _____ Date Installed _____

Purchased From _____

Address _____

Phone _____

Getting Started

Before using your oven, become familiar with the features and control panel layout.

Below the oven mode touch pads are three touch pads labeled "CANCEL•SECURE," "LIGHT" and "COOK TIME". The "CANCEL•SECURE" touch pad enables the user to cancel the selection of an oven mode or Delay Timed program, or disable the control panel by pressing and holding the pad for approximately three (3) seconds. Once the control panel is in the "SECURE" mode, "OFF" will be displayed on the clock. The "LIGHT" touch pad turns the interior oven light "on" and "off." The "LIGHT" touch pad will remain functional if the control panel has been disabled. The "COOK TIME" touch pad is used to select the length of time for a cooking process in Delay Timed cooking mode.

Clock functions are selected by pressing the touch pads located below the clock display and oven mode touch pads. Oven functions are chosen by pressing the touch pad for the desired mode. Once a clock or oven function has been chosen, a description of the selection will flash in the clock display area.

IMPORTANT:

After choosing a clock function or oven mode, you have six seconds to perform the next programming step. If the next step is not complete within six (6) seconds, the program selection displayed on the clock will disappear. Should this occur, just repeat the initial function selection.

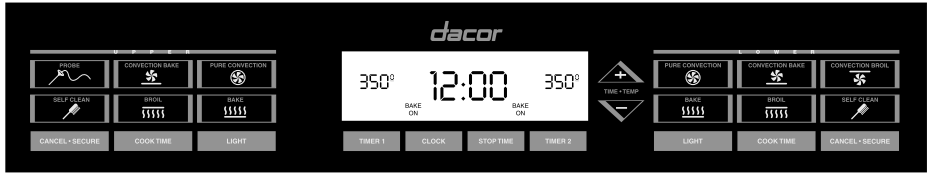
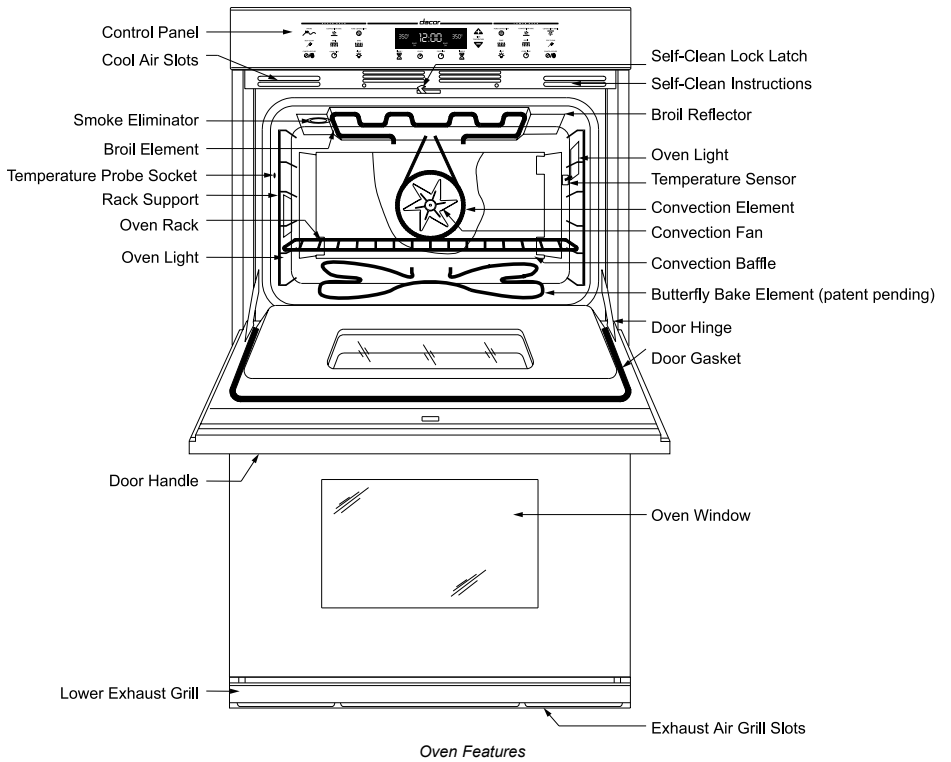

Epicure ECD227 and ECD230 Wall Oven Control Panel



Millennia MCD227 and MCD230 Wall Oven Control Panel

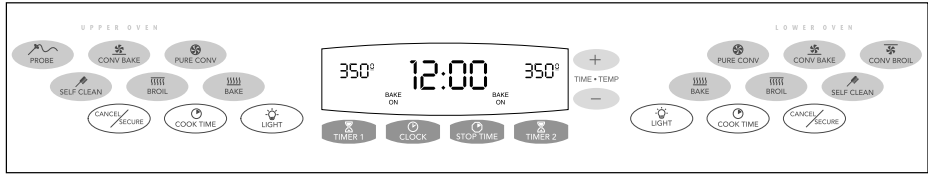

Millennia MCD227 and MCD230 Wall Oven Control Panel

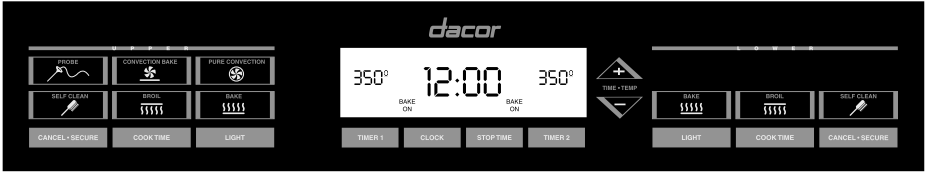

Epicure ECS227 and ECS230 Wall Oven Control Panel



Millennia MCS227 and MCS230 Wall Oven Control Panel

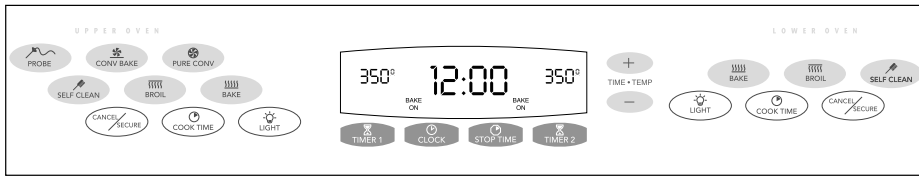

Preference PCS230 Wall Oven Control Panel



Epicure ECS127, ECS130 and ECS136 Wall Oven Control Panel



Millennia MCS127 and MCS130 Wall Oven Control Panel

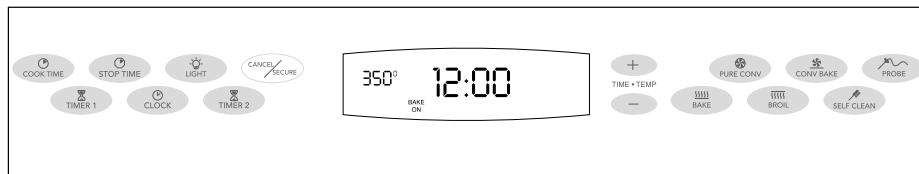

Preference PCS130 Wall Oven Control Panel

What is Pure Convection™?

Your new oven has the best cooking system available today, "Pure Convection™". Pure Convection™ is a total system approach to cooking. The heat source is a third element outside the cooking cell behind a "baffle." Not only does the baffle separate the food from the heat source, it channels the air from the "Convection Fan" evenly into the cell eliminating any hot or cool spots in the oven. This system is what allows multi-rack cooking while achieving even results from one rack to another.

The other component in Pure Convection™ is the "Filter." The filter eliminates the transference of flavors when cooking entire meals and also keeps the oven cleaner.

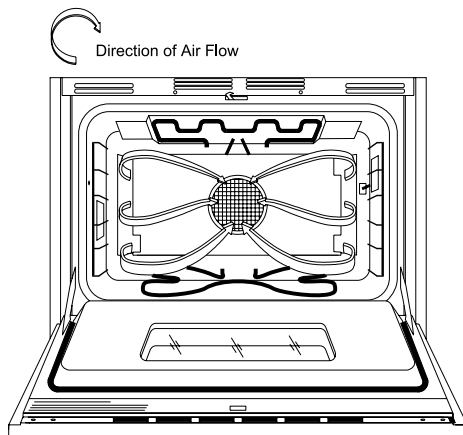

Heated Air Circulation Pattern in Convection Modes

Setting the Time of Day

Follow these two steps to set the correct time of day:

1. Press the "CLOCK" touch pad. The time of day will flash, "AM" or "PM" will be displayed, and "TIME" will flash in the display.
2. Press the touch pad "+" or "-" until the correct time of day is displayed and release.

Oven Modes

All oven modes are described below:

STANDARD BAKE – In Standard Bake mode, the bottom heating element provides conventional radiant heat. Temperatures may be set from 135° to 555°F in 5°F increments. Use Standard Bake for single rack baking and roasting.

STANDARD BROIL – The high wattage, top heating element supplies the heat in Broil mode. The broil temperature is adjustable from 135°F, to the "HI" setting (equivalent to 555°F) for greater cooking flexibility. Broiling is performed with the door closed.

CONVECTION BROIL – The high wattage, top heating element supplies the heat in Broil mode in combination with the convection fan for better heat distribution. The broil temperature is adjustable from 135°F to the "HI" setting (equivalent to 555°F) for greater cooking flexibility. Only available in ECD 230, PCD 230, and MCD230 models. Broiling is performed with the door closed.



PURE CONVECTION™ – In Pure Convection™ mode a third heating element, encircling the convection fan located in the rear of the oven chamber, acts as the heat source. The convection fan draws air from the oven chamber, then forces it across the hot convection heating element. The heated air is directed back into the oven chamber through the convection baffle. The baffle distributes the heated air evenly to ensure uniform results. Temperatures may be set from 135° to 555°F in 5°F increments. Use this mode for single rack baking, multiple rack baking, roasting, and preparation of complete meals.



CONVECTION BAKE – In this combination convection-radiant mode, the lower element provides the heat. As in Pure Convection™ mode, the convection fan and baffle combine to circulate heated air evenly throughout the oven chamber. Temperatures may be set from 135°F to 555°F in 5°F increments. Use this mode for single rack baking, multiple rack baking and roasting.



TEMPERATURE PROBE – The Temperature Probe can be used in combination with Standard Bake, Pure Convection™, or Convection Bake modes. The Temperature Probe takes the guesswork out of roasting by cooking food to the exact internal temperature you desire. The temperature range that the Probe will read is from 100°F to 200°F.



SELF-CLEAN – In the pyrolytic Self-Clean mode, the oven reaches temperatures of 850°F, thereby burning off oven soil automatically. The Self-Clean time is adjustable up to four hours so that varying degrees of oven soil can be successfully removed. Also, the Self-Clean cycle can be delayed to start at a later time if desired.

Oven Racks and Supports

Three chrome-plated convection racks are provided in the oven. Always remember to position the racks prior to heating the oven. Also, remove the oven racks prior to self-cleaning to prevent permanent discoloration of the racks.

The porcelain rack supports provide six heights for positioning of the oven racks.

To install a rack, align the left and right edges of the rack with the horizontal guide rails of the rack supports, then slide the rack into the oven.

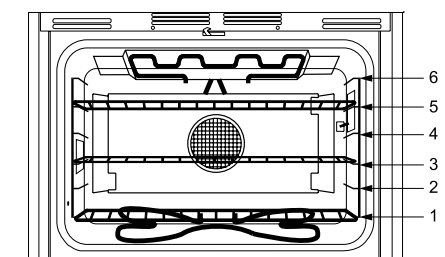

Oven Rack Positions

Oven Mode Selection

Follow these steps to manually operate the oven in Standard Bake, Pure Convection™ or Convection Bake mode:

1. Position oven rack(s) at the proper height(s).
2. Press the touch pad for "STANDARD BAKE", "PURE CONVECTION™" or "CONVECTION BAKE". The oven will beep once, the selected cooking mode will flash, and "--" will be displayed.
3. Press either the "+" or "-" pad. The default temperature of 350°F will be displayed.
4. To adjust the cooking temperature from 350°F, press and hold the "TIME•TEMP" pad. (Press "+" key to increase the temperature setting, "-" to decrease.) "PRE" and "ON" will appear in the clock display, and the oven will begin to heat. The convection fan will turn on to help stabilize the oven temperature during preheat. In standard bake mode, the convection fan will turn off once the desired temperature is attained. If in a convection mode, the convection fan will turn on. Also, the clock display will change from the desired cooking temperature to the actual oven temperature, starting with 135°F. The temperature display will increase in 5°F increments until the desired temperature is reached. The cooling fan will turn on when the oven temperature reaches 200°F. When the desired temperature is attained, the Preheat cycle is complete. The clock will beep once and "PRE" and "ON" will disappear from the display. (From this time forward, the "ON" display will cycle on and off with the heating elements.)
5. Carefully place the food onto the desired rack(s) within the preheated oven.
6. It is recommended that a Minute Timer be set to time the cooking process.
7. When the time expires and/or the food is done cooking, press the "CANCEL•SECURE" pad to turn off the oven.

Preheating the Oven

The oven features an automatic Preheat cycle that rapidly brings the oven chamber up to temperature. Simply by choosing a cooking mode and setting a temperature, the oven will automatically perform the Preheat function. The Preheat cycle operates in Standard Bake, Pure Convection™ and Convection Bake modes. There is no Preheat cycle for the Broil or Convection Broil modes.

Typically, 7 to 10 minutes are required to preheat the oven to 350°F, and 11 to 14 minutes are necessary to reach 425°F. Preheat times will be greater in those areas in which the electrical supply is less than 240 volts or 208 volts

NOTES:

1. **For faster heat up, the broil element comes on during Preheat. For best results, allow the oven to preheat prior to placing food inside.**

2. **The Preheat cycle is disabled during "PROBE" cooking. For best results, allow the oven to preheat in the desired mode prior to pressing the "PROBE" key.**

Using the Minute Timers

The clock features two timers that may be used to time cooking or other processes up to 11 hours, 50 minutes in length.

To use the Minute Timer function, follow these steps:

1. Press the touch pad labeled "TIMER 1", or "TIMER 2". The clock will display "00:00", and "TIMER 1", or "TIMER 2" will flash.
2. Press the "+" pad until the desired time is displayed on the clock.
3. After "TIMER 1" has expired, the clock will sound off with one second beeps and "TIMER 1" will appear in the display. After the "TIMER 2" minute timer has expired, the clock will sound alternating one and two second beeps and "TIMER 2" will appear in the display. The beeper can be silenced by pressing the "TIMER" touch pad while the beeper is sounding.

IMPORTANT:

Cancellation of the Minute Timer does not turn off the oven if it is operating. You must manually shut the oven off by pressing the "CANCEL•SECURE" touch pad. (See the Delay Timed Cooking section for automatic oven turn on and turn off.)

NOTES:

1. **To view the current time of day rather than the remaining time on the Minute timer, just press the "CLOCK" touch pad. To change back to a Minute Timer display, press the "TIMER 1" or "TIMER 2" touch pad.**
2. **To cancel the Minute Timer while in progress, press the "TIMER 1 or 2" touch pad two times. The clock display will return to the time of day.**
3. **The Minute timers may be used at the same time as Delay Timed Cooking or Self-Clean.**
4. **The Minute Timers will beep for 2 minutes (if not cancelled) before automatically shutting off.**
5. **Pressing the "CANCEL•SECURE" pad when the beeper is sounding will cancel both the beeper and the cooking function.**

Securing the Controls

To avoid accidentally turning the oven on, activate the "SECURE" feature. Press and hold the "CANCEL•SECURE" pad for approximately three seconds. This will disable the control panel and allow cleaning the controls without accidentally starting any functions. Three beeps will sound and "OFF" will appear in the display when the control panel has been secured.

To re-activate the control panel, again push and hold the "CANCEL•SECURE" pad for three seconds. Three beeps will sound and the "OFF" will disappear from the display.

Baking/Roasting

In addition to the conventional radiant-heat Standard Bake mode, your DACOR oven offers two convection baking modes: Pure Convection™ and Convection Bake. **All modes can be used to successfully prepare meals using standard recipes or your own personal favorites.**

Because of variations in food density, surface texture and consistency, there are a few foods that may be prepared more successfully in the Standard Bake mode. For this reason, Standard Bake mode is recommended when preparing baked goods such as custard. The user may find other foods that are also prepared more consistently in Standard Bake mode. This is perfectly normal.

1. As a general rule, to convert conventional Standard Bake recipes to convection recipes, reduce temperature by 25°F and the cooking time by approximately 10%.
2. Some recipes, especially those that are homemade, may require adjustment and testing when converting from standard to convection modes. If unsure how to convert a recipe, begin by preparing the recipe in Standard Bake mode. After achieving acceptable results this way, follow the convection guidelines listed. If the food is not prepared to your satisfaction during this first convection trial, adjust only one recipe variable at a time (such as cooking time, rack position or temperature) and repeat the convection test. If necessary, continue adjusting one recipe variable at a time until satisfactory results are achieved. **Common Baking Problems**, for additional information.
3. Do not open the oven door frequently during baking. Look through the door window to check the progress of baking whenever possible.
4. Use the Minute Timers to time baking functions
5. Wait until the shortest recommended baking time before checking food. For baked goods, a wooden pick placed in the center should come clean when the food is done.
6. **Bakeware Tips:**
 - Cakes, quick breads, muffins and cookies should be baked in shiny, reflective pans for light, golden crusts.
 - Medium gauge aluminum sheets with low sides should be used when preparing cookies, biscuits and cream puffs.
 - Bake most frozen foods in their original foil containers placed on a flat cookie sheet. Follow the package recommendations.

PROBLEM

1. Cookies and biscuits burn on the bottom.

PROBABLE CAUSE

Oven door opened too often

CORRECTION

Set Minute Timer to shortest recommended time and check food at this time. Use door window to check food.

Incorrect rack position being used. Pan too close to bake element.

Change rack position. Use Pure Convection™ mode.

Standard Bake or Convection Bake mode being used.

Use Pure Convection™ mode.

2. Cookies and biscuits are too brown on top.

Rack position being used is too high.

Change rack position.

Food was placed in the oven during pre-heat.

Wait until oven is pre-heated

3. Cakes burn on the sides or are not done in center.

Oven was too hot.

Reduce temperature.

4. Cakes crack on top.

Oven temperature was too high.

Reduce oven temperature.

5. Cakes are not level.

Oven and/or oven rack was not level.

Level oven and rack as needed.

6. Pies burn around edges or are not done in center.

Oven was too hot.

Reduce temperature.

Dark, heat absorbing pan is being used.

Use shiny, reflective pans.

7. Pies are too light in color on top.

Oven was not hot enough.

Increase oven temperature.

Oven and/or rack over crowded.

Reduce number of pans.

Common Baking Problems

- When using glass bakeware, reduce the recipe temperature by 25°F, except when baking pies or yeast breads. Follow the standard recipe baking time for pies and yeast breads.
7. Place pans carefully on the oven racks. Turn pans on the racks so that the long sides run left to right, parallel to the door.
 8. Adjustments to recipe times and temperatures will have to be made when baking at high altitudes. Consult a cookbook on high-altitude cooking.

Oven GlideRack™

Dacor's Oven GlideRack™ is designed to install effortlessly and glide at a full extension. Especially when using Dacor's pizza stone (model number ABS20), the full extension of the rack allows you to slide the pizza on and off the stone with great ease. It is also great for large roasts in large roasting pans. This easy- slide rack will allow you to baste more easily and check temperatures of the food more safely and quickly.

Helpful Hints When Using Your Oven GlideRack™:

1. This rack works particularly well with heavier items, although you can use it during any baking, broiling or roasting in your Dacor oven.
2. These racks will need to be spaced out when using more than one in the oven at a time. For instance, the racks should be used on rack positions 1,3, & 5 or 2 & 4, counting up from the bottom, instead of using racks 2,3, & 4.
3. When using the rack with Dacor's ABS20 baking stone, use rack position 1 for best results.
4. Heavier roasting pans and dishes will also cook better on Rack position 1.
5. Do not leave the rack in during self- clean. The rack will become difficult to slide in and out if it is self- cleaned. Remove all the racks and the filter in the back of the oven before self- cleaning..
6. To clean the rack, use hot, soapy water and the rough side of a sponge.

Multiple Rack Baking

The uniform air circulation provided by Pure Convection™ cooking enables the full oven capacity to be utilized. Many foods, such as pizzas, cakes, cookies, biscuits, muffins, rolls and frozen convenience foods can be successfully prepared on either two or three racks at the same time. Additionally, complete meals can be prepared by using multiple racks.

See below for specific recommendations. Follow the steps in the **Oven Modes** section to manually operate the oven, or refer to the **Delay Timed Cooking** section below for automatic operation.

Multiple Rack Baking Tips:

1. Typically, when baking on two racks, use rack positions #2 and #4 or #3 and #5. When baking on three racks, use rack positions #1, #3 and #5.
2. When adapting a single rack recipe to multiple rack baking, it may be necessary to add to the baking time. This is due to the extra mass of food in the oven.

Proper Installation of the Easy slide Oven Rack:

1. Fully extend the two side guides. Align two small clips on the bottom at the rear of the Oven GlideRack™ with the black porcelain rack guides in the oven.
2. Begin to slide the rack in, then lift up. The Oven GlideRack™ must be in between the two clips on the upper and lower side of the rack rear.
3. Push the rack all the way to the back.
4. Grasp the rack in the front center and pull. The rack should come forward while the side guides remain in place.

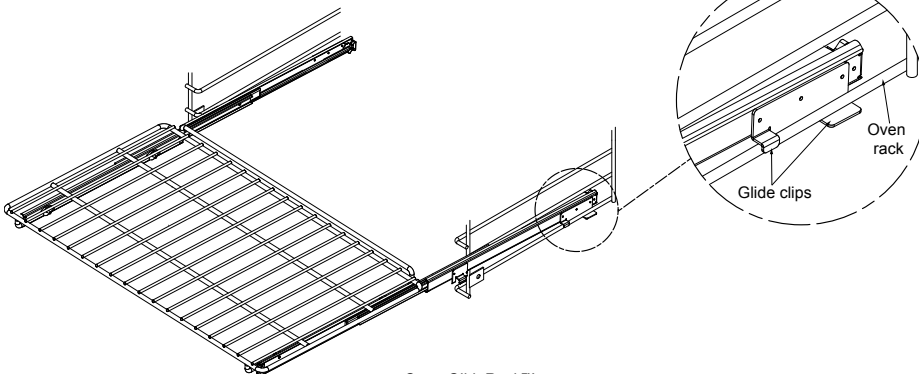

Oven GlideRack™

Using the Temperature Probe

For many foods, especially roasts and poultry, internal food temperature is the best test for properly cooked food. The Temperature Probe takes the guesswork out of roasting by cooking food to the exact temperature you desire.

NOTES:

Double Oven models have a Temperature in the upper oven only.

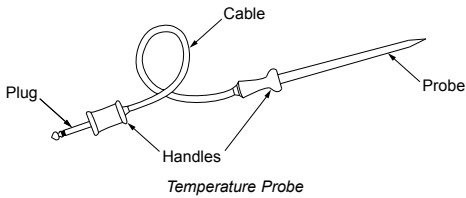

IMPORTANT

1. Use of probes other than the one provide with your wall oven may result in damage to the probe and/or the wall oven.
2. Use the handles of the Temperature Probe and plug when inserting and removing them from the food and outlet.
3. Do not use tongs to pull the cable when removing the Probe. Do so could damage the Probe.
4. Make sure the food is completely defrosted before inserting the Probe to avoid breaking the Probe.
5. Never leave the Temperature Probe inside the oven during Self-Clean mode.
6. To prevent the possibility of burns, unplug the Temperature Probe using hot pads.
7. Do not store the Probe inside the oven.

Proper Temperature Probe Placement:

1. Lay the Probe on the outside of the meat along the top or side and mark with your finger where the edge of the meat comes to on the Probe. The point should rest in the center of the thickest meaty part of the roast.
2. Insert the Probe to the point marked by your finger into the meat. The Probe should not touch the bone, fat, gristle or the bottom of the pan.
 - For roasts with no bone, insert the Probe into the side of the roast in the center.
 - For bone-in ham or lamb, insert the Probe into the center of the lowest large muscle or joint.
 - For dishes such as meat loaf or casseroles, insert the Probe into the center of the dish. When cooking fish, insert the Probe from just above the gill into the meatiest area, parallel to the backbone.
 - Insert the Probe into the meatiest part of the inner thigh from below, and parallel to the leg of a whole turkey.

Minimum Safe Internal Temperatures for Various Foods

Type & Cut	Internal Temp. (F)
Pork, ham, sausage and bacon	180
All foods previously served and cooled that are reheated	165 within two hours
All poultry and game birds (turkey, chicken, cornish game hen, duck, etc.)	180
Stuffed meats	165
Stuffing	165
Ground beef and ground pork	165
Fish and most other potentially hazardous food not listed in this table	145
Beef roasts (rare)	145
Beef steaks (rare)	145

Minimum Safe Internal Temperatures

Setting the Oven When Using the Temperature Probe:

1. Preheat the oven to the desired temperature. (**Convection Roasting Guide for Meats, Poultry and Fish**)
2. Insert the Temperature Probe into the food. (See Proper **Temperature Probe Placement** above.)
3. After the oven cell has reached the desired temperature, place the food into the oven.
4. Wearing an oven mitt, lift the probe outlet cover and plug the Temperature Probe into the outlet in the oven. (The outlet is located on the left inside oven wall near the front of the oven.) Make sure it is pushed all the way into the outlet. Close the oven door.
5.  Press the "PROBE" button. The Display will flash and beep "PRB" if the Probe is not inserted properly.
6. Adjust the temperature to the desired setting using the TIME•TEMPERATURE buttons. A jump-in temperature of 160° will appear when the TIME•TEMPERATURE key is first pressed. To change to the desired temperature, just press the TIME•TEMPERATURE key until you reach the desired temperature. The temperature can be set from 100-200°.
 - After the temperature has been set, the control panel temperature readout will default to 95°F, even if the food has not reached that temperature. The temperature readout will increase in 1°F increments until the food reaches the set temperature.
7. The oven will go to the "HOLD" mode for 2 hours after the internal temperature of the food has reached the desired temperature and will hold the oven temperature at 150°F. The residual heat of the oven will cause the internal temperature of the food to continue to climb. Use hot pads to remove the Temperature Probe from the food. Do not use tongs to pull on the Probe, it might be damaged.

NOTES:

After meat is pulled out of the oven, it will continue to cook. Carry-over cooking affects all foods. The larger the item, the longer the carry-over. It is best to let the meat rest after it comes out of the oven for 10 to 15 minutes. This will allow the meat to retain its juices and continue to set, making it easier to carve.

If the Probe is left inserted in the oven outlet when not in use, the control will beep and flash PRB until the Probe is unplugged. Unplugging the Probe from the oven turns the oven off.

Timed/Delayed Timed Cooking

This function allows the user to finish and/or start a cooking cycle automatically. It is especially useful for preparing meals in advance, or cooking while you are at work or play. Timed Cooking can only be used with Standard Bake, Pure Convections and Convection Bake modes. It will not function in the Broil modes.



Setting the Oven for Delayed Timed Cooking

NOTE:

For the double ovens, both the upper and lower chambers can be set for Delay Timed Cooking. However, both chambers must have the same "COOK TIMES" and "STOP TIMES".

WARNING:

Food safety is an important consideration when using delayed cooking modes. To avoid potential sickness and spoiling of food, take the following steps:

1. **Avoid using foods that will spoil while waiting for the cooking cycle to begin. Typical foods to avoid include those containing eggs and dairy products, cream soups, and cooked or uncooked meats, poultry and fish stand in the oven for more than two hours before cooking begins.**
2. **If cooking will not begin immediately, place only very cold or frozen food into the oven. Most unfrozen foods should never stand in the oven for more than two hours before cooking begins.**
3. **Do not allow foods to remain in the oven more than one hour after completion of the cooking cycle. When the temperature drops below 140°, bacteria can develop.**

To use Timed Cooking, follow these steps: (This mode will begin cooking immediately and turn off at the desired time.)

1. Position oven rack(s) at the proper height(s).
2. Place the food onto the center of the oven rack(s).
3. Select the desired cooking mode and temperature.
4. Press the "COOK TIME" pad and "TIME" will appear in the clock display. Press the "TIME•TEMP" "+" pad to set the length of time that the food will be cooked. The "COOK TIME" can be set from 5 minutes to 11 hours, 50 minutes.
5. After the "COOK TIME" has expired, the clock will beep three times, and "Hold" will be displayed. If cooking in a convection mode, the convection fan will also turn off at this time. While in "Hold" mode, the oven temperature will be maintained at 150°F for a period of two hours. "Hold" mode can be cancelled by pressing the "CANCEL•SECURE" touch pad. The cooling fan will continue to run depending upon the length and temperature of the cooking process.

To use Timed Cooking, follow these steps: (This mode allows the cooking process to start at a later time and finish at the desired time.)

1. Follow steps 1 thru 4 in the previous instructions for **Timed Cooking**.
2. Press the "STOP TIME" touch pad, and "STOP" will appear in the clock display. Press the "TIME•TEMP" "+" pad to enter the time of day that you wish the oven to shut off. "DELAY" will now be displayed. The oven will calculate the correct "START TIME." After the "COOK TIME" has expired, the clock will beep three times, and "Hold" will be displayed. If cooking in a convection mode, the convection fan will also turn off at this time. While in "Hold" mode, the oven temperature will be maintained at 150°F for a period of two hours. "Hold" mode can be cancelled by pressing the "CANCEL•SECURE" touch pad. The cooling fan will continue to run depending upon the length and temperature of the cooking process.

DELAYED TIMED COOKING TIPS:

1. Do not use foods containing baking powder or yeast in Delay Timed Cooking. These foods will not rise properly.
2. Remember that "COOK TIME" refers to the length of the cooking cycle. It does not refer to the start time!
3. The time required to preheat the oven must be included in the "COOK TIME." Thus, the "COOK TIME" should be increased by about 8 to 12 minutes depending upon the temperature setting. The top element does not come on to preheat in the Delay Mode, so you will not pre-maturely brown foods.

Dehydrating/Defrosting

The oven can be used to dehydrate or defrost foods at low heat settings in "Pure Convection™" mode.

Follow these steps to dehydrate or defrost foods:

1. Position oven rack(s) at the proper height(s).
2. Place the food onto the center of the oven rack. (For dehydrating, prepare food as recommended then place food onto a drying rack.)
3. Press the "PURE CONVECTION™" pad.
4. Set the temperature to 135°F. This is the minimum temperature that can be set. (For dehydrating, a higher temperature setting may be required. Follow the recommended temperature for the type of food being prepared.)
5. It is recommended that the user set the Minute Timer(s) to time the process.

Broiling

Broiling is a quick and flavorful way to prepare many foods, including steaks, chicken, chops, hamburgers and fish. **Broiling in the oven is completed with the oven door completely shut.** It is normal and necessary for some smoke to be present to give the food a broiled flavor. The broil temperature may be adjusted in 5°F increments from 135°F up to the maximum setting of "HI". The "HI" setting is equivalent to 555°F.

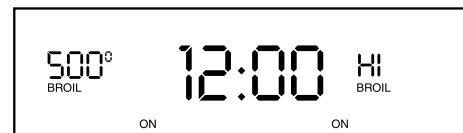

Clock Displaying Broil (double oven)

Follow these steps to operate the oven in Standard Broil or Convection Broil modes:

1. Close the door tightly.
2. Press the "BROIL" or "CONVECTION BROIL" pad.
3. Press the "TIME•TEMP" "+" or "-" pad and the default temperature setting "HI" will be displayed. "HI" is equivalent to 555°F.

4. If a temperature other than "HI" is desired, press the "TIME•TEMP" "-" pad to reduce the temperature. Six seconds after setting the temperature, the "ON" indicator will light up in the clock display, the broiler element will begin heating, and the cooling fan will turn on.
5. It is recommended that the user set the Minute Timer(s) to time the broiling process.
6. When the Minute Timer expires and/or the food is cooked, press the "CANCEL•SECURE" touch pad to turn off the oven. The cooling fan will continue to run for 30 to 45 minutes depending upon the length and temperature of the broiling process.

BROILING TIPS:

1. Always use a broiler pan and grill to provide drainage for excess fat and grease. This will reduce spatter, smoke and flare-ups.
2. Pre-heat the broiler for 10 minutes prior to cooking.
3. Begin with a room temperature broiler pan for even cooking.
4. Use tongs or a spatula to turn and remove meats. Never pierce meat with a fork as this allows juices to escape.
5. Broil food on the first side for slightly more than half of the recommended time, then season and turn. Season the second side just before removing.
6. To prevent sticking, lightly grease the broiler grill. Excess grease will result in heavy smoke. For easier cleaning, remove the broiler pan and grill when the food is removed. While the pan and grill are still warm, soak the pan and grill in a solution of hot water and dishwashing liquid, then scrub them with an abrasive pad.
7. To prevent sticking, lightly grease the broiler grill. Excess grease will result in heavy smoke.

⚠️ WARNINGS:

1. **To avoid electrical shock or burns, turn off all controls and ensure the oven is cool before cleaning.**
2. **Do not use harsh or abrasive cleaning agents, waxes, polishes, or commercial oven cleaners to clean the oven.**

Read and follow the **CARE AND CLEANING INSTRUCTIONS** to ensure that proper oven operation and appearance will be maintained throughout the lifetime of the product.

Several materials and finishes are used in the oven. Each material and finish must be properly cleaned according to the following recommendations. **Failure to follow these recommendations may result in permanent damage to the oven.**

Control Panel

To avoid accidentally turning the oven on while cleaning the control panel, activate the "Secure" feature. Press and hold the "CANCEL•SECURE" pad for approximately three seconds. This will disable the control panel and allow cleaning the controls without accidentally starting any functions. "OFF" will appear in the display when the control panel has been secured.

To re-activate the control panel, again push and hold the "CANCEL•SECURE" pad for three seconds. "OFF" will disappear from the display.

Clean the control panel with a solution of mild detergent and warm water. **DO NOT USE ABRASIVE CLEANERS OR SCRUBBERS. THEY WILL PERMANENTLY DAMAGE THE FINISH.** Dry the control panel completely with a soft, lint-free cloth.

Door Handle & Control Housing

Clean the door handle and control panel housing with a solution of mild detergent and hot water. Rinse and dry with a soft cloth. **DO NOT USE ABRASIVE CLEANERS OR SCRUBBERS. THEY WILL PERMANENTLY DAMAGE THE FINISH.**

Door Glass

Clean all glass surfaces with a solution of mild detergent and hot water. Use a mild glass cleaner to remove fingerprints or smears. Dry completely with a soft, lint-free cloth.

Stainless Steel Surfaces

On stainless steel ovens, the control panel, door(s) and exhaust grill are covered with stainless steel panels. Clean these surfaces with a solution of mild detergent and warm water. Rinse and dry with a soft, lint-free cloth.

If commercially available stainless steel cleaners are used, it is important to read the labels for chlorine compounds. Chlorine is a corrosive substance. If these compounds are present, rinse thoroughly and dry with a soft, lint-free cloth.

Always wipe stainless steel surfaces with the grain.

Porcelain Surfaces

The oven interior and inner door liners are finished in porcelain enamel. Clean these surfaces with a solution of mild detergent and hot water. Rinse and dry with a soft cloth. **Do not use abrasives or commercial oven cleaners.** Always remove excess grease and soil from the oven interior and door prior to using the Self-Cleaning cycle.

Brass, Chrome & Copper Surfaces

Clean these surfaces with a solution of mild detergent and warm water. Rinse, dry and polish with a soft, lint-free cloth.

If a commercially available polish is used, it is important to read the label for chlorine compounds. Chlorine is a corrosive substance and is not recommended for use with brass, copper or chrome finishes. If these compounds are present, rinse surface thoroughly and dry with a soft, lint-free cloth.

Follow manufacturer's instructions for application of polish.

Broiler Pan and Grill

The oven broiler pan and grill is finished in porcelain enamel. Clean both components in a solution of detergent and hot water. For heavy soil conditions, use a scouring pad such as steel wool with plenty of water. Rinse well after cleaning

Oven Racks

Oven racks are chrome-plated. For everyday cleaning, apply a solution of detergent and hot water. To clean heavy soil, use a scouring pad such as steel wool with plenty of water, or use a solution of 1 cup ammonia to 2 gallons of water. Remove racks during Self-Cleaning. If racks are left in the oven during self-cleaning, they will permanently discolor.

Convection Fan Filter

⚠ WARNING:

Remove the filter only when it is cool.

The convection fan filter is made of stainless steel. Remove the filter regularly for cleaning, as a clogged filter will reduce the effectiveness of convection cooking modes. Soak the filter in hot soapy water. Dry the filter completely before re-installing. Remove the filter during Self-Cleaning. If the filter is left in the oven during Self-Cleaning it will permanently discolor. **Re-install the filter before cooking in the oven again. Failure to do so will expose the convection fan blade that rotates at high speed during convection modes.**

Step 1: Orient the filter so that the two mounting tabs are towards the rear, open end down.

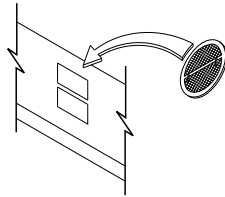

Removing and Installing the Convection Fan Filter
Step 1

Step 2: Hook the two mounting tabs over the center horizontal bar.

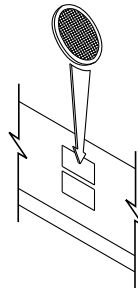

Removing and Installing the Convection Fan Filter
Step 2

Self-Cleaning

The electric door latch is a convenient safety feature. The door latch is automatically activated after selecting the Self-Clean mode. The latch ensures that the oven door cannot be opened while the interior oven temperatures are unsafe to the user.

The oven features an automatic pyrolytic Self-Cleaning cycle to eliminate the need for difficult and time-consuming manual scrubbing of interior surfaces. During this cycle, the oven reaches temperatures of 850°F to burn off soil and deposits. A powder ash residue is left in the bottom of the oven after completion of the Self-Clean cycle.

The Self-Clean time is variable from 2 to 4 hours to offer flexibility in handling various soil conditions. A 2-hour cycle normally handles a moderately soiled oven, whereas a 4-hour cycle is recommended for a heavily soiled condition. The Self-Clean cycle can also be delayed to start at a later time if desired.

⚠ IMPORTANT:

1. It is normal for some smoke to be emitted during the first few Self-Clean cycles.
2. Popping sounds are normal during Self-Clean cycles. These sounds are caused by the expansion and contraction of metal surfaces during heat-up and cool-down.
3. Do not line the oven with aluminum foil or other materials. These items can melt or burn during a Self-Clean cycle, causing permanent damage to the oven.

⚠ WARNINGS:

1. DO NOT OPERATE THE OVEN LIGHTS IN THE SELF-CLEAN MODE.
2. Do not touch the outside surfaces of the oven during the Self-Clean cycle
3. Do not use commercial oven cleaners inside the oven. Use of these cleaners can produce hazardous fumes or can permanently damage the porcelain finishes.

Prepare the oven for Self-Cleaning by following these steps:

1. Clean soil from the oven front frame area and the oven door outside of the door gasket. Do not clean the door gasket. Cleaning the door gasket by hand can cause it to bend or move. A tight door seal is essential for proper baking and Self-Cleaning. Rinse surfaces well with a solution of vinegar and water, then wipe dry. Heavily soiled areas may be cleaned with a non-scratching scouring pad.

- Remove the broiler pan and grill, all cookware, utensils and other loose items from the oven chamber. Also, remove all oven racks and the convection fan filter to prevent them from permanently discoloring. However, to clean stubborn particles in the convection filter you may elect to simply leave it in place during self-clean. The filter will discolor due to the high heat, but this will not harm the filtering capabilities
- Wipe up excess grease and other food spills with a damp cloth. This will minimize smoke and increase the efficiency of the Self-Clean cycle.
- Turn on kitchen fans or vents to help remove odors during the Self-Clean cycle.

IMPORTANT:

If racks are left in the oven during a Self-Clean cycle, it will affect their ability to slide in and out easily. Polish the rack edges with a soapy steel wool pad, then apply a small amount of vegetable oil to the edges so that the racks will slide more easily.

Follow these steps to Self-Clean the oven:

- Complete all steps listed above for preparing the oven for Self-Cleaning.
- Close the oven door completely.
- Press the "SELF-CLEAN" touch pad. The oven will beep once, "CLEAN" will flash, and "--:--" will be displayed.
- Press the "TIME•TEMP" "+" pad and the default time of "2:00" hours will be displayed.
- Increase the self-clean time up to 4 hours (depending upon the amount of oven soil) by holding the "TIME•TEMP" "+" pad.
- To delay the self-clean start to a more convenient time, press the "STOP TIME" touch pad. Then, press the "TIME•TEMP" "+" pad to set the time of day for the cycle to be complete. "DELAY TIMED" will appear in the clock display. The cycle can be delayed up to 11 hours and 50 minutes.
- Approximately 30 to 60 seconds after selecting Self-Clean, the automatic door latch will lock the door. "LOCK" and "ON" will appear in the clock display. The oven will begin heating. The "ON" indicator will cycle on and off with the burner.

NOTE:

If Delay Timed mode has been set, the "ON" display and the oven heat will not turn on until the programmed time has been reached.

IMPORTANT:

If the door is not closed completely, the automatic door latch will not be able to lock the door when the Self-Clean mode is selected. In this case, "door" will flash in the clock display. If this occurs, press the "CANCEL•SECURE" pad and wait approximately 1 minute. Repeat the Self-Clean steps from the beginning, being certain to close the door completely. Do

not try to force the door open after it is locked, as the automatic latch can be damaged. If you need to unlock the door, turn off the Self-Clean cycle by pressing the "CANCEL•SECURE" pad. After approximately 1 minute, "LOCK" will disappear from the clock display, and the door will unlock. The door will remain locked until the oven temperature falls below 390°F. Do not select any cooking function until the oven door is unlocked.

- About 50 to 60 minutes will be required for the oven to reach the Self-Clean temperature of 850°F.
- The Self-Clean cycle can be stopped at any time by pressing "CANCEL•SECURE."
- After completion of the Self-Clean cycle, the oven will stop heating and the "ON" and "CLEAN" indicators will disappear from the clock display. Press the "CANCEL•SECURE" pad.
- After the interior oven temperature falls below 390°F, the door latch will release and "LOCK" will disappear from the clock display. The door can now be opened.
- Open the door. After ensuring that the oven has cooled sufficiently to be safe, use a damp cloth or sponge to wipe out the powder residue found in the bottom of the oven. If white spots remain in the oven, remove them with a non-scratch scouring pad before using the oven again. These spots are normally salt that cannot be removed by a Self-Clean cycle.
- Re-install the oven racks and convection fan filter before cooking in the oven.

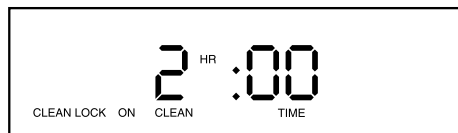

Clock Display in Self-Cleaning Mode

IMPORTANT:

With the oven at room temperature, if the Self-Clean mode is accidentally selected and the oven enters Self-Clean mode (indicated by "LOCK" and "ON" in the clock display), the user must cancel out of this mode before attempting to select a different mode. To cancel, press the "CANCEL•SECURE" pad. Wait at least 60 seconds before attempting to select another mode. This allows the door latch time to unlock.

SELF-CLEANING TIPS:

- If any soil remains in the oven after completion of a Self-Cleaning cycle, repeat the cycle if desired. Increase the cleaning time during future cycles.
- Clean the oven regularly to prevent excessive soil build-up. This will increase the efficiency of the Self-Clean cycle and reduce the amount of smoke and odors generated.

- Self-Clean in the cooler evening hours after cooking is complete and when electricity rates are lower.
- In the double oven, if one oven is in the Self-Clean mode the other oven is inoperable.

Adjusting the Oven Temperature

IMPORTANT:

The user may find the temperature in their new oven to be different from that of their previously-owned appliance. Familiarity with the old appliance sometimes makes it difficult to get used to a new oven. If you feel that the oven temperature is consistently high or low, the temperature of the new oven can be adjusted. The adjustment needs to be done only once.

The oven temperature may be adjusted (calibrated) by following these steps:

- Press "BAKE" selector pad.
- Press the "TIME•TEMP" "+" pad to set a temperature of 500°F or higher.
- Press and hold the "BAKE" selector pad. After approximately 5 seconds the temperature display is replaced by "00". The "BAKE" pad can now be released. The calibration mode has been accessed.
- Press the "TIME•TEMP" "+" or "-" pad to set the amount of temperature adjustment. The temperature can be changed a maximum of 35°F higher or lower. Set the adjustment to positive (+) numbers to increase the oven temperature; set the adjustment to negative (-) numbers to reduce the oven temperature. Temperatures can be adjusted in increments of 5°F.
- After setting the desired temperature adjustment, press the "CANCEL•SECURE" pad to exit the calibration mode and to reset the clock display.

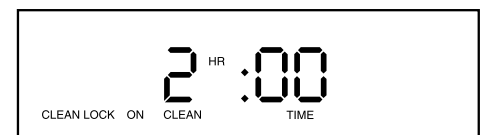

Clock Display When Adjusting (Calibrating) the Oven Temperature

NOTES:

- If "CANCEL•SECURE" is not pressed after setting the adjustment, the clock display will automatically reset in 6 seconds.
- The amount of temperature adjustment may be changed again by repeating the calibration procedure. The oven will only retain the amount of the most recent temperature adjustment.
- The temperature adjustment is not affected by an electrical power failure
- The temperature adjustment only affects Standard Bake and Convection Bake modes. Broil and Self-Clean temperatures cannot be adjusted.

Replacing the Oven Light(s)

The light assembly consists of a removable lens cover and 10-watt 120VAC halogen bulb, as well as a light fixture housing. Light bulb replacement is considered to be a homeowner maintenance operation.

⚠ WARNINGS:

To prevent electrical shock and/or personal injury:

1. Make certain that the appliance and light bulb are cool and that power to the appliance has been turned off before replacing the light bulb.
2. Always ensure that the lens cover is in place when using the appliance. The lens cover protects the bulb from breakage caused by high temperatures or mechanical shock.

To replace a light bulb, follow these steps:

1. Turn off the power at the main power supply.
2. Remove the lens cover from the housing by pulling straight out.

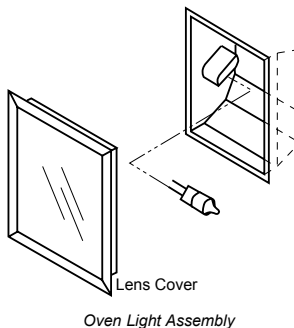

📖 NOTE:

In some cases the lens cover may be tight enough to require the use of your light lens pry stick. This prying tool should be used with caution. Do not cause uneven stress on the lens cover. Gently insert the point end of the pry stick under the center edge of the lens cover on the side facing the oven door. Hold your hand under the lens for support then pry out to remove the lens cover.

3. Pull the light bulb out and replace it with a special 10-watt halogen bulb rated for use in a Self-Cleaning oven. Use DACOR Part No. 86364 available from any authorized DACOR parts distributor or dealer.
4. Reinstall the lens cover by aligning the cover over the opening and gently pressing it into its original position.
5. Turn the power back on at the main power supply.

Troubleshooting

Unnecessary service calls may be expensive, frustrating and time-consuming. Before you call for service, please review the potential problems, possible causes and remedies shown below. Also, refer to the table on page 11 to view various oven failure codes that can be displayed by the clock. Failure Codes will appear where the temperature is normally displayed.

⚠ IMPORTANT:

If a Failure Code is displayed, the oven will beep continuously until the user presses the "CANCEL•SECURE" button. The oven will not heat after a failure. Call a qualified appliance technician to repair the oven.

Problem	Possible Cause	Remedy
1. Nothing works	Oven is not connected to electrical power	Have oven connected to a properly sized electrical power supply by a qualified electrician.
	Power supply is not energized.	Have an electrician check power supply, including the house circuit breaker, wiring and fuses
2. Oven will not heat..	Time of day is not set.	Press "CLOCK" touch pad, then press "TIME•TEMP" pad to set correct time of day.
	Oven settings are not correct	Follow mode selection and clock settings as specified in OVEN OPERATION section.
	Oven is set for Delay Timed Cooking.	Oven will turn on automatically at preset time. If desired, press "CANCEL•SECURE" touch pad to cancel out of Delay Timed Cooking. Change rack position.
3. Clock displays incorrect time of day.	Time of day is not set.	Press "CLOCK" touch pad, then press "TIME•TEMP" pad to set correct time of day.
	Power supply has been interrupted.	Reset time of day.
4. Foods over-cook.	Incorrect cooking time, temperature, or rack position being used.	Adjust time or temperature.
	Oven temperature calibration differs from your previous oven.	Adjust oven temperature as per ADJUSTING THE OVEN TEMPERATURE section.
5. Foods under-cook.	Incorrect cooking time, temperature, or rack position being used.	Adjust time or temperature.
	Oven temperature calibration differs from your previous oven.	Adjust oven temperature as per ADJUSTING THE OVEN TEMPERATURE section.
6. Oven does not Self-Clean.	Door is not shut tight, so automatic door latch will not lock.	Close door tightly.

	Oven settings are not correct.	Follow mode selection and clock settings as specified in the SELF-CLEANING section.
	Oven is set for Delay Timed Cleaning.	Oven will turn on automatically at preset time. If desired, press "CANCEL•SECURE" touch pad to cancel out Delay Timed Cleaning.
7. Oven light will not work.	Light bulb is burned out	Follow REPLACING THE OVEN LIGHT section.
8. Door will not open.	Oven is in Self-Clean mode.	If oven is hot, door latch will release automatically when oven temperature falls below 390°F at end of cycle. If Self-Clean was just selected and the oven is still cool, press "CANCEL•SECURE" to turn off Self-Clean. The door will open in about 30 seconds.
9. Oven will not heat after Self Cleaning.	Time of day is not set due to power failure.	Press "CLOCK" touch pad, then press "TIME•TEMP" pad to set correct time of day.
	Oven settings are not correct.	Follow mode selection and clock settings as specified in the OVEN OPERATION section. Oven will turn on automatically at preset time. If desired, press "CANCEL•SECURE" touch pad to cancel out of Delay Timed mode.

Troubleshooting Guide (Continued)

Clock Display	Cause
F0.	Touch pad is stuck in depressed position.
F1.	Relay circuit failure.
F2.	Oven temperature exceeded the clean runaway temperature (Self-Clean mode only) or the cooking runaway temperature (cooking modes only).
F3.	Short circuit in the oven temperature sensor.
F4.	Open circuit in the oven temperature sensor.
F6.	Failure in the EEPROM check comparison. (Only time of day and timer will operate.)
F7	Failure of the Self-Clean automatic door latch circuit.
F8.	Failure of the door latch motor. Occurs when the motor runs for two minutes without the door locking in Self-Clean mode.

Oven Failure Codes

Product Maintenance

No maintenance, other than the **CARE AND CLEANING INSTRUCTIONS** identified in this **Use & Care Manual**, should be attempted by the owner/operator. All other maintenance and service must be performed by a qualified appliance technician.

If You Need Service...

First, review the recommended checks listed in the preceding **Troubleshooting Guide**. Then, be certain that the appliance has been installed properly and is being operated correctly. Familiarize yourself with the warranty terms and conditions listed in the **PRODUCT WARRANTY** section.

If the above checks have been completed and the problem has not yet been remedied, call your local authorized DACOR service representative. Your dealer can normally provide the name and telephone number of the nearest service company.

DACOR works diligently to ensure your satisfaction when service is necessary. However, if you are not completely satisfied with the service provided, contact the company that performed the service and express why you are not pleased. Normally, they will be willing and able to resolve the problem.

If the service agency is not able to respond effectively, call or write the DACOR Customer Service Department. The phone number and address of this department are listed on the inside front cover of this manual. Please include your telephone number if you choose to write. We will then do our utmost to assure your happiness and satisfaction.

Accessories

For accessories call your local Dacor dealer.

Accessory Cookiesheets (3 in a carton): These Full sized cookie sheets maximize oven rack baking capabilities by utilizing the total useable rack space.

- 27" Oven Model No. ACS273
- 30" Oven Model No. ACS303
- 36" Oven Model No. ACS363

Replacement Oven Light Bulb

- IOW Halogen Part No. 86364

Stainless Steel Cleaner

- Elco Cleaner Part No. A302

What is Covered

CERTIFICATE OF WARRANTIES DACOR WALL OVENS

WITHIN THE FIFTY STATES OF THE U.S.A., THE DISTRICT OF COLUMBIA AND CANADA*:

FULL ONE YEAR WARRANTY

If your DACOR product fails to function within one year of the original date of purchase, due to a defect in material or workmanship, DACOR will remedy the defect without charge to you or subsequent users. The owner must provide proof of purchase upon request and have the appliance accessible for service.

* Warranty is null and void if non-CSA approved product is transported from the U.S.

OUTSIDE THE FIFTY STATES OF THE U.S.A., THE DISTRICT OF COLUMBIA AND CANADA:

LIMITED FIRST YEAR WARRANTY

If your DACOR product fails to function within one year of the original date of purchase, due to a defect in material or workmanship, DACOR will furnish a new part, F.O.B. factory, to replace the defective part. All delivery, installation and labor costs are the responsibility of the purchaser. The owner must provide proof of purchase upon request and have the appliance accessible for service.

What is Not Covered

- Failure of the product caused by faulty installation, improper usage, or neglect of required maintenance.
- Service calls to educate the customer in the proper use and care of the product.
- Failure of the product when used for commercial, business, rental or any application other than for residential consumer use.
- Replacement of house fuses or fuse boxes, or resetting of circuit breakers.
- Damage to the product caused by accident, fire, flood or other acts of God.
- Breakage, discoloration or damage to glass, metal surfaces, plastic components, trim, paint, porcelain or other cosmetic finish, caused by improper usage or care, abuse, or neglect.

THE REMEDIES PROVIDED FOR THE ABOVE EXPRESS WARRANTIES ARE THE SOLE AND EXCLUSIVE REMEDIES. THEREFORE, NO OTHER EXPRESS WARRANTIES ARE MADE, AND OUTSIDE THE FIFTY STATES OF THE UNITED STATES AND THE DISTRICT OF COLUMBIA, ALL IMPLIED WARRANTIES, INCLUDING BUT NOT LIMITED TO, ANY IMPLIED WARRANTY OF MERCHANTABILITY OR FITNESS FOR A PARTICULAR USE OR PURPOSE ARE LIMITED IN DURATION TO ONE YEAR FROM THE DATE OF ORIGINAL PURCHASE. IN NO EVENT SHALL DACOR BE LIABLE FOR INCIDENTAL EXPENSE OR CONSEQUENTIAL DAMAGES. NO WARRANTIES, EXPRESSED OR IMPLIED, ARE MADE TO ANY BUYER FOR RESALE.

Some states do not allow limitations on how long an implied warranty lasts or do not allow the exclusion or limitation of incidental or consequential damages, so the above limitations or exclusions may not apply to you. This warranty gives you specific legal rights, and you may also have other rights that vary from state to state.

fold here

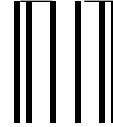

NO POSTAGE
NECESSARY
IF MAILED
IN THE
UNITED STATES

BUSINESS REPLY MAIL
FIRST-CLASS MAIL PERMIT NO. 4507 DIAMOND BAR CA

POSTAGE WILL BE PAID BY ADDRESSEE

ATTN: WARRANTY PROCESSING DEPT
DACOR
1440 BRIDGEGATE DR STE 200
PO BOX 6532
DIAMOND BAR CA 91765-9861

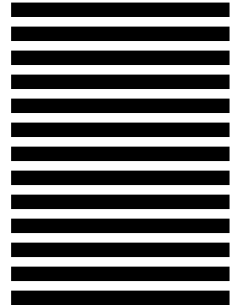



Please visit www.dacor.com to activate your warranty online.

WARRANTY INFORMATION



IMPORTANT:

Your warranty for this product **CANNOT BE ACTIVATED** until this form has been returned to Dacor. If you have purchased more than one Dacor product, Please return all forms in one envelope.

Please rest assured that under no conditions will Dacor sell your name or any of the information on this form for mailing list purposes. We are very grateful that you have chosen Dacor products for your home and do not consider the sale of such information to be a proper way of expressing our gratitude!

(Please Print or Type)

Owner's Name: _____
Last First Middle

Street: _____

City: _____ State: _____ Zip: _____

Purchase Date: _____ Email: _____ Telephone: _____

Dealer: _____

City: _____ State: _____ Zip: _____

Your willingness to take a few seconds to fill in the section below will be sincerely appreciated. Thank you.

1. How were you **first** exposed to Dacor products? (Please check one only.)

- A. T.V. Cooking Show
- B. Magazine
- C. Appliance Dealer Showroom
- D. Kitchen Dealer Showroom
- E. Home Show
- F. Builder
- G. Architect/Designer
- H. Another Dacor Owner
- I. Model Home
- J. Other _____

2. Where did you buy your Dacor appliances?

- A. Appliance Dealer
- B. Kitchen Dealer
- C. Builder Supplier
- D. Builder
- E. Other _____

3. For what purpose was the product purchased?

- A. Replacement **only**
- B. Part of a Remodeled
- C. New Home
- D. Other _____

4. What is your household income?

- A. Under \$75,000
- B. \$75,000 – \$100,000
- C. \$100,000 – \$150,000
- D. \$150,000 – \$200,000
- E. \$200,000 – \$250,000
- F. Over \$250,000

5. What other brands of appliances do you have in your kitchen?

- A. Cooktop _____
- B. Oven _____
- C. Dishwasher _____
- D. Refrigerator _____

6. Would you buy or recommend another Dacor product?

- Yes
- No

Comments: _____

Thank you very much for your assistance. The information you have provided will be extremely valuable in helping us plan for the future and giving you the support you deserve.

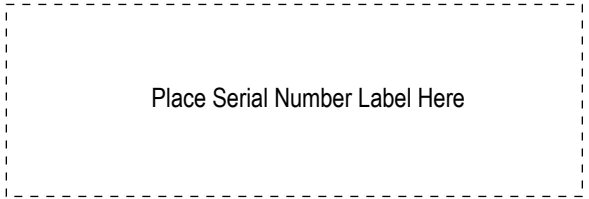

cut here

cut here