

Use and Care Manual

Discovery™ iQ Wall Oven

Models: DYO130B, DYO130FS, DYO130S, DYO130B



Aj Madison
Your Appliance Authority™
800-570-3355

Table of Contents

Important Safety Instructions.....	1
Getting to Know Your Oven.....	3
Setting Up Your Oven.....	6
Operating Your Oven - The Basics.....	9
Operating Your Oven - Deluxe Features	17
Additional Features	33
Cooking Tips	34
Parts and Accessories.....	35
Care and Cleaning	36
Before You Call for Service	41
Warranty and Service.....	43



To Our Valued Customer:

Congratulations on your purchase of the very latest in Dacor® products! Our unique combination of features, style and performance make us The Life of the Kitchen™, and a great addition to your home.

In order to familiarize yourself with the controls, functions and full potential of your new Distinctive Appliance, read this use and care manual thoroughly, beginning with the **Important Safety Instructions** section.

All Dacor appliances are designed and manufactured with quality and pride, while working within the framework of our company value. Should you ever experience a problem with your product, please first check the **Before You Call for Service** section of this manual for guidance. It provides useful suggestions and remedies prior to calling for service.

Valuable customer input helps us to continuously improve our products and services, so please feel free to contact our Customer Service Team for assistance with any of your product support needs.

Dacor Customer Service Team
14425 Clark Avenue
City of Industry, CA 91745

Telephone:

(800) 793-0093

Fax:

(626) 403-3130

Hours of Operation:

Monday through Friday

6:00 A.M. to 5:00 P.M. Pacific Time

Web Site:

www.dacor.com

Thank you for choosing Dacor for your home. We are a company built by families for families and we are dedicated to serving yours. We are confident that your new Dacor product will deliver a high level of performance and enjoyment for many years to come.

Sincerely,

The Dacor Customer Service Team

Important Safety Instructions

Installer: Leave these instructions with the appliance.

Customer: Read this use and care manual completely before using this appliance. Save it for future reference.

For service and warranty information see page 43.

If you have any questions, call:

Dacor Customer Service
(800) 793-0093 (U.S.A. and Canada)
Monday — Friday 6:00 A.M. to 5:00 P.M. Pacific Time
Web site: www.dacor.com

Have the complete model and serial number for your appliance available. The numbers are found on the appliance data plate, located inside the grill, below the control panel. Open the door to expose the grill. Write these numbers below for future reference.

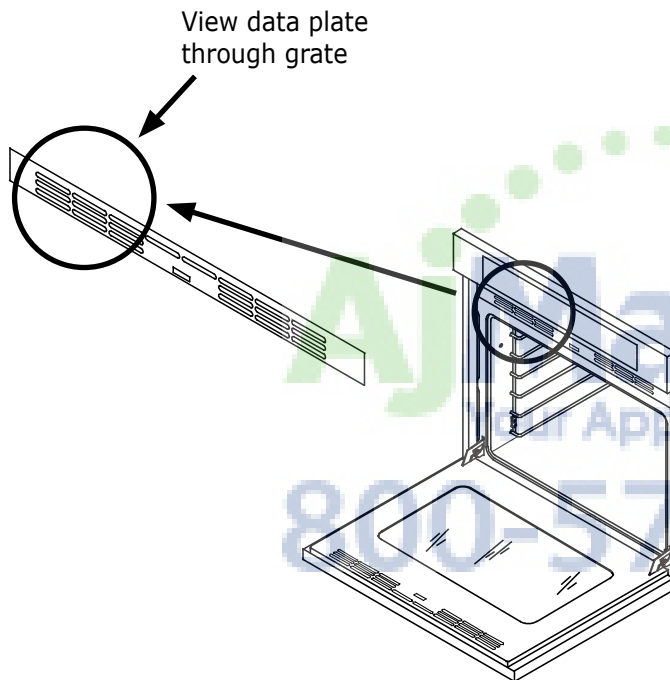

Model number _____

Serial number _____

Date of purchase _____

Since Dacor continuously improves the quality and performance of our products, we may need to make changes to the appliance without updating this manual.

Visit www.dacor.com to download the latest version of this manual.

Important Information About Safety Instructions

The **Important Safety Instructions** and warnings in this manual cannot cover all possible problems and conditions that can occur. Use common sense and caution when installing, maintaining or operating this appliance.

Always contact the Dacor Customer Service Team about problems or conditions that you don't understand.

Safety Symbols and Labels

DANGER

Immediate hazards that **WILL** result in severe personal injury or death.

WARNING

Hazards or unsafe actions that **COULD** result in severe personal injury or death.

CAUTION

Hazards or unsafe actions that **COULD** result in minor personal injury or property damage.

DANGER

IMPORTANT: To avoid the possibility of explosion or fire, do not store or use combustible, flammable or explosive vapors and liquids (such as gasoline) inside or in the vicinity of this or any other appliance. Keep items that could explode, such as aerosol cans away from the oven. Do not store flammable or explosive materials in adjacent cabinets or areas.

WARNING

WARNING - NEVER use this appliance as a space heater to heat or warm the room. Doing so may result in overheating of the appliance.

WARNING

WARNING - NEVER cover any slots, holes or passages in the oven bottom or cover an entire rack with materials such as aluminum foil. Doing so blocks air flow through the oven causing a fire hazard.

State of California Proposition 65 Warnings:

WARNING: This product contains one or more chemicals known to the State of California to cause cancer.

WARNING: This product contains one or more chemicals known to the State of California to cause birth defects or other reproductive harm.

READ AND SAVE THESE INSTRUCTIONS

Important Safety Instructions

General Safety Precautions

To reduce the risk of fire, electric shock, serious injury or death when using your oven, follow basic safety precautions, including the following:

WARNING

- If you receive a damaged product, immediately contact your dealer or builder. Do not install or use a damaged appliance.
- Make sure that the oven has been properly installed and grounded by a qualified installer according to the accompanying installation instructions. Have the installer show you the location of the circuit breaker panel or fuse box so that you know where and how to turn off power to the oven.
- Do not install, repair or replace any part of the oven unless specifically recommended in the literature accompanying it. A qualified service technician should perform all other service.
- Before performing any type of service, make sure that the electrical power to the oven is turned off at the circuit breaker panel or fuse box.
- Only use the oven for cooking tasks expected of a home appliance as outlined in this manual. This oven is not intended for commercial use.
- DO NOT TOUCH THE SURFACES OF THE OVEN DURING OR IMMEDIATELY AFTER USE.
- Make sure individuals who use the oven are able to operate it properly.
- Never allow anyone, including children to sit, stand or climb on any part of the oven including the door. Doing so may cause tipping, damage, serious injury or death.
- Do not leave children alone or unattended in the area around the oven. Do not allow children to play with the controls, pull on the handles or touch other parts of the oven.
- Do not store items of interest to children above the oven. Children could be burned or injured while climbing on the appliance.
- Do not tamper with the controls.
- To prevent the unit from tipping forward and to provide a stable installation, make sure the oven is secured to the cabinet according to the accompanying installation instructions.
- Do not heat unopened food containers such as baby food jars and cans. Pressure build up may cause the container to burst and cause injury.
- Do not use water on grease fires. A violent steam explosion may result. Smother any flames with a lid, cookie sheet or flat tray. Use baking soda or a foam extinguisher to extinguish flaming grease. Be careful to avoid getting burned.
- Keep flammable items, such as paper, cardboard, plastic and cloth away from and out of the oven. Do not allow pot holders to touch hot surfaces.

WARNING

- Do not wear loose or hanging apparel while using the oven. Do not allow clothing to come into contact with the interior of the oven and surrounding areas during and immediately after use.
- Do not use towels or bulky cloth as pot holders.
- Do not use the oven for storage.
- Clean and maintain the oven regularly as instructed in this manual. Keep the entire oven free of grease that could catch fire.
- Do not touch the outside surfaces of the oven during the self-clean cycle. They will be hot.
- Use cookware only for its intended purpose. Check the manufacturer's recommendations before use to determine if a utensil is suitable for use in an oven. Certain types of glass, ceramic and earthenware are not suitable for use in an oven. Personal injury or damage may result from the improper use of cookware.
- Exercise caution when opening the oven door. Let hot air or steam escape before looking or reaching inside.
- Use extreme caution if adding water to food. Steam can cause serious burns or scalds.
- Use only dry pot holders when removing food and cookware from the oven. Wet pot holders can cause steam burns.
- For your safety, do not use the oven to cook without the convection filter installed. When the filter is not installed, the spinning fan blades at the back of the oven are exposed.
- Do not allow food to sit in the oven for more than one hour before or after cooking. Eating spoiled food can result in food poisoning.
- Do not leave objects, such as aluminum foil, the meat probe or cookie sheets on the bottom of the oven. Do not allow the broil elements on the ceiling of the oven chamber to be covered up. Do not line the oven with aluminum foil or other materials. Doing so may cause the oven or the items in it to overheat, creating a fire hazard or causing property damage.
- Non-stick coatings, when heated, can be harmful to birds. Remove birds to a separate, well-ventilated room during cooking.
- Do not allow acids (citrus juices, tomato sauces, etc.) to remain on the oven's surfaces. The porcelain finish may stain or pit.

Getting to Know Your Oven

Control Panel Layout

A Touch display	The touch display allows you to navigate and select the various features and functions of your oven. It can be set to dim after 5 minutes of non-use (see Energy Saving Mode , page 7).
B HOME key	Touch this key to go back to the <i>oven</i> home screen on the touch display, except when the <i>oven</i> home screen is already displayed. When you touch the HOME key when the <i>oven</i> home screen is already displayed, the display jumps to the <i>Android</i> home screen. When the <i>Android</i> home screen is displayed, touch HOME again to return to the <i>oven</i> home screen. IMPORTANT: Touching the HOME key does not turn off the oven once started, even if the oven status is not currently displayed.
C MENU key	Touch this key (or Oven Menu on the touch display) to go to the main oven cooking menu. See page 11.
D BACK key	Touch this key to go back one menu on the touch display. IMPORTANT: Touching the BACK key does not turn off the oven once started, even if the oven status is not currently displayed.
E START • CONTINUE key	Touch this key (or Start on the touch display) to start the oven after selecting the desired settings. See page 11.
F CANCEL • SECURE key	Use this key to turn off the oven. This key sets all temperature settings back to zero and turns off any features that are currently in use. It also activates the lock-out feature (see page 13). NOTE: This key does not turn off the timers. The timers do not control the functions of the oven.
G LIGHT key	If you need to turn the oven lights on or off, touch the light key.
H Android system keys	Touching these keys on the touch screen allows you to navigate the Android operating system and settings. See page 33 for more details.

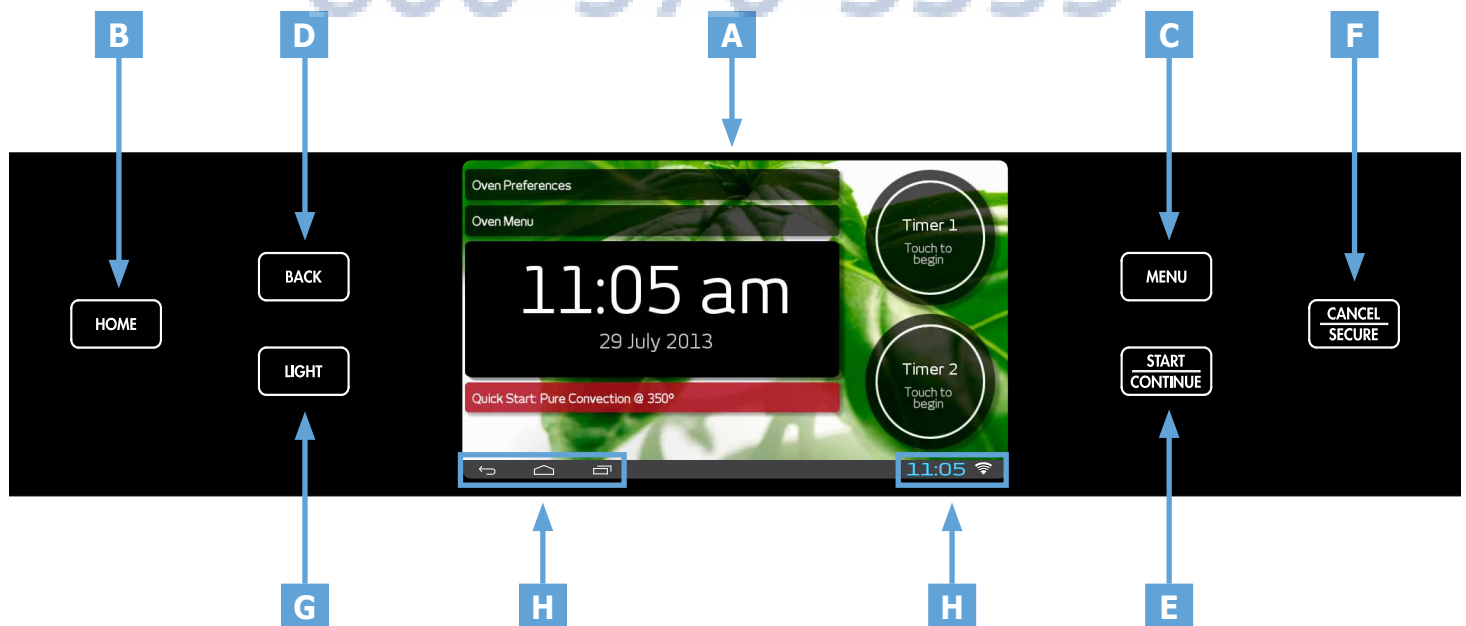

Control Panel

Getting to Know Your Oven

Parts of the Oven

A Control panel	Your oven's control panel consists of touch keys and a touch display. Use the control panel to control all the oven's features (sometimes called modes).
B Air intake/exhaust slots	The oven draws air in through the intake slots to cool its internal parts. The air comes out through the exhaust slot at the bottom of the oven. Do not block or cover the air intake or exhaust slots.
C Meat probe connector	When you use the meat probe, insert the skewer into the meat and plug the other end into this connector. See the Using the Meat Probe section on page 24 for proper operation.
D Oven lights	There are two oven lights inside the oven chamber so that you can easily see the food inside. Touch the light key on the control panel to turn them on. The bulbs are 12 volt, 20 Watt, halogen.
E Rack supports	There are seven sets of rack supports inside each oven chamber. They support the adjustable oven racks. They are numbered from the bottom up.
F Door gasket	The door gasket prevents heat from escaping when the door is closed.
G Self-clean latch	The self-clean latch automatically locks the oven door during the self-clean process. The door latches for your safety. There are very high temperatures inside the oven during the self-clean process.
H Broil elements	The broil elements are located on the ceiling of the oven chamber. They are the source of top heat.
J Convection fan	The convection fan circulates heated air through the oven chamber during the convection cooking process. The convection filter covers it.
K Convection element	The convection element heats the air that is circulated through the oven chamber by the convection fan during the convection cooking process. The convection filter covers it.
L Convection filter	The convection filter covers the convection fan. It helps prevent the transfer of taste from one food to another when you are cooking a whole meal. It also keeps the oven cleaner and covers the moving fan blades for safety purposes.
M Oven rack	Your oven comes with a set of GlideRack™ oven racks and one set of standard racks.
N Bake element	Hidden below the floor of the oven chamber is the bake element. It is the source of bottom heat.

Included Accessories

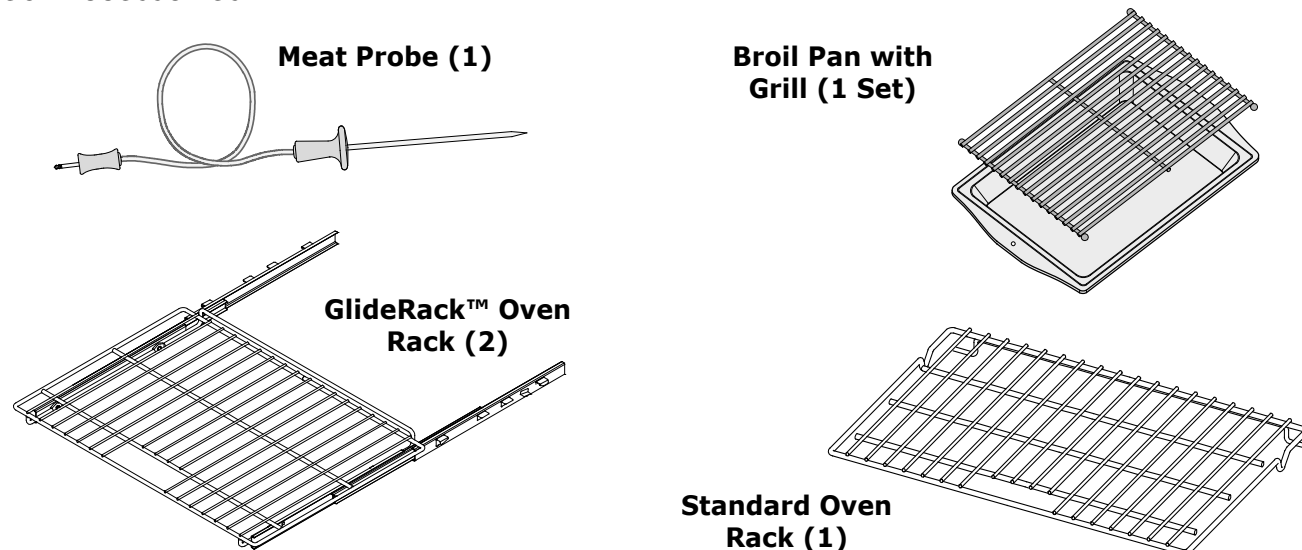

Getting to Know Your Oven

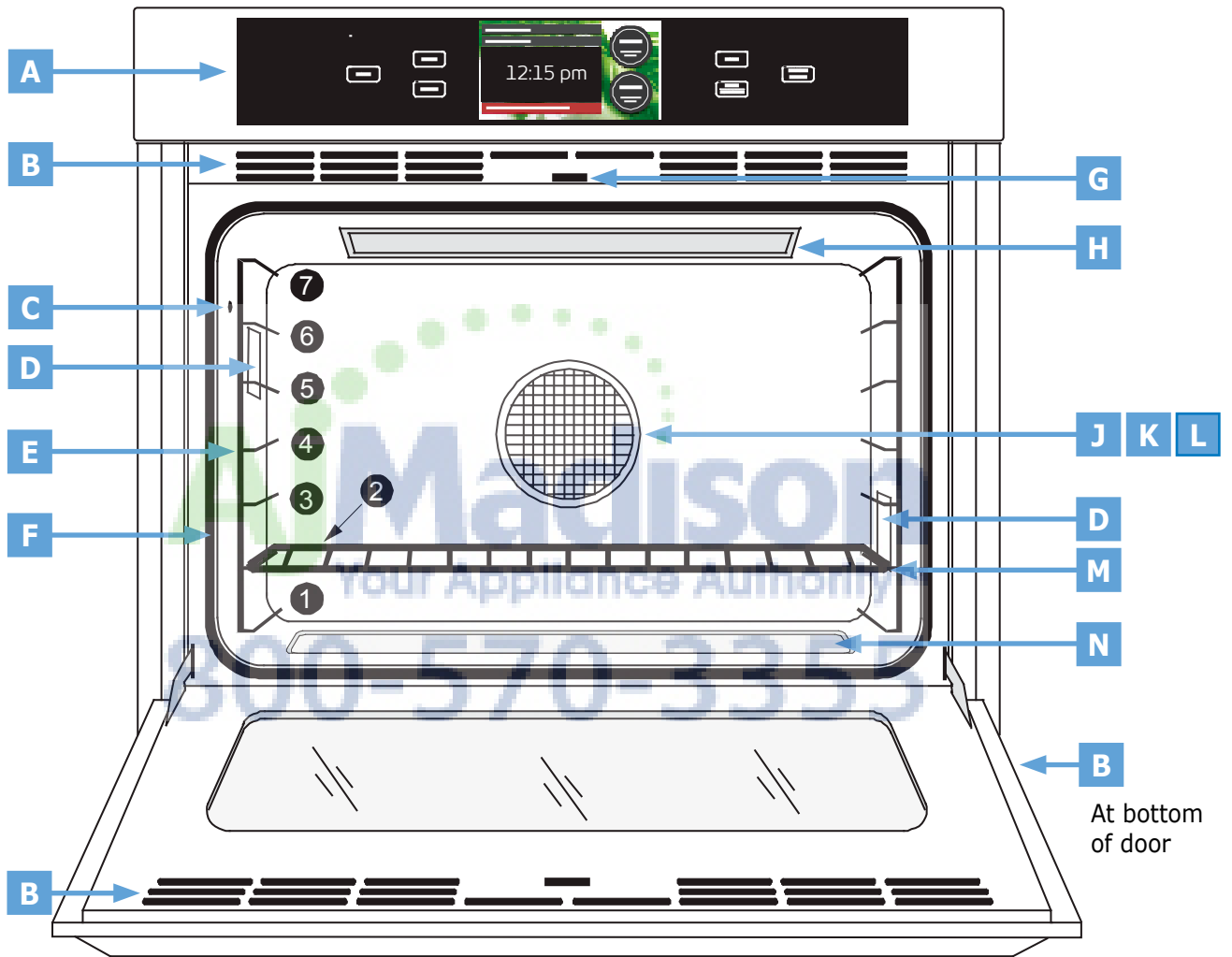

Setting Up Your Oven

Control Panel/Display Settings

- Touch **Oven Preferences** on the *oven* home screen.



- The **Oven Preferences** menu will be displayed. Use the up (Λ) and down (∨) arrows to view all of the various options.

Date/Time Settings Menu

1. From the **Oven Preferences** menu, touch **Date/Time Settings**.

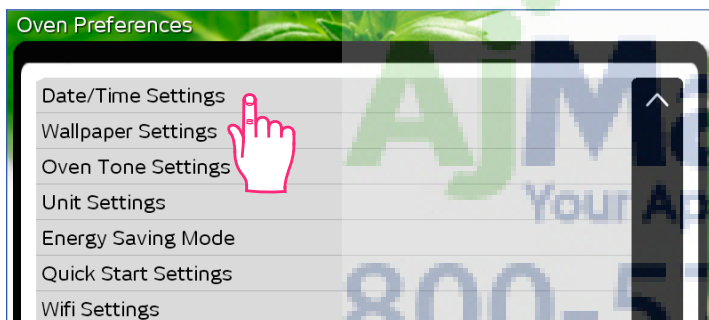

2. Touch one of the following selections:

- ◇ **Automatic date & time** - Touch to check or un-check. This setting is preferred unless WiFi internet service is not available. If WiFi internet service is not available, use the **Set date** and **Set time** functions below to set the time and date manually.
- ◇ **Set date** (manual) - Use to manually set the date only when **Automatic date & time** (above) is unchecked. Touch the up (Λ) and down (∨) arrows to select the date, then touch **Set**.
- ◇ **Set time** (manual)- Use to manually set the time only when **Automatic date & time** (above) is unchecked. Touch the up (Λ) and down (∨) arrows to select the date, then touch **Set**.
- ◇ **Select time zone** - Touch and "drag" to scroll up or down to the various time zones. Tap to select.
- ◇ **Use 24-hour format** - Touch to check or un-check. When checked, the oven is set to 24 hour time, also known as military time. For example, 1:36 PM = 13:36 military time.

- ◇ **Select date format** - Touch to select the preferred date format shown on the display.

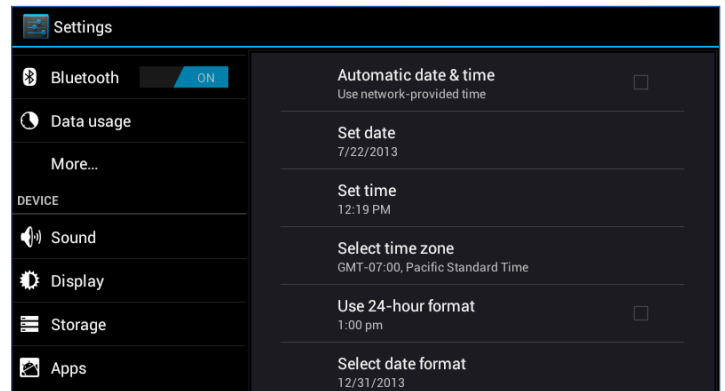

3. Touch **BACK** on the control panel to save.
4. Touch **HOME** to return to the *oven* home screen.

IMPORTANT: The above menu makes changes to Android system operations, not just the oven cooking operations.

Wallpaper Settings (background)

You can select from several different patterns to customize the background of the touch display.

To change the wallpaper:

1. From the **Oven Preferences** menu, touch **Wallpaper Settings**.

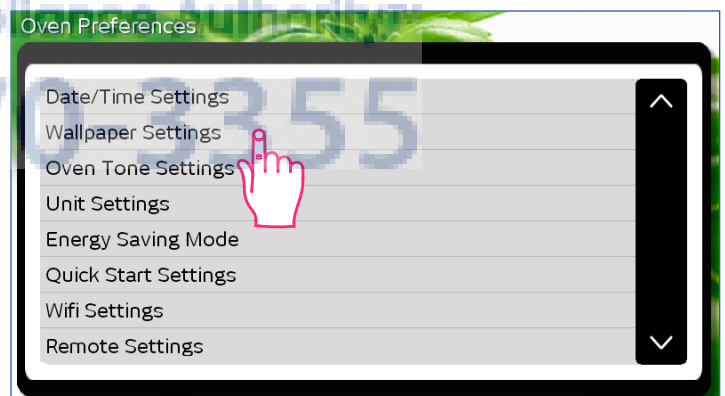

2. Touch and "drag" up and down to see the entire selection. To select, touch the desired graphic. **NOTE:** The available backgrounds vary with software version.



Setting Up Your Oven

3. Touch **HOME** on the control panel to return to the *oven* home screen.

Oven Tone Settings

The volume of the various oven tones may be adjusted or silenced. A tone sounds any time you touch any of the keys or when various error conditions exist. A tone also sounds when a timer is done counting (see page 18) or whenever the oven notifies the user it has performed certain functions, for example, preheating is complete.

To turn off, adjust or silence the various oven tones:

1. From the **Oven Preferences** menu, touch **Oven Tone Settings**.

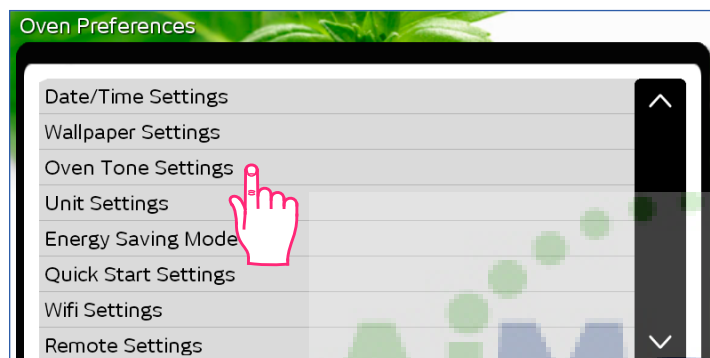

2. Touch to select one of the following:
 - ◇ **Volumes** - Displays volume controls for various system functions. Touch and drag left or right to adjust.

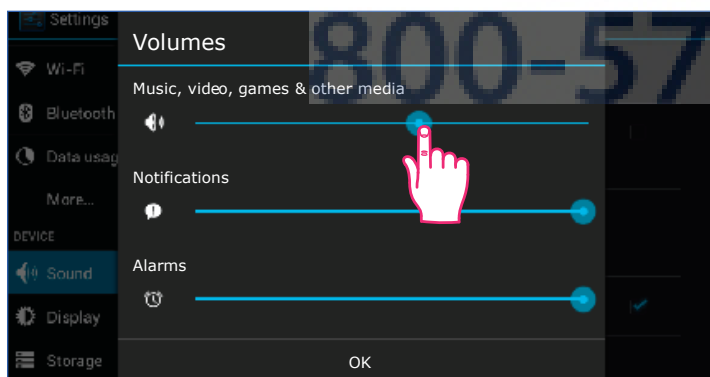

- ◇ **Silent mode** - Displays the check box that silences all oven sounds. Touch to check or un-check.
- ◇ **Default notification** - Touch to select the default Android system tones (does not change tones emitted during cooking operations). Touch the desired tone (a sample will play).
- ◇ **Touch sounds** - Displays the check box that silences sound emitted when you touch the oven keys. Touch to check or un-check.

3. Touch **OK** to exit.
4. Touch **HOME** to return to the *oven* home screen.

Unit Settings (Temperature Scale)

You can select the temperature scale (Fahrenheit or Celsius) the oven uses to display the cooking temperature. The oven is preset at the factory to Fahrenheit.

To change the temperature scale:

1. From the **Oven Preferences** menu, touch **Unit Settings**.

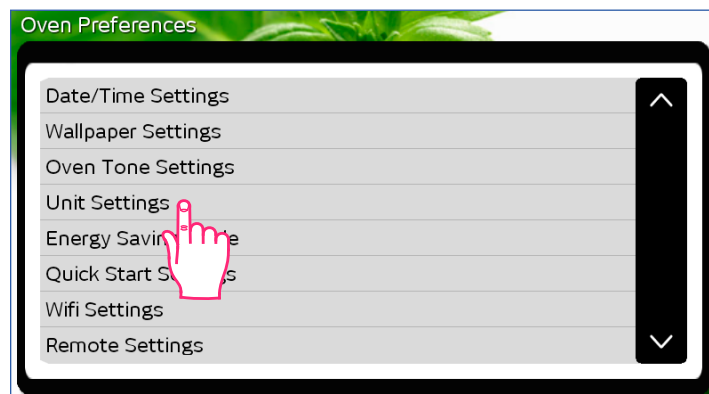

2. Touch the check box for the desired setting, "F" or "C" then touch **SAVE**.

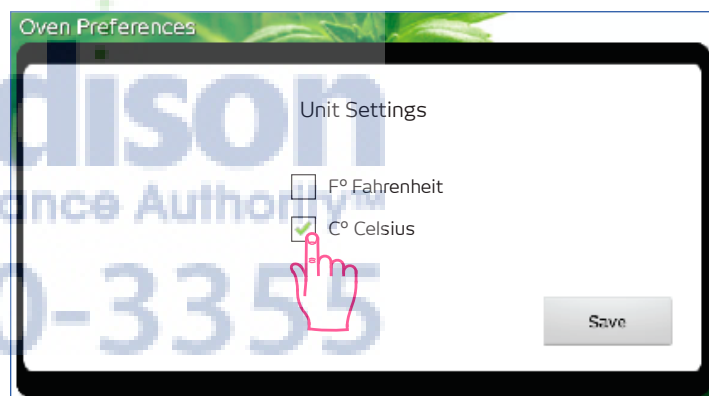

3. Touch **HOME** to return to the *oven* home screen.

Energy Saving Mode

The *oven* home screen can be set to stay on constantly or dim after 5 minutes of non-use. When energy saving mode is on, touch the screen to reactivate the *oven* home screen.

To change the energy saving setting:

1. From the **Oven Preferences** menu, touch **Energy Saving Mode**.

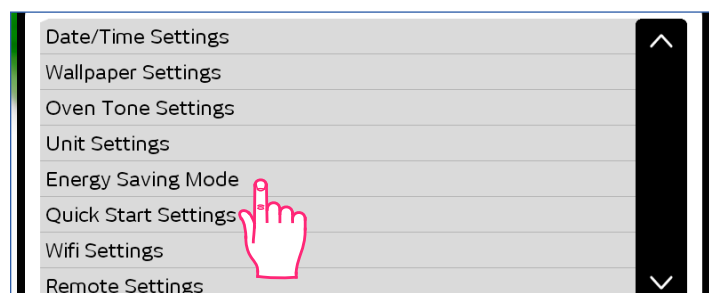

Setting Up Your Oven

2. Touch the check box for **NO Sleep**, **Light Sleep** or **Deep Sleep**, then touch **Save**.

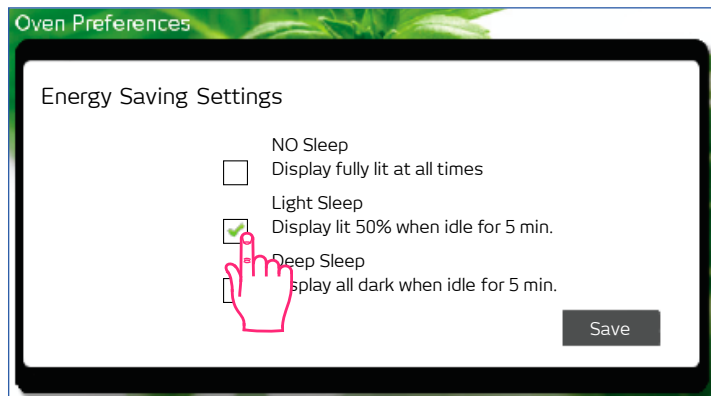

3. Touch **HOME** to return to the *oven* home screen.

Quick Start Settings

The **Quick Start** mode, selected from the *oven* home screen may be set to your own personal preferences.

To change the Quick Start setting:

1. From the **Oven Preferences** menu, touch **Quick Start Settings**.

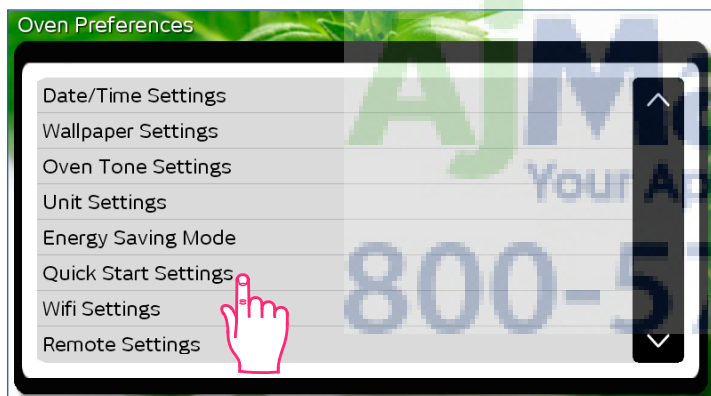

2. Touch the down arrow (v) under **Cooking Mode** to select a cooking mode (see below). Touch and "drag" up and down to see the entire selection of cooking modes. To select, tap the desired mode.
3. Touch the up (^) and down (v) **Temperature** arrows to select the cooking temperature, then touch **Save**.

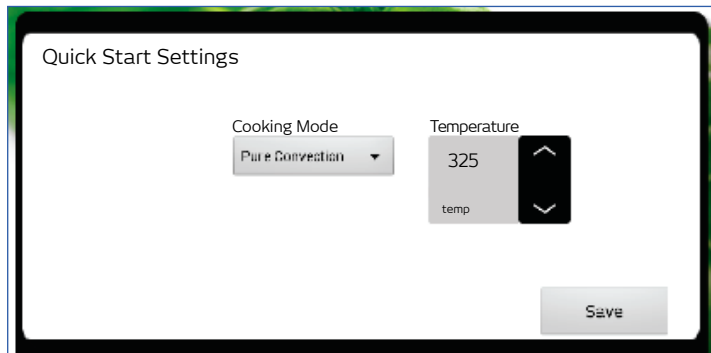

4. Touch **HOME** to return to the *oven* home screen.

WiFi Settings

See page 33 for instructions on WiFi set up.

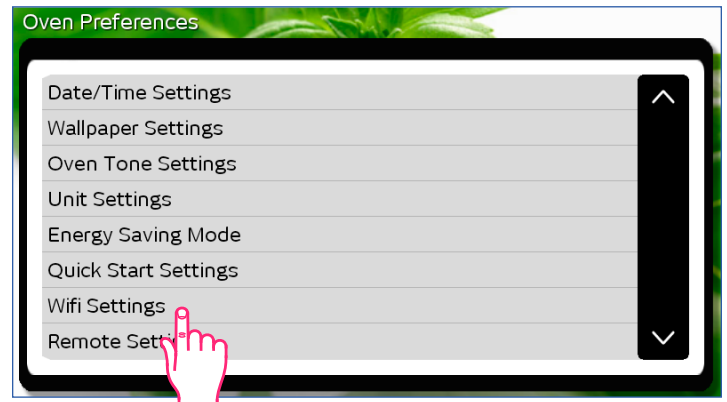

Remote Settings

Future versions of the software will support remote operation of your oven. This feature is not currently available on your oven.

Oven Setup

Select this option if the initial oven setup was skipped the first time power to the oven was turned on.

Tutorial

From the **Oven Preferences** menu, touch **Tutorial** to access the oven tutorial. This is the same tutorial that comes up on the touch display the first time power to the oven is turned on.

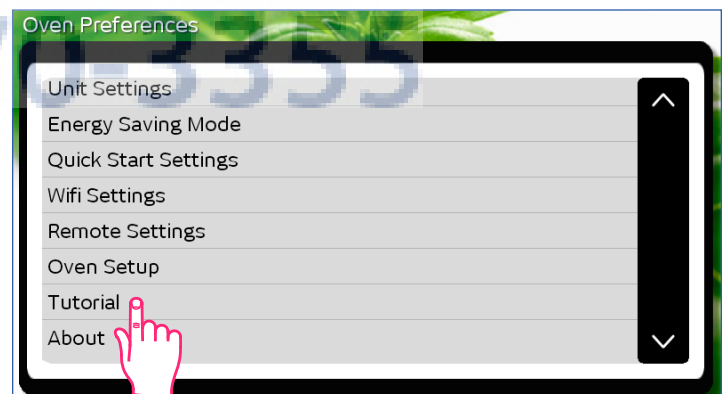

- Touch **BACK** to exit to the **Oven Preferences** screen.
- Touch **HOME** to return to the *oven* home screen.

About (System Information)

From the **Oven Preferences** menu, touch **About** to view:

- The Android operating system revision
- The Dacor software version
- The oven serial number
- The oven model number

Operating Your Oven - The Basics

Important Things to Know Before Operation

- Dacor recommends turning the oven on for one hour at 500°F (260°C) to burn off any residual oils used during the manufacturing process. Any of these oils left on the inner parts can cause an undesirable smell the first few times the oven is used.
- When you use your oven in one of the convection, bake or roast modes, it preheats automatically. The preheat cycle rapidly brings the oven chamber up to the proper cooking temperature. Wait for the oven to finish preheating (**Insert Food** appears on the display) before placing the food in the oven. Excessive browning will occur if you put the food in the oven while it is preheating.
- While the oven is preheating the actual oven temperature will appear on the display, next to the temperature setting. It takes several minutes to preheat the oven. Preheat time depends on the temperature settings. The time may be longer depending on the type of electrical supply in your community. There is no preheat cycle for any of the broil modes.
- After you pull food out of the oven, it will continue to cook. This process is called "carry-over." The larger the portion of food, the longer it will cook. It is best to let meat rest for 10 to 15 minutes after it comes out of the oven before carving. Doing so will allow the meat to retain its juices and make it easier to carve.
- After you turn off the oven, the cooling fans may continue to run until the internal parts have cooled down.
- Broil modes do not work with the meat probe connected.
- This unit has been tested and found to comply with the limits for a class B digital device, pursuant to Part 15 of the FCC rules. These limits are designed to provide reasonable protection against harmful interference in a residential installation. This unit generates, uses and can radiate radio frequency energy and, if not installed and used in accordance with the instructions, may cause harmful interference to radio communications. However there is no guarantee that interference will not occur in a particular installation. If this unit does cause harmful interference to radio or television reception, which can be determined by turning the unit off and on, the user is encouraged to try to correct the interference by one or more of the following measures:
 - ◇ Reorient or relocate the receiving antenna.
 - ◇ Increase the distance between the unit and receiver.
 - ◇ Connect the unit into an outlet or a circuit different from that to which the receiver is connected.

Preset Temperature Settings

Your oven has a suggested preset temperature setting for each of the cooking modes to reduce the need to always enter the temperature each time you cook. See the table below. You have the choice (in most cooking modes) of cooking at the preset cooking temperature or selecting a different one. See **Starting Your Oven**.

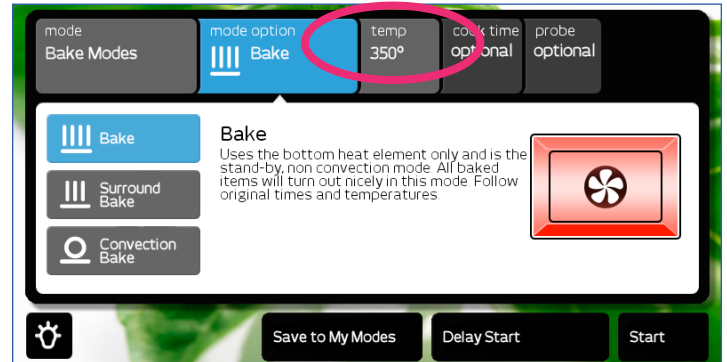

Cooking Mode	Preset Temperature
Bake	350°F (176°C)
Broil	550°F (287°C)
Convection Bake	325°F (162°C)
Convection Broil	550°F (287°C)
Convection Roast	325°F (162°C)
Defrost	130°F (54°C)
Dehydrate	125°F (51°C)
Max Broil	550°F (287°C)
Pure Convection	325°F (162°C)
Pure Convection Sear	325°F (162°C)
Proof	110°F (43°C)
Roast	375°F (190°C)
Surround Bake	350°F (176°C)
Warm/Hold	150°F (65°C)

Operating Your Oven - The Basics

Oven Racks

You may use either rack type on any level inside the oven.

WARNING

To reduce the chance of burns, position the oven racks when the oven is cool. If you must reposition a rack when the oven is hot, use pot holders.

To insert the standard oven rack...

1. Insert the end of the rack with the safety notches into the oven first.
2. Attach both sides of the rack to the rack supports in the oven as shown in the diagram below.
3. Begin to slide the rack in, and then, lift up so that the safety notches clear the ends of the rack supports.
4. Push the rack all the way in with both hands.

To remove the standard oven rack...

- Grasp it with both hands and pull gently straight out toward you until it stops.
- To remove the rack completely, lift the front of the rack up about six inches and continue to pull it out. Lifting the rack releases the safety notches. The safety notches reduce the chances of a rack coming out of the oven accidentally.

To insert a GlideRack oven rack...

Your oven also comes with Dacor GlideRack oven racks. You can pull a GlideRack oven rack out further than a standard rack and still support heavy pots and pans full of food. It is great for heavier foods and the optional Dacor baking stone.

1. Align both sets of safety clips (right and left) on the back of the rack guides with the oven rack supports as shown below. **NOTE:** The diagram below shows installation with the rack guides extended but, the rack may be installed with or without the guides extended, whichever is easier.
2. Begin to slide the rack in, lifting the front safety clips over the front of the oven rack supports.
3. Push the rack all the way in.
4. Grasp the rack in the center of the front and pull. The rack should come forward while the guides remain in place.

To remove a GlideRack oven rack...

- Grasp the rack with both hands and pull it gently straight out toward you until it stops.
- Lift up until the front safety clips just clear the front of the rack supports on the oven. Continue to pull out. Moving the end of the rack back and forth slightly, left to right, as you pull, will make it easier to remove.

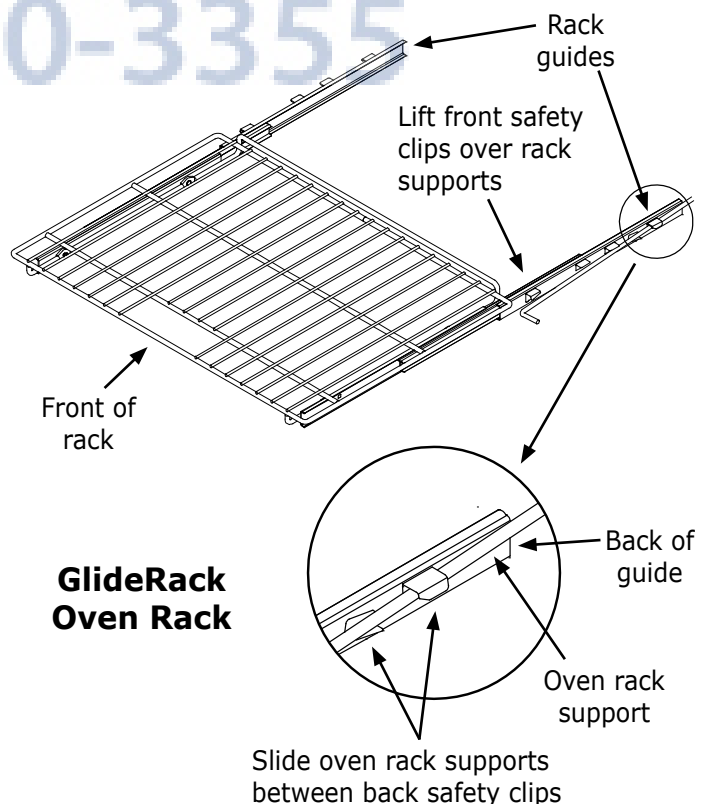
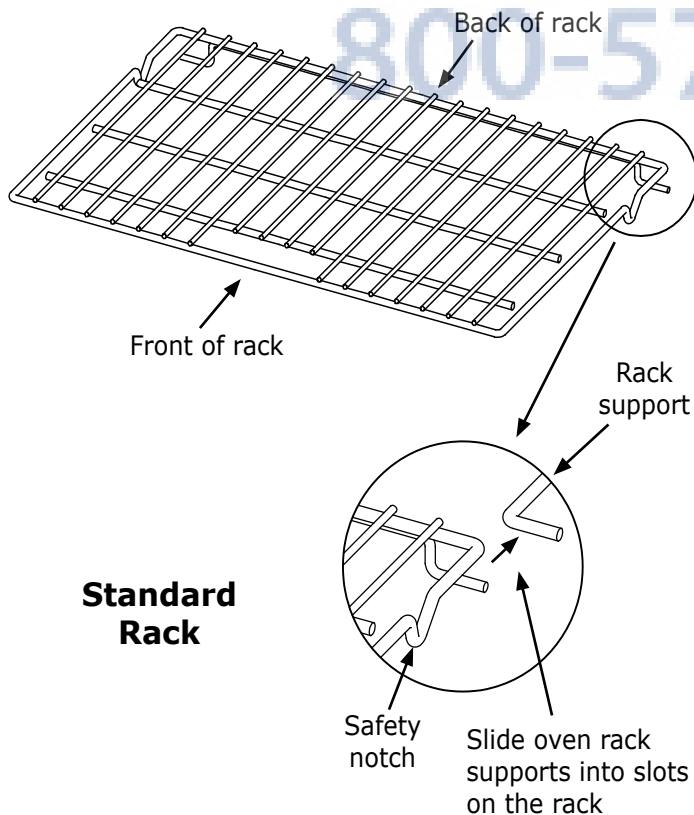

Operating Your Oven - The Basics

Starting Your Oven - Quick Start

The quick start feature allows you to start cooking quickly. Using the main menu (see next section), allows you more cooking options and features.

NOTE

You can change quick start mode to your favorite cooking settings. See page 8 for set up.

1. Adjust the racks to the appropriate level.
2. Touch **Quick Start**. The quick start settings will appear on the display.

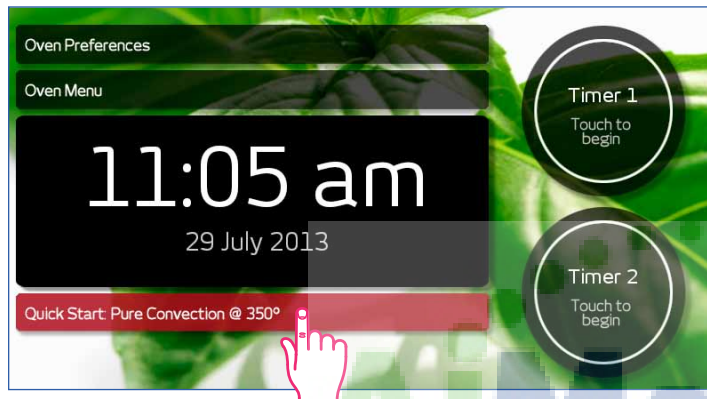

3. If quick start is set to one of the broil modes, insert the food in the oven. If quick start is set for a convection, bake or roast mode, wait to insert the food to avoid excessive browning during preheat.
4. Touch **Start**. The oven temperature setting appears in white and the actual temperature appears in red, as shown below.

If **Preheating** appears on the display, wait for pre-heat to complete (**Insert Food** appears on the display). When **Insert Food** appears on the display, place the food in the oven, or touch **Start** to maintain the oven temperature until you are ready to put the food in the oven.



5. To turn off the oven touch **CANCEL · SECURE** on the control panel.

Starting Your Oven - Main Menu

1. Adjust the racks to the appropriate level.
2. Touch **Oven Menu**.



3. The main cooking menu will appear on the display. Touch the best type of cooking mode for the type of food to be cooked on the main menu:
 - ◇ Pure Convection modes
 - ◇ Bake modes
 - ◇ Broil modes
 - ◇ Roast modes

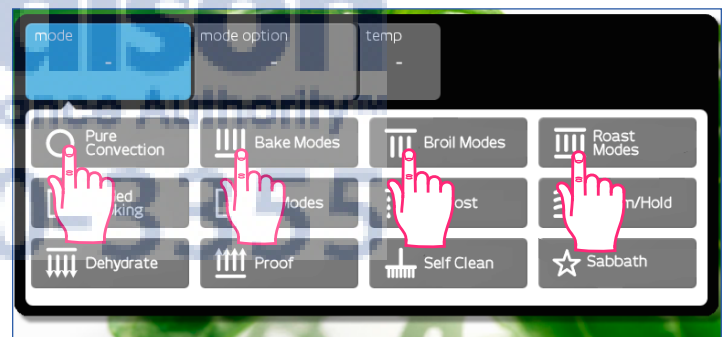

For additional cooking features see **Operating Your Oven - Deluxe Features**

4. Touch the desired sub-mode. When you touch each sub-mode, a description of that mode appears on the display.

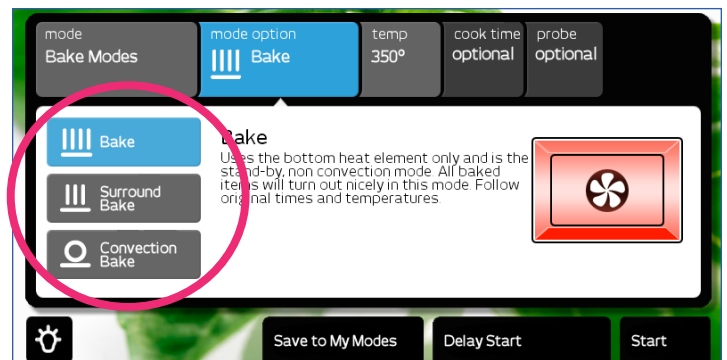

continued...

Operating Your Oven - The Basics

5. If you want to change the preset cooking temperature, touch **temp**.

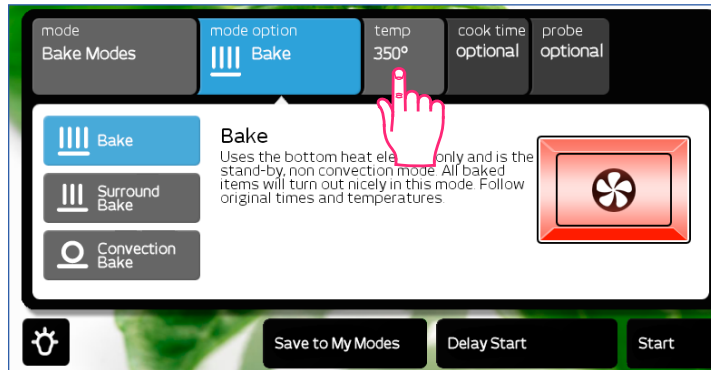

The temperature adjustment bar will appear. Touch and slide the pointer back and forth to select the desired cooking temperature. Touch the arrows on either end of the adjustment bar to make minor adjustments.

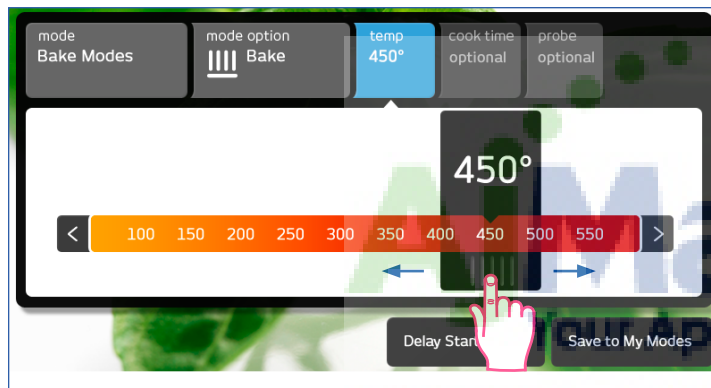

6. If using one of the broil modes, insert the food in the oven. If using a convection, bake or roast mode, wait to insert the food to avoid excessive browning during preheat.
7. Touch **Start**. The oven temperature setting appears in white and the actual temperature appears in red, as shown below.

If **Preheating** appears on the display, wait for pre-heat to complete (**Insert Food** appears on the display). When **Insert Food** appears on the display, place the food in the oven, or touch **Start** to maintain the oven temperature until you are ready to cook.



8. To turn off the oven, touch **CANCEL · SECURECANCEL UPPER** or **CANCEL LOWER** on the control panel.

Changing the Temperature

To change to a different temperature while the oven is on:

1. Touch the temperature setting on the display.



2. The temperature adjustment bar will appear. Touch and slide the pointer back and forth to select the desired cooking temperature. Touch the arrows on either end of the adjustment bar to make minor adjustments.

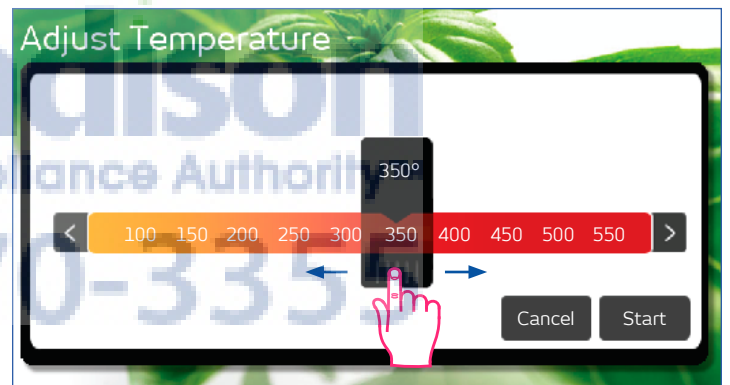

3. Touch **Start**.



IMPORTANT

If you increase the temperature by more than 50°F (28°C), to reach the new temperature, the oven needs to preheat. Remove the food from the oven to prevent excessive browning.

Operating Your Oven - The Basics

Changing the Oven Cooking Mode

To change to a different cooking mode while the oven is on, for example to change from Bake to Convection Roast:

1. Touch the current cooking mode icon that appears on the touch display, left of the temperature setting.

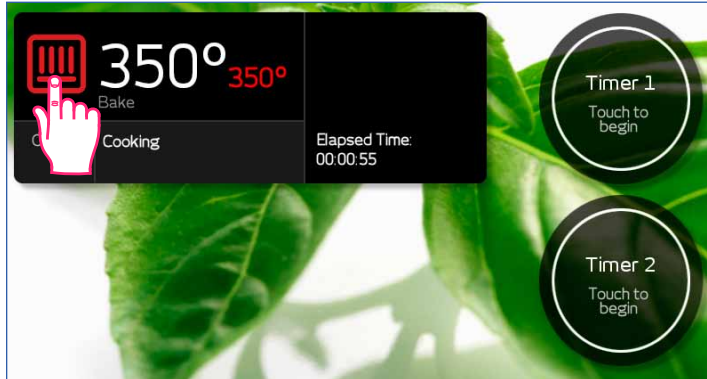

2. The main cooking menu will appear on the display. Touch the new desired cooking mode.

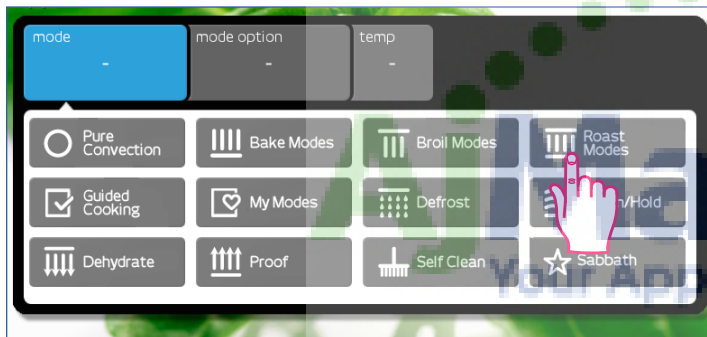

3. Touch the sub-mode, as shown below.

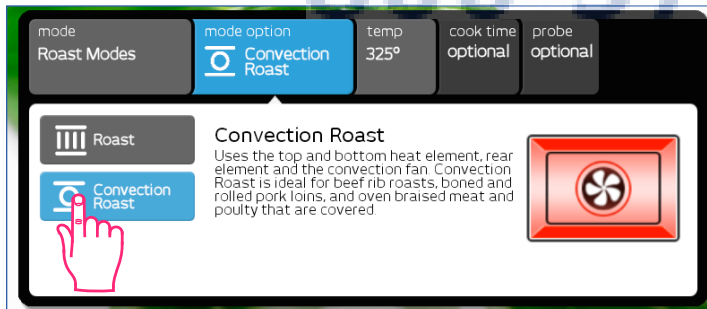

4. If you want to change the preset temperature, touch **temp**.

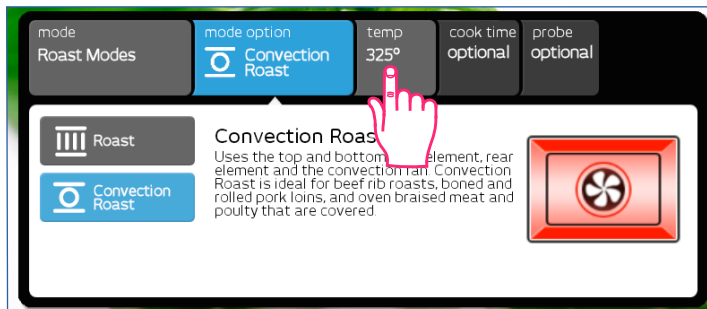

5. The temperature adjustment bar will appear. Touch and slide the pointer back and forth to select the desired cooking temperature. Touch the arrows on either end of the adjustment bar to make minor adjustments.

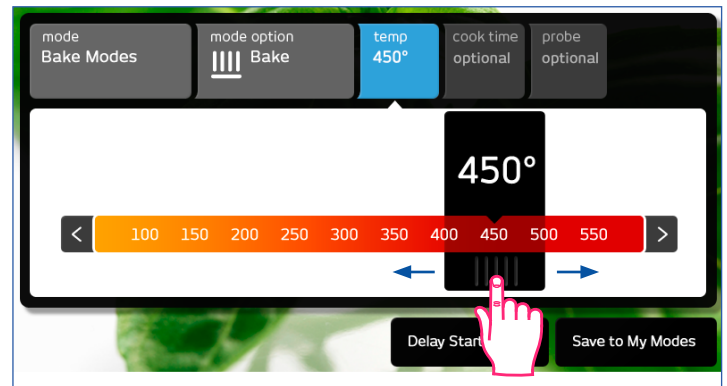

6. Touch **Start**.

NOTE

- Since you have restarted the oven during this process, **Insert Food** may appear on the display. Touch **Start** to clear the message.
- If you increase the temperature by more than 50°F (28°C), remove the food from the oven to prevent excessive browning.

Lock-Out Feature

If you want to disable the control panel when the oven is not in use:

- Touch and hold the **CANCEL · SECURE** key on the control panel for about five seconds. The control panel keys will stop working and **Locked** will appear on the display. Only the **CANCEL · SECURE** and oven light keys will remain functional.



- To reactivate the control panel, touch and hold the **CANCEL · SECURE** key for about five seconds.

IMPORTANT

Using the lock-out feature turns off the timers if they are in use.

Operating Your Oven - The Basics

Understanding the Various Oven Modes

Your Oven's Two Pure Convection Modes

- **Pure Convection**
- **Pure Convection Sear**

About Pure Convection

Pure Convection uses the convection element and fan. The uniform air circulation provided by Pure Convection allows you to use more oven capacity at once. Use this mode for single rack baking, multiple rack baking, roasting, and preparation of complete meals. Many foods, such as pizzas, cakes, cookies, biscuits, muffins, rolls and frozen convenience foods can be successfully prepared on two or three racks at a time. Pure Convection is also good for whole roasted duck, lamb shoulder and short leg of lamb.

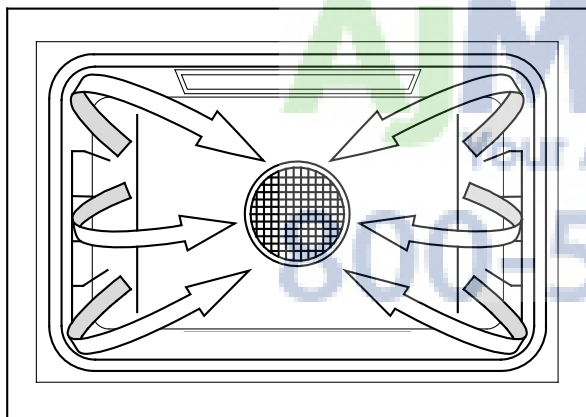

IMPORTANT

As a general rule, modes that utilize convection have cooking times that are about 25% shorter. You may want to set the timer 15 minutes before the shortest stated time and add more time if necessary.

Some recipes, especially those that are homemade, may require adjustment and testing when converting from standard to convection baking. If you are unsure how to convert a recipe, begin by preparing the recipe using the standard bake settings.

If the food is not cooked to your satisfaction during this first convection trial, adjust one recipe variable at a time (such as cooking time, rack position or temperature) and repeat the convection test. If necessary, continue adjusting one recipe variable at a time until you get satisfactory results.

For multiple rack baking...

- Typically, when baking on two racks with your oven, use rack positions #3 and #5 (counting from the bottom up). When baking on three racks, use rack positions #2, #4 and #6.
- When adapting a single rack recipe to multiple rack baking, it may be necessary to add to the baking time due to the extra bulk of the food in the oven.

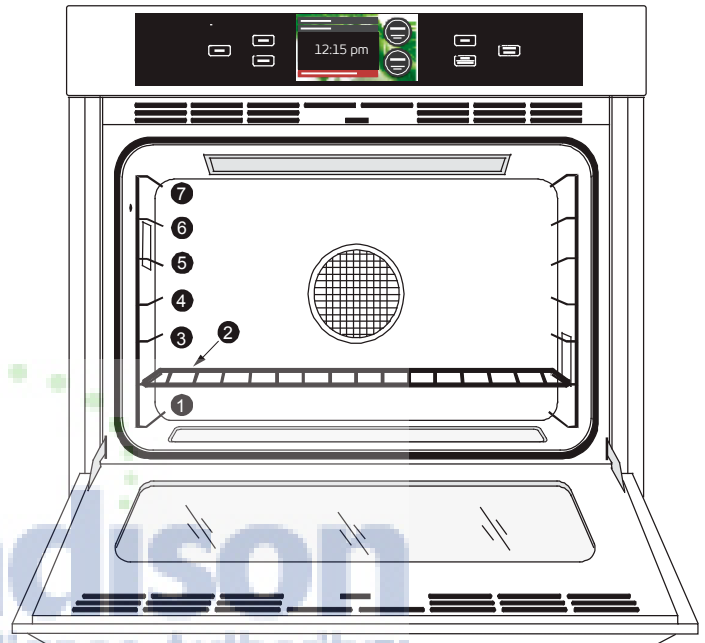

Pure Convection Sear

Pure Convection sear uses the convection element and fan. In Pure Convection Sear mode, the oven cooks the meat 75°F (42°C) higher than the set temperature for the first 15 minutes. The resulting browning process sears the surface of the meat to keep the natural juices from escaping. This mode is best for game hens, chickens, stuffed and un-stuffed turkeys, turkey breasts, pork tenderloin and pork loins.



Operating Your Oven - The Basics

Your Oven's Three Bake Modes

- **Bake**
- **Surround Bake**
- **Convection Bake**

Bake

Uses only the bake element. This mode is the stand-by, non-convection mode. All baked items will turn out nicely in this mode.



Tips for Using Bake Mode

- For best results, use a single rack. See page 34 for suggested rack positions for various foods. For cooking on multiple racks, Dacor recommends using one of the convection modes.
- Follow your recipe's original cooking time and temperature.
- Do not open the oven door frequently during baking. Look through the oven door window to check the progress of baking whenever possible.
- Use the timers to determine baking time.
- Wait until the shortest recommended baking time before checking the food. For most baked goods, a wooden toothpick placed in the center should come clean when the food is done.

Surround Bake

Surround Bake uses both the bake element and a broil element. This mode is best for angel-food cake, fruit cobblers, quick breads, soufflés and cheesecakes baked in a water bath. Egg-leavened items turn out best in this mode because they still get a nice rise without over-browning or curdling. Thick battered breads, such as banana bread, bake well in this mode because they cook through while providing the correct amount of browning.



Convection Bake

Convection Bake uses both the bake element and the convection element and fan. Use this mode for single rack convection baking. The combination of the convection fan and bottom heat source is best for fruit crisps, custard pies, double-crust fruit pies, quiches, yeast breads in a loaf pan and popovers. Also, items baked in a deep ceramic dish or earthenware clay pots are best in this mode. Most of these items cook in a deep pan and require browning on the top and bottom.



IMPORTANT

Modes that utilize convection tend to have a cooking time that is about 25% shorter.

Adjust and test cooking times for your recipes, especially those that are homemade, when converting from standard to convection baking. See the Pure Convection section on page 14 for additional guidelines.

Common Problems When Using the Bake Mode

Problem	May be caused by	What to do
Cookies burn on the bottom.	Oven door opened too often.	Set timer to shortest recommended cooking time and check food when timer beeps. Use door window to check food.
	Incorrect rack position used.	Change rack position.
	Dark, heat absorbing cookie sheets used.	Use shiny, reflective cookie sheets.
Cookies are too brown on top.	Rack position being used is too high.	Change rack position.
	Food placed in oven during preheat.	Wait until oven is preheated.
	Incorrect baking mode being used.	See Starting Your Oven - Main Menu on page 11 for guidelines.
Cakes burn on the sides or are not done in the center.	Oven temperature too high.	Reduce oven temperature.
	Dark, heat absorbing cake pans used.	Use shiny, reflective cake pans.
Cakes crack on top.	Oven temperature too high.	Reduce oven temperature.
Cakes are not level.	Oven and/or oven rack not level.	Level oven and rack as needed.
Pies burn around the edges or are not done in the center.	Oven temperature too high.	Reduce oven temperature.
	Dark, heat absorbing pans used.	Use shiny, reflective pans.
	Oven and/or rack over-crowded.	Reduce number of pans.

Operating Your Oven - The Basics

Understanding the Various Oven Modes (cont.)

Your Oven's Three Broil Modes

- **Broil**
- **Max Broil**
- **Convection Broil**

WARNING

- Use the broil modes only with the oven door completely closed.
- To avoid damage to the meat probe, remove it from the oven when using either of the broil modes. If the meat probe is connected the broil modes will not start (an error signal to appear on the display).

Broiling is a quick, flavorful way to prepare many foods, including steaks, chicken, chops, hamburgers and fish.

Broil

Broil mode uses one of the broil elements. It is best for broiling smaller amounts of food.



Max Broil

Max Broil uses both broil elements. It is best for larger quantities of food to be broiled.



Convection Broil

Convection Broil uses a combination of the convection element and fan and a broil element. It is best for items that do not need to be flipped such as, thinner cuts of meat, fish and garlic bread.



Broiling Tips

- To reduce the chance of overcooking, use rack positions 1 through 4. Results will vary based on the type of food being broiled and the rack position used.
- It is normal and necessary for some smoke to be present to give the food a broiled flavor.
- Setting the timer is recommended to time the broiling process.
- Always use a broiler pan and grill to provide drainage for excess fat and grease. Doing so will reduce spatter, smoke and flare-ups.
- Start with a room temperature broiler pan for even cooking.
- Use tongs or a spatula to turn and remove meats. Never pierce meat with a fork because the natural juices will escape.

- Broil food on the first side for a little more than half of the recommended time, then season and turn. Season the second side just before removing the food from the oven.
- To prevent sticking, lightly grease the broiler grill. Excess grease will result in heavy smoke. For easier cleaning, remove the broiler pan and grill when removing the food.

Your Oven's Two Roast Modes

- **Roast**
- **Convection Roast**

Roast

Roast mode uses both the bake element and a broil element. It is best for half and whole cooked hams, rack of veal, and rack of lamb. When braising in the oven, cover foods with foil if necessary.



Convection Roast

Convection Roast uses a combination of the convection element and fan, a broil element and the bake element. It is best for rib roasts, turkeys, chickens, etc.



IMPORTANT

Modes that utilize convection tend to have cooking time that is about 25% shorter.

As with other convection modes, adjust and test cooking times for your recipes, especially those that are home-made. See the Pure Convection section on page 14 for additional guidelines.

Roasting Tips

- All baking modes can be used to roast in your oven. However, the Convection Roast mode is recommended to produce meats that are deliciously seared on the outside and succulently juicy on the inside, more quickly. Foods that are exceptional, when prepared in the Convection Roast mode, include: beef, pork, ham, lamb, turkey, chicken and cornish hens.
- Always roast meats fat side up in a shallow pan, using a roasting rack. Always use a pan that fits the size of the food being prepared. The broiler pan and grill that come with the oven, can be used in most cases. No basting is required when the fat side is up. Do not add water to the pan. It will cause a steamed effect.
- Poultry should be placed breast side up on a rack in a shallow pan that fits the size of the food. Again, the broiler pan and grill that come with the oven can be used. Brush poultry with melted butter, margarine or oil before and during roasting.

Operating Your Oven - The Basics

- When using the roast mode, do not use pans with tall sides. They interfere with the circulation of heated air over the food.
- If using a meat thermometer, insert the probe halfway into the center of the thickest portion of the meat. For poultry, insert the thermometer probe between the body and leg into the thickest part of the inner thigh. To ensure an accurate reading, the tip of the probe should not touch bone, fat or gristle. Check the meat temperature 2/3 of the way through the recommended roasting time. After reading the meat thermometer once, insert it 1/2 inch further into the meat, then take a second reading. If the second temperature registers below the first, continue cooking the meat.
- Remove meats from the oven when the thermometer registers 5 to 10°F (3 to 6°C) below the desired temperature. The meat will continue to carry-over.
- Allow roasts to stand 15 to 20 minutes after roasting in order to make carving easier.
- Roasting times always vary according to the size, shape and quality of meats and poultry. Less tender cuts of meat are best prepared in Bake mode and may require moist cooking techniques. Use your favorite cookbook recipes.
- Reduce spatter by lining the bottom of the roasting pan with lightly crushed aluminum foil.

Operating Your Oven - Deluxe Features

Warm/Hold

This mode allows you to keep your food warm 150°F (65°C) until you are ready to serve, after the food is done cooking.

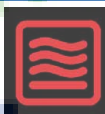

WARNING

To avoid potential sickness and the spoiling of food, do not allow food temperature to drop below 140°F (60°C). Below 140°F bacteria can develop.

1. When the food is done cooking, touch **CANCEL** - **SECURE**.



2. Touch **Oven Menu**.



3. Touch **Warm/Hold** on the main menu.

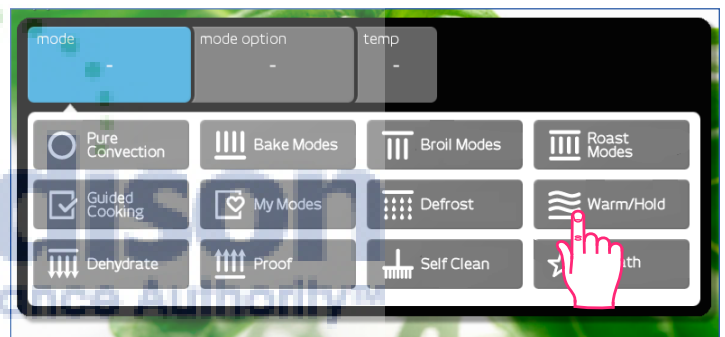

4. Touch **Start**.

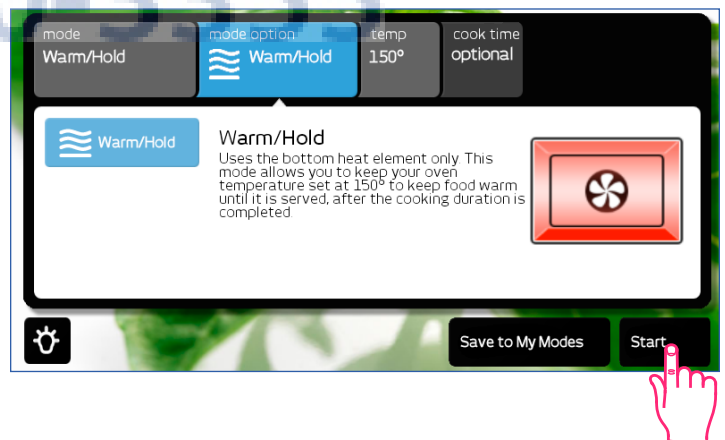

Operating Your Oven - Deluxe Features

Timers

WARNING

The timers on your oven do not turn the oven on or off. They are only for timing purposes. When you want to turn the oven off automatically, use the **Delay Start/Cook Time Features** (see page 22).

IMPORTANT

Touching **CANCEL · SECURE** does **NOT** reset or stop the timers.

Your oven is equipped with two built-in timers...

- You can use both of them at the same time.
- You can time from 1 minute to 99 hours and 59 minutes.
- The timers can be set to count up or count down.

To use the timers on your oven...

1. Touch **Timer 1** or **Timer 2** on the *oven* home screen.



2. Enter the hours and minutes to be timed on the keypad that appears on the touch display. You can also touch the up (^) and down (v) keys to make small adjustments to the time. **NOTE:** Touch **Cancel** to clear the display and re-enter the hours and minutes, or touch **Cancel** a second time to return to the *oven* home screen.

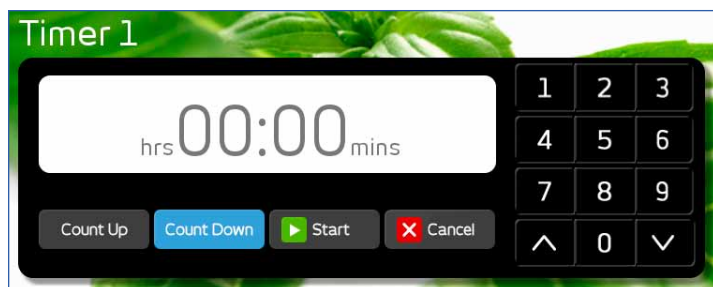

3. Touch **Count Up** or **Count Down**. If you touch **Count Up**, the timer will start at 00:00 and count up to the time entered in step 2. If you touch **Count Down**, the timer will start at the time entered and count down to 00:00.

4. Touch **START**.

5. The display will return to the *oven* home screen and the timer count will be displayed.



When the timer is done counting, the timer display will flash and a tone will sound. The alarms for Timer 1 and Timer 2 have different patterns.

Timer	Alarm Pattern
1	1 second on, 1 second off, repeat
2	1 second on, 1 second off, 1 second on, 2 seconds off, repeat

To turn off the alarm tone, touch **stop** for the appropriate timer on the touch display.

While the timer is running...

- You can touch **Timer 1 Stop** or **Timer 2 Stop** on the display to stop and clear the timer.
- You can touch **Timer 1 Pause** or **Timer 2 Pause** on the display to pause the count up/down. Touch **Continue** to resume counting up/down.

Operating Your Oven - Deluxe Features

Defrosting

The oven uses the convection element and fan for this process.

WARNING

To avoid food poisoning, cook meats immediately after defrosting them.

To defrost foods

1. Adjust the racks to the appropriate level. 
2. For best results put the food on an aluminum surface. Place the food on the center of the oven rack.
3. Touch **Oven Menu**.

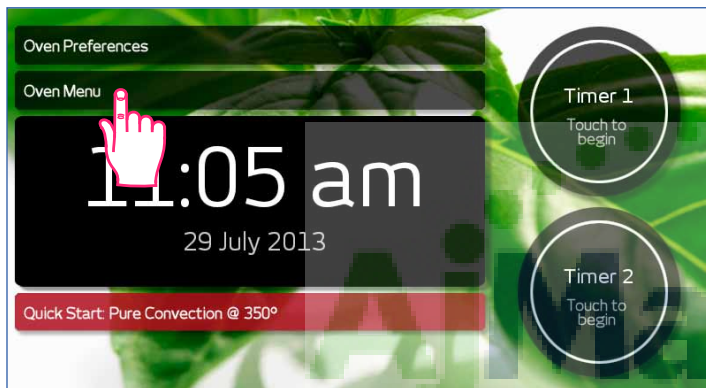

4. Touch **Defrost** on the main menu.

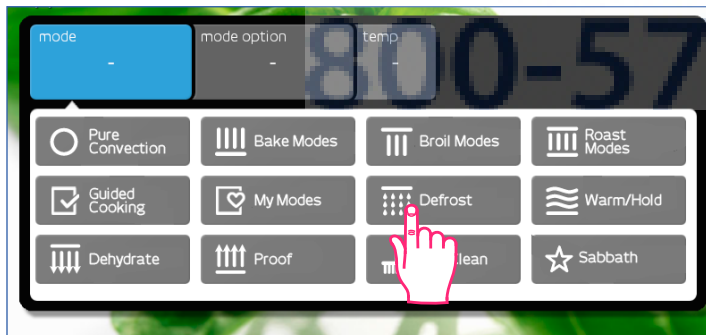

5. If you want to change the preset temperature, touch **temp**.



6. The temperature adjustment bar will appear. Touch and slide the pointer back and forth to select the desired defrost temperature. Touch the arrows on either end of the adjustment bar to make minor adjustments.

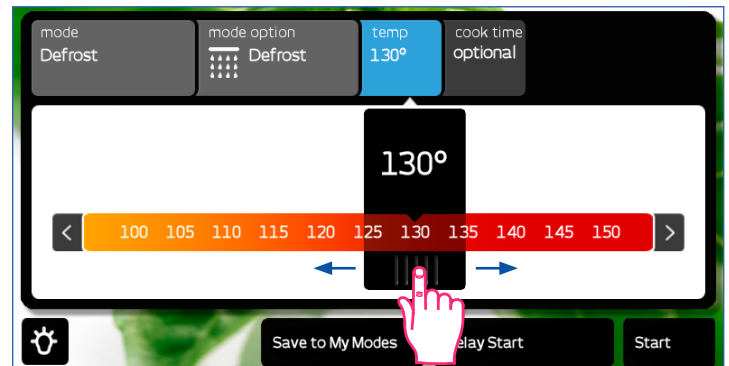

7. Touch **Start**.

Defrosting Tips

- Food that takes an exceptional amount of time to defrost will not defrost well in a convection oven.
- You should not defrost anything that would normally take over two hours to thaw. The food will begin to spoil because the defrost temperature is not high enough to cook the food.
- If you have a partially defrosted turkey, rib roast or other large cut of meat, you may continue to defrost it in your convection oven. If wing tips and legs begin to dry out when you defrost poultry, you may wrap the tips with aluminum foil.
- If you are defrosting a small cut of meat, lay it on a flat cookie sheet with a one inch rim to catch juices as the meat thaws.
- Thick, frozen casseroles such as lasagna will not defrost well in your oven. Instead, defrost according to the food manufacturer's suggestions. You can defrost casseroles in a refrigerator overnight. You should leave the food in its original container and keep it covered.
- You can bake some foods from frozen. Some examples are: pizza, frozen pastries, croissants, cookies, etc. Before baking frozen food, allow the oven to preheat.

Operating Your Oven - Deluxe Features

Dehydrating

The oven uses the convection element and fan for this process.

To dehydrate foods

1. Adjust the racks to the appropriate level.
2. Prepare the food as recommended, then place it on a drying rack. Place the food on the center of the oven rack.
3. Touch **Oven Menu**.



4. Touch **Dehydrate** on the main menu.

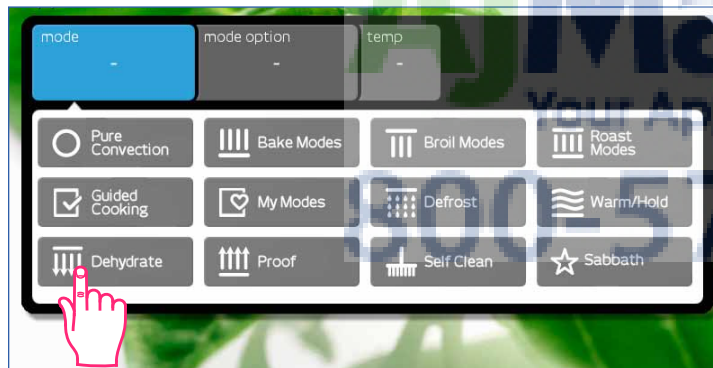

5. If you want to change the preset temperature, touch **temp**.

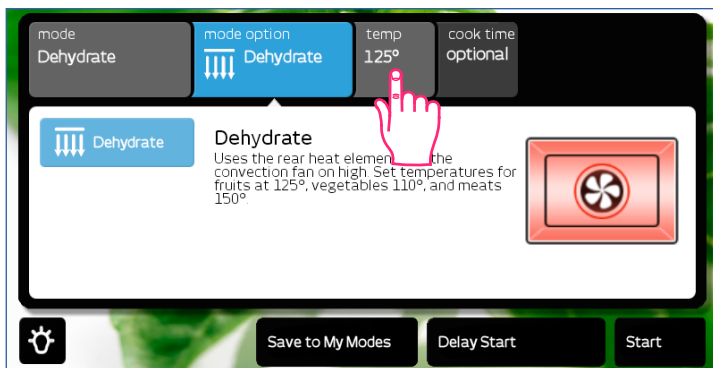

The temperature adjustment bar will appear. Touch and slide the pointer back and forth to select the desired dehydrate temperature. Touch the arrows on either end of the bar to make minor adjustments.

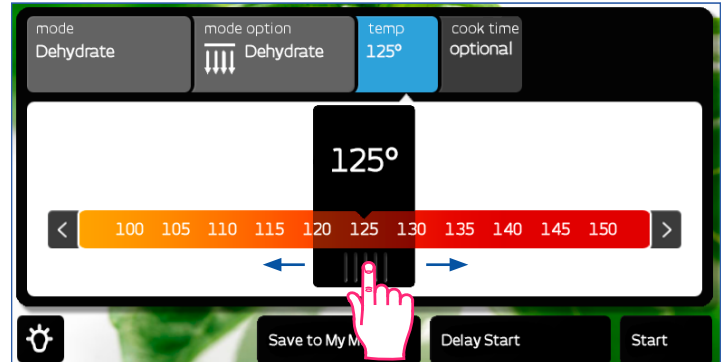

6. Touch **Start**.

Food Type	Dehydrating Temperature
Fruit	125°F (52°C)
Meat	150°F (65°C)
Vegetables	110°F (43°C)

Recommended Dehydrate Temperatures

Dehydrating Tips

Equipment Recommended:

- Half sheet pan or jelly roll pan with ½ inch rim all the way around
- Baking rack that fits inside the half sheet pan
- Cheesecloth
- 4 quart sauce pot with lid
- Steamer basket that fits inside four quart saucepan. One that is perforated and opens up will work well.
- Slotted spoon
- Paper towels
- A sharp knife

When you dehydrate...

1. Wash and remove excess moisture from all fruits and vegetables before dehydrating.
2. Cut fruits and vegetables into uniform pieces.
3. You can add honey, spices, lime juice or orange juice to give the fruit a different flavor.
4. It is best to dehydrate on a baking rack with a pan underneath to catch any juices. If the fruit is small, use cheesecloth over the rack. If you use a rack, it will allow for maximum air circulation around the fruit. The cheesecloth will prevent the fruit from sticking to the rack.
5. Place the food onto the center of the oven rack.

Operating Your Oven - Deluxe Features

Solving Discoloration Problems

To prevent darkening during dehydration and storage, you should steam blanch apples, apricots, peaches, nectarines, pears or foods that will oxidize.

To steam blanch:

1. Add 1 inch of water to a four quart sauce pot. Insert the steam basket and place the fruit in it.
2. Cover the pot and steam for 1 to 2 minutes.
3. Remove with a slotted spoon and dab with a paper towel to remove excess moisture before dehydrating.

Apples, pears, pineapples and some other fruits will brown or darken during dehydration. To prevent discoloration, dip fruits in pineapple juice or lemon juice after steam blanching.

Creating a Candied Effect

To give the fruit a candied effect and to help retain color, blanch them in a simple syrup. You can candy the fruits mentioned above as well as figs and plums. The basic ratio for a simple syrup is one cup of sugar to one cup of water. Add these ingredients to a four quart stock pot and bring to a boil. Stir until all the sugar dissolves. Remove the saucepan from the cooktop and allow it to cool. Dip fruit into the simple syrup after it has cooled.

Preventing Tough Skins when Dehydrating

You should water blanch items with tough skins such as grapes, prunes, dark plums, cherries, figs and some types of berries. Water blanching these types of fruit will crack the skins so that moisture can escape and dehydration can be done more effectively.

To water blanch...

1. Bring 2 quarts of water to boil in a four quart sauce pot.
2. Drop the fruit in the water for 1 to 2 minutes, or until the skin begins to crack.
3. Remove the fruit with a slotted spoon and dab dry with a paper towel before dehydrating. The pit can be left inside or removed half way through the dehydrating process.

Proofing

You can use your oven to proof yeasted doughs. The oven uses bake element for this process. This mode allows dough to rise more quickly in a warm, draft-free environment.



1. Adjust the racks to the appropriate level.
2. Touch **Oven Menu**.



3. Touch **Proof** on the main menu.

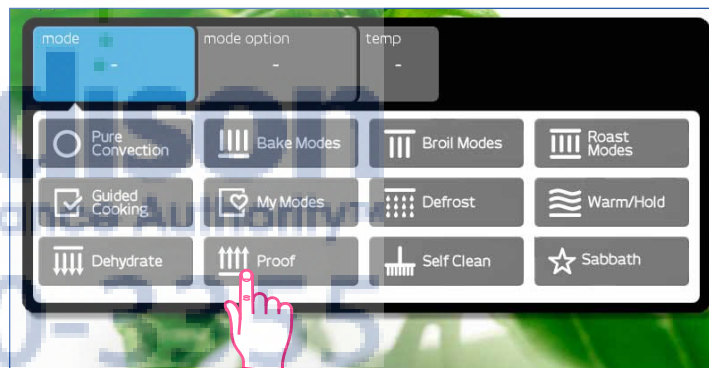

4. Touch **Start**.
5. Place the dough in a greased bowl inside of the oven. Cover it with either a damp cloth or plastic wrap coated with a nonstick spray.
6. Turn on the oven lights.
7. Set the timer for the amount of rise time in the recipe.

Operating Your Oven - Deluxe Features

Delay Start/Cook Time Features

If you want to set the oven to automatically turn itself on and off at a later time, you can use the Delay Start/Cook Time features.

NOTE

- The Delay Start and Cook Time features do not work with Broil, Max Broil and Convection Broil modes.
- Cook Time cooking cannot be used in Sabbath mode or any of the broil modes. Delay Start cannot be used with any of the broil modes, Warm/Hold mode and Proof mode.
- Use of the Cook Time feature and the meat probe at the same time is not recommended because one can conflict with the timing of the other.

Things to Know About the Delay Start/Cook Time Features

- **Delay Start** determines when the oven turns on and Cook Time determines when the oven turns off. You can use them together or independently to:
 - ◇ Turn the oven on and off automatically (use both features).
 - ◇ Turn the oven on automatically and leave it on until you turn it off manually (use Delay Start only).
 - ◇ Turn the oven on manually and turn it off automatically (use Cook Time only).
- You may use the timers while using the Delay Start/Cook Time features. The timers do not effect the Delay Start/Cook Time settings.
- Delay Start and Cook Time can be canceled at any time by touching **CANCEL · SECURE**.

WARNING

Food safety is an important consideration when using the Delay Start/Cook Time features. To avoid potential sickness and the spoiling of food, take the following steps:

- Avoid using foods that will spoil while waiting for the oven to start cooking. Typical foods to avoid include: those containing eggs and dairy products, cream soups and cooked or uncooked meats, poultry and fish.
- Do not allow foods to remain in the oven after it turns completely off. When the temperature drops below 140°F (60°C), bacteria can develop (after Keep Warm mode).
- If cooking will not begin immediately, place only very cold or frozen food into the oven. Most unfrozen foods should never stand in the oven for more than two hours before cooking begins.

About Keep Warm Mode

- When you set the oven to stop cooking using Cook Time, the oven will go into Keep Warm mode at the end of the cook time you have set. As this happens, the control panel will beep for 30 seconds and **Keep Warm** will appear on the display. In keep warm mode, the oven will keep the temperature at 150°F (65°C) for two hours.



- After 2 hours, **Mode Completed** will appear on the display and the oven will shut off completely.
- Touch **CANCEL · SECURE** to clear Keep Warm mode and turn the oven all the way off or to clear the display after the mode is completed.

Using the Start Time/Cook Time Features

1. Adjust the racks to the appropriate level and place the food in the oven.
2. Touch **Oven Menu**.



Operating Your Oven - Deluxe Features

3. Select the desired cooking mode, sub-mode and temperature according to the **Starting Your Oven - Main Menu** section on page 11, but before touching **Start**, perform steps 4 and/or 5 below.

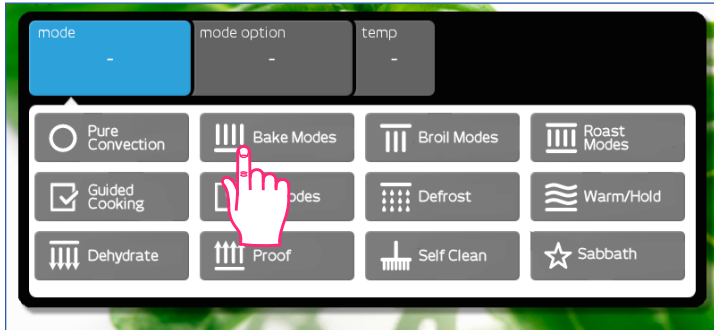

4. If you want to turn the oven on immediately skip to step 5.

- ◇ Touch **Delay Start**.

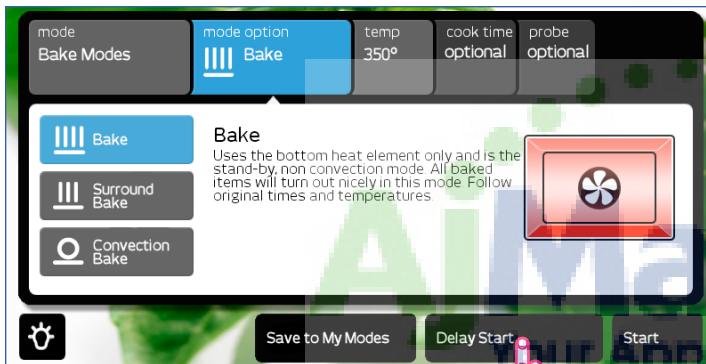

- ◇ The time adjustment bar appears. Touch and slide the pointer back and forth to select the desired start time.



- ◇ Touch **Set Delay**.
- ◇ If you want the oven to run continuously until you shut it off manually, go to step 6. Otherwise, touch **Start**.

5. Set the **Cook Time**:

- ◇ Touch **cook time**.

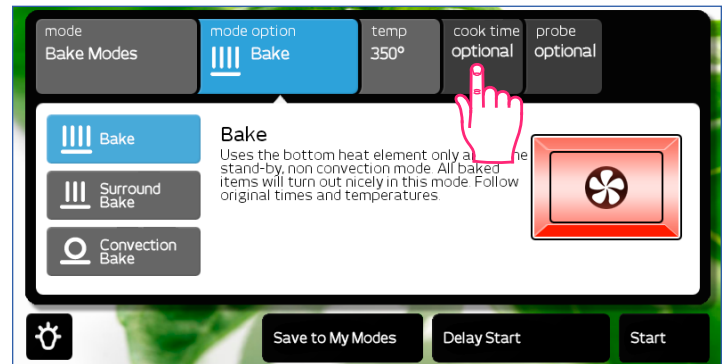

- ◇ Enter the **Cook Time** in hours and minutes on the keypad that appears on the touch display. You can also touch the up (^) and down (v) arrows to make small adjustments to the time. **NOTE:** Touching **Clear** once clears the display and allows you to re-enter the time.

- ◇ Touch **Count Up** or **Count Down**. If you touch **Count Up**, the display will start at 00:00 and count up to the time entered, if you touch **Count Down**, the display will start at the time entered and count down to 00:00.

The oven will cook for the amount of cook time set whether it is turned on manually or automatically using **Delay Start**.

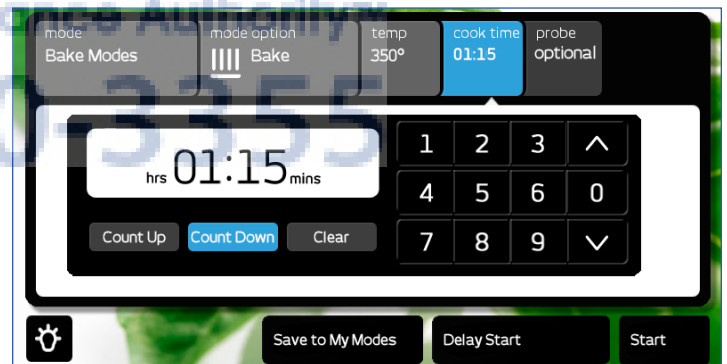

6. Touch **Start**.

IMPORTANT

The time required to preheat the oven must be included in the amount of cook time. For cooking temperatures of 350°F (175°C) and below, add about 13 minutes to the cook time. Increase the cook time as the temperature increases above 350°F (175°C).

To cancel the Delay Start/Cook Time settings, touch **CANCEL · SECURE**.



Operating Your Oven - Deluxe Features

Using the Meat Probe

When you cook foods like roasts and poultry, the internal temperature is the best way to tell when the food is properly cooked. Your oven's meat probe is an easy way to take the guesswork out of roasting. You can use it to cook food to the exact temperature you desire. The probe can be set from 125°F (51°C) to 185°F (85°C).



WARNING

- To avoid the possibility of burns, use hot pads to handle, connect, and unplug the meat probe when the oven is hot.
- Use the handles to insert and remove the meat probe's skewer and to connect it to the oven. Pushing or pulling on either end of the cable could damage the meat probe. To avoid breaking the meat probe, make sure the food is completely defrosted before inserting the skewer.
- Do not allow foods to remain in the oven after it turns completely off. When the temperature drops below 140°F (60°C), bacteria can develop (after Keep Warm mode).
- To prevent damage, never leave the meat probe inside the oven when it is not being used, especially during the self-clean cycle.
- Using a meat probe other than the one provided with your oven may result in damage to the probe and/or the oven.

NOTE

- The meat probe does not work with Broil, Max Broil, Convection Broil and Sabbath modes. Plugging in the meat probe when using one of these modes will cause an error signal to appear on the display.
- Use of the meat probe and Cook Time feature at the same time is not recommended because one can conflict with the timing of the other.

To use the meat probe...

1. Prepare the meat for cooking prior to setting the oven. Insert the meat probe skewer into the center of the meat. Make sure that the skewer is not inside any fatty portions of the meat and does not touch any bones. The point should rest in the thickest part of the meat. When you are cooking fowl, the tip of the skewer should rest toward the center of the bird.

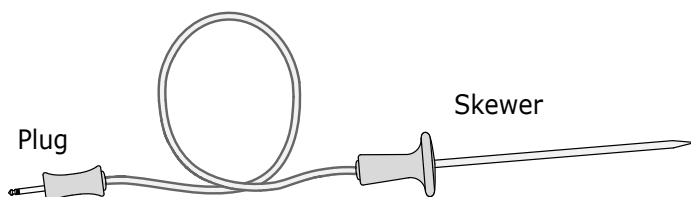

2. Adjust the racks to the appropriate level to allow the meat to fit in the oven.

3. Touch **Oven Menu**.



4. Select the desired cooking mode, sub-mode and temperature according to the **Starting Your Oven - Main Menu** section on page 11.

5. Touch **probe**.



6. The probe temperature adjustment bar will appear. Touch and slide the pointer back and forth to select the desired "cook to" (target) temperature. Touching the arrows on either end of the adjustment bar allows you to make minor adjustments. Use the **USDA Minimum Safe Cooking Temperature Chart** on page 26 as a guideline for the type of meat you are cooking. **NOTE:** Touch **ON/OFF** if you change your mind and want to cancel probe operation.

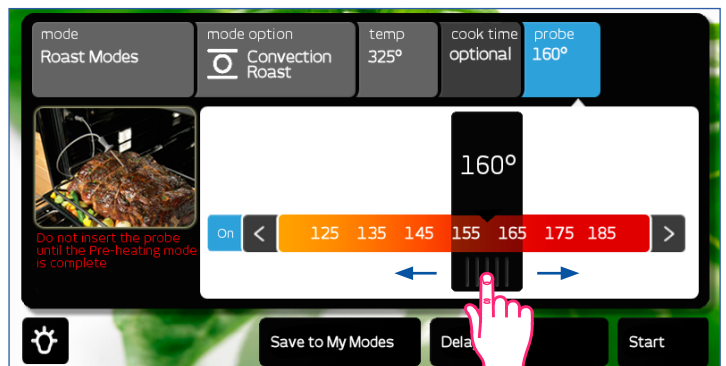

7. Touch **START**.

Operating Your Oven - Deluxe Features

8. Allow the oven to preheat before placing the food in the oven.
9. Once the oven has preheated (**Insert Food** appears), put the meat in the oven using pot holders. Insert the meat probe plug into the connector inside the oven and close the door. If you forget to connect the meat probe, and error message will appear on the display. The meat probe function will automatically cancel after 2 minutes if the meat probe is not connected.
10. Touch **START**. If you do not touch **START**, the probe mode will not start.
 - ◇ When the meat probe is in use, the oven will automatically control the cooking time. During cooking, four temperatures appear on the display.

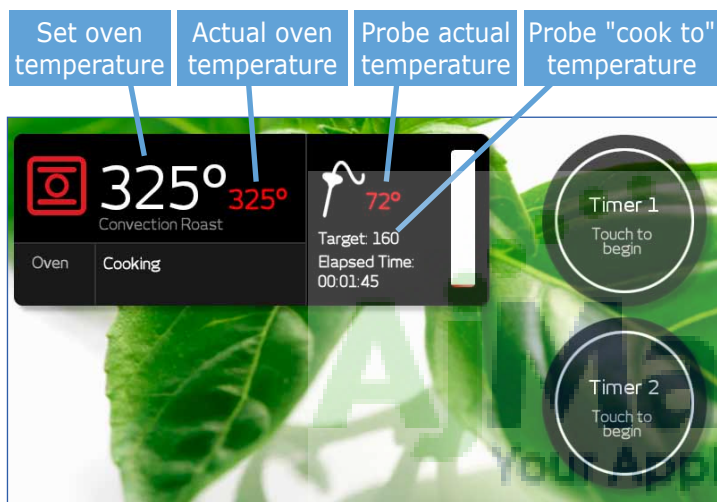

- ◇ The oven will continue to cook until the meat's internal temperature reaches the "cook to" (target) temperature you have selected.
 - ◇ When the meat is done, the oven will go into Keep Warm mode. As this happens, the control panel will beep for 30 seconds and **Keep Warm** will appear on the display. In keep warm mode, the oven will keep the temperature at 150°F (65°C) for two hours.
 - ◇ After 2 hours, **Mode Completed** will appear on the display and the oven will shut off completely.
11. Touch **CANCEL · SECURE** to clear Keep Warm mode and turn the oven all the way off or to clear the display after the mode is completed.

To change the meat probe temperature during cooking...

1. Touch the probe icon.



2. The probe temperature adjustment bar will appear. Touch and slide the pointer back and forth to select the desired "cook to" (target) temperature. Touch the arrows on either end of the bar to make minor adjustments.

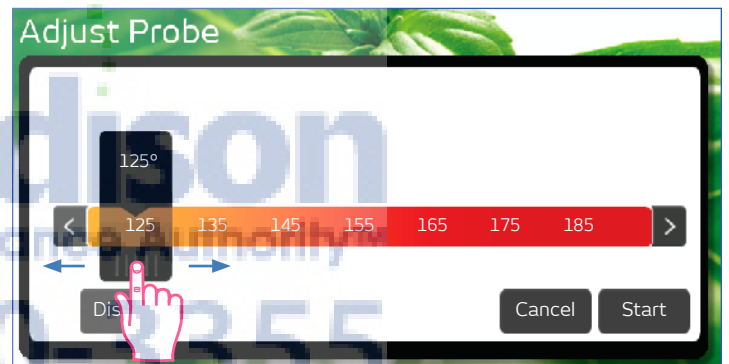

3. Touch **START**.

To change the cooking mode during meat probe cooking...

1. Touch the cooking mode icon, left of the temperature setting.

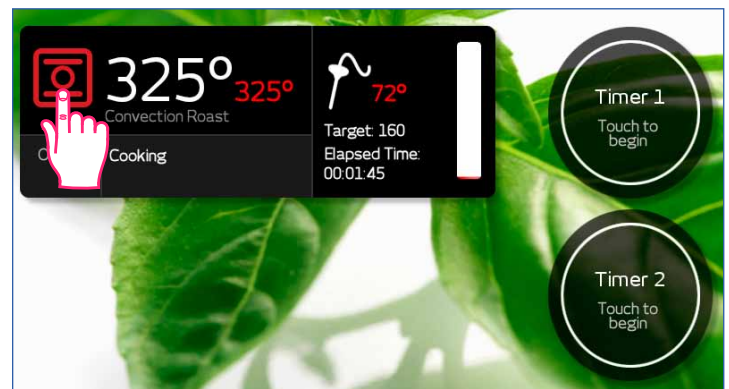

continued...

Operating Your Oven - Deluxe Features

Changing the cooking mode during meat probe cooking (cont.)

- The main cooking menu will appear. Touch the new desired cooking mode (and sub-mode).

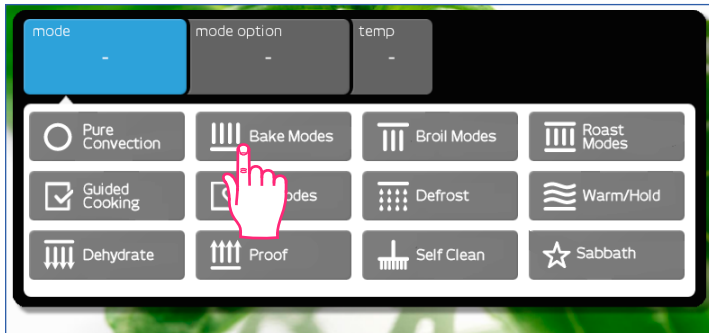

- If you want to cook at a temperature different from the preset temperature, touch **temp**.

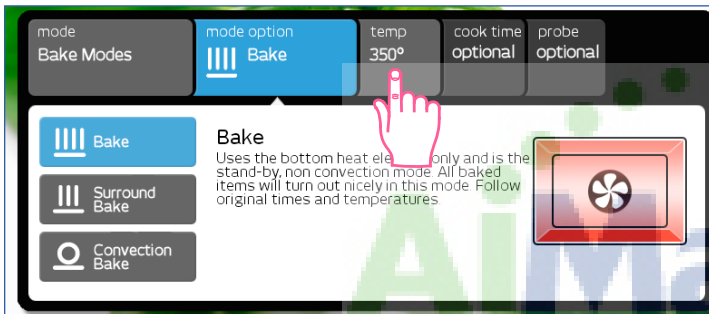

Touch and slide the pointer back and forth to select the desired cooking temperature. Touch the arrows on either end of the bar to make minor adjustments.

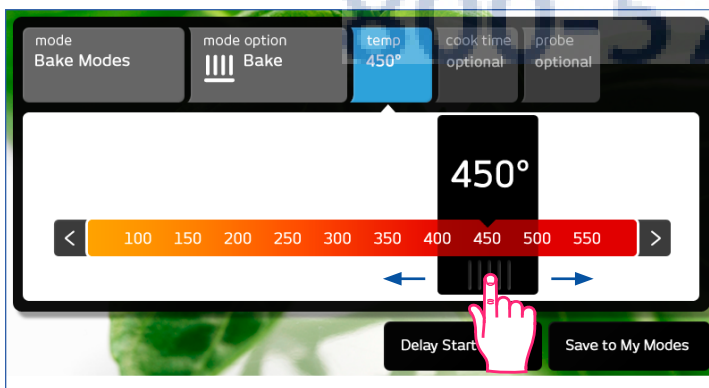

- Touch **probe**.

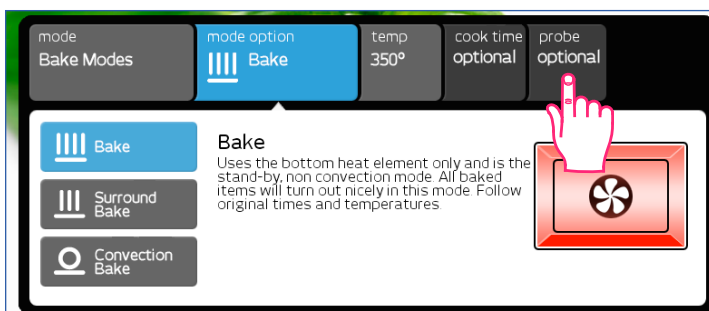

- Touch and slide the pointer on the probe temperature adjustment bar back and forth to select the desired "cook to" (target) temperature.

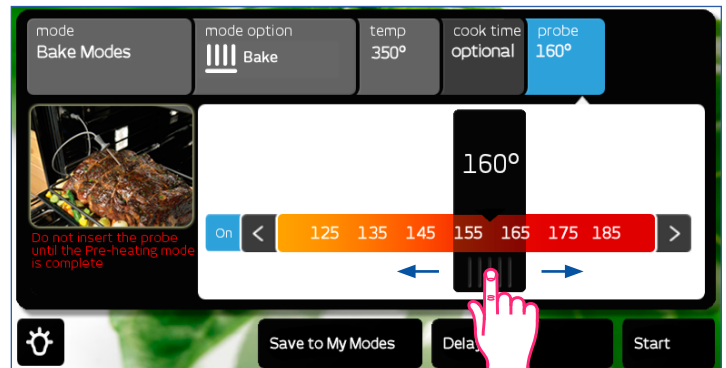

- Touch **Start**.

NOTE

- Since you have restarted the oven during this process, **Insert Food** may appear on the display. Touch **Start** to clear the message.
- If you increase the temperature by more than 50°F (28°C), remove the food from the oven to avoid excessive browning.

USDA Minimum Safe Internal Cooking Temperatures for Various Foods

Ground Meat and Meat Mixtures

Beef, pork, veal, lamb	160°F (71°C)
Turkey, chicken	165°F (76°C)

Fresh Beef, Veal and Lamb

Steaks, roasts, chops	145°F (65°C)
-----------------------	--------------

Poultry

Chicken and turkey, whole (temperature taken in thigh)	165°F (76°C)
Poultry breasts, roast	165°F (76°C)
Poultry thighs, legs, wings	165°F (76°C)
Duck and goose	165°F (76°C)
Stuffing (cooked alone or in bird)	165°F (76°C)

Fresh Pork

Fresh pork	160°F (71°C)
------------	--------------

Ham

Fresh (raw)	160°F (71°C)
cooked (reheat)	140°F (60°C)

NOTE: The minimum safe internal cooking temperatures are subject to change. There are changes in bacteria and the temperatures required to eradicate them. For the most current information, contact the USDA.

USDA Meat and Poultry Hot Line: Phone: (800) 535-4355
www.fsis.usda.gov

Operating Your Oven - Deluxe Features

Guided Cooking

Your oven is equipped with the convenience of the Dacor Guided Cooking System. The Dacor Guided Cooking System takes a lot of the guesswork out of cooking. You select the type of food, and the oven will set the temperature, the mode and show you the amount of time required to cook.



How to Use Guided Cooking:

1. Before you turn on the oven, position the racks.
2. Touch **Oven Menu**.



3. Touch **Guided Cooking**.

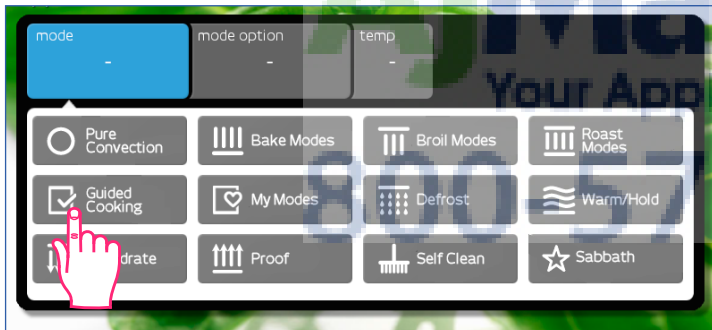

4. Select the category of food you want to cook. For example, **Meat** (touch and drag to view options further down the list).
5. When you select the category, the oven will list several specific types of food for you to pick from. Touch to select the specific type of food. The oven will determine the optimal mode and cooking temperature.

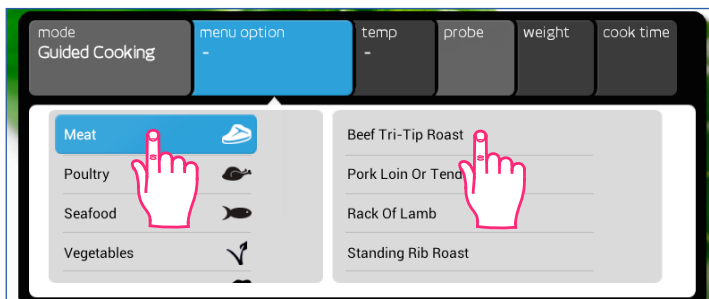

For Meats, Poultry and Seafood:

After you select the type of meat, you can choose to cook using the meat probe or to cook by weight.

- To use the meat probe, touch and slide the pointer back and forth to select how well the meat is to be cooked. Touch the arrows on either end to make minor adjustments. Touch **Start**. Insert the meat probe into the meat according to the instructions on page 24. Insert the meat into the oven and connect the meat probe when instructed on the display.

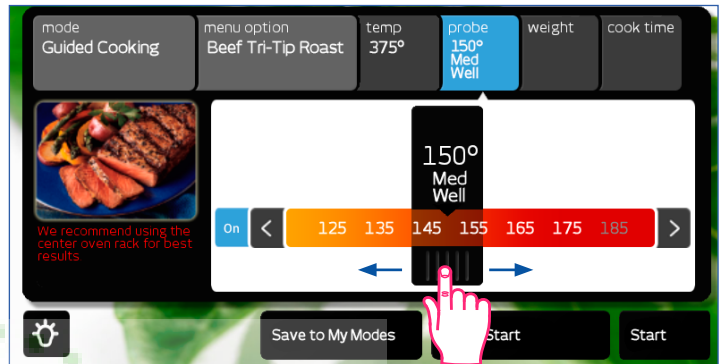

- To cook by weight, touch the **ON/OFF** key next to the meat probe temperature slider (shown above) after selecting the specific meat type. Touch the up (^) and down (v) arrows to select the weight. Touch **Start**.

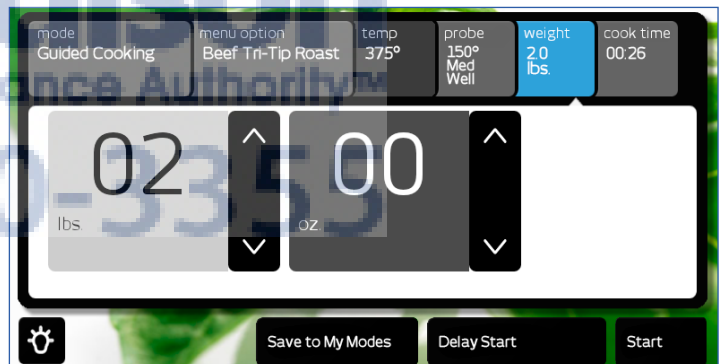

For Vegetables, Breads, Deserts and Other items:

- Touch **Pan Size**, then touch the type of cookware being used on the touch display.



Touch **Start**.

continued...

Operating Your Oven - Deluxe Features

Important Tips for Using Dacor Guide

- For best results, follow the helpful instructions on the display.
- The oven will preheat when you touch **Start** and instruct you to place the food in the oven when pre-heat is complete.
- When the oven is through cooking for the amount of time indicated, the oven will reduce the temperature to 150°F (65°C) to keep the food warm for two hours ("**Keep Warm**" appears on the display).
- At the end of the keep warm cycle, the oven will turn off and **Mode Completed** will appear on the display.
- As with all other cooking modes, to turn off your oven touch **CANCEL · SECURE**.

My Modes

The My Modes feature allows you to save the oven settings for dozens of your favorite recipes. Once you save the settings, the oven remembers them and you can use them to automatically set the temperature, meat probe and cooking time so that you don't have to look them up.

You save the settings after you select the feature you want to use, but just before touching **Start**.

To save the oven settings for your favorite recipe:

1. Touch **Oven Menu**.



2. The main cooking menu will appear on the display. Select the mode for the settings you want to save. You may select from:

Convection Modes	Bake Modes	Broil Modes
Roast Modes	Defrost	Warm/Hold
Dehydrate	Proof	

3. If you select a Convection, Bake, Broil or Roast mode, select the sub-mode (for example Convection Roast).

4. Touch **temp** and select the cooking temperature if you want. You may also set **cook time**, (meat) **probe** and **Delay Start**.
5. Just before you touch **Start**, touch **Save to My Modes** on the display.

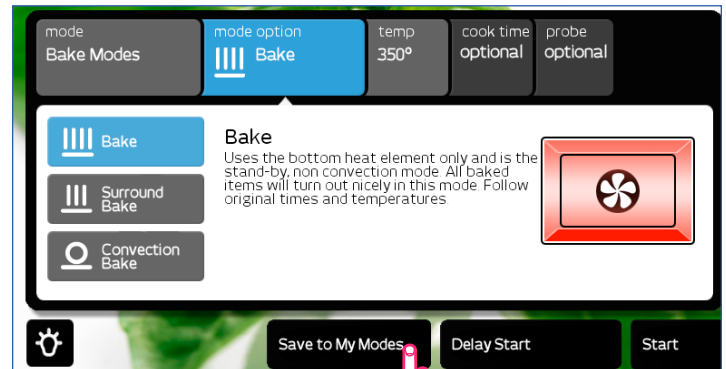

6. Touch the white area labeled **Type Your Mode's Name Here** on the touch display.

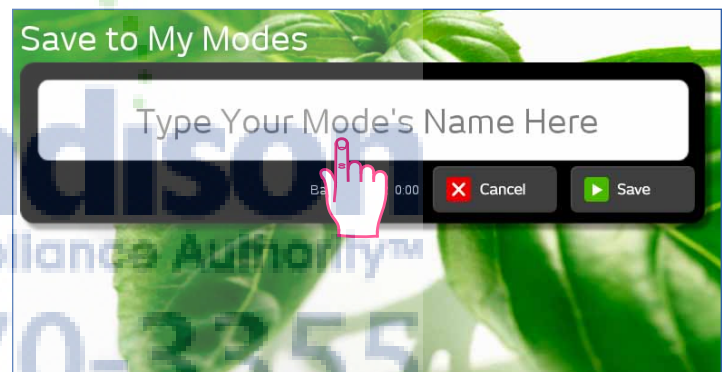

7. The keyboard will appear on the display. Enter the name you want to use to remember the cook settings you are saving, then touch **Done**.

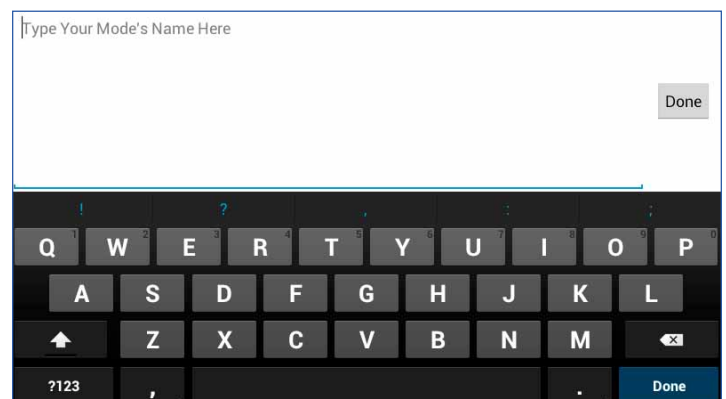

8. Touch **Save**. **NOTE:** The saved settings will not be lost in the event of a power outage.

Operating Your Oven - Deluxe Features

How to use the oven settings you have saved

1. Adjust the racks to the appropriate level.
2. Touch **Oven Menu**.



3. Touch **My Modes** on the main menu.

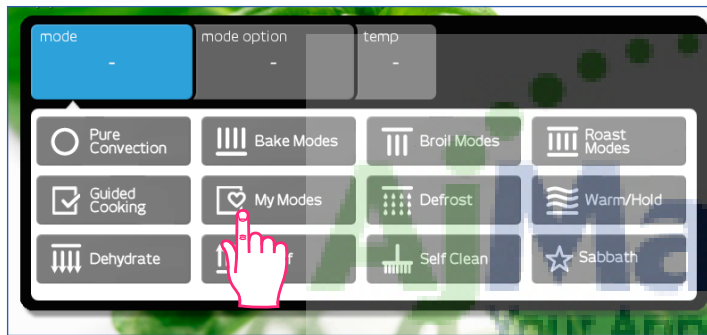

4. Touch the desired, stored cooking mode on the display. Touch and drag to see additional entries not shown on the display.

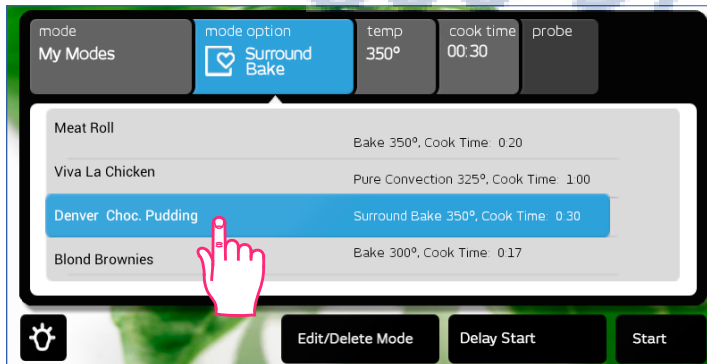

5. Touch **Start**.

To delete a mode that you have previously saved:

1. Touch **Oven Menu**.



2. Touch **My Modes** on the main menu.

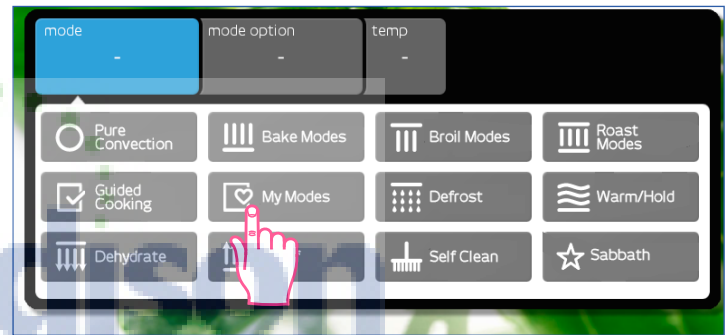

3. Touch the stored cooking mode you want to delete on the display.

4. Touch **Edit/Delete Mode**.

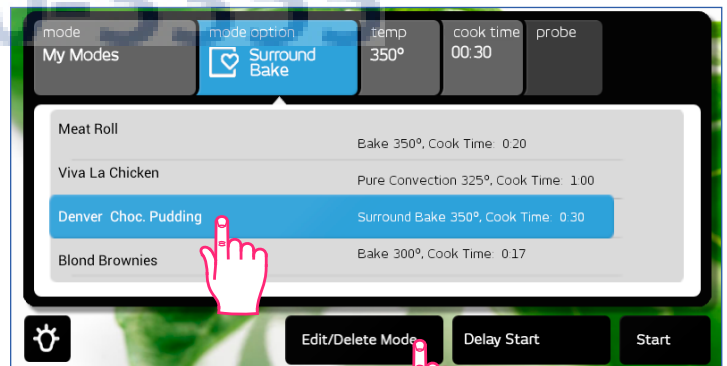

5. Touch **Confirm Delete**.

6. Touch **HOME** to return to the oven home screen.

continued...

Operating Your Oven - Deluxe Features

My Modes (cont.)

To Change the name of a mode that you have previously saved:

1. Touch **Oven Menu**.



2. Touch **My Modes**.

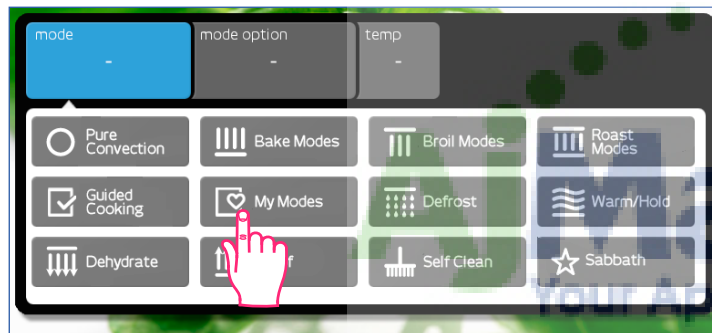

3. Touch the stored cooking mode you want to edit the name for on the display.

4. Touch **Edit/Delete Mode**.

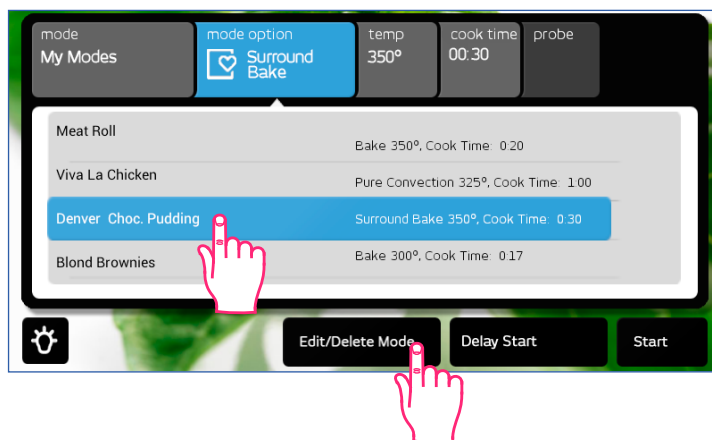

5. Touch **Edit Mode**.

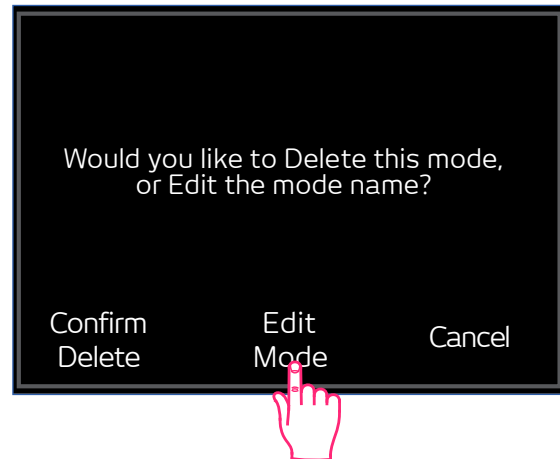

6. Touch the white area containing the current name.

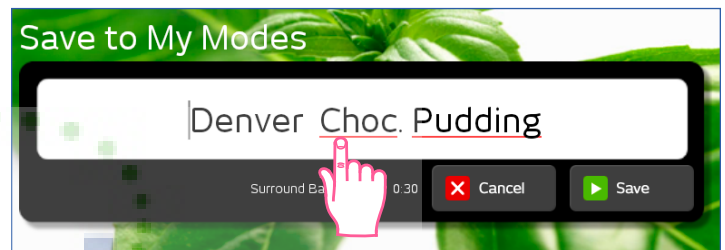

7. Use the keyboard to edit the name of the saved mode, then touch **Done**.

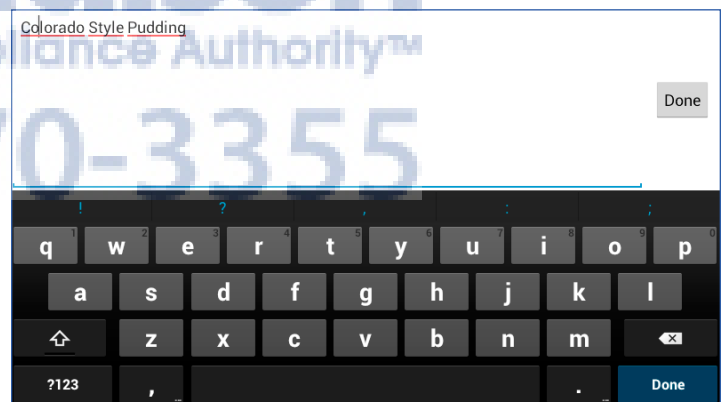

8. Touch **Save**.

Operating Your Oven - Deluxe Features

Sabbath Mode

The Sabbath mode on your oven complies with Jewish laws for use on the Sabbath and Holy Days. This feature allows the oven to perform two types of cooking, Pure Convection and Bake.



When the oven is set to Sabbath mode, it disables the following features:

- The oven lights
- All keys, except **CANCEL · SECURE, START · CONTINUE** and the temperature up and down arrows.

IMPORTANT

- **Sabbath Mode** and the cooking temperature appear on the display when Sabbath mode is in operation.
- Sabbath mode will not work with the meat probe connected (the meat probe symbol will flash).
- If one or both timers are running, the oven cancels timer operation when Sabbath mode is selected.
- You may want to use a rack thermometer to keep track of the oven temperature.

Using Sabbath Mode

1. Touch **Oven Menu**.



2. Touch **Sabbath** on the main menu.

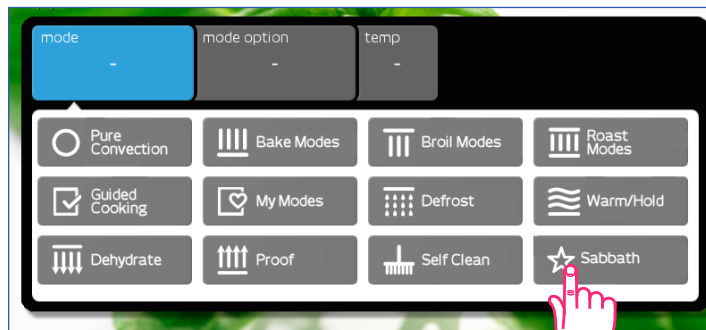

3. Touch **Sabbath Convection** or **Sabbath Bake**.
4. If you want to change the preset cooking temperature, touch **temp**.

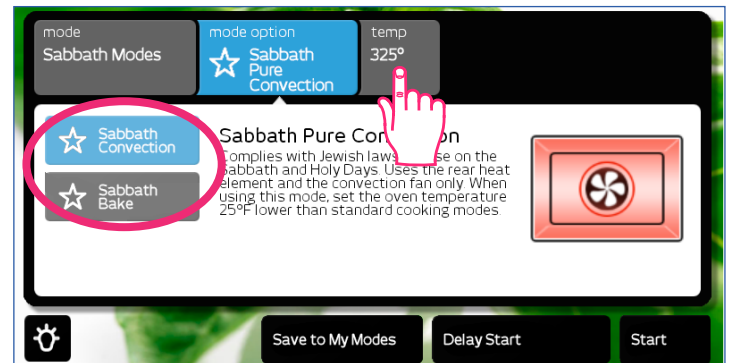

Touch and slide the pointer on the temperature adjustment bar to select the desired cooking temperature.

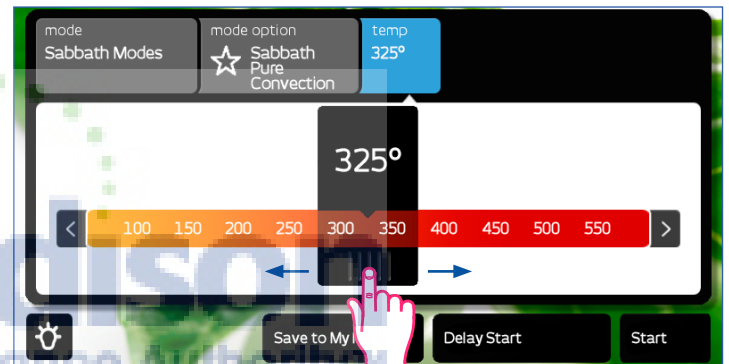

5. If you do not want to delay the starting of the oven skip to step 6. If you want to delay the start of the oven, touch **Delay Start** on the touch display.
6. Touch and slide the pointer on the Delay Start adjustment bar to select the start time. Touch **Set Delay** to activate.



7. Touch **Start**.

The **CANCEL · SECURE** key on your oven remains active so that you can turn off the Sabbath feature or turn off the ovens.



continued...

Operating Your Oven - Deluxe Features

Things to Know about Sabbath Mode

- When the oven is cooking, touching the up (^) and down (v) arrows (see picture), tells the oven to raise the temperature by 25°F (14°C). In compliance with Jewish law, the bake elements will be adjusted randomly when these keys are touched and no changes will be seen on the display.
- You can store a variety different Sabbath settings using the My Modes feature (see page 28) and then, select the one you want to use each time.

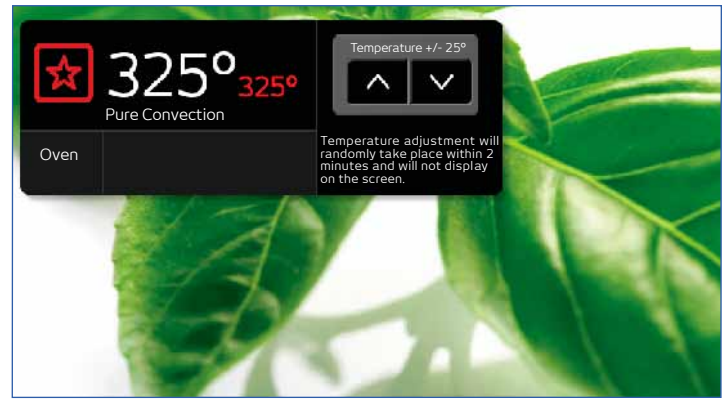

AjMadison
Your Appliance Authority™
800-570-3355

Additional Features

Android Operating System

In addition to the Dacor Cooking App (application), you can access the many features of the Android operating system on your oven, including:

- Accessing and browsing web sites on the internet.
- Downloading and running Android apps, in addition to the standard apps that come with your oven.
- Downloading and playing music and videos.

All this can be done while your oven continues to cook.

Android Touch Keys/Icons

The Android touch keys and icons appear in the Android navigation and status bar at the bottom of the touch display.

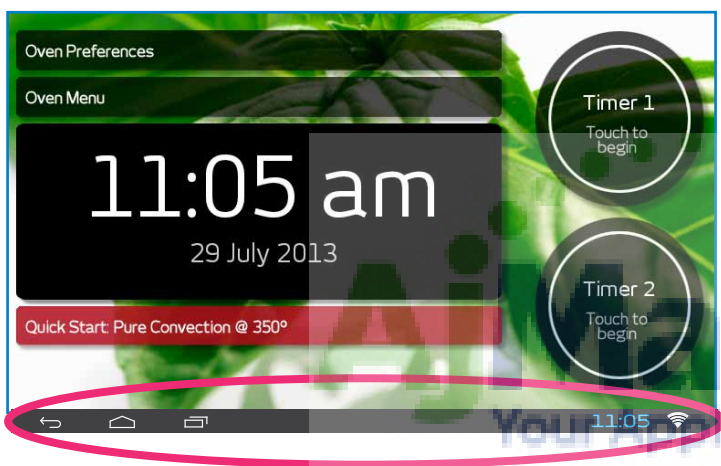

Listed below are the most often used keys and icons, and what they mean:



Back - Touch this key to go back one screen on the Android operating system.



Home (Android) - Touch to go to the Android operating system home screen.



Active Apps - Touch to show a list of all active Android apps, including the Dacor Cooking App. Touch the **return** (v) icon to return to the main navigation bar.



WiFi - Indicates WiFi connection is active.

Using the Android Operating System

- To access the Android operating system, touch the Android home icon on the bottom left of the touch display, or when the *oven* home screen appears on the display, touch the **HOME** key on the control panel.
- To return to the *oven* home screen (Dacor IQ Cooking App), touch the **HOME** key on the control panel.
- Touch the time display, on the bottom right, to access the Android operating system setup menu.

Android Apps

Your oven comes with the following applications pre-loaded. They appear on the *Android* home screen. Touch the app icon to launch:

- Dacor IQ Cooking App - Takes you to the *oven* home screen. This app starts automatically when the *oven* is powered up, after a power failure or when you restart the computer (touch and hold **HOME** and **BACK** keys for 5 seconds).
- Dacor.com - Starts the web browser and takes you to the Dacor web site. Once started, you can use the browser to access other web sites as well.
- Playstore - Starts the web browser and takes you to the Google Play web site. From Google Play, you can download apps, music, videos and more.
- Calender - A standard calender application that allows you to schedule events, appointments and reminders.
- Gmail - Allows access to Gmail email accounts.

WiFi Settings

The Wifi Settings can be accessed through the **Oven Preferences** menu,



or by using the Android status bar (see picture on left). If using the time display on the status bar (bottom right), touch the time display, touch the pop-up menu that appears, then touch **WiFi**.

- If Wifi is OFF, touch the ON/OFF key and slide to the right to turn ON (see below).
- To connect the oven's Android operating system to your network, touch the network name and follow the prompts to finish connecting.

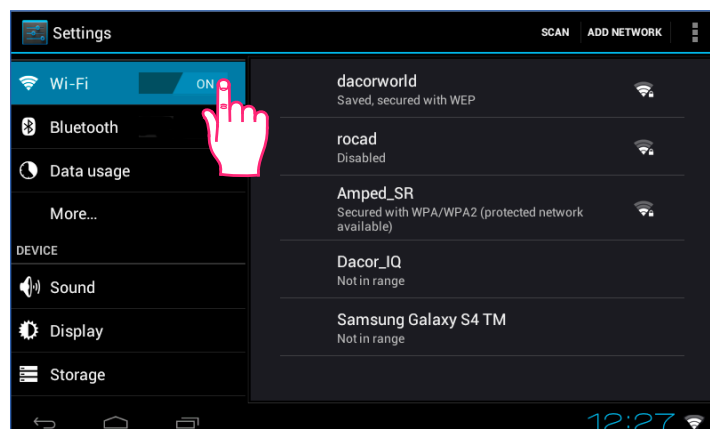

Cooking Tips

Food Placement

- Typically, when baking on two racks with your oven, use rack positions #3 and #5 (counting from the bottom up). When baking on three racks, use rack positions #2, #4 and #6.
- Turn pans on the racks so that the long sides run left to right, as you face them.
- When you are cooking a food item that is very heavy, use a Dacor GlideRack oven rack. You can pull it out further than a conventional rack, making it easier to check the food, stir or add ingredients.
- Heavier roasting pans and dishes will cook better on rack position #1.
- When using a baking stone, use rack position #3 for best results. If you put a baking stone on a GlideRack oven rack, instead of one of the standard oven racks, you can pull the stone out of the oven further, making pizza easier to remove.

The Best Use of Bake Ware

- You should bake cakes, quick breads, muffins and cookies in shiny, reflective pans for light, golden crusts. Avoid old, darkened, warped, dented, stainless steel and tin-coated pans. They heat unevenly and will not give good baking results.
- Use medium gauge aluminum sheets with low sides when preparing cookies, biscuits and cream puffs. Dacor cookie sheets (optional), with their low profiles, will give you the best results.
- Bake most frozen foods in their original foil containers, placed flat on a cookie sheet. Follow the package recommendations.
- When using glass bake ware, reduce the recipe temperature by 25°F (14°C), except when baking pies or yeast breads. Follow the standard recipe baking time for pies and yeast breads.
- Use the pan size and type recommended by the recipe for best results.
- For roasting, Dacor's optional "V" shaped rack and broil/roast pan works best to allow air circulation around the food.
- Dacor's roasting pan works particularly well and two of them will fit side by side in your oven.

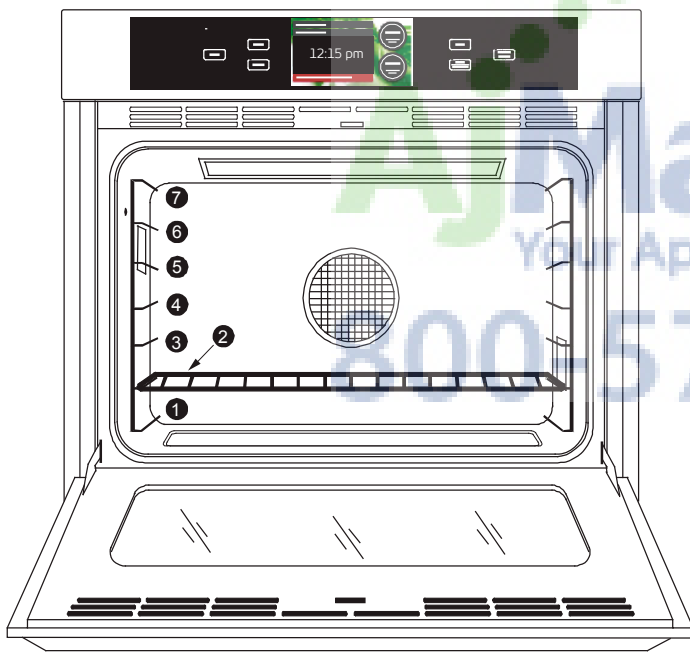

"V" shaped rack

Grill

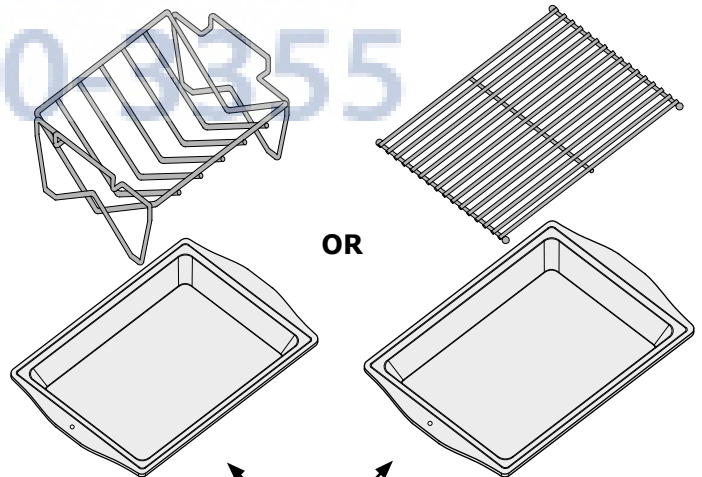

Deep dish broil-roast pan
(one per kit)

**Optional Broil and Roast Pan Kit
(AORPVR)**

Cooking Tips

High Altitude Cooking

Due to the lower atmospheric pressure at higher altitudes, foods tend to take longer to cook. Therefore, recipe adjustments should be made in some cases. In general, no recipe adjustment is necessary for yeast-risen baked goods, although allowing the dough or batter to rise twice before the final pan rising develops a better flavor. Try making the adjustments below for successful recipes. Take note of the changes that work best and mark your recipes accordingly. You may also consult a cookbook on high altitude cooking for specific recommendations.

Altitude (feet)	Baking Powder for each teaspoon, decrease by:	Sugar for each teaspoon, decrease by:	Liquid, for each cup add:
3000	5-10%	10 - 25%	5-10%
5000	10%	10%	20%
7000	25%	20%	20 - 25%



Description	Dacor Part Number
Halogen light bulb (12 Volt, 20 Watt)	100429
Meat probe	72723
Standard broil pan	82107
Grill for standard broil pan	82108
30 Inch standard type oven rack	106992
30 Inch GlideRack type oven rack	701464*, ARG030H**
Large capacity roast/broil pan with "V" shaped rack	AORPVR
Pizza baking stone	ABS16
Cookie sheets, 30 inch*** (3 per carton)	A0303CS

* Use this number for ordering a replacement under warranty.

** Use this number for ordering additional racks, not covered under warranty.

*** Dacor full size cookie sheets maximize oven rack baking capabilities by utilizing the total usable rack space.

To order parts or accessories, contact your Dacor dealer or visit www.everythingdacor.com.

Care and Cleaning

WARNING

- Clean only the parts of the oven listed in this manual. Clean them only in the manner specified.
- To avoid dangerous fumes or damage to your oven's surfaces and accessories, use only the types of cleaning solutions specified in this manual.
- To avoid burns, turn off the oven and make sure that all parts are cool before cleaning.
- To prevent damage, do not use abrasive or corrosive cleaners or applicators such as steel wool or scouring pads, on any part of the oven unless instructed to do so. Use only a sponge, soft cloth, fibrous or plastic brush or nylon cleaning pad for cleaning the surfaces of your oven.
- Do not use a steam cleaner to clean the oven. Steam could penetrate the electrical components and cause a short circuit.
- Do not try to remove heavy spills with a sharp object such as a knife or metal spatula. Sharp objects may scratch your oven's surfaces.

Your Oven's Self-clean Feature

About the Self-clean Cycle

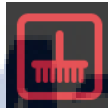

- The oven will run better and produce better baked goods when it is clean. During self-cleaning, the oven is heated to very high temperatures which burn off any deposits on the surfaces of the oven. Self-cleaning eliminates the need for manual scrubbing of interior surfaces. The self-clean process takes about 3 hours total.
- It is normal for the oven to emit smoke during the first few Self Clean cycles. It is also normal for the oven to emit popping sounds during self-cleaning. These sounds are caused by the expansion and contraction of metal surfaces when the oven heats up and cools down.
- Self-clean mode will not function if the meat probe is connected.

WARNING

- Always wipe up excess grease and other food spills with a damp cloth prior to using the self-clean cycle. Doing so will minimize smoke and increase efficiency. See proper cleaning instructions on this page.
- Do not touch the outside surfaces of the oven during the Self Clean cycle. They will be hot.
- Items left in the oven (including the racks) during self-cleaning will become damaged or damage the oven.

How to Use the Self-Clean Feature

IMPORTANT

- The oven lights do not operate while the oven is in Self Clean mode to protect them from damage.
- Attempting to use Self Clean with the meat probe connected will cause an error signal to appear on the display.

1. Before self-cleaning the oven, remove the racks, the convection filter, all cookware (pots, pans, forks, etc.), the meat probe, foil and any other loose objects from the oven chamber. See page 39 for filter cleaning instructions.
2. Clean soil from the porcelain surfaces of the door outside of the door gasket. Rinse surfaces well with a solution of vinegar and water, then wipe dry. Heavily soiled areas may be cleaned with a non-scratching scouring pad.
3. Clean the door gasket by dabbing it with a solution of water and mild soap.

WARNING

- Take extreme caution when cleaning the door gasket. Rubbing or displacing it may damage the tight door seal required for proper cooking and self-cleaning.
- Do not try to force the door open after it is locked. Damage to the door or latch may result.

4. Turn on kitchen fans or vents to help remove odors during the Self Clean cycle.
5. Make sure the oven door is shut.
6. Touch **Oven Menu**.



7. Touch **Self Clean** on the main menu.



Care and Cleaning

8. Touch **START · CONTINUE** on the control panel (to the right of the touch display).

**START
CONTINUE**

The control panel automatically locks the oven door during self-cleaning. The latch prevents the door from being opened since the high interior oven temperatures can easily cause injury. If the door is not shut, an error message will appear on the display. To correct the problem, touch **CANCEL · SECURE** and wait approximately one minute, then close the door. When the door is properly closed, start the Self Clean process again.

The display shows the Self Clean cycle status:

- ◇ **Cleaning** indicates that Self Clean is in process.
- ◇ **Door is Locked** indicates that the door is latched.
- ◇ **Cooling** indicates that the oven is in the "cooling down" portion of the Self Clean process.

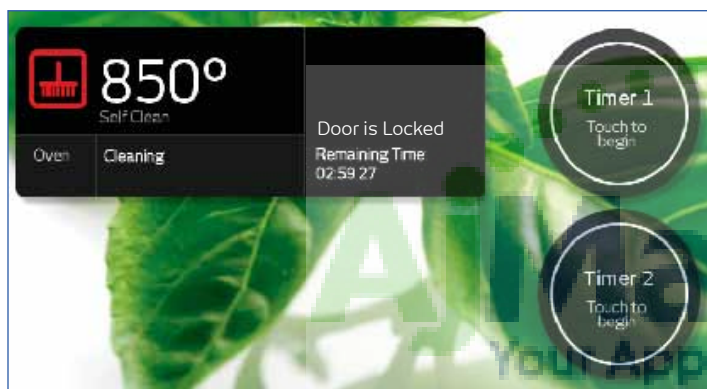

If you want to stop the self-clean cycle, touch **CANCEL · SECURE**. Keep in mind that the oven door will remain locked until it is safe enough to open. **Door is Locked** will disappear from the display when the door lock is released. You will still need to exercise caution when the door lock is released because the inside of the oven may still be hot.

After the self-clean cycle is complete...

- The door latch will release when the inside has cooled down. **Cooling** and **Door is Locked** will disappear from the display. Exercise caution because the oven will still be hot at the time the door lock is released.
- Reinstall the convection filter and oven racks before using your oven.
- You may notice a powder ash residue in the bottom of the oven after self-cleaning. This condition is normal. Use a damp cloth or sponge to wipe up the residue after the oven cools down.
-

Self-cleaning Tips

- If any soil remains in the oven after the Self-Clean cycle is done, you may repeat the cycle if you want.
- Self clean the oven regularly to prevent excessive soil build-up. Doing so will make the Self Clean cycle work better and reduce smoke and odors.

Green Clean

The green clean feature is a quick, simple, steam clean process used to clean light soil inside the oven. Green Clean allows you to save time and energy over the Self Clean process, which should be used for heavier soil build up. Also, unlike the self-clean process, the Green Clean process may be performed on both ovens at the same time.



WARNING

- To avoid steam burns, do not pour water into the oven when it is hot.
- The water remaining inside the oven will still be hot to the touch when the door is opened after the process is complete.

1. Remove the oven racks and all utensils from the oven.
2. Making sure the oven is cool, pour 1 1/2 cups of water (preferably distilled) into the recessed portion of the oven floor. For slightly heavier build up, you may mix a teaspoon of hand dishwashing soap into the water prior to pouring.
3. Fold a dish towel in half and insert the end (double thickness) between the door and the door gasket (right to left) to catch water that may dribble out during the process. Lay the rest of the towel just inside on the oven floor.

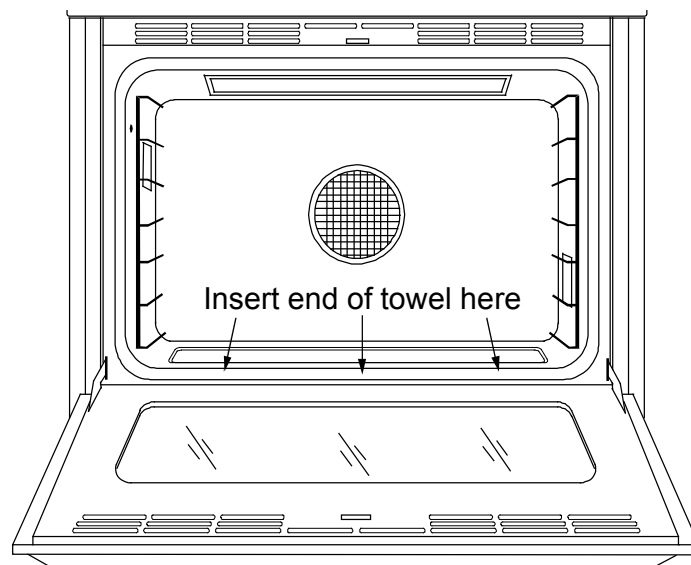

continued...

Care and Cleaning

Green Clean (cont.)

4. Close the oven door and touch **Oven Menu**.



5. Touch **Self Clean** on the main menu.

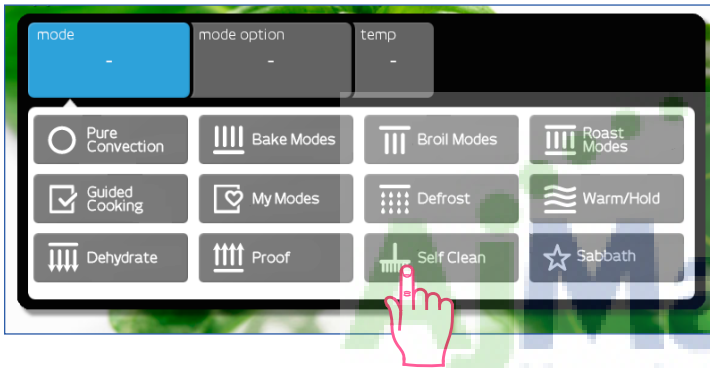

6. Touch **Green Clean**.

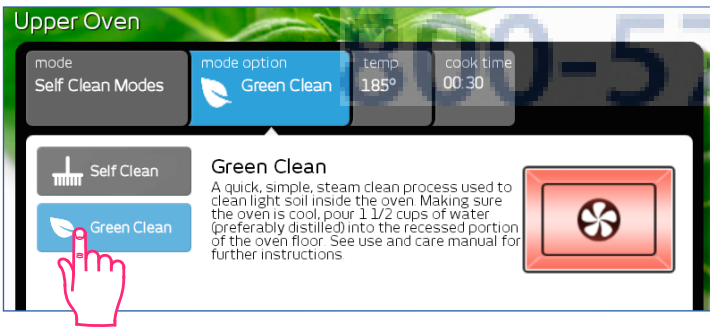

7. Touch **START · CONTINUE** on the control panel (to the right of the touch display). The control panel automatically locks the oven door during cleaning. The latch prevents the door from being opened to avoid the chance of steam burns. If the door is not shut, an error message will appear on the display. To correct the problem, touch **CANCEL · SECURE** and wait approximately one minute, then close the door. When the door is properly closed, start the Green Clean process again.



The display shows the Green Clean cycle status:

- ◇ **Cleaning** indicates that Green Clean is in process.
- ◇ **Door is Locked** indicates that the door is latched.



8. After about 30 minutes the control panel will beep, indicating that the process is complete. Touch **CANCEL · SECURE** to clear the screen.

- ◇ Using a soapy sponge, wipe down the inside of the door window first. Then carefully sponge out the remaining water from the inside of the oven. Scrub the inside of the oven with the soapy sponge until grease and soil is removed from the surfaces inside. Lime deposits can be removed with a cloth soaked in vinegar.
- ◇ Make sure all surfaces are dry after cleaning by wiping down the oven with paper towels. Leave the door partially open to allow any left over condensation to escape.
- ◇ Repeat the process any time soil begins to build up inside.

Cleaning the Exterior

Control Panel

CAUTION

Do not use abrasive cleaners or scrubbers on the control panel. They will permanently damage the finish.

To avoid turning the oven on while cleaning the control panel, activate the lock-out feature. Touch and hold your finger on the **CANCEL · SECURE** key for five seconds. The keys will be disabled and **Locked** will appear on the display.



Clean the control panel with the soft side of a sponge dampened with a mild solution of detergent and warm water. Dry the control panel completely with a soft, lint-free cloth.

To re-activate the control panel, touch and hold your finger on the **CANCEL · SECURE** key for five seconds.

Care and Cleaning

Stainless Steel Surfaces

CAUTION

Always wipe stainless steel (silver colored) surfaces with the grain. To prevent scratching, do not use abrasive cleaners or scrubbers on stainless steel surfaces.

Using a soft cloth, clean metal surfaces with a mild solution of detergent and warm water. Rinse and dry with a soft, lint-free cloth.

Glass (Interior and Exterior)

Use a mild glass cleaner to remove finger prints on glass surfaces. You can also clean glass surfaces with Dacor Cooktop Cleaning Creme. Use it according to the directions on the package.

You may scrub the oven light lens with the rough side of a sponge and warm, soapy water. Be careful not to scratch the lens.

Cleaning the Interior

Convection Filter

WARNING

For your safety and proper oven performance, re-install the filter before using the oven to cook. If you don't, the spinning fan blades at the back of the oven will be exposed.

The convection filter is located in the back of the oven chamber. Clean the filter regularly. If you allow it to become clogged, the oven's convection cooking modes will not work properly. You also need to remove the filter during the self-clean cycle.

Removing your oven's convection filter...

When the oven is cool, put your fingers around the edges of the filter and gently push up.

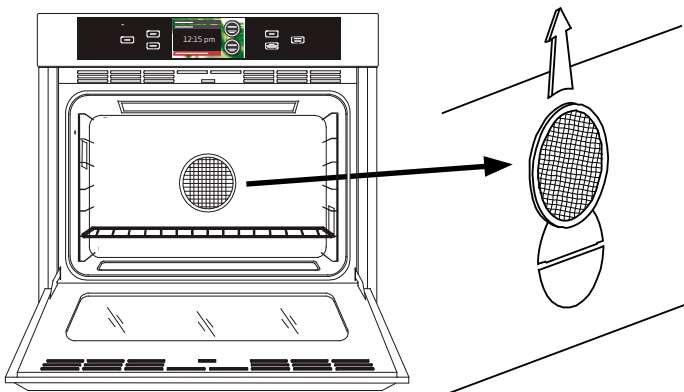

To clean the filter...

Soak it in hot, soapy water. Rinse well. You may also place it in a dishwasher on the top rack. Dry the filter before re-installing it.

Installing your oven's convection filter...

Carefully hook the metal clips on the back of the filter over the metal bar across the fan hole. Make sure it is centered over the hole. Be careful not to scratch the porcelain surfaces with the back of the filter.

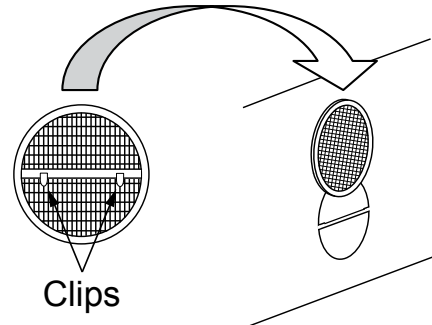

Door Gasket (Seal)

WARNING

Take extreme caution when cleaning the door gasket. Rubbing or displacing it may damage the tight door seal required for proper cooking and self-cleaning.

Clean the door gasket by dabbing it with a solution of water and mild soap. Do not scrub it or it will become damaged.

Oven Racks

CAUTION

To prevent damage, do not self-clean the oven racks.

To clean the oven racks, apply a solution of detergent and hot water. When you need to clean heavy soil, use a scouring pad such as steel wool with plenty of water. You may also use a solution of one cup of ammonia to two gallons of water.

Meat Probe

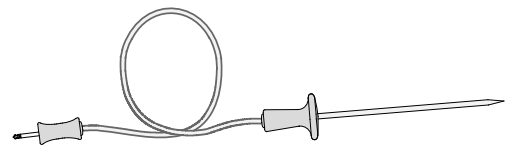

WARNING

- To prevent damage, do not immerse the meat probe in water.
- The meat probe will not function properly if the plug the connects to the oven is wet.

The meat probe is constructed of silicone handles, a wire, a plug and a stainless steel skewer. To clean the skewer, use a scouring pad and hot, soapy water. When you clean the handles, wipe them with a soft sponge soaked with a solution of detergent and warm water. Dry thoroughly.

Care and Cleaning

Broil Pan

Your broil pan has a porcelain enamel finish. When you clean it, use a solution of detergent and hot water. If your broil pan is heavily soiled, use a scouring pad with plenty of water. Rinse it well after cleaning.

Optional Roast/Broil Pan with "V" Shaped Rack

The roast/broil pan has a porcelain enamel finish. When you clean it, use a solution of detergent and hot water. If the roast/broil pan is heavily soiled, use a scouring pad and plenty of water. Rinse it well after cleaning.

The optional "V" shaped rack and grill are finished with an Excalibur nonstick coating. When you clean it, use a mild solution of detergent and warm water. Use the soft side of a sponge to scrub it and dry it with a lint-free cloth.

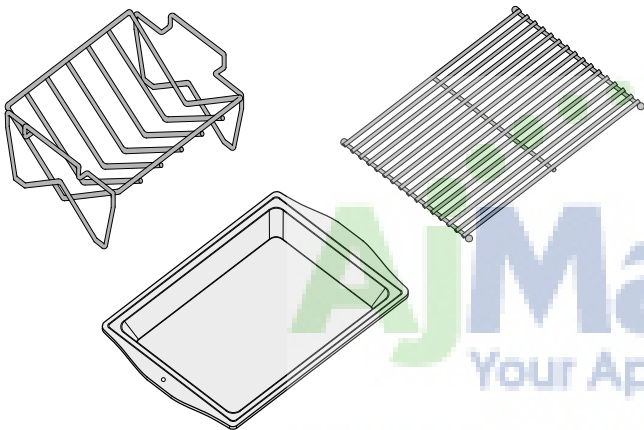

Optional Baking Stone

Wash the optional baking stone with hot water and scrub it clean before you use it for the first time. Do not use any soap or detergents to wash it. The stone is porous and soap will get trapped inside. The trapped soap will affect the flavor of the food cooked on it. Don't be alarmed if the stone gets stains on it after it is used for a while. Stains do not affect the stone's ability to bake properly.

When you need to remove large food particles from the baking stone, use warm water and a scrub brush. If there is a lot of oil build-up, it may smoke and create odors. If you need to remove the oily build up, use a scouring pad or brush to remove it. You may also use a paste of baking soda and water to scrub off small stains.

Optional Cookie Sheets

Clean the optional aluminum cookie sheets with a solution of detergent and warm water. Since aluminum can scratch, you need to use the soft side of a sponge. A way for you to keep cookie sheets cleaner is to use parchment paper over the cooking surface during baking. The parchment paper will also prevent food from sticking.

Replacing the Light Bulbs

WARNING

- To prevent electrical shock and/or personal injury, make certain that the oven and light bulbs are cool and that power to the oven has been turned off at the circuit breaker panel or fuse box before replacing the light bulbs.
- Always make sure the lens covers are in place when using the oven. The lens covers protect the light bulbs from breakage caused by high oven temperatures or mechanical shock.
- Replacing the lens cover without lining up the cutout with the light socket will damage the light fixture.
- Do not use a screwdriver to remove the lens.

Light bulb replacement is considered to be a homeowner maintenance operation. If the lights do not work, before replacing them, please consult the **Problem Solution Guide** on page 41.

IMPORTANT

Do not touch the replacement halogen light bulbs with your fingers. Halogen bulbs are sensitive to the oils from your hand. The oils from your hand will stick to the bulb and cause it to burn out faster than normal.

To replace the light bulbs...

1. Replace the light bulb only with Dacor part number 100429. See page 35 for ordering information.
2. Turn off power to the oven at the circuit breaker panel or fuse box.
3. Hold your hand under the lens for support and gently pry it loose using a spatula or table knife. Pull the lens cover straight out.

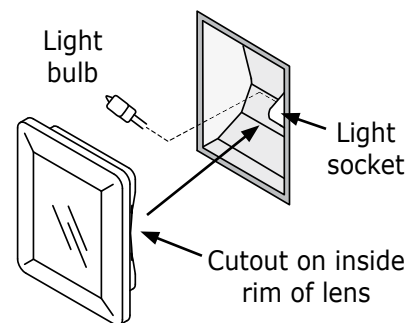

4. Grasp the old bulb and pull it straight out of the socket.
5. Using a glove, insert the new bulb into the socket.
6. As you reinstall the lens cover, line up the cutout on the inside rim with the light socket. Gently press it into its original position.
7. Turn the power to the oven back on at the circuit breaker panel or fuse box.

Before You Call for Service

Problem Solution Guide

NOTE: See **Common Problems When Using the Bake Mode** on page 15 for problems with cooking food.

Problem	May Be Caused By	What to Do
Nothing works. Control panel is not lit.	Oven not connected to electrical power.	Have a licensed electrician connect the oven to properly wired electrical connection.
	Power to oven is off.	Turn on power at circuit breaker or fuse box. Check for tripped breaker or blown fuse.
	Power outage.	Contact power company.
Nothing works/control panel does not respond. Control panel is lit.	Control panel locked (Locked appears on display).	Touch CANCEL • SECURE key for 5 seconds to reactivate control panel.
	Oven's computer needs to be restarted.	Touch HOME and BACK keys for 5 seconds to restart computer.
Control panel dim or only time and date is shown.	Oven in "sleep" mode.	Energy saving mode activated. See page 7 to change settings or touch display to reactivate.
Normal screen is missing from display.	Android operating system is showing.	Touch Dacor Cooking or HOME to return to oven home screen.
Oven will not heat.	Oven setting not correct.	Touch CANCEL • SECURE , then follow instructions in Operating Your Oven section.
	Oven set for delay start.	Oven will turn on automatically at the preset time. Touch CANCEL • SECURE to return to normal operation.
	Attempting to broil with the meat probe connected.	Broil modes will not work when meat probe is connected. Disconnect meat probe.
Oven does not self-clean/green clean.	Oven door not shut tightly.	Check for obstructions. Shut door tightly.
	Oven not set properly.	Follow instructions in Care and Cleaning section.
	Meat probe connected.	Oven will not start Self Clean cycle when meat probe is connected. Disconnect and remove meat probe.
Oven door will not open.	Oven is set to self clean.	Check display. If Locked symbol appears on display, oven door cannot be opened. Wait for oven to complete self-clean or touch CANCEL • SECURE . Door will unlock once oven has cooled.
Oven lights will not work.	Oven in Self Clean mode.	Lights do not work when oven is in Self Clean mode. See page 36.
	Oven in Sabbath mode.	Lights do not work when oven is in Sabbath mode. See page 31.
	Light bulbs burned out.	Replace light bulbs.
Oven lights will not turn off.	Light key is set to on.	Touch light key to turn lights off.
	Door ajar.	Make sure the door is completely shut.

Before You Call for Service

Problem Solution Guide - (cont.)

Problem	May Be Caused By	What to Do
Sabbath mode does not work.	Meat probe connected.	Oven will not start Sabbath mode when meat probe is connected. Disconnect and remove meat probe.
Oven goes into Keep Warm mode too quickly after meat probe is connected.	Meat probe connector is still wet after cleaning.	Dry the metal portion of the plug that connects to the oven using a soft dry rag.
Cooling fan continues to run after oven has been turned off.	Normal operation.	The cooling fan may run for a while after the oven is turned off, until the internal parts have cooled.
Time on display not correct.	Clock not set to automatic or WiFi internet service not available.	See Clock/Date Settings on page 6.
Control panel does not "beep" when touching the keys on the control panel and when the timer runs down to zero.	Control panel tones disabled.	Enable control panel tones. See Oven Tone Settings on page 7.
No sound(s).	Volume turned down.	Adjust volume controls. See Oven Tone Settings on page 7.
Normal screen is missing from display.	Android operating system is showing.	Touch "Dacor Cooking" or touch HOME key to return to <i>oven</i> home screen.
Timers do not work.	Oven set to Sabbath mode	Normal operation. Timers are not operational when oven is in Sabbath mode.
Timers will not stop.	Using CANCEL - SECURE to turn off timers.	The timers cannot be canceled by using this keys. See page 18 for proper operation.
Foods over or under cook.	Incorrect cooking time or temperature.	Follow instructions in Operating Your Oven section.
Cannot connect to WiFi, network.	Wifi network turned off.	Check to make sure you can connect to the WiFi router with another wireless device, at close range. If you cannot connect, check to make sure that the router is on and working properly.
	Weak signal.	Check to make sure Wifi network is within range of oven. Access Wifi settings as instructed on page 33. If the WiFi system does not appear on the settings menu or has a weak signal, move the Wifi router close to the oven to see if the signal improves. If not, call for service.
Wifi connection intermittent.	See weak signal, above.	

Warranty and Service

Getting Help

Before you request service:

1. Review the **Before You Call for Service** section of this manual (see page 41).
2. Use the helpful tips found in our **Problem Solution Guide**.
3. Become familiar with the warranty terms and conditions of your product.
4. If none of these tips or suggestions resolves your problem, call our Customer Service Center at the number below.

Dacor's Customer Service Center is available 6:00 A.M. – 5:00 P.M. Pacific Time

For warranty repairs or questions and for Dacor Distinctive Service (DDS) in the US and Canada
Phone: (800) 793-0093, extension 2822

For non-warranty repairs or questions in the US and Canada
Phone: (800) 793-0093, extension 2813

Contact us through our web site at:

www.dacor.com/contact-us

Warranty

What Is Covered

CERTIFICATE OF WARRANTIES: DACOR OVENS

WITHIN THE FIFTY STATES OF THE U.S.A., THE DISTRICT OF COLUMBIA, AND CANADA:

FULL ONE-YEAR WARRANTY

The warranty applies only to the Dacor appliance sold to the first use purchaser, starting from the date of original retail purchase or closing date for new construction, whichever period is longer. Warranty is valid on products purchased brand new from a Dacor Authorized Dealer, or other seller authorized by Dacor.

If your Dacor product fails to function within one year of the original date of purchase, due to a defect in material or workmanship, Dacor will remedy it without charge to you.

All cosmetic damage (such as scratches on stainless steel, paint/porcelain blemishes, etc.) to the product or included accessories must be reported to Dacor within 60 days of the original purchase date to qualify for warranty coverage. Consumable parts such as filters and light bulbs are not covered and are the responsibility of the purchaser.

LIMITATIONS OF COVERAGE

Service will be provided by a Dacor designated service company during regular business hours. Please note service providers are independent entities and are not agents of Dacor.

Dealer display and model home display products with a production date greater than 5 years, products sold "As Is," and products installed for non-residential use, which include but are not limited to religious organizations, fire stations, bed & breakfast, and spas carry a one year parts warranty only. All delivery, installation, labor costs, and other service fees are the responsibility of the purchaser.

Warranty will be null and void on product that has altered, defaced, or missing serial numbers and tags.

The owner must provide proof of purchase or closing statement for new construction upon request. All Dacor products must be accessible for service.

Warranty is null and void if non-ETL or non-CUL approved product is transported from the U.S.A.

OUTSIDE THE FIFTY STATES OF THE U.S.A., THE DISTRICT OF COLUMBIA, AND CANADA:

LIMITED FIRST YEAR WARRANTY

If your Dacor product fails to function within one year of the original date of purchase due to a defect in material or workmanship, Dacor will furnish a new part, F.O.B. factory to replace the defective part.

All delivery, installation, labor costs and other service fees are the responsibility of the purchaser.

continued...

Warranty and Service

Warranty (cont.)

What Is Not Covered

- Slight color variations may be noticed because of differences in painted parts, kitchen lighting, product placement, and other factors; this warranty does not apply to color variation.
- Service calls to educate the customer on proper use and care of the product.
- Service fees for travel to islands and remote areas, which include but are not limited to, ferries, toll roads or other travel expenses.
- Consequential or incidental damage, including but not limited to food or medicine loss, time away from work or restaurant meals.
- Failure of the product when used for commercial, business, rental or any application other than for residential consumer use.
- Failure of the product caused by improper product installation.
- Replacement of house fuses, fuse boxes or resetting of circuit breakers.
- Damage to the product caused by accident, fire, flood, power interruption, power surges or other acts of God.
- Liability or responsibility for damage to surrounding property including cabinetry, floors, ceilings and other structures or objects around the product.
- Breakage, discoloration, or damage to glass, metal surfaces, plastic components, trim, paint or other cosmetic finish caused by improper usage, care, abuse or neglect.

Out of Warranty

Should you experience a service issue beyond the standard warranty period, please contact us. Dacor reviews each issue and customer concern to provide the best possible solution based on the circumstances.

THE REMEDIES PROVIDED IN THE ABOVE EXPRESS WARRANTIES ARE THE SOLE AND EXCLUSIVE REMEDIES. THEREFORE, NO OTHER EXPRESS WARRANTIES ARE MADE, AND OUTSIDE THE FIFTY STATES OF THE UNITED STATES, THE DISTRICT OF COLUMBIA AND CANADA, ALL IMPLIED WARRANTIES, INCLUDING BUT NOT LIMITED TO, ANY IMPLIED WARRANTY OF MERCHANTABILITY OR FITNESS FOR A PARTICULAR USE OR PURPOSE, ARE LIMITED IN DURATION TO ONE YEAR FROM THE DATE OF ORIGINAL PURCHASE. IN NO EVENT SHALL DACOR BE LIABLE FOR INCIDENTAL EXPENSE OR CONSEQUENTIAL DAMAGES. IN THE EVENT DACOR PREVAILS IN ANY LAWSUIT, DACOR SHALL BE ENTITLED TO REIMBURSEMENT OF ALL COSTS AND EXPENSES, INCLUDING ATTORNEY'S FEES, FROM THE DACOR CUSTOMER. NO WARRANTIES, EXPRESS OR IMPLIED, ARE MADE TO ANY BUYER FOR RESALE.

Some states do not allow limitations on how long an implied warranty lasts, or do not allow the exclusion or limitation of inconsequential damages, therefore the above limitations or exclusions may not apply to you. This warranty gives you specific legal rights, and you may also have other rights that vary from state to state.

800-570-3355





Dacor.com

Part No. 107601 Rev. B