



treos®

ERLEBE DAS BAD

WIR ENTWICKELN. WIR KREIEREN. WIR INSPIRIEREN



Tauchen Sie ein in die
Produktvielfalt des treos®-Sortiments.
In dieser Broschüre finden Sie eine großzügige
Auswahl unserer besonderen Produkte. Aussagekräftig und
neugierig machend. Die Bandbreite des gesamten Sortiments können Sie
jederzeit auf unserer Internetpräsenz www.treos.de und im interaktiven
Produktordner entdecken. Lassen Sie sich begeistern!

treos® ist ein inhabergeführtes, stetig wachsendes Unternehmen mit
Hauptsitz in Düsseldorf. Es steht seit vielen Jahren für elegante, progressive
Funktionalität, hochwertige Verarbeitung und neuestes Design. Erleben Sie
wie einfach und komfortabel, puristisch und individuell, entspannend oder
auch aufregend treos® ist. Die treos®-Komplexität birgt Vielfalt und Details.

□ BADARMATUREN	SEITE 02
▪ ARMATUREN	SEITE 04
▪ DUSCHSYSTEME	SEITE 07
▪ REGENPANEELE	SEITE 08
▪ BRAUSEN	SEITE 08
▪ ZUBEHÖR	SEITE 10
□ ACCESSOIRES	SEITE 12
□ BADSPIEGEL	SEITE 16
▪ SPIEGEL	SEITE 18
▪ SPIEGELSCHRÄNKE	SEITE 19
□ MINERALGUSS	SEITE 20
▪ WASCHBECKEN	SEITE 22
▪ BADEWANNEN	SEITE 25
▪ DUSCHTASSEN	SEITE 26
□ KERAMIK	SEITE 28
▪ WASCHBECKEN	SEITE 30
▪ WCS	SEITE 30
□ BADMÖBEL	SEITE 32
□ KÜCHE	SEITE 42



BADARMATUREN

- ARMATUREN
- DUSCHSYSTEME
- REGENPANEELE
- BRAUSEN
- ZUBEHÖR

Hochwertige, puristisch anmutende Badarmaturen, Duschsysteme mit oder ohne Regenbrause, sowie verwöhnende Regenpaneele generieren sinnliche und entspannte Wohlfühlmomente. Bedienkomfort und Funktionalität für höchste Ansprüche. Nicht nur die Silhouette überzeugt.



ARMATUREN

WASCHTISCHARMATUREN — □



173.01.1000



173.01.1030



173.01.10302



175.01.1030



176.01.1000



190.01.1000



191.01.1000



193.01.1000



195.01.1030



197.01.1000



197.01.1030



198.01.1000



199.01.1000



173.01.1700



176.01.1700



190.01.1700



190.01.17002



191.01.1700



193.01.1700



195.01.1730



197.01.1700



198.01.1700



199.01.1700



175.01.1500



176.01.1500



191.01.1500



195.01.1500



195.01.15002

WASCHTISCH
2-LOCH



175.01.1800



190.01.1815



193.01.1850



195.01.1815



195.01.1817



197.01.1850



199.01.1800

WANNE/BRAUSE
AUFPUTZ



173.01.1100



176.01.1100



190.01.1100



191.01.1100



193.01.1100



195.01.1100



197.01.1100



198.01.1100



199.01.1100

BRAUSE
AUFPUTZ



173.01.1200



175.01.1200



176.01.1200



190.01.1220



191.01.1200



193.01.1200



195.01.1200



197.01.1200



198.01.1200



199.01.1200

WANNE/BRAUSE
UNTERPUTZ



173.01.2106



176.01.2106



190.01.2106



191.01.2106



193.01.2106



195.01.2106

ARMATUREN



197.01.2106



198.01.2106



199.01.2106

BRAUSE
UNTERPUTZ



173.01.2246



176.01.2246



190.01.2246



191.01.2246



193.01.2246



195.01.2246



197.01.2246



198.01.2246



199.01.2246

WANNE
4-LOCH



175.01.2400



190.01.2400



193.01.2400



197.01.2400



175.01.1160



190.01.1160



193.01.1160



195.01.1160



198.01.1160



198.01.2400

WANNE
FREISTEHEND

DUSCHSYSTEME | THERMOSTAT



173.01.2720



173.01.2726



176.01.2720



190.01.2722



191.01.2720



195.01.2724



195.01.27262

DUSCHSYSTEME | EINHEBELMISCHER



175.01.2762



190.01.2762



195.01.2764



198.01.2762



199.01.2760

ARMATUREN

DUSCHSYSTEME | OHNE ARMATUR — □



175.01.2772



190.01.2772



193.01.2772



195.01.2774

REGENPANEELLE — □



930.01.3434



930.01.34342



930.01.4444



930.01.44442



930.01.5555

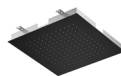

930.01.55552

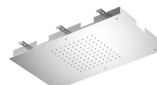

930.01.7040

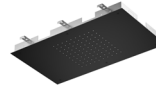

930.01.70402



930.01.7041

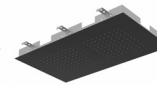

930.01.70412

BRAUSEN — □



173.01.1687



190.01.1681



190.01.1686



191.01.1687



199.01.1687

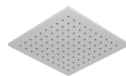

175.01.1686

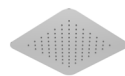

175.01.1682

BRAUSE
ANSCHLUSS



175.01.1670



190.01.1670

BRAUSEN MIT BRAUSESTANGE □



193.01.1670



195.01.1670



195.01.1672



199.01.1670

BRAUSE
WANDHALTER



173.01.1650



175.01.1650



190.01.1626



190.01.1650



191.01.1650



193.01.1650



195.01.1650



195.01.1652



199.01.1650



173.01.1602



175.01.1602



190.01.1601



190.01.1622



193.01.1601



195.01.1602



195.01.1604



199.01.1600

ARMATUREN

ZUBEHÖR — □



190.01.7900



175.01.7900



190.01.1571



175.01.1571



190.01.4400



175.01.4400



190.01.1660



175.01.1660



190.01.1640



175.01.1640



191.01.1690



191.01.16902



190.01.1696



190.01.16962



190.01.9510

WIR ENTWICKELN.

Wenn das Kreativ-Team von treos® neue Produkte entwickelt, werden Ideen, Skizzen, Marktbeobachtungen sowie Kundenwünsche zusammengeführt und analysiert.

Vorausschauend und innovativ, stets inspiriert von den neuesten Trends. Oft werden Farben und Formen neu interpretiert. Wir konzipieren einzigartige Produkte, wie diese Waschtisch-armatur (198.01.1000).

Wir hinterfragen: Passt die klare Formensprache zur Funktionalität, die Reduktion auf das Wesentliche zur Ästhetik, ist es neuartig und individuell?

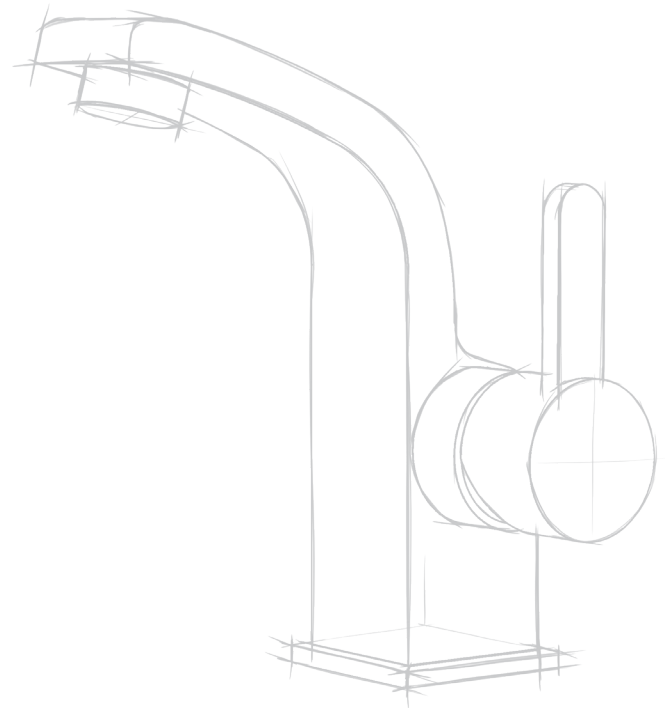



ACCESSOIRES

Die stilvollen Accessoires bringen Ordnung und Struktur ins Bad. Passend zu den treos®-Badmöbeln, -Spiegeln und -Armaturen. Gezielt platziert, verleihen sie dem Bad einen ganz besonderen Charme. Einzelne oder im Set – nicht nur optisch ein Hingucker.



ACCESSOIRES

SERIE 505



505.02.2400



505.02.8000



505.02.2550



505.02.2610



505.02.2500



505.02.2560



505.02.25602

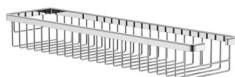

505.02.2301



505.02.2800



505.02.2900

SERIE 555



555.02.2400



555.02.8000



555.02.2550



555.02.2610



555.02.2500



555.02.2560



555.02.25602

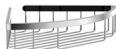

555.02.2301



555.02.2801



555.02.2800



555.02.2900

WIR KREIEREN.

Das CAD- & CGI-Team von treos® setzt jede neue Idee in 3D um. Aus den Skizzen, dem Layout, der Konstruktion und den Materialvorstellungen entsteht unser Wunschprototyp. Maßstabsgetreu und so realistisch wie möglich. In enger Absprache mit der Produktion. So wie bei dem Seifenspender (505.02.8000). Jedes der neuen Muster wird virtuell, in unterschiedlichen Darstellungen, mit Produkten aus dem treos®-Sortiment abgebildet. Passt der neue Artikel in unser Portfolio? Die Kombinationsfähigkeit soll und muss gewährleistet sein. treos®-Kunden wissen dies zu schätzen.

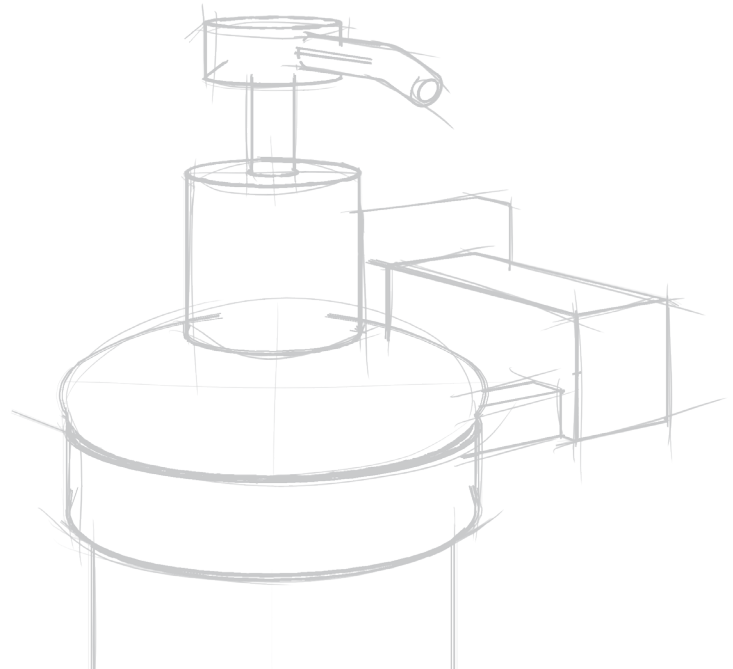



BADSPIEGEL

- SPIEGEL
- SPIEGELSCHRÄNKE

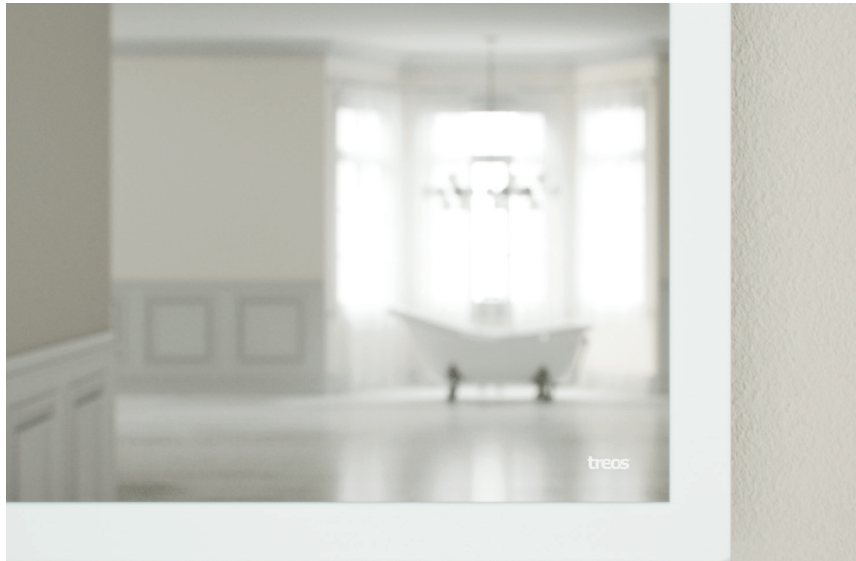

Sie verschönern jedes Bad. Die exklusive Auswahl der treos®-Spiegel überzeugt durch die Größen- und Formenvielfalt. Stücke mit gleichmäßiger Ambiente-LED-Beleuchtung oder mit integriertem, beleuchtetem Kosmetikspiegel setzen besondere Highlights.

BADSPIEGEL

SERIE 600 — □



600.06.6070



600.06.8070



600.06.7100



600.06.7125

SERIE 605 — □



605.06.0600



605.06.0750



606.06.0700



606.06.1000

SERIE 610 — □



610.06.4560



610.06.6060



610.06.8060



610.06.8100

SERIE 614 — □



610.06.8120



614.06.7050



614.06.8060



614.06.8080



614.06.8100



614.06.8120

SERIE 620 □



620.06.6570



620.06.8070



620.06.8100



620.06.8120

SERIE 630 □



630.06.6070



630.06.7570



630.06.7100



630.06.7125

SPIEGELSCHRÄNKE | SERIE 500 □



500.06.6074



500.06.60742



500.06.7074



500.06.70742



500.06.1074



500.06.10742



500.06.1274



500.06.12742



MINERALGUSS

- WASCHBECKEN
- BADEWANNEN
- DUSCHTASSEN



Faszinierende Waschbecken, Duschtassen und Wannen – gegossen aus einem Stück. Die angenehme, fugenfreie Oberfläche ist rutschhemmend, wärmespeichernd, strapazierfähig und absorbiert die Lautstärke.

MINERALGUSS

WASCHBECKEN — □



710.04.4021



710.04.4022



700.04.4628



710.04.4236



720.04.4535



710.04.5036



710.04.5045



711.04.5045



730.04.5045



710.04.6045



711.04.6045



720.04.6046



710.04.7042

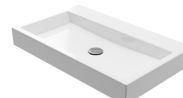

711.04.7042



710.04.1004



712.04.1004

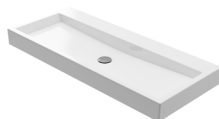

711.04.1004



710.04.0412



710.04.0426



730.04.0415



730.04.0400



730.04.4035



735.04.4035



730.04.5035



735.04.5035



710.04.0430



710.04.4040



700.04.5435



730.04.4632



710.04.4538



710.04.5040



710.04.5931



710.04.5130



713.04.5130



714.04.5130



715.04.5130



716.04.5130



717.04.5130



718.04.5130



710.04.5632



713.04.5632



714.04.5632



715.04.5632



716.04.5632



717.04.5632



718.04.5632



710.04.4939



713.04.4939



714.04.4939



715.04.4939



716.04.4939



717.04.4939



718.04.4939



730.04.6036



733.04.6036



734.04.6036



735.04.6036



736.04.6036



737.04.6036



738.04.6036



750.04.0400



750.04.0460

MINERALGUSS



750.04.5036



750.04.3737



750.04.5026



750.04.5536



750.04.5040



750.04.6050



750.04.7050



750.04.8050



755.04.9005



750.04.9052



750.04.9050



750.04.9055



750.04.1252



750.04.1250



750.04.1255



750.04.1550



750.04.1555



750.04.2250



750.04.2450

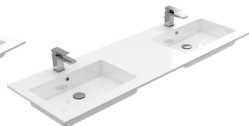

750.04.2550



700.04.6060



730.04.5145



710.04.4050



710.04.4500



700.04.1785



703.04.1785



730.04.1780



733.04.1780



710.04.1770



710.04.1561



710.04.1570



700.04.1572



710.04.1660



710.04.1661



710.04.1672



710.1678



715.1678



710.04.1772



710.04.1586

MINERALGUSS

DUSCHTASSEN — □



780.04.8080



780.04.9090



780.04.1010



780.04.8010

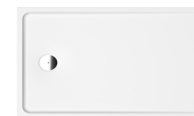

780.04.8012

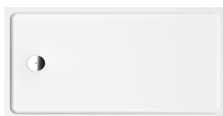

780.04.8014

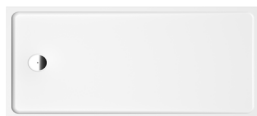

780.04.8016

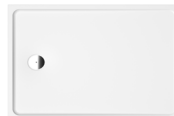

780.04.9012

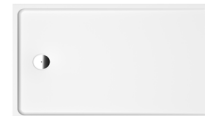

780.04.9014



780.04.9016



795.04.8080



795.04.9090



795.04.1010



795.04.8010



795.04.8012

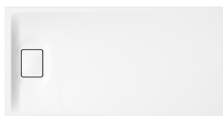

795.04.8014

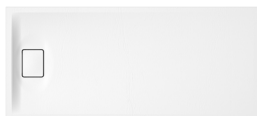

795.04.8016



795.04.9012

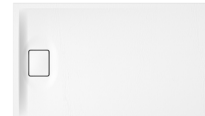

795.04.9014

WIR REALISIEREN.

Wird entschieden ein neues Produkt in das Sortiment aufzunehmen, werden die Daten an die Produktion weitergeleitet. In enger Absprache und ständigem Dialog werden Machbarkeit, Funktionalität sowie Ergonomie geprüft und alle Informationen ausgetauscht. Es entstehen mehrere Muster, praktikabel und nah an der Idee. So auch bei dem Mineralguss-Aufsatzwaschbecken (715.04.5632). Passen Preis- und Leistungs-Verhältnis, Spezifikationen und Anspruch zusammen, dann wird aus einem Muster ein neues treos®-Produkt. Die stete Kontrolle während der Herstellung und des

Produktionsvorganges, stellt die gleichbleibende, hervorragende treos®-Qualität sicher. Deutsches Know-how.

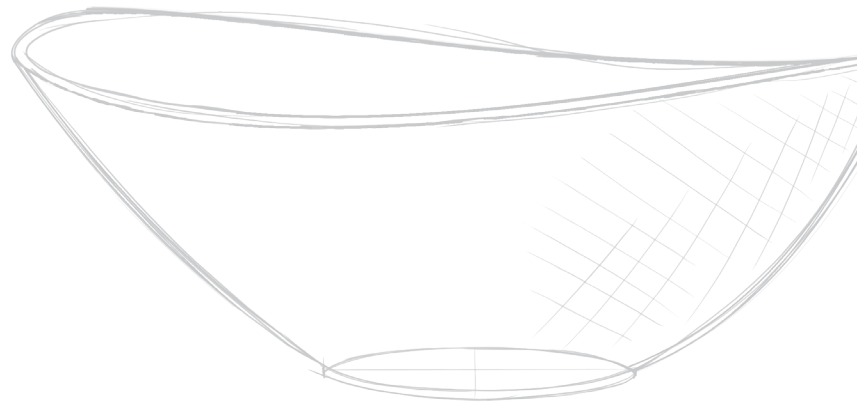



KERAMIK

- WASCHBECKEN
- WCs

Moderne Keramik-Aufsatzwaschbecken und Waschbecken für die Wandmontage. Rund, oval oder eckig. Wandhängende Tiefspül-WCs mit offenem Spülrand, welche mit passendem WC-Sitz mit Absenkautomatik ergänzt werden können.



KERAMIK

WASCHBECKEN — □



800.03.0400



800.03.0430



800.03.4531



800.03.4040



800.03.5035



800.03.4020



800.03.4530



800.03.4631



800.03.6047

WCS — □



800.03.2000



810.03.2000



810.03.2001



800.03.2080



810.03.2080



810.03.2081

WIR VERMARKTEN.

Die Entscheidung für ein neues Produkt ist gefallen. Die Vorlaufzeit, welche für dessen Produktion benötigt wird, nutzt unser dynamisches Media- & Marketing-Team für die neue Vermarktungsstrategie. Alle Kampagnen, ob Social Media, Digital- / Druckmedien oder auf der treos®-Website, werden sofort auf den neuen Artikel zugeschnitten. Gleichzeitig und innerhalb kürzester Zeit.

Auch das Keramik-Tiefspül-WC (800.03.2000) kam so aus dem Hause treos® auf den Markt. Progressiv, bahnbrechend und umgehend für den Kunden erhältlich.

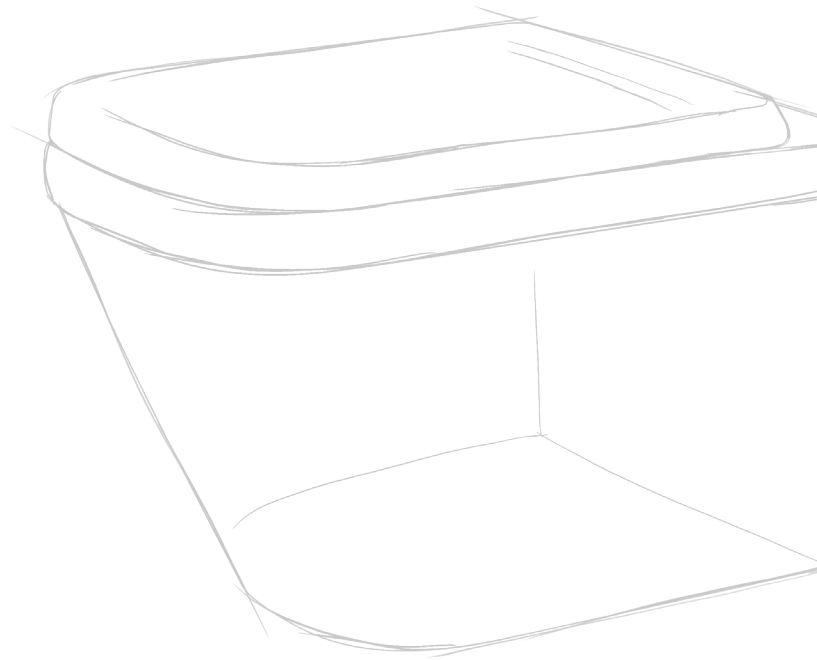



BADMÖBEL



Waschtischunterschranke und Wandschränke mit Softclose-System (blum® Auszugssystem) oder Tip-Open-Technik für sanftes Öffnen und gedämpftes Schließen. Konsolenplatten konzipiert für passende Aufsatzbecken. Klare Formensprache, vielfältige Varianten, moderne Funktionalität und Hochwertigkeit.

BADMÖBEL

Farbkarte | uni

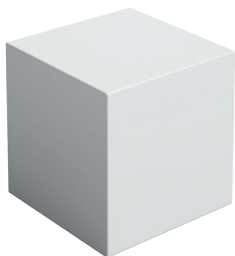

weiß,
hochglänzend

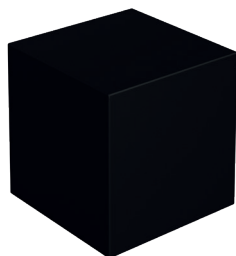

schwarz,
seidenmatt

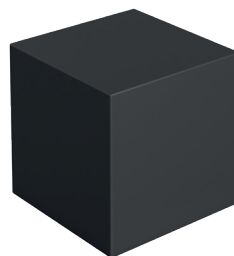

graphit-grau,
hochglänzend

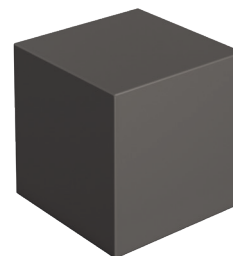

cappuccino-braun
hochglänzend

Farbkarte | Holz



Holz,
F. Oak



Holz,
S. Oak



Holz,
D. Oak

Stauraum in seiner schönsten Farbe & Form. treos® Badmöbel bieten nicht nur jede Menge Stauraum, sondern bringen all die kleinen und großen Dinge, die sich im Bad finden, auch auf äußerst elegante Weise noch unter. Durch die wählbaren Oberflächen werden die modernen Schränke entweder zum gezielten Hingucker im Bad oder nehmen sich bewusst zurück. Perfekt kombiniert, kommen die verschieden großen Unterschränke, mit einem zum Beispiel passenden Mineralguss-Waschtischbecken in glänzendem Weiß, daher. Hiermit bieten wir Ihnen die Individualität, welche Sie bevorzugen und/oder Ihre Räumlichkeit vorgibt. Lassen Sie sich inspirieren!

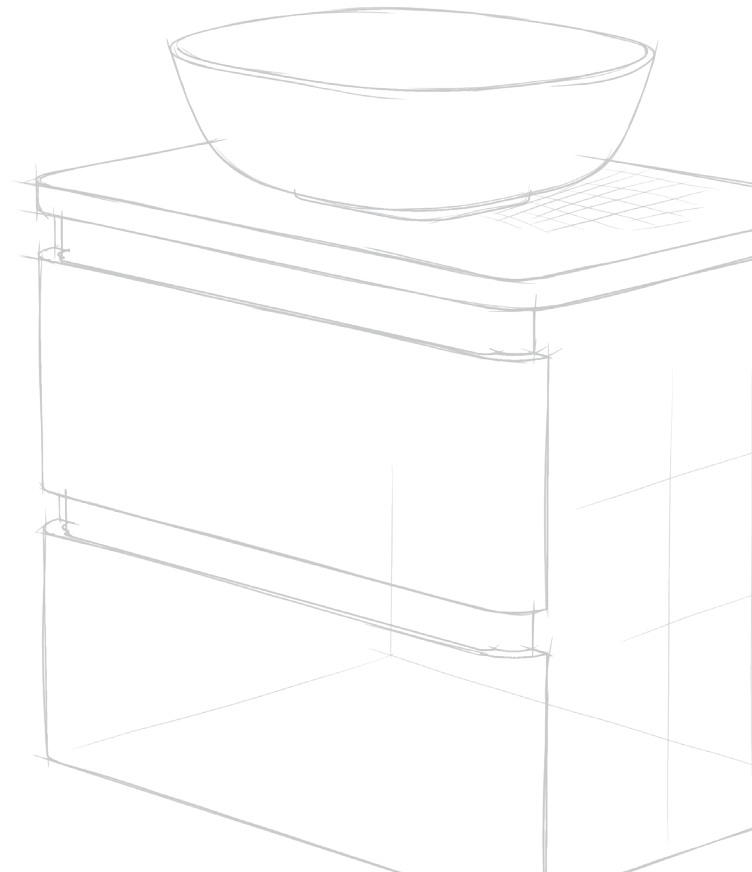

BADMÖBEL

SERIE 900 / 901 / 902 — □



- 900.05.0402
- 900.05.0406
- 900.05.0407
- 900.05.0408



- 900.05.0582
- 900.05.0586
- 900.05.0587
- 900.05.0588



- 901.05.0582
- 901.05.0586
- 901.05.0587
- 901.05.0588



- 901.05.0582
- 901.05.0586
- 901.05.0587
- 901.05.0588



- 901.05.0732
- 901.05.0736
- 901.05.0737
- 901.05.0738



- 900.05.1002
- 900.05.1006
- 900.05.1007
- 900.05.1008



- 901.05.1002
- 901.05.1006
- 901.05.1007
- 901.05.1008



- 900.05.1252
- 900.05.1256
- 900.05.1257
- 900.05.1258



- 901.05.1252
- 901.05.1256
- 901.05.1257
- 901.05.1258



- 902.05.1252
- 902.05.1256
- 902.05.1257
- 902.05.1258

SERIE 905 / 906



- 900.05.1272
- 900.05.1276
- 900.05.1277
- 900.05.1278



- 900.05.1262
- 900.05.1266
- 900.05.1267
- 900.05.1268

SERIE 905 / 906



905.05.0602



905.05.0604



906.05.0602



906.05.0604



905.05.0902



905.05.0904



906.05.0902



906.05.0904



905.05.0994



905.05.0992



906.05.0992



906.05.0994

BADMÖBEL

SERIE 910 / 911 / 912 — □



910.05.0422



910.05.0532



910.05.0702



911.05.0702



910.05.1002



911.05.1002



912.05.1002



910.05.1462



910.05.1412

SERIE 915 — □



915.05.5042



915.05.7042



915.05.9032



915.05.9042



915.05.9052



915.05.1232



915.05.1242



915.05.1252



915.05.2252



915.05.1462

SERIE 920 / 921 □



- 920.05.0602
- 920.05.0606
- 920.05.0607
- 920.05.0608



- 921.05.0602
- 921.05.0606
- 921.05.0607
- 921.05.0608



- 920.05.0902
- 920.05.0906
- 920.05.0907
- 920.05.0908



- 921.05.0902
- 921.05.0906
- 921.05.0907
- 921.05.0908



- 920.05.1202
- 920.05.1206
- 920.05.1207
- 920.05.1208



- 921.05.1202
- 921.05.1206
- 921.05.1207
- 921.05.1208



- 920.05.0652
- 920.05.0656
- 920.05.0657
- 920.05.0658



- 921.05.0652
- 921.05.0656
- 921.05.0657
- 921.05.0658

BADMÖBEL



- 920.05.1262
- 920.05.1266
- 920.05.1267
- 920.05.1268



- 920.05.1362
- 920.05.1366
- 920.05.1367
- 920.05.1368

SERIE 925 □



925.05.06013



925.05.09013



950.05.06013



950.05.09013

SERIE 950 □



- 950.05.0552
- 950.05.0554
- 950.05.05510
- 950.05.05511



- 950.05.0752
- 950.05.0754
- 950.05.07510
- 950.05.07511



- 950.05.1002
- 950.05.1004
- 950.05.10010
- 950.05.10011



- 950.05.1252
- 950.05.1254
- 950.05.12510
- 950.05.12511



- 950.05.1602
- 950.05.1604
- 950.05.16010
- 950.05.16011



950.05.2055



950.05.20552



- 955.05.0122
- 955.05.0124
- 955.05.01210
- 955.05.01211



066.07.7042



066.07.1042

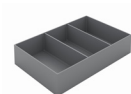

066.07.1111



066.07.1112

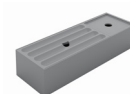

066.07.1113



062.07.0972



062.07.0974



062.07.0982



062.07.0984



062.07.5552



KÜCHE

Spültischarmaturen, die persönliche Akzente in der Küche setzen. In Chrom oder in kratzbeständiger Edelstahloptik – puristisch oder klassisch. Mehr Bewegungsfreiheit dank dem optimierten und schwenkbaren Auslauf.



KÜCHE

SPÜLSCHÄRMATUREN — □



175.01.1400



190.01.1400



190.01.1401



190.01.1402



190.01.1403



190.01.1404



193.01.1400



195.01.1400



197.01.1400



199.01.1400

WIR INSPIRIEREN.

Mit Werbekampagnen wird jeder neue Artikel, wie z. B. die Spültischarmatur (199.01.1400), den Kunden und Entscheidern näher gebracht. Neben Produktvorstellungen, Social Media Präsenz und Broschüren, bereitet treos® auf der Website (www.treos.de) eine virtuelle Welt für Kunden vor. Hier wird man demnächst verschiedene Beispiele finden, wie man ein Produkt mit dem treos®-Sortiment kombinieren könnte. Immer individuell, zeitgemäß und inspirierend. Digitalisierung wird bei treos® verstärkt vorangetrieben. Ihre Zufriedenheit ist unser Ansporn und unser Wunsch.

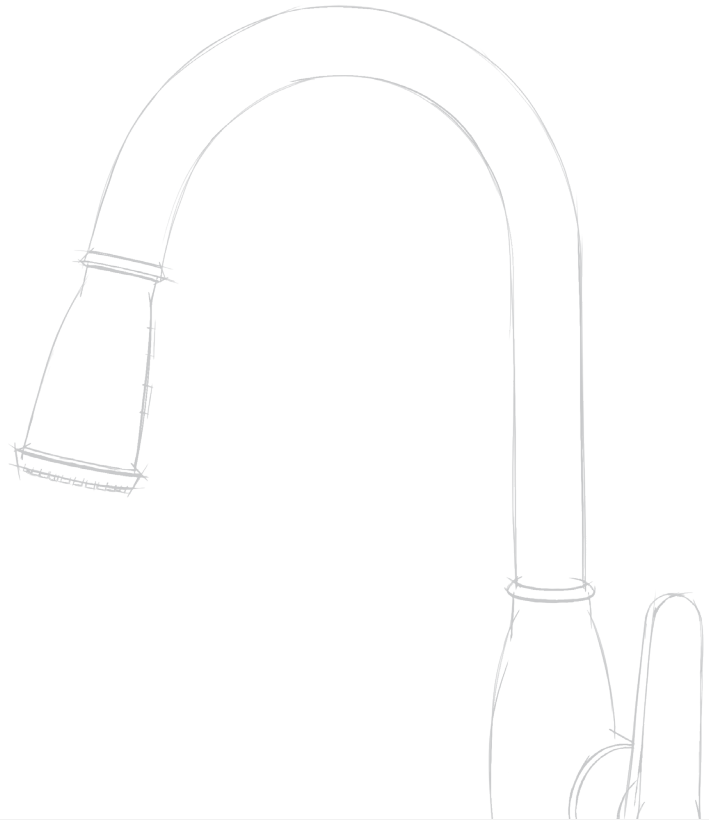

treos® GmbH
Heerdter Lohweg 216
40549 Düsseldorf

T.: +49 (0) 211 580904-0
F.: +49 (0) 211 580904-90
E-Mail: info@treos.de

www.treos.de

Verleger: treos® GmbH, Düsseldorf | Bildrechte: treos® GmbH · Layout, Satz & Herstellung: treos® GmbH, Düsseldorf
Modell-, Programm- und technische Modifikationen, sowie Irrtümer und Druckfehler vorbehalten. Die Artikel sind nicht maßstabsgetreu abgebildet. Die Farbe kann drucktechnisch bedingt von der Originalfarbe des Artikels abweichen. Bei den Produktdarstellungen und abgebildeten Milleubildern handelt es sich um Visualisierungen. Das Originalprodukt kann von der visualisierten Darstellung abweichen, die gezeigten Bilder dienen nur als Referenz.