

# EG4 Lifepower4 Rack Mounted 24V 200Ah

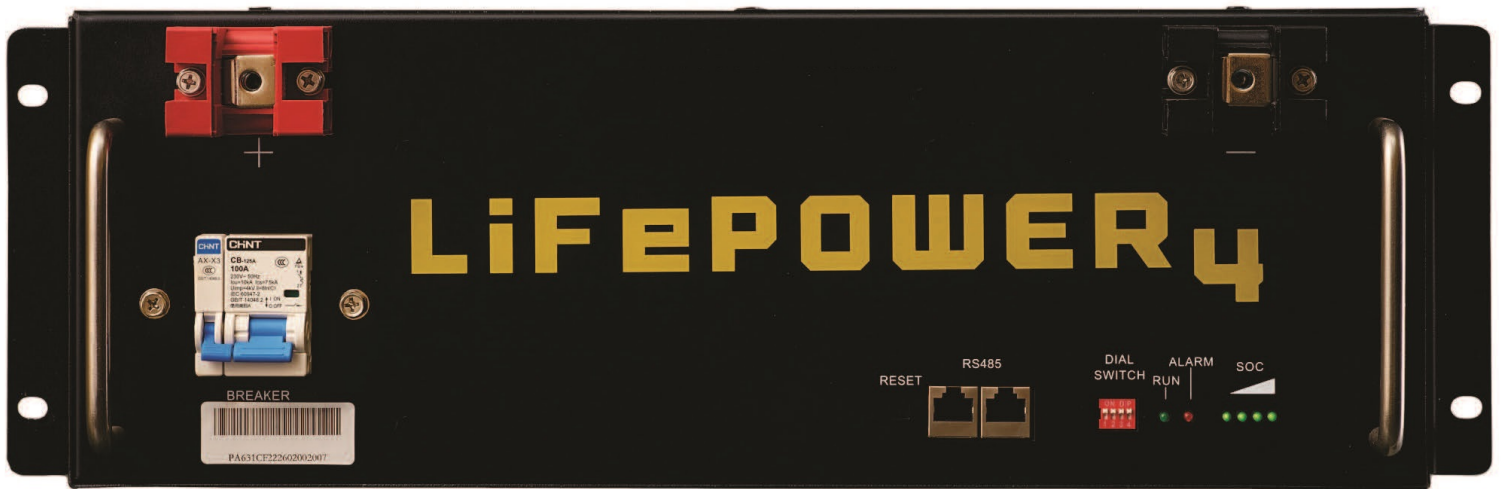

## User Manual

Version 2.3.3

Information subject to change without notice

# Table of Contents

<b>EG4 Lifepower4 Battery Diagram.....</b>	<b>1</b>
<b>About This Manual.....</b>	<b>2</b>
<b>Introduction.....</b>	<b>3</b>
<b>Overview.....</b>	<b>3</b>
<b>Installation.....</b>	<b>3</b>
<b>EG4 Battery Rack Interface.....</b>	<b>4</b>
<b>Charging.....</b>	<b>5</b>
<b>Introduction to the BMS.....</b>	<b>6</b>
<b>Battery Communications.....</b>	<b>7</b>
<b>PC Software.....</b>	<b>7</b>
<b>Battery Storage.....</b>	<b>16</b>
<b>Battery End of Life.....</b>	<b>17</b>
<b>Troubleshooting.....</b>	<b>17</b>
<b>Warranty.....</b>	<b>19</b>

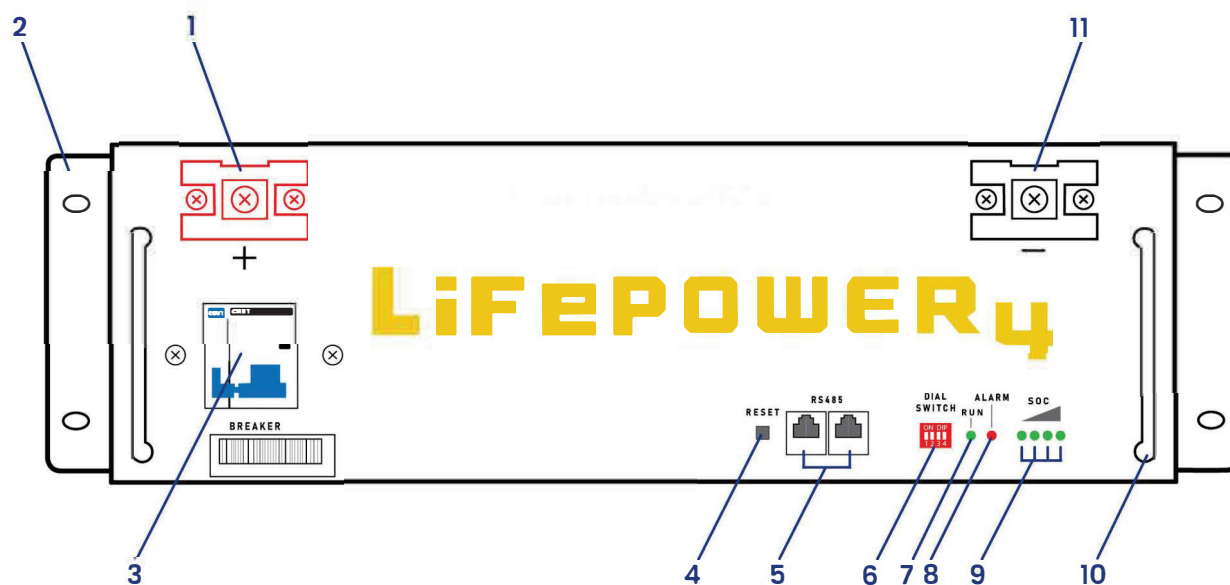

NO.	ITEM	DESCRIPTION	REMARKS
1	Positive terminal	Positive battery connection	M6 bolt
2	Rack mount ear	For battery pack mounting	
3	Breaker	Power output switch	
4	Reset	Emergency reset button	
5	RS485	Communication interface	Inverter/Battery communication
6	ID switches	Assigns unique battery address	DIP switch
7	RUN	Operation indication LED	Blinks when the system is on
8	Alarm	Alarm indication LED	
9	State of charge	SOC indication LED	
10	Handle	Handle for carrying	
11	Negative terminal	Negative battery connection	M6 bolt

# About This Manual

## Purpose

This manual describes installation, commissioning, operation, and troubleshooting. Please read the manual fully and carefully before installing and operating. Keep this manual for future use.

## Scope

This manual provides basic installation guidelines as well as information on tools and wiring.

# Safety Notice

**Attention: The following contains important safety and operating instructions. Read and keep this manual for future reference.**

## **DO NOT place LiFePower4 batteries in series.**

1. Before installing or using the unit read all instructions and cautionary markings on the unit and all appropriate sections of the manual.
2. CAUTION - Do not disassemble the unit. Take it to a qualified service center when service or repair is required. Incorrect re-assembly may result in a risk of electric shock or fire.
3. To reduce the risk of electric shock, shutdown and disconnect all wiring before attempting any maintenance or cleaning. Turning off the unit alone will not reduce the risk of shock or injury.
4. CAUTION - Only qualified personnel can install this equipment.
5. NEVER charge a battery below the specified minimum temperature; refer to the battery data sheet.
6. Wire size is critical for safe operation, and optimal performance of the equipment. Refer to an accredited sizing resource or cable manufacturer specifications to meet charge/discharge requirements.
7. Use caution when working with metal tools on or around all systems and batteries. Risk of electrical arcs and/or short circuiting of equipment can lead to severe injury and damage.
8. Strictly follow installation procedure when connecting/disconnecting DC terminals. Refer to the Installation section of this manual for details.
9. The included breaker is not a guarantee of battery protection. Size and install the correct overcurrent protection for conductors and battery if not included with the product.
10. Grounding - The grounding system must meet the Authority Having Jurisdiction (AHJ) requirements for your area.
11. NEVER short DC inputs. Do NOT connect the system to the grid with a shorted DC input.
12. WARNING - Only qualified service personnel are able to service this equipment. If errors persist after following the troubleshooting table, please contact your retailer for further assistance.
13. EG4 server rack batteries weigh over 100lbs each. Use caution when handling batteries.

## **DISCLAIMER**

EG4 reserves the right to make changes to the material herein at any time without notice. You may refer to the EG4 website at [www.eg4electronics.com](http://www.eg4electronics.com) for the most updated version of our manual.



# Introduction

## Product Description

EG4 Lifepower4 Rack-Mounted lithium battery products are suitable for low-voltage small and medium-sized energy storage system applications. These products adopt the highest safety performance lithium iron phosphate cells, with a high-precision battery management system (BMS), which can monitor and collect voltage, current and temperature of each cell in the module in real time. The BMS also has a passive balance function, advanced battery control strategy, which can improve the performance of the battery pack further.

The battery module consists of 16 “AAA” Grade cells , BMS, housing, breaker, and wire. The module can be placed in a standard 19-inch cabinet and establish communication with the outside devices through RS485, and communicate with other modules through RS485. The modules can be connected in parallel to meet the expansion needs. Maximum inter battery communications support 16 modules.

## Overview

### Included Equipment

When you purchase an EG4 Lifepower4 battery, you will receive multiple items. These items will be included in the battery box, or separate packaging within your shipment.

1. (1) EG4 Lifepower4 battery module
2. Inter-battery communication cable
3. Positive and Negative color coded connection cables

## Installation

### Needed Tools For Installation

The tools required may vary depending on how you choose to mount your battery. In general, you will need the following items to install your battery into an EG4 racking solution.

1. 10mm socket and ratchet
2. Phillips head screwdriver
3. Torque wrench of proper size

**NOTE:** Before installing multiple batteries into your battery bank, check for any batteries with SOC below 25%. To do this simply check that at least 2 SOC lights are on.

*If a battery has less than 2 SOC lights, then please contact your distributor tech department for proper battery balancing procedures.*

# EG4 Lifepower4 and EG4 Battery Rack Interface

1. **Grounding** - Ensure that all batteries are installed in the EG4 battery rack using the mounting hardware provided. Connect a grounding conductor to the grounding lug (or screw) on the rack (or cabinet), then connect the grounding conductor to a grounding rod. (**Warning - DO NOT** ground rack/cabinet or door to negative or positive bus bars)

2. **Communication cable installation** - (When a single module is used, please ignore this step)  
When multiple batteries are connected in parallel, please set the address code of the battery according to the DIP Table on page 7 (make sure there is no duplicate address code). Then connect the RS485 interface of the battery to each other, finally RS485 interface of the No.0 address battery connects to the inverter by communication cable.

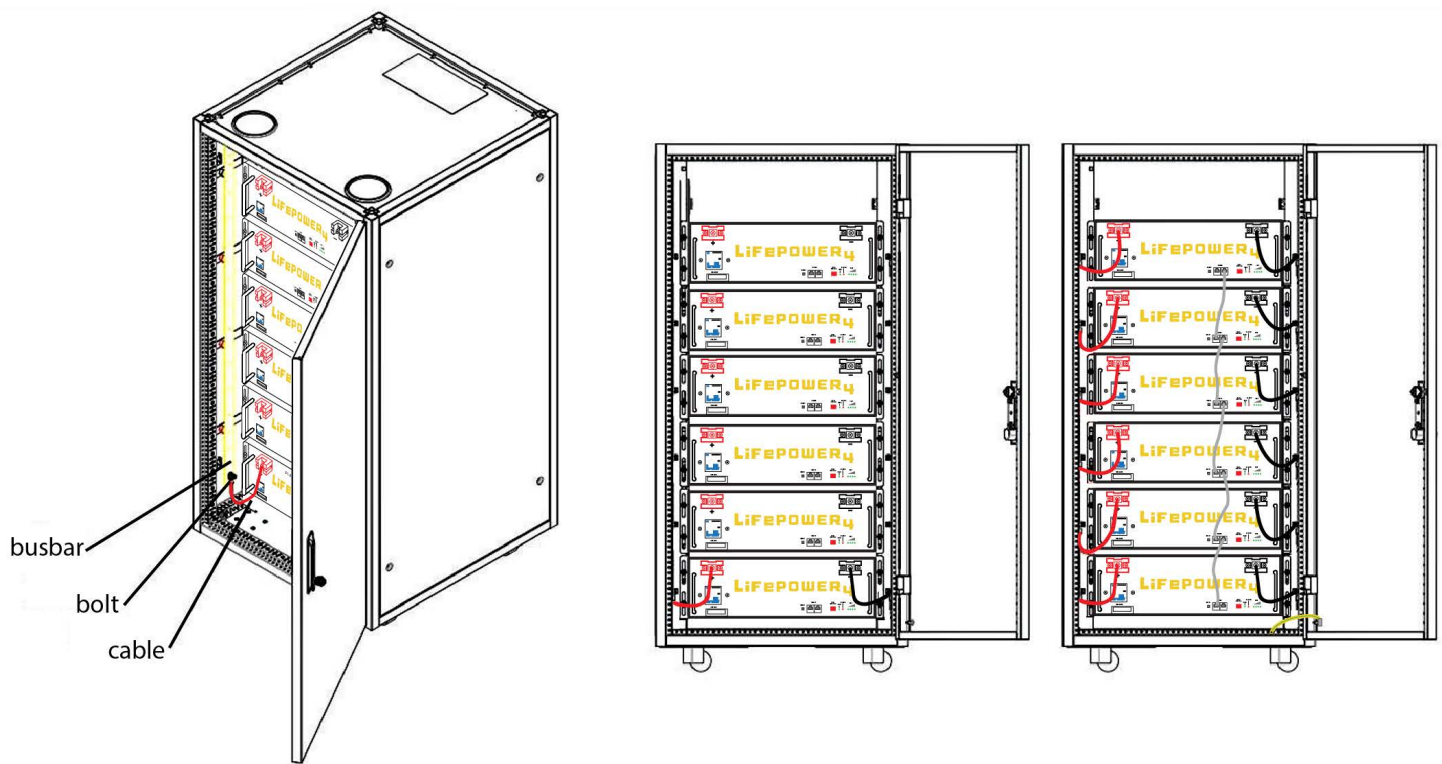

In the above figures, there are 6 EG4 Lifepower4 24V 200Ah batteries wired in parallel. This battery bank still maintains the appropriate 24V needed for most Inverter/Charger systems. However, the Amp hour rating of this bank has increased to 1200Ah.

**WARNING:** Do NOT parallel batteries by using jumper wires on the terminals. This will cause high amperage in the final jumpers and potentially excessive amperage on the battery terminals.

**WARNING:** When adding or removing a battery from the rack/cabinet, turn off ALL batteries and test your bus bars with a DC voltmeter. This will ensure that there is 0V on the bus bars. Do NOT work with live (powered) conductors.

## How to connect Cables to the Battery Terminals

1. Identify the positive and negative terminals on your battery. These are labeled and color coded. (Red for Positive, Black for Negative)
2. Verify you have all hardware to attach the cable properly. Check to ensure the bolt insert for the terminal fully seats and can be tightened to the proper torque.
3. Connect the cables to your battery terminals by removing the terminal bolts, inserting them through the eyelet of the proper cable, and reseating the bolt into the terminal block to the correct torque.
4. DO NOT finger tighten the terminal bolts. They require a specific torque (60 in-lb/7nm) to ensure they do not loosen during operation. Failure to properly tighten the terminal bolts can result in serious damage and will void your warranty.

## Connecting Your Batteries to a Busbar

EG4 recommends that you only use a properly sized (amp rated) busbar to parallel batteries together.

1. Connect the battery cables to your positive busbar by removing the bus bolts, inserting them through the eyelets of the proper cable, and reseating the bolt into the busbar to 60 in-lbs/7nm. Repeat with all positive cables.
2. Connect the battery cables to your negative busbar by removing the bus bolts, inserting them through the eyelets of the proper cable, and reseating the bolt into the busbar to the correct torque. Repeat with all negative cables.

## Battery Charging - User Defined Mode

Once you are ready to charge your batteries, you must ensure that you use the proper settings. This will ensure that you don't over-charge or damage your batteries.

### 24V

1. Bulk/Absorption: 28.1V (+/- .2V)
2. Float: 27V (+/- .2V)
3. Low DC cutoff: 23.5-22V\*
4. Battery Charge Temperature Range: 32°F - 122°F
5. Battery Discharge Temperature Range: -4°F - 131°F

\*depending on load - start high, lower if needed

## What To Expect During a Charge Cycle

It is normal for LFP batteries that have their own internal BMS and that are wired in parallel to demonstrate a fairly wide variety of SOC readings during any given charge or discharge cycle. Variations of up to 10% are common. This is not cause for concern or indication you are getting anything less than the full capacity of your pack. This is caused by even slight variations in wiring resistance to each battery, internal resistance, temperature differences and variations in cell manufacture. Even a slight variation causes one battery to take more of the load or charge for a while. Over the duration of the discharge or charge cycle, this will balance out with the lagging battery then taking the load or charge at the other end of the cycle resulting in recovering the full listed KWH capacity of the pack. The voltage differences created as batteries diverge in SOC will eventually cause them to converge at some point in the cycle.

# Introduction to the BMS

The BMS (Battery Management System) is designed to protect your battery and battery cells from a number of situations that may damage or destroy your system. This protection also helps keep your battery and the battery cells operable for a larger number of life cycles. Each EG4-LL battery is specifically configured to ensure the optimal performance and operation of your equipment.

## PCB Temperature Protection

The BMS will ensure that the PCB (Printed Circuit Board) does not overheat. This is the part that houses most of the “brains” of the battery. This feature will turn off the battery if it begins to overheat.

## Cell Balance Protection

Cell balance ensures that each cell is within a specific voltage range of each other. Cell balance is crucial for ensuring that your battery is operating properly for its lifespan. This is done automatically at all times.

## Environmental Temperature Protection

In periods of extreme heat or cold, it may be dangerous for your battery to operate. Continued operation in these conditions can cause permanent damage to your battery, and electrical system. To ensure this does not happen, the BMS is designed to measure the temperature while it is charging/discharging, and will shut down the battery to prevent damage.

## Voltage Protection

The BMS is designed to constantly monitor the voltage of each individual cell and ensure that they do not become over/undercharged.

## Current Protection

The BMS is designed to constantly monitor the charge/discharge amperage, and has built in protections against exceeding specific parameters. These include built in timers that shut off quickly in the event of extremely large amperage, and delayed shut down for amperage that is only slightly above maximum. This also protects from short circuits.

## Precharge Resistor Circuit











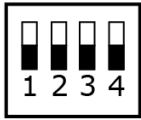
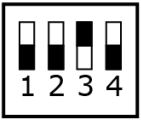
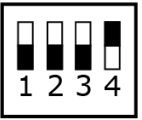
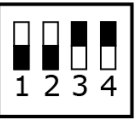

EG4 Lifepower4 batteries are designed with an internal precharge resistor to assist in starting large inverters. These resistors are active as soon as you turn on the battery’s breaker. Follow these instructions when connecting EG4 Lifepower4 batteries to inverters.

1. Ensure all batteries are off.
2. Using red conductors, make the “positive” connection between the battery bank and inverter.  
(Make sure to use appropriate over current protection)
3. Using black conductors, make the “negative” connection between the battery bank and inverter.
4. Ensure all conductors are firmly attached and in-line over current protection is closed (on).
5. Turn all battery breakers on. (This activates the precharge resistor)
6. If any battery alarm light turns on, cycle that battery’s breaker off then on.  
(This reactivates the precharge resistor)
7. Repeat until the alarm light(s) clears.
8. Turn on inverter.

# Battery Communications

Each EG4 is built with the user in mind, and designed to show you as much information as possible as easily as possible. We include an option to connect your battery to PC software to monitor the status of your battery. This allows you to see and understand exactly what your battery is doing, as well as allowing you to troubleshoot if you run into any issues.

## DIP Switch ID Settings

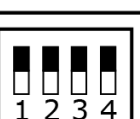
0		4		8		12	
1		5		9		13	
2		6		10		14	
3		7		11		15	

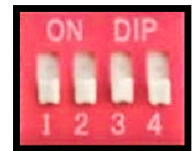

ID code bits correspond to binary digits, up represents "ON", down represents "OFF". The right side of the code bit is the low bit, and the left side is the high bit. The code range is 0~15, and the communication mode can support up to 16 modules in parallel.

EG4 Lifepower4 batteries interface with inverters and PC monitoring by designating a "Host" battery (DIP switch ID No. 0). This battery will connect directly via an EG4 battery communications cable or a standard CAT 5, 5e, or 6 cable (for closed loop communications with supported non-EG4 inverter types).

If you have multiple batteries, ALL other DIP switch settings MUST be different from each other. This allows equipment to see each battery in the bank separately.

## PC Software Installation

The PC software provides a tool for temporary battery analysis and diagnostics. You cannot run the PC software and a closed loop inverter at the same time. Use the battery communications cable (USB/RS485) to connect to the open RS485 port on the Host battery. (Remove inverter communication cable, if present)

Check the [eg4electronics.com](http://eg4electronics.com) website to get the latest version of the software for free, and run the BMS\_TEST.exe program directly after unpacking.

# Interfacing PC with Liferpower4 BMS

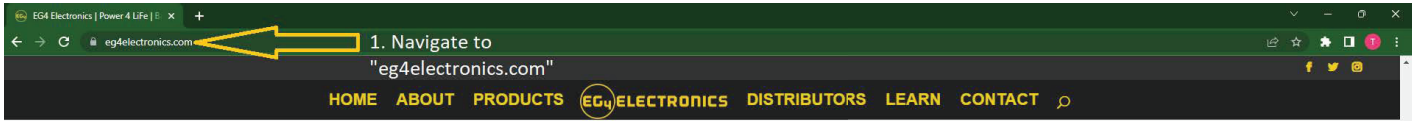

## The EG4 Advantage

## Stay Up To Date

Firmware updates, Manuals, Spec. Sheets.

Downloads >

Scroll down and click the "Downloads" link

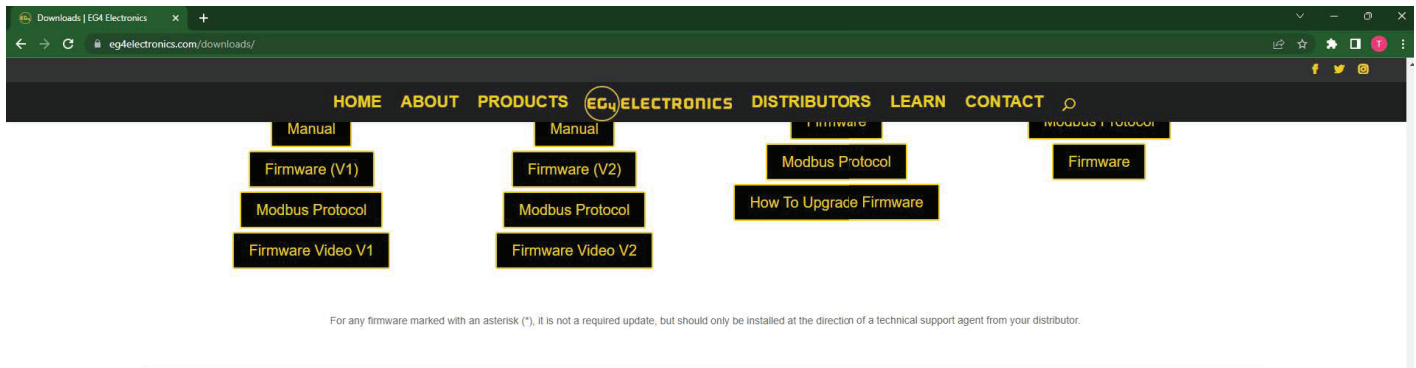
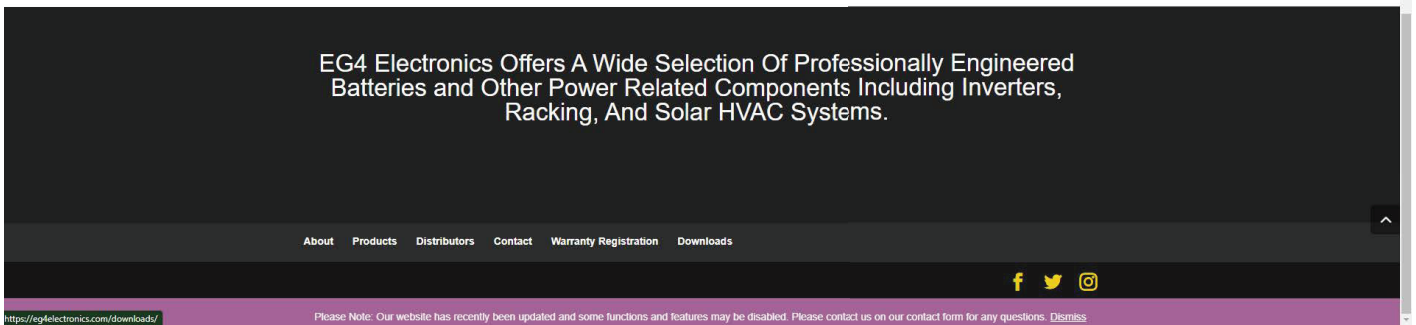

2. Once that has been clicked, a download for the software will start in the bottom left hand corner

## Software and Drivers

BMS Tools

BMS Test >

USB Cable Driver

This is the BMS software for use with the EG4-LL batteries.

This is the BMS software for use with the EG4-LiFePower4 batteries.

This is a driver for the cable that allows you to connect to our batteries. By default it should install when plugged into the computer, but if for some reason you are not able to see the cable this is the driver you can manually install as needed.

1. Scroll down and click on the "BMS Test" download option

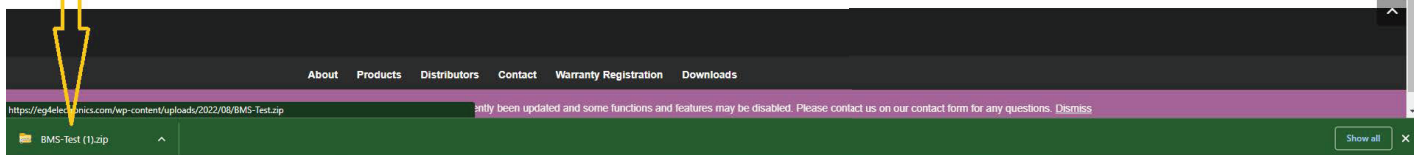



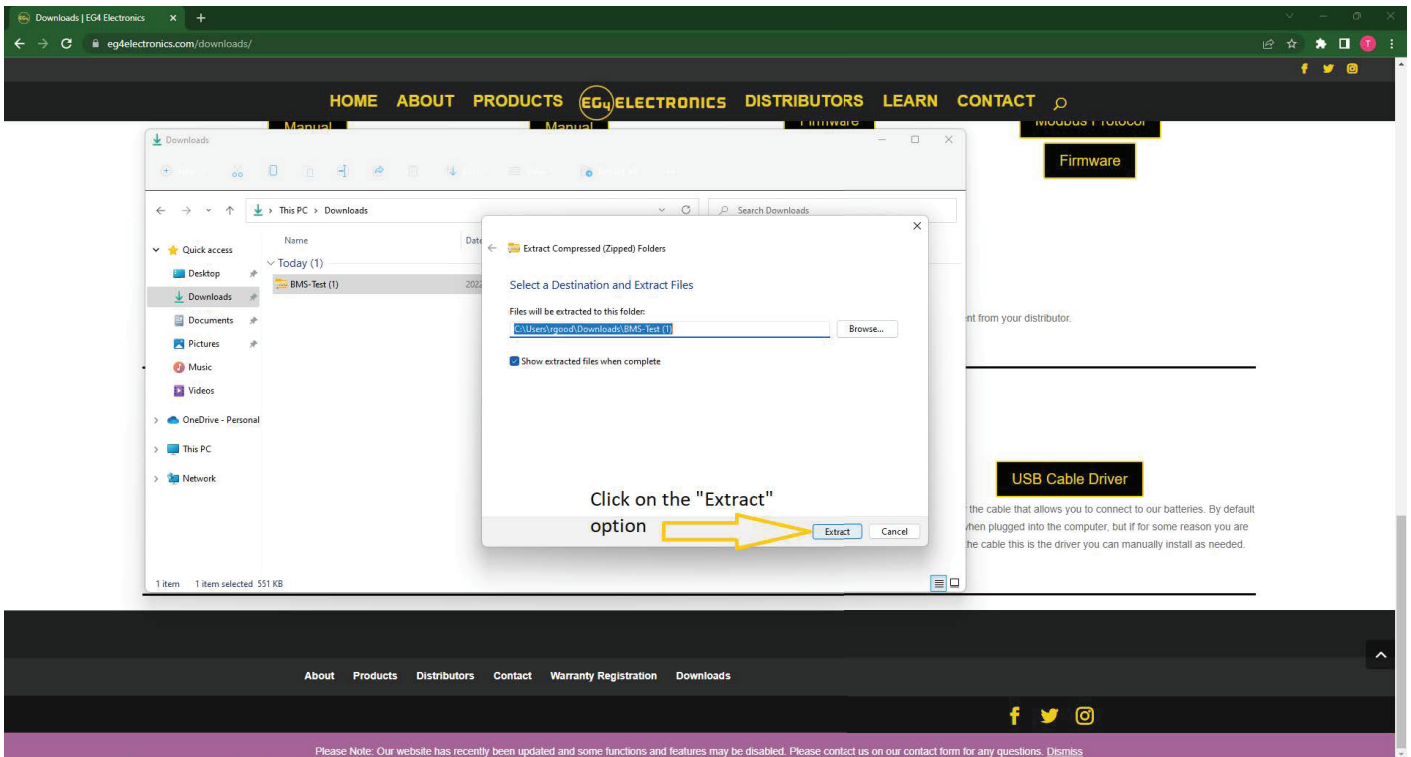
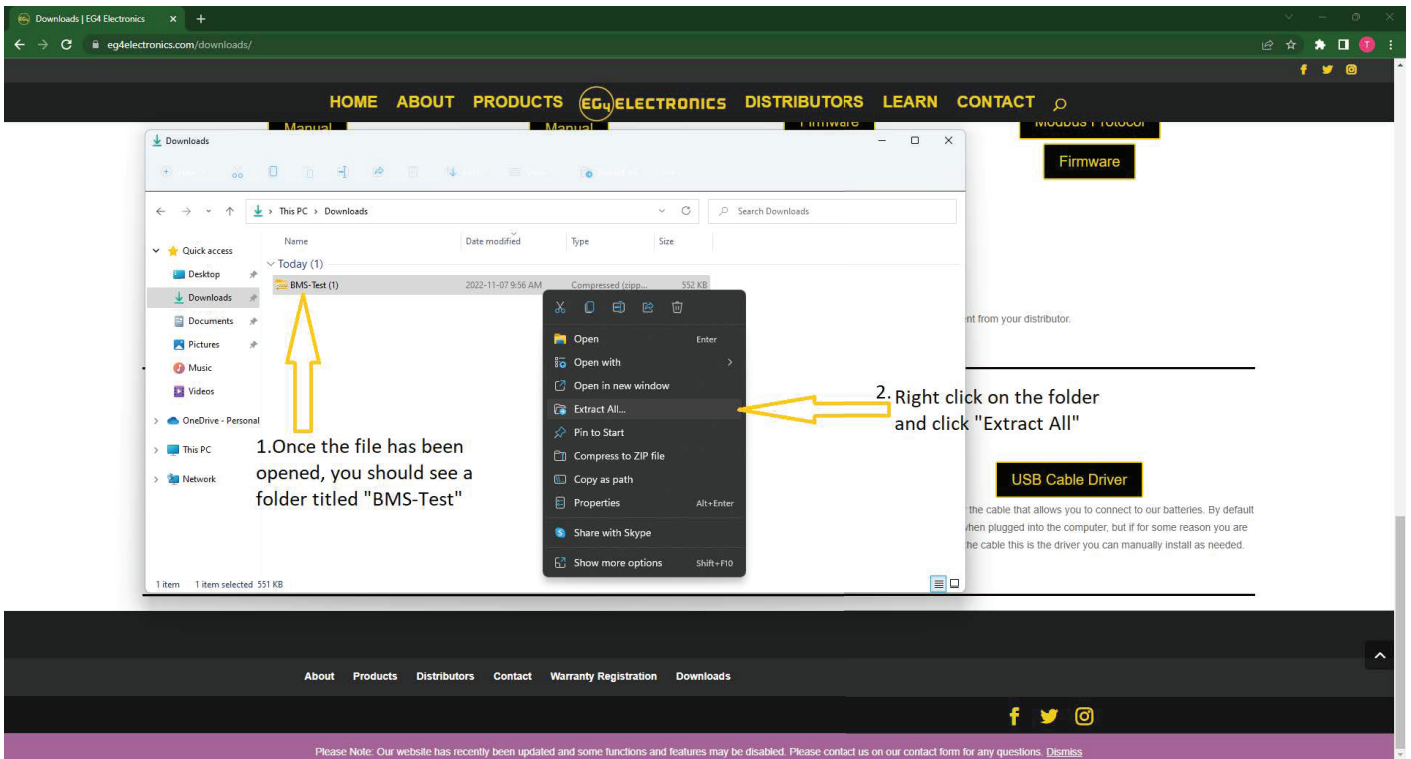

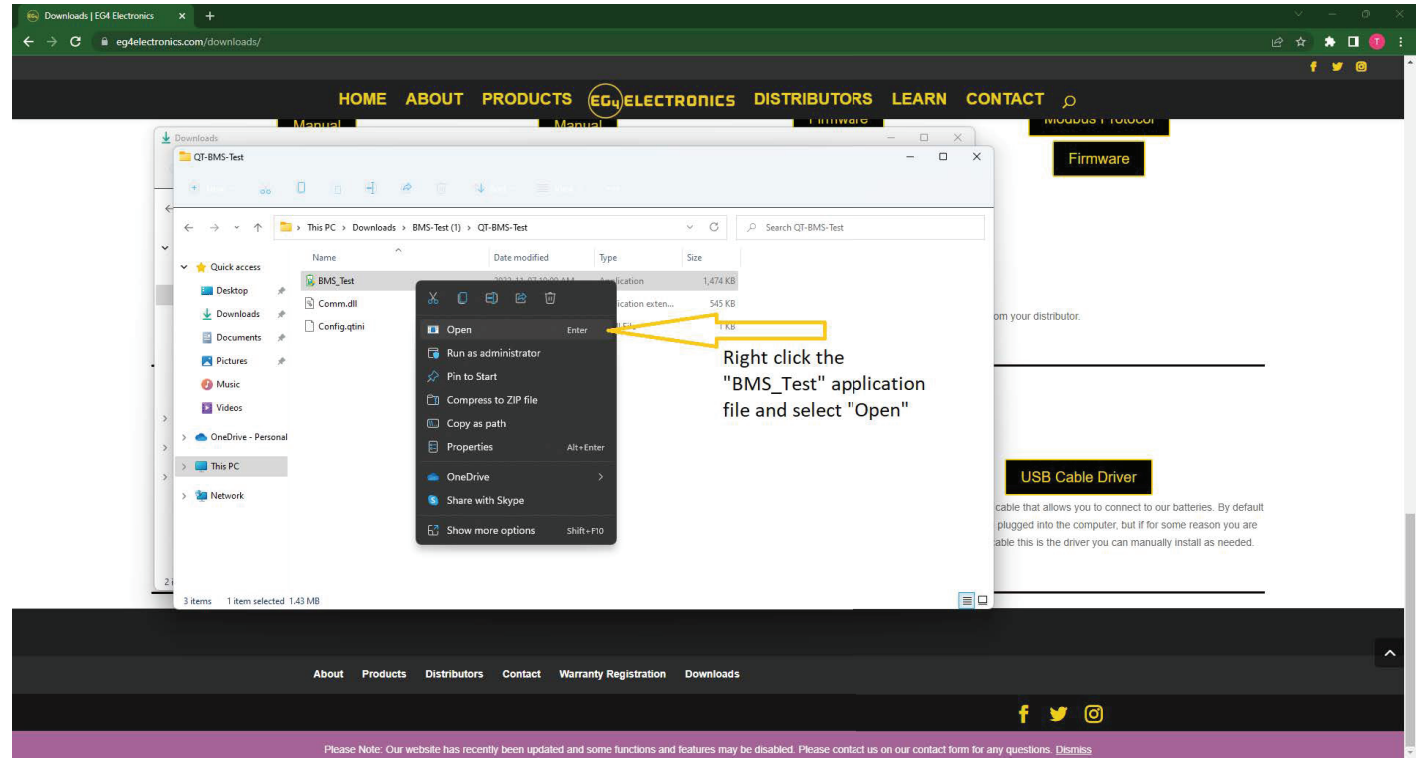
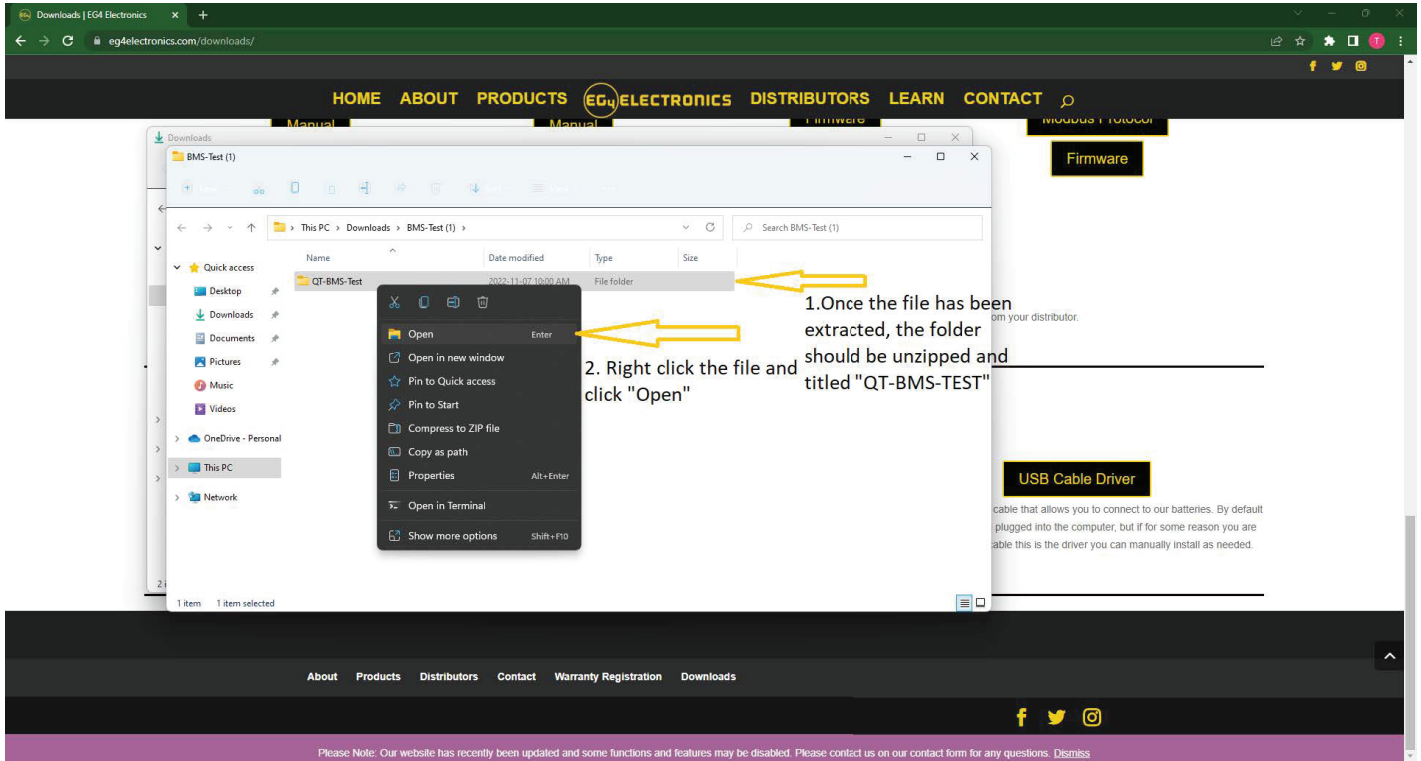



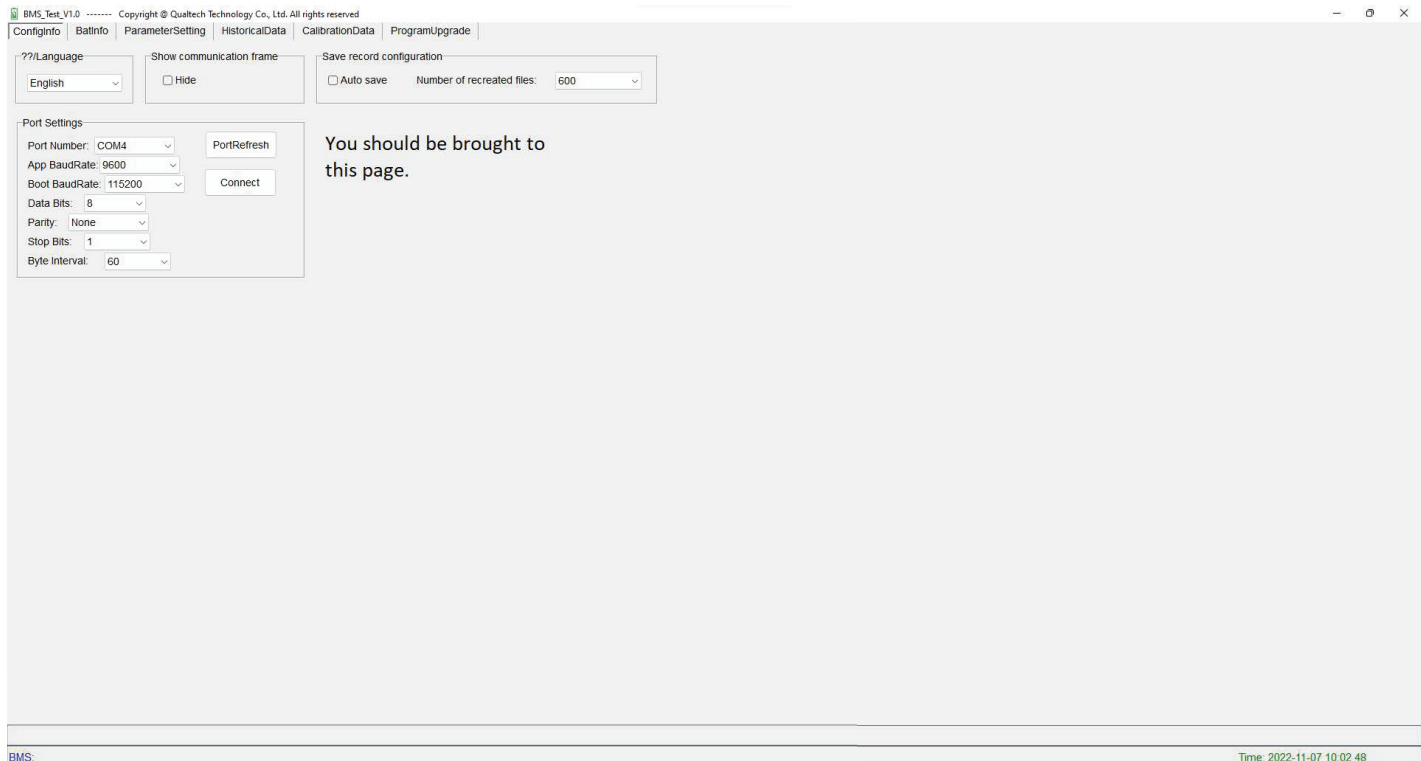
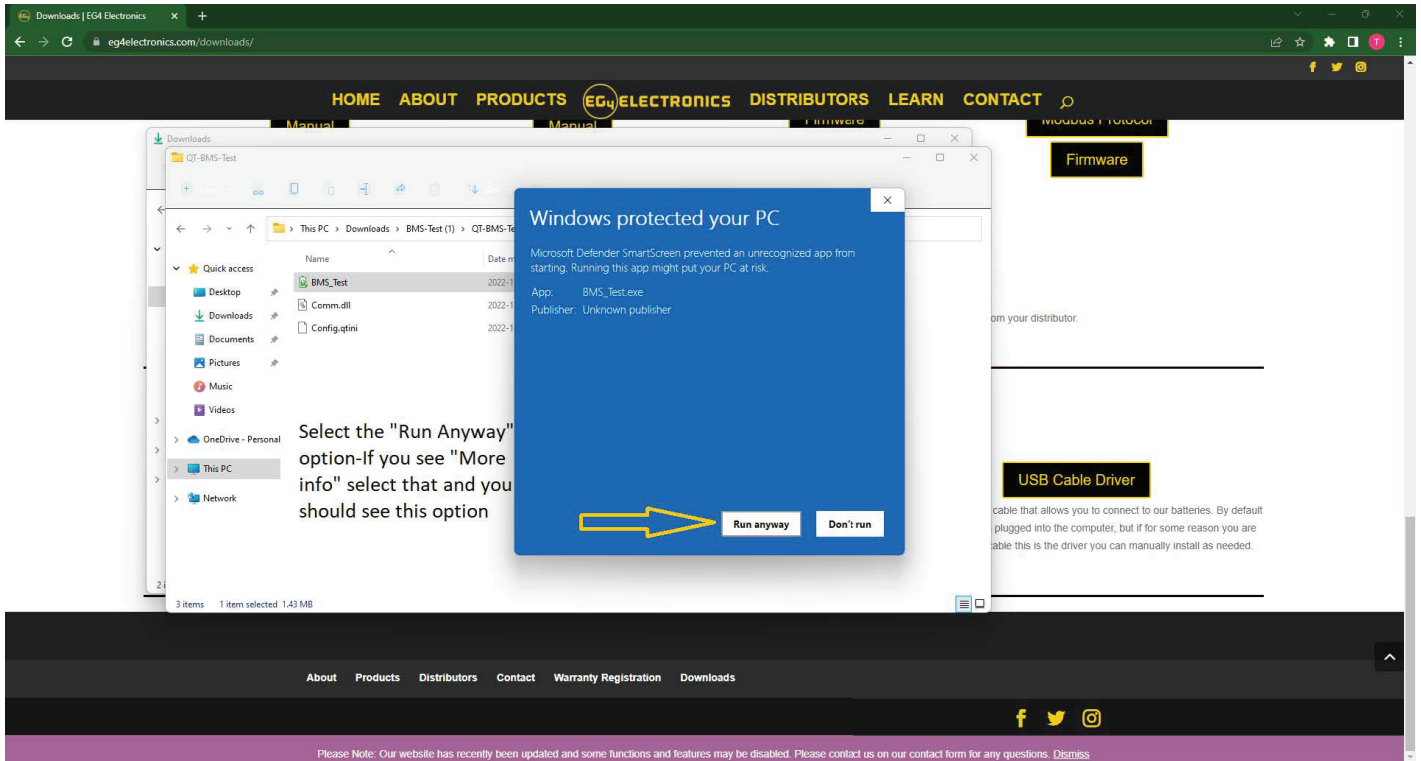

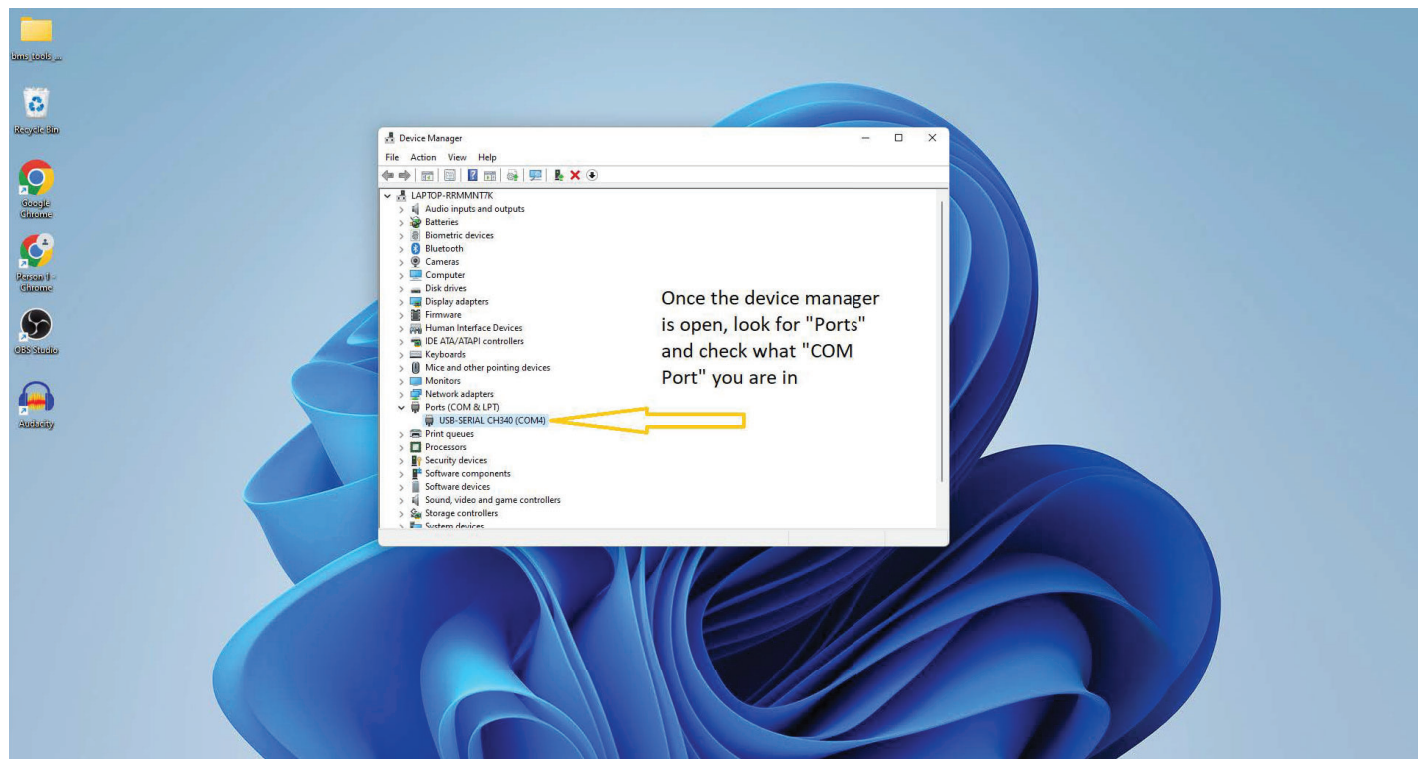
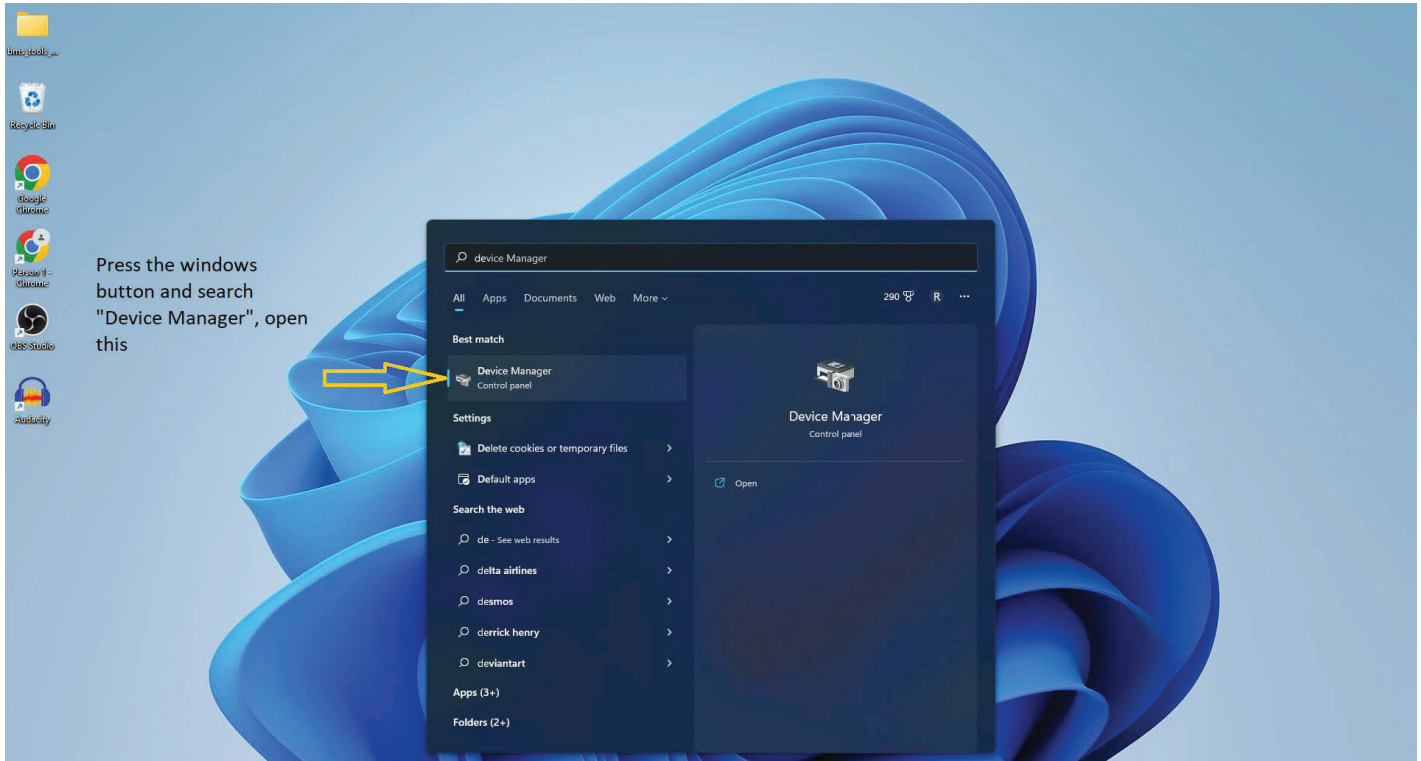











# Troubleshooting

## Alarm Description and Handling

When the ALM light on the battery control panel is on, it means that the battery has given an alarm or has been protected, please check the cause of the failure through the computer and take appropriate measures or go directly to your distributor. Common alarm conditions are shown below.

State	Warning/ Normal	RUN	ALM	SOC LED				Definition
				25%	50%	75%	100%	
OFF		OFF	OFF	OFF	OFF	OFF	OFF	All OFF
Standby	Normal	ON	OFF	ON as battery capacity indicates				
	Warning	ON	Flash 2					
	Protection	OFF	ON					
Charge	Normal	Flash 1	OFF					
	Warning	Flash 1	Flash 2					
	Protection	OFF	ON					
Discharge	Normal	Flash 2	OFF					
	Warning	Flash 2	Flash 2					
	Protection	OFF	ON					
BMS failure		OFF	Flash2	OFF				

Fault	Analysis	Solution
Module overvoltage protection	The battery pack voltage has exceeded the recommended maximum battery voltage	Stop charging the battery. Ensure charger setting is within EG4 specifications.
Module undervoltage protection	The battery pack voltage has discharged below the recommended minimum battery voltage	Stop discharging the battery. Ensure inverter settings are within EG4 specifications.
High temperature protection (Charging)	The battery temperature is above the maximum threshold	Stop charging the battery, and turn off the battery. Allow the battery to cool. If the problem persists, contact your distributor
Low temperature protection (Charging)	The battery temperature is below the minimum threshold	Stop charging the battery. Ensure that the battery temp is above 32F before charging.
Cell high temperature protection (Discharging)	The battery cell temperature is above the maximum threshold	Stop discharging the battery, and turn off the battery. Allow the battery to cool. If the problem persists, contact your distributor
Cell low temperature protection (Discharging)	The battery cell temperature is below the minimum threshold	Stop discharging the battery. Turn off the battery. Ensure the battery is above -4F before discharging
Charge overcurrent protection	The charging current is too high	Ensure that your charging current is set within battery specifications.
Discharge overcurrent protection	The discharging current is too high	Ensure that your home loads are within your battery bank's capacity
Output short circuit protection	Your DC circuit has a short	Locate short using a multimeter

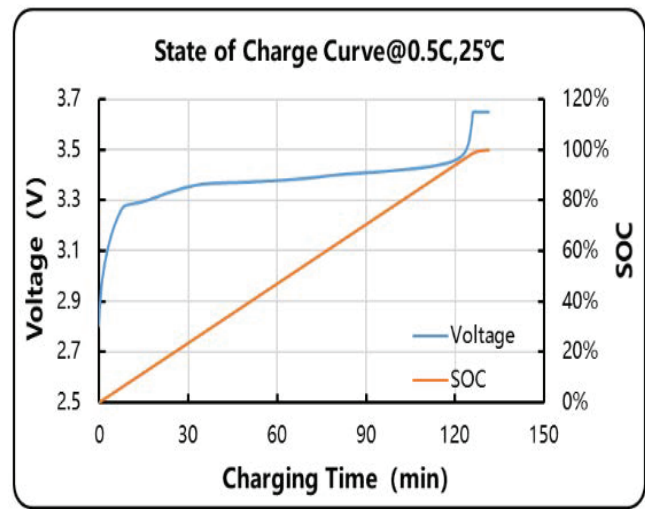
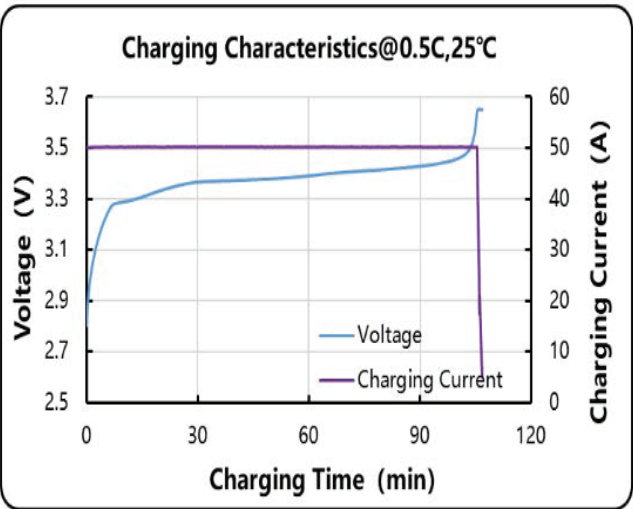
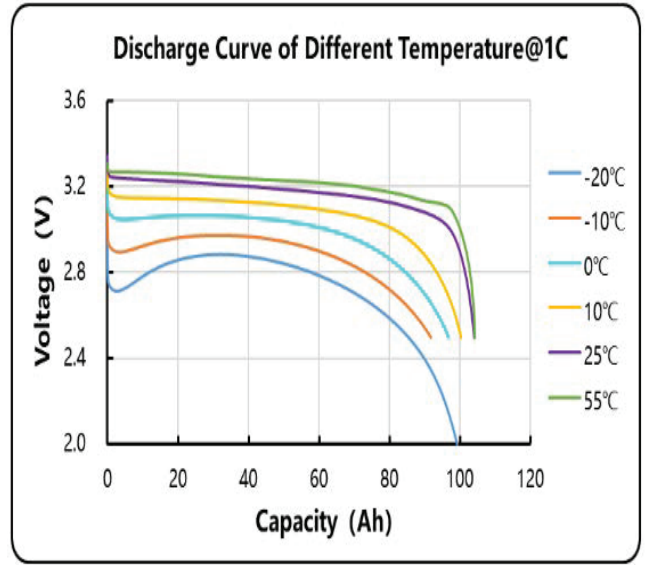
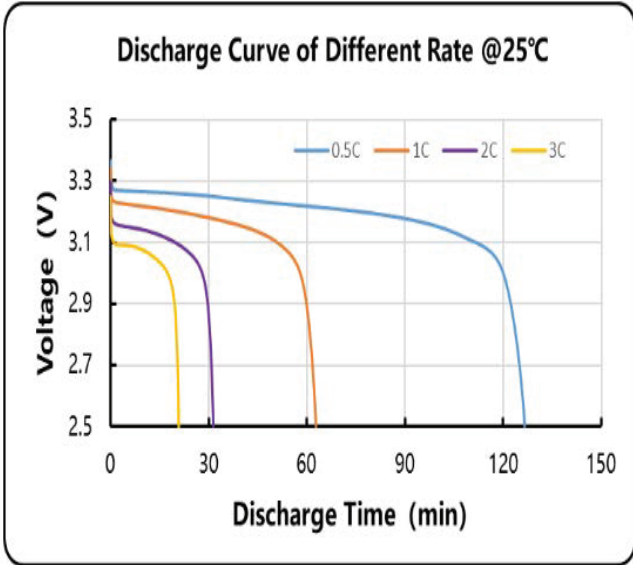

Different Temperature Self Discharge			
SOC	Storage Temperature (°C)	Storage Days	Capacity Retention
100%SOC	25	28	96%
100%SOC	55	7	94%



# Battery Storage

## How do you properly store your battery?

If you plan to store your batteries, there are a few steps you can take to ensure that they are stored safely and in a state that will ensure they are not damaged while storing them. These include a few factors as detailed below.

### Battery State

The state of the battery when placed into storage will affect how long it can be stored for as well as the condition when you begin using it again. EG4 recommends that each battery is brought to a SOC (state of charge) of 100% prior to placing it in storage. Lithium iron phosphate batteries will lose a certain percentage of their total charge while in storage, depending on how long they are stored and the conditions they are stored in. Our recommendation is to ensure they are fully charged to allow them to be stored as safely and for as long as possible.

### Environmental Factors

The environment you store your EG4 battery in can greatly affect the health of the battery. The temperature should remain moderate. We also suggest keeping the battery away from locations where it may get wet, or locations with extremely high humidity.

## What steps should you take to maintain a healthy battery?

EG4 batteries are an advanced lithium iron phosphate battery. This means that in reality, they require very little maintenance. If used correctly by following this manual, we have designed these to be 'set it and forget it' for most of their lifespan. We recommend connecting to the batteries periodically using the monitoring software to ensure there aren't any irregularities. Beyond that, after initial set up you shouldn't need to do much with your batteries at all.

# Battery End of Life

## How should you properly recycle or dispose of your batteries?

The EG4 battery is designed to last for 15+ years when used correctly. We have worked tirelessly to ensure that our batteries will maintain a charge after thousands of cycles. However, when it does come time to retire your battery, there are a few things you must consider.

Lithium iron phosphate batteries are considered a hazardous material and should not be disposed of by simply placing them in the trash. There are a number of online websites and organizations that will accept your battery to recycle at little to no cost to you. At EG4, we understand that we are working with customers across the United States and the world. Our best recommendation is to visit your favorite search engine, and search the term "Lithium Battery Disposal Near Me". You will likely get an assortment of organizations that can safely dispose of your battery. We highly recommend calling ahead of time to ensure that the location is still open and accepting materials.

If, however, you are unable to locate a disposal location safely, we are here to help. Before dumping your battery or disposing of it incorrectly, please contact our customer service team for further assistance.

## EG4 Warranty

Your 5 year Lifepower4 warranty must be registered within the first year of purchase to remain valid. If you choose not to register your warranty, your warranty may be invalidated. This limited warranty is to the original purchaser of the product and not transferable to any other person or entity. All BMS and Cell Exchanges are covered throughout the warranty period. If a full replacement warranty is needed the warranty is prorated 1/4th per year after the first year at the current retail pricing.

Warranty Exclusions - EG4 Electronics has no obligation under this limited warranty for product subjected to the following conditions (including but not limited to):

- Damages incurred during installation or removal
- Damages caused during mishandling of product
- Inappropriate Environmental Exposure
- Damages caused by improper maintenance
- Tampering, Altering, and/or Disassembly of product
- Using product in applications other than which it was intended for by manufacturer
- Lightning, Fire, Flood, or Acts of God
- Any product whose serial number has been altered, defaced, or removed

The equipment sold by EG4 Electronics is designed to be installed only by licensed, trained, and insured solar electrical installation professionals. We strongly advise the customer to seek the assistance of such a professional to exclusively perform the implementation of any of these products, and we make no warranty of the purchaser's safety, success of equipment implementation, or compliance with local codes and regulations.

EG4 Electronics disclaims all additional warranties, expressed or implied, including but not limited to, any implied warranty with respect to the accuracy or completeness of the information they disseminate and /or fitness of the materials sold for a particular purpose. No warranty may be created or extended by sales or promotional materials on these items. Each party hereby irrevocably waives its rights to trial by jury in any Action or proceeding arising out of this agreement or the transactions relating to its subject matter. All installation advice provided by EG4 before, during, or after purchase of solar equipment is purely for the purpose of general concept education and must not replace the expertise of a licensed and trained solar specialist. The Customer agrees to full indemnification for EG4 henceforth from any legal recourse relating to and arising out of losses, direct or consequential, from the installation of the products purchased by the customer in excess of the value of the equipment purchase price.