

EG4[®] LL-S 48V 100Ah SERVER RACK

USER MANUAL



SCAN FOR UPDATED
DOCUMENTS



TABLE OF CONTENTS

1.	ABBREVIATIONS	1
2.	TECHNICAL SPECIFICATIONS TABLE	2
3.	SAFETY	4
3.1	SAFETY INSTRUCTION	4
3.2	IMPORTANT SAFETY NOTIFICATIONS	4
4.	BRIEF INTRODUCTION.....	6
5.	SYSTEM OVERVIEW	6
5.1	BATTERY DIAGRAM	8
5.2	EMERGENCY STOP (RSD, ESS DISCONNECT).....	9
6.	INSTALLATION	10
6.1	PACKAGING LIST AND PLACEMENT	10
6.2	LOCATION SELECTION AND INSTALLATION.....	10
6.2.1	STORAGE.....	10
6.2.2	REQUIREMENTS FOR INSTALLATION.....	11
6.2.3	GENERAL INSTALLATION	12
6.2.4	INSTALLATION IN EG4 BATTERY RACK.....	13
6.3	BATTERY COMMUNICATIONS.....	14
6.3.1	CONNECTING MULTIPLE BATTERIES IN PARALLEL.....	14
6.3.2	COMMUNICATION CABLE PINOUT AND DIP SWITCH ID TABLES	14
6.4	INSTALLING WITH DIFFERENT EG4 BATTERY MODELS	16
7.	BATTERY OPERATION	17
7.1	LCD SCREEN	17
7.1.1	BUTTON DESCRIPTION.....	17
7.1.2	WAKING UP THE LCD SCREEN	17
7.1.3	CELL INFORMATION.....	18
7.1.4	TEMPERATURE INFORMATION.....	18
7.2	COMMUNICATION PROTOCOL SELECTION.....	19
7.2.1	PROTOCOL CHANGE/SELECTION PROCEDURE.....	19
7.3	BMS TOOLS INSTALLATION AND INTERFACING	20
7.3.1	DOWNLOADING AND INSTALLING BMS TOOLS.....	20
7.3.2	INTERFACING WITH BMS TOOLS.....	21
7.3.3	INTERFACE MENU DEFINITION	24
7.4	BATTERY CHARGING	25
8.	TROUBLESHOOTING, MAINTENANCE & DISPOSAL	25
8.1	INTRODUCTION TO THE BMS	25
8.2	ALARM DESCRIPTION AND TROUBLESHOOTING.....	26
8.3	BATTERY END OF LIFE	27
9.	EG4 10-YEAR LIMITED WARRANTY	28

1. ABBREVIATIONS

- AWG – American Wire Gauge
- A – Amps
- Ah – Amp hour(s)
- AC – Alternating Current
- AFCI – Arc-Fault Circuit Interrupter
- AHJ – Authority Having Jurisdiction
- kAIC – kilo-Amp Interrupting Capability
- ANSI – American National Standards Institute
- BAT – Battery
- BMS – Battery Management System
- COM – Communication
- CT – Current Transformer
- DC – Direct Current
- DIP – Dual In-line Package
- DOD – Depth of Discharge
- EG – Equipment Ground
- EGS – Equipment Grounding System
- EMC – Electromagnetic Compatibility
- EPS – Emergency Power System
- ESS – Energy Storage System
- E-Stop – Emergency Stop
- FCC – Federal Communication Commission
- GE – Grounding Electrode
- GEC – Grounding Electrode Conductor
- GFCI – Ground Fault Circuit Interrupter
- GFDI – Ground Fault Detector/Interrupter
- Imp – Maximum Power Point Current
- IEEE – Institute of Electrical and Electronic Engineers
- IP – Ingress Protection
- I_{sc} – Short-Circuit Current
- In-lbs. – Inch Pounds
- kW – Kilowatt
- kWh – Kilowatt-hour
- LCD – Liquid Crystal Display
- LFP – Lithium Iron Phosphate
- L1 – Line 1
- L2 – Line 2
- mm – Millimeters
- MPPT – Maximum Power Point Tracking
- mV – Millivolt
- N – Neutral
- NEC – National Electric Code
- NEMA – National Electrical Manufacturers Association
- NFPA – National Fire Prevention Association
- Nm – Newton Meters
- NOCT – Normal Operating Cell Temperature
- PC – Personal Computer
- PCB – Printed Circuit Board
- PE – Protective Earth
- PPE – Personal Protective Equipment
- PV – Photovoltaic
- RSD – Rapid Shut Down
- SCC – Standards Council of Canada
- SOC – State of Charge
- STC – Standard Testing Conditions
- UL – Underwriters Laboratories
- UPS – Uninterrupted Power Supply
- V – Volts
- VOC – Open-Circuit Voltage
- VMP – Voltage Maximum Power

2. TECHNICAL SPECIFICATIONS TABLE

MODULE OPERATING PARAMETERS			
PARAMETER	BMS	RECOMMENDED SETTING	
VOLTAGE	51.2V	NA	
CAPACITY	100Ah	NA	
CHARGING VOLTAGE (BULK/ABSORB)	56.8V	56.2V (+/-0.2V)	
FLOAT	NA	54V (+/-0.2V)	
LOW DC CUTOFF	44.8V	47V-45.6V (Start high, lower as needed)	
CHARGING CURRENT	100A (Max. continuous)	30-50A	
DISCHARGING CURRENT	100A (Max. continuous)	90A	
ENVIRONMENTAL PARAMETERS			
CHARGING RANGE	32°F – 113°F (0°C – 45°C)		
DISCHARGING RANGE	-4°F – 122°F (-20°C – 50°C)		
STORAGE RANGE	-4°F – 122°F (-20°C – 50°C)		
INGRESS PROTECTION	IP20		
BMS PARAMETERS			
CHARGE	SPEC	DELAY	RECOVERY
CELL VOLTAGE PROTECTION	3.8V	1s	3.45V
MODULE VOLTAGE PROTECTION	60.0V	1s	55.2V
OVER CHARGING CURRENT 1	>102A	20s	-
OVER CHARGING CURRENT 2	≥120A	3s	-
TEMPERATURE PROTECTION	<23°F or >158°F <-5°C or >70°C	1s	<32°F or >140°F <0°C or >60°C
DISCHARGE			
CELL VOLTAGE PROTECTION	2.3V	1s	3.1V
MODULE VOLTAGE PROTECTION	44.8V	1s	48.0V
OVER CHARGING CURRENT 1	>102A	30s	60s
OVER CHARGING CURRENT 2	>150A	3s	60s
SHORT-CIRCUIT	>300A	<0.1mS	-
TEMPERATURE PROTECTION	<-4°F or >167°F <-20°C or >75°C	1s	>14°F or <149°F >-10°C or <65°C
PCB TEMP PROTECTION	>221°F (>105°C)	1s	<176°F (<80°C)

GENERAL SPECIFICATIONS			
PARAMETER		SPEC	CONDITION
CELL BALANCE	120mA	Passive Balance	Cell Voltage Difference >40mV
TEMPERATURE ACCURACY	3%	Cycle Measurement	Measuring Range: 40°F – 212°F (-4°C – 100°C)
VOLTAGE ACCURACY	0.5%	Cycle Measurement	For Cells/Module
CURRENT ACCURACY	3%	Cycle Measurement	Measurement Range: +/-200A
SOC	5%	-	Integral Calculation
POWER CONSUMPTION (SLEEP & OFF MODE)	<300uA	-	Storage/Transport/ Standby
POWER CONSUMPTION (OPERATING)	<25mA	-	Charging/Discharging
COMMUNICATION PORTS		RS485/CAN	Customizable
MAXIMUM UNITS IN SERIES			1
MAXIMUM UNITS IN PARALLEL			64
E-STOP FUNCTION			Yes
DIMENSION (H×W×D)			6.1in×19in×17.4in (15.5cm×48.2cm×44.2cm)
WEIGHT			99.6 lbs. (45.2 kg)
STANDARDS AND CERTIFICATIONS			
MODULE			ETL Listed to UL Standard 9540A:2019
CELL			UL:1973

3. SAFETY

3.1 SAFETY INSTRUCTION

Before any work begins, carefully read all safety instructions, and always observe them when working on or with the battery. The installation must follow all applicable national or local standards and regulations. Consult with the local AHJ to obtain the proper permits and permissions before installation.

Incorrect installation may cause:

- *Injury or death to the installer, operator or third party*
- *Damage to the battery or other attached equipment*

3.2 IMPORTANT SAFETY NOTIFICATIONS

There are various safety concerns that must be carefully observed before, during, and after the installation, as well as during future operation and maintenance. The following are important safety notifications for the installer and any end users of this product under normal operating conditions.



DANGER!

AVERTISSEMENT!

High Voltages and Large Current!

Circuits à tension élevée!

1. **Do not disassemble the battery.** Contact the distributor for any issues that need repair for more information and proper handling instructions. Incorrect servicing or re-assembly may result in a risk of electric shock or fire and void the warranty.
2. **Never short-circuit DC inputs.** Short-circuiting the battery may result in a risk of electric shock or fire and can lead to severe injury or death and/or permanent damage to the unit and/or any connected equipment.
3. **Use caution when working with metal tools on or around batteries and systems.** **Risk** of electrical arcs and/or short circuiting of equipment can lead to severe injury or death and equipment damage.
4. **Beware of high battery current.** Please ensure that the battery module breakers and/or on/off switches are in the “open” or “off” position before installing or working on the battery. Use a voltmeter to confirm there is no voltage present to avoid electric shock.
5. **Do not make any connections or disconnections to the system while the batteries are operating.** Damage to system components or risk of electrical shock may occur if working with energized batteries.
6. Make sure the battery and rack are properly grounded.
7. An installer should make sure to be well protected by reasonable and professional insulative equipment [e.g., personal protective equipment (PPE)].
8. Before installing, operating, or maintaining the system, it is important to inspect all existing wiring to ensure it meets the appropriate specifications and conditions for use.
9. Ensure that the battery and system component connections are secure and proper to prevent damage or injuries caused by improper installation.



WARNING: All work on this product must be carried out by qualified personnel. To reduce the risk of electric shock, do not perform any servicing other than that specified in the operating instructions unless qualified to do so

1. Read all instructions before commencing installation. For electrical work, follow all local and national wiring standards, regulations, and these installation instructions. All wiring should be in accordance with the National Electrical Code (NEC), ANSI/NFPA 70.
2. The battery and system can connect with the utility grid only if the utility provider permits. Consult with the local AHJ before installing this product for any additional regulations and requirements for the area.
3. All warning labels and nameplates on this battery should be clearly visible and must not be removed or covered.
4. The installer should consider the safety of future users when choosing the battery's correct position and location as specified in this manual.
5. Please keep children away from touching or misusing the battery and relevant systems.

The battery is designed to stop charging when reaching the low threshold of 32°F. If charging current is observed when the internal battery temperature is below 32°F, disconnect battery immediately and consult manufacturer.

DISCLAIMER

EG4 reserves the right to make changes to the material herein at any time without notice. Please refer to www.eg4electronics.com for the latest documentation.

4. BRIEF INTRODUCTION

The EG4 48V LL-S rack-mounted lithium batteries are ideal for low-voltage energy storage system applications. These batteries use lithium iron phosphate cells with the highest safety performance and a battery management system (BMS) that can monitor and collect voltage, current, and temperature of each cell within the module in real time. The BMS also contains a passive balance function and an advanced battery control method, both of which can help improve the performance of the battery pack. For enhanced security, the battery has two onboard fire-extinguishing modules.

5. SYSTEM OVERVIEW

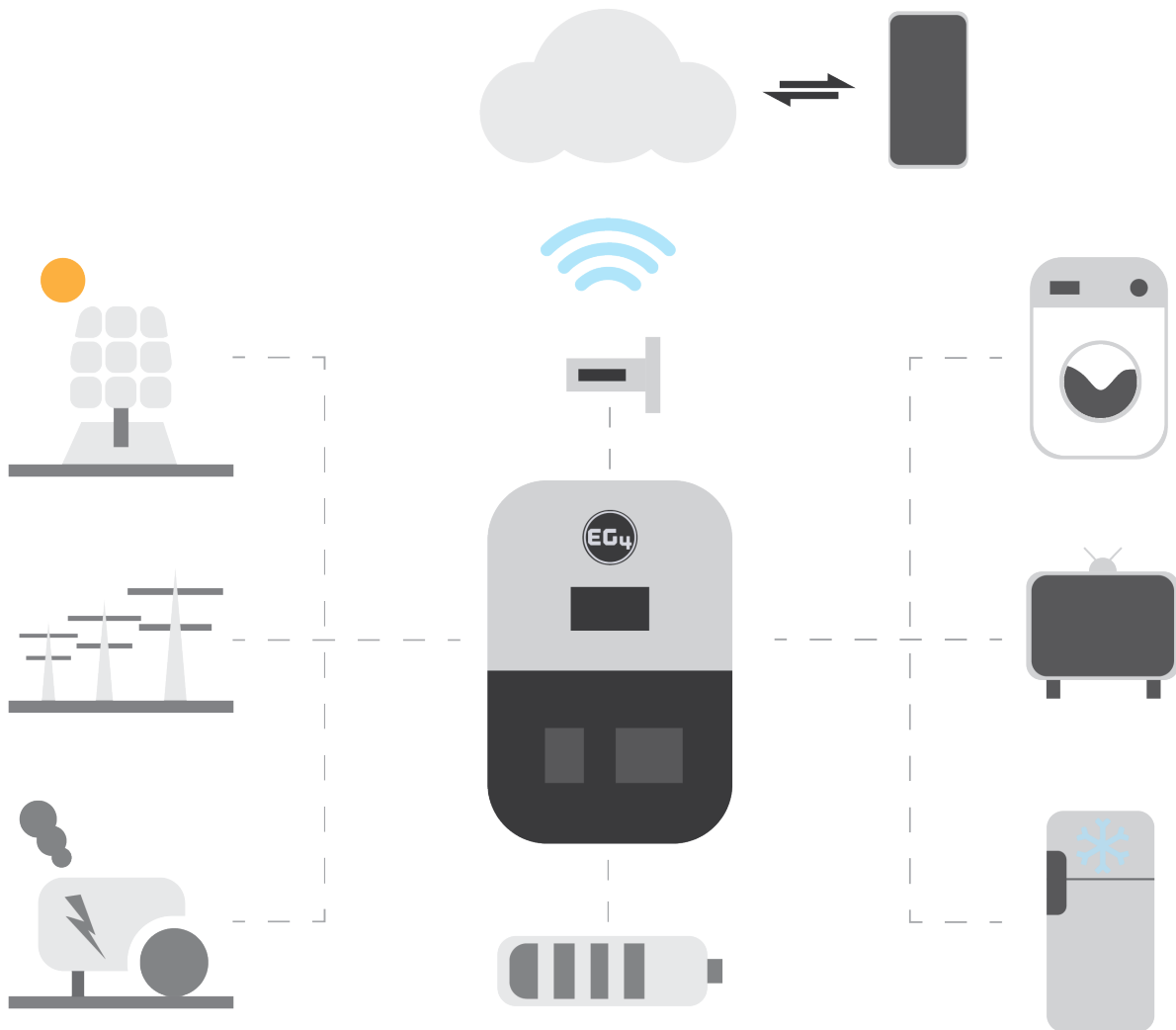

Overview of System Components

The battery module is made up of sixteen "AAA" grade cells, a BMS, a housing, a breaker, and wire. It can be installed in a standard 19-inch cabinet and communicates with external devices via CAN/RS485 as well as with other EG4 batteries via RS485. The modules can be connected in parallel to meet expansion requirements. Inter-battery communications support a maximum of 64 modules for the 6 DIP switch model or 16 modules for the 4 DIP switch model.

This unit contains two aerosol fire-fighting modules inside the battery for safety measures. *

***This image is for display purposes only.
Do not open the battery!
Doing so without proper authorization
will void the warranty!**

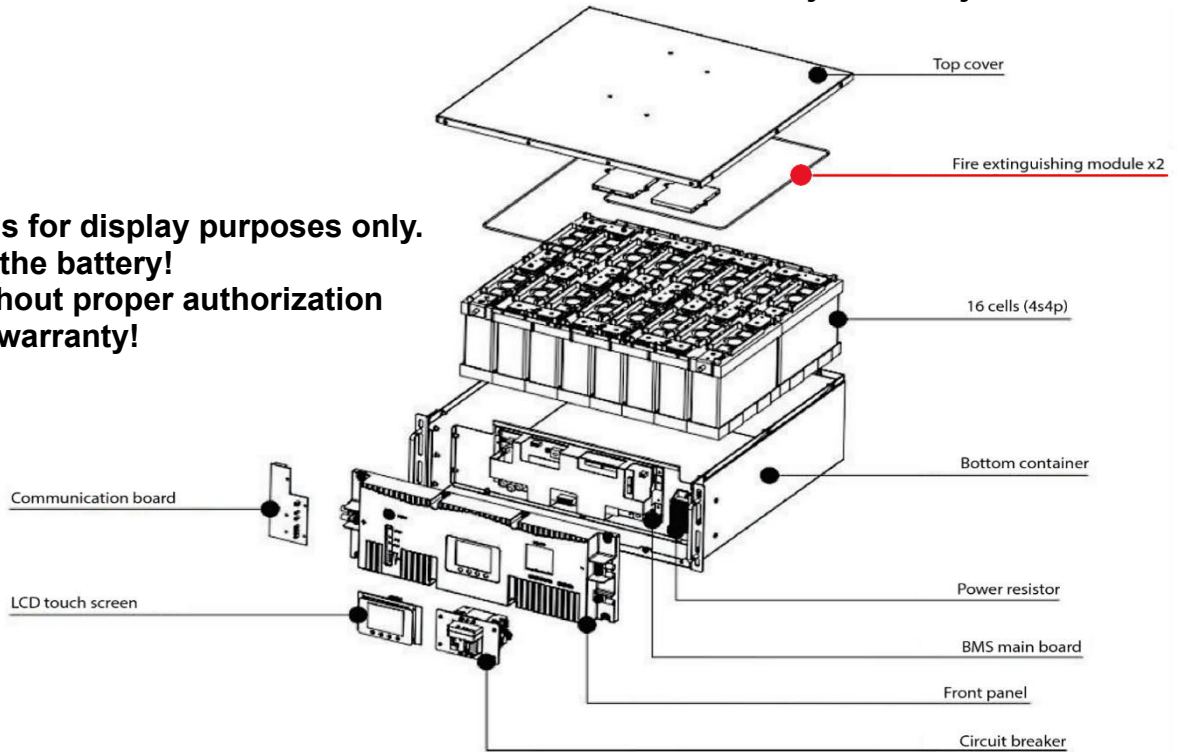

5.1 BATTERY DIAGRAM

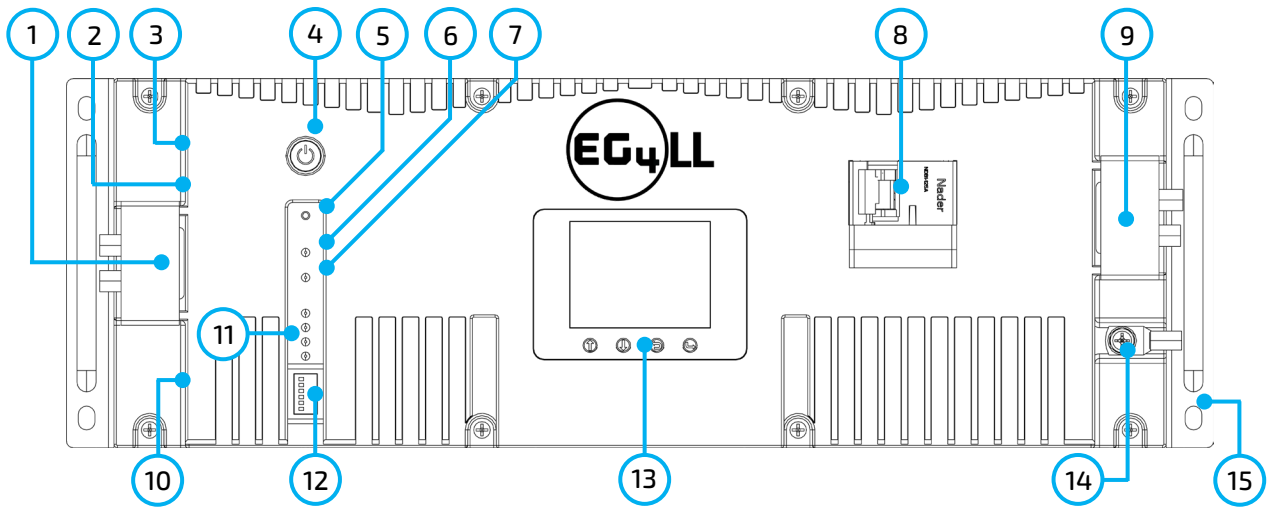

NO.	ITEM	DESCRIPTION	REMARKS
1	Positive terminal	M6 bolt (x2)	-
2	RS485 port	RS485 communication interface	Pin 1 & Pin 8 – RS485_B Pin 2 & Pin 7 – RS485_A
3	CAN port	CAN communication interface	Pin 4 – CAN_H Pin 5 – CAN_L
4	ON/OFF button	Turn BMS on/off	-
5	Reset	Emergency reset	-
6	RUN LED	Operational Status LED	Always on if system is running
7	ALM LED	Alarm Status LED	-
8	Circuit breaker	Shuts down power supply	-
9	Negative terminal	M6 bolt (x2)	-
10	Battery-Comm ports	Parallel battery communication port	Pin 1 & Pin 8 – RS485_B Pin 2 & Pin 7 – RS485_A
11	SOC LED	State of charge LED	4 green lights = full charge
12	ID Board	DIP switch board for BMS	May be 4 or 6 DIP
13	LCD Display	Shows battery information	-
14	Ground screw	Provides safe route for grounding	-
15	Handle	For carrying/handling battery	-

 **NOTE:** During single-battery operation, the battery terminals can connect directly to the equipment

5.2 EMERGENCY STOP (RSD, ESS DISCONNECT)

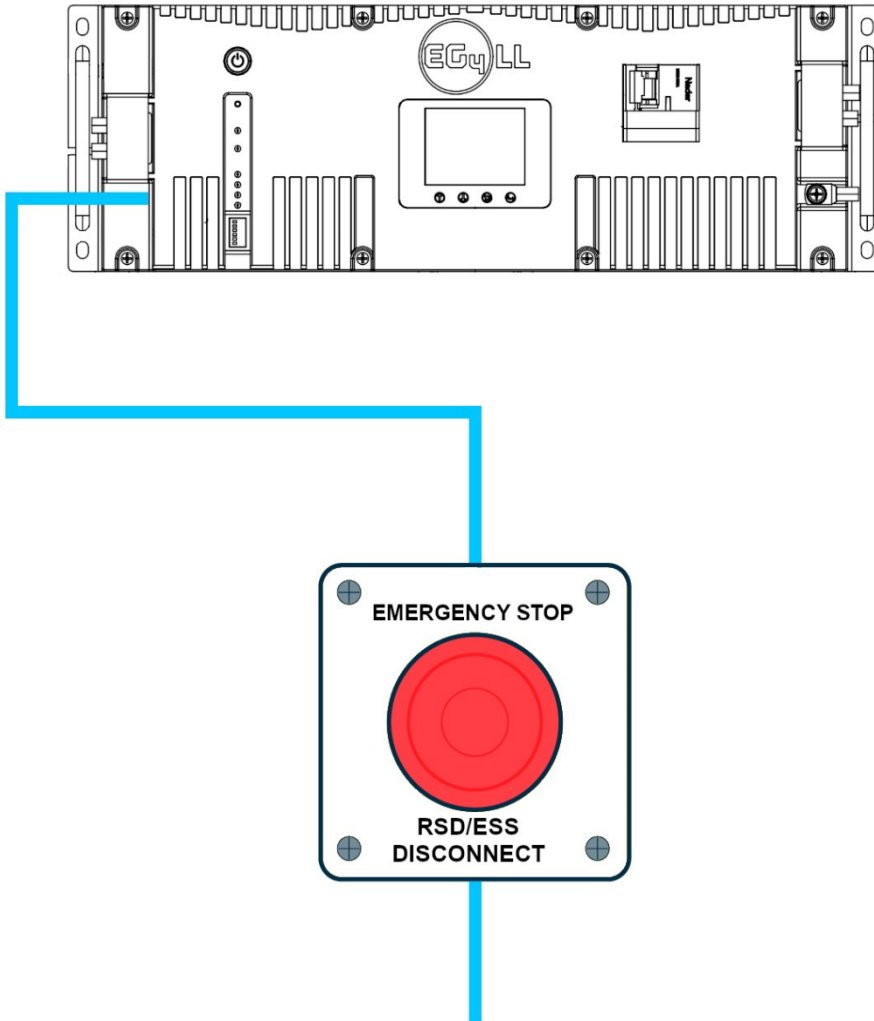

The optional ESS disconnect can be used to shut down all batteries and inverters (if equipped) with the push of a button.

This integrated safety feature ties directly into the battery communication system via an open Battery-Com port using a standard Cat 5/6 ethernet cable.

Pins 3 & 6 are used to communicate the emergency stop information to the batteries once the stop button is pressed.

If the inverter is equipped with rapid shut down (RSD) capabilities, the emergency stop feature can be used to initiate this function. Check with the AHJ and NEC code for compliance.

To inverter, RSD Initiator, or ESS Disconnect
(Inverter recommended if compatible with inverter's RSD system)
Normally Open (NO) or Normally Closed (NC) contacts depending on inverter

6. INSTALLATION

6.1 PACKAGING LIST AND PLACEMENT

When the product is unpacked, the contents should match those listed below:

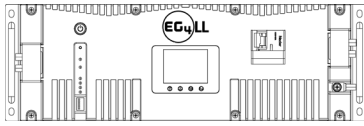

(1) EG4-LL Battery Module

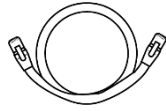

(1) Inter-battery Communication Cable



(1) ea. 6-AWG Pos. and Neg. Connection Cables



(4) M6-1.0 Terminal Bolts

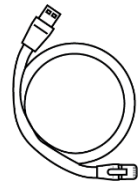

(1) Battery to PC Communication Cable

6.2 LOCATION SELECTION AND INSTALLATION

6.2.1 STORAGE

There are a few steps to be taken to ensure that batteries are stored safely and in a state that will ensure they are not damaged during storage. These are detailed below.

Battery State

The state of the battery when placed into storage will affect how long it can be stored as well as the battery's condition when it is brought out of storage. EG4 recommends that each battery is brought to a 100% SOC (state of charge) before placing it in storage. Lithium batteries will lose a certain percentage of their total charge while in storage, depending on how long they are stored and the conditions they are stored in. EG4 recommends recharging the batteries after 8 – 9 months in prolonged storage.

Environmental Factors

The storage location for the EG4 battery can greatly affect the health of the battery.

For best results, the temperature should remain moderate, between 41°F and 68°F (5°C and 20°C).

Keep the battery away from locations where it may get wet or locations with high humidity (>55%).

Store the batteries away from combustible materials!

6.2.2 REQUIREMENTS FOR INSTALLATION



WARNING: Do not put EG4 LL-S batteries in series! The BMS and internal components are not designed to handle this setup, which could cause the modules to fail leading to damage.

- Avoid exposing batteries to conductive materials, such as water, strong oxidizers, and strong acids.
- Avoid putting batteries in direct sunlight or on extremely hot surfaces.
- Keep all flammable materials out of the working area.
- Use caution when handling batteries and/or battery-powered devices to avoid damaging the battery casing or connections.
- Before using batteries, inspect them for signs of damage. Never use damaged or puffy batteries. Please contact the distributor if a battery is received in this state or experiences this issue.



IMPORTANT: Never position the battery upside down or face down!

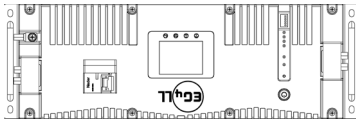

Best

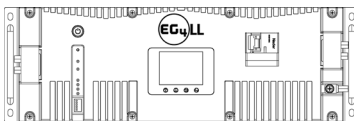

Acceptable

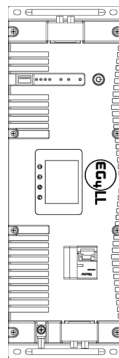

Acceptable



6.2.3 GENERAL INSTALLATION

CABLE SIZE	MIN. INSULATOR VOLTAGE	TORQUE VALUE	MAX RECOMMENDED DISTANCE
2 AWG	600V	60 in-lbs. (~6.8 Nm)	15 ft. (4.6 m)



NOTE: This chart applies for a 100A continuous output (one battery). Where ambient temperature is above 86°F (30°C), cable size must be increased according to NEC 310. **The 6 AWG cable included in the package is intended only for the connection from the module to an EG4 battery rack busbar.**



DANGER: When adding or removing a battery from any rack, cabinet, or busbar, turn off ALL batteries, and use a voltmeter to confirm there is no voltage present. This will prevent users from encountering live (powered) busbars by accident. **Failure to do so can result in severe injury and/or death.**

Tools Needed for Installation

The tools required may vary depending on the mounting location. Typically, the following items are needed to install the battery into an EG4 battery rack solution or general racking:

1. 10mm socket and ratchet
2. Phillips head screwdriver
3. Torque wrench
4. M6-1.0 terminal bolts (*included in package*)

Connecting Cables to the Battery Terminals and Busbars

EG4 recommends using a properly sized (amp rated) busbar to parallel batteries together. Paralleling via the battery terminals will cause inconsistent charging and discharging issues in the bank.

1. Identify the positive and negative terminals of the battery. These are labeled and color coded (red for positive, black for negative).
2. Verify all hardware is on hand to attach the cable properly. Check to ensure the bolt threads fully into the terminal and can be tightened to the proper torque following the table above.
3. Connect the cables to the battery terminals by removing the M8 terminal bolts, inserting them through the eyelet of the proper cable, and reseating the bolt into the terminal block to the correct torque.
4. Connect the positive battery cables to the positive busbar by removing the bus bolts, inserting them through the eyelets of the proper cable, and reseating the bolt into the busbar to the proper torque value. Repeat with all negative cables.
5. **DO NOT** finger tighten the battery terminal bolts. They require a specific torque to ensure they do not loosen during operation. Failure to properly tighten the terminal bolts can result in serious damage and will void the product warranty.

6.2.4 INSTALLATION IN EG4 BATTERY RACK

1. Insert the battery into the rack slot, beginning with the bottom slot and progressing upward. Slide in until the battery is firmly seated in the rack.
2. **Use the included 6 AWG power cable to connect each battery to the busbar.**
3. **DO NOT** finger tighten the battery or busbar terminal bolts. Both require a specific torque [60 in-lbs. (6.8 Nm)] to ensure they do not loosen during operation. Failure to properly tighten the terminal bolts can result in serious damage and will void the warranty.
4. Clearly identify the location of the system's positive and negative terminals—red to the positive terminal and black to the negative terminal—to ensure there are no connection errors. Then connect to the equipment or switch terminals.

Grounding

Attach a grounding wire from the rack/cabinet to an equipment grounding conductor, then terminate the EGC at a grounding electrode.



WARNING: Do not ground rack/cabinet or door to negative or positive bus bars!

In this image, there are 6 EG4 LL-S 48V 100Ah batteries wired in parallel. This battery bank still maintains the appropriate 48V needed for a system. However, the amp hour rating of this bank has increased to 600Ah. In addition, the potential output amperage of the rack increases.



IMPORTANT: Size main battery cables appropriately! Refer to an NEC approved ampacity chart for specifications.

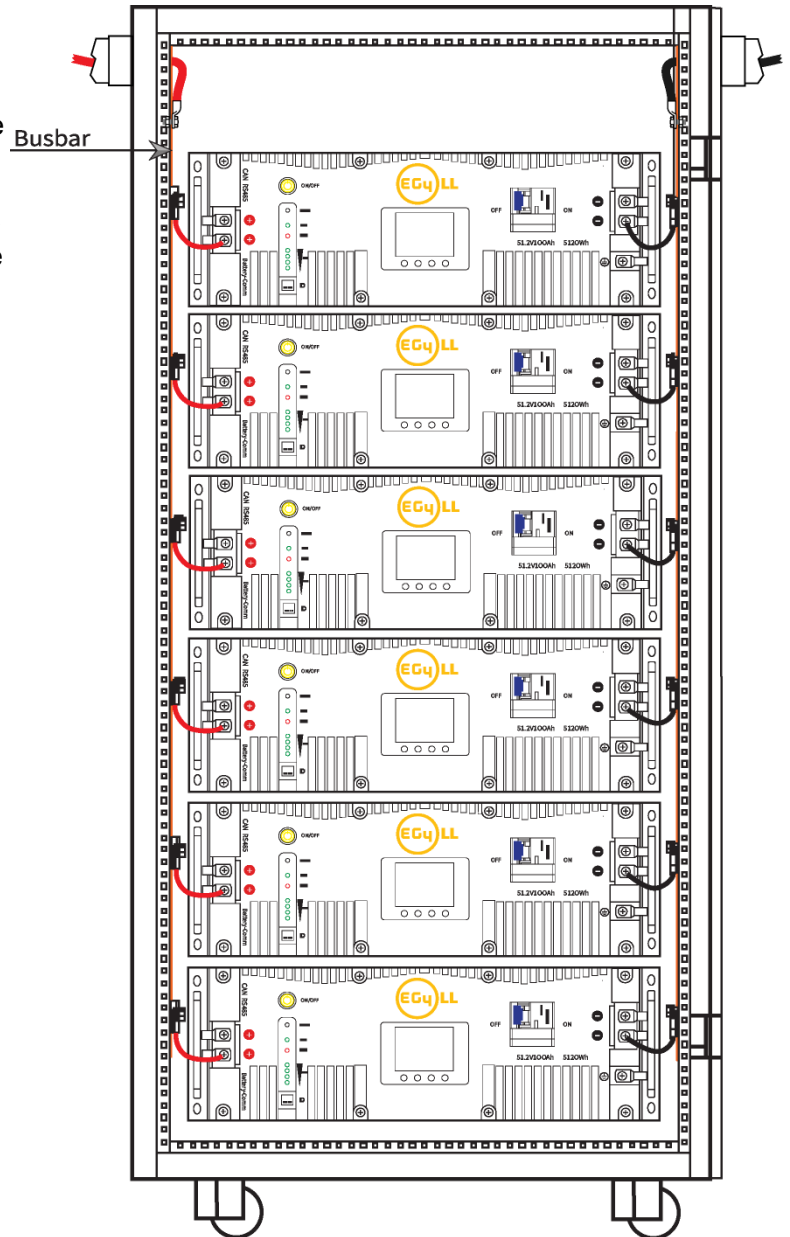

6.3 BATTERY COMMUNICATIONS

Each EG4 battery is designed with the end-user in mind, displaying as much information as possible in the simplest manner. EG4 Electronics includes the option of connecting the battery to PC software to monitor the module status. This allows the user to see and understand exactly what the battery is doing as well as troubleshoot if problems arise.

When a single battery is used, it will communicate directly with the system via the RS485 or CAN port. The battery will connect via a properly pinned battery communications cable (not included).

The communication cable from battery to battery is a standard CAT5 cable. If the included battery to inverter CAT5 cable is not long enough to span the distance from inverter to master battery, please refer to the Communication Cable Pinout Table in Section 6.3.2



WARNING!

Make sure to install the communication cables into their respective ports! Improper installation may lead to component damage!

EG4 recommends double checking all points of connection before introducing power to the system to mitigate any potential issues.

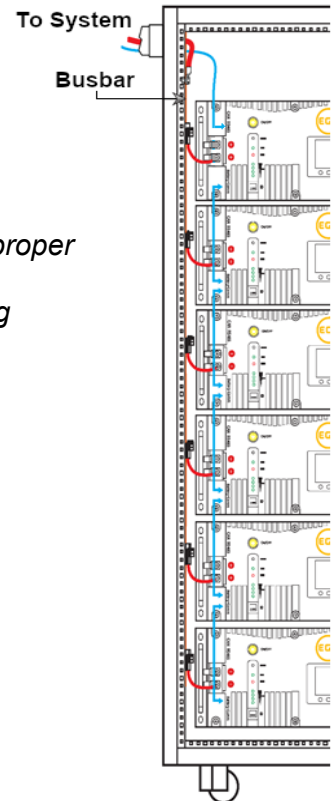

6.3.1 CONNECTING MULTIPLE BATTERIES IN PARALLEL

1. Ensure all battery breakers and BMS are OFF.
2. Set the address code of each battery according to the DIP Switch ID Table (see Section 6.3.2: DIP Switch ID Table), making sure there are no duplicate addresses.
3. Establish communication between the batteries via the “Battery-Comm” ports starting with the top port on the last battery address and terminating on the bottom port of the host.
4. The battery with DIP Switch ID 1 (referred to as the host) connects to the system via communication cable using the RS485 or CAN port. (See image to the right)
5. Power on each battery breaker and BMS ON/OFF switch one at a time beginning with the host battery.

6.3.2 COMMUNICATION CABLE PINOUT AND DIP SWITCH ID TABLES

EG4 LL-S batteries interface with an inverter by designating a “Host” battery (DIP switch ID No. 1). The ID code range is 1–64 (1 –16 for the 4 DIP model), and the communication mode can support up to 64 modules in parallel (16 with the 4 DIP model).



REMINDER: When paralleling multiple batteries, all DIP switch settings **must** be different from each other. This allows all equipment to see each battery in the bank separately.

Communication Cable Pinout & Table*



PIN	DESCRIPTION
1	RS485-B
2	RS485-A
3	CAN Ground (optional)
4	CAN High
5	CAN Low

DIP switch ID table – 4 Pin

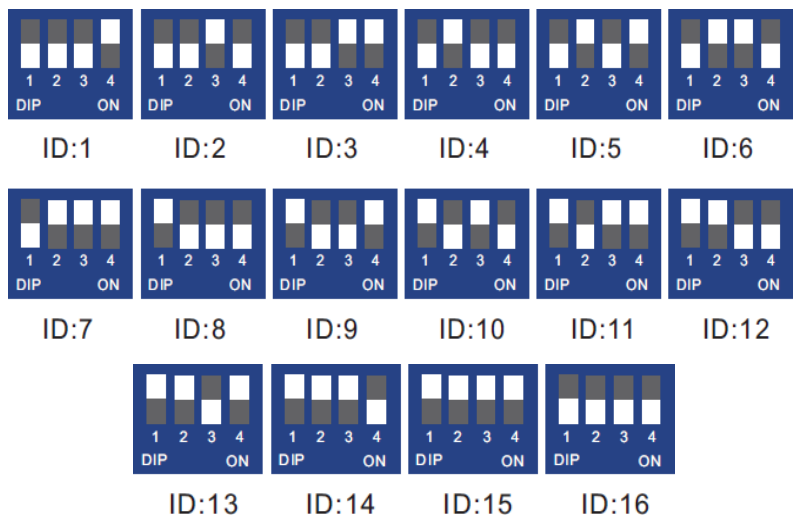

*Pinouts are for battery side;
 please refer to the system
 manual for pinout
 configuration on system end.

DIP switch ID table – 6 Pin

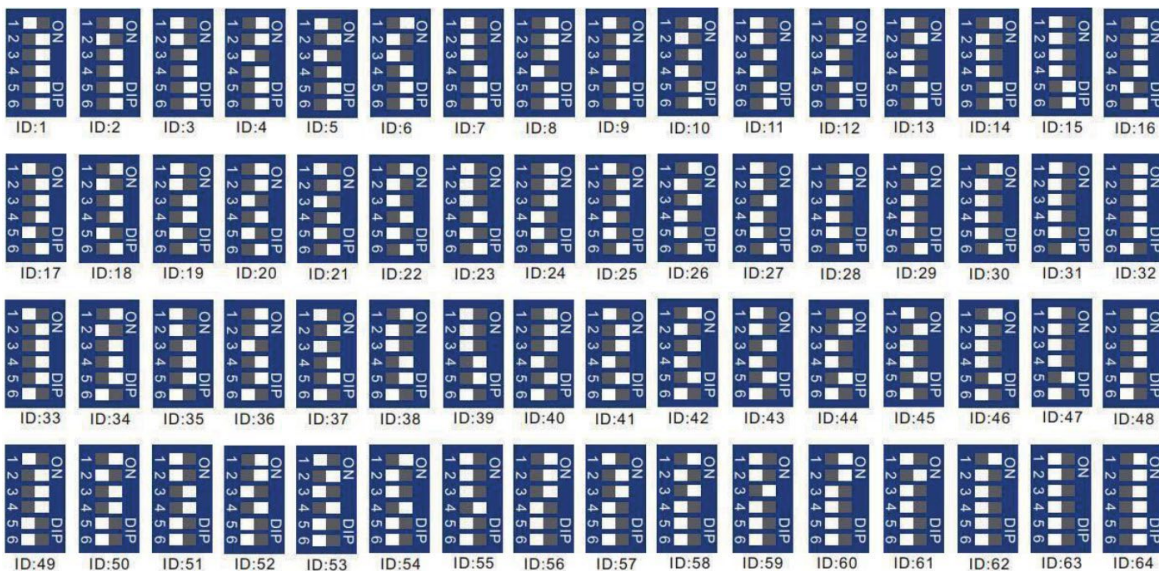

6.4 INSTALLING WITH DIFFERENT EG4 BATTERY MODELS

EG4 LL-S batteries can communicate with all EG4 48V server rack modules. However, the proper firmware will need to be applied to any LL-V1 and/or Lifepower4 modules before installation. Please visit <https://eg4electronics.com/resources/downloads> for the latest firmware.

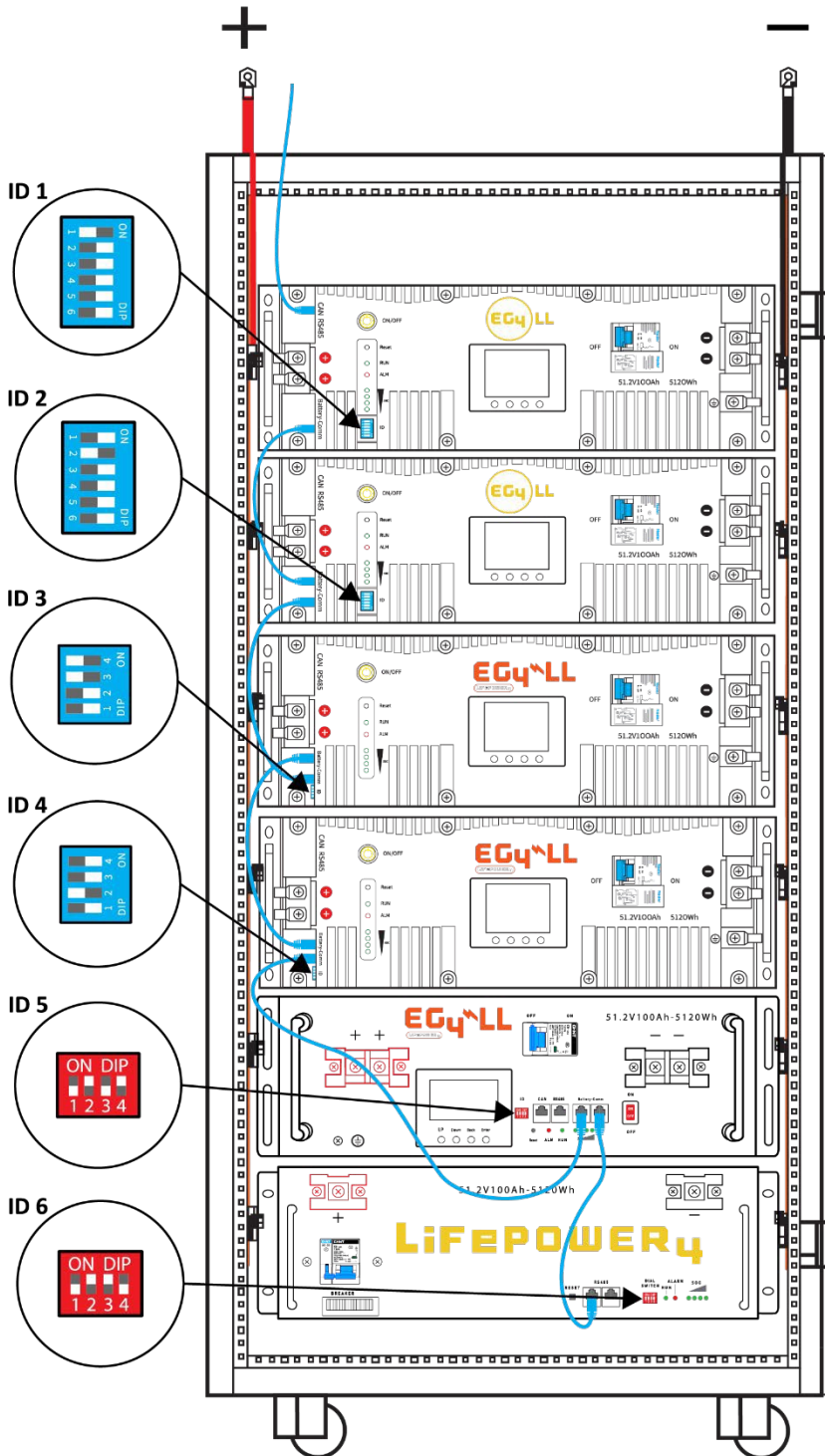

1. **Always use the newest model of LL** at the top of the rack as this will need to be the battery that communicates with the system. This battery is also known as the master and will need to have ID number 1.
2. When installing the batteries, ensure that the same models are grouped together in the bank. This allows for communication to flow between the batteries consistently.
3. After installing the batteries into the rack, refer to the DIP Switch ID table to assign the address code of the bank in numerical order, beginning with the master and progressing among the different models.

The image on the left shows a bank with the following EG4 modules:

1. LL- S (6 DIP) [ID-1]
2. LL- V2 (6 DIP) [ID-2]
3. LL- V2 (4 DIP) [ID-3]
4. LL- V2 (4 DIP) [ID-4]
5. LL- V1 [ID-5]
6. Lifepower4 [ID-6]

7. BATTERY OPERATION

7.1 LCD SCREEN

Each module has a built-in HD LCD touch screen used to display important information about the cells including voltage, current, temperature, and SOC.

7.1.1 BUTTON DESCRIPTION

There are 4 function buttons below the display with detailed descriptions, as shown in the table below.

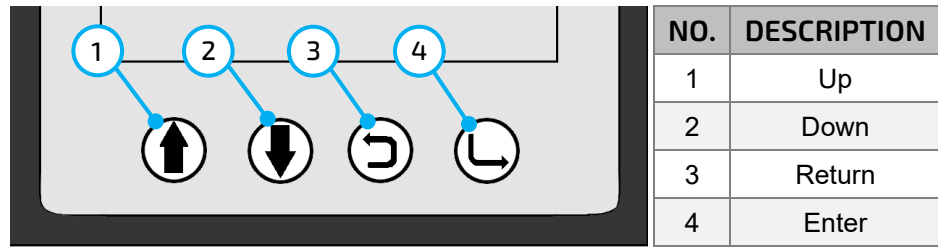

7.1.2 WAKING UP THE LCD SCREEN

Press any key to wake up the screen when the power is on, and the information will appear on the display.

Main Page Information

NO.	MODULE DESCRIPTION
1	Battery Name
2	Status
3	Voltage
4	Current
5	System Date
6	System Time

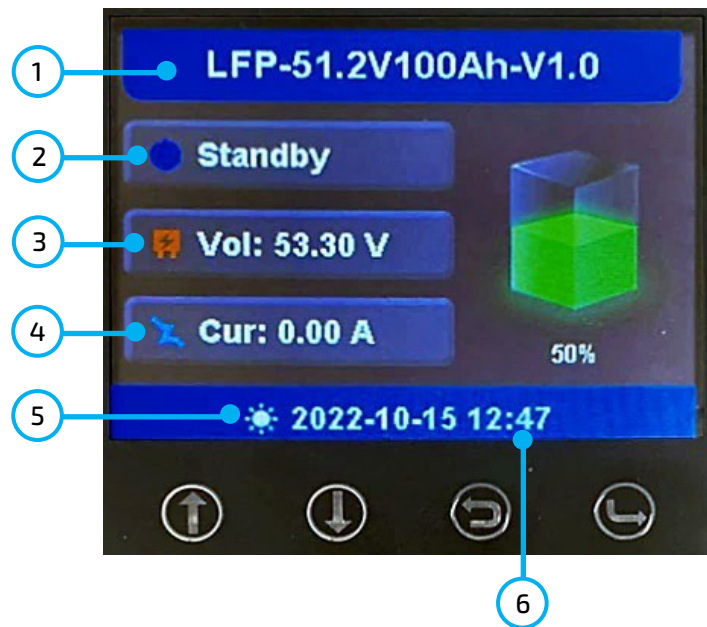

7.1.3 CELL INFORMATION

Check individual cell voltage by pressing the “Enter” button on the main page of the LCD screen (shown in mV). There are 2 pages. Pressing “Up” and “Down” changes the page.



Page 1

Page 2

7.1.4 TEMPERATURE INFORMATION

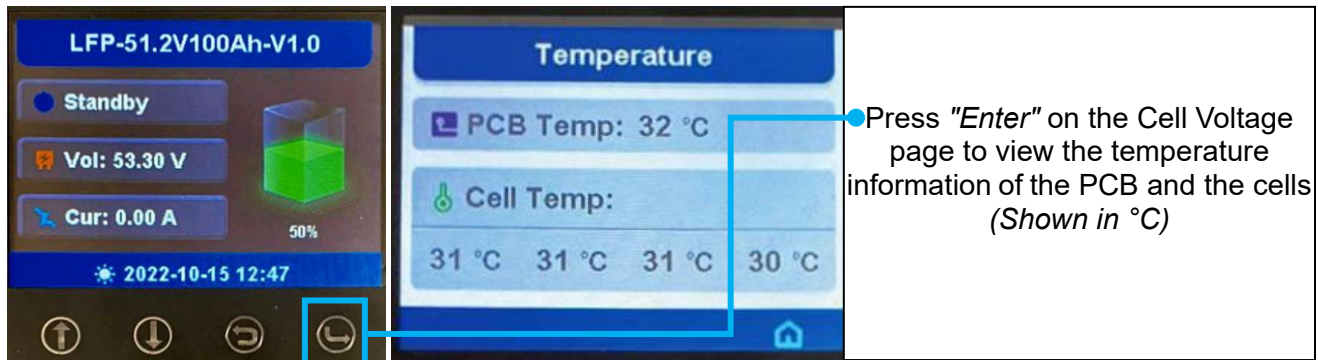

7.2 COMMUNICATION PROTOCOL SELECTION



REMINDER: Only the host battery (Address 1) needs to be set to the inverter protocol; all other batteries must have unique addresses starting at address 2 and ascending in sequential order. The host battery must connect from the CAN/RS485 port to the inverter's (or communication device's) BMS communication port.

7.2.1 PROTOCOL CHANGE/SELECTION PROCEDURE

1. Power off all battery DC breakers and BMS power buttons. **Ensure that the voltage between positive and negative busbars is 0V.**

2. The inverter protocol can only be changed with the host battery temporarily set to address 64 (all dials right) or address 16 for the 4 DIP switch model (all dials down). After the dial is changed, restart the battery's BMS using the power button for the settings to take effect. (See image on right.)

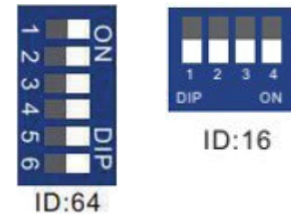

3. On the host battery, press and hold the "Return" key for 5 seconds to enter the "Protocol Setting".

4. Select the corresponding RS485 program or CAN program, and press Enter.

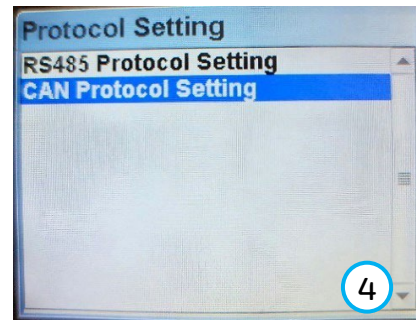
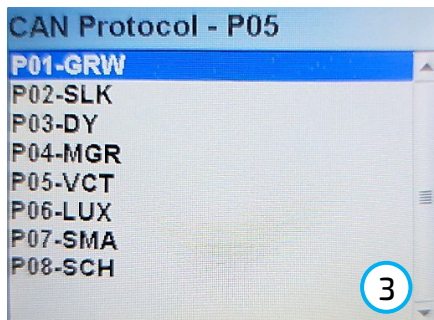

CAN PROTOCOL	INVERTER
P01-GRW	Growatt
P02-SLK	Sol-Ark
P03-DY	Deye
P04-MGR	Megarevo
P05-VCT	Victron
P06-LUX	Luxpower

RS485 PROTOCOL	INVERTER
P01-EG4	EG4
P02-GRW	Growatt
P03-LUX	Luxpower
P04-SCH	Schneider

5. Press the "Return" key to return to the main interface.

6. Change the host DIP switch address back to address 1. (See image on right.)

7. Power cycle the host battery, and the BMS will correspond to the protocol selected.

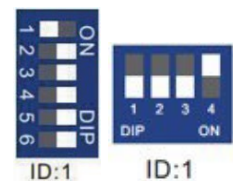

7.3 BMS TOOLS INSTALLATION AND INTERFACING

The PC software “*BMS Tools*” provides real-time battery analysis and diagnostics. The battery cannot communicate with BMS Tools and a closed loop inverter at the same time.

7.3.1 DOWNLOADING AND INSTALLING BMS TOOLS

Visit <https://eg4electronics.com/resources/downloads> to get the latest version of the software. The file can be located on the downloads page underneath the product in question.

Once the file has been downloaded, unzip the .zip file. Once the file is unzipped, refer to the included “Connection guide for BMS Tools V1.0.pdf” for an extensive walkthrough to set up BMS Tools.

If confirmation of the port numbers for battery to PC communications is needed, please consult the following section.

7.3.2 INTERFACING WITH BMS TOOLS

1. Press the ON/OFF button on the battery to power off the BMS.
2. Set the DIP switch ID address of the battery to Address 64 (4-pin DIP, see image A) or Address 16 (6-pin DIP, see image B).
3. Connect the included battery-to-PC USB cable to the PC and to the RS485 port on the battery. (If BMS Tools is running on the PC, close the program before continuing.)
4. Press the ON/OFF button to power on the battery.
5. In the search bar at the bottom of the PC screen type in "Device Manager."
6. Open "Device Manager," and double click on "Ports" to look for the COM port the battery is in. (See image below.)

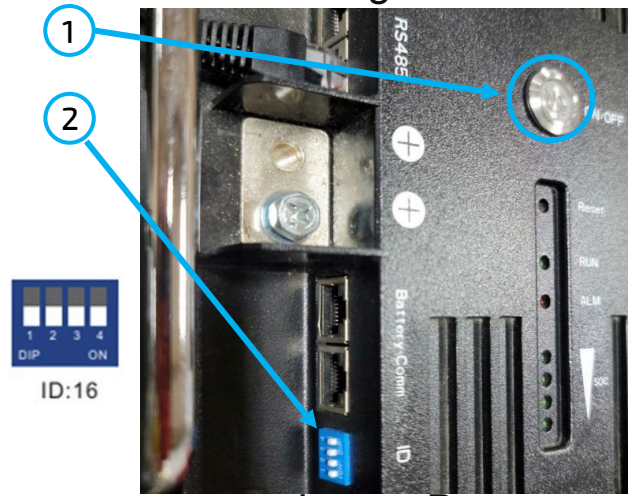
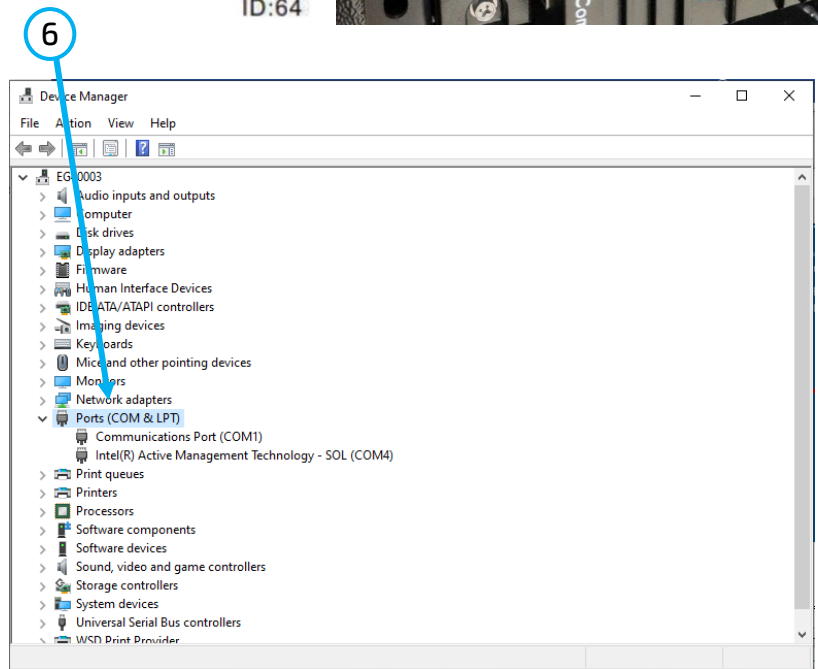
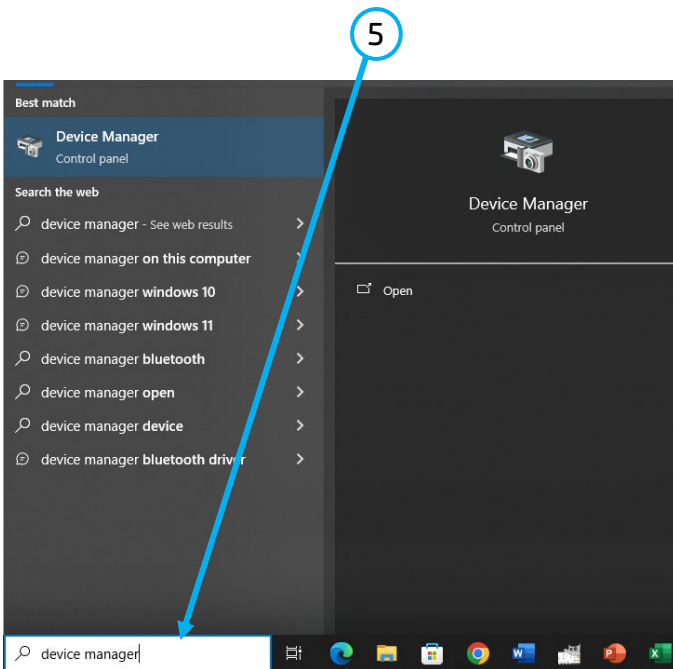
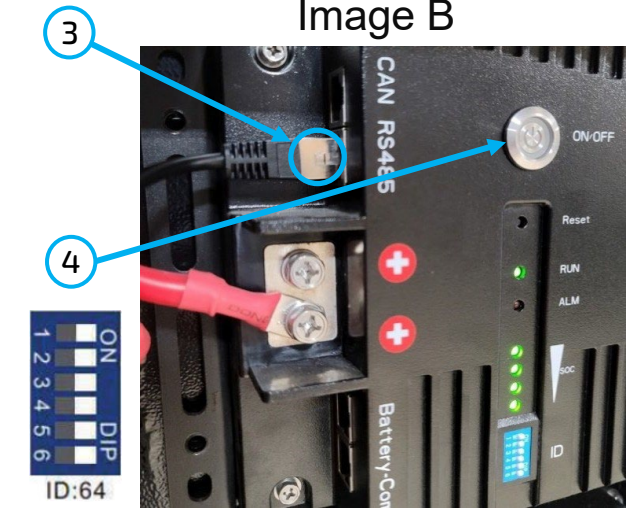
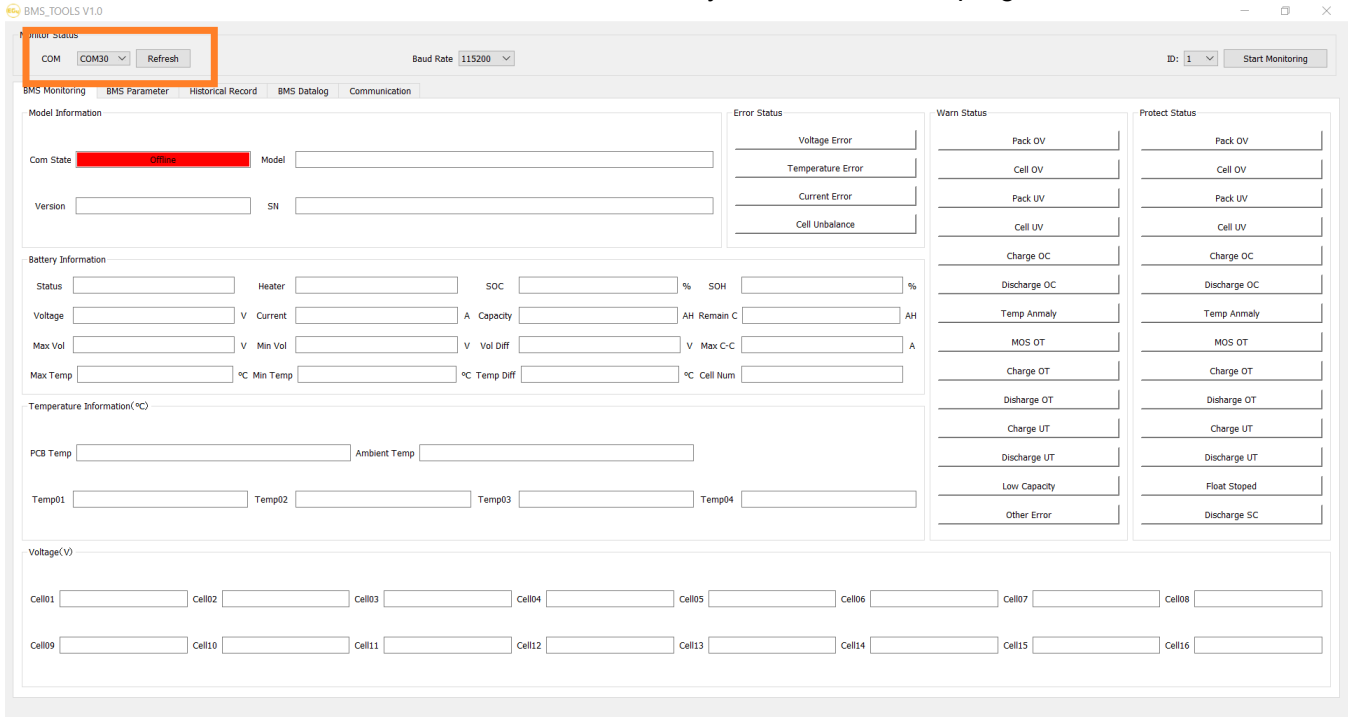

Image B



7. Using an RS-485 (RJ45 Pins 1-B, 2-A) to USB-A cable, connect to the RS-485 port of the battery and then to a USB-A port on a Windows computer.
8. Set the battery's dipswitch to ID: 64. (all dips ON)
9. Power on the battery pack.
10. Confirm the RS485 cable's COM is set correctly in the BMS Tools program.



11. Change the Baud Rate to 9600.

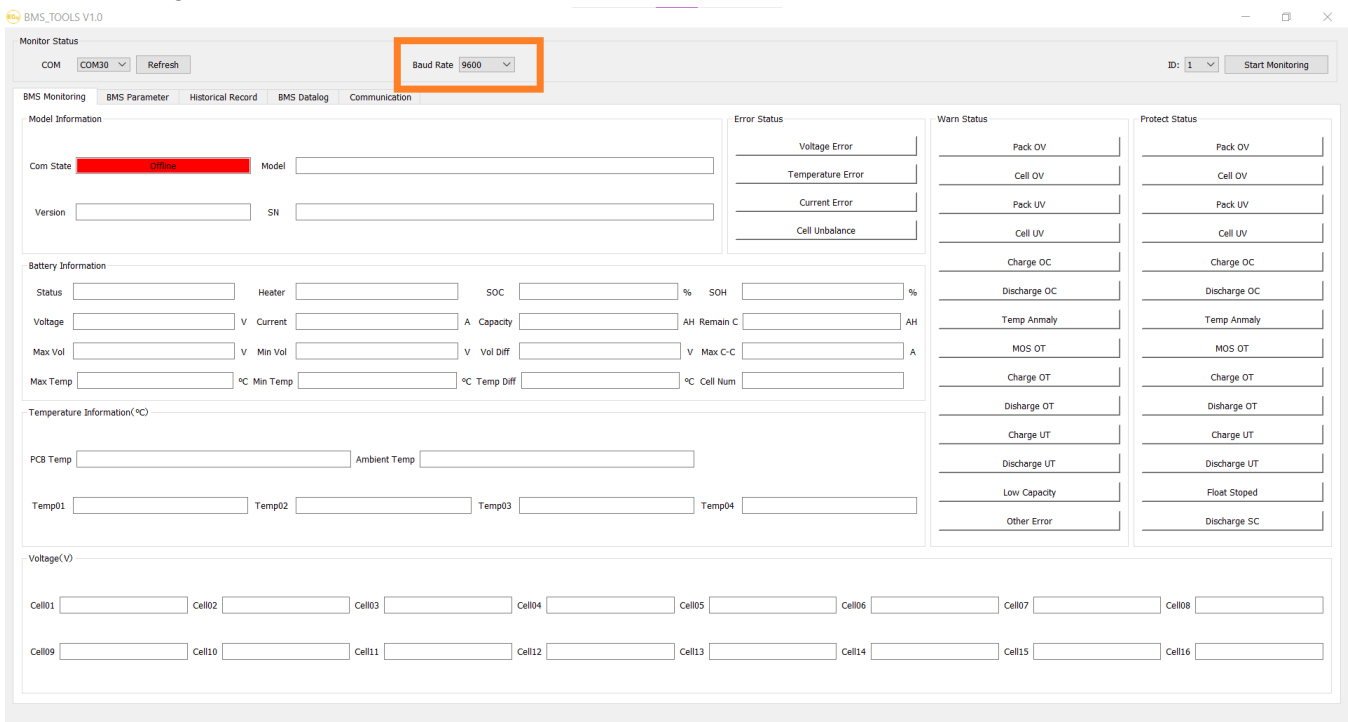

12. Change the "ID" to 64.

BMS_TOOLS V1.0

Monitor Status

COM: COM30 Refresh Baud Rate: 9600 ID: 64 Start Monitoring

BMS Monitoring | BMS Parameter | Historical Record | BMS Datalog | Communication

Model Information

Com State: Offline Model: _____

Version: _____ SN: _____

Battery Information

Status: _____ Heater: _____ SOC: _____ % SOH: _____ %

Voltage: _____ V Current: _____ A Capacity: _____ AH Remain C: _____ AH

Max Vol: _____ V Min Vol: _____ V Vol Diff: _____ V Max C-C: _____ A

Max Temp: _____ °C Min Temp: _____ °C Temp Diff: _____ °C Cell Num: _____

Temperature Information(°C)

PCB Temp: _____ Ambient Temp: _____

Temp01: _____ Temp02: _____ Temp03: _____ Temp04: _____

Voltage(V)

Cell01: _____ Cell02: _____ Cell03: _____ Cell04: _____ Cell05: _____ Cell06: _____ Cell07: _____ Cell08: _____

Cell09: _____ Cell10: _____ Cell11: _____ Cell12: _____ Cell13: _____ Cell14: _____ Cell15: _____ Cell16: _____

Error Status

- Voltage Error
- Temperature Error
- Current Error
- Cell Unbalance

Warn Status

- Pack OV
- Cell OV
- Pack UV
- Cell UV
- Charge OC
- Discharge OC
- Temp Anmaly
- MOS OT
- Charge OT
- Discharge OT
- Charge UT
- Discharge UT
- Low Capacity
- Other Error

Protect Status

- Pack OV
- Cell OV
- Pack UV
- Cell UV
- Charge OC
- Discharge OC
- Temp Anmaly
- MOS OT
- Charge OT
- Discharge OT
- Charge UT
- Discharge UT
- Float Stopped
- Discharge SC

13. Select, "Start Monitoring".

BMS_TOOLS V1.0

Monitor Status

COM: COM30 Refresh Baud Rate: 9600 ID: 64 Start Monitoring

BMS Monitoring | BMS Parameter | Historical Record | BMS Datalog | Communication

Model Information

Com State: Offline Model: _____

Version: _____ SN: _____

Battery Information

Status: _____ Heater: _____ SOC: _____ % SOH: _____ %

Voltage: _____ V Current: _____ A Capacity: _____ AH Remain C: _____ AH

Max Vol: _____ V Min Vol: _____ V Vol Diff: _____ V Max C-C: _____ A

Max Temp: _____ °C Min Temp: _____ °C Temp Diff: _____ °C Cell Num: _____

Temperature Information(°C)

PCB Temp: _____ Ambient Temp: _____

Temp01: _____ Temp02: _____ Temp03: _____ Temp04: _____

Voltage(V)

Cell01: _____ Cell02: _____ Cell03: _____ Cell04: _____ Cell05: _____ Cell06: _____ Cell07: _____ Cell08: _____

Cell09: _____ Cell10: _____ Cell11: _____ Cell12: _____ Cell13: _____ Cell14: _____ Cell15: _____ Cell16: _____

Error Status

- Voltage Error
- Temperature Error
- Current Error
- Cell Unbalance

Warn Status

- Pack OV
- Cell OV
- Pack UV
- Cell UV
- Charge OC
- Discharge OC
- Temp Anmaly
- MOS OT
- Charge OT
- Discharge OT
- Charge UT
- Discharge UT
- Low Capacity
- Other Error

Protect Status

- Pack OV
- Cell OV
- Pack UV
- Cell UV
- Charge OC
- Discharge OC
- Temp Anmaly
- MOS OT
- Charge OT
- Discharge OT
- Charge UT
- Discharge UT
- Float Stopped
- Discharge SC

14. The “Com State” will change from “Offline” to “Online”.
The system will now monitor the battery’s values in real time.

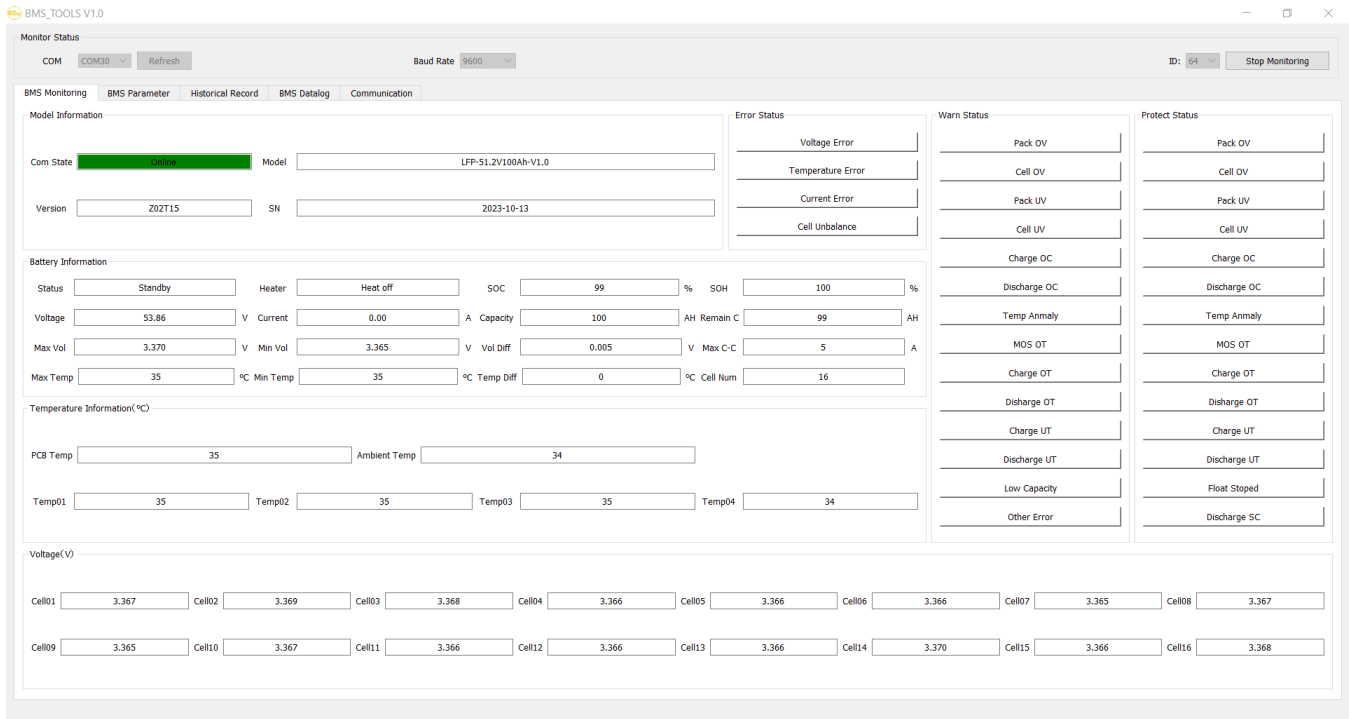

7. To review these steps, scan the QR codes below for a video walkthrough and/or white sheet further explaining the process.



BMS Tools White Sheet



BMS Tools Video Walkthrough

7.3.3 INTERFACE MENU DEFINITION

If experiencing any issues with the battery module or the BMS, please contact the distributor for assistance or troubleshooting steps.

ITEM	DEFINITION
BMS Monitoring	Real-time data and status monitoring of the BMS (<i>see Section 9.2.1: Warning and Protect Status Definitions table</i>)
BMS Parameter	BMS parameter setting management (restricted, unauthorized changes will void warranty)
BMS Datalog	BMS operation data logging to PC (for manufacturer use)
Historical Record	Real-time BMS operation data records (<i>exportable</i>)
Communication	Record of sending and receiving of battery pack data (<i>exportable</i>)

7.4 BATTERY CHARGING

Ensure the proper settings are set on the charge controller and/or inverter being used to avoid overcharging or damaging the module.

(Refer to Section 1: Technical Specifications Table for a full list of charging/discharging parameters.)



IMPORTANT: (SOC Discrepancy)

It is normal for lithium batteries that have their own internal BMS that are wired in parallel to demonstrate a wide variety of SOC readings during any given charge or discharge cycle. **Variations of up to 10% are common.** This is not cause for concern or indication that the module is providing less than the maximum capacity. This can be caused by a few different factors, including variations in wire resistance, internal battery resistance, temperature differences and cell variations. Even a slight variation causes one battery to take more of the load or charge for a short time. Over the duration of the discharge or charge cycle, this will balance out with the lagging battery taking the load or charge at the other end of the cycle resulting in recovering the full listed kWh capacity of the pack. The voltage differences created as batteries diverge in SOC will eventually cause them to converge at some point in the cycle.

8. TROUBLESHOOTING, MAINTENANCE & DISPOSAL

8.1 INTRODUCTION TO THE BMS

The BMS is intended to safeguard the battery and battery cells against a variety of situations that could damage or destroy system components. This protection also aids in keeping the battery and battery cells operational for a greater number of life cycles. Each EG4 LL-S battery is specifically configured to ensure peak performance and operation with any system.

PCB temperature protection

The BMS will ensure that the Printed Circuit Board (PCB) does not overheat. This is the part that houses most of the “brains” of the battery. This feature will turn off the battery if it begins to overheat.

Cell balance protection

Cell balance ensures that each cell is within a specific voltage range of each other. Cell balance is crucial for ensuring that the battery is operating properly for its lifespan. This is always done automatically.

Environmental temperature protection

It may be dangerous to attempt using the battery in extreme heat or cold. Continued operation in these conditions may result in permanent damage to the battery module and its components. To prevent this, the BMS is designed to measure the temperature while charging/discharging and will shut down the battery to prevent damage.

Voltage protection

The BMS is designed to continuously monitor the voltage of each individual cell and ensure that they are not over/undercharged.

Current protection

The BMS is designed to constantly monitor the charge/discharge amperage and has built-in safeguards against exceeding specific parameters. These include built-in timers that shut off quickly in the event of short circuits, extremely high amperage and delayed shut down for amperage that is only slightly above the maximum capacity.

8.2 ALARM DESCRIPTION AND TROUBLESHOOTING

When the ALM light on the battery control panel is on, it means that the battery has given an alarm or has been protected from potential damage. Please check the cause of the failure through the app or BMS Tools and take appropriate measures or go directly to the battery site to troubleshoot. BMS Tools alarms are shown in the table below:

Warning and Protect Status Definitions Table

STATUS	NAME	DEFINITION	ACTION
Warning/ Protect	Pack OV	Pack over-voltage	Module needs to be discharged to lower its voltage.
	Cell OV	Cell over-voltage	Check individual cell voltage in BMS Tools.
	Pack UV	Pack under-voltage	Module needs to be charged.
	Cell UV	Cell under-voltage	Check individual cell voltage in BMS Tools.
	Charge OC	Charge over-current	Incoming current needs to be reduced.
	Discharge OC	Discharge over-current	Discharge current is too high; lower loads.
	Temp Anomaly	Temperature anomaly	Check ambient and module temperature.
	MOS OT	MOSFET over-temperature	BMS temperature is too high. Power off module and cool down location.
	Charge OT	Charge over-temperature	Power off module and cool down location.
	Discharge OT	Discharge over-temperature	Power off module and cool down location.
	Charge UT	Charge under-temperature	Power off module and warm up location.
	Discharge UT	Discharge under- temperature	Power off module and warm up location.
Warning	Low Capacity	Low battery capacity	Module needs to be charged.
Warning	Other Error	Error not listed	Contact the distributor
Protect	Float Stopped	Float Stopped	Contact the distributor
Protect	Discharge SC	Discharge short circuit	Discharge current is too high, turn BMS and breaker off and back on to reset. Lower loads



NOTE: The “Historical Record” tab can indicate what occurred with the module before entering a warning or protection state. It is recommended to export this data into a text (.txt) file to provide to the distributor for any additional troubleshooting assistance.

Other Common Faults and Solutions

FAULT	ANALYSIS	ACTION
Inverter communication failure	Check communication port connection, and battery ID setting.	Input proper "host" battery DIP switch address, and power cycle the battery.
No DC output	Open breaker, or battery voltage is too low.	Check battery breaker or charge the battery.
Power supply unstable	Battery capacity is not at full power.	Check for proper battery cable connection.
Battery cannot be charged fully	DC output voltage is below the minimum charge voltage.	Check the charging settings on the inverter to ensure they match battery requirements.
ALM LED always on	Short circuit	Disconnect the power cable and check all cables.
The battery output voltage is unstable.	Battery management system does not operate normally.	Press the reset button to reset the battery, then reboot the system.
ALM LED flashes 20 times with SOC1 LED on.	Unbalanced voltage within a cell	Deep discharge the battery bank (<20% SOC), then charge battery bank fully.
ALM LED flashes 20 times with SOC2 LED on.	Unbalanced temperature	Contact the distributor.
ALM LED flashes 20 times with SOC 3/4 LED on.	BMS damaged	Contact the distributor.
Different SOC value of batteries in parallel operation.	No issue	Deep discharge the battery bank (<20% SOC), then charge battery bank fully.
Low voltage protection with no LED on	BMS is in low voltage protection, and is in sleep mode	Contact the distributor.
Deeply discharged with "RUN" LED on	The battery voltage is too low to start BMS.	Contact the distributor.



NOTE: *If any of the warnings or faults from both tables persist, please contact the distributor for additional troubleshooting steps.*

8.3 BATTERY END OF LIFE

The EG4 LL-S 48V battery is designed to last for *more than 15 years* when used correctly. We have worked tirelessly to ensure that our batteries will maintain a charge after thousands of cycles. However, when it does come time to retire the battery, there are a few things to consider. Lithium iron phosphate batteries are considered a hazardous material and should not be disposed of by simply placing them in the trash. There are several websites and organizations that will accept this battery to recycle at little to no cost to the user. At EG4, we understand that we are working with customers across the United States and the world. Our recommendation is to go online and search the term "Lithium battery Disposal Near Me." There will likely be an assortment of organizations that can safely dispose of LFP batteries.

We recommend calling ahead of time to ensure that the location is still open and accepting material.

If users are unable to locate a disposal location safely, EG4 is here to help. Before dumping the battery or disposing of it incorrectly, please contact our customer service team for assistance.

9. EG4 10-YEAR LIMITED WARRANTY

EG4 Electronics offers a 10-year Full Parts Replacement or Full Product Replacement Prorated Warranty from the date of battery purchase. The warranty must be registered within the first year of purchase or provide proof of purchase from an EG4 authorized distributor to remain valid. If choosing not to register or cannot provide proof of purchase, the warranty may be invalidated. This limited warranty is to the original purchaser of the product and is one time transferable only if the product remains installed in the original installation location. All parts exchanges, including BMS, are covered during the warranty period. If a full replacement warranty is needed, the warranty is prorated 1/9th per year after the first year at the current retail pricing. Replacement shipping charges may incur on a case-by-case basis. Outside of the continental US, replacement shipping charges may apply. Product that is not purchased through an EG4 approved vendor is not covered under this warranty. A list of approved vendors can be found on the EG4 website. Reselling or removing the product from the original installation site will void the warranty.

Warranty Exclusions - EG4 Electronics has no obligation under this limited warranty for products subjected to the following conditions including (but not limited to):

- Damages incurred during installation/reinstallation or removal
- Poor workmanship performed by an individual, installer, or a firm
- Damages caused by mishandling the product or inappropriate environmental exposure
- Damages caused by improper maintenance or operating outside the specified operating conditions
- Tampering, altering, and/or disassembly of the product
- Using product in applications other than what the manufacturer intended
- Lightning, fire, flood, earthquake, terrorism, riots, or acts of God
- Any product with a serial number that has been altered, defaced, or removed
- Any unauthorized firmware updates/upgrades/patches
- Damages incurred from voltage or current spikes due to open-loop lithium battery communications

EG4 product warranty is a limited warranty – EG4 limits its liability in the event of a product defect to repair or replacement in accordance with the terms of this limited warranty. EG4 is not responsible for any additional or indirect damages that may arise from the malfunctioning of the product. These damages could be incidental or consequential, including without limitation, any liability for the loss of revenue, profits, or time. EG4 shall not be liable for any direct or indirect loss of life, including (but not limited to) bodily injury, illness, or death arising from the misuse or mishandling of the product, whether caused by negligence or otherwise.

Contact the distributor for Return Policy and Warranty Claims.



CONTACT US

support@eg4electronics.com

(903) 609-1988

www.eg4electronics.com