

NGT

USER MANUAL

QR Code for Registration

Attach the
SN Code here

Contents

General Notice.....	4
Precautions.....	5
Safety Notice.....	6
Installation Guide.....	8
Parts Info.....	13
Dashboard Display Info.....	15
Operation Guide.....	18
Battery Use and Maintenance Guide.....	25
DOs and DON'Ts while Riding.....	31
Maintenance and Repair.....	33
Storage Method.....	35
Regular Maintenance Checklist.....	36
Troubleshooting List.....	37
Technical Parameters.....	43
Warranty information.....	46
Service and maintenance.....	49
Maintenance Record.....	51

General Notice

- △ Please read this User Manual carefully for proper operation before riding the scooter.
- △ For your safety, please check whether the parts are in good condition according to this User Manual before riding. Contact your dealer in time in case of any problems.
- △ Please follow the traffic laws. Slow down on slippery roads in bad weather to allow greater braking distance for your safety.
- △ Please pay attention to deep water. It may cause rusting or failure of the motor, battery or other parts if water level reaches wheel axle.
- △ Do not dismantle the scooter on your own. Please contact your dealer for replacement or purchase of original parts.
- △ Do not lend your vehicle to those who can't operate a scooter for others' safety and preventing unnecessary damage to your scooter.
- △ Please keep the User Manual and the Warranty Card properly.

Precautions

△ Rider and Passenger

This vehicle is not designed for a ride of more than 2 persons.

△ Road Conditions

This vehicle is not designed for off-road use.

- △ This user manual should be deemed as a permanent document of this vehicle. If this scooter is transferred to others, this User Manual should also be handed over to the new owner.
- △ Reproduction or reprint of any part of this User Manual is strictly prohibited.

Caution: Do not exceed the speed limit, use the brakes gently to maintain a safe speed while riding downhill.

Attention: Failure to follow the instructions herein may lead to serious casualties, personal injury or scooter damage.

Safety Notice

- △ Using a safety helmet and protective goggles is strongly advised.
- △ You are advised to take proper training or exercise before using on open roads.
- △ Please follow the Operation Guide to fully understand how to properly operate the scooter.
- △ It should be noted that the braking distance in bad weather will be much longer. Please avoid braking on paint markers, manhole covers and oil stains to prevent slipping. Pay extra attention when riding through railway crossings, junctions, tunnels, and bridges. Slow down if road conditions are unclear.

- △ Do not use high beam indiscriminately. Continuous use of high beam may disturb the vision of the drivers and pedestrians.
- △ Do not use mobile phones or other electronic devices which may draw your attention while riding.
- △ Do not change the lane without signaling. Changing the lane at will is one of the major causes for accidents. When you need to change the lane, remember to switch on the Turn Signal Indicator first. Always check the vehicles approaching from behind before changing the lane.

Installation Guide

- ① Insert the key to the main lock and turn to the icon of "OPEN" as shown in the right figure.

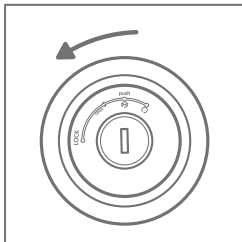

- ② Open the saddle to take out the key box, windshield package (with rubber pads and standard parts), and installation tools.

Insert the key into the keyhole in the rear storage and turn it to open the battery compartment. Take out the charger and rearview mirrors package inside.

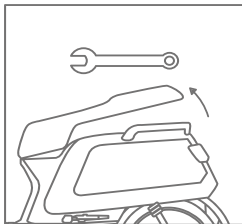

Installation Guide

- ③ Take out the rearview mirrors and check them carefully.

Install the left rearview mirror into the mounting hole on the left brake lever and turn it clockwise. The bolt shall be screwed in for more than 15mm.

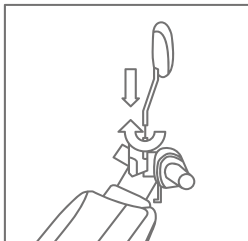

- ④ Adjust the rearview mirrors to an appropriate position and then tighten nuts on the rearview mirror with a spanner. Properly set the dust cover.

Install the right rearview mirror in the same way.

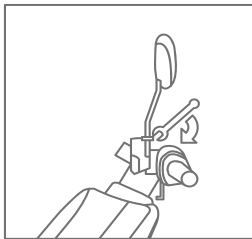

- ⑤ Align the windshield rubber part with the windshield holes and then install it.
- ⑥ Tighten the two screws with the screwdriver to secure the windshield.

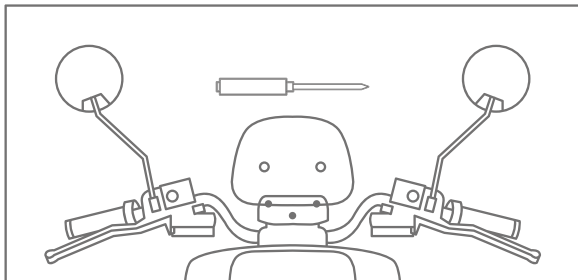

Downloading the APP

Functions such as checking battery level, locating, and management can be implemented on the electric scooter through the app.

- ① Scan the QR code below to download the APP titled Niu E-Scooter.



- ② Run Setup after downloading and register.
- ③ Please scan the QR code on the inside of cover page for app registration.

Note:

The mobile phone system is required to be at least Android 4.0 or iOS 8. Make sure that the mobile phone has been connected to the Internet when running the app (Wi-Fi / 2G / 3G / 4G).

Parts Info

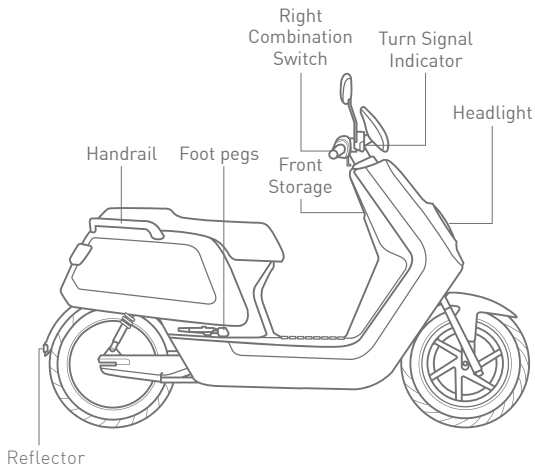

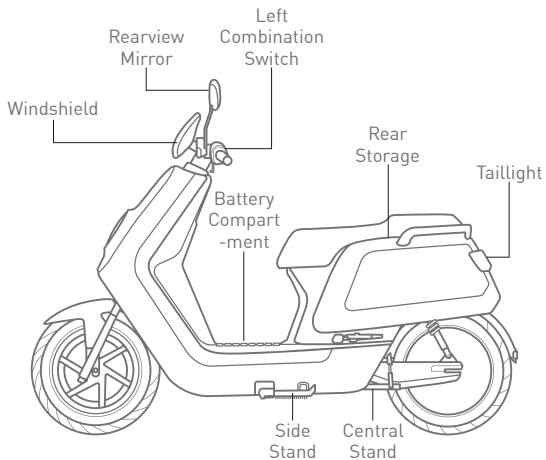



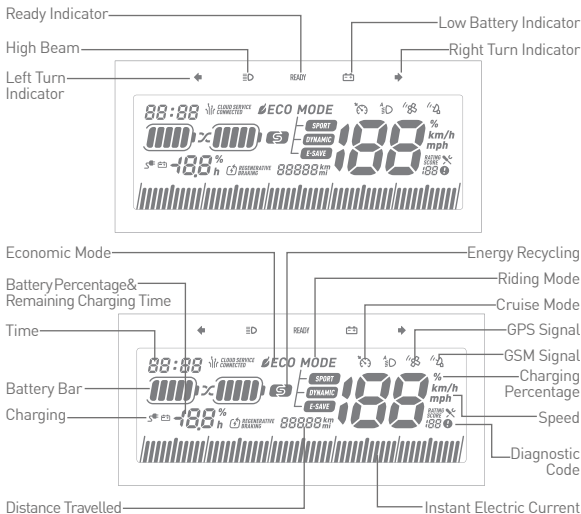

















Dashboard Display Info



Dashboard Display Info

	Left Turn Signal Indicator	The Left Turn Signal Indicator is on.
	Right Turn Signal Indicator	The Right Turn Signal Indicator is on.
	High Beam	The High Beam is on.
READY	Ready Indicator	In Riding Mode.
	Low Battery Indicator	Battery level less than 10%.
	Time	The time now is 10:00
	Economic Mode	Ideal energy consumption status.
	Cruise Mode	The scooter is in Cruise Mode.
30 	Diagnostic Code	The Diagnostic Code is 30. Please see the "Troubleshooting List"
	Energy Recycling Status	Energy is being recycled from braking.
	GPS Signal	No flashing: Signal strong. Bars are flashing: Signal weak. Entire icon flashing: No signal.
	GSM Signal	No flashing: Signal strong. Bars are flashing: Signal weak. Entire icon flashing: No signal.
	Battery Bar	Current battery level is 80~89%.

Dashboard Display Info

	Battery Percentage (Small)	Current battery level is 85%.
	Remaining Charging Time	The remaining charging time is 3.2h (using scooter charging port).
	Charging	Battery is being charged.
	Distance Travelled	Distance Travelled is 802km.
	Instant Electric Current	Indicates instant power output.
	Riding Mode*	Energy Saving Mode Dynamic Mode Sport Mode
	Speed	Current speed is 26km/h.
	Charging Percentage (Large)	Current battery charging progress is 13% (using scooter charging port).

Operation Guide

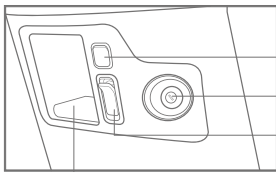

△ Front Storage Area

- ① USB Charging Port
- ② Main Lock
- ③ Hook
- ④ Front Storage

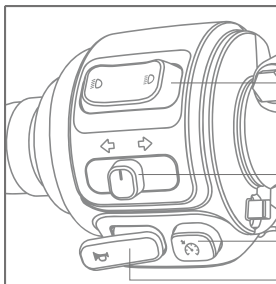

△ Left Combination Switch

- ① High/Low Beam Light
- ② Turn Signal Indicator
- ③ Cruise Mode switch
- ④ Horn

Operation Guide

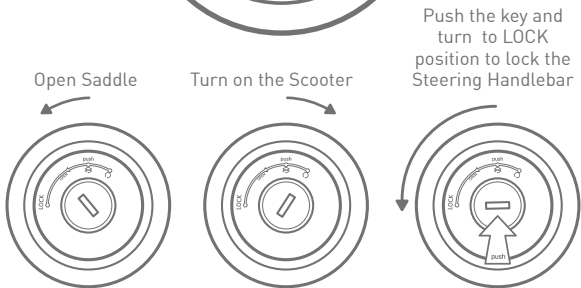
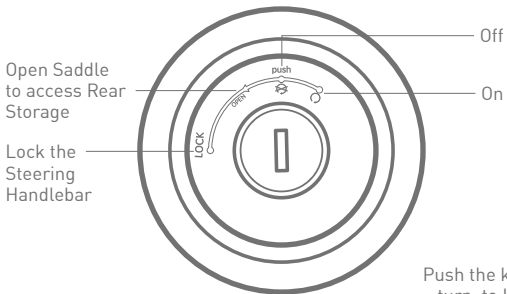

- ① High/Low Beam: Press the right part to switch to the high beam; press the left part to switch to the low beam.

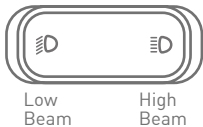

Remarks: To signal overtaking with flashing light, the rider may press and release the left part of the button repeatedly.

- ② Turn Signal Indicator: Push the button left to turn on the Left Turn Signal Indicator; push the button right to turn on the Right Turn Signal Indicator. Press the button to turn off.

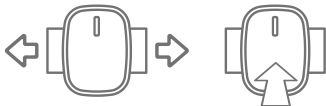

- ③ Cruising Mode: Push the button to cruise at current speed. Press again or brake to turn it off.



Operation Guide

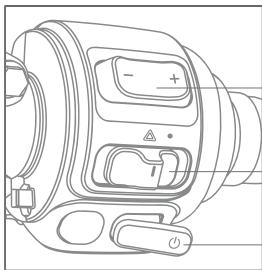

△ Right Combination Switch

① Mode Selector

② Warning Light Switch

③ Start / Stop Button

① Mode Selector: Press right part to switch up the mode. Press left part to switch down the mode.

Switch down



Switch up

- ② Warning Light Switch: Push the switch left to turn on the Warning Light; push the switch right to turn off the Warning Light.

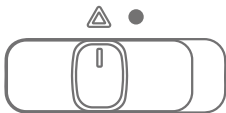

Turn on the Hazard Light



Turn off the Hazard Light

- ⑤ Start/Stop Button: Press and hold the button for 2 seconds to set the scooter in the riding mode. The **READY** indicator on the dashboard will light up and you are ready to go. Press the button again to turn it off.



Operation Guide

▲ Start the Scooter

- ① Press the Unlock button of the remote controller. After the Turn Signal Indicators flash twice, the scooter is unlocked.
- ② After the scooter is unlocked, insert the key into the Keyhole and turn clockwise to  position.
After system diagnostic, hold the brake and press the Start Button for 2 seconds.
- ④ The **READY** indicator will light up. Release the brake and the scooter will be ready to go.

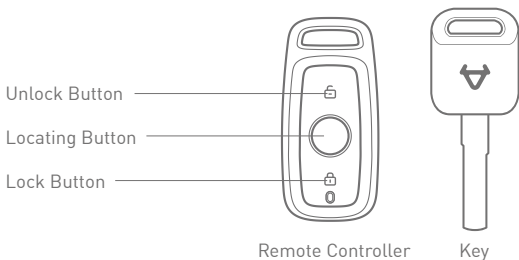

Operation Guide

△ Locking Steering Handlebar

After you reach the destination, unfold the side/central stand to park the scooter. Turn the steering handlebar to the left, then push the key and turn it anticlockwise to LOCK position.

△ Locking with Remote Controller

The scooter can only be locked when the scooter is turned off. Press the Lock Button on the Remote Controller within an effective distance to turn on the Alarm. The Turn Signal Indicators will stay on for 2 seconds after the scooter is properly locked.

△ Locating

Press the Locating Button and the Turn Signal Indicators will flash for 10 seconds. If no further operation during this period, the Alarm will be on for 10 seconds. The Alarm can be cancelled by pressing the Unlock or Lock Button.

Battery Use and Maintenance Guide

△ Using Environment

In order to prevent possible leakage, overheat, smoking, fire or explosion, please follow these instructions:

- ① The battery should be used at the temperature of -10°C to 45°C .
- ② Do not expose to water, beverages or corrosive liquids.
- ③ Keep away from heat source, open fire, inflammable and explosive gases and liquids.
- ④ Please keep metal parts away from the battery compartment.

In case of undesirable odor, overheat or deformation of the battery, please disuse the battery immediately, keep away from the battery and contact your dealer.

Warning: The battery is not a repairable part by the user. In case of battery fault, please contact your dealer. Users dismantling the battery may lead to leakage, overheat, smoking, fire or explosion.

Battery Use and Maintenance Guide

△ Charging Environment

The battery should be charged at the temperature of 0°C to 40°C. The charging time should not exceed 24 hours. Overcharging will shorten the battery life.

Attention: Do not charge the battery below 0°C.

Warning: Using non-original battery chargers may lead to leakage, overheat, smoking, fire or explosion.

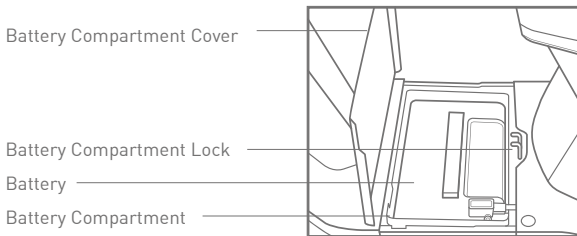

Battery Use and Maintenance Guide

△ Battery charging instructions

The N-GT provides two modes of charging: A vehicle charging mode and an external charging mode.

△ Vehicle charging mode

You can connect the charger to the vehicle charging port at the rear of the saddle box to charge both batteries at the same time. Also the charger can be connected to a single battery of the vehicle to charge; Then the charging indicator on the dashboard will light up and the charging progress will be displayed.

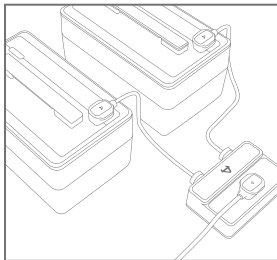
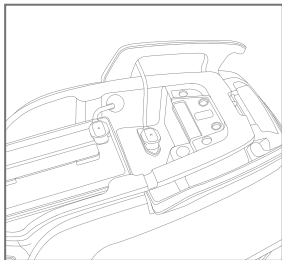

△ External charging mode

Take out the batteries, connect the charger separately and charge one battery after another; or use the double-battery charging adapter box to charge two batteries at the same time. The battery indicator will light up during the charging and the charging process will be displayed.

△ When only one battery powers the vehicle, the maximum speed of the vehicle is the speed at the second gear.

△ Battery indicator light instructions

- ① In the charging state, the current battery power will be displayed. After the battery is fully charged, all the indicators are always on and do not flash.
- ② When the battery is not charging, press the power button and the indicator will show the current battery power.

- △ If the capacity is less than 20%, an indicator will flash three times to remind you to charge.
- △ If all the indicators flash, it means that the battery is being in fault.
- △ Please contact an authorised dealer for further questions.

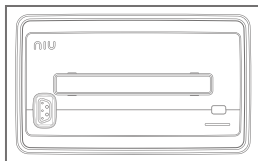

Warning:

- △ All operation should be strictly conform to the user manual. If not, result will be assumed by user.
- △ Must use original charger.
- △ Pay attention to the type of battery and applied voltage. Mixture use is forbidden.
- △ Charging should be in ventilated environment. DO NOT charge in closed space or under high temperature. DO NOT put charger into trunk or tail box while charging.
- △ While charging, connect battery with charger before connect with electric supply. After fully charged, disconnect the electric supply before unplug the battery plug.
- △ When the green light turns on, disconnect the power in time. Avoid long time connection between charger and AC power supply while not charging.
- △ While charging, if the signal light is abnormal, has odor, or the charger is over temperature, please stop charging immediately and check or change the charger in time.
- △ When using and storing the charger, please avoid foreign matter, especially water or other liquid in case of internal short circuit. DO NOT bring charger within scooter, if have to, please make sure of damping.
- △ DO NOT disassemble or change the parts in charger by yourself.

Attention:

- △ If the battery can not be fully charged within 12 hours, please stop charging and contact your dealer.
- △ To maximize the battery life, please keep the battery percentage within 20% to 80%.
- △ For storage, please keep the battery under 40°C to prevent irreversible capacity loss of the battery.
- △ The battery will faster lose capacity in low temperature conditions. To be more specific, the usable capacity is 70% at -10°C, 85% at 0°C and 100% at 25°C.
- △ The best battery capacity performance for storage is 50%.
- △ The battery needs to be disconnected from the scooter for a storage time longer than one week. In this condition, please keep the battery at the temperature of 10°C to 25°C with capacity of 30%-70%.
- △ It's advised to have a charge and a discharge at least once every 2 months to minimize battery capacity loss during storage.
- △ Falling may cause uncontrollable internal damage to the battery and may cause leakage, overheat, smoking, fire or explosion.
- △ The battery needs to take out from the scooter for storage longer than one week.
- △ If there is battery failure due to misuse or lack of proper maintenance as instructed, its warranty will be invalidated.

DOs and DON'Ts while Riding

△ Before Riding

Please check the following details before riding.

Check Point	Description
Steering Handlebar	1) Steadiness 2) Steering flexibility 3) No axial displacement or loosening
Braking	Braking lever has 5 to 9mm idle travel.
Tyres	1) The air pressure range of the front tyre is 20 to 25psi; the air pressure range of the rear tyre is 26 to 32psi. 2) Proper tyre tread depth 3) No cracks or openings
Battery	Adequate for planned distance to travel
Lights	Check all the lights; High Beam, Low Beam, Brake Light, Turn Signal Indicator, etc.
Horn	Check whether the horn can work.

DOs and DON'Ts while Riding

△ Braking Precautions

Adjust the scooter upright before applying brakes.

If the tyres are locked and the scooter lose steering ability resulting from excessive braking force, loosen the grip on the braking lever and the tyres will be working again and the scooter will be stabilized.

Try to maintain a 1:1 ratio of front and rear braking force on slippery roads.

Attention:

Do not exceed the speed limit and apply brakes cautiously. Always use side stand when parking.

Attention:

Inexperienced riders tend to use the rear brake only, which will accelerate the wear of the brake and result in a longer braking distance.

Warning:

Using the front brake or rear brake only is dangerous because of possible grip or control loss. Pay extra attention and use the brakes gently when riding on damp, slippery roads and around corners. Otherwise, riders will be exposed to great danger.

Maintenance and Repair

Users are advised to have the scooter checked and maintained on a regular basis, even for the scooters that are not used for a long time.

△ Regular Maintenance

Maintenance work may only be carried out by an authorised workshop. In order to maintain the warranty, maintenance must be carried out in accordance with the chapter "Service and maintenance".

△ Daily Maintenance

If any problem occurs during checks, please look through the Home Repair Instructions or send the scooter to the dealer's for checks and maintenance.

△ Scooter Washing

Please use neutral detergent and water to wash the scooter. Use soft cloth to wipe the scooter after washing to prevent scratching.

Attention:

If the scooter is frequently used in overload, high-speed, bumpy or up/downhill riding conditions, the maintenance cycle should be shortened. For more guaranteed quality and longer service life, please use original parts, which are under normal warranty.

Warning:

If incapable of repair or adjustment on his/her own, the scooter owner is advised to send the scooter to the dealer's for maintenance and adjustment for the sake of safety.

Always choose a smooth surface road for repair and adjustment and unfold the central stand before repair and adjustment. If it's necessary to repair the scooter during a ride, please mind the traffic.

Warning:

Do not use pressure washer to wash the scooter, especially around the battery compartment. Do not flush the rear inner mudguard, where the charger, controller and other parts are installed behind. If the charging port on the scooter is wetted, please do not charge before the charger dries off. Contacting your dealer is recommended.

Storage Method

△ Short-term Storage:

- ① Keep the scooter in flat, steady, well-ventilated and dry area.
- ② Charge the battery to 50% full before storage to maximize battery life.
- ③ Avoid exposure under sunlight and rain to reduce damage or aging.

△ Long-term Storage:

Remember to have a charge and a discharge at least every 2 months and charge the battery to 50% full before storage to maximize battery life.

Charge the battery to 100% full after long-term storage.

Check all the parts carefully to make sure that there is no problem before riding it. If there's any problem, take the scooter to your dealer for maintenance or repair.

Warning: Please disconnect the battery from the scooter if the time of storage will exceed one month.

Regular Maintenance Checklist

Regular Maintenance Checklist	
Regular Safety and Performance Check	Brakes Check function
	Check headlights and all lamps
	Check horn function
	Check tyre condition
Structural Check	Check lubrication points
	Wheel and Steering Bearing
	Check shock absorber and suspension fork
	Check main and side stands
Major Parts	Check battery charge
	Check main wiring harness
	General visual check

Troubleshooting List

Malfunction Description	Causes	Troubleshooting
No output when switched on	1) Empty battery 2) Alarm failure	1) Charge the battery. 2) Contact your dealer for professional checks
Motor failure when turning the twist grip after switched on	1) Battery voltage is low 2) The power off switch is enabled when pulling the brake lever 3) The Parking Mode has not been turned off yet	1) Charge the battery. 2) Do not pull the brake lever when twisting the twist grip. 3) Check "Start the Scooter" section of this Manual.
Battery charge failure	1) The plug of the battery not properly connected with the battery socket. 2) Battery is overcharged	1) Check whether the plug is loosened. 2) Contact your dealer for professional checks

Troubleshooting List

Malfunction Description	Causes	Troubleshooting
Dropping speed or range	1) Low battery level 2) Under-inflation of tyres 3) Frequent braking and overload 4) Battery aging or normal capacity loss 5) Low battery capacity resulting from low temperature	1) Charge the battery and check if the plug is properly plugged in and whether the charger is damaged. 2) Check the tyre inflation every time. 3) Develop good riding habits. 4) Replace the battery. 5) Normal situation.
Sudden stop during a ride	Empty battery	Charge the battery.
	Identify the fault causes in reference to the meter panel fault codes. Contact your dealer if the troubleshooting methods listed in this manual are not working.	

Troubleshooting List

Malfunction Description	Causes	Troubleshooting
00 displayed	Communication failure or Dashboard failure	1. Disconnect the battery and reconnect it after 30 seconds. 2. Check whether the wires are loosened. 3. Contact your dealer for professional checks.
10 displayed	FOC Controller locked rotor	Stop the scooter and restart later.
11 displayed	FOC Controller undervoltage/ overvoltage	Stop the scooter and restart later.
12 displayed	FOC Controller overcurrent	Contact your dealer for professional checks.
13 displayed	FOC Controller over-temperature	Disconnect the battery and cool it down before reuse.
20 displayed	Motor overtemperature	Stop the scooter and restart when cooled down.

Troubleshooting List

Malfunction Description	Causes	Troubleshooting
30 displayed	Battery overcharged	Turn on the headlight and hazard light to discharge until the code disappear.
31 displayed	Charging overcurrent	Stop charging the battery and check if the charger is failed.
32 displayed	Charging at low temperature	Take the battery indoor until back to normal operating temperature.
60 displayed	SIM card identification failure	Contact your dealer for professional checks.
62 displayed	GPS module failure	Contact your dealer for professional checks.
63 displayed	GPS antenna short circuit	Contact your dealer for professional checks.
64 displayed	GPS antenna open circuit	Contact your dealer for professional checks.
65 displayed	ECU SN missing/incorrect	Contact your dealer for professional checks.

Troubleshooting List

Malfunction Description	Causes	Troubleshooting
67 displayed	SIM card unpaid/ inactivated/low signal strength	Contact your dealer for professional checks.
99 displayed	Electronic components communication failure	Contact your dealer for professional checks.
110 displayed	FOC Controller failure	Contact your dealer for professional checks.
111 displayed	1. The scooter is locked. 2. FOC Controller verification failure	1. Press unlock button on the Remote. 2. Contact your dealer for professional checks.
120 displayed	Motor failure	Contact your dealer for professional checks.
130 displayed	Battery overdischarged	Charge the battery.
131 displayed	Over-current discharging	Stop the scooter and restart later.
132 displayed	Battery overtemperature	Stop riding and let battery cool down.

Troubleshooting List

Malfunction Description	Causes	Troubleshooting
133 displayed	Battery undertemperature	Charge the battery after it reaches the operating temperature range.
140 displayed	Twist grip failure	Please check the wires of the twist grip or contact your dealer for professional checks.
161 displayed	The scooter is locked by remote command	Contact your dealer for professional checks.
190 displayed	Controller communication failure	Contact your dealer for professional checks.
191 displayed	BMS communication failure	Contact your dealer for professional checks.

Technical Parameters

Key Features			
Product Weight	109 kg	Gradeability	Dynamic: 15°
Rated Voltage	60 V	Maximum Designed Speed	E-SAVE: 20 km/h DYNAMIC: 45 km/h SPORT: 70 km/h
Maximum Load	259 kg	Braking Distance	≤4.5 m (30 km/h)
Designed Capacity		2 Persons	

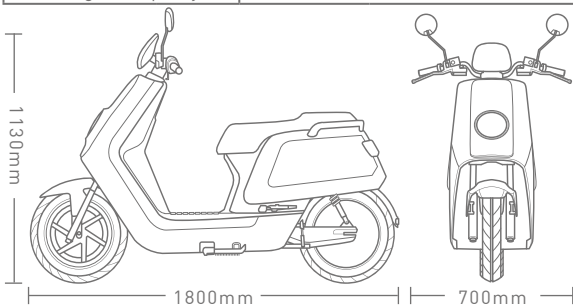

Technical Parameters

Frame	
Front Damper	Telescopic fork
Rear Damper	2x Oil Damping Direct Acting Shock Absorber
Front Tyre Specifications	90/90-12 Rim: 2.15x12
Rear Tyre Specifications	120/70-12 Rim: 3.50x12
Front Brake Mode	220 mm Dual-Piston Hydraulic Disk Brake with CBS
Rear Brake Mode	180 mm Hydraulic Disk Brake with CBS
Minimum Ground Clearance	145 mm
Seat Height	740 mm
Battery System	
Voltage	60 V
Capacity	35 Ah ×2
Standard Charging Current	5 A ×2
Maximum Discharging Current	35 A ×2

Power System	
Motor	Tailored Motor by Bosch GmbH
Motor control mode	FOC Vector Control
Motor rated power	3500 W
Controller Maximum Current	70 A
Electrical System	
Headlight	12V LED
Turn Indicator	12V LED
Taillight	12V LED
Brake Light	12V LED
Meter Panel	12V LCD
Central Control Unit	12V
USB Charging	5V/1A

Warranty information

Please carefully read the instruction manual of your vehicle before operating it in order to make yourself familiar with its handling. We explicitly point out that the instruction, maintenance, and care instructions given in the operating manual have to be complied with in order to sustain your claim towards warranty. Only the strict compliance with customer specifications stated in the instruction manual ensures the prolonging of the natural life of your vehicle.

Starting with the date of the first handover to the end customer a limited warranty of 24 months is granted regarding the accuracy of the vehicle in terms of material and manufacturing according to latest standards. The legal warranty regulations will not be restricted by this limited guarantee. Maintenance work has to be exclusively done by authorized workshops entitled by us. Warranty in general is bound to the region of invoicing and can therefore only be carried out within the country the vehicle was bought. Damages that can be traced back to inappropriate usage, manipulation, or neglecting of the maintenance/care/operating instructions will not be covered by warranty. Warranty can only be granted if occurring damages are immediately reported to the seller or any other authorized workshop

by the buyer. The warranty claim entitles the buyer to remedy deficiencies or to the reparation or the exchange of a damaged part in an authorized workshop after our approval. Compensation for remote or instantaneous damages cannot be granted. Vehicles in desolate condition will not be covered by warranty. Repair works carried out on warranty do not extend the guarantee period. Only this document entitles you to call on warranty services. Therefore please make sure that you are delivered this fully filled in document by the seller and that he has registered your vehicle correctly in our system. Please also mind the following advices.

Body and panelling of the vehicle have to be kept free of dirt constantly. Do not use high pressure water blasters, strong jets of water, sharp and corrosive or other aggressive detergents which could harm surfaces and varnish permanently and foster corrosion. It is vital to use protecting cleansers. Please consult our dealers for the right and appropriate products. Aluminium parts or other refined parts (chrome parts, anodized parts or other processed surfaces) have to be treated with appropriate maintenance products in order to prevent oxidation. Frame and metal parts are continuously to be treated with anticorrosive. A vehicle constantly parked outside has to be covered to avoid weathering and crack formations on seat and

plastic parts. Vehicles used off-road and for racing purposes are excluded from warranty.

Material which is to be used in the context of service and maintenance works are excluded from warranty as well as the following parts (may vary depending on vehicle):

- Lightbulbs
- Brake pads
- Wheel and axle
- Tires

Service and maintenance

Important information

The date for the implementation of maintenance that limit is observed, which is reached first. That means driven kilometer or duration from initial startup.

The warranty can be granted only when the vehicle serviced in accordance with this plan and was not exposed to extraordinary stress.

Warning:

Only perform appropriate works which are intended for your vehicle.

Hydraulic lines should be replaced every 4 years.

From 13000km or the 4. year, the inspection should take place at least once a year or every 3000km.

The vehicle must continuously be checked for rust. The vehicle owner is responsible for rust prevention.

On the following pages you will find the maintenance schedule and the maintenance record.

Maintenance schedule		1000km	4000km or 1. year	7000km or 2. year	10000km or 3. year	13000km or 4. year
COMPONENT	PERFORM					
General inspection	I	✓	✓	✓	✓	✓
Steering and controls	I / E	✓	✓	✓	✓	✓
Steering bearing	I / C / L				✓	✓
Electric System	I	✓	✓	✓	✓	✓
Lights and switches	I / E	✓	✓	✓	✓	✓
Wheel bearing	I / E		✓	E	✓	E
Wheels, Rims	I	✓	✓	✓	✓	✓
Tyres	I*				✓	✓
Brake system generally	I / C / E	✓	✓	✓	✓	✓
Brake fluid	E			✓		
Telescopic fork	I	✓		✓		✓
Shock absorber rear	I	✓		✓		✓
Throttle	I / L		✓	✓	✓	✓
Main / Side stand	I / C / E		✓	✓	✓	✓

I... Control (Inspect) E... Exchange C... Clean L... Lubricate

*Check: Thread depth / Pressure

General information regarding „control“: this component must be checked if the function is correct. Instructions such as „cleaning“ or „lubrication“ mean, that this work must be carried out additionally. If errors / defects are detected, they should be remedied.

Maintenance Record

Date		Mileage	
Notes			
Dealer			

Maintenance Record

Date		Mileage	
Notes			
Dealer			

Maintenance Record

Date		Mileage	
Notes			
Dealer			

Maintenance Record

Date		Mileage	
Notes			
Dealer			

Maintenance Record

Date		Mileage	
Notes			
Dealer			

Maintenance Record

Date		Mileage	
Notes			
Dealer			

Maintenance Record

Date		Mileage	
Notes			
Dealer			

Maintenance Record

Date		Mileage	
Notes			
Dealer			

Copyright © 2018

All rights reserved.

This user manual is copyrighted. Copying in mechanical, electronic or any other form without the written permission of the manufacturer is prohibited.

Distributed by:

KSR Group GmbH
Wirtschaftspark 15
3494 Gedersdorf
Austria

Imported by:

KSR Group GmbH
Wirtschaftspark 15
3494 Gedersdorf
Austria



© by NIU / KSR Group GmbH

V1.2