

www.WheelchairSuperstore.com

KARMAN HEALTHCARE XO-505

INSTRUCTION MANUAL



Power Stand-Up and Recline Power Wheelchair

07/07/2015EC

Contents

XO-505 Series : Parts Explanation	3
<u>Chapter 1. SAFETY TIPS</u>	4
1-1. Standing	4
1-2. Important point to note for operating the wheelchair	5
1-3. Safety information on driving and free wheel mode	5~6
1-4. Rear wheels	6
1-5. Armrests	6
1-6. Power drive attachments	6
1-7. Modifications	6
<u>Chapter 2. UNPACKING AND PREPARING THE STAND UP WHEELCHAIR FOR USE</u>	7
2-1. The original package and accessories	7
2-2. Unfolding the stand up wheelchair	7
<u>Chapter 3. ADJUSTMENT</u>	8
3-1. Adjusting the seat depth	8
3-2. Adjusting the footrest height	9
3-3. Adjusting the footrest angle	9
3-4. The knee support and safety belt and chest belt	10~11
3-5. Adjusting the armrest height	11
3-6. The heel strap	12
3-7. Gas spring	12
3-8. The seat cushion	12
<u>Chapter 4. DRIVING</u>	13
4-1. Before driving for the first time	13
4-2. Taking obstacles	13
4-3. Driving up and down gradients	13~14
4-4. Free wheel	14

<u>Chapter 5.</u>	OPERATION THE STANDING AND SITTING	15
<u>Chapter 6.</u>	CONTROL SYSTEM	16
6-1.	The Dynamic DX2 remote	16
6-2.	Battery and control box connection	17
6-3.	Battery charge	17~18
6-4.	Main Circuit Breaker	18
6-5.	System Lock / unlock & Sleep mode / wake up	19
6-6.	Standard Menu Navigation Drive Mode - Standard	20
6-7.	Accessory Mode – Standard	21
6-8.	FLASH CODES	22
<u>Chapter 7.</u>	MAINTENANCE	23~24

XO-505 Series



01	Headrest	10	Joystick
02	Backrest	11	Front Stick Supporter
03	Armrest	12	Seatrest
04	Side Panel	13	Knee Support
05	Recline Actuator	14	Legrest
06	Footrest Motor/Differential Gear	15	Footrest
07	Anti-Tipper wheel	16	Swing Caster
08	Rear Wheel	17	Front Wheel
09	H-style Belt	18	

Chapter 1. SAFETY TIPS

1-1. Standing

Attention :

Open the master power switch before using. (See Chapter 6 , P18)

- Before using the stand up wheelchair you should supposed to be familiar with the operation and the function.
- Use only standard household and hard even ground. Not use in the ground of dripping wet.
- In case of staircase, the stand up wheelchair must be carried by two persons.
- When rides or leaves the stand up wheelchair , should not put the foot on the footplate, to avoid the dangers.

WARNING:

Maximum weight limit should not exceed





Max Load - 250 lbs. (120KGS)

1-1.1. Standing up stresses your body in ways you may not be used to. Therefore , We recommend you consult your doctor or physical therapist before using the stand-up wheelchair.

1-1.2. Before stand up it is absolutely vital that the knee support, safety belt and Chest belt are fixed correctly.

1-2. Important point to note for operating the wheelchair :

The following action should not attempt to try

	<p>DO NOT DRIVE OVER UNEVEN GROUND!</p> <p>Danger of tipping over!</p>
	<p>DO NOT LEAN OUT OF THE RAISED VERTICALIZER!</p> <p>Danger of tipping over!</p>
	<p>NEVER DRIVE ON ASCENDING OR DOWNWARD SLOPES WHEN THE VERTICALIZER IS RAISED!</p> <p>Danger of tipping over!</p>
	<p>NEVER REACH INTO THE MOVING APPARATUS OF THE RAISED VERTICALIZER!</p> <p>Danger of crushing!</p>

1-3. Safety Information on Driving and Free wheel Mode

Danger of injury if the wheelchair tips over

- Only ever drive downhill at a maximum of 1/5 of the top speed! Avoid abrupt braking or acceleration on gradients.
- If at all possible, avoid driving on slippery surface (such as gravel) where there is a danger of you losing control over the vehicle, especially on a gradient! If driving on such a surface is inevitable, then always drive slower and with the utmost caution.
- Never attempt to overcome an obstacle when on an uphill or downhill gradient!
- Never attempt to drive up or down a flight of steps with your wheelchair!
- Always approach straight on! Ensure that the front wheels and rear wheels move over the

obstacle in one stroke! Do not stop halfway! Do not exceed the maximum obstacle height!

- Avoid shifting your center of gravity as well as abrupt joystick movements and changes of direction when the wheelchair is in motion!
- Never use the wheelchair to transport more than one person!
- Do not exceed the maximum permissible load!
- Note that the wheelchair will brake or accelerate if you change the Driving Mode whilst the wheelchair is in motion!

1-4. Rear Wheels

CURBS, INCLINES AND RAMPS

Always practice with your Healthcare professional or attendant. Before attempting to negotiate curbs, Inclines or ramps alone. It is important for you to develop a safe. Technique that is suitable to your abilities.

WARNING:

Doing a "wheelie"(tilting the wheelchair Backward to its balance point) can be dangerous.

Do not attempt this maneuver without an attendant.

1-5. Armrests

Flip-back Armrests

Never lift the wheelchair by the Flip-back armrests. These parts are detachable and lifting the wheelchair by them may cause damage to the chair or injury to the user.

1-6. Power Drive Attachments

Power stand up wheelchair does not advocate the use of power drive attachments on any MSER series wheelchair. Use of a power drive attachment on MSER series wheelchair alters its intended use. Installation of a power drive attachment is considered an alteration to the frame and voids the warranty.

1-7. Modifications

Marking any unauthorized modifications or using parts not supplied by technical personnel. May change the wheelchair structure and create an unsafe condition voiding the warranty.

Chapter 2. UNPACKING AND PREPARING THE POWER STAND UP WHEELCHAIR FOR USE

2-1. The Original Package And Accessories

The Following Components:

- Power Stand up wheelchair & Joystick & Heel strap & chest belt
- Knee Support
- Charger
- User manual, Oil pot and tool
- Option as order

2-2. Unfolding the Stand up Wheelchair

- Remove any transport straps or transport guards.

Backrest Assembly instructions process as Follows : (Disregard the below procedure if your backrest has already been pre-assembled. Continue with headrest instructions.)



001 Remove any transport straps and move the wheelchair out from carton



002 Grasp the wheelchair at the backrest and pull backward up to stop



003 After the back cushion to stop positive ,Align the hole and tighten screws (Not too tighten)

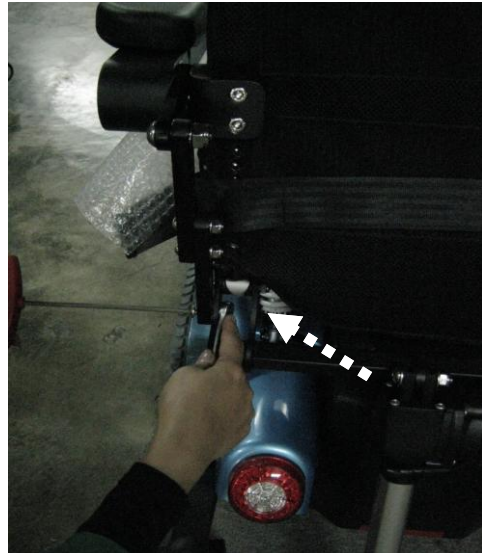

004 Alignment holes and tighten the screw



005 Complete screws locking



006 To assemble the Actuator and tighten the screw (Not too tighten)



007 Use cable tie to fixed cable



008 Use cable tie to fixed cable



009 Use cable tie to fixed cable



010 Use cable tie to fixed cable



011 To assemble head rest



012 To assemble head rest

Chapter 3. ADJUSTMENT

Should you require adjustments and alterations to the mechanism of the wheelchair, or any maintenance work, please contact qualified technicians.

3-1. Adjusting the Seat Depth

- (1) Push the Joystick forward let the wheelchair frame rise . (Fig-7)
- (2) After loosening the left (right) both side screws the seat depth can be adjusted using the different holes at 1 inch distance. (Fig-8 & 9)
- (3) Retighten the left (right) both side screws. (Fig-10)

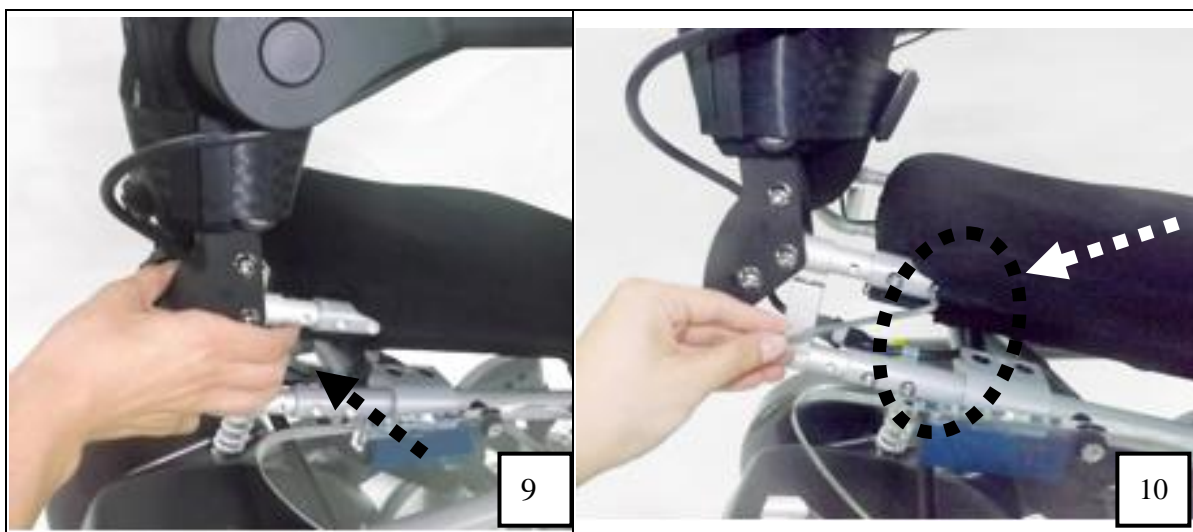
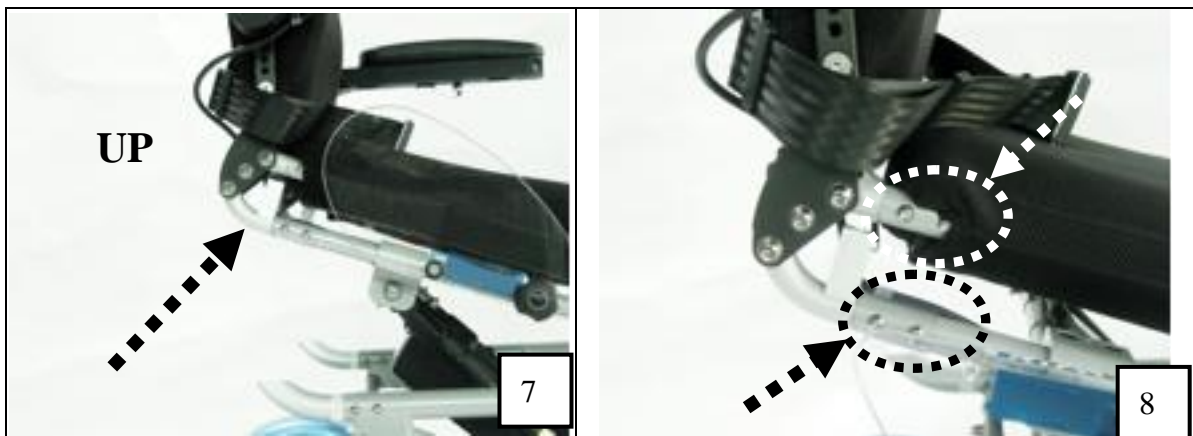

3-2. Adjusting the Footrest Height

The height of the footrest is adjustable and should be altered in line with your body proportions to guarantee the best standing position possible. Footrest adjustment should also take account of your choice of seat cushion. (Fig-11 ~ 14)

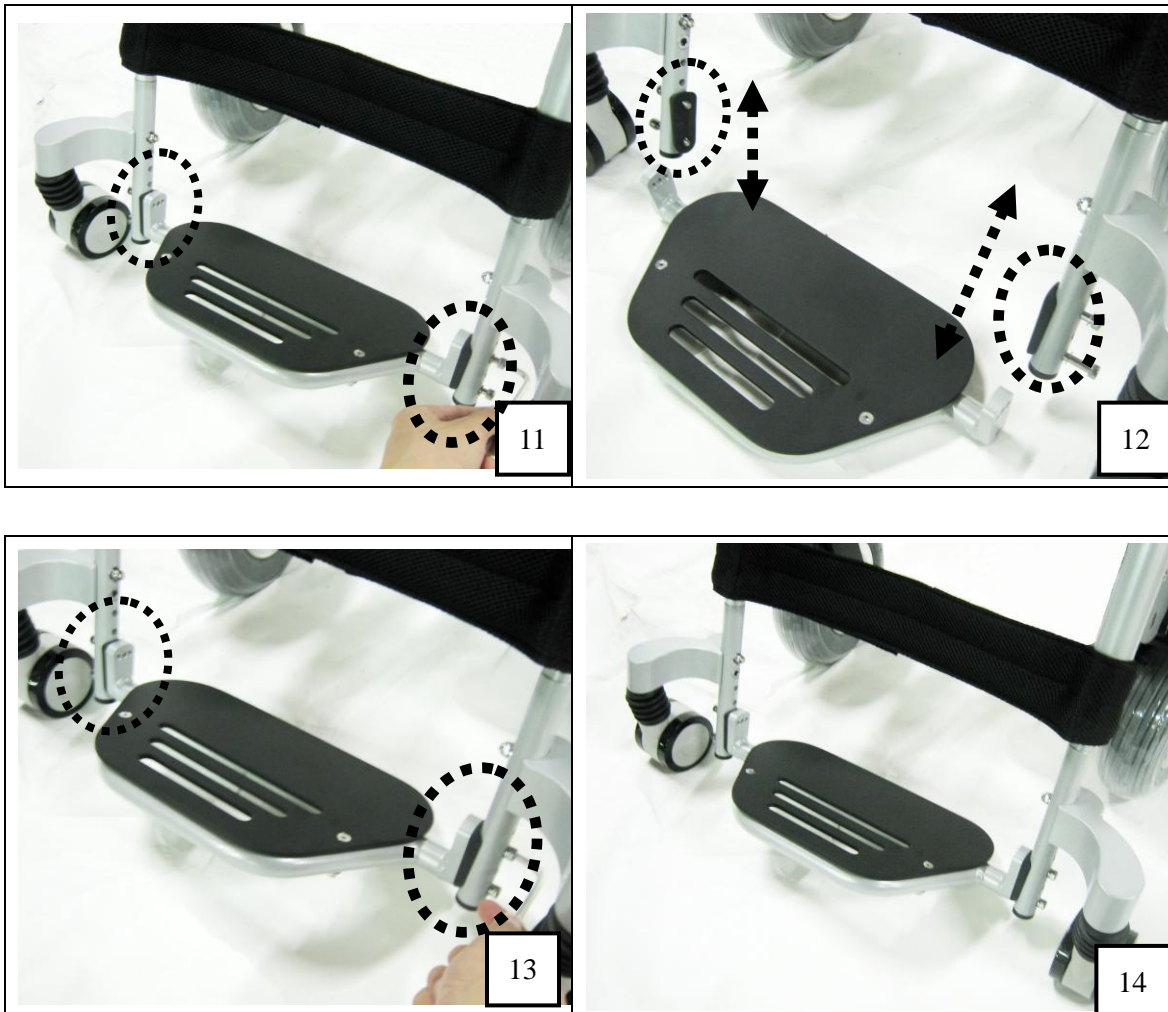

- After loosening the screws the Footrest height can be adjusted using the different holes at 1.8cm distance.
- Retighten the screws.

3-3. Adjusting the Footrest Angle

- After release the screws the footplate angle can be adjusted using the different hole for 3 range. (Fig-15 & 16)
- Retighten the screws. (Fig-17)

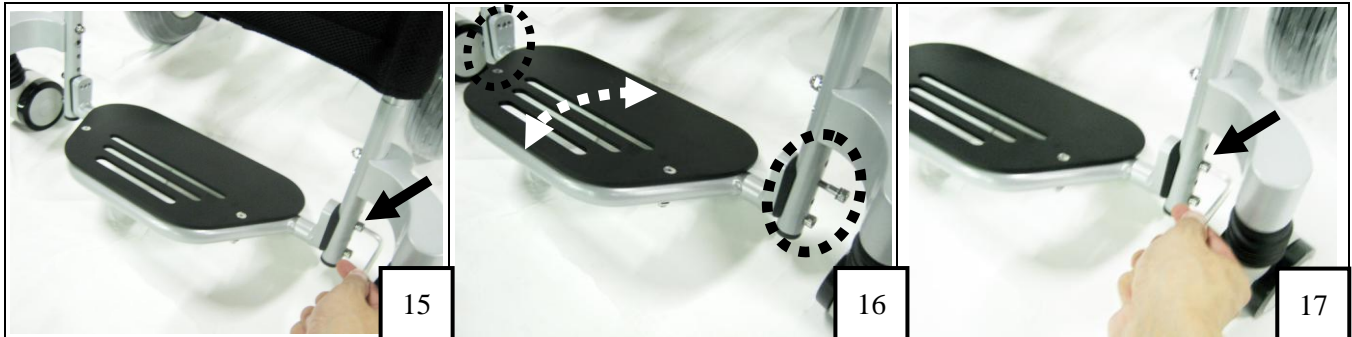

3-4. Adjusting the Knee Support and Safety Belt and Chest Belt

The most important safety features of the stand up wheelchairs are the knee support & safety belt and chest belt. It is absolutely essential that these be correctly in place before you attempt to stand up.

3-4-1. The knee support

The knee support holds the knees in an extended posture and prevents you slipping out the power wheelchair while standing up.

Attach the two triangular form of the knee lock support to the double-head screws on either side of the wheelchair. (Fig-18)



Center the knee support in front of each knee using the Velour fasteners, then pull it until it is sitting firmly in place, just below (not right on) the kneecap and not too tight. (Fig-19)



3-4-2. The safety belt (Fig-20)

- The safety belt holds the waist in place.
- Make sure that the safety belt is secure on the backrest of velour fasten.
- Close the catch on the safety belt and pull it and not too tight.
- To release the safety belt. Simply press the red button in the center of the catch.
- To slacken, hold the catch at a right angle to the belt and pull.



3-4-3 The chest belt (Fig-21 ~ 23)

- Make sure that the chest belt is secure on the backrest of velour fasten.
- The chest belt is hold the upper body.



Once the knee support, safety belt and chest belt are fitted correctly you are ready to stand up.

3-5. Adjusting the Armrest Height

- (1) Release the left (right) screws can be removed to suit position. (Fig-24)
- (2) Retighten the screws .(Fig- 24)

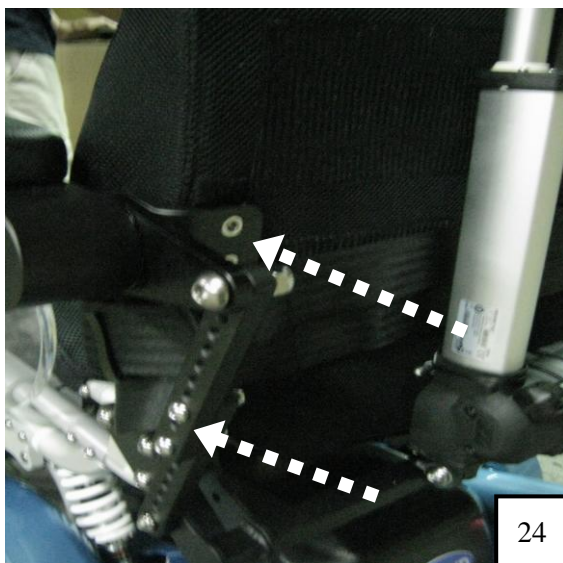

3-6. The Heels Strap (Fig-25)

The purpose of the heel strap is to prevent the legs and feet slipping backwards. It is fitted behind the heels or higher. By making use of the Velour fastening. It is possible to alter the length of the strap and thus to ensure the ideal position for the feet on the footrest. Ideal positioning of the feet is vital in ensuring a good standing position.



3-7. Gas Spring

The gas spring are specially design to help hold your body weight in the balance and safety.

NOTE: Contents under pressure. Do not take apart, puncture and apply heat or fire.

3-8. The Seat Cushion

There is a choice of various different seat cushions, governed by your individual needs. The Velcro fasteners fitted to the surface of your seat should allow you to attach the majority of set cushions securely. The Velcro fasteners prevent the cushion from slipping out of place even when you are standing up. The height of the footrest should be adjusted to take into account the height of a given seat cushion.

Remove the Seat Cushion

Flip-back the side panel. (Fig-28) can be Remove the Seat Cushion (Fig-26 & 28)



Chapter 4. DRIVING

4-1. Before Driving for the First Time

Before you take your first trip, you should familiarize yourself well with the operation of the vehicle and with all operating elements. Take your time to test all functions and driving modes.

Attention:

- You are within easy reach of all operating controls.
- The battery charge is sufficient for the distance intended to be covered.
- The restraining belt is in perfect order.

4-2. Taking Obstacles

Your electric wheelchair is able to overcome obstacles and curbstones to a maximum height of 5 cm.

WARNING:

- Never approach obstacles at an angle!
- Put your backrest into an upright position before climbing an obstacle!
- Never drive over obstacles with an erected vertical.

4-3. Driving up and down gradients

Your electric wheelchair has a maximum tilt-resistant climbing ability of 10 degrees.

WARNING:

- Only ever drive downhill at a maximum of 1/5 of the top speed.
- Avoid sudden changes of direction or abrupt braking when driving on slopes.
- Always return the backrest of your seat to an upright position before ascending slopes. We recommend that you position the seat backrest slightly to the rear before descending slopes.
- If the lifter is raised drive mode is only used for positioning and not for regular drive operation. Lower the lifter before ascending a slope.
- Never attempt to ascend or descend a slope on slippery surfaces or where there is a danger of skidding.
- Avoid trying to get out of the vehicle on an incline or a gradient.
- Always drive straight in the direction the road or path you are on goes, rather than attempting to zigzag.
- Never attempt to turn around on an incline or a slope.

DANGER:

- When the vertical is raised drive operation only serves positioning and not normal driving.
- Never driver over uneven ground, on an upward or downward slope obstacles when the vertical.

4-4. Free Wheel

Because the motors are designed to engage the electromagnetic brakes when the vehicle is not in use or when the power is OFF. There is also a manual feature that allows them to “free-wheel”. Free- wheeling is accomplished by pulling the free- wheeling levers to the free-wheeling position. (Fig-29) Combined with clutch. (Fig-30)

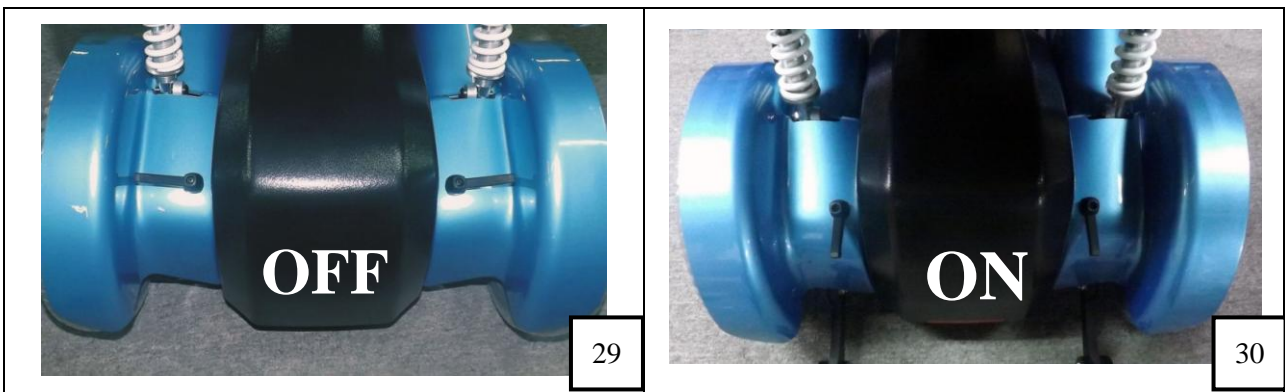

WARNING:

- Never free-wheel your power wheelchair on a slope.
- Never free-wheel the motors while operating your vehicle.
- Always remember to engage the motors before turning the power back ON.

Chapter 5. OPERATION THE STANDING AND SITTING

1. First, adjusting and fixed the knee support to suit position and make sure the two triangular form of knee support lock to the double-head screws of frame.
(Fig-31 & 32)

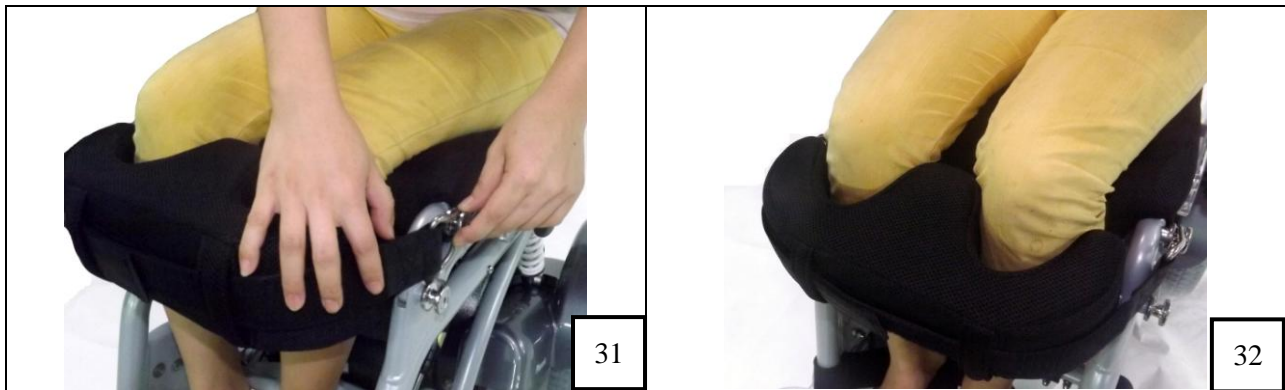

2. Fixed the safety belt and chest belt. (Fig-33)



3. Push the Joystick of wheelchair forward is operated for stand up.
4. Pull the Joystick of wheelchair backward is operated for sitting down.

Note:

- Please make sure your hand not under the stand up mechanism.
- Make sure not children in the wheelchair back.
- Once the knee support, safety belt and chest belt are fitted correctly you are ready to stand up.

Chapter 6. CONTROL SYSTEM

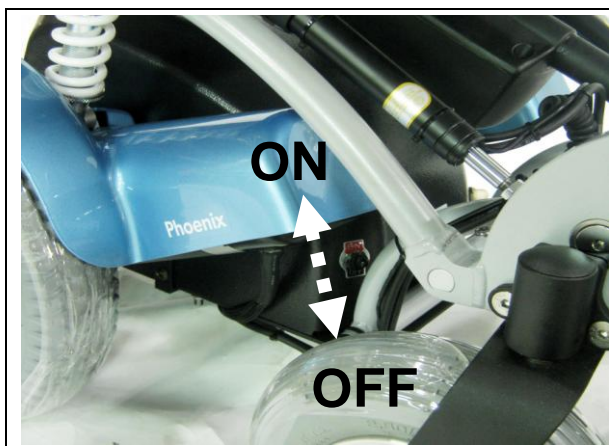

Master power switch

※ Open the master power switch before using.

6-1. The Dynamic DX2 Remote

Assembly of the remote

1. ON/OFF
2. Left indicator button
3. Function keys I
4. Drive Profile selection+
5. Drive Profile selection-
6. Horn
7. Joystick
8. Accessory Mode selection
9. Accessory Mode selection
10. Function keys I I
11. Screen
12. Right indicator button



Lower side

1. Combined charging socket / programming socket



6-2. Battery and Control Connection

The main electrical control system is composed of motor, Control box battery and controller. The connection of control system as below.

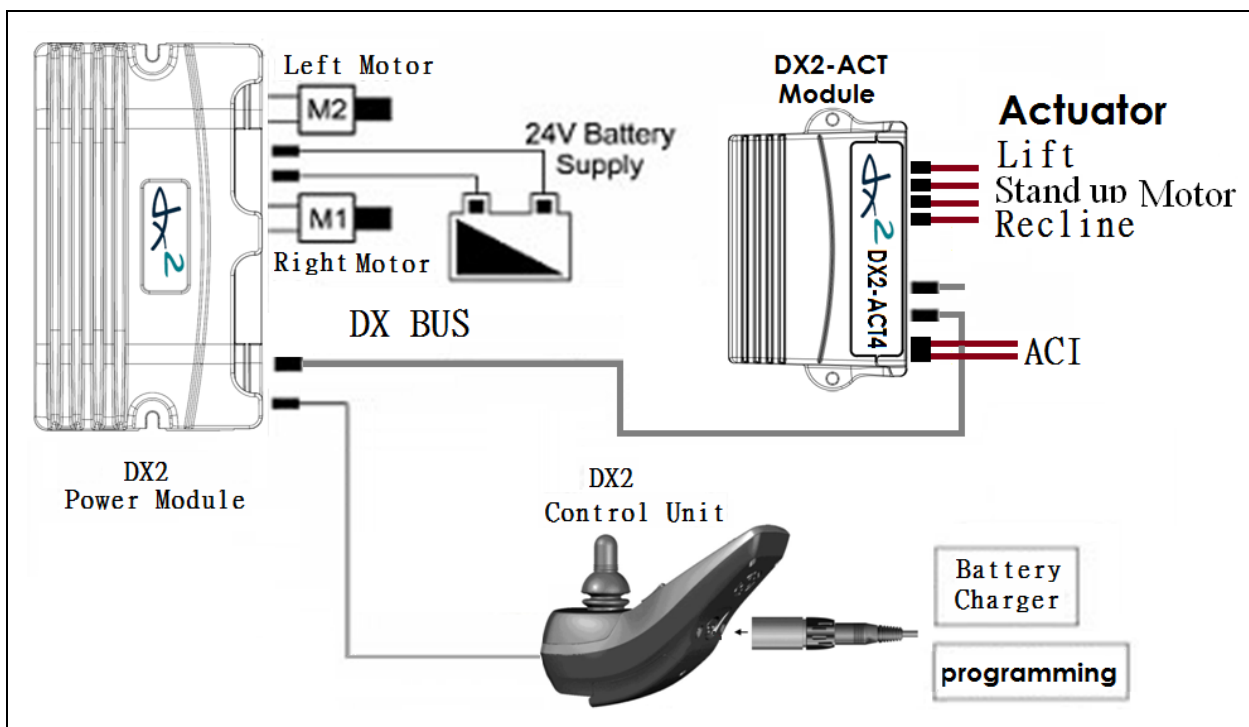

6-3. Battery Charge (Fig-34)



1. First, the battery charger line connect to the battery DC power socket and make sure the line is right connect.
2. Connect the AC power line to the AC socket. (110~230V)
3. The light of battery charger from yellow color become green color and represent the battery charge in finish.

	Battery full	
	Battery almost full	
	Battery half full, drive towards a charger	
	Battery low, recharge soon	
	Battery almost empty, recharge now	
	Battery empty, recharge immediately	

※ When the battery capacity is empty power, it will stop working.

Battery Warnings

Battery warnings are shown at the centre of the screen, in the "Active Mode" area.

Warning Icon	Meaning
	Battery overcharged. <ul style="list-style-type: none">• Slow down and turn on the lights (if fitted).
 + Horn beeps	Battery completely empty. System turns off. <ul style="list-style-type: none">• Recharge.

Attention:

- 1. Anytime check the battery capacity.**
- 2 .New battery must charged over 8 hours.**
- 3.Charge your battery from the battery charger provided by manufacturer only.**

6-4. Main Circuit Breaker

The main circuit breaker reset button is located on the battery box. (Fig -35).

The main circuit breaker monitors the electric current drawn from the battery. It is a safety feature built in your wheelchair for your extra safety.

The entire electric system of the wheelchair is protected by the main circuit breaker against overloading.

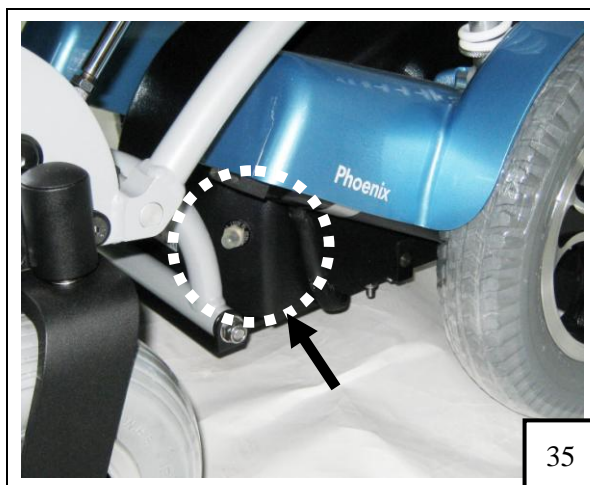

6-5. System Lock / unlock & Sleep mode / wake up



If the **Lock Enable** parameter is set to 'Yes', the system can be locked by pressing the power button for more than 4 seconds.

To lock the DX System



Press the power button for 4 seconds when the DX System is turned on.

- The DX System will turn off in a locked state.

To unlock the DX System



Press the power button.

- The AJR will show a lock on the display.



Press the horn button twice within 10 seconds.

- The DX System will turn on normally.

Sleep mode



If the Sleep Mode Enable parameter (see DSM 5.3.9.8) is set to 'Yes', the DX System will go to sleep after a period of inactivity. This period can be set with the Sleep Timeout parameter (see DSM 5.3.8.5). When the DX System sleeps, it is partially turned off to reduce energy consumption.

To wake up the DX System

Any key
or
Joystick

Press any button on the AJR, or, if the Enable Joystick Wakeup parameter (see DSM 5.3.9.10) is set to 'Yes', move the joystick.

- The DX System will turn on.

6-6. Standard Menu Navigation

Drive Mode - Standard



The operation of the function keys is dependent on the value of the [I II] Function Button

The colour of the current Drive Profile, shown in the middle of the screen, is dependent on the chair's status.

	A green Drive Profile shows a normal drive operation
	An orange Drive Profile is displayed to indicate that a chair can drive, or is driving in a restricted capacity – that is, reduced speed.
	A red (flashing) Drive Profile indicates that the chair is in an inhibited state – the chair cannot be driven in this state.

Button	Function		
	Left Indicator >2s: Side lights		
	Right Indicator >2s: Hazard lights		
	Function	I	II
	Speed Pot	slower	faster
	Warning + Actuator	Side lights	Actuator Aux1
	Actuator up + down	Actuator Aux1 up	Actuator Aux1 down
	Two Actuators	Actuator Aux1	Actuator Aux2
	Full Lighting	Left indicator > 2s: Side lights	Right indicator >2s: Hazard lights
	Warning + Hazard	Side lights	Hazard lights
	Warning + ECU alarm	Side lights	ECU Alarm
	ECU Alarm + Toggle ECU Al.	ECU Alarm	ECU Alarm Latched

Drive Mode Menu Map

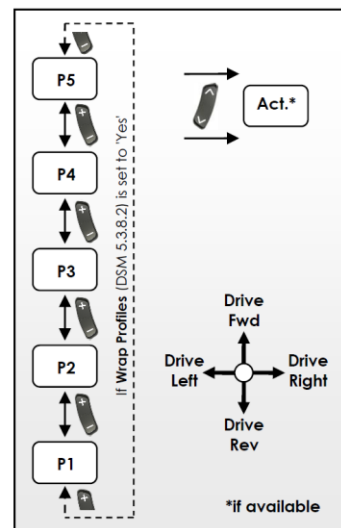

※NOTE:After the backing pad lie of 15 degrees more than 15 degrees when standing on/Under the action will be stopped and can not travel





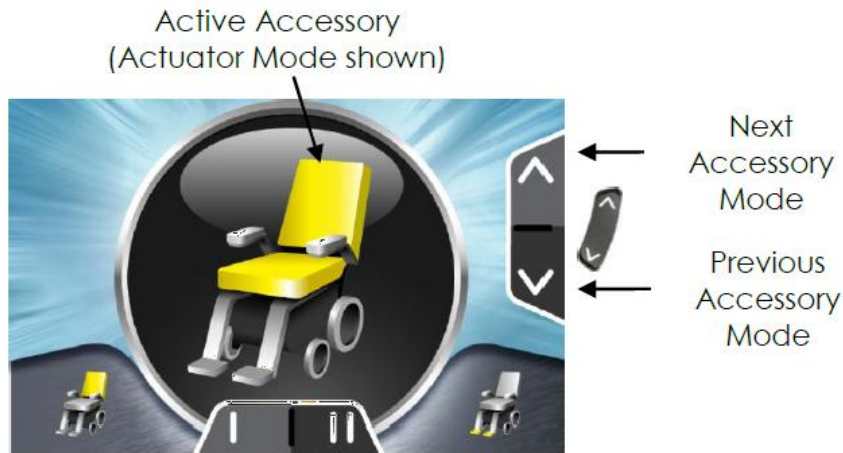

6-7. Accessory Mode – Standard

Accessory Modes are available:

- ☐● when the presence of that accessory is detected in the DX System;
- ☐● when the menu of that accessory has been enabled with its corresponding menu enable parameter



When the Accessory Mode button is pressed (either Next or Previous) the menu will always start at the Seating Accessory screen (if actuators are active).

Mode	Active	Parameter(s)
Actuators		Depends on enabled actuators
iPortal2		Set 'Allow non-driving profile' to 'Yes'. See DSM section 5.3.8.4 Allow Non-Driving Profile
Lights		Lighting Menu (0)
ECU 1 Mouse		ECU Menu (4.2.1.9)
ECU 2		ECU Menu (4.2.1.9)
Program Screen Settings		OBP Menu (4.2.1.7)

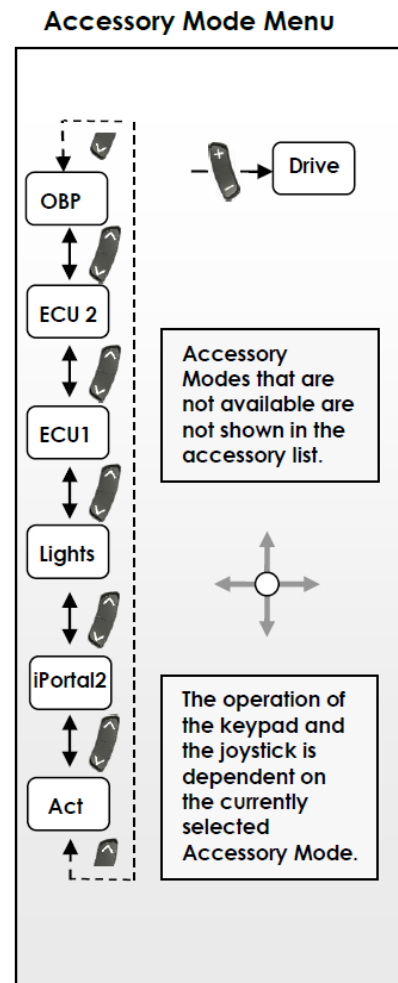

6-8. FLASH CODES



Flash codes indicate the nature of an abnormal condition directly from the DX2 Information Gauge. Without the use of any servicing tools, the condition can be simply diagnosed.

Flash Code	Description	Action
1	DX Module Fault	Turn the DX System off then on again. Check DXBUS connections and replace where necessary..
2	Temperature Fault	Turn system off, wait a few minutes for the system to stabilise, and turn system back on. If fault re-occurs, consult your Dynamic Service Centre.
3	Left(M1) Motor Fault	Disconnect the left motor plug and check continuity between the motor pins on M1. Ensure there is no continuity between motor and park brake terminals
4	Right (M2) Motor Fault	Disconnect the right motor plug and check continuity between the motor pins on M2. Ensure there is no continuity between motor and park brake terminals.
5	Left (M1)Park Brake Fault	Disconnect the M1 plug and check continuity between the two Positronic Park Brake pins. Ensure there is no continuity between motor and park brake terminals.
6	Right (M2)Park Brake Fault	Disconnect the M2 plug and check continuity between the two Positronic Park Brake pins Ensure there is no continuity between motor and park brake terminals.
7	Low Battery Fault	Check battery connection and terminals. The battery voltage should be similar when the -battery is on charge, and when it isn't. Check that fuses have not blown, or circuit breakers tripped. Replace battery if worn out or if capacity is insufficient for the user's needs
8	Over voltage Fault	If this fault occurs during battery charging, the battery charger is defective or incorrectly adjusted Check the battery charger's open circuit voltage is in accordance with the battery anufacturer's-limits, and is less than 32V Check that the battery wiring and terminating is secure.
9	CANL Fault	Check the continuity of the DXBUS cable. Check for shorts between DXBUS pins. An open or short circuit on another DX Module can cause this fault.
10	CANH Fault	Check the continuity of the DXBUS cable. If the Hazard Lights were already switched on when the DX System was turned on, Flash Code 10 and Limp Mode (slow driving) may result. To clear this fault, turn the Hazard Lights off, then turn the DX System off then on again. If generated by a Kill signal, the cause of the fault is severe.
11	Stall Timeout Fault	Turn the DX System off then on again. The system may require time to cool down. Ensure wheels turn freely while under no load. Have motor(s) checked by a service technician.
12	Module Mismatch	Reprogramming the wheelchair system may correct this problem Consult your Dynamic Service Centre.

Chapter 7. MAINTENANCE

- When cleaning your stand up wheelchair use a dry or slightly moistened cloth to wipe the wheelchair down. For stubborn or oily stains, apply a mild detergent to the cloth. Do not hose down your wheelchair with water.
- According to frequency of use, check tire pressure between once a week and once a month.
- Check the state of the tread on the tires every one to six months. If a tire is heavily or unevenly worn, it should be replaced.
- According to frequency of use, To lubricate the joint between one a week and once a month. (Fig-36~44)

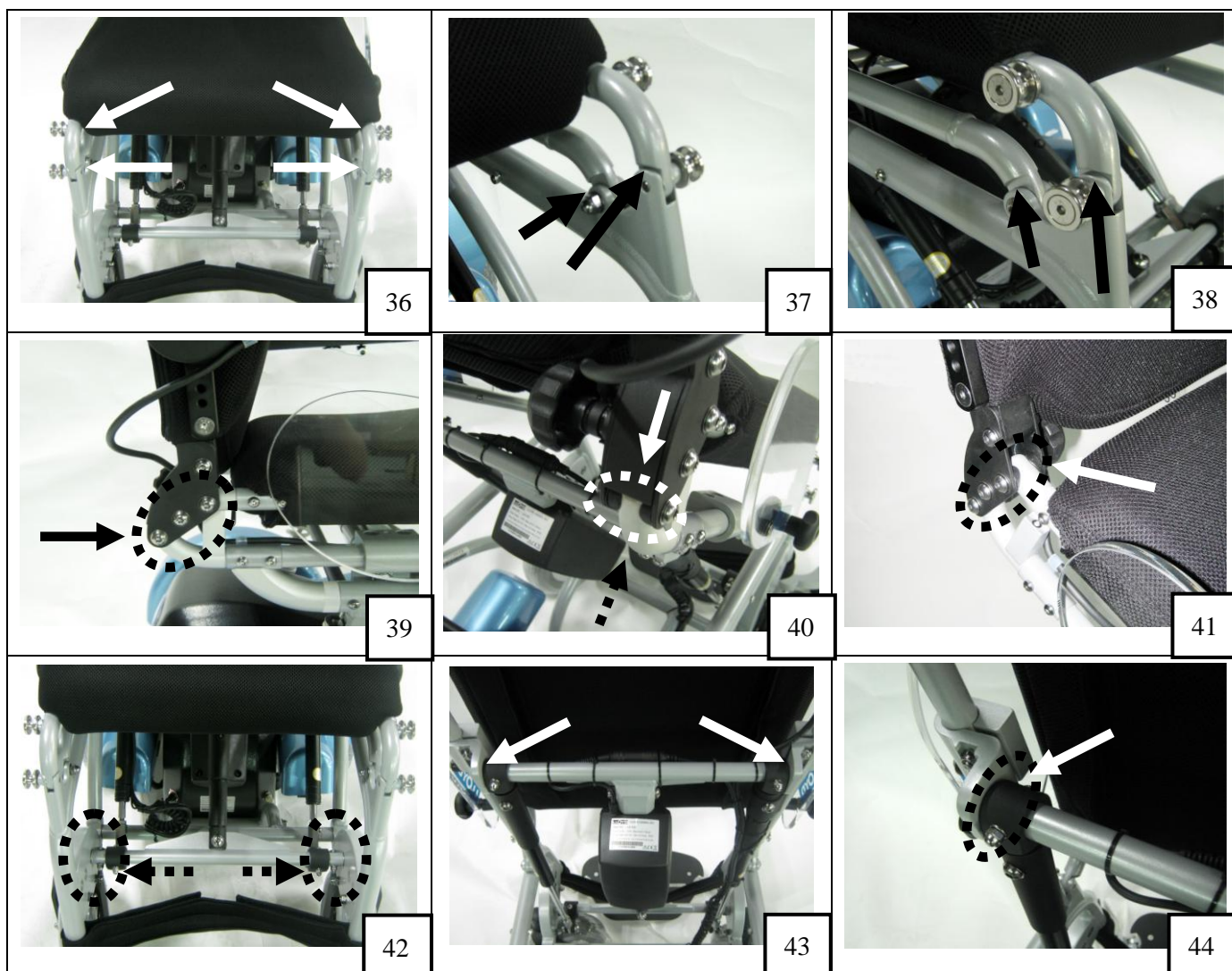

WARNING!

Failure to maintain the brushes could void the power wheelchair warranty.

To inspect or replace the motor brushes:

1. Unscrew the motor brush caps. (Fig-45)
2. Remove the brushes.
3. Inspect the brushes for wear. (Fig-46)
4. Replace the brushes if necessary.

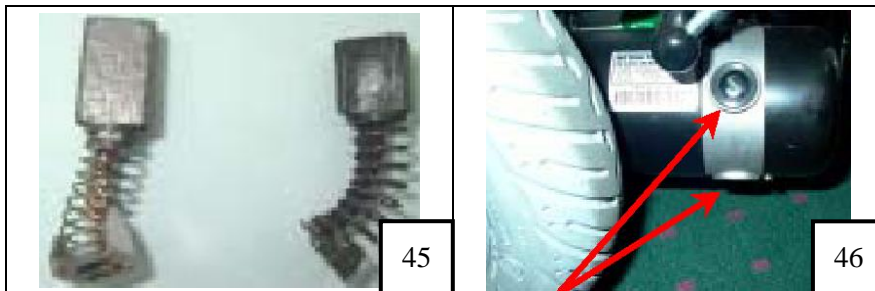

This product has been supplied from an environmentally aware manufacturer that complies with the Waste Electrical Equipment (WEEE) Directive 2002/96/EC.

Please be environmentally responsible and recycle this product at the end of its life through your local recycling facility.

This product may contain substances that could be harmful to the environment if disposed of into a landfill.

NOTICE

This chair is not intended for those who have:

- Lower limbs joint contracture (absolute contra-indication)
- Total hip replacement (THR) and total knee replacement (TKR)
- Instability on lower extremity joints
- Severe osteoporosis on lower extremities
- Severe abnormal reflex (lower extremities withdraw reflex)
- Severe postural hypotension
- Low-shearing seat will be suggested to those who use positioning system

WARRANTY

<u>Frame</u>	<u>Electrical</u>	<u>Parts</u>	<u>Motor/Transaxle/Brake</u>
3 Years	1 Year	1 Year	1 Year

1. Structural frame components including platform, fork, seat post and frame welds are warranted, to the original owner/
2. To present a claim, Customer shall deliver the defective part for exchange or repair if possible to an Authorized Karman provider.
3. This warranty is for the replacement or repair, at the option of Karman Healthcare Inc., of defective parts only and does not cover any labor charges including, but not limited to, charges incurred for installation of replacement parts or additional fees, which may be imposed by Karman Healthcare Inc.
4. All warranty replacement parts are under warranty from the date of purchase of the original “product” and not from the date of part replacement.
5. This warranty is valid and enforceable only on “products” purchased in the United States and from a Karman provider.
6. This warranty is applicable only to the customer as an original purchaser of the “product” from an Authorized Karman provider and shall not apply to any subsequent purchaser, assignee or other recipient of the power chair from customer.
7. No provider or other similar person has any authority to make any warranties or representations concerning Karman Healthcare Inc. products, or to extend this warranty beyond the expressed terms contained within. Distributor assumes no responsibility for any warranties beyond the expressed terms contained in the warranty. Customer releases and holds distributor harmless from any claims stemming from any unauthorized representations.
8. This warranty does not apply unless the Registration Card is signed completed and returned within thirty days (30) from the date of purchase.
9. Warranty Exceptions:
 - A. Transaxle: In cases where there is an increase in the operational noise level, the warranty will not apply.
 - B. Motor: If damage occurs as a result of not replacing motor brushes after heavy wear to brushes.
10. This warranty does not cover batteries or damage caused by battery leakage. The battery manufacturer covers warranty.
11. This warranty does not cover plastic covers; seat upholstery, tires, or armpads these are considered wear items.
12. All transportation costs and shipping damage incurred while submitting parts for repair or replacement are the responsibility of the original purchaser.
13. This warranty does not apply to any injury, loss, defect or malfunction of the “product” or failure to function resulting from any failure to operate or maintain “product” in accordance with the directions contained in the owners manual provided by Karman; or any injury, loss, damage or malfunction, or failure to function resulting from any accident, acts of God, alterations in the “product” by anyone other than the distributor, or misuse, unreasonable use, tampering, abuse, acts, omissions, failure or negligence by anyone other than the manufacturer.

www.WheelchairSuperstore.com