

Age Range: 1 3
Weight Limit: 40 lbs.
Surfaces: Asphalt/Hard Surfaces
Speed: 2.0 Forward
Colors: Green Body/
 Orange Seat/Black
 Wheels



M5130 Get Set Go! Kart Toddler Series

Intro: 2007
Suggested Retail:
 \$99.99

Box Dimensions:
 11.375 x 24.375 31.750
 18 lbs.

Warranty
 One Year Vehicle
 6 Months Battery

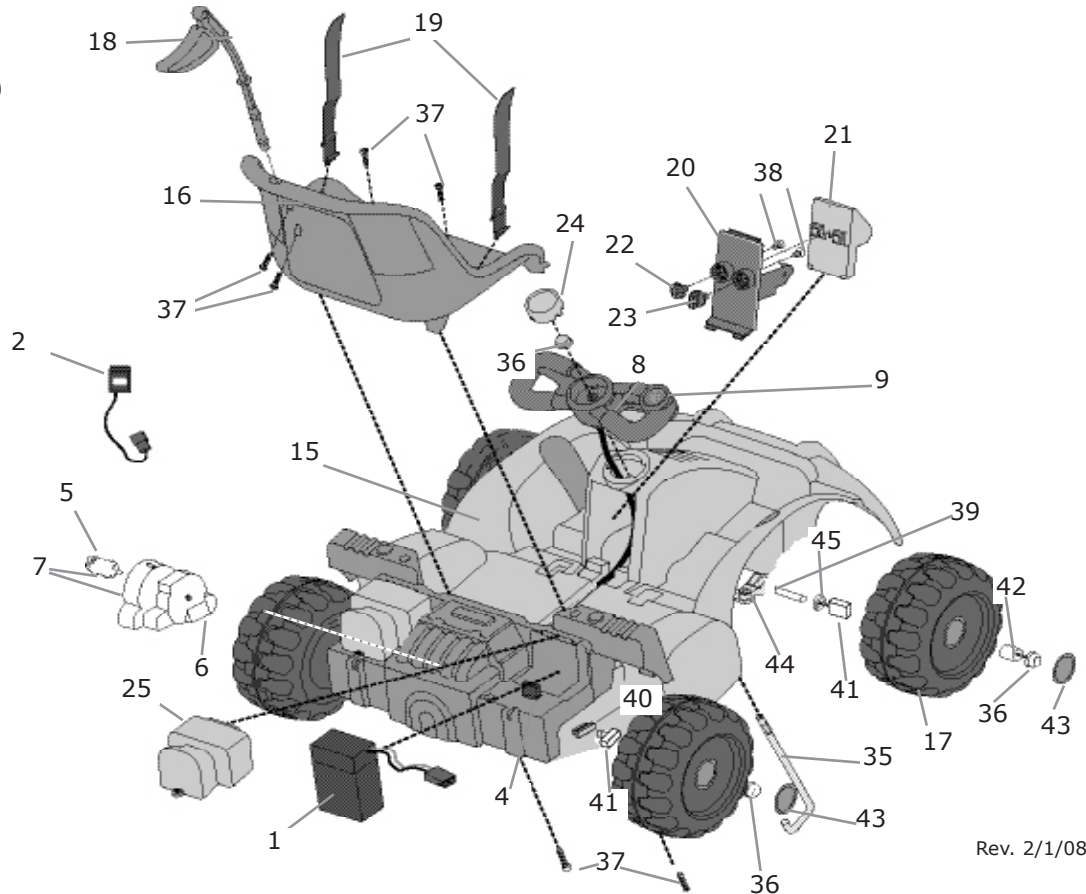

Rev. 2/1/08

Item No.	Description	Part No.	Qty. Item	Part	No. Qty.	Description	No.
Working / Electrical Parts			Hardware / Metal Parts				
1.	6V, 4 amp Battery	00801-1457	1	35.	Steering Column	76790-4539	1
2.	6V, 4 amp Charger	00801-1483	1	36.	.354 Cap Nut	0801-0693	6
4.	Wiring Harness	76790-9699	1	37.	8 x 3/4 Screw	00912-8001	6
5.	Motor Pinion	00968-3700	1	38.	6 x 3/8 Screw	N/A	2
6.	Gearbox #10	00968-3800	1	(Order Hardware Bag)			
7.	Motor Gearbox Assy	00968-3900	1	39.	Front Axle	76790-4519	2
8.	Steering Wheel Assy w/Harness	M5130-9209	1	40.	Bushing w/Out Ext, Rect	74504-2549	2
9.	Switch	00801-1222	1	41.	Bushing w/Ext. Rect	78560-2659	4
Plastic / Other Parts			Parts Not Shown				
15.	Vehicle Frame	N/A	1	Large Parts Bag			
16.	Seat	M5130-2149	1	Hardware Bag			
17.	Wheel	76790-2119	4	Owner's Manual			
18.	Flag	M5130-2269	1	Decal Sheet			
19.	Seat Belt Set	75547-5519	1	Rear Axle			
20.	Sound Box Cover	M5130-2239	1	Emblem			
21.	Sound Box	G4815-9359R	1	Motor Cover			
22.	Sound Knob	M5130-2259	1	Cable Tie			
23.	Key Knob	M5130-2249	1				
24.	Steering Wheel Cap	M5130-2229	1				
25.	Rear Bumper Cover	76790-2139	2				

N/A = Not Available

Bold and Underlined parts are to be purchased and installed by Service Centers only. These items may not be sold directly to consumers by Service Centers or Fisher-Price.