

Age Range: 3 and up
 Weight Limit: 130 lbs max
 Surfaces: Hard
 Surfaces & Grass
 Speed: 2.5 & 5.0 MPH FOR
 2.5 MPH REV
 Colors: Blue Body/Black
 Wheels
 Intro: 2004
 Suggested Retail: \$219.99
 Box Dimensions:
 18.375 X 33.375 X 44.750
 67 lbs
 Warranty
 One Year Vehicle
 6 Months Battery

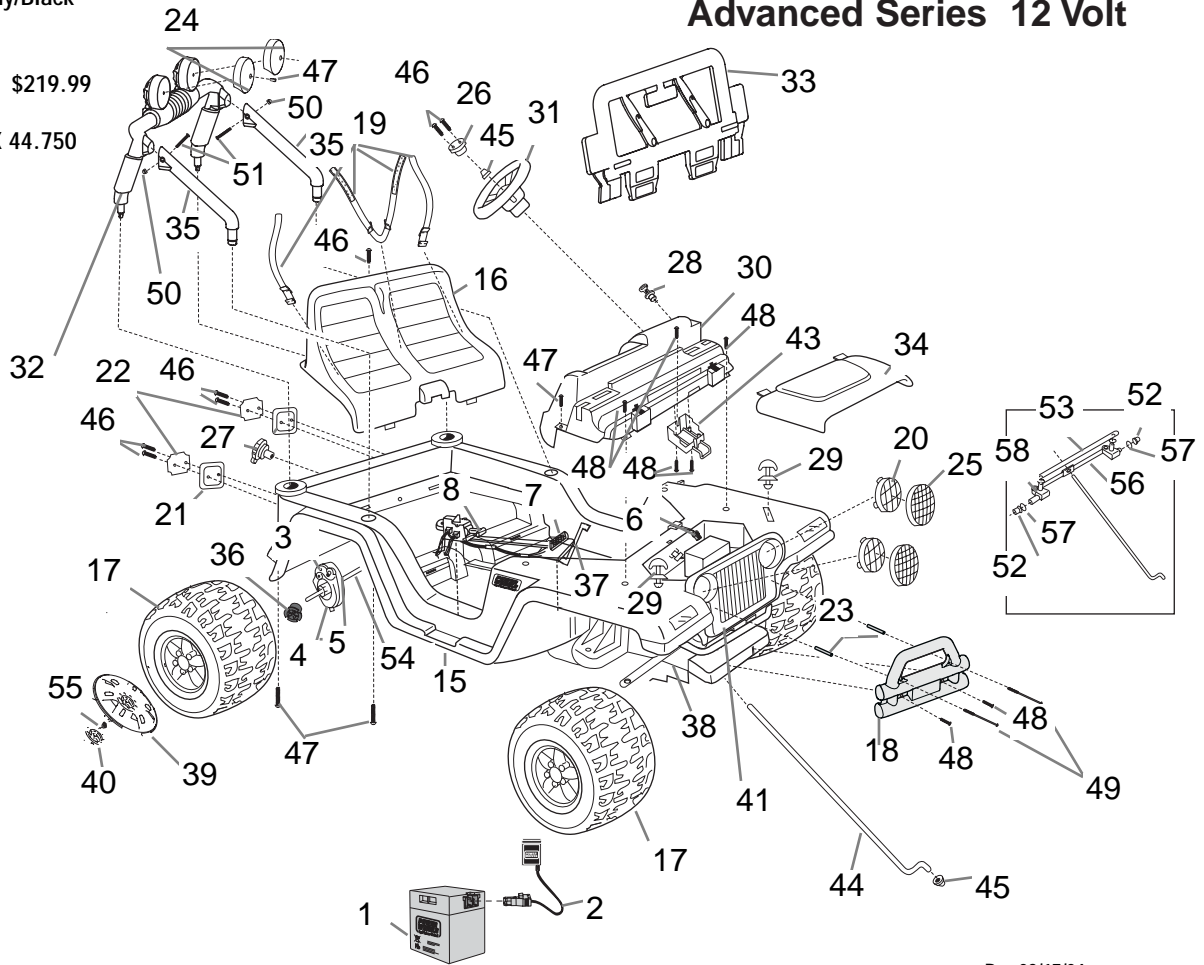

B7659 Jeep Wrangler- Restage

Advanced Series 12 Volt



Rev.02/17/04

Item No.	Description	Part No.	Qty.	Item No.	Description	Part No.	Qty.	Item No.	Description	Part No.	Qty.
Working / Electrical Parts											
1.	12V Battery	00801-0638	1	30.	Dash	B7659-9069D	1		(Order Hardware Bag)		
2.	12V Probe Charger	00801-0972	1	31.	Steering Wheel	74440-2379	1	52.	7/16 Round Bushing	74550-2689	2
3.	Motor Gearbox Assembly	00968-2912	2	32.	Sport Bar	B0155-2219	1	53.	Cross Bar	75840-4409	1
4.	Gearbox W/out Motor	00968-2802	2	33.	Windshield	B0155-2619	1	54.	Rear Axle	B7659-4529	1
5.	Motor Pinion Assembly	00968-2702	2	34.	Hood	4000-0246	1	55.	.437 Cap Nut	0801-0227	6
6.	Main Harness Assembly	C2390-9799D	1	35.	Sport Bar Support	B0155-2769	2	56.	Steering Linkage Assembly	74440-9419A	1
7.	Footboard Assembly	74020-9839D	1	36.	Wheel Driver	74460-2249	2	57.	7/16 Washer	0801-0196	4
8.	Shifter Assembly	74310-9239	1	37.	Channel Cover	78537-2289	1	58.	Front Axle	B7659-4519	2
Plastic / Other Parts											
15.	Body	N/A	1	38.	Front Module	B7659-2019	1				
16.	Seat	78490-2319	1	39.	Hubcap	B7659-2469	4				
17.	Wheel	B7659-2459	4	40.	Hubcap Cover	B7659-2679	4				
18.	Brushguard	B0155-2789	1	41.	Grill	75598-2849	1				
19.	Seatbelt Set	B7659-5339	1	Hardware / Metal Parts							
20.	Headlight Lens	74450-2279	2	43.	Battery Retainer (Clamp)	74020-9819					
21.	Taillight Housing Set	74020-2759	1	44.	Steering Column	78490-4239	1				
22.	Taillight Lens Set	73233-2279	1	45.	.354 Cap Nut	0801-0604	3				
23.	Spacer	74460-2069	2	46.	#8 x 1" Screw	0912-8003	7				
24.	Light Cover	B7659-2169	2	47.	#10 x 1/2" Screw N/A (Order Hardware Bag)		8				
25.	Lens Guard	74460-2339	2	48.	#10 x 1" Screw	0801-0220	7				
26.	Steering Wheel Cap	74550-2729	1	49.	#8 x 4" Screw N/A (Order Hardware Bag)		2				
27.	Gas Cap	75597-2089	1	50.	#8 Lock Nut N/A (Order Hardware Bag)		2				
28.	Key Assembly	74765-9369	1	51.	#8-32 X 1.625" Screw N/A		2				
29.	Hood Latch	74020-9559	2								
Parts Not Shown											
											1
											1
											1
											1
											1
											1
											1
											1

N/A = Not Available

Bold and Underlined parts are to be purchased and installed by Service Centers only. These items may not be sold directly to consumers by Service Centers or Fisher-Price.