

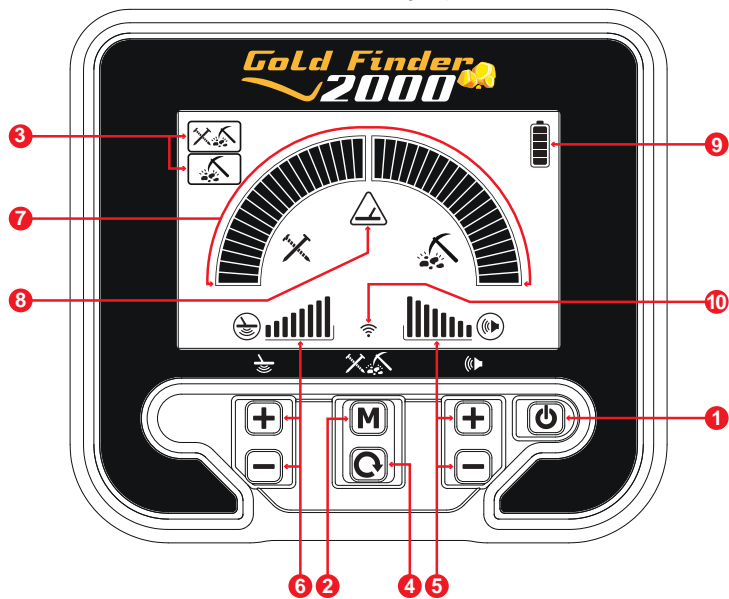

Control Display



- 1) On / Off Button
- 2) Search Mode Button
- 3) Search Modes
- 4) Pinpoint Button
- 5) Volume Buttons
- 6) Sensitivity Buttons
- 7) Signal Strength Bar
- 8) Warning Icons
- 9) Battery Icon
- 10) Wireless Connection Icon



Turning On/Off the Device

To turn on the device, press and hold the On/Off button  until the bar starts filling up. To turn off the device, press and hold the button until the display light turns off.



Search Modes

There are 2 search modes: All Metal and Discrimination. Press the M button  to select the mode.



All Metal Mode

In this mode, the device does not provide audio tone discrimination and gives the same audio tone for all types of targets.



Discrimination Mode

In this mode, the device does NOT provide any audio tone for ferrous metals and it provides a high tone for non-ferrous metals.

In both search modes:

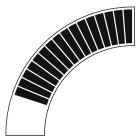

When the device detects a ferrous metal, the left side of the bar fills up in proportion to the strength of the target signal.

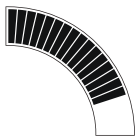

When the device detects a non-ferrous metal, the right side of the bar fills up in proportion to the strength of the target signal.



Sensitivity

This is the depth setting of the device. It is also used to eliminate the ambient electromagnetic signals from the surrounding environment and noise signals transmitted from ground.

Sensitivity setting consists of 8 levels and is pre-defined for each mode. Each mode starts with its default sensitivity setting and it can be manually modified when necessary.

Note : If the ground is highly mineralized causing the device to overload, decrease the Sensitivity until the overload warning icon  disappears from the screen.



Volume

Press the + or - button to adjust the volume.



Pinpoint

Pinpoint is to find the center or the exact location of a detected target.

To perform pinpoint :

- 1- After a target is detected, move the search coil aside where there is no target response and push the Pinpoint button .
- 2- Keep the button pressed down and bring the search coil closer to the target slowly and parallel to the ground.
- 3- Signal sound becomes stronger and changes in pitch while getting closer to the target center. In addition, the bar on screen will rise or fall based on signal strength.
- 4- Mark the position which provides the loudest sound using a tool or your foot.
- 5- Repeat the above procedure by changing your direction 90°. Actions to be performed from a couple of different directions will narrow the target area and provide you with the most exact details of the target location.

Frequency Shift

It is used to eliminate the electromagnetic interference that the device receives from another detector which operates in the same frequency range nearby or from the surroundings. If too much noise is received when the search coil is lifted in the air, this may be caused by the local electromagnetic signals or excessive sensitivity settings.

To shift the frequency, press and hold the M button  for 3 seconds while the device is on. The frame around the search modes icon will start blinking. Change the frequency using the sensitivity +/- buttons.

Note : If no button is pressed for 5 seconds, the screen will time out and the device will revert back to the main screen.

Frequency shift will be reflected on the left side of the bar. The left side of the bar will start filling up / falling each time you press the sensitivity +/- buttons. Frequency shift consists of 10 steps and 5 is the central frequency.

IMPORTANT! At each power up, the frequency shift setting will start at the central frequency of 5.

Illumination LEDs

It is the flashlight used for lighting the area you are scanning while detecting at night or in dark locations. To activate the LEDs, while the detector is on, press the pinpoint and volume minus (-) buttons at the same time. Repeat the same to turn them off. LEDs do not operate when the device is off. It is recommended to turn them on only when necessary since they consume extra battery power.

Wireless Connection

Gold Finder 2000 has a built-in wireless module which allows for wireless speaker and wireless headphones connection. The wireless speaker is supplied with the device and the pairing instructions are provided below. You can find the pairing instructions for the wireless headphones in the Nokta Makro 2.4GHz Wireless Headphones sold separately.

Turn on the wireless speaker by pressing and holding down the power button and do not let go of the button until the beep indicating the battery status is heard. The green LED on the speaker will start flashing fast. The speaker is ready to be paired with the device. Turn on the device while pressing the sensitivity plus (+) button. Do not let go of the sensitivity plus (+) button until the device is turned on and the wireless icon  appears at the center bottom of the screen. Once the wireless icon is displayed, the sound will be heard both from the device and the speaker.

If the pairing is not successful, repeat the above steps.

Changing the Wireless Connection Channel

To change the channel, press and hold the M button  for 3 seconds while the device is on. The frame around the search modes icon will start blinking. Change the frequency using the volume +/- buttons.

The channel number will be reflected on the right side of the bar. The right side of the bar will start filling up / falling each time you press the sensitivity +/- buttons. There are a total of 20 channels. When the bar is completely empty, it means that the wireless connection is off.

Factory Defaults

Press and hold the M button  immediately after turning on the device. When the display light turns on, release the M button. The bar will rise and fall, the battery icon will fill up and the device will revert back to factory defaults.

Software Update

Gold Finder 2000 has software update capability. All software updates made after the device is released to the market will be announced on the product's web page along with updating instructions.

Warning Icons



Low Battery Warning

Battery icon on the display shows the battery life status. When the charge decreases, the bars inside the battery icon decrease, too. When the battery is depleted, the battery icon will start flashing.



Check Coil

It indicates an interruption in the search coil transmitter signal. The search coil connector may be unattached, loose or disconnected or the search coil may have a defect. If the issue continues when you change the search coil, there may be an issue in the coil control circuit.



Overload

Shallow and/or large targets may cause an overload and the device starts to generate a continuous sound which resembles a siren. Overload icon  is shown on the display simultaneously. In such a case, lift the search coil up until the icon disappears.

WARRANTY

This product has a 2 year limited warranty from the time of purchase. Please refer to www.noktadetectors.com for further warranty information.



FCC STATEMENT

This device complies with Part 15 of the FCC Rules. Operation is subject to the following two conditions: (1) this device may not cause harmful interference, and (2) this device must accept any interference received, including interference that may cause undesired operation.



For Consumers within the European Union: Do not dispose of this equipment in general household waste. The crossed wheeled bin symbol on this equipment indicates this unit should not be disposed of in general household waste, but recycled in compliance with local government regulations and environmental requirements.

Assembly



(4) To adjust the armrest to your comfort, push the red lock forward. Adjust it by sliding it up or down and secure by pushing the red lock in the opposite direction. Insert the armrest strap as shown in the picture and adjust it to your arm size and tighten.

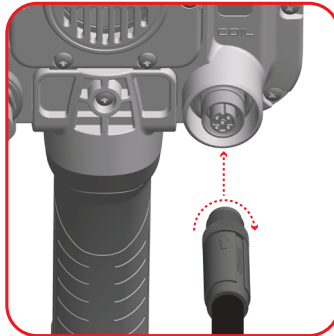

(3) Wind the search coil cable on the shaft without stretching too much. Then, plug the connector to the search coil input socket on the system box and secure by tightening the nut. While tightening, you may hear clicks indicating that the connector is secured.

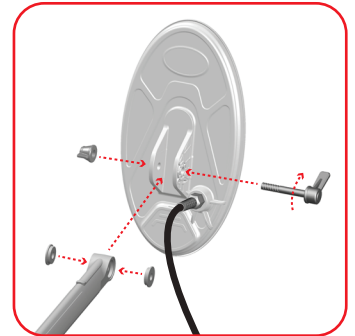

(1) After inserting the washers on the lower shaft, place the lower shaft in its location on the search coil. Secure by tightening the screw and nut. Do not overtighten.

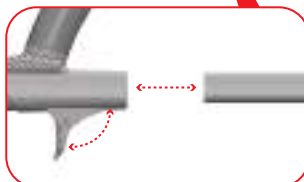

(2) To join the middle rod with the upper and lower rods, open the lever latches and engage the pieces together. After adjusting the length of the device to your height, press the latches to secure.

