

# **VF GOLD VISION**

VISUALIZE GOLD  
AND GET IT



Contents	1	Bionic System	39
Property Rights	2	Settings	42
Package Contents	3	Wireless Handle Charging	46
Important Warnings	4	Technical Specifications	48
Device Installation	5		
Device Overview	8		
Keypad	9		
Powering Device On	10		
Main Screen	11		
Search Systems	12		
3D Ground Scan System	13		
Long Range System	15		
Free Mode System	29		
Smart Depth System	31		
Ionic System	36		

## Property Rights

**Gold Vision GV-3720** product was designed programmed and produced exclusively by “Geoground-Geophysical Ground Measuring production” group.

All innovations, systems, designs and computational algorithms available on this device are exclusive to Geoground, and are protected by proprietary rights.

Any copying or imitation of the Device or any part thereof or the technologies used therein, without expressly authorized by the Company, will be subject to all legal liability for such person or entity.

Geoground is not responsible for any use of its products in violation of the laws of the country in which these devices are used.

Geoground is not responsible for any kind of damage caused by misuse of the device or misunderstanding of this user manual.



**GEOGROUND**  
**GEOPHYSICAL GROUND MEASURING**

Email(Info) : [info@geo-ground.com](mailto:info@geo-ground.com)

Email(Sales) : [sales@geo-ground.com](mailto:sales@geo-ground.com)

Website : [www.Geo-Ground.com](http://www.Geo-Ground.com)

## Package Contents

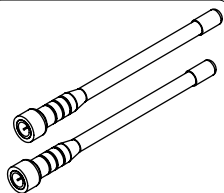

Search Antennas

New!

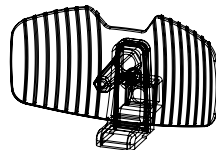

Signal Booster Dish

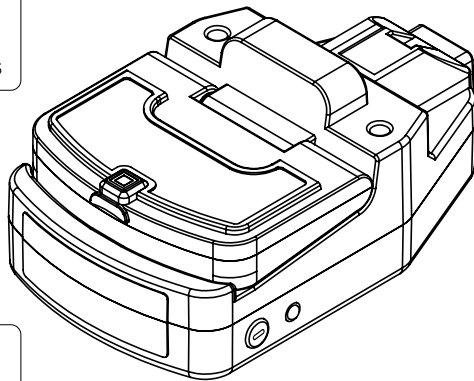

Main Unit

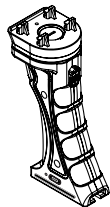

Wireless Handle

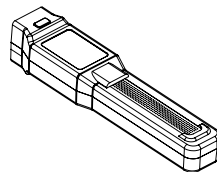

Smart Sensor

## Important Warnings



### Important warnings before use

1. Do not install or assemble the device without reading this user manual.
2. No part of the Device may be disassembled or repaired except by Geoground or its authorized service centers.

Any disassembly of the Device or any of its parts by any person or entity not authorized by Geoground; to void the device warranty.

3. Make sure that there are no metals of any kind while using the device.
4. Do not store the device and its components at low or high temperatures for long periods.
5. It is preferable not to use a different charger than the original charger for the device (you can request another original charger for the device in case the original charger is lost).
6. Please protect the device and all its accessories from water, extreme heat and harsh conditions.
7. In order for the battery life to last longer try to charge the battery at least once a month.

## Device Installation

**First:** Install the smart sensor into its socket in main unit of the device correctly.

**Caution:**

The Smart Sensor lock button should be on the top side of the main unit.

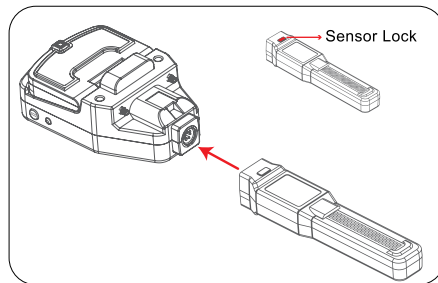

If the smart sensor not installed on the device, a sensor error message will display on the systems screens. Install the smart sensor correctly and restart the device.

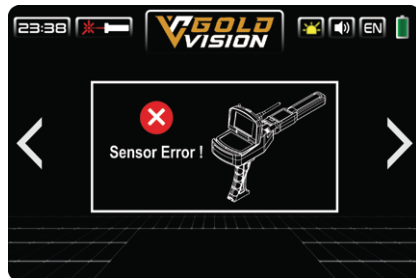
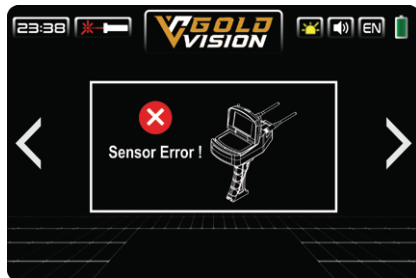

## Device Installation

**Second:** Install the wireless handle unit on the bottom side of the device.

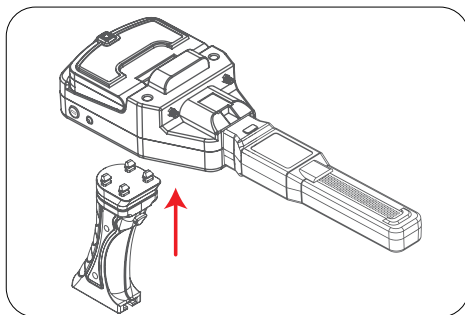
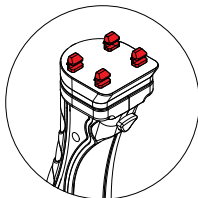
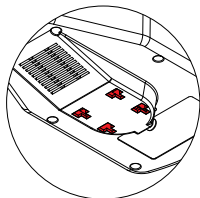

Attention must be paid to inserting the four pegs located on the top side of the wireless handle unit directly into the correct corresponding slots at the bottom of the main unit of the device, properly.

**Third:** install the search antennas on the device as shown on the side. Then, twist the antennas clockwise until they fit in the designated location on the main unit.

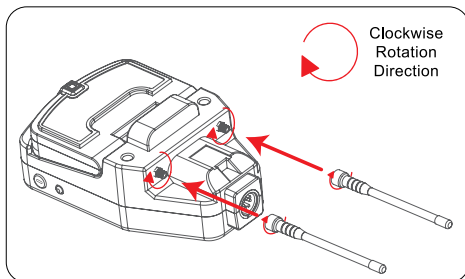

## Device Installation

**Fourth:** install the Signal Booster Dish in its correct position as shown in the pictures below.

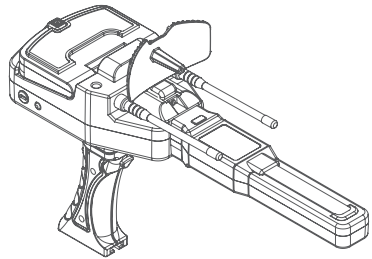
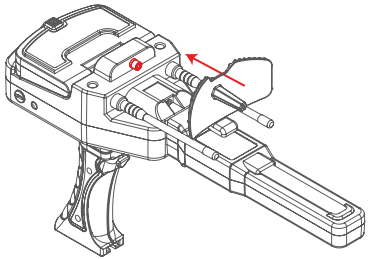

The Signal Booster Dish in the Gold Vision device is a very distinctive and powerful addition to the device, as this dish helps in enhancing all the signals captured by the device, this will help the device to better identify metal targets in the search area.

Please take care to insert the signal booster dish in the correct place as shown on the side.

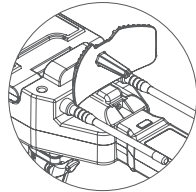
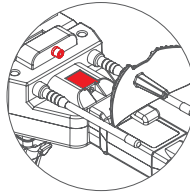



# Device Overview

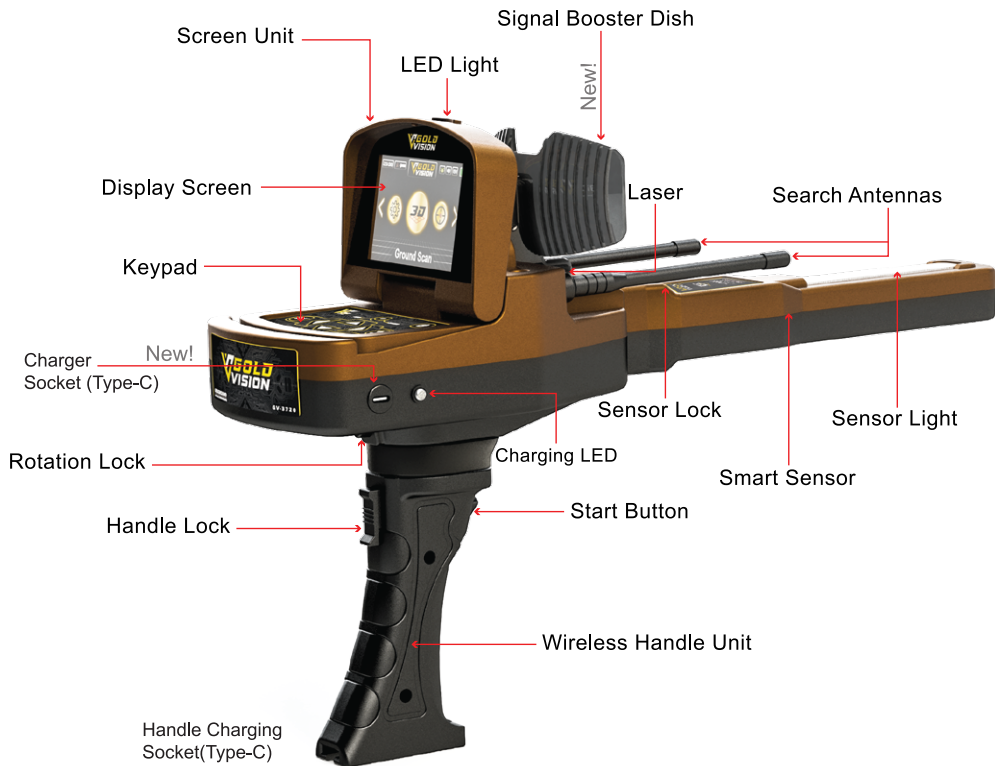

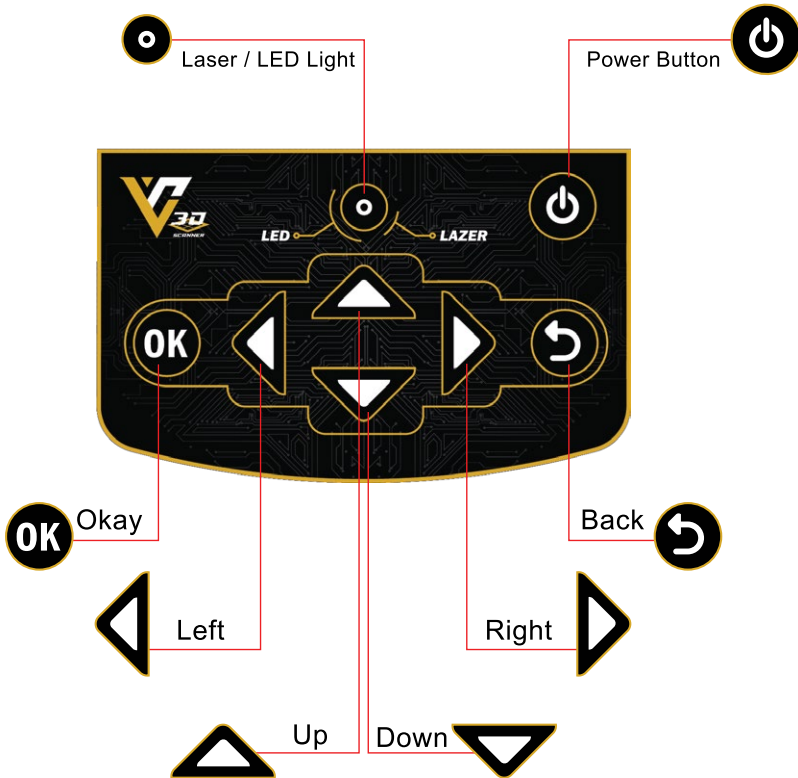

## Powering Device On

After installing the device, and before starting use, make sure that the device and the wireless handle connected to charging until the color of the charging LED light changes from red to blue.

Open the screen unit, and press and hold the Power button. Wait a while for the download to complete. First, you will see the splash screen.

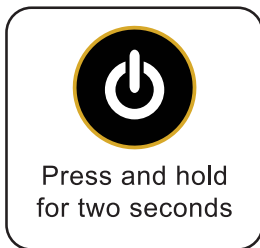

Splash Screen

We strongly recommend that the device be in a flat and horizontal position when operating the device for the first time.

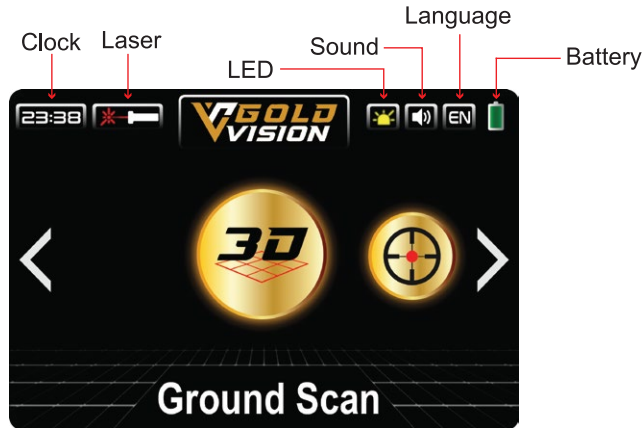

Main Screen

- 1: Clock status, which can be adjusted from the Device Settings.
- 2: Laser status, which can be turned on by pressing and holding the Laser button on the keypad, The laser will also automatically activated when searching through the "Bionic" system.
- 3: LED Light status, which can be turned on or off by pressing the LED button.
- 4: General sound status, which can be controlled in the device settings.
- 5: Language Indicator: The symbol of the language used in the device will show here, as device program user interface comes in eight international languages, which we can also change from the device settings.
- 6: Battery status, which displays the current charging level of the device battery.

## Search Systems

**Gold Vision GV-3720** device from Geoground Company contains 6 different and various search systems, which are listed below:

1. **3D ground Scan System**
2. **Long Range System**
3. **Free Mode System**
4. **Ionic System**
5. **Bionic System**
6. **Smart Depth System**

After turning on the device and skipping the start-up screen, the "3D Ground Scan" system screen will display on screen as it shown on the side.

You can navigate to the next system using the Right/Left arrow buttons on the keypad.





### 3D Ground Scan System

This system works with the built-in ground scanning technology through the smart sensor that is used to measure changes in magnetic fields resulting from metallic targets or underground voids.

**To start working on the application, please read the user manual attached with this guide inside the device's bag.**

The search results of this system displayed in the exclusive and proprietary GEOGROUND 3D ANALYZER application, which user can install it on any supported Android smartphone or tablet.



Geoground has developed and programmed this application, which provides the user with multiple visual tools for analyzing the three-dimensional drawing and determining the type, shape, size, and depth of any potential targets within the scanned area in a visual manner.

## 3D Ground Scan System

To conduct a search with this system, the user must install the wireless handle and the smart sensor and connect the

**GEOGROUND 3D ANALYZER** application to the device.

It is also important to note to lock the device rotation feature using the lock button on the handle.

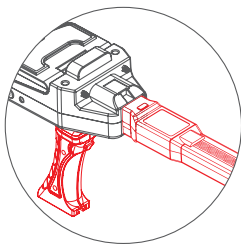

After connecting the application to the device, we will notice that the system screen automatically opens on the device. This screen is just an alert screen. We then go to the application and continue the search process there, according to the quick user guide attached in the device's bag.

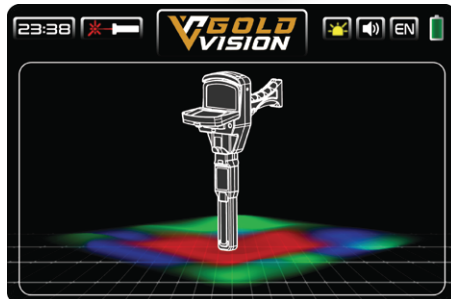



## Long Range System

The device rotation around the electronic handle feature was developed to accommodate various uses for all device systems.

In the "Long-Range" system, when the device detects frequencies of potential targets, it rotates around the electronic handle towards the designated target.

**Install the wireless handle, antennas, smart sensor, and signal boosting dish in the device, making sure to unlock the wireless handle lock.**

### First: System Selection:

Select Long Range system from the main menu and press OK to enter the system. The system screen, which includes the system settings, will show to us, as shown on the side.

User has to adjust all settings based on search area and target to get better scanning result.



From here, you can set the "Soil" type, "Target" type, Max "Distance" and Max "Depth" using these settings. Use the Up/Down arrows to switch between tabs.





# Long Range System

## 1. Target

In this section, the user has to select the type of target he is looking for in the surrounding area.

Selecting the correct target causes the device to focus only on that selected target and perform the search based on the settings chosen in this system. Gold Vision device designed to search for **11** different types of targets.

These target types are:

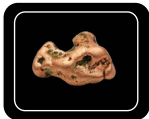

Bronze



Cavities

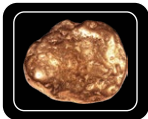

Copper



Diamonds



Gemstones

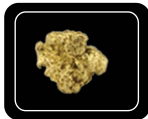

Gold Ore



Gold  
Treasures



Gold Veins



Iron



Platinum



Silver

Use the Left/Right arrow keys on device keypad to change the type of target you want to focus your search on.



## 2. Soil

In this section, the user must select the soil type of the desired area before completing the settings and starting the search process.



Gold Vision device designed to work in seven different types of soil. Soil types are as follows:



High Mineral



Low Mineral



Normal



Rocky



Sand



Stony



Wet

## Long Range System

### 3. Distance

Gold Vision device has a detection capacity of up to 3000 meters from the device's location.

From this section, the user can search for all possible targets within the range he defines (from 1 meter to a maximum of 3000 meters).

Use the Left/Right arrows on the keypad to change the desired distance.

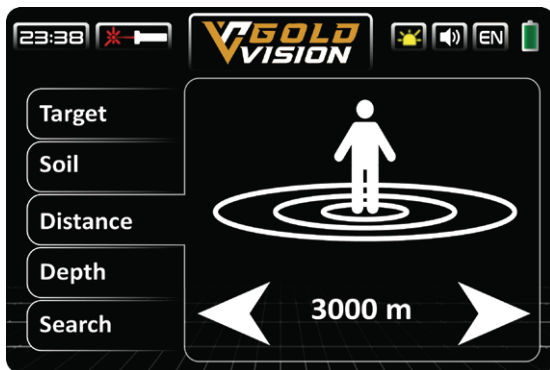

By long pressing the Left/Right keys, the values will change faster.



## 4. Depth

Gold Vision device has the ability to detect targets up to a depth of 40 meters underground, and this feature will enable the user to search for all possible targets to this depth. Use the Left/Right keys on the keypad to change the desired depth.

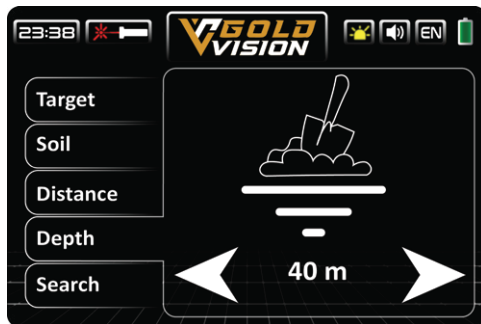

## 5. Search

After selecting the desired settings, use the Down key to go to the search section. On this page, you can see all the settings that you previously selected in the previous sections.

By pressing the OK key on the keypad, the search screen will be displayed.. Continue to the following pages to explain the details of the search screen



# Long Range System

## Calibration

After completing the initial settings, and entering the search screen, a warning window will appear to us, as shown below.

Press the OK button on the keypad or the Start button on the top of the wireless handle to start calibration and enter the search screen.

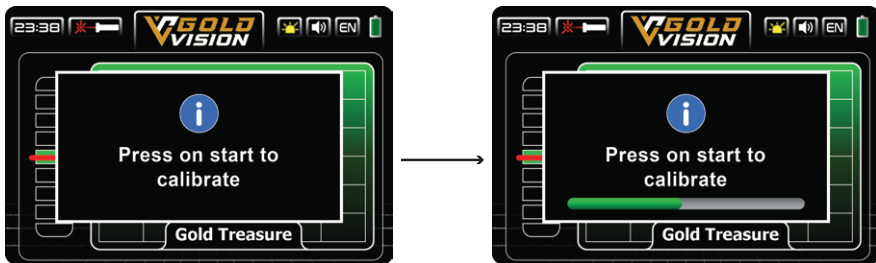

Note: To reset the calibration, press the start button on the handle and wait 5 seconds for the reset process to complete. Always try to keep the device in a horizontal position

Start Button

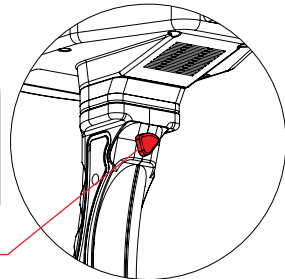

## Description of the Search Screen

After completing the initial settings, and skipping the previous warning, the search screen will appear.

### Screen Description:

**Search Screen:** This screen shows us within the large box the ongoing search process according to the previously selected settings.

**Balance Indicator:** This indicator shows the balance of the device in relation to the direction of the horizon. To get a better result when searching, this indicator (red line) should be on the green line in the middle.

**Selected Target:** In this box, it display the target type, which selected previously in the system settings.

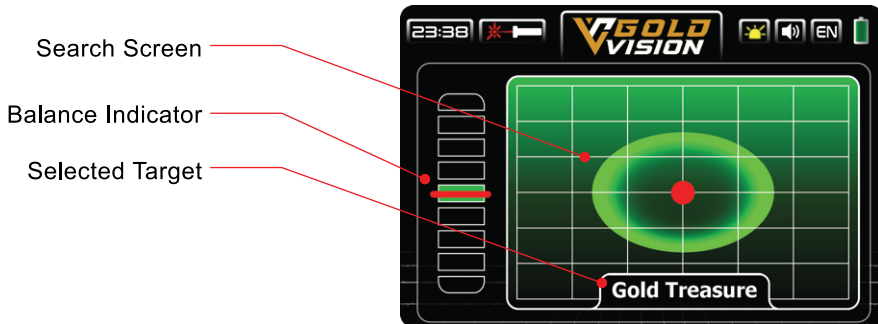

## Long Range System

### Device Balancing

In Long-Range system, the device searches for targets that the user chooses in advance, after specifying the correct settings in the system. Go to the area where you want to search and keep the device in a flat horizontal position without tilting to any side, here the user can calibrate the balance of the device using the balance indicator on the screen.

Make sure that the device's balance indicator (red line) is on the green mark in the middle of the indicator. You should also be aware that this requires a lot of concentration (for example, if you are tired, try to rest a bit and then continue the calibration process) in order to obtain a better and more accurate results.

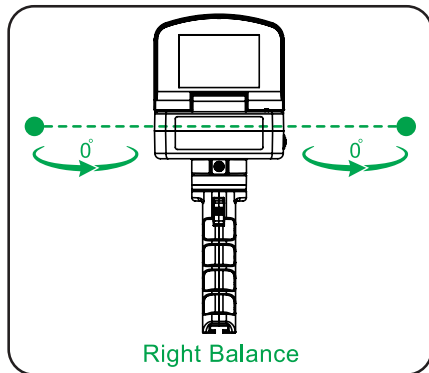
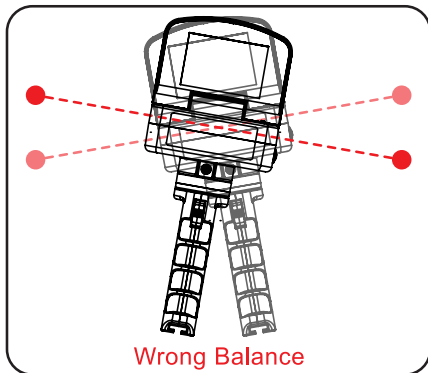

## Search Method

1: Search Method According To The Zigzag Path If Device Does Not Rotate: In the case of the initial or normal search, that is, when there are no targets or signals picked up by the device in the current search area, we must always advance according to the Zigzag path, in order for the device to capture and analyze as much signals as possible in all directions of the surrounding area.

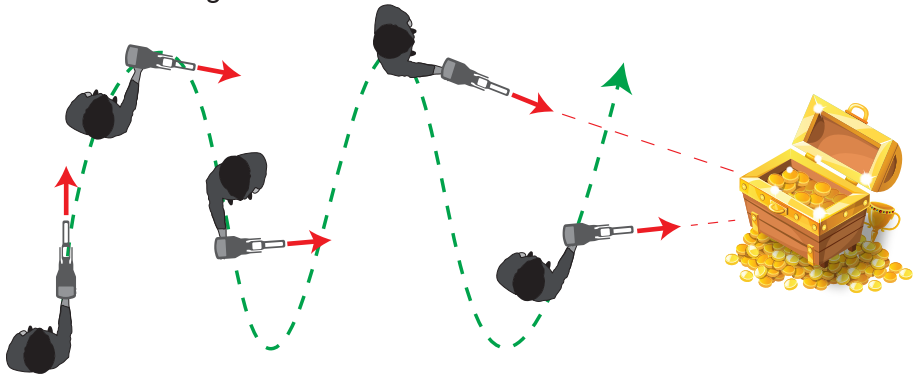

We always recommend starting from the northern region of the target search area. Until the device begins to rotate on its axis. Then the user must follow the method of determining the target area, which will be described in Paragraph 2.



## Long Range System

### 2: Determine Target Area if Device Rotates:

Suppose that we are now advancing in the search area specified by the winding path (Zigzag), and at some point in this path, the device begins to rotate around its axis to the right or to the left.

Then user here must advance following the direction of the device's rotation always, and then we will notice that the device leads us to a point or a certain direction.

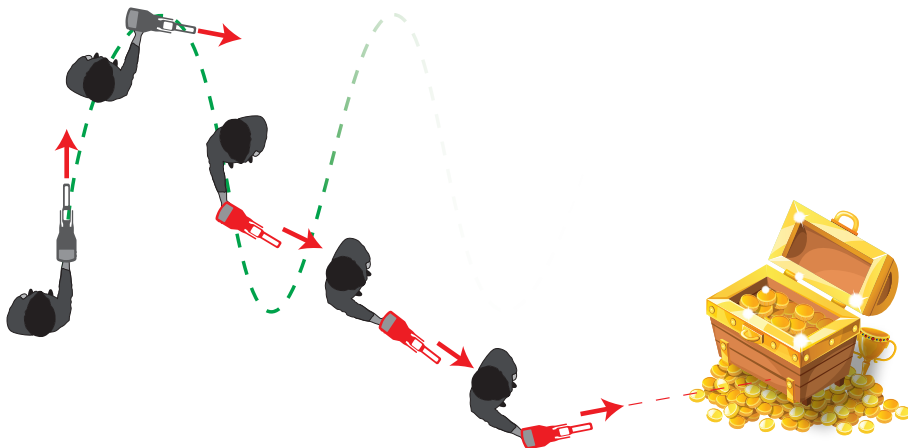

## Long Range System

We keep following the direction of rotation of the device, until the device begins to rotate around its axis for more than 90 degrees.

Then we mark this point.

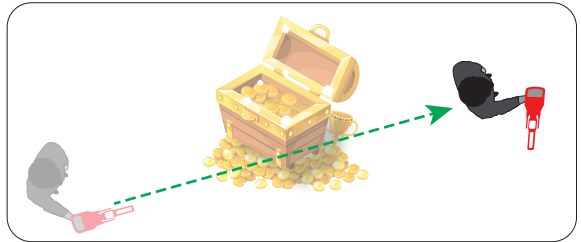

We go back in the opposite direction and slowly until the device rotates around its axis again for more than 90 degrees, we put a mark at this point as well. We repeat this process from different directions of the search area and mark each point where the device rotates. We will notice that it has begun to form a rough outline of the target area.

We will notice that the device always rotates towards a specific point or area.

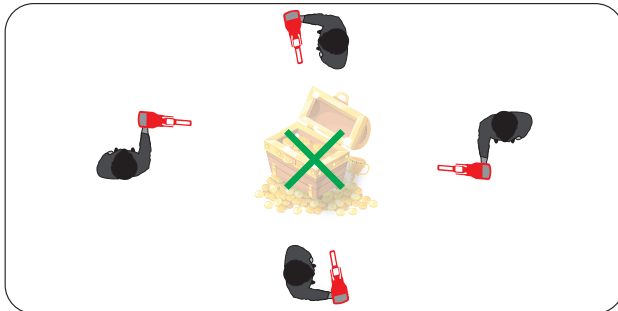

## Long Range System

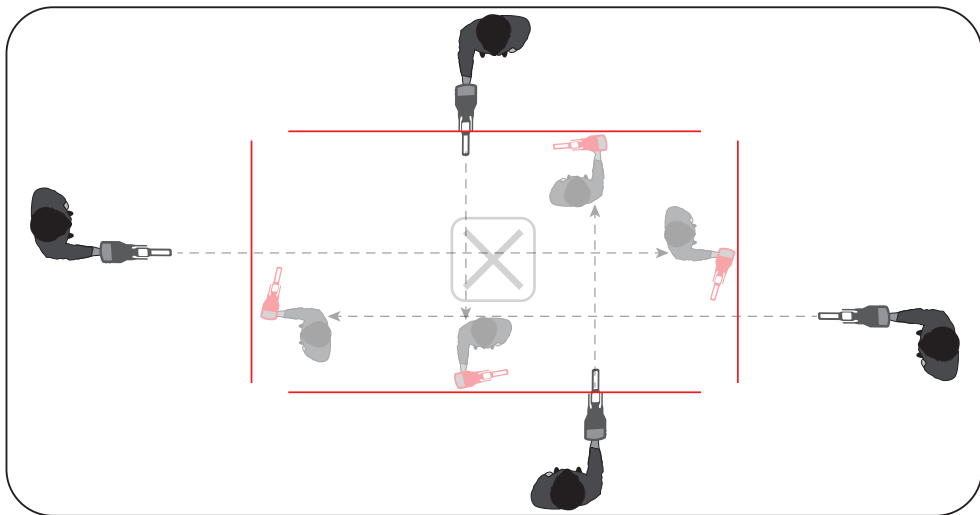

We move away a little from the drawn area (marked area) and start heading from the north side towards it, and at every point where the device rotates for more than 90 degrees, we draw a new transverse line.

We repeat this process from the four sides of the target area; we will see that a square or rectangular shape has begun to form for this area.

Let us say this region is (X). We follow the next step (the process of verifying the target area) to make sure and limit the target area more accurately.

3: The process of verifying the target area:

We start moving from the area (X) a few meters towards the north, and define a new point (A), and then we advance from the right and left of this point towards the area (X). If the direction of rotation of the device in both cases is towards the area (X), then this means that the area (X) is the possible area for the presence of the target.

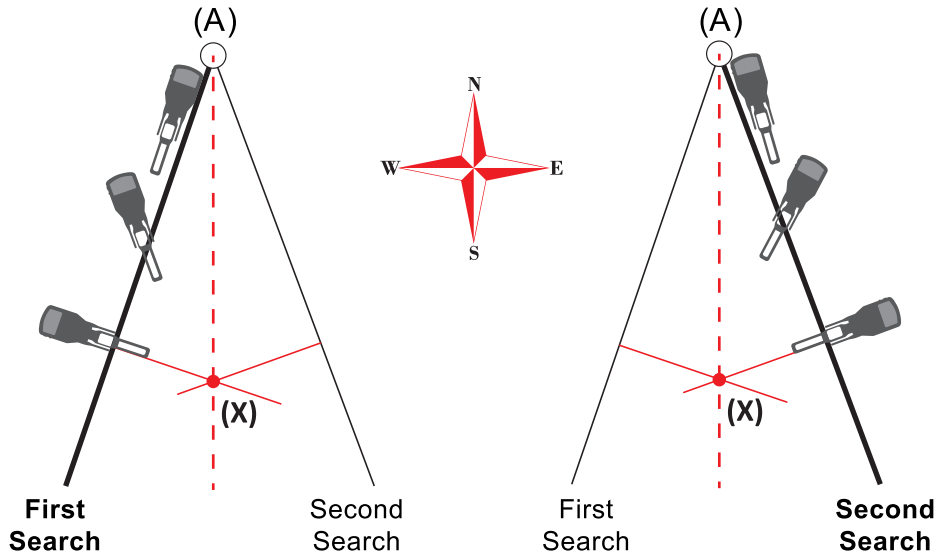

## Long Range System

In order to limit the target area more correctly, we repeat the previously mentioned process in more than one different direction for the potential target area (X).

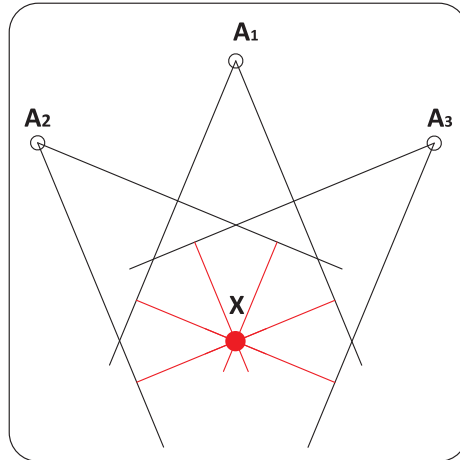

We always recommend that we proceed as slowly as possible while researching this situation.



### Free Mode System

Free Mode system in the Gold Vision device is similar to the principle of operation and technology found in the Long-Range scan system.

However, in this system we can specify an accurate value for the required search frequencies, to match a specific type of metal that we want to search for, in order to obtain more accuracy during search for specific minerals or specific targets.

**Install the handle, antennas, smart sensor and signal booster dish into the device. With the need to unlock the wireless, handle lock.**

Select the free mode system from the main menu and press the OK key to enter. Here we can customize the frequency value that we want precisely, instead of choosing the target type from the automatic list as in a long-range system.



We complete the remaining settings (such as the type of soil, the maximum distance and depth of the desired target) as in the long-range system, and start the search according to the Zigzag path also mentioned in the long-range system.

## Free Mode System

The way to search and adjust the settings in the free mode system is the same as in the long-range system, except for the option to select the frequency. Here in the free mode system, the user can customize the value of the frequency he wants very accurately that is, the user must select the frequency he wants from the Frequency option, instead of choosing the target type from the automatic list in the long-range system.

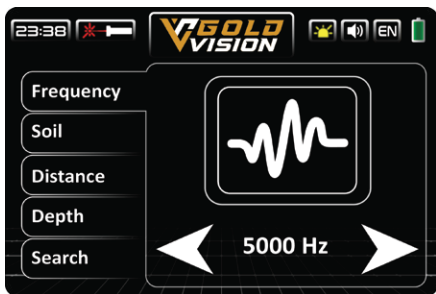

Free Mode System Settings

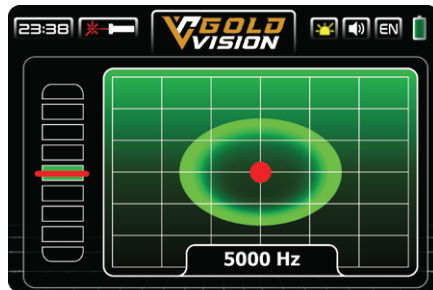

Search Screen

From the system settings, in addition to adjusting the frequency, we can also set the soil type, maximum distance and the maximum depth of the desired target.

Use the Up/Down arrows to switch between system tabs.





## Smart Depth System

Geoground, after a long period of research and using highly intelligent algorithms, was able to program and operate the new Smart Depth system. This system is able to calculate the approximate depth of a buried target with excellent accuracy.

The smart depth system in Gold Vision device is a unique system, through which the user can calculate or estimate the depth of targets buried underground accurately. This done by using a specific method that includes the user's movement starting from the "approximate target location", moving in two

different directions, and waiting for the antennas to move more than 70 degrees in each time , then the device will estimate the potential target depth value based on that.





## Smart Depth System

After completing the search using the previous systems (Long-Range and Free Mode), we mark and define the shape of our previously drawn area. Then we mark the center point of the selected target area, that is, so that this point is in the middle of the target area.

We are going to use this system to calculate the approximate depth of the target below this point.

**Install the handle, antennas and smart sensor into the device, and do not forget to unlock the wireless handle lock.**

Note: If the Smart Sensor is not installed on the device, a sensor error message will be displayed on the screen. Install the smart sensor correctly, and complete the search.

**First:** After entering the system screen, a message will appear asking you to stand over the central point of the target, we stand over the central point of the target and press Start button on the handle. We wait until the loading is completed, and we make sure that the device is properly balanced, that is, in a flat and horizontal position without tilting to any side.

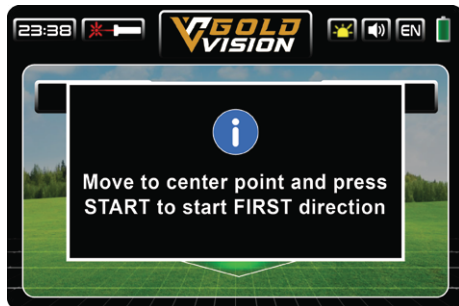

## Smart Depth System

**Second:** A message will appear indicating that we should proceed in the first path. We start moving forward towards the corner of the first path, and as we move forward with each step, we will have to press the Start button on the handle. We will notice in the corner of the screen the number of steps we have taken and the direction of the path we are taking. **Every path we take ends when the device starts turning left or right on its axis.**

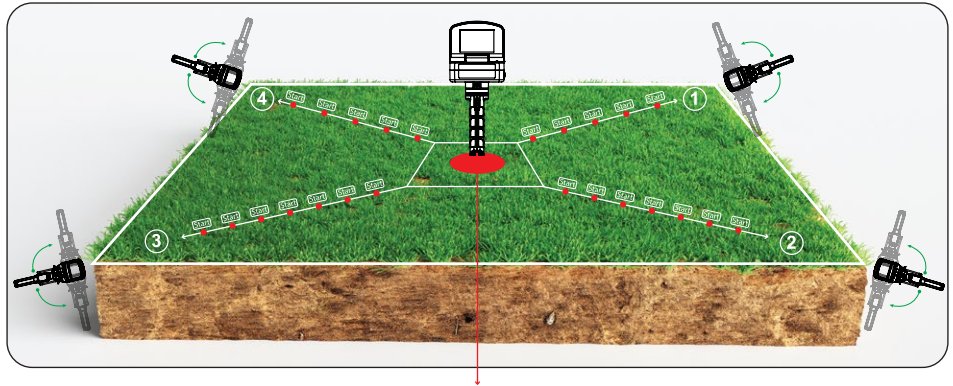

Starting Point (Central Point of Target)

User should pay attention to make the movement paths always in clockwise direction, that mean we start from direction number 1 then 2 then 3 and end with last direction 4, as shown in figure.



## Smart Depth System

Third: When the device is turning its direction, a message will appear to us stating that we must return to the central target point. We return to the central point of the target, and press Start button on the handle to start the second path. We follow the previously mentioned steps in the second path, followed by the third, and finally the fourth path.



Note: When progressing in any of the previous paths, we must always remember to press the Start button on the wireless handle once with every step we take in the specified path.

Direction:  
Back



Direction:  
Front



Direction:  
Left



Direction:  
Right



## Smart Depth System

After completing the four paths, a message will appear indicating that we have successfully completed all paths, and we can now know the approximate depth of the buried target.



We press the start button or the OK button from the keypad, and after a few seconds, the device will start calculating the depth of the buried target and display the result of the approximate depth of the target at the bottom of the screen, as shown in the picture below.

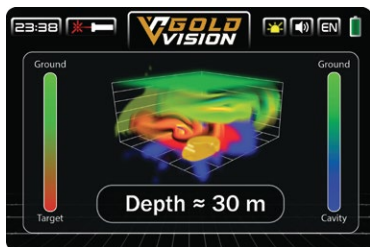

Note: The calculated depth in the Smart Depth System is an approximate and estimated depth.

We also point out the importance of balancing the device after completing each path we take, in order to obtain a better result for the depth of the target.

## Ionic System



Ionic search system developed according to a completely new technology, which is the first of its kind in metal detectors, and represents a great improvement over the traditional system that existed before.

The new technology allows for a more accurate detection of ionic fields resulting from metallic targets buried underground, ensuring accurate signal reception and processing in the device.



The emanating ionic fields from the potential targets detected by using Smart Sensor, a special purpose probe with new technology designed to allow accurate detection of ionic fields, the probe installed in special port on the front side of device main unit.

When selecting the ionic system in the device, the device will show us on the search screen two-progress bars.

The first at the top reflects the signal strength coming from a metallic target such as gold or iron, and the second bar at the bottom shows us the signal strength resulting from an underground void such as a tunnel, grave or some gap. **Install the handle and sensor into its ports, with the need to lock the wireless handle lock.**

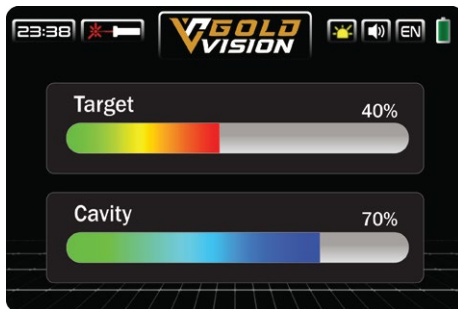
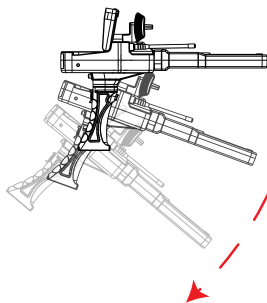

After entering the ionic system screen, the user must press the Start button outside the search area in the opposite direction in which we want to search, in order to calibrate the sensor.

Then we slowly move the device up and down at the same speed, while tilting the device slightly towards the surface of the ground.

## Ionic System

The status of the progress bar and the percentage on the screen will change according to the proximity and strength of the captured signal to the target, whether it is an ion target or a gap (space).

If there is a signal close to the target, the target progress bar will display on the screen the percentage of the signal captured from the ion target.



Target Percentage Indicator

If there is a signal that is a cavity or void nearby, the gap progress bar will display on the screen the percentage of the signal captured from the nearby cavity.



Cavity Percentage Indicator

To make sure the signal is correct, we reset the system by pressing and holding the Start button once, but in a different direction than the one from which the signal was taken the first time. We repeat this step more than once and in different directions, so if the same signal continues to appear with the same values, it means that the signal picked up by the device is correct.



## Bionic System

The Bionic system works in a similar way to the ionic system, but with the difference that here ionic signals are captured from a specific metal object, for example from a gold coin, then the search is directed towards capturing signals similar to metal objects buried underground within the surrounding area.

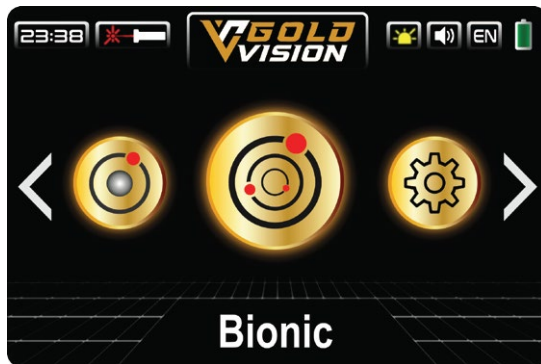

In the previous ionic search system, the search is random and free, but in the bionic system, the search is directed according to a specific target type based on predefined signals.



## Bionic System

### How to Use:

**Install the handle and the sensor into its sockets in the device, and pay attention to lock the wireless handle lock.**

Point the smart sensor head at the metal target of the type of metal you want to find, and then press Start button on the handle.

Move the device slowly in all directions and wait for the results on the system screen. Repeat this process again to get better results.

When this system is turned on, we will notice that the laser light has started to work automatically, and this will help in capturing the signals of the desired target type more accurately.

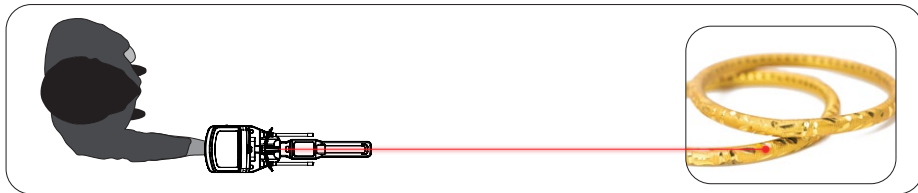
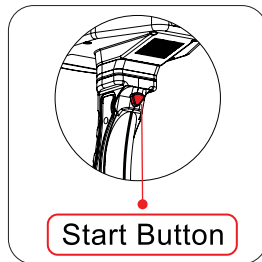

Note: If we want to search for a different new target, we just direct the device and the laser light towards this new target and press Start button, and repeat the previous process again.

In the event that there is, a signal close to the search location or a signal similar to the signal captured by the metal whose signal we picked up previously (the sample signal).

A red moving circle will appear on the indicator in conjunction with sonic alert (audio tone) indicating that the device has started to pick up the signals and has found the desired target.



Bionic system indicator  
in case of target capture



Bionic System - Search Process

When there is no signal to be picked up by the device, only a green moving circle will appear on the indicator, and without the device making any accompanying sound.

To make sure the signal is correct; the user must return to the first metal target and repeat the process again.

## Settings

When you turn on the device for the first time, the Language settings screen will appear; we can choose the desired language for us and press OK, after which the main screen of the Gold Vision device will appear.

We can access the device settings from the main menu.

To enter any section of the Settings, we select required setting and press the OK button on the keypad of the device.

The device settings sections are: **Time - Display - Sound - Language – Info**



### Time:

We can use this section to set the device's clock time. To change the time, press the OK button on the keypad once to move to the time section, then the hour number will change to red, use the Up and Down keys to change the hour. To move to the minutes pane press the right key, and use the Up and Down keys to set the minutes value.

## Display:

In this section of the device settings, you can see settings related to the screen such as sleep mode, screen brightness, and smart sensor LED light.

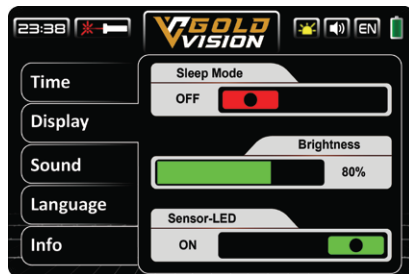

### 1. Sleep Mode:

With this option, the device screen will go to sleep mode and turn off if the device not used for one minute, to turn the screen on back again, press a key on the keypad.

To turn the Sleep Mode option on or off, we press the Left / Right keys on the keypad.



### 2. Brightness:

Use this option to adjust the screen brightness level.

You can increase or decrease the device screen brightness value using the left/right keys.

## Settings

### 3. Sensor - LED:

By turning this option on, the LED light indicator of the Smart Sensor will be turned on during the search, as the user can see the search results and visualization of the multiple device systems through the changes of sensor LED light color.

The red light indicates the presence of metals of different types.

The blue color related to the presence of voids or cavities in the search area.

The green color indicates the normal state of the search (normal ground).



### Sound:

In this section, the user can control the volume of various sounds made by the device, such as the general sound of the device, the sound of keypad clicks, and the sound issued during scan.

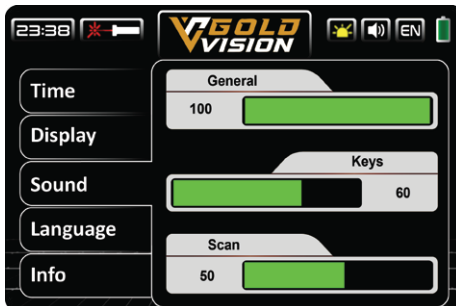

**Language:**

The device user interface is available in eight languages:

English - German - Spanish - French  
- Russian - Italian - Arabic - Persian



We can change the language of the device, after entering the language settings section, using Left/Right arrows of the keypad.

**Info:**

In this section, the user can see the complete information about the device (The values of this page cannot be changed).

After finishing adjusting the settings, we can go back to the main menu by clicking the "Back" button on the keypad.

## Wireless Handle Charging

This device is equipped with an RF system for wireless communication between the device and the handle. After prolonged and intensive use of the device and the handle, the capacity and charge of the handle may decrease. Here is how to charge the handle.

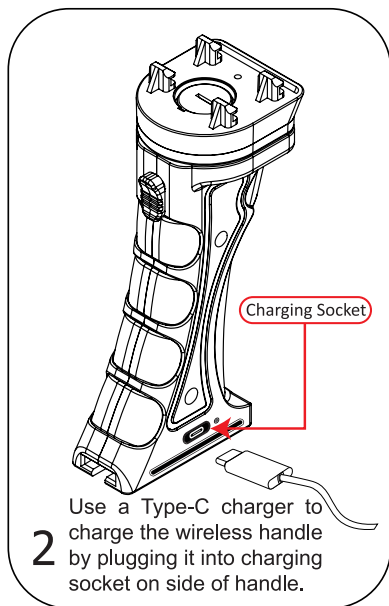
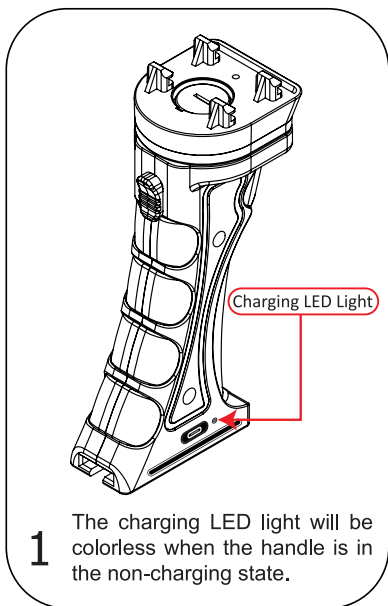

## Wireless Handle Charging

Pay attention to ensure the charging a device handle for a minimum of 5 to 10 minutes before using it.

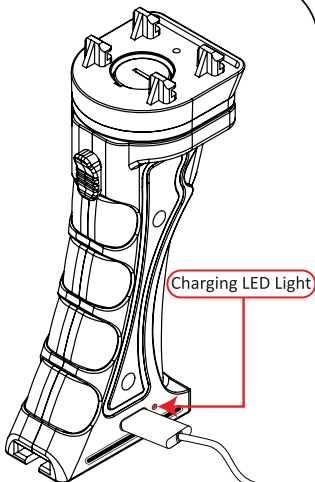

**3**

The charging LED light near the charging socket will light red, which means the handle is being charged.

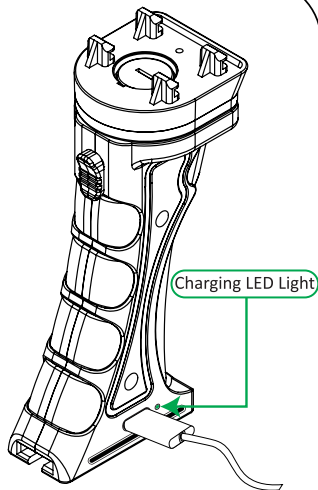

**4**

The light turns green when the handle is fully charged.



## Technical specifications

CPU	Type	ARM
	Frequency	72 MHz
Memory	Type	SD
	Capacity	2 GB
Screen	Type	TFT LCD HMI
	Size	3.5 INCH
	Resolution	480 X 320
	Color	64 K 65536
	Back Light	LED
Sound	Output	Speaker + Headset
	Jack Type	3.5 mm
	Internal Speaker	3W
Charger	Input	100 – 220 V 50 / 60 Hz
	Output	5V - 2.5 A
Battery	Type	Lithium Ion
	Input	5V - 2.5 A
	Capacity	9600 mA
	Removable Battery	No
Other	Flash LED	5mm
	LAZER	650nm /5mw
	Vibration	Yes
Temperature	Operating Temp	0 – 40 C
Package	Dimension	400 mm X 300 mm X 160 mm
	Weight	3200 g

# VF GOLD VISION

VISUALIZE GOLD  
AND GET IT

