

T Gold And Metal Detector TITAN GER 1000



GERMAN INDUSTRY
WWW.GERDETECT.DE

TITAN GER - 1000

5 Systems in 1 Device

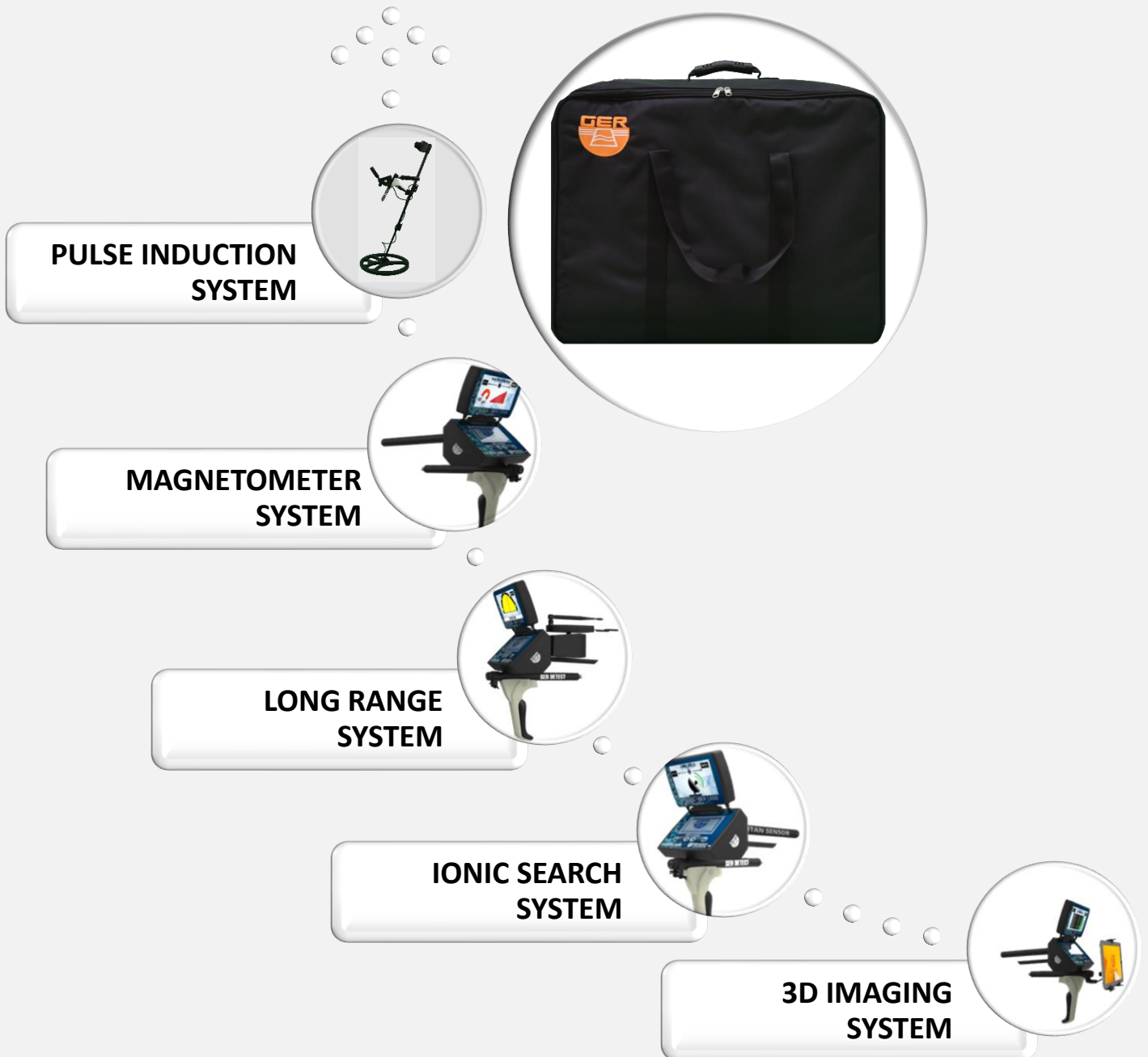



Critical Warning



Please be sure that all precautions taken against risks:

Do not use your device while it is raining or on extremely wet floor.

Turn on your device after you make sure that all parts are in place

Make sure that the device battery is fully charged before searching.

If the battery starts to give a peep sound, close the device and recharge the battery.

Do not start the pulse induction system without connecting the coil cable to the device, other ways the device will stop in the middle of opening.

It is recommended to read the user manual before start working on the device to understand everything and to avoid mistakes doing the search

After the device start make sound and turn off automatically put the battery on charge and do not try to start the device without charging the battery

Be aware of high voltage resources, and do not use any charger other than the original charger that come with the device

Main unit of the device is under warranty against all electronic breakdowns for two (2) years

Any damages caused by user errors (laying open the main unit, hits, harms etc.) are not within this warranty

Battery, antenna and tablet are also not within this warranty

You should follow the instructions in this user manual strictly to minimize the faults and to use your device correctly



Overview

- Dear customer, thank you for choosing the TITAN GER – 1000
- This device enables you to detect underground gold & Treasures
- TITAN GER – 1000 designed to reach up to 45 meters under the ground
- and 2500 meters front range
- In addition, it contain five systems to confirm your target
- and identify the target underground and its depth



WARNING

**when you hear a continuous beep sound
turn the battery off immediately
and put it on charging
to save the battery life**

1

The Long Range System

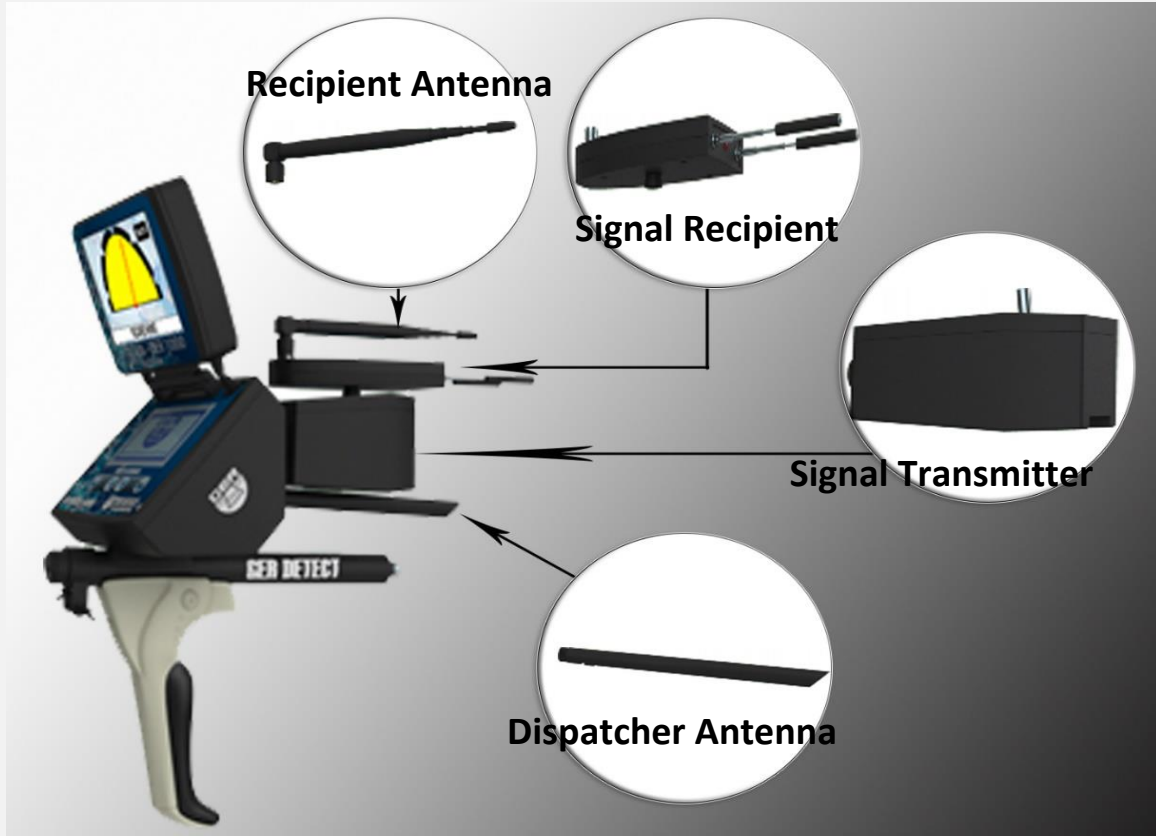

This system specializes to cover vast areas and locate the target with in 1 meter Square up to depths of 45 meters below the surface of the ground and Front Range up to 2,500 meters.

The long-range system parts

Connect the Dispatcher
Antenna



Connect the Signal
Transmitter



Connect the Signal
Recipient

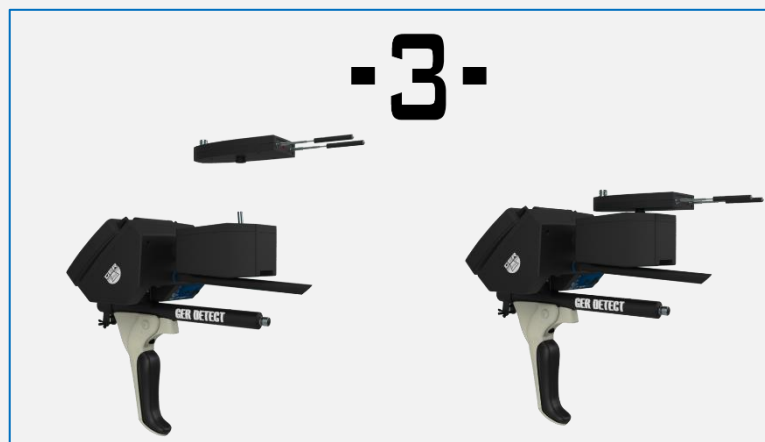

Connect the Recipient
Antenna

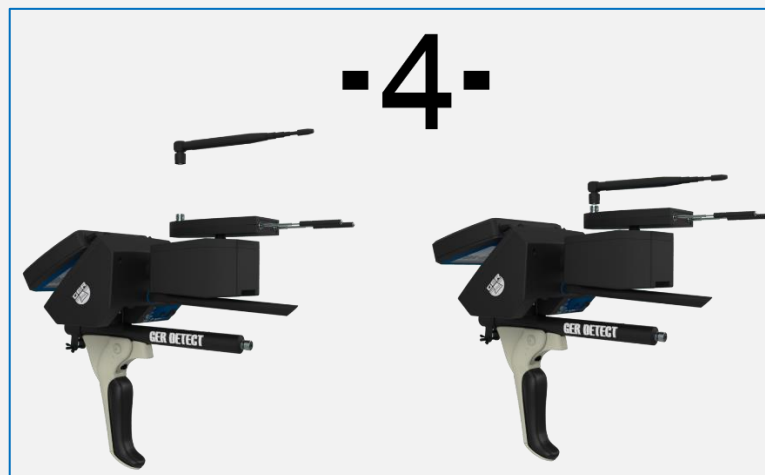

- Connect the Battery to the Device
- Open the Device Screen and Start The Device Through **ON / OFF** switch



CLICK ON THE SCREEN OF THE DEVICE TO DISPLAY THE LANGUAGES LIST
THE DEVICE WORKS ON FOUR LANGUAGES:

(GERMAN-ENGLISH-FRENCH-ARABIC)



Press on setting icon to enter to setting screen



Press on information icon to enter to information

After selecting the language, you want to work in (English for example)

The search systems menu will appear (Select long-range search system)

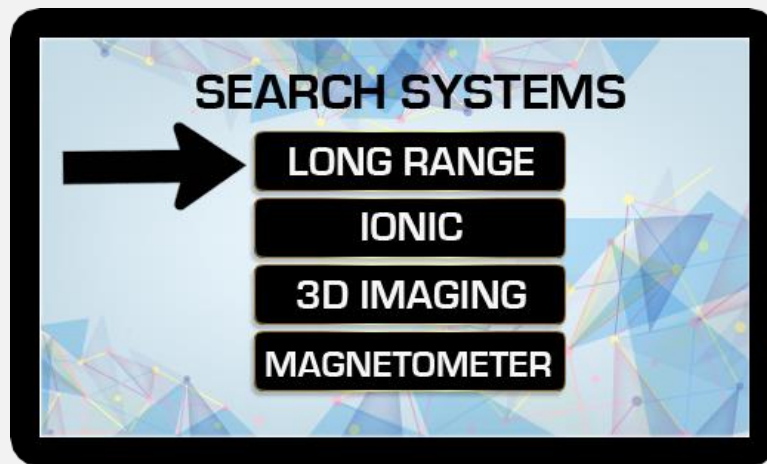

After selecting the long-range system, the metals that this system can detect will appear :

Choose the metal to be search for from a list of metals through pressure on the metal name, (BURIED GOLD FOR EXAMPLE)



After selecting, the metal to be searched for, the Front Range Options will appear

Choose the Front Range according to the area you want to reach

You can select between (0500 M - 1000 M - 1500 M - 2000 M - 2500 M)

Choose 2500 M for example.

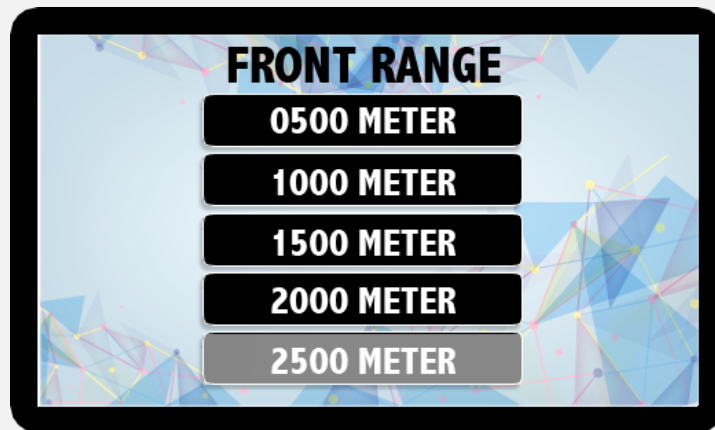

After selecting the Front Range, the search screen will appear which contain an indicator, which will guide you directly to the target. Make sure that the antenna is pointing ahead

Adjust the antenna with the indicator on the screen to receive accurate signal

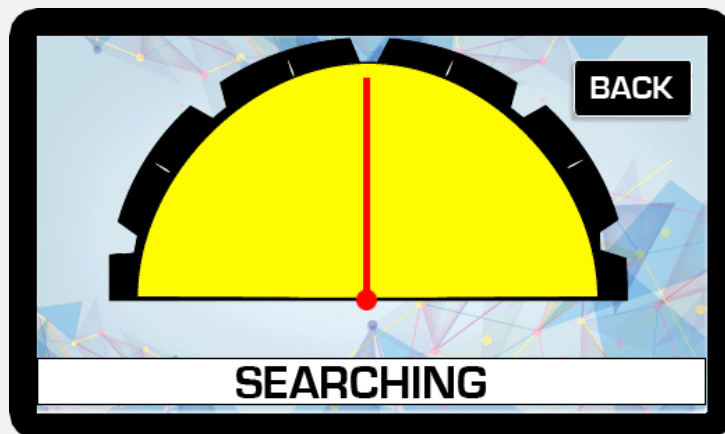

Increase the length of the antennas receiving a signal

To able the device to detects targets even to **2500 meters**

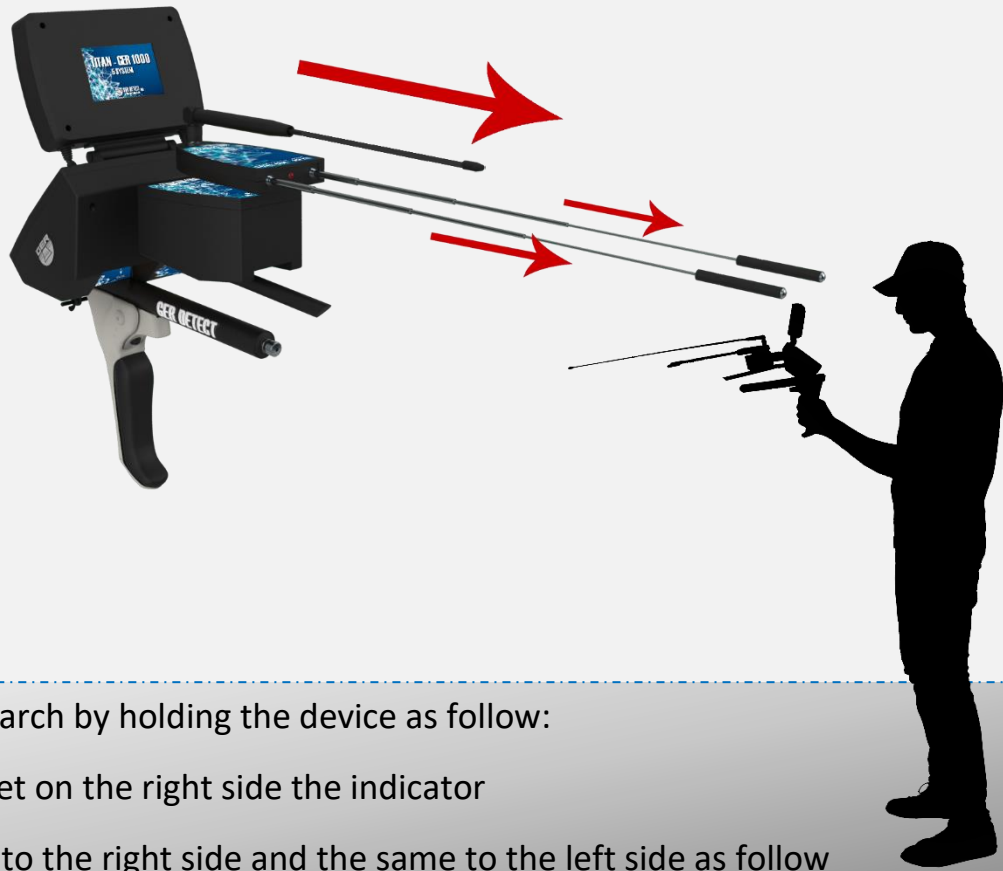

Star the search by holding the device as follow:

If the target on the right side the indicator

Will Point to the right side and the same to the left side as follow

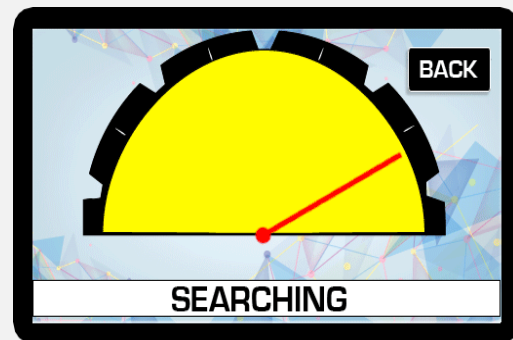
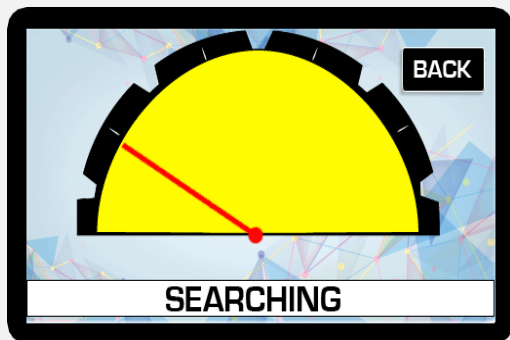

After detecting the target, confirm the target from four direction



North to South

South to North

East to West

West to East

To determine the depth of the discovered target Stand above target and turn **45 degrees**

Walk straight ahead until the antenna reverse to the back

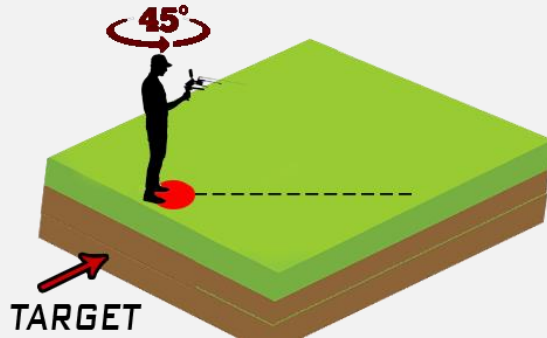

Measure the distance between the antennas reversing back and the target center point.

The distance between the antennas reversing back and the center point is equal the target depth

For **example**, if the distance is **10 m** the depth of the target is **10**.

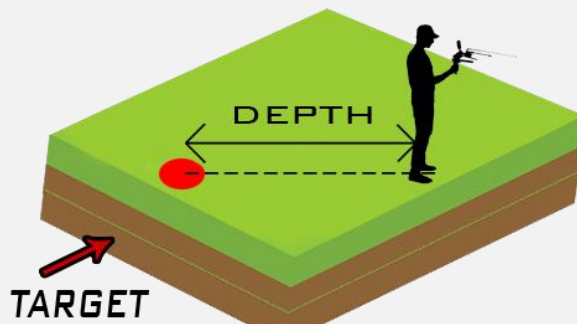

Note: The target must be buried underground for many years so that by the time and interaction with the soil's composition, an ionic field will be formed which will help prospectors to detect the target.

Therefore, testing the device on metals laid on the ground or newly buried under the ground will not show the real capacity and functionality of this device to detect the target or to reach larger depths.

The reason for that is that the ionic fields are radiations from gold and other metals that have been in the ground for a long time and have intersected and interacted with the soil and the nature of the earth as well as having been regulated with magnetic fields north and south – These features do not actualize in gold and other metals when they exist on the ground or newly buried.

2

The Ionic Search System



This system specializes to cover vast areas and locate the target with
In **1** meter Square up to a depths of **45** meters below the surface of
The ground and Front Range up to **2500** meters vertical

Connect component

Connect the Ionic
Sensor

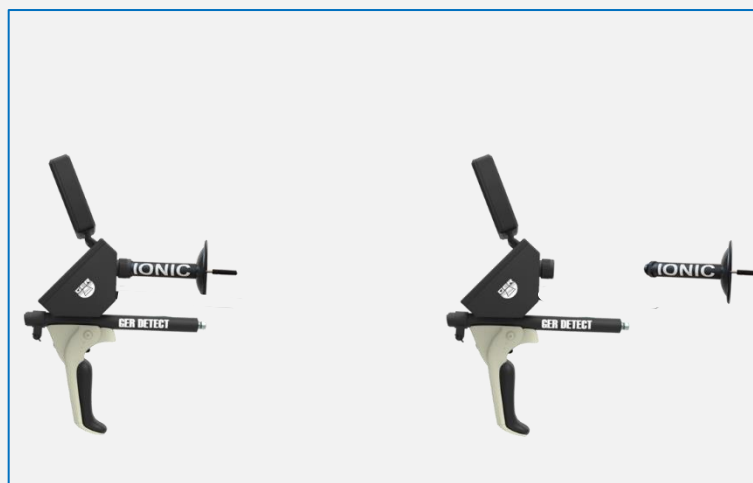

- Connect the Battery to the Device
- Open the Device Screen and Start the Device through **ON / OFF** switch

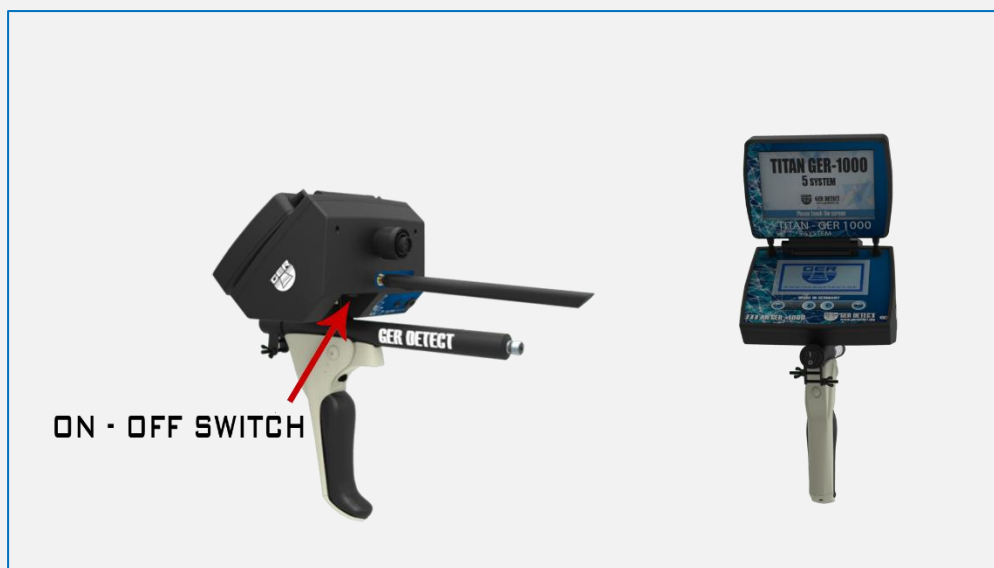

Click on the screen of the device to display the languages list
the device works on four languages:
(GERMAN-ENGLISH-FRENCH-ARABIC)

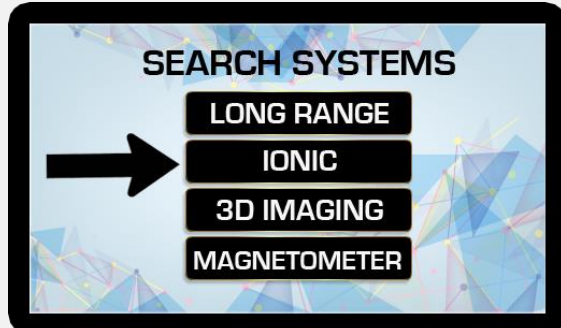

After selecting the language, you want to work in (**English for example**)
The search systems menu will appear, Select **IONIC** search system

After selecting the ionic system you have to determine the direction
from north / south



North to South

South to North

East to West

West to East

After selecting the ionic system, the search screen will appear.

Point the device to the ground if the device start to make a sound you must calibrate

The device with the ground by pressing on the **calibration button** as follow:

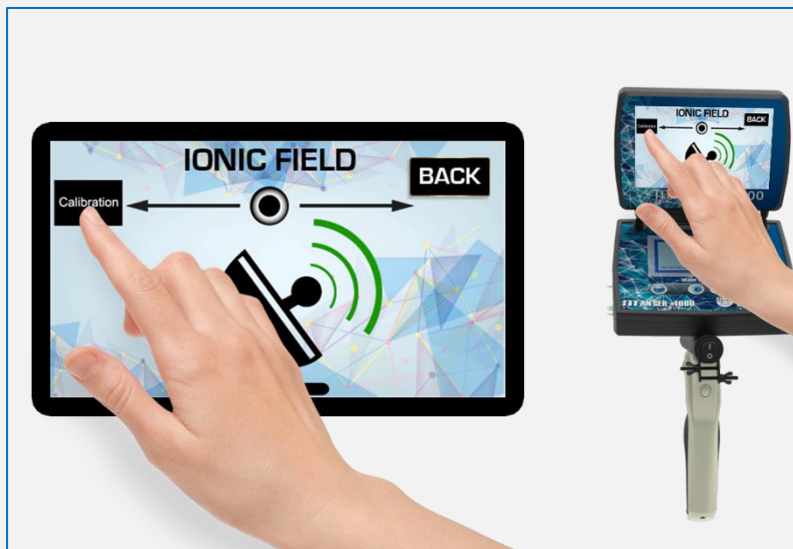

After you finish the calibration, start the search by moving the device **180 degrees** right and left.

When the device detect a target, it will start to make a sound.

In addition, the indicter will start to move to alert you about the target discovered.

The sound will start Accelerating when you will be close to the target.



You can also use the ionic search system during the driving in a moving vehicle... as follow:



In the event of lack of vision, you can operate the laser to locate the target place.

Through the laser ON / OFF, button

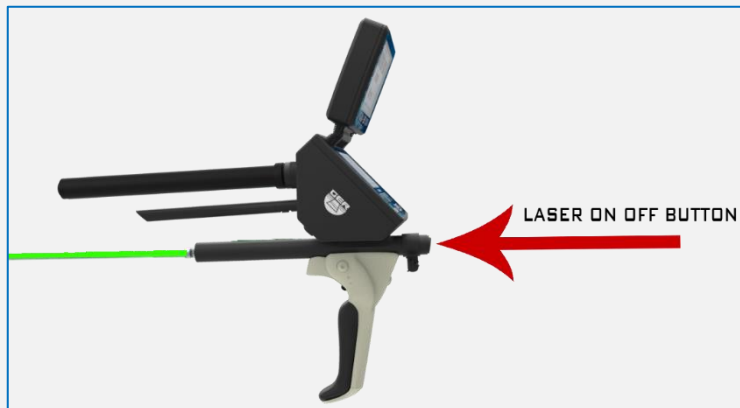

Note:

When you use the Ionic Search System the researcher should avoid directing device northward never, because the device will make a sound (This is because the device in this case will be Reverse of magnetic fields, which is directing from north to south)

Note: The target must be buried underground for many years so that by the time and interaction with the soil's composition, an ionic field will be formed which will help prospectors to detect the target.

Therefore, testing the device on metals laid on the ground or newly buried under the ground will not show the real capacity and functionality of this device to detect the target or to reach larger depths.

The reason for that is that the ionic fields are radiations from gold and other metals that have been in the ground for a long time and have intersected and interacted with the soil and the nature of the earth as well as having been regulated with magnetic fields north and south – These features do not actualize in gold and other metals when they exist on the ground or newly buried

3

3D Imaging System



This system specializes to show you the area scanned on the tablet screen in three-dimensional photo and through which you can specify the target size, shape and depth of the target underground up to 45 meters.

Connect component

Connect the
Dispatcher Antenna

-1-



Connect the 3D Imaging Sensor

-2-



Install the Tablet Holder To The Device

-3-



Fix the tablet that supplied with the device on the tablet holder which Contains analysis program to display the photo

-4-



- Turning to the tablet to make a Bluetooth connection between the device and the analysis program.
- Click on the Desktop option

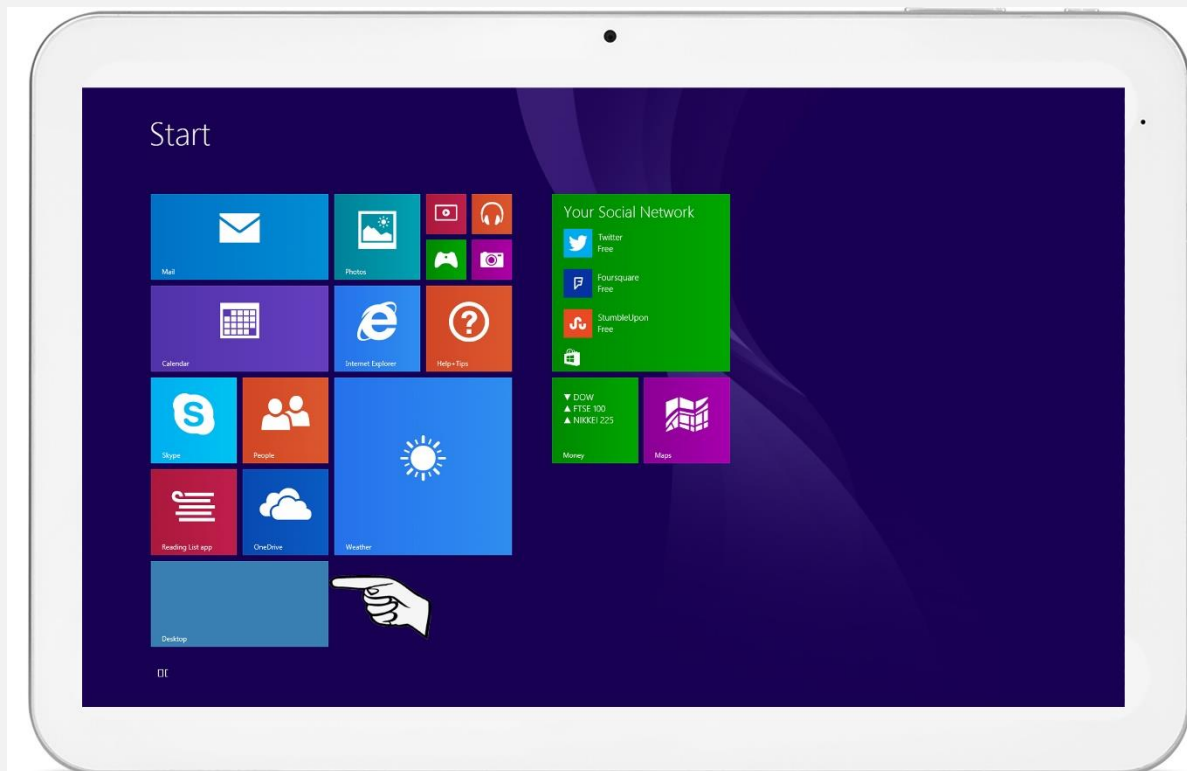

The desktop screen will appear.

- 1- Touch the arrow to reveal the hidden icons.
- 2- Click on the Bluetooth icon.
- 3- Chose add a Bluetooth device

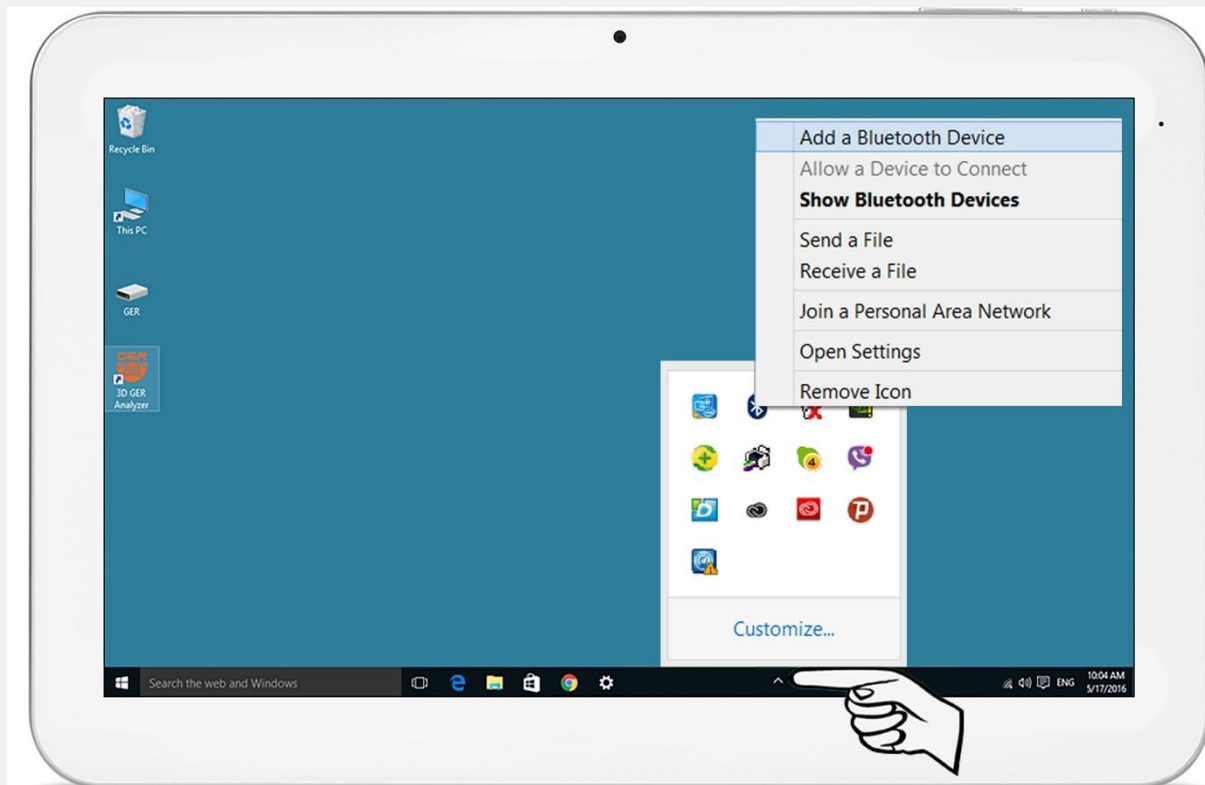

The tablet will start to search for any devices with Bluetooth in the area.
When the device Bluetooth appear click on pair.

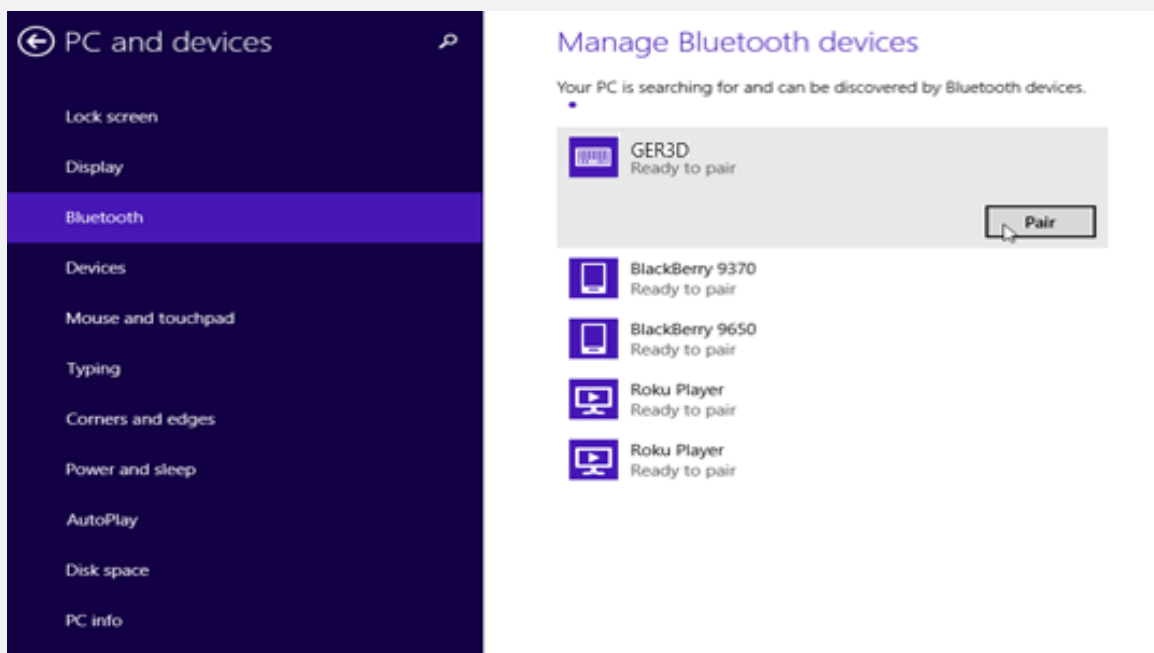

NOTE: The Bluetooth password is **1000**

Now select the **3D IMAGING** system from the systems menu in the device.

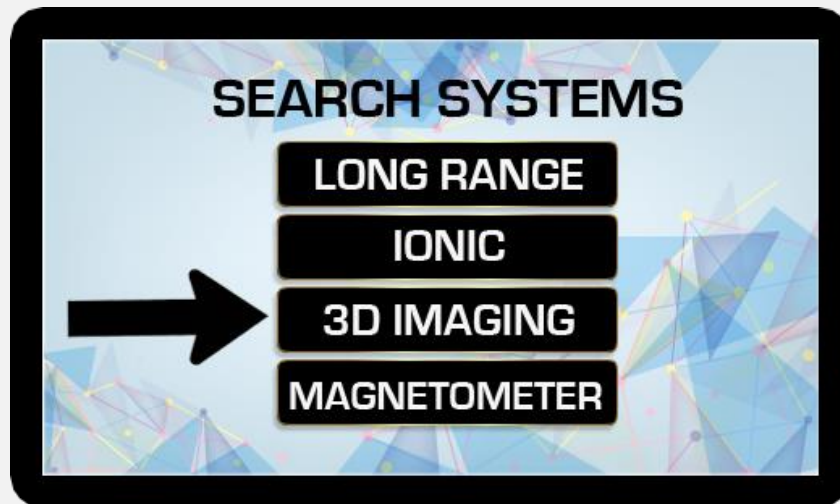

After selecting the 3D imaging system, the search screen will appear.

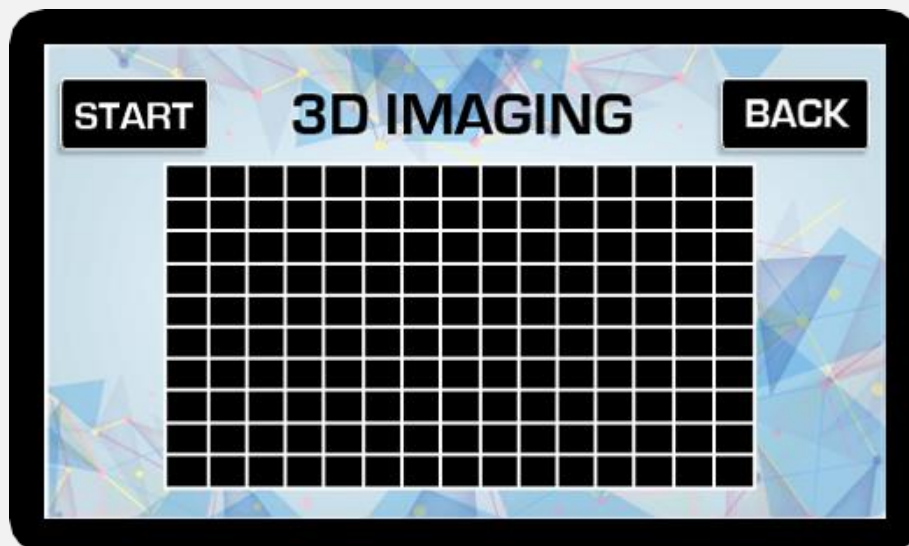

Open the 3D GER Analyzer that installed on the tablet

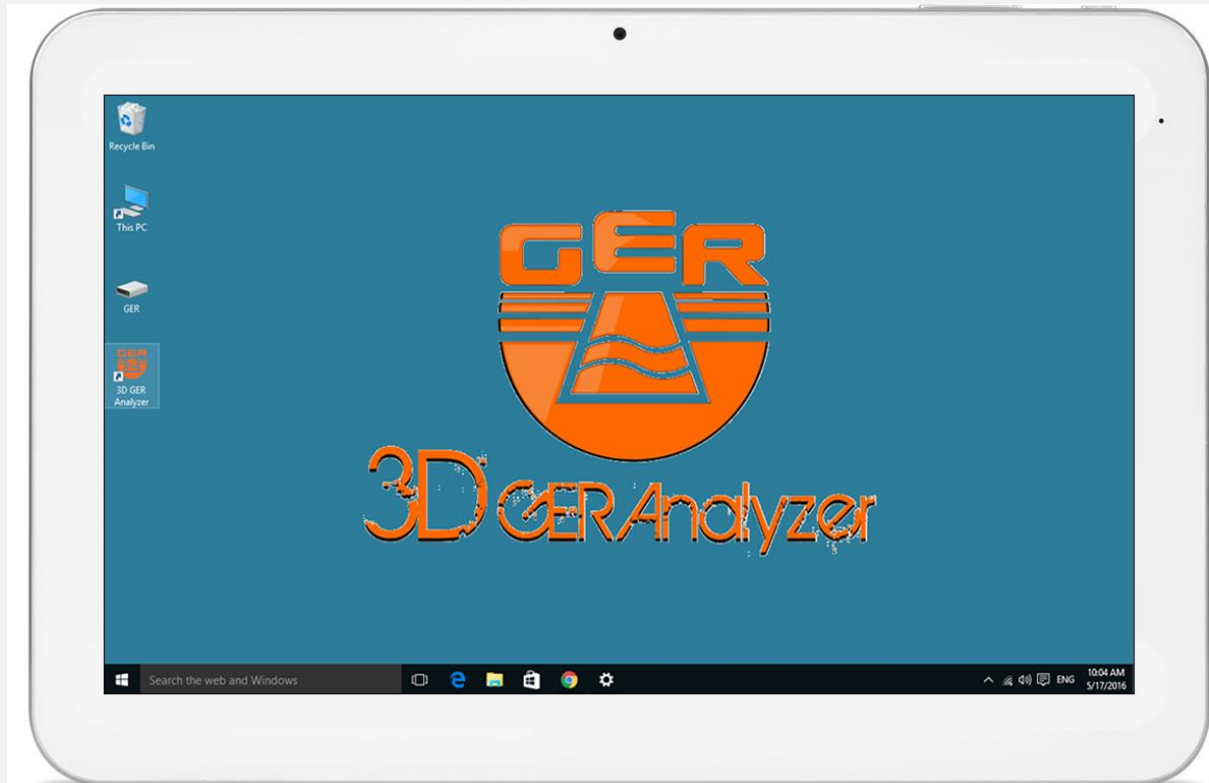

Start a new project to scan the ground by clicking on new scan

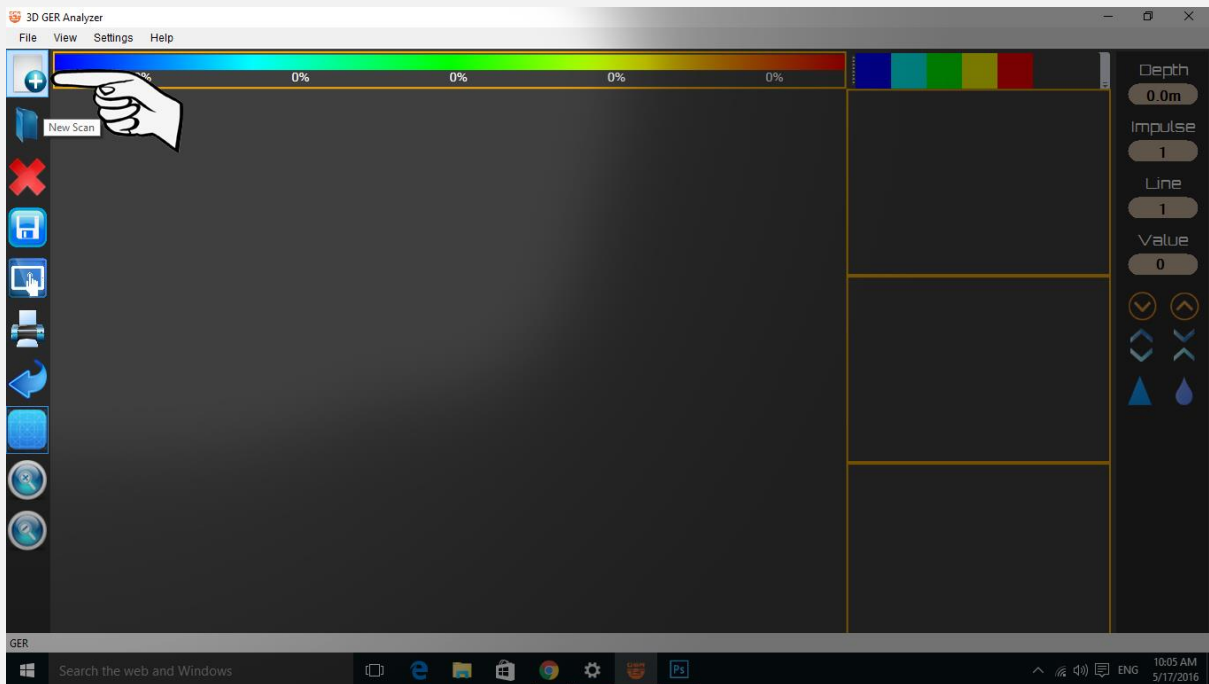

The connection settings window will appear on the screen.

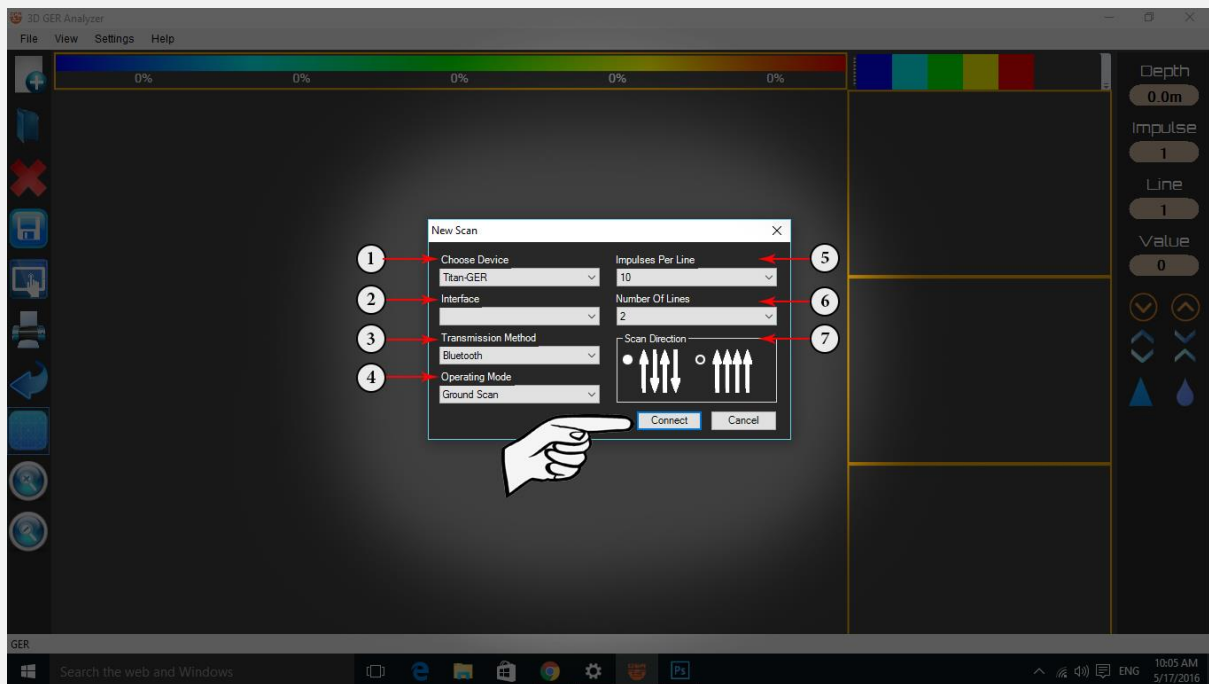

Enter the settings as follow

- 1- CHOSE DEVICE: **TITAN GER**
- 2- INTER FACE: OPEN THE BLUETOOTH SETTINGS AND ENTER THE COM NUMBER (OUT GOING) FOR EXAMBLE **COM 17**

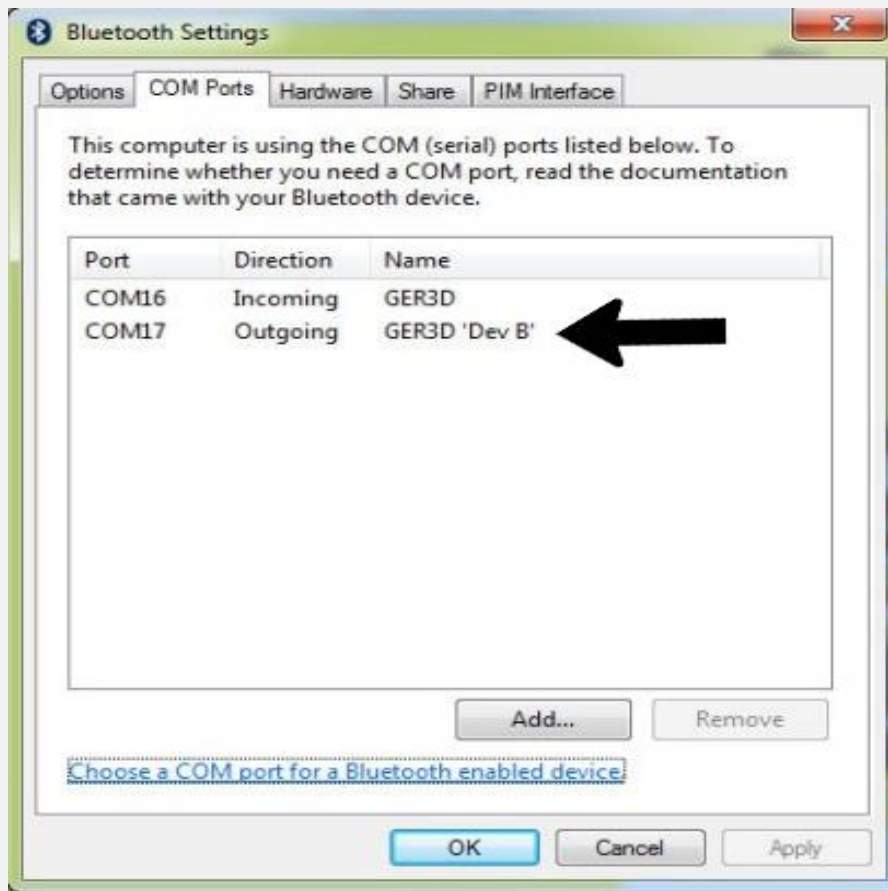

3- TRANSMISSION METHOD: **BLUETOOTH**

4- OPERATING MODE: **GROUND SCAN**

5- IMPULSES PER LINE: **10 TO 50 (EACH IMPULSE = 30 CM)**

6- NUMBER OF LINES: **1 TO 15 (EACH IMPULSE = 30 CM)**

7- SCAN DIRECTION : **OPTIONAL**





After you enter the settings, click on connect and shift to the device.

Therefore, the device will start taking pictures as follow:

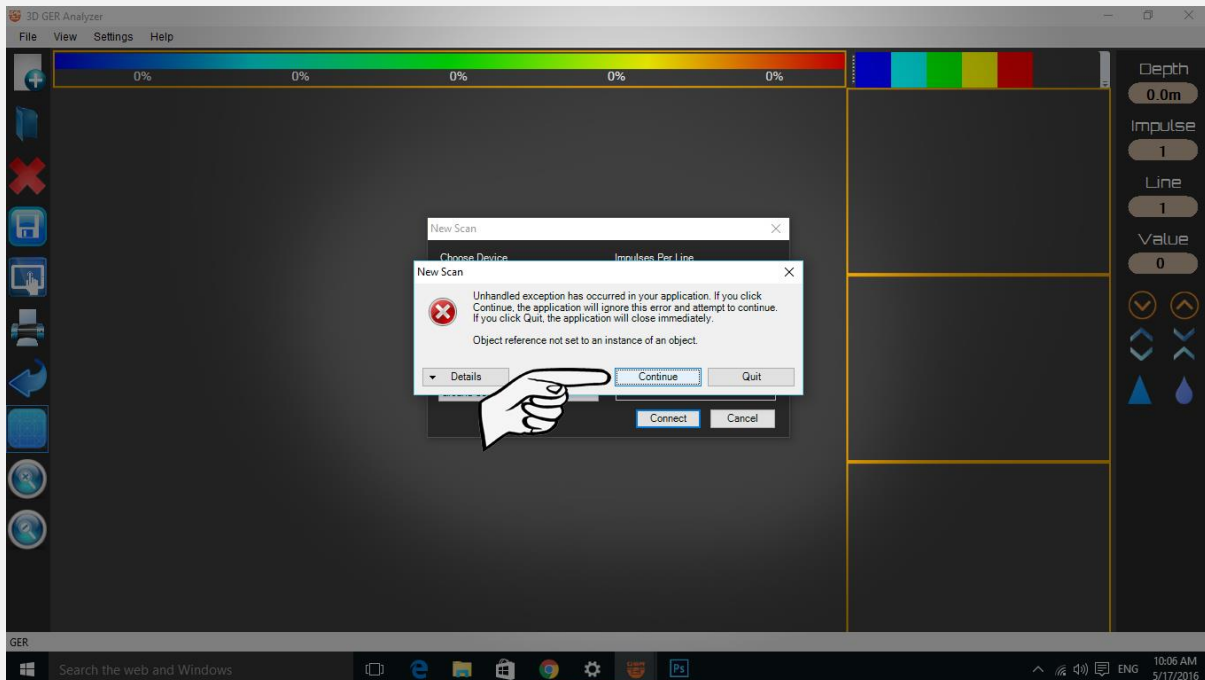

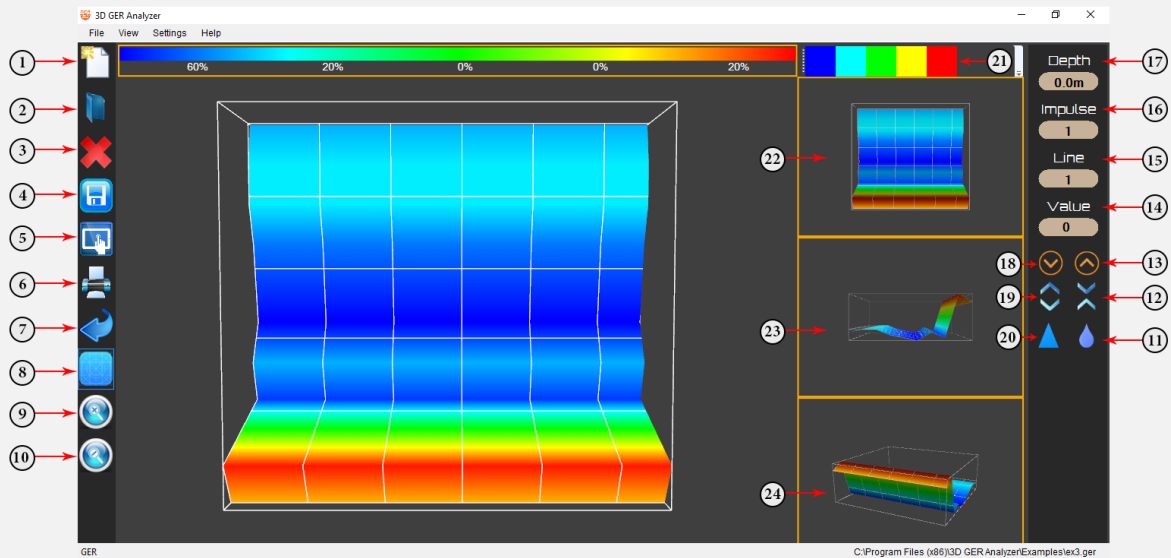

NO	Explaining
1	Start new scan and disconnect after scanning finish
2	Open file from your tablet already existing in your tablet
3	Cancel the scanning or delete the photo
4	Save the photo as a GER file to re-open it any time you want
5	Save as a photo with no option to change anything in the photo shape
6	Print report allowed you to see the where about of the metal and the other elements
7	To return the photo as it is being before you start analyzing
8	To hide and appear the grid which Represent the number of photos in the scan
9	Zoom in to make the picture bigger

10	Zoom out to make the picture smaller
11	A Tool you use it in case of not clear target to see the correct shape (-)
12	to make the target in low size
13	Move up between the grid squares to pin point the area that you want to know its depth
14	The value which will difference between the metals, the cavity and the ground
15	The number of lines that you have been scanning
16	The number of pulses (photos) you have been taking
17	The depth: when you can see the target exact depth
18	Move down between the grid squares to pin point the area that you want to know its depth
19	to make the target in high size
20	A Tool you use it in case of not clear target to see the correct shape (+)
21	These options allowed you to see the target in 2D & 3D shape and you can hide the soil for example or the metals and keep the cavity
22	Another way to see the target from down
23	Another way to see the target from the side
24	Another way to see the target from the angle

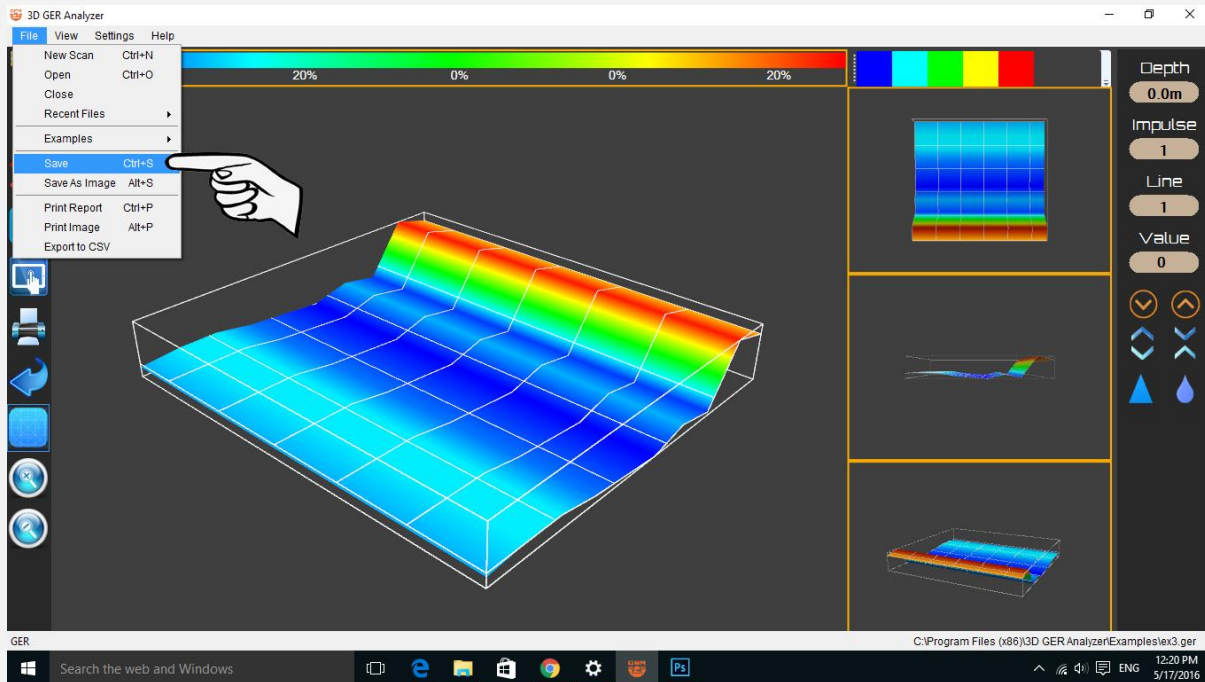

After you finish the scanning you can save the scan on the tablet as a project to be able to analyze again also you can save it as a photo

Note: Here is the color system

Red	Metal	Green	Ground
Yellow	Minerals	Blue	Cavity

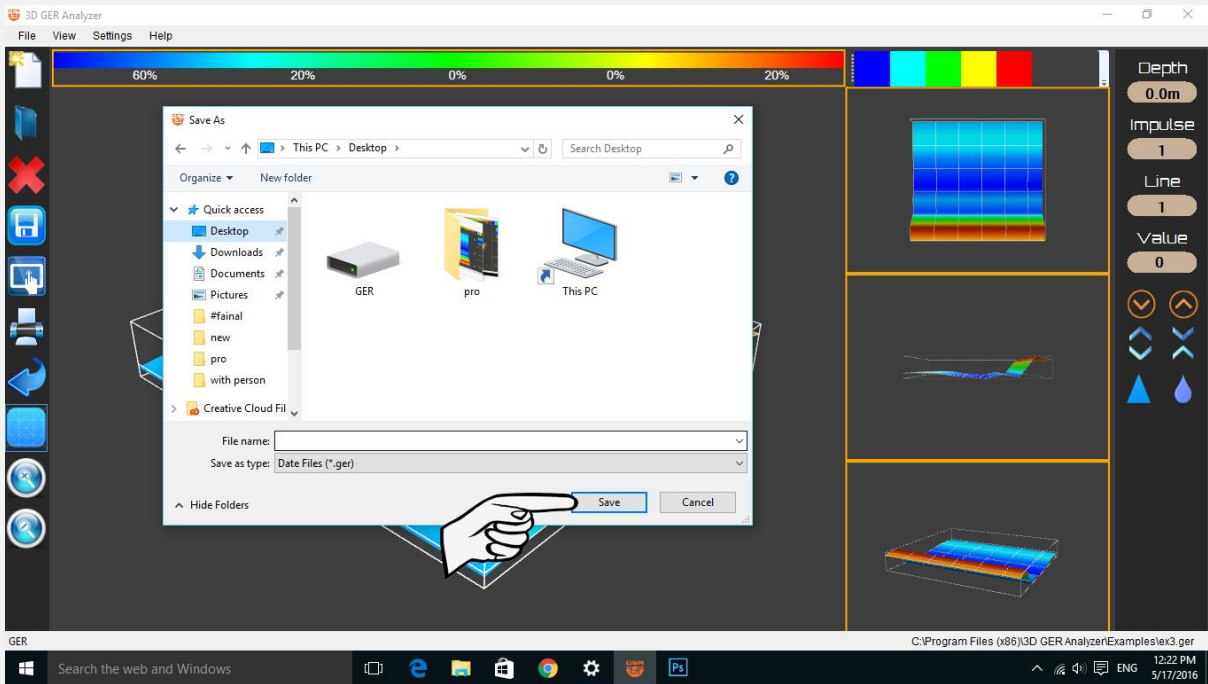

If you want to have printed report you can press on the print icon, the report will appear, and you can print it (the number in the report it is the value of the ground – metals – cavities)

Note: if the deference between tow picture (tow square) is big that mean good target and if is it small that is mean empty target

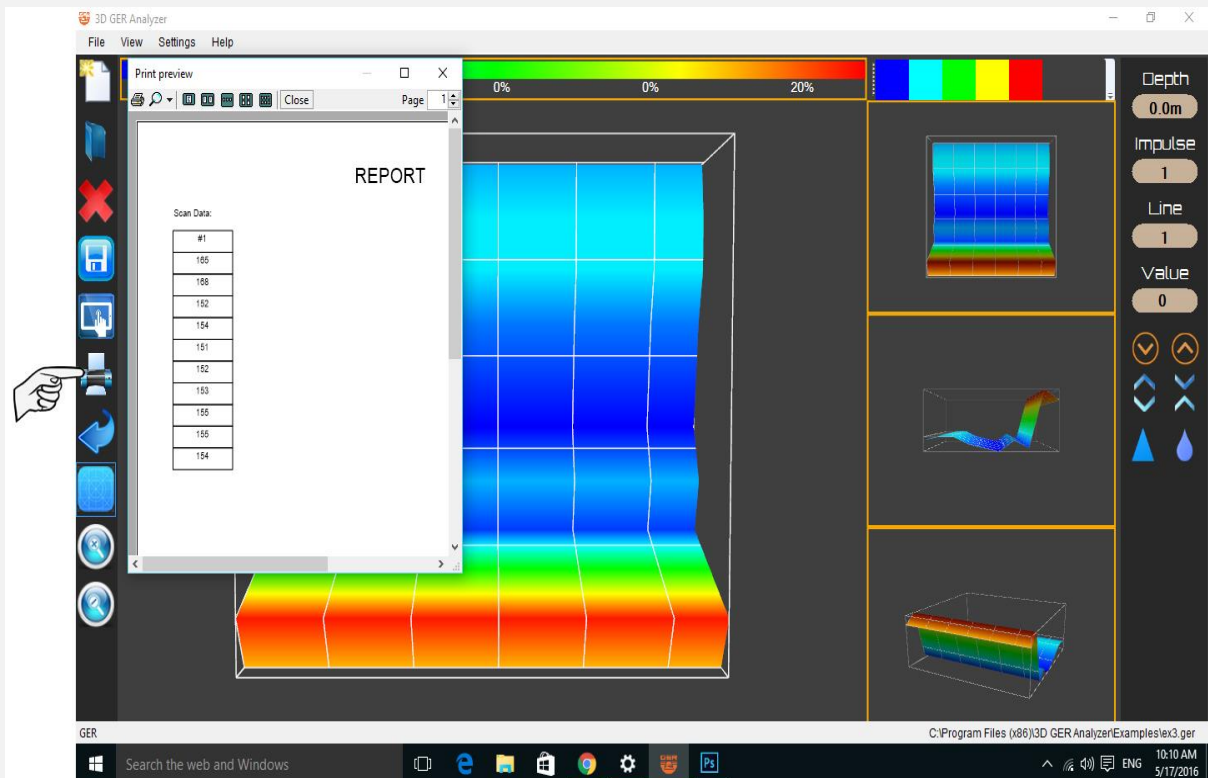

4

The Magnetometer System

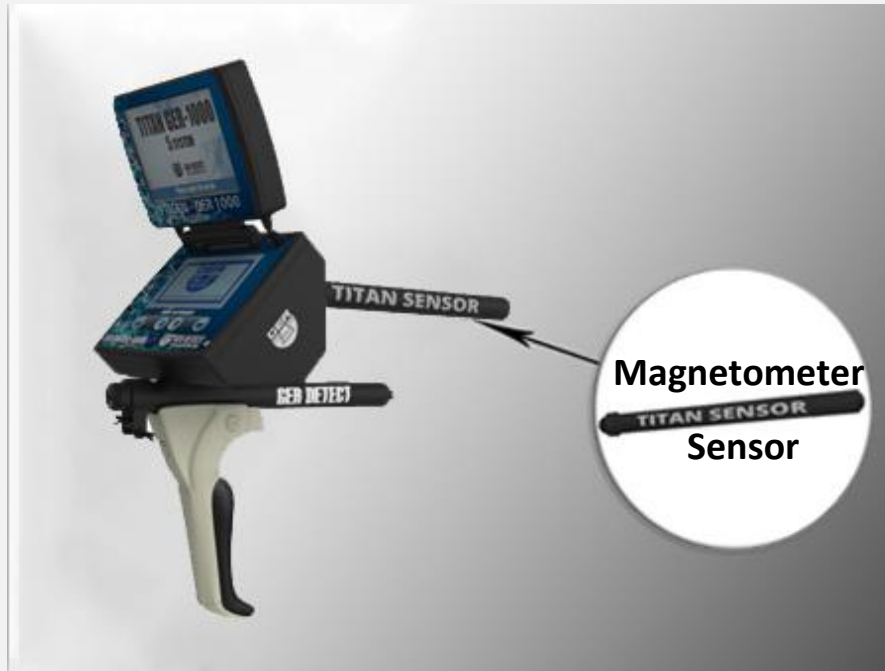

Connect component

Connect the Sensor to the Device



Click on the screen of the device to display the languages list

The device works on four languages:

(GERMAN-ENGLISH-FRENCH-ARABIC)



After selecting the language, you want to work in (English for example)

The search systems menu will appear

Select **MAGNETOMETER** search system

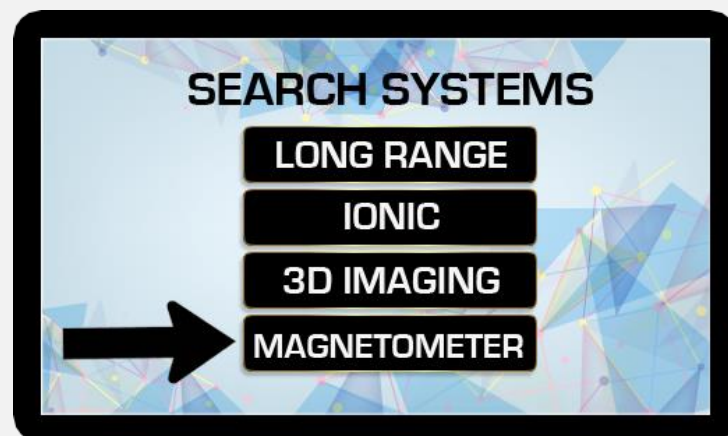

After selecting the magnetometer system, the search screen will appear.

Point the device to the ground if the device start to make a sound you must calibrate

The device with the ground by pressing on the **calibration button** as follow:



After you finish the calibration, start the search by moving the device forward and back agents the ground

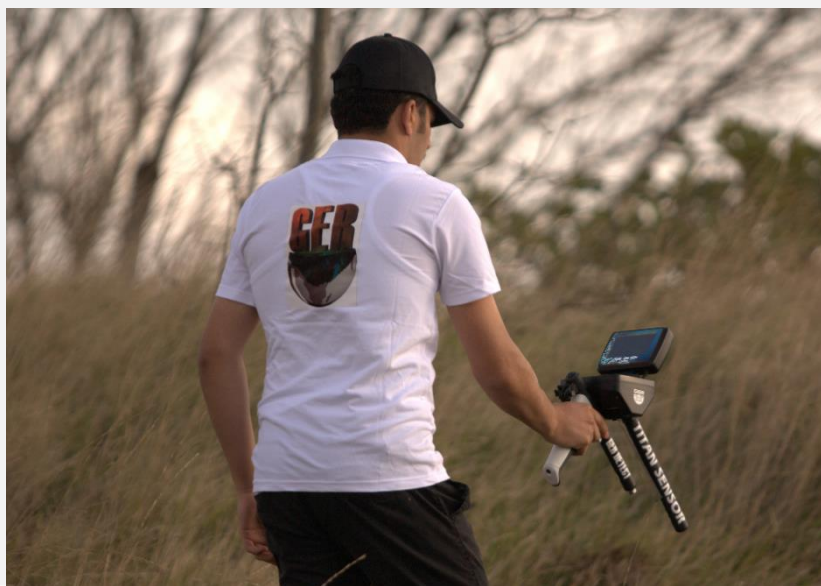

When the device detect a target, it will start to make a sound.

In addition, the indicter will start to move to alert you about the target discovered.

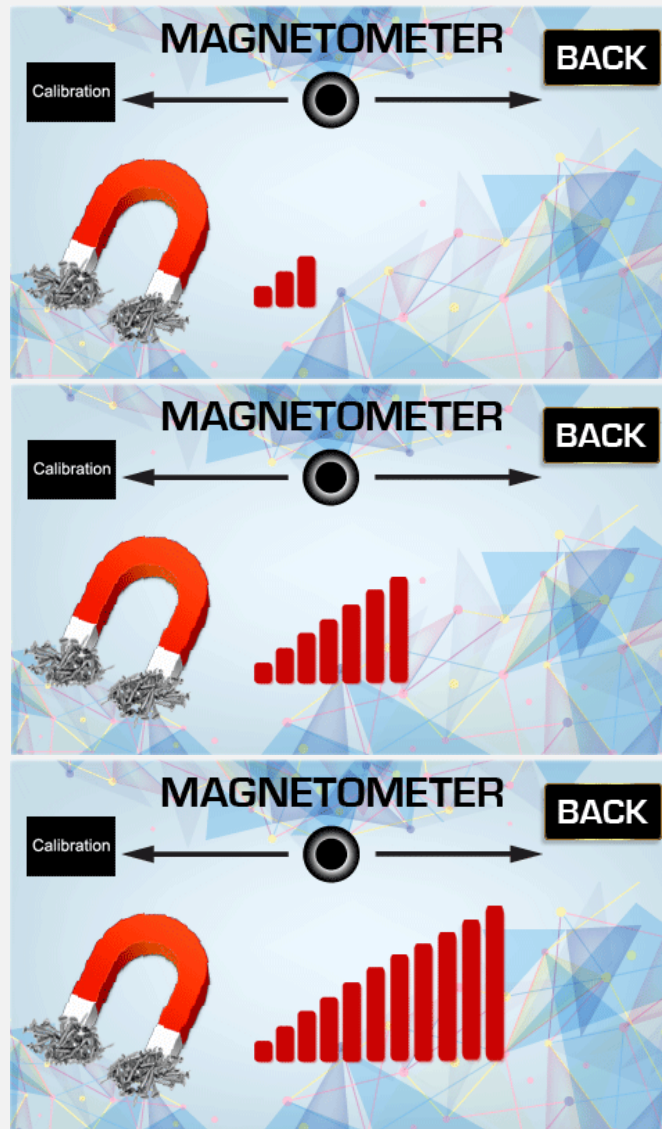

The sound will start accelerating when you will be close to the target.

Note: The target must be buried underground for many years so that by the time and interaction with the soil's composition, a magnetic field will be formed which will help prospectors to detect the target.

Therefore, testing the device on metals laid on the ground or newly buried under the ground will not show the real capacity and functionality of this device to detect the target or to reach larger depths.

The reason for that is that the magnetic fields are radiations from gold and other metals that have been in the ground for a long time and have intersected and interacted with the soil and the nature of the earth as well as having been regulated with magnetic fields north and south – These features do not actualize in gold and other metals when they exist on the ground or newly buried.

5 • The Pulse induction System



This system specializes to cover vast areas and locate the target with in **1**-meter square up to depths of **12** meters below the surface of the ground.

Connect component

Connect the coil cable to the device

Start the device by pressing on the power switch **(ON OFF)**



After pressing the (on/off) button

Make sure that there is no metal on the person he will hold the device or electronic devices or mobile phones or high voltage electricity wires in the area you want to use the device in

open the device by the start button



Select the device language from the list of languages

Move between languages through the navigation keys (**up and down**)



After selecting the language the device will open to the discrimination search mode

First, you have to calibrate the device with the ground when you start searching (during the search if you hear noise you have to make calibration again)



Hold the device like this

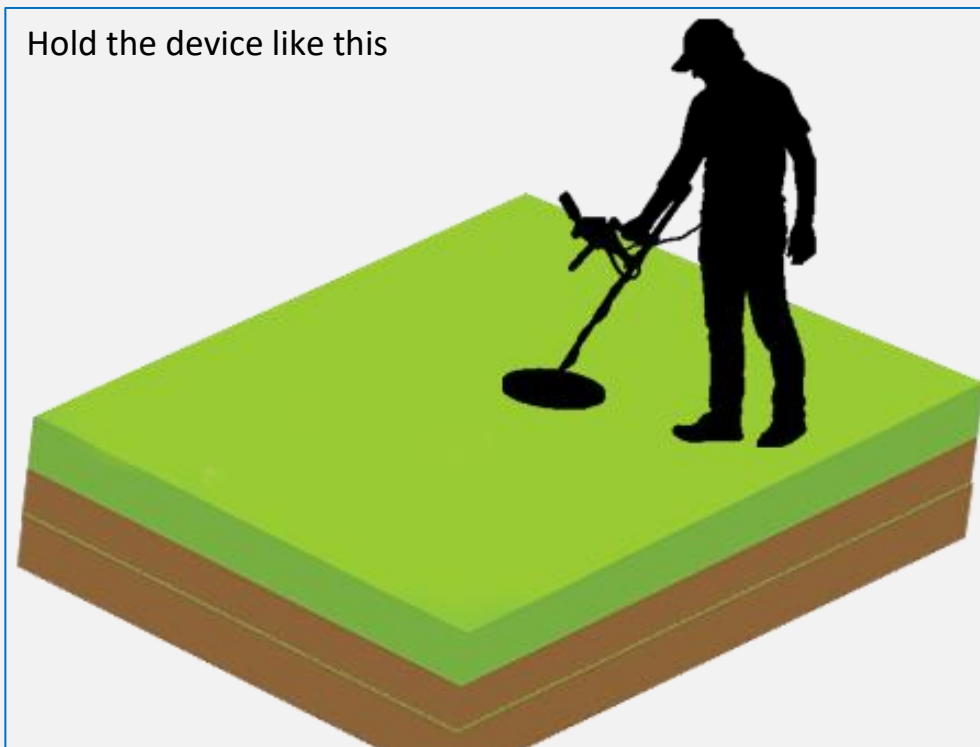

The device work on two modes

1- Discrimination search mode: This mode can discriminate between ferrous metal and non-ferrous

2- Cavity search mode

This mode can detect all cavities under the ground
(Natural cavities – made by human cavities)

In addition, it can show you the shape and the size

Start the search by moving the device right and left in stable movement and close to the ground.

The coil should be above the ground between **5 TO 10 CM**

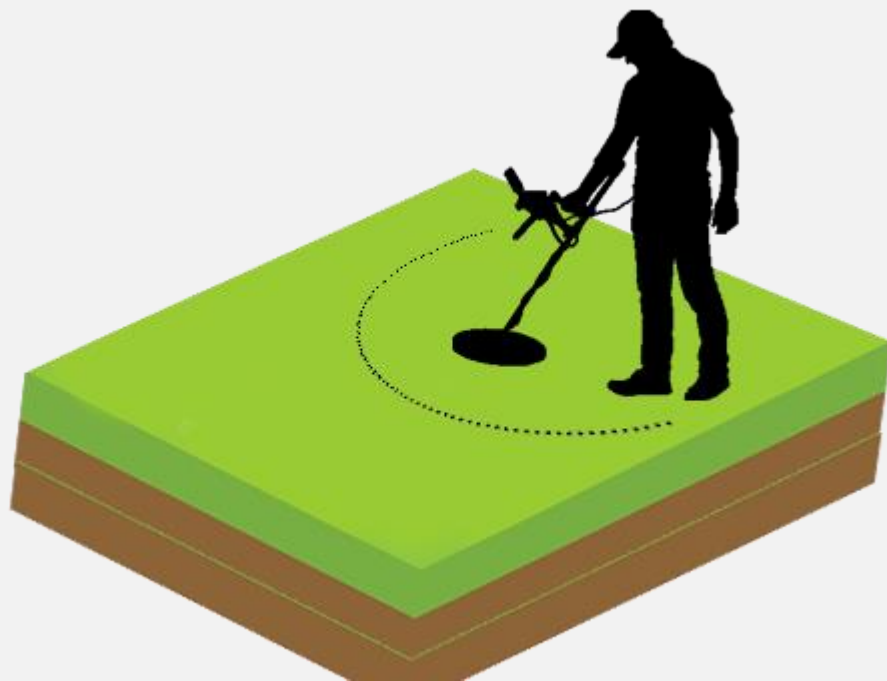

Start with the normal search mode

In case the device detects any metal an indicator will appear on the screen and you will start to hear sound conforming the target present:



Adjust the sensitivity by the navigation buttons UP & DOWN.

Switch between the options by start button.

The discrimination mode it can Separate between metals

Ferrous: for iron and the invaluable metals like copper & steel & aluminum

Non- Ferrous: for Gold and silver and bronze .

In the cavity search mode starts your scan in stable way to determine the shape of the cavity.



 **Warning**

If you want the device work well without errors you have to follow next steps

When using the device please do not wear the watch



When using the device please do not wear the jewelry



When using the device please get away from metal, lighter and mobile phone



Please take off the belt



The shoes should not contain any metal



Stay away from the car



Only you can use the ionic system, while you are driving the car

Stay away from electrical ground power lines or any surfacing electric



Thanks for choosing
our products



We wish you the best
of luck in your

www.gerdetect.de