

BOYA

USB & XLR Microphone

USB & XLR麦克风

BY-PM700 Pro

Instruction Manual
使用说明



Introduction

Thanks for choosing BOYA!

The BOYA BY-PM700 Pro is a desktop microphone with USB digital output and XLR analog output, compatible with Android devices, Windows/Mac computers, and analog audio devices. It provides a perfect audio solution for home studio recording, podcasting, voice over, video conference, and more.

The microphone features pattern selection, allowing you to select Stereo, Omnidirectional, Cardioid or Bidirectional pattern for different recording scenarios.

The 3.5mm headphone jack allows you to monitor and ensure the audio intelligibility during recording. With built in controls for headphone volume, gain and muting, you are in total control of your sound. An adjustable desktop stand allows you to place the microphone at the angle that's right for you.

Cautions

1. Do not use the unit under water, don't expose it to rain. Please store it in a cool, dry place.
2. Please use and store it in normal temperature. Do not move it from overheated to super-cooled condition frequently as well as keep away from heat sources such as heater, oven, or other devices that produce heat.
3. When using and storing, please pay attention to dust and moisture.
4. Be careful to violent collision.

Package Contents

- BY-PM700 Pro Microphone
- USB-A to USB-C Cable (3m)
- USB-C to USB-C Cable (2m)
- 5-Pin XLR Female to Dual 3-Pin XLR Male Y-Cable (0.5m)

Product Structure

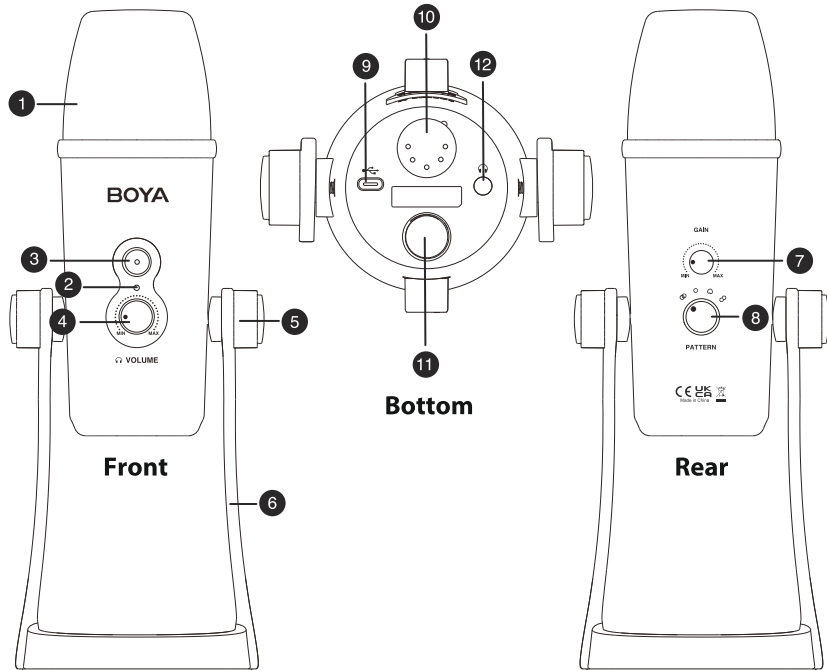

1. Tri-Capsule Array

2. Power Indicator

3. Mute Button

- Press to mute/unmute the microphone.
- When LED indicator is red, the microphone is muted.

4. Headphone Volume Control

5. Locking Knobs

6. Desk Stand

7. Gain Control

8. Pattern Selection

Stereo Pattern

Use the left and right channels to pick up sound, ideal for capturing a realistic sound image.

Omnidirectional Pattern

Pick up sound equally from all directions, capturing a natural blend of voice and ambiance with low sensitivity to wind and handling noise, as well as to vocal plosives.

Cardioid Pattern

Maximizes the rejection of sound coming from the sides and rear of the mic and can be used as a directional microphone to capture full, rich, and natural-sounding audio for podcast, speech, dialog, instrument etc.

Bi-directional Pattern

Pick up sound at the front and rear of the microphone, while sides sounds are not picked. It fits for capturing instruments, or recording an interview between two people.

9. USB-C Port

10. 5-Pin XLR Connector

11. 5/8" Threaded Hole

12. 3.5mm Headphone Output

13. USB-C to USB-C Cable

14. USB-A to USB-C Cable

15. 5-Pin XLR Female to Dual
3-Pin XLR Male Y-Cable

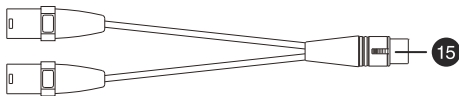

Functions

Angle Adjustment

Loosen the knobs of both sides anticlockwise.

Adjust the microphone at your desired angle, then tighten the knobs.

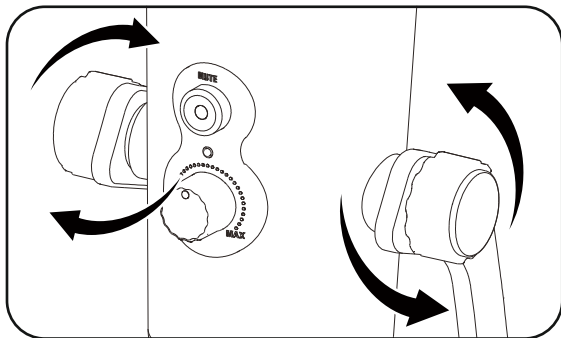

Mounting the BY-PM700 Pro to a boom arm

1. Unscrew the locking knobs to remove the microphone from the desk stand.
2. Mount the microphone to the boom arm through its 5/8" threaded hole.

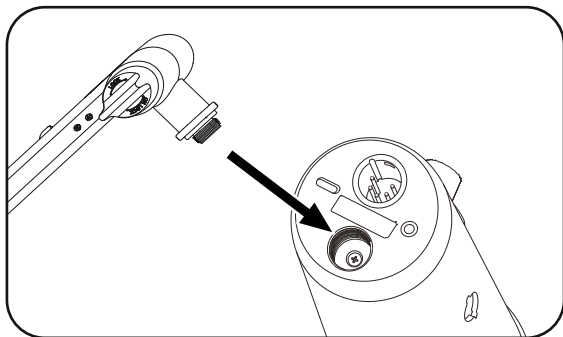

Note:
the boom arm is not included.

How to Use

Using the USB digital output

1. Connect the microphone to your smartphone/computer

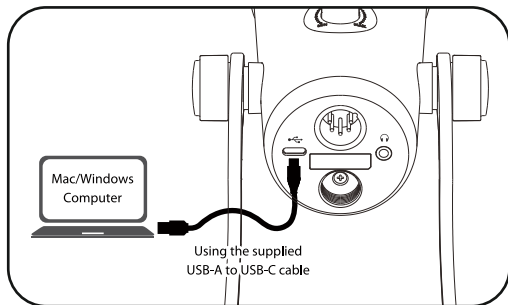
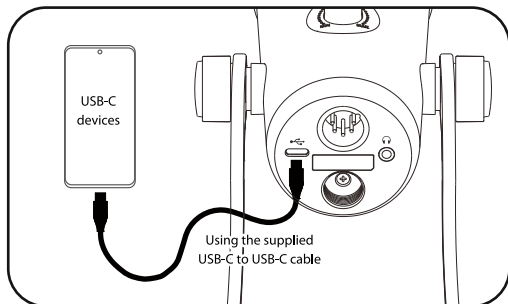

2. Connect headphones for audio monitoring.

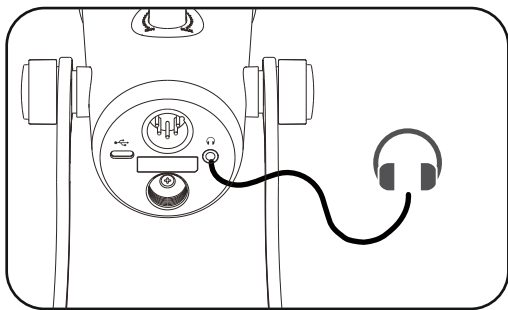

3. Select the desired polar pattern and adjust the gain control and volume control knobs according to your needs.

4. You are ready to record.

Setup for Windows 10

1. Connect the microphone to your computer using the supplied cable.
2. Go to “Setting”, choose “Sound”.
3. Select “Speaker BY-PM700 Pro” as the output device.
4. Select “Microphone BY-PM700 Pro” as the input device.

Sound

Choose your output device

Speaker (BY-PM700 Pro) ▾

Some apps are using custom output settings. You can personalize these in app volume and device preferences below.

Device properties

Volume

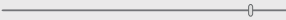
  93

 Troubleshoot

Input

Choose your input device

Microphone (BY-PM700 Pro) ▾

Some apps are using custom input settings. You can personalize these in app volume and device preferences below.

Device properties

Test your microphone

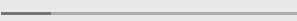
 Troubleshoot

Setup for Windows 7

1. Connect the microphone to your computer using the supplied cable.
2. Go to "Control Panel"-->"Hardware and Sound"--> "Sound".
3. Select "Speaker BY-PM700 Pro" as the default device in "Sound", under the "Playback" menu.
4. Select "Microphone BY-PM700 Pro" as the default device in "Sound", under the "Recording" menu.

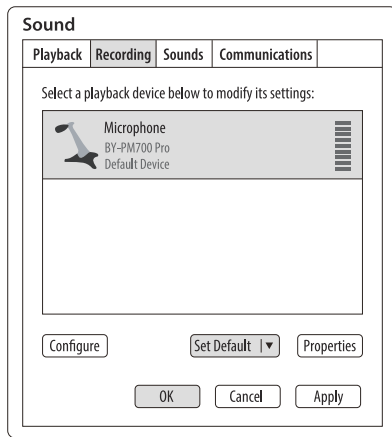
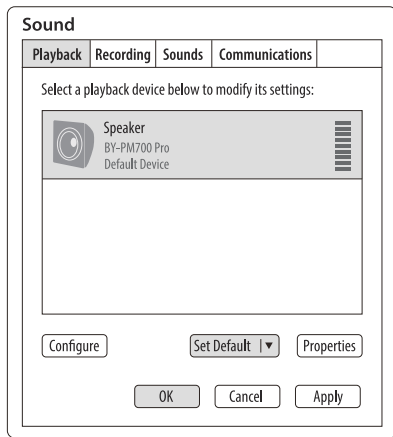

Setup for Mac

1. Connect the microphone to your computer using the supplied cable.
2. Go to Apple Icon-->System Preferences-->Sound Icon.
3. Select "BY-PM700 Pro" under the "Input" tab.
4. Select "BY-PM700 Pro" under the "Output" tab.

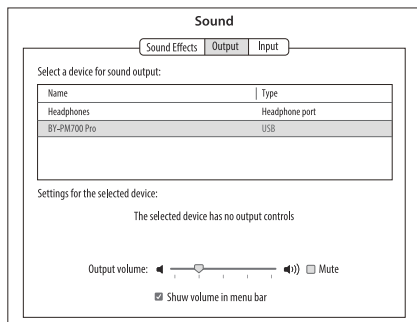
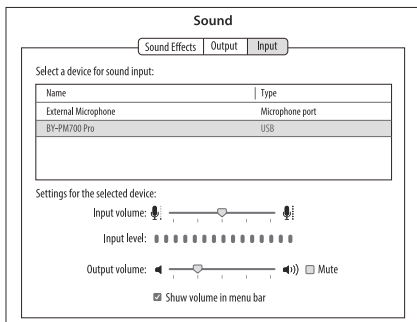

Using the XLR analog output

1. Plug the supplied XLR Y-cable into the 5-pin connector of the microphone, then connect the other end of the cable to an audio interface or other analog audio devices.
2. When using the XLR analog output, the BY-PM700 Pro should be powered by 12-48V phantom power. Please turn on the phantom power supply on the external device.

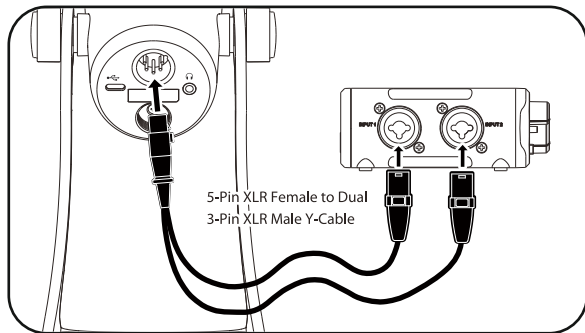

Note: When using the analog XLR output only, the 3.5mm headphone jack, volume control and mute button are not functional. It is recommended to monitor the audio via the external device.

Features

- Professional microphone with USB digital output and XLR analog output
- Universal compatibility with Android devices, Windows/Mac computers, analog audio devices
- Selectable Stereo, Omnidirectional, Cardioid and Bidirectional patterns for different scenarios
- 3.5mm headphone jack for latency-free monitoring
- Built-in controls for gain, headphone volume and muting
- 24bit/48kHz audio resolution
- Rugged metal construction
- Durable & detachable desk stand included

Specifications:

Polar Pattern	Stereo, Omnidirectional, Cardioid, Bidirectional
Frequency Response	20-20,000Hz
Sensitivity	-36dB
Power Consumption	5V/80mA
Signal-to-Noise Ratio	80dB
Maximum SPL	120dB
Microphone's Gain Control	0~54dB
Sampling Rate	48 kHz
Bit Depth	24 bit
Headphone Output Connector	1/8"(3.5mm) jack
Audio Output Connector	USB-C, 5-Pin XLR
Dimensions	295x112x116 mm
Weight	1115g

Polar Pattern

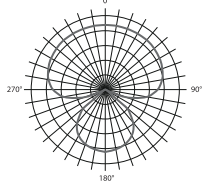
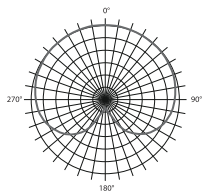
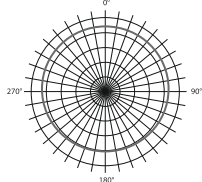
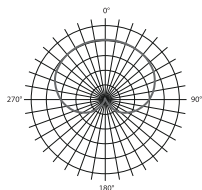

Frequency Response

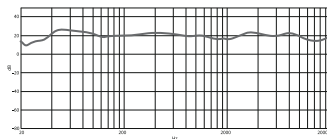

Cardioid

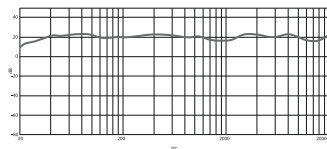

Omnidirectional

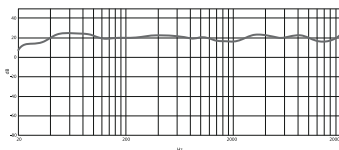

Stereo

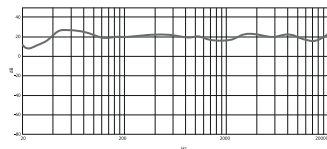

Bidirectional

感谢您选择BOYA!

博雅BY-PM700 Pro是一款具有USB数字输出和XLR模拟输出的桌面麦克风，兼容安卓设备、Windows/Mac电脑以及模拟音频设备，为家庭工作室录音、播客、配音、视频会议等提供完美的音频解决方案。

BY-PM700 Pro具有立体声、全向、心型和双向四种拾音模式可供选择，适用于不同录音场景。产品具有增益调节、耳机音量调节和静音功能。3.5mm耳机插孔可让您在录音过程中进行监听并确保音频清晰度。可调节的桌面支架允许用户根据自身使用场景，自由调节麦克风角度。

注意事项

- 不要在水下使用本机，不要将其暴露在雨中。请存放在阴凉干燥处。
- 请在常温下使用并保存。不要频繁地将其从过热状态移至过冷状态，并远离热源，如加热器、烤箱或其他产生热量的设备。
- 在使用和储存时，请注意防尘和防潮。
- 小心避免猛烈的碰撞。

包装清单

- BY-PM700 Pro麦克风
- USB-A转USB-C转接线（3米）
- USB-C转USB-C转接线（2米）
- 5芯卡侬母转3芯卡侬公一分二转接线（0.5米）

产品结构

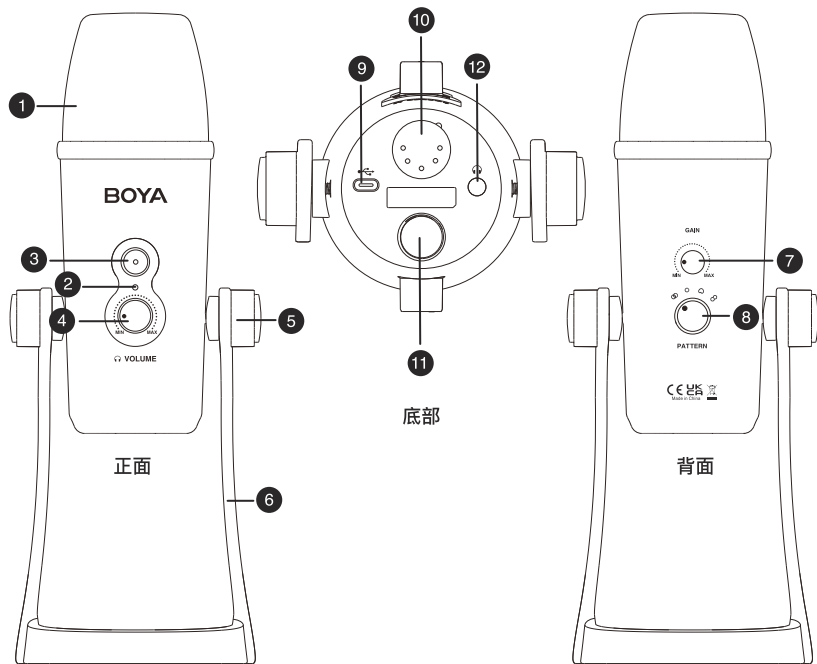

1. 三振膜舱拾音头

2. 电源指示灯

3. 静音键

- 短按此键开启/关闭静音模式。
- 当LED指示灯亮红灯时，静音模式开启。

4. 耳机音量调节旋钮

5. 锁紧旋钮

6. 桌面支架

7. 增益调节旋钮

8. 模式切换旋钮

 立体声模式

使用左右声道拾取声音，适用于捕捉逼真的声像。

 全向模式

全方位拾音，适合于收录自然混合的周围音，对风和手持噪音以及爆破音的敏感度较低。

 心型模式

最大程度地剔除麦克风两侧和后方的声音，通常当作指向型麦克风使用，适合捕捉饱满圆润的自然声，可用于播客、演讲、访谈、乐器弹奏等场合。

 双向模式

从麦克风的前后方拾音，两边的声音无法被收录，非常适合乐器演奏、双人访谈的场景。

- 9. USB-C接口
- 10. 五芯卡侬接口
- 11. 5/8英寸螺纹孔
- 12. 3.5mm耳机插孔
- 13. USB-C转USB-C转接线
- 14. USB-A转USB-C转接线
- 15. 5芯卡侬转3芯卡侬
一分二转接线

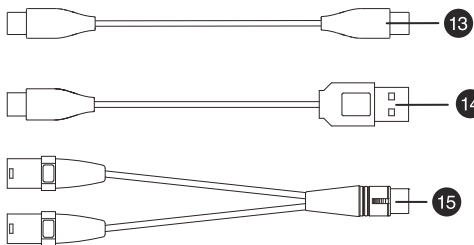

功能

麦克风角度调节

逆时针松开两侧的旋钮，将麦克风调整到所需角度，然后拧紧旋钮。

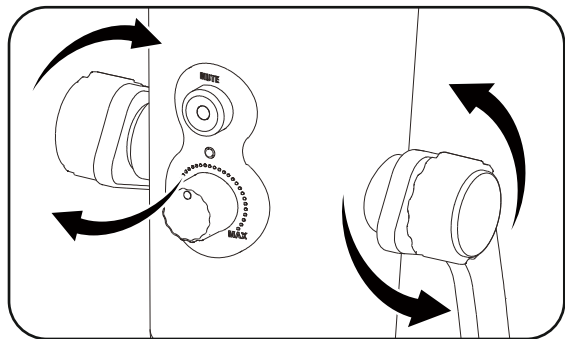

将麦克风安装至悬臂支架上

1. 松开锁紧旋钮，将麦克风从桌面支架上拆卸下来。
2. 通过麦克风底部 5/8 英寸螺纹孔，将麦克风安装至悬臂支架上。

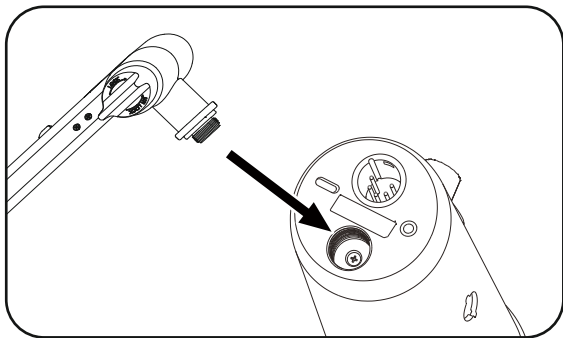

注意：包装内不含悬臂支架。

使用方法

使用USB数字输出

1. 将麦克风连接至手机/电脑。

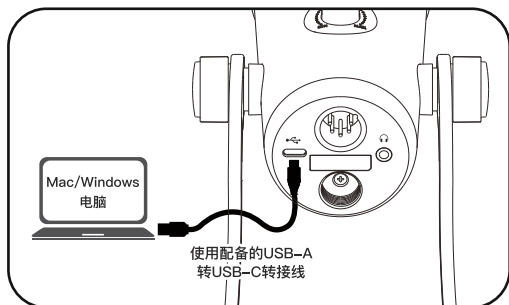
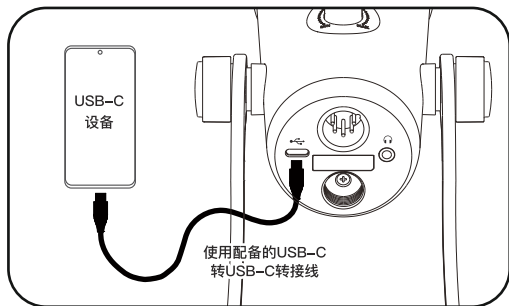

2. 接入耳机进行音频监听。

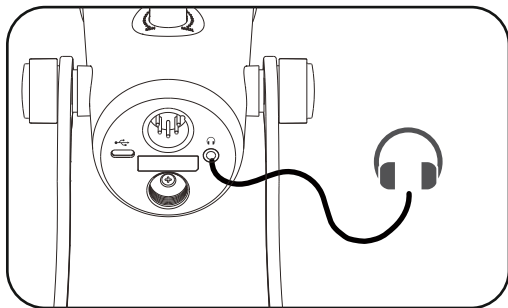

3. 选择所需的拾音模式，并根据录制需要，调节增益旋钮和音量控制旋钮。

4. 开始录制。

程序设置

Windows 10系统

1. 用配备的转接线将麦克风接入电脑。
2. 在设置界面选择“声音”。
3. 选择扬声器BY-PM700 Pro为输出设备。
4. 选择麦克风BY-PM700 Pro输入设备。

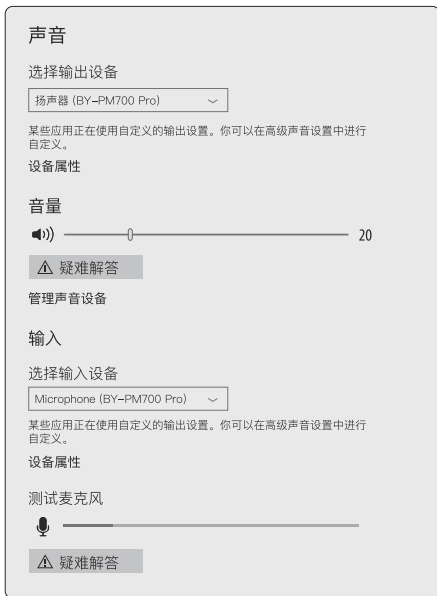

Windows 7系统

1. 用配备的转接线将麦克风接入电脑。
2. 点开“控制面板”-->“硬件和声音”-->“声音”。
3. 在“播放”选项卡下选择“扬声器BY-PM700 Pro”为默认声音设备。
4. 在“录制”选项卡下选择“麦克风BY-PM700 Pro”为默认声音设备。



Mac系统

1. 用配备的转接线将麦克风接入电脑。
2. 进入Apple主菜单-->系统偏好设置--> 声音。
3. 选择“BY-PM700 Pro”为输入设备。
4. 选择“BY-PM700 Pro”为输出设备

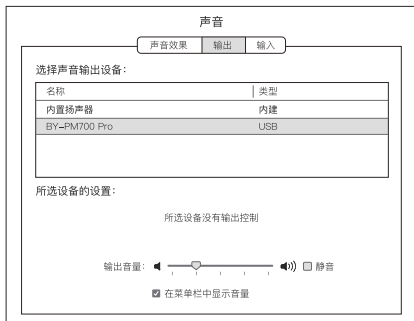
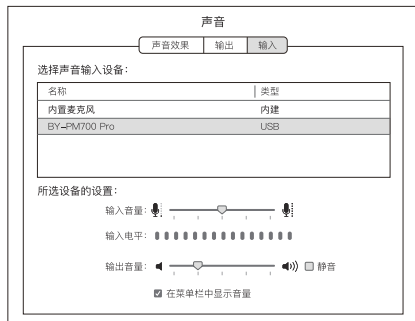

使用XLR模拟输出

1. 将配备的卡侬转接线插入麦克风的XLR接口，然后另一端连接到音频接口或其他模拟音频设备。
2. 使用模拟XLR输出时，BY-PM700 Pro需12-48V幻象电源供电，请打开外接设备上的幻象电源。

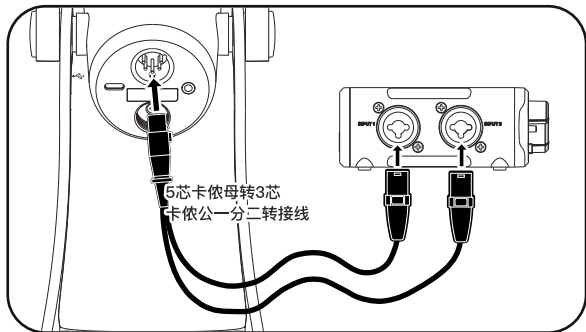

注意：不使用USB供电，单独使用模拟XLR输出时，3.5mm耳机插孔、音量控制旋钮和静音按钮不起作用。建议通过外部设备监听音频。

特点

- 专业级麦克风，具有USB数字输出和XLR模拟输出
- 广泛的兼容性，可用于安卓设备、Windows/Mac电脑以及模拟音频设备
- 立体声、全向、心型和双向四种拾音模式可选，适用于不同录制场景
- 3.5mm耳机插孔，实现无延迟监听
- 具有增益调节、耳机音量调节和静音功能
- 24bit/48kHz音频分辨率
- 坚固的金属结构
- 配备耐用可拆卸桌面支架

参数

拾音模式	立体声、全向、心型、双向拾音
频率响应	20-20,000Hz
灵敏度	-36dB
功率消耗	5V/80mA
信噪比	80dB
最大声压级	120dB
麦克风增益值	0~54dB
采样率	48 kHz
位深	24 bit
耳机输出口	3.5mm插孔
音频输出孔	USB-C, 5芯XLR
尺寸	295×112×116 mm
重量	1115g

指向性

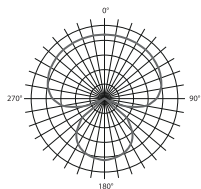
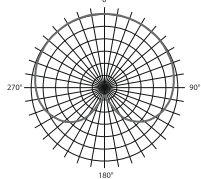
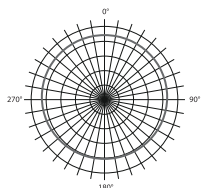
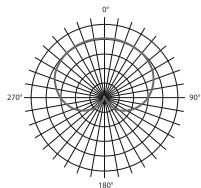

频响曲线

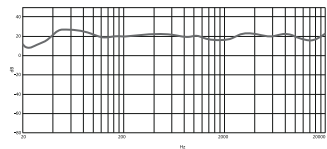
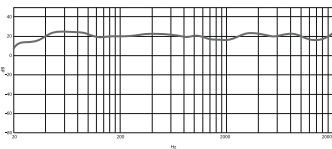
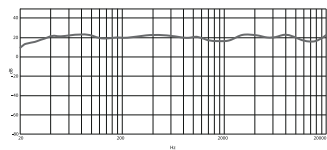
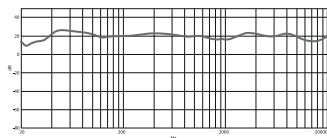

心型

全向

立体声

双向

SHENZHEN JIAYZ PHOTO INDUSTRIAL., LTD.

The BOYA logo is a trademark which is registered and owned by
Shenzhen Jiayz Photo Industrial., Ltd.

深圳市长丰影像器材有限公司

地址:广东省深圳市龙华区观澜街道大富社区硅谷动力智能终端产业园A16栋

TEL: 400 6131096

Email: sales@boya-mic.com

www.boya-mic.com / www.jiayz.com