

All information contained in this documents is subject to change without prior notification. POINTMAN ©2016. All rights reserved.

POINTMAN® Card Printer

nuvia™

User guide manual

Install Printer and Ready

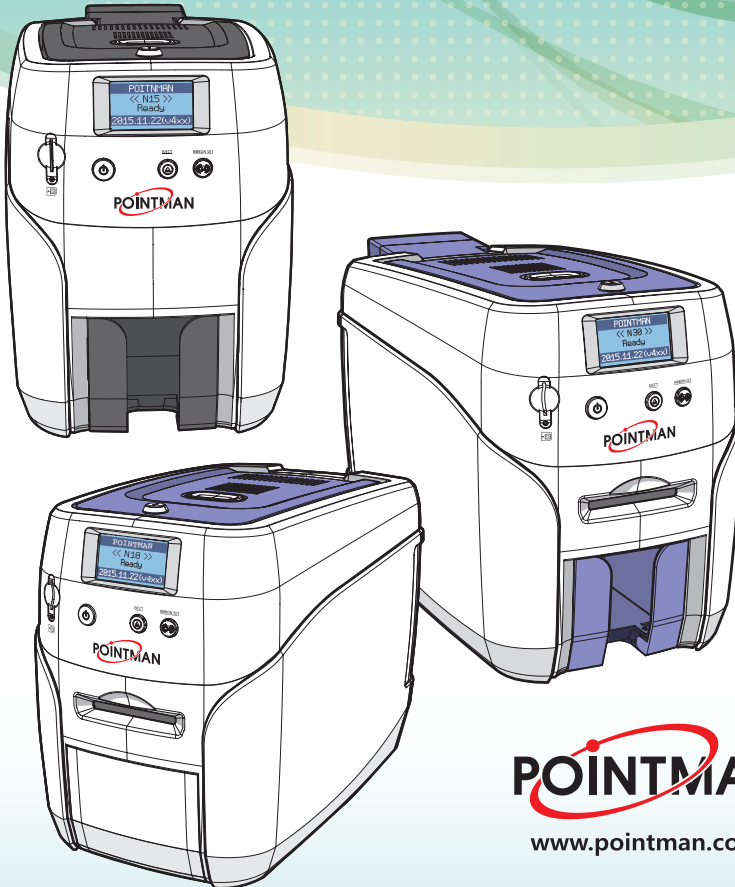

POINTMAN
www.pointman.co.kr

Contents

Safety Precautions	06
Product Introduction	09
Product Overview	09
NUVIA Series	09
Names of Parts	10
N10 (Manual Feeding, Single-sided Printing)	10
N10 (Manual Feeding, Double-sided Printing)	12
N15 (Auto Feeding, Single-sided Printing, 1 Input hopper)	14
N15 (Auto Feeding, Double-sided Printing, 1 Input hopper)	16
N20 / N30 (Auto Feeding, Single-sided Printing, 1 Input hopper)	18
N20 / N30 (Auto Feeding, Single-sided Printing, 2 Input hoppers)	20
N20 / N30 (Auto Feeding, Double-sided Printing, 1 Input hopper)	22
N20 / N30 (Auto Feeding, Double-sided Printing, 2 Input hoppers)	24
Load Blue Cleaning Roller & Ribbon	26
Load Blue Cleaning Roller	26
Load Ribbon	27
Load Cards	28
Place Cards in the Input Hopper	28
Place Cards after Removing the Input Hopper	29
Print Single Card	31
Magnetic Cards	32
Input Hopper & Ribbon Lock	33
Input Hopper Lock	33
Top Cover Lock	33
Install/Remove Output Stacker	34

Open the Output Stacker Cover and Take the Cards	34
Use the Spring Load to Take a Small Quantity of Cards	35
Pull the Output Stacker and the Cards	35
Connect Power & Communication Cables	36
Install Program	37
System Requirements	37
① Supported Operating System	37
② Recommended Specifications	37
Install Software	37
① Install Software Using Local Port (USB)	37
② Install Software for Network Printer	39
③ Configure Networking Settings	44
1) Network Configuration Window	44
2) DHCP (Dynamic Host Configuration Protocol)?	45
3) Network Settings - Automatic (DHCP supported)	45
4) Network Settings - Manual	48
Uninstall Program	50
Print Cards	50
Set as Default Printer	51
Change Printer Port (Using the Printer Driver)	52
Select Input Hopper in the Printer Settings	54
Print Using Application Programs & Configure Driver Settings	56
Print Using Application Programs	56
Configure Printer Default Settings in Application Programs	56
① Layout	57
② Paper	58
③ Output	58
④ Image	59
⑤ Magnetic	61
⑥ Control	62

⑦ About	67
Check IP Address & Print Test Card	68
Check IP Address	68
Print Self-Test Card	70
① If Connected to a PC	70
② If Not Connected to a PC: User Mode	71
Maintenance Instructions	73
Supported Cards	73
① Size	73
② Thickness	73
③ Acceptable Cards	73
④ Unacceptable Cards	73
Clean the Printer	73
Clean the Exterior	73
Clean Inside the Printer Using Cleaning Kit	74
① Cleaning Kit & Use	74
② Clean the Printer Using CR80 Cleaning Card / Long-T Cleaning Card	75
1) Check the Proper Use of CR80 Cleaning Card / Long-T Cleaning Card	75
2) Not Connected to a PC: User Mode	76
3) Connected to a PC	78
③ Clean the Printer Using Alcohol Swab	79
1) Clean the Inside of the Printer Using Alcohol Swab	79
2) Clean the Printer's TPH Using Alcohol Swab	80
Clean the Blue Cleaning Roller	81
Troubleshooting	81
Errors	81
① TPH	81
1) Replace the TPH	82
② Card Feeding	84
1) Remove Jammed Card (Single-sided Printing)	84
2) Remove Jammed Card (Double-sided Printing)	85
③ Ribbon	87
④ Card	87

⑤ Miscellaneous	87
Warning	88
① Card	88
② Ribbon	88
③ Miscellaneous	89
Additional Errors	89
Ribbon Specifications	89
Color Ribbons	89
Monochrome Ribbons	89
Printer Specifications	90
Product Features	90
Standard Specifications	90
① Printing Type	90
② Printing Function	90
③ Resolution	90
④ Printing Speed	90
1) Color Printing	90
2) Monochrome Printing	90
⑤ Card Capacity	91
Optional Accessories	91
Printer Specifications	91
① Dimensions (Width x Length x Height) & Weight	91
1) N10 (Manual Feed)	91
2) N15/ N20 / N30 (Auto Feed)	91
② Power Adapter	91
③ Font	91
④ Memory	92
⑤ Interface	92
⑥ PC Specifications	92
⑦ Software	92
Regulatory	93

Safety Precautions

Before using this product, please make sure that you have read the safety precautions described below. The safety precautions noted on this page are categorized as Warning, Caution, Attention, and Note. We are not responsible for any injuries or damage when the product is not used in compliance with these precautions.



Warning

These warnings must always be followed; otherwise, this may result in serious injury or damage.



Caution

Not following this caution can cause service interruption or product damage.



Important

Use this information to check and inspect for the proper operation of the product.



Note

This is a note that provides more details or information that is useful for users.



-Warning

These warnings must always be followed; otherwise, serious injury may result.

Power

- Do not use a damaged plug or loose outlet.
- Do not pull the cable to unplug or touch the plug with wet hands.
- Do not bend the cable by force or place any heavy objects on it.
- Keep it unplugged if not in use for an extended period of time or in case of lightning or thunder.

Installation / Storage

- Do not install the printer in a place where it may be subjected to moisture, dust, or splashes of water (rain).
- Keep the printer away from heat sources, as well as lit candles and cigarettes.
- Unplug the printer when moving it.
(If the printer is moved while plugged, the cable may be damaged and cause electric shock.)
- Keep any inflammable liquid, gas, and aerosol away from the printer.

Cleaning

- Keep the power plug clean, away from dust and water.
- Unplug when cleaning, and do not spray water or use benzene or thinner.

Misc.

- Do not place metal objects, chemicals, or anything with water on it.
- If you observe strange smoke, odor, or noise from the printer, unplug it immediately and contact your dealer.
- Use only the specified adapter.

※ Do not use adapters from other devices, e.g. laptop, monitor, game console.



-Caution

Not following this caution can cause service interruption or product damage.

Installation/ Storage

- Do not install the printer on an unstable surface.
- Do not place the printer under direct sunlight as it may cause a malfunction.

Misc.

- Do not remove any cover or protective device that is attached with screws.
- Do not operate the printer while your hand is placed inside.
- Clean and maintain the printer according to the user instructions.
- Do not disassemble, repair, or modify the printer arbitrarily.

Product Introduction

-Product Overview

Thank you for purchasing Nuvia series card printer.

NUVIA series card printers are designed to print various types of cards easily and quickly to meet users' needs. The printers support the image, text and barcode prints as well as mag. stripe cards and smart cards encoding. You can easily create any types of ID cards, membership cards, bank cards and loyalty cards with Nuvia printers.

-NUVIA Series



N10



N15



N20/N30

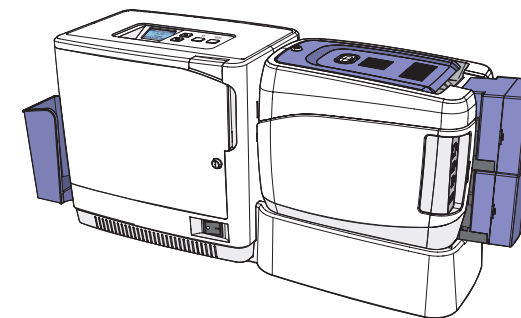

NUVIA+NL200



Important

Please make sure that all the components and accessories are included in the box. If there are missing or damaged items, then please contact your dealer for assistance.

Names of Parts

-N10 (Manual Feeding, Single-sided Printing)

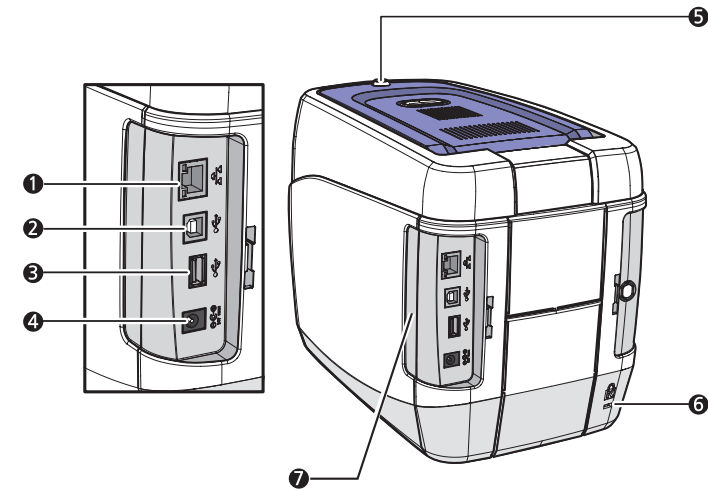
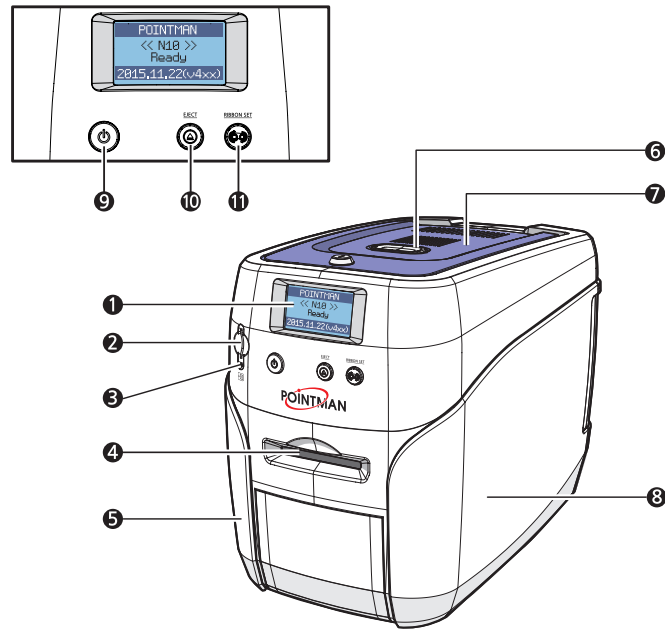

Name	Description
1 LCD Display	Displays the printer's operation status on the LCD screen.
OPTION 2 SIM Card Slot	Used for inserting mobile chips.
OPTION 3 SIM Card Slot LED	Indicates the mobile chip status.
4 Single Card Slot	Used to insert or release a single card.
5 Left Side Cover	Open to install optional accessories or fix errors.
6 Top Cover Button	Open top cover to load a ribbon and replace a cleaning roller.
7 Top Cover	Open to replace the cleaning roller.
8 Right Side Cover	Open to replace the main board or fix errors.
9 Power Switch	Turns the printer on/off.
10 Card Eject Button	Release the card inside the printer.
11 Ribbon Set Button	Replace or reposition the ribbon.

Name	Description
1 Ethernet Port	Used to connect to a network using a LAN cable.
2 USB Port	Used to connect to a PC using a USB cable.
3 USB Socket	Used to insert USB memory media or to connect to a PC.
4 Power Supply Port	Connects to the power supply.
OPTION 5 Top Cover Lock Key	Locks/unlocks the Top Cover.
6 Kensington Security Slot	Use this to mount a security lock.
7 Side Cover Open Section	Press to open the Side Cover.

-N10 (Manual Feeding, Double-sided Printing)

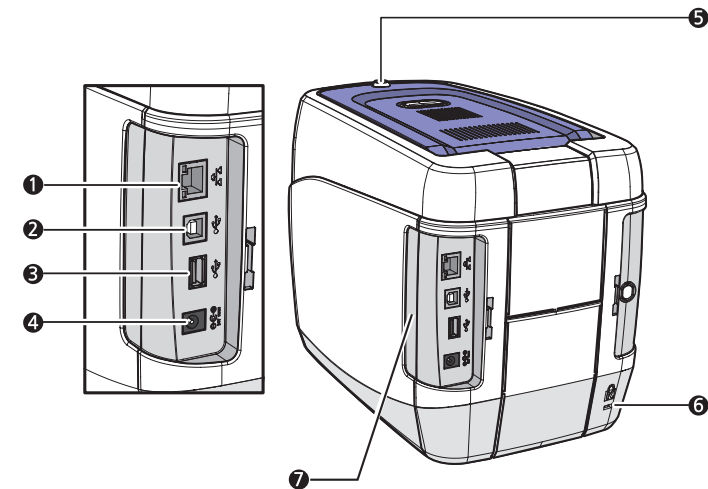
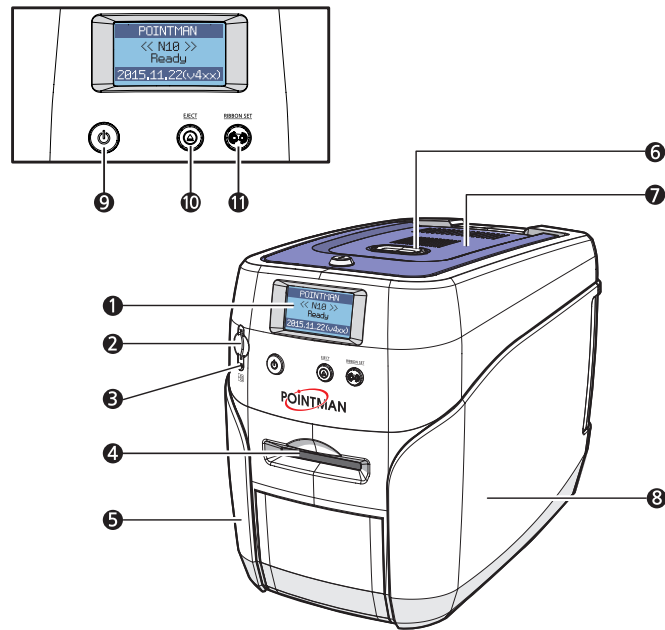

Name	Description
1 LCD Display	Displays the printer's operation status on the LCD screen.
OPTION 2 SIM Card Slot	Used for inserting mobile chips.
OPTION 3 SIM Card Slot LED	Indicates the mobile chip status.
4 Single Card Slot	Used to insert or release a single card.
5 Left Side Cover	Open to install optional accessories or fix errors.
6 Top Cover Button	Open top cover to load a ribbon and replace a cleaning roller.
7 Top Cover	Open to replace the cleaning roller.
8 Right Side Cover	Open to replace the main board or fix errors.
9 Power Switch	Turns the printer on/off.
10 Card Eject Button	Release the card inside the printer.
11 Ribbon Set Button	Replace or reposition the ribbon.

Name	Description
1 Ethernet Port	Used to connect to a network using a LAN cable.
2 USB Port	Used to connect to a PC using a USB cable.
3 USB Socket	Used to insert USB memory media or to connect to a PC.
4 Power Supply Port	Connects to the power supply.
OPTION 5 Top Cover Lock Key	Locks/unlocks the Top Cover.
6 Kensington Security Slot	Use this to mount a security lock.
7 Side Cover Open Section	Press to open the Side Cover.

-N15 (Auto Feeding, Single-sided Printing, 1 Input hopper)

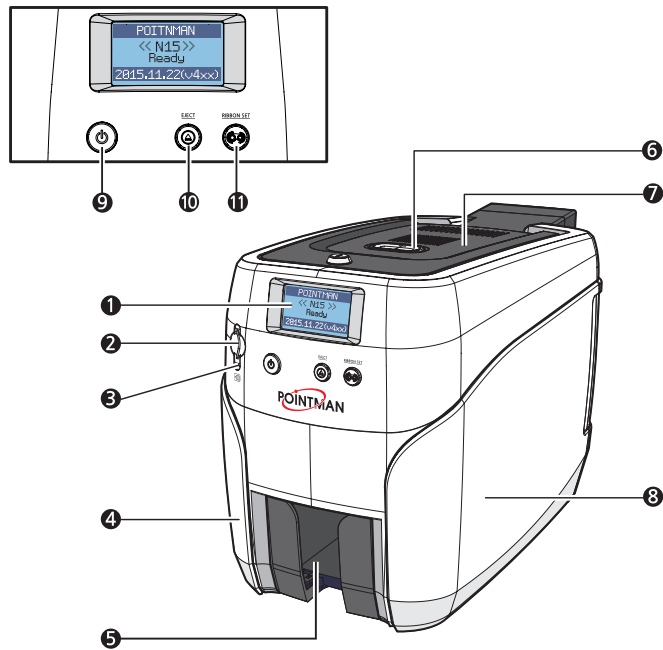

Name	Description
1 LCD Display	Displays the printer's operation status on the LCD screen.
OPTION 2 SIM Card Slot	Used for inserting mobile chips.
OPTION 3 SIM Card Slot LED	Indicates the mobile chip status.
4 Left Side Cover	Open to install optional accessories or fix errors.
5 Output Stacker	Stores printed cards (max. 60 cards).
6 Top Cover Button	Opens the Top Cover.
7 Top Cover	Open top cover to load a ribbon and replace a cleaning roller.
8 Right Side Cover	Open to replace the main board or fix errors.
9 Power Switch	Turns the printer on/off.
10 Card Eject Button	Release the card inside the printer.
11 Ribbon Set Button	Replace or reposition the ribbon.

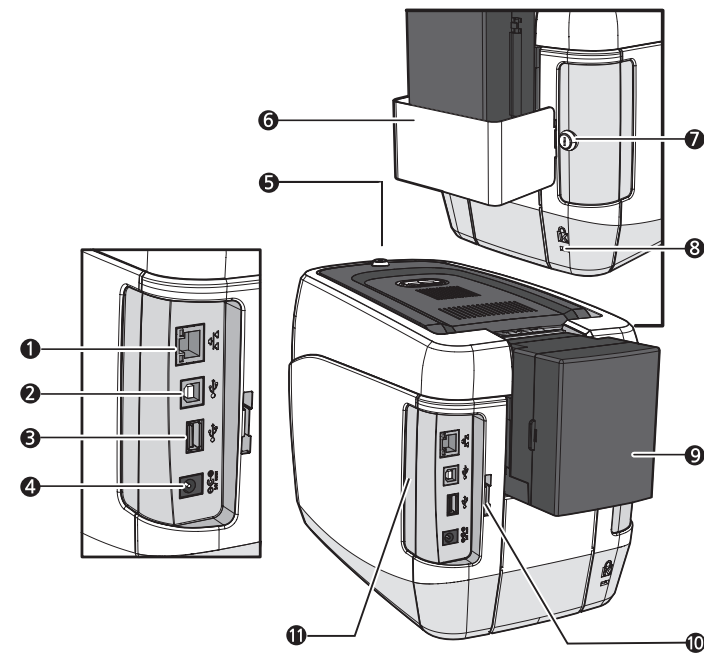

Name	Description
1 Ethernet Port	Used to connect to a network using a LAN cable.
2 USB Port	Used to connect to a PC using a USB cable.
3 USB Socket	Used to insert USB memory media or to connect to a PC.
4 Power Supply Port	Connects to the power supply.
OPTION 5 Top Cover Lock Key	Locks/unlocks the Top Cover.
OPTION 6 Input Hopper Lock	Used to lock the input hopper for Security.
OPTION 7 Input Hopper Lock Key	Locks/unlocks the input hopper.
8 Kensington Security Slot	Use this to mount a security lock.
9 Input Hopper (Standard)	Stores cards to print (max. 100 cards).
10 Lock Connector Link	Used to connect the Back Cover to the Input Hopper Lock.
11 Side Cover Open Section	Press to open the Side Cover.

-N15 (Auto Feeding, Double-sided Printing, 1 Input hopper)

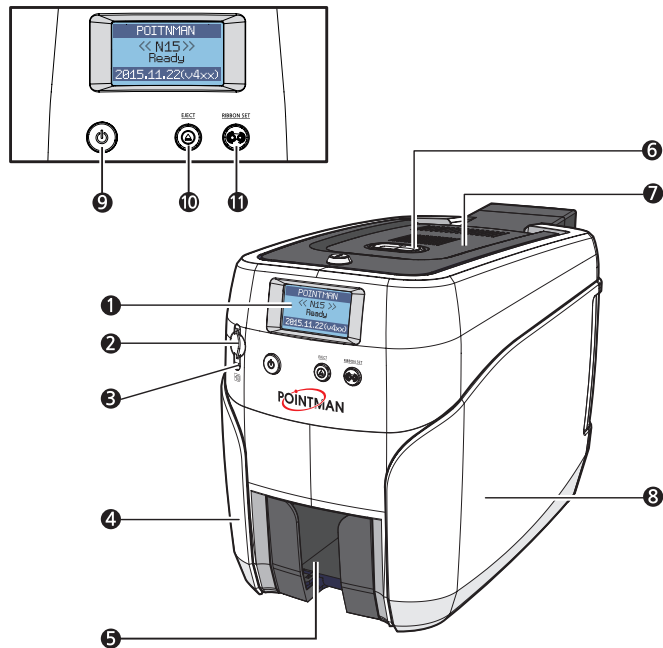

Name	Description
1 LCD Display	Displays the printer's operation status on the LCD screen.
OPTION 2 SIM Card Slot	Used for inserting mobile chips.
OPTION 3 SIM Card Slot LED	Indicates the mobile chip status.
4 Left Side Cover	Open to install optional accessories or fix errors.
5 Output Stacker	Stores printed cards (max. 60 cards).
6 Top Cover Button	Opens the Top Cover.
7 Top Cover	Open top cover to load a ribbon and replace a cleaning roller.
8 Right Side Cover	Open to replace the main board or fix errors.
9 Power Switch	Turns the printer on/off.
10 Card Eject Button	Release the card inside the printer.
11 Ribbon Set Button	Replace or reposition the ribbon.

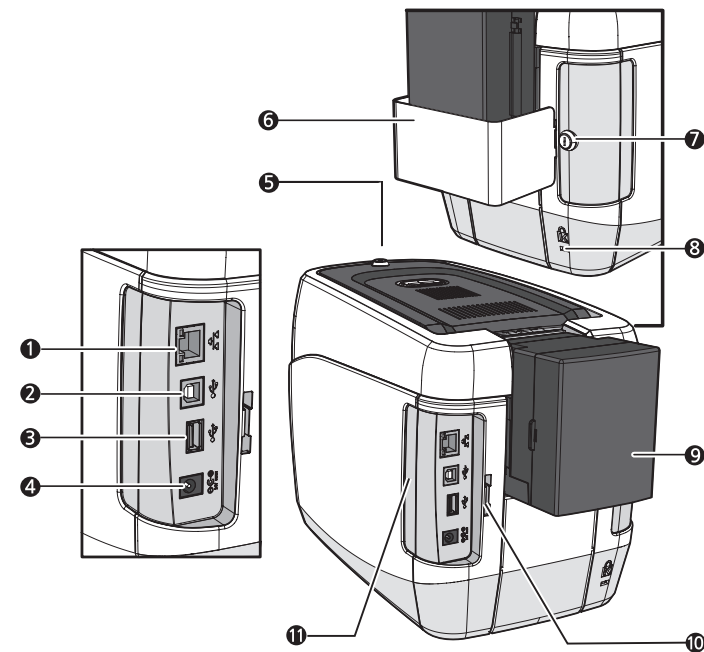

Name	Description
1 Ethernet Port	Used to connect to a network using a LAN cable.
2 USB Port	Used to connect to a PC using a USB cable.
3 USB Socket	Used to insert USB memory media or to connect to a PC.
4 Power Supply Port	Connects to the power supply.
OPTION 5 Top Cover Lock Key	Locks/unlocks the Top Cover.
OPTION 6 Input Hopper Lock	Used to lock the input hopper for Security.
OPTION 7 Input Hopper Lock Key	Locks/unlocks the input hopper.
8 Kensington Security Slot	Use this to mount a security lock.
9 Input Hopper (Standard)	Stores cards to print (max. 100 cards).
10 Lock Connector Link	Used to connect the Back Cover to the Input Hopper Lock.
11 Side Cover Open Section	Press to open the Side Cover.

-N20 / N30 (Auto Feeding, Single-sided Printing, 1 Input hopper)

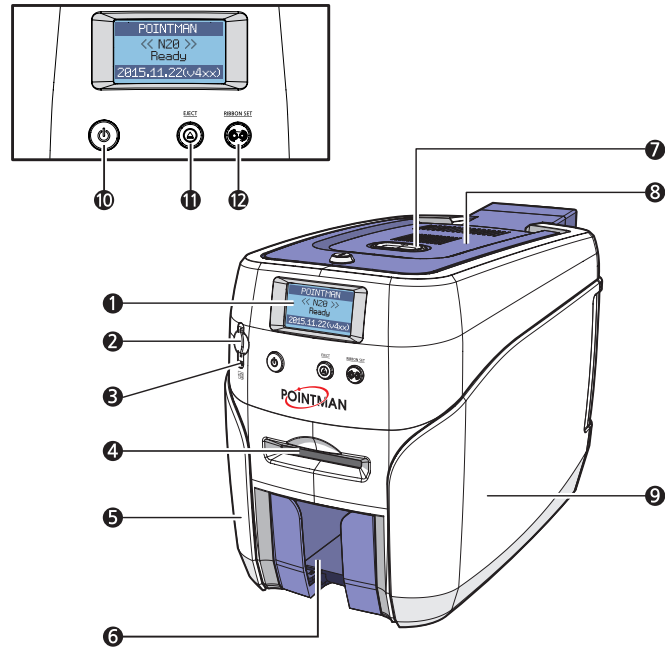

Name	Description
1 LCD Display	Displays the printer's operation status on the LCD screen.
OPTION 2 SIM Card Slot	Used for inserting mobile chips.
OPTION 3 SIM Card Slot LED	Indicates the mobile chip status.
4 Single Card Slot	Used to insert or release a single card.
5 Left Side Cover	Open to install optional accessories or fix errors.
6 Output Stacker	Stores printed cards (max. 60 cards).
7 Top Cover Button	Opens the Top Cover.
8 Top Cover	Open top cover to load a ribbon and replace a cleaning roller.
9 Right Side Cover	Open to replace the main board or fix errors.
10 Power Switch	Turns the printer on/off.
11 Card Eject Button	Release the card inside the printer.
12 Ribbon Set Button	Replace or reposition the ribbon.

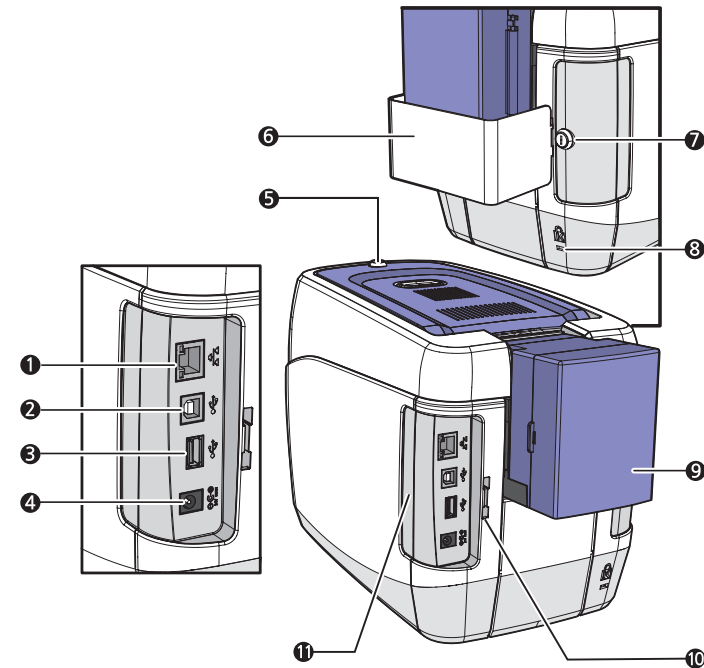

Name	Description
1 Ethernet Port	Used to connect to a network using a LAN cable.
2 USB Port	Used to connect to a PC using a USB cable.
3 USB Socket	Used to insert USB memory media or to connect to a PC.
4 Power Supply Port	Connects to the power supply.
OPTION 5 Top Cover Lock Key	Locks/unlocks the Top Cover.
OPTION 6 Input Hopper Lock	Used to lock the input hopper for Security.
OPTION 7 Input Hopper Lock Key	Locks/unlocks the input hopper.
8 Kensington Security Slot	Use this to mount a security lock.
9 Input Hopper (Standard)	Stores cards to print (max. 100 cards).
10 Lock Connector Link	Used to connect the Back Cover to the Input Hopper Lock.
11 Side Cover Open Section	Press to open the Side Cover.

-N20 / N30 (Auto Feeding, Single-sided Printing, 2 Input hoppers)

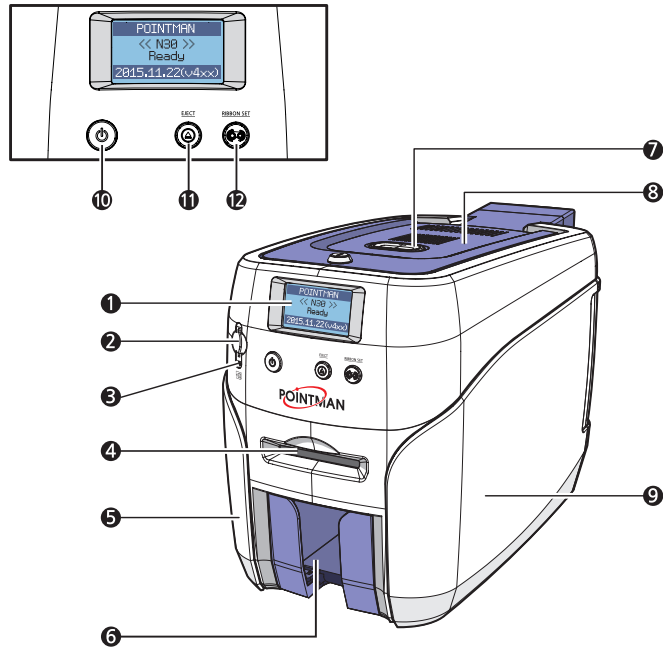

Name	Description
1 LCD Display	Displays the printer's operation status on the LCD screen.
OPTION 2 SIM Card Slot	Used for inserting mobile chips.
OPTION 3 SIM Card Slot LED	Indicates the mobile chip status.
4 Single Card Slot	Used to insert or release a single card.
5 Left Side Cover	Open to install optional accessories or fix errors.
6 Output Stacker	Stores printed cards (max. 60 cards).
7 Top Cover Button	Opens the Top Cover.
8 Top Cover	Open top cover to load a ribbon and replace a cleaning roller.
9 Right Side Cover	Open to replace the main board or fix errors.
10 Power Switch	Turns the printer on/off.
11 Card Eject Button	Release the card inside the printer.
12 Ribbon Set Button	Replace or reposition the ribbon.

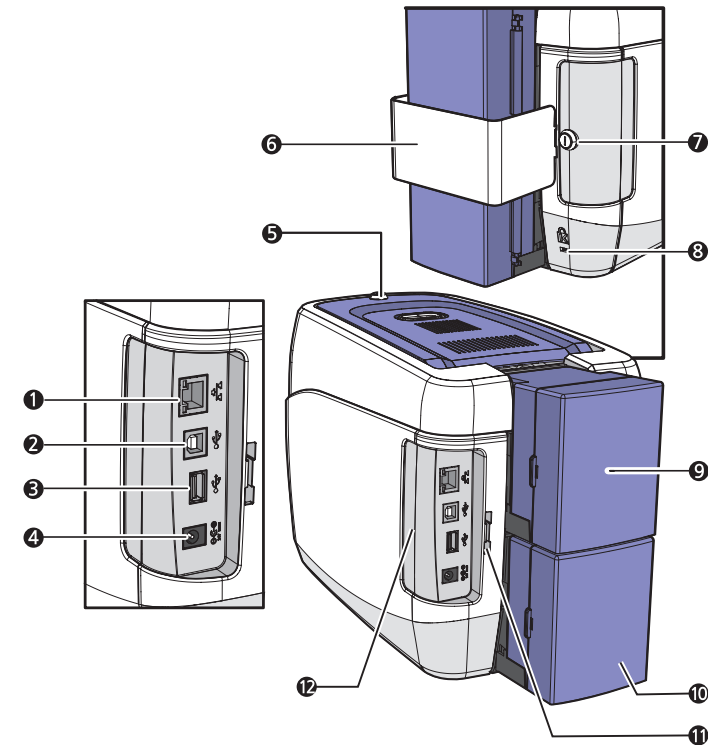

Name	Description
1 Ethernet Port	Used to connect to a network using a LAN cable.
2 USB Port	Used to connect to a PC using a USB cable.
3 USB Socket	Used to insert USB memory media or to connect to a PC.
4 Power Supply Port	Connects to the power supply.
OPTION 5 Top Cover Lock Key	Locks/unlocks the Top Cover.
OPTION 6 Input Hopper Lock	Used to lock the Input hopper for security
OPTION 7 Input Hopper Lock Key	Locks/unlocks the Input Hopper.
8 Kensington Security Slot	Use this to mount a security lock.
9 Input Hopper (Standard)	Stores cards to print (max. 100 cards).
10 Input Hopper (Optional)	Stores additional cards (Standard+Optional: max. 200 cards)
11 Lock Connector Link	Used to connect the back cover to the Input Hopper Lock.
12 Side Cover Open Section	Press to open the Side Cover.

-N20 / N30 (Auto Feeding, Double-sided Printing, 1 Input hopper)

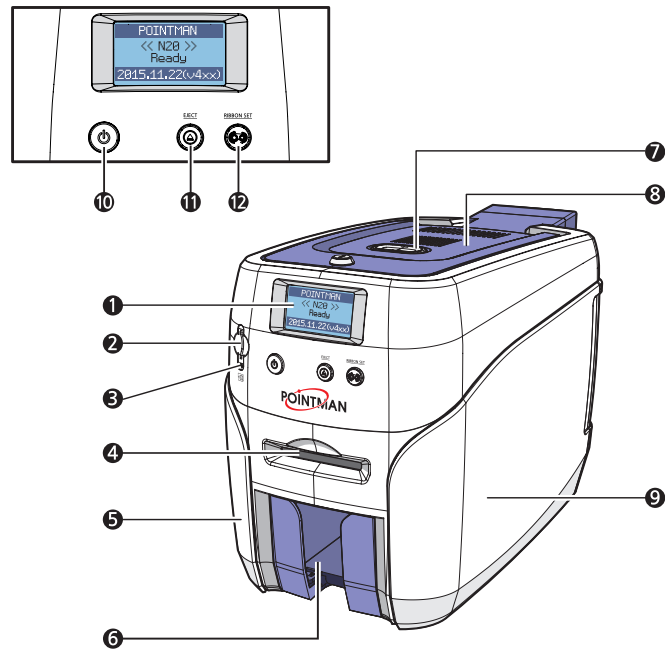

Name	Description
1 LCD Display	Displays the printer's operation status on the LCD screen.
OPTION 2 SIM Card Slot	Used for inserting mobile chips.
OPTION 3 SIM Card Slot LED	Indicates the mobile chip status.
4 Single Card Slot	Used to insert or release a single card.
5 Left Side Cover	Open to install optional accessories or fix errors.
6 Output Stacker	Stores printed cards (max. 60 cards).
7 Top Cover Button	Opens the Top Cover.
8 Top Cover	Open top cover to load a ribbon and replace a cleaning roller.
9 Right Side Cover	Open to replace the main board or fix errors.
10 Power Switch	Turns the printer on/off.
11 Card Eject Button	Release the card inside the printer.
12 Ribbon Set Button	Replace or reposition the ribbon.

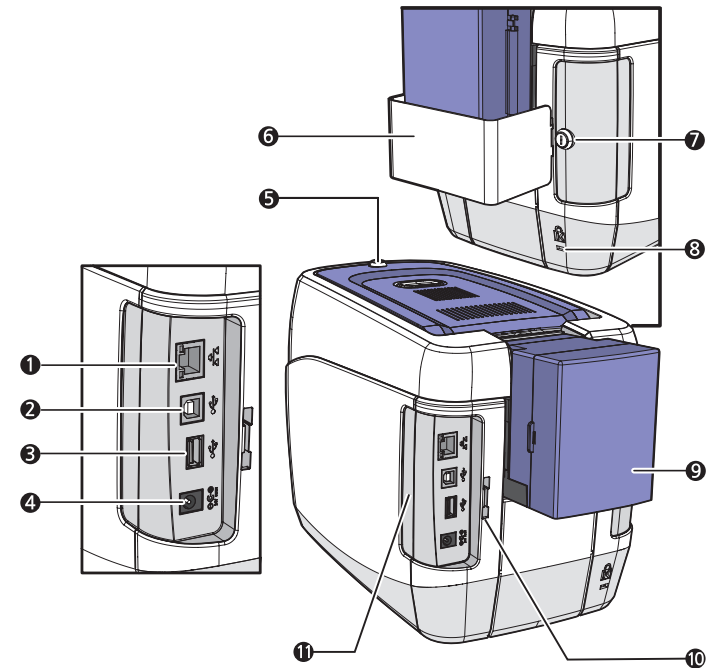

Name	Description
1 Ethernet Port	Used to connect to a network using a LAN cable.
2 USB Port	Used to connect to a PC using a USB cable.
3 USB Socket	Used to insert USB memory media or to connect to a PC.
4 Power Supply Port	Connects to the power supply.
OPTION 5 Top Cover Lock Key	Locks/unlocks the Top Cover.
OPTION 6 Input Hopper Lock	Used to lock the input hopper for Security.
OPTION 7 Input Hopper Lock Key	Locks/unlocks the input hopper.
8 Kensington Security Slot	Use this to mount a security lock.
9 Input Hopper (Standard)	Stores cards to print (max. 100 cards).
10 Lock Connector Link	Used to connect the Back Cover to the Input Hopper Lock.
11 Side Cover Open Section	Press to open the Side Cover.

-N20 / N30 (Auto Feeding, Double-sided Printing, 2 Input hoppers)

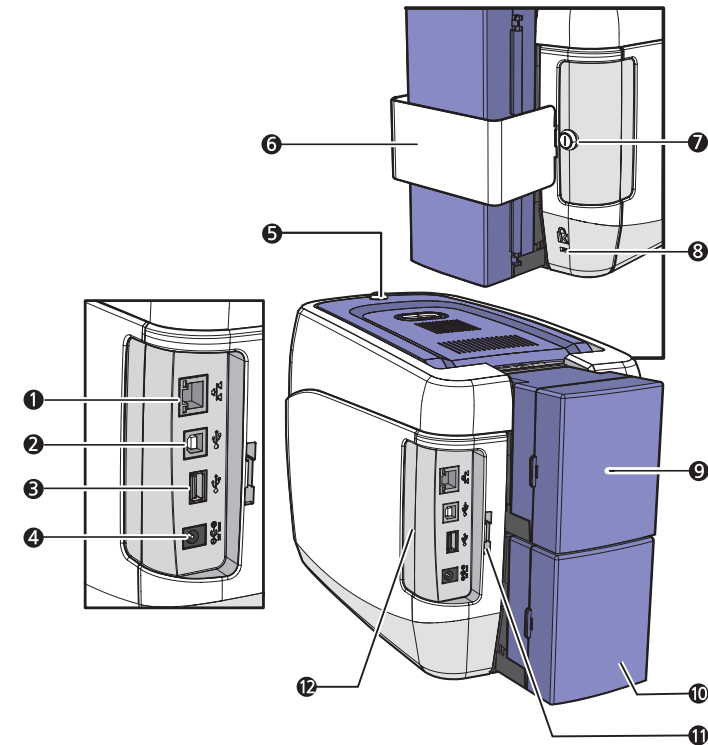
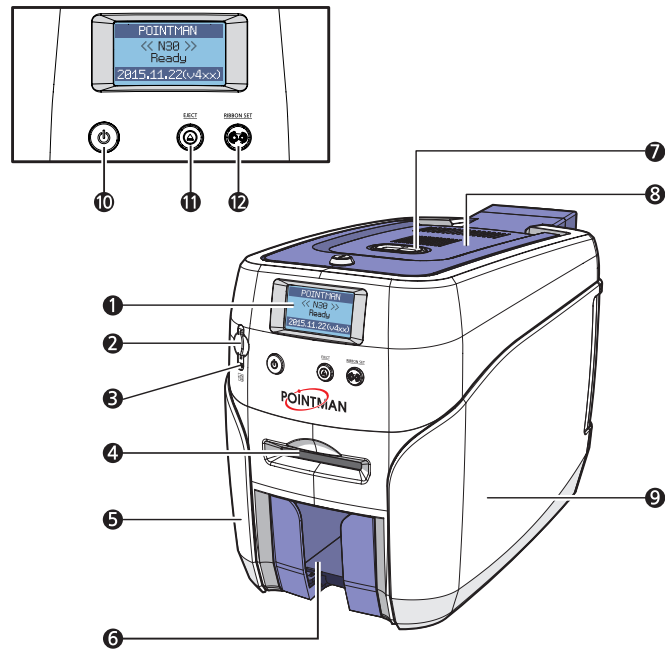

Name	Description
① LCD Display	Displays the printer's operation status on the LCD screen.
OPTION ② SIM Card Slot	Used for inserting mobile chips.
OPTION ③ SIM Card Slot LED	Indicates the mobile chip status.
④ Single Card Slot	Used to insert or release a single card.
⑤ Left Side Cover	Open to install optional accessories or fix errors.
⑥ Output Stacker	Stores printed cards (max. 60 cards).
⑦ Top Cover Button	Opens the Top Cover.
⑧ Top Cover	Open top cover to load a ribbon and replace a cleaning roller.
⑨ Right Side Cover	Open to replace the main board or fix errors.
⑩ Power Switch	Turns the printer on/off.
⑪ Card Eject Button	Release the card inside the printer.
⑫ Ribbon Set Button	Replace or reposition the ribbon.

Name	Description
① Ethernet Port	Used to connect to a network using a LAN cable.
② USB Port	Used to connect to a PC using a USB cable.
③ USB Socket	Used to insert USB memory media or to connect to a PC.
④ Power Supply Port	Connects to the power supply.
OPTION ⑤ Top Cover Lock Key	Locks/unlocks the Top Cover.
OPTION ⑥ Input Hopper Lock	Used to lock the Input hopper for security
OPTION ⑦ Input Hopper Lock Key	Locks/unlocks the Input Hopper.
⑧ Kensington Security Slot	Use this to mount a security lock.
⑨ Input Hopper (Standard)	Stores cards to print (max. 100 cards).
⑩ Input Hopper (Optional)	Stores additional cards (Standard+Optional: max. 200 cards)
⑪ Lock Connector Link	Used to connect the back cover to the Input Hopper Lock.
⑫ Side Cover Open Section	Press to open the Side Cover.

Load Blue Cleaning Roller & Ribbon

-Load Blue Cleaning Roller

1. Press the “Open” button and lift the Top Cover all the way as shown in the picture.

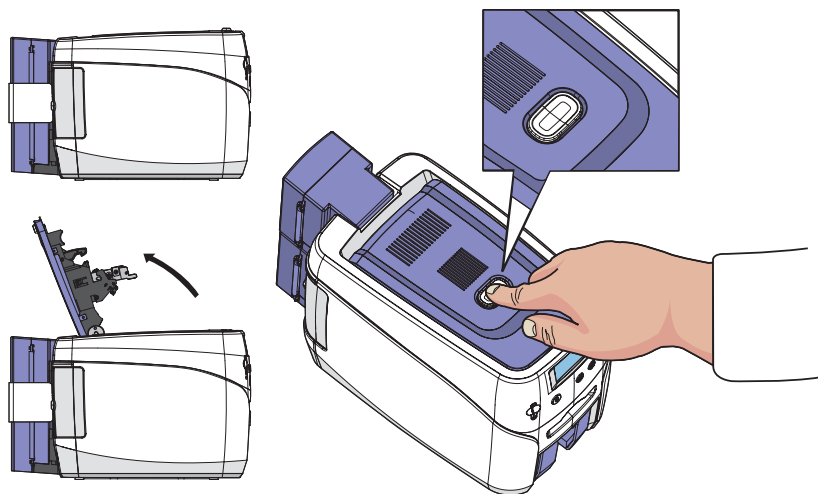

2. Place the Blue cleaning roller into the “U-shaped holder” and push it down.

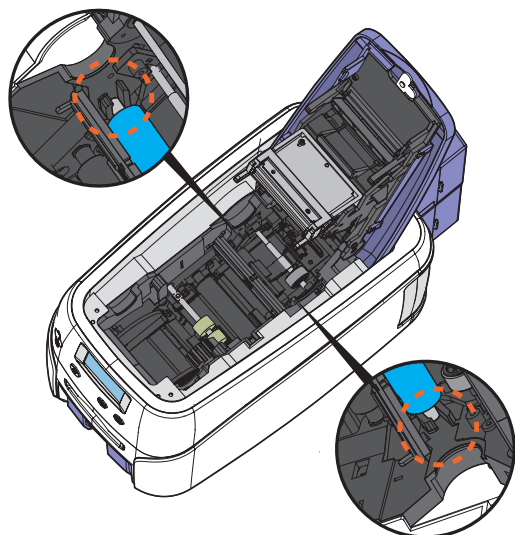

! Caution

- Wash the cleaning roller using running water and dry every 7 days if the printer is used frequently or when replacing the ribbon.
- If the cleaning roller is not cleaned properly, then the card may be printed unevenly or with marks across the card.. This may also cause serious damage to parts (e.g. print head).

-Load Ribbon

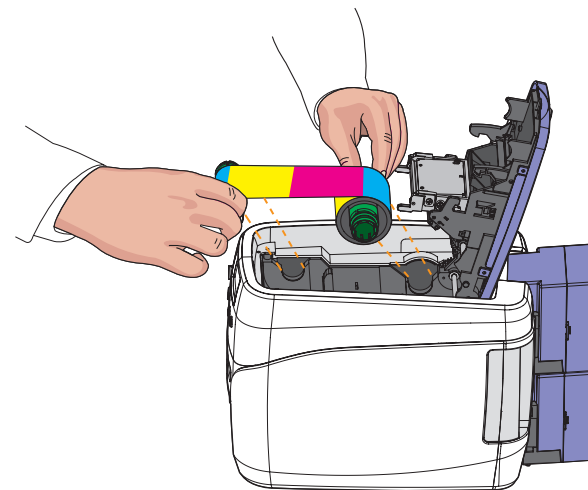

! Caution

- Do not close the cover by force when the ribbon is not placed properly as this may cause damage.
- If the Top Cover is not closed, the printer may not print properly (make sure it is closed completely).
- Make sure that the Ribbon RFID Tag is positioned correctly.

1. Make sure that the ribbon is positioned correctly for loading and rolling.

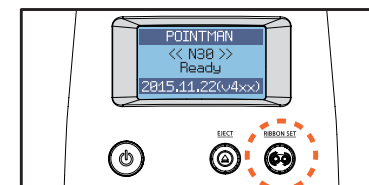

2. Close the cover and press the “Ribbon Set” button to complete the process.

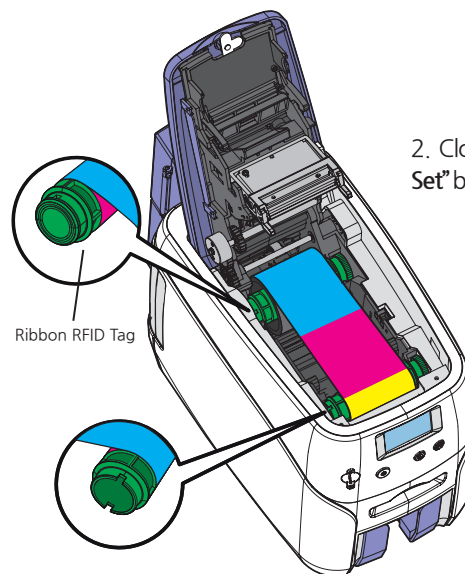

Load Cards

-Place Cards in the Input Hopper

To prevent card jam, please separate the cards from each other. Please arrange the card as the following pictures.

1. Push a stack of cards back and forth to an angle.

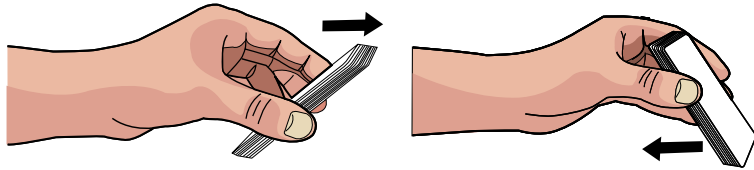

2. Align a stack of cards evenly and load the cards inside the input hopper as shown in the picture.

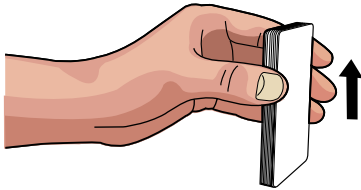

3. Open the Input Hopper by pulling it sideways.

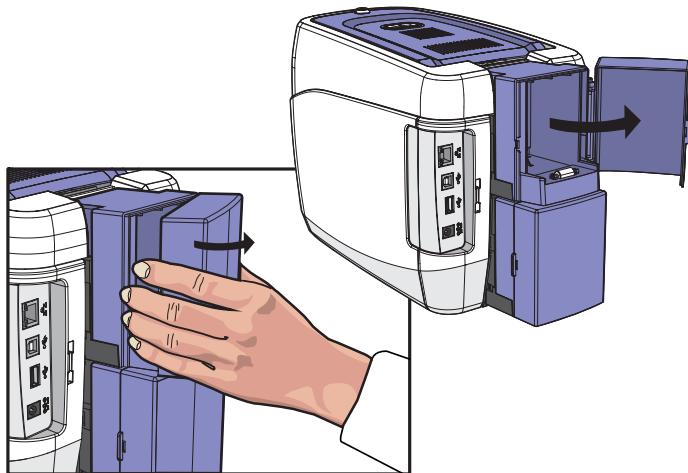

4. Place the cards inside the Input Hopper as shown in the picture.



Caution

- Make sure that the IC chip is facing the outside.
- If IC /Magnetic Stripe cards are not placed correctly, then an error will occur.
- Make sure the magnetic stripe should be on the bottom and to the left.

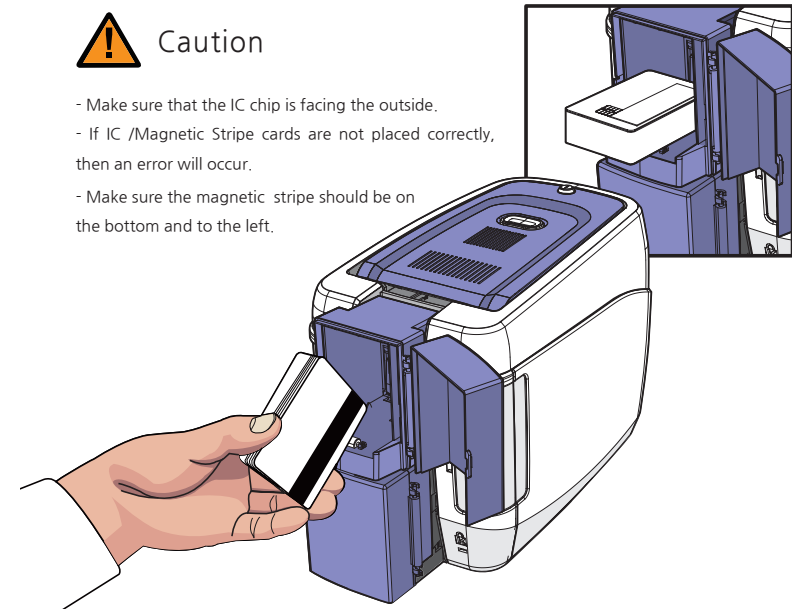

-Place Cards after Removing the Input Hopper

1. Hold the Input Hoppers by the sides, and pull it backward to remove it.

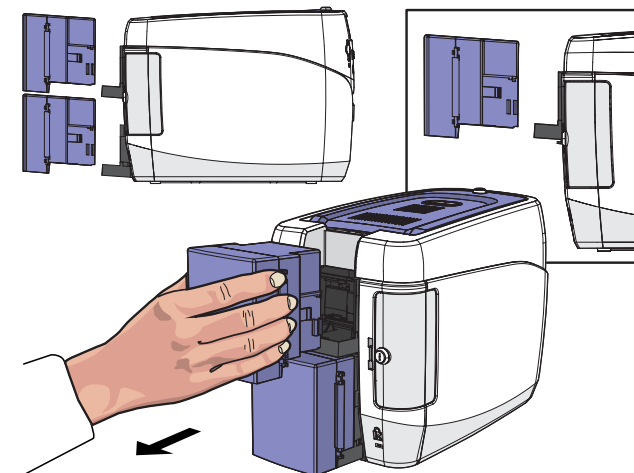

2. Hold the backside of the Input Hopper with one hand and open the cover with the other. Then, place the cards inside as shown in the picture.

 **Caution**

- Make sure that the IC chip is facing the outside.
- If IC Cards are not placed correctly, then an error will occur.

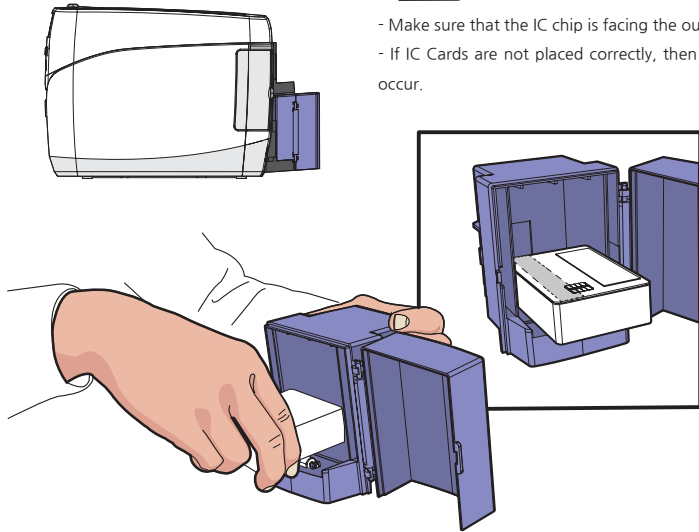

3. Close the cover, and place the Input Hopper in the tray.

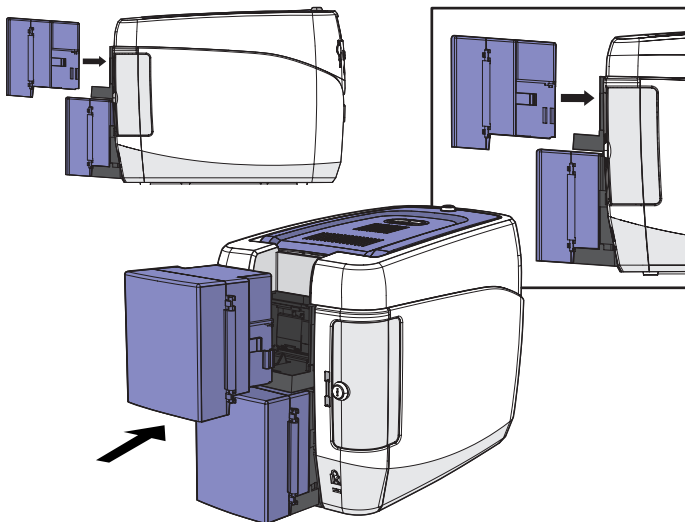

 **Note**

- The hinge is located where the card is loaded into the path to prevent displacement.
- The hinge is lifted when the card is loaded into the printer.

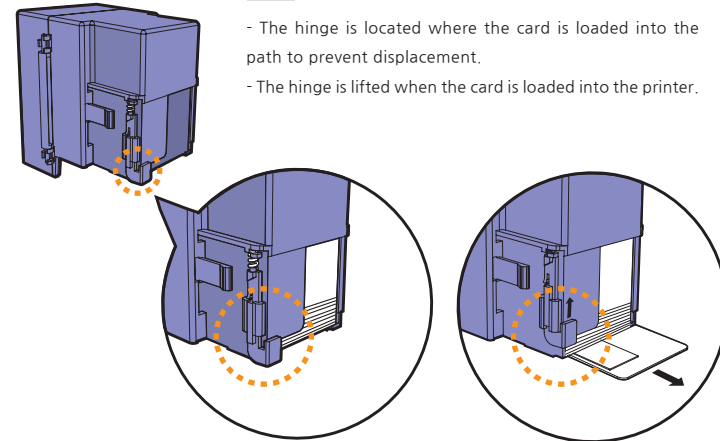

Before the input card hopper is loaded

When the input card hopper is loading

Print Single Card

1. Insert a card into the front single card slot as shown in the picture.

 **Note**

- For N10, N20, N30 printers

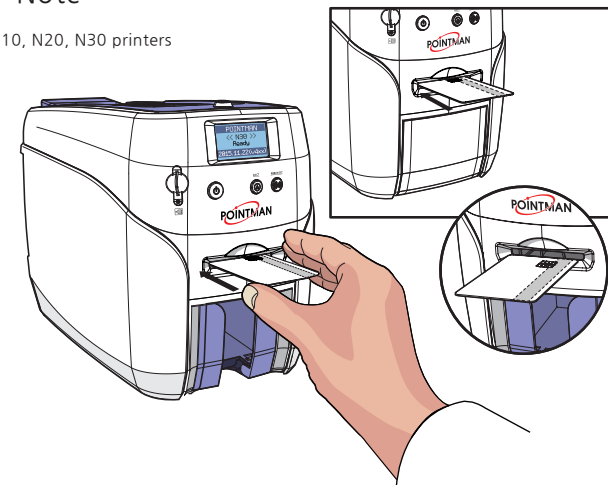

 **Caution**

- Make sure the IC Chip is on the leading edge into the printer
- If IC Cards are not placed correctly, then an error will occur.



Note

- The card loaded in the single card slot is printed first, even if there are cards in the Input Hopper.

- This feature is intended for printing both a large quantity of cards (e.g. standard cards) and a small quantity of cards (e.g. VIP membership cards) without removing the cards loaded in the input hopper.

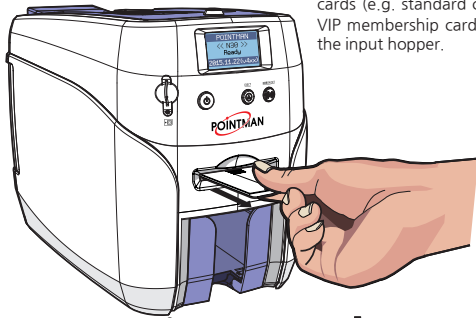

Magnetic Cards

If the printer has the MS module (Single/Triple Track Head), it can encode information on the Mag. Stripe card.. (ISO 7811 track 1,2,3, Hi-Co/Lo-Co)

Magnetic Card Standard		: ISO 7811		
	Track	Track 1	Track 2	Track 3
	Recording Density	210 BPI	75 BPI	210 BPI
ISO 7811	Capacity	79 alphanumeric characters	40 numeric characters	107 numeric characters
		(7 bit code)	(5 bit code)	(5 bit code)
	Start / End code	%/?	;/?	;/?

When loading Mag. Stripe cards, make sure the magnetic stripe is facing down and on the left side as shown in the pictures.

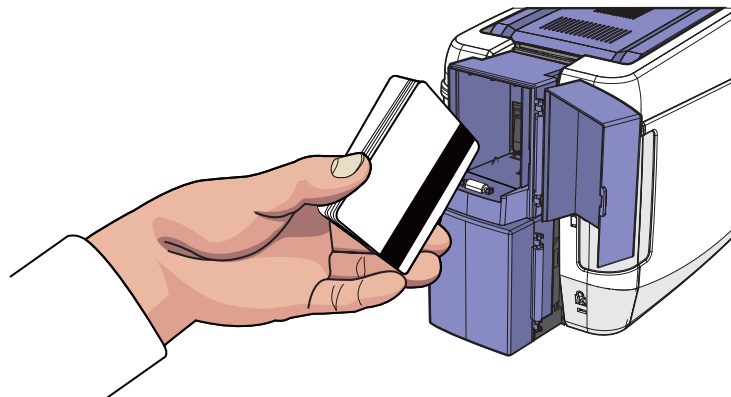

Input Hopper & Ribbon Lock

OPTION -Input Hopper Lock

1. Place the Input Hopper Lock in the area highlighted by the circle and push it down to fix it in the position. Then, use the Lock Key to lock it.

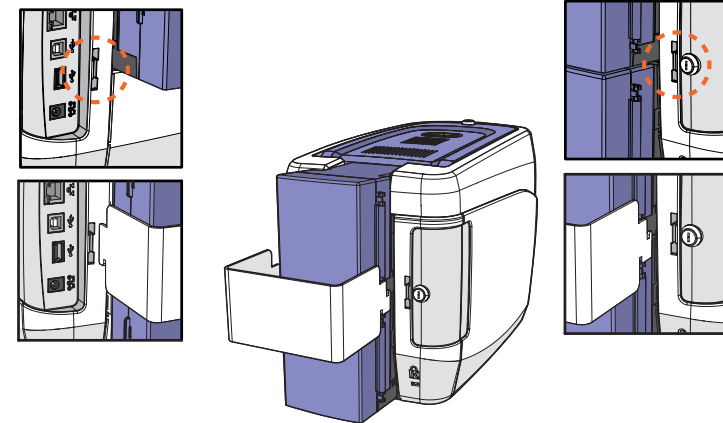

OPTION -Top Cover Lock

1. Use the Lock Key to lock the Top Cover.

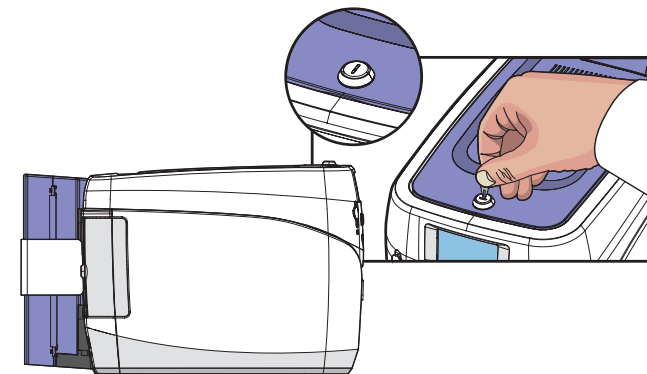

Install/Remove Output Stacker

The Output Stacker can be installed or removed as follows:

Option 1: Open the Output Stacker cover and take the cards.

Option 2: Use the spring load to remove a small quantity of cards.

Option 3: Pull the Output Stacker out and take the cards.

-Open the Output Stacker Cover and Take the Cards

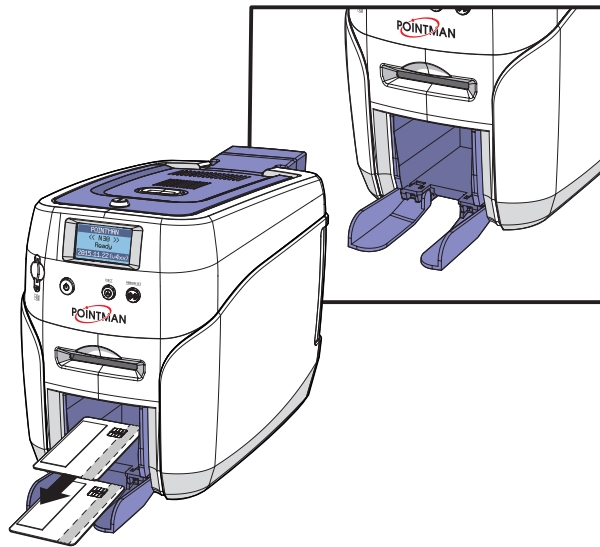

Lower the Output Stacker cover until it latches as shown in the picture. Use this method when printing a small quantity of cards and check the results right away.

-Use the Spring Load to Take a Small Quantity of Cards.

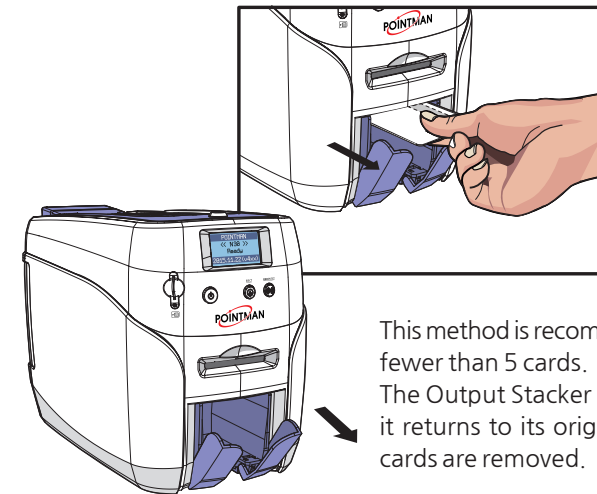

This method is recommended when printing fewer than 5 cards. The Output Stacker is spring loaded so that it returns to its original position when the cards are removed.

- Pull the Output Stacker out and take the Cards.

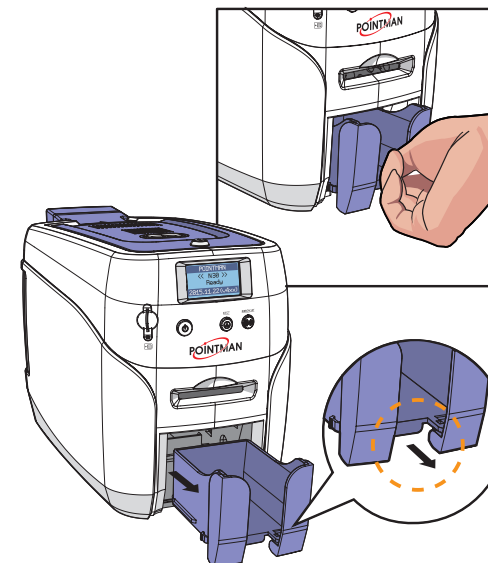

Push the Output Stacker and pull it forward and then pull it back to take it as shown in the picture.

This method is recommended for printing more than 50 cards, and up to 60 cards can be loaded in this way.

Connect Power & Communication Cables

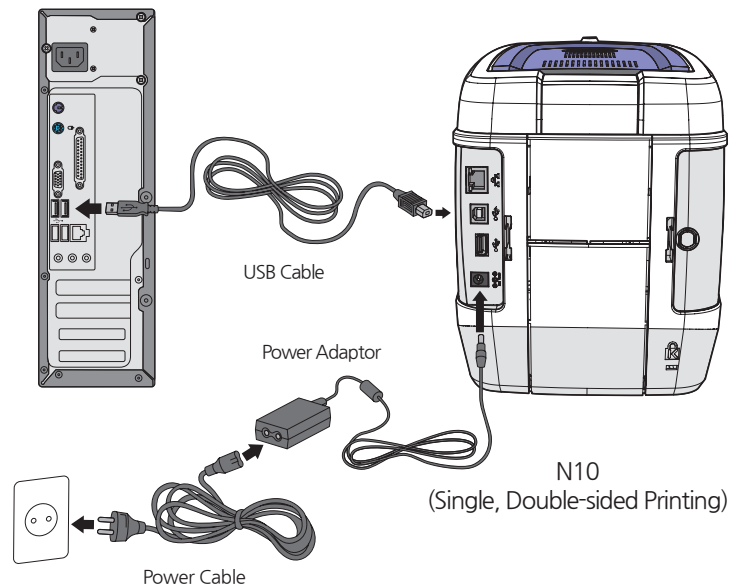
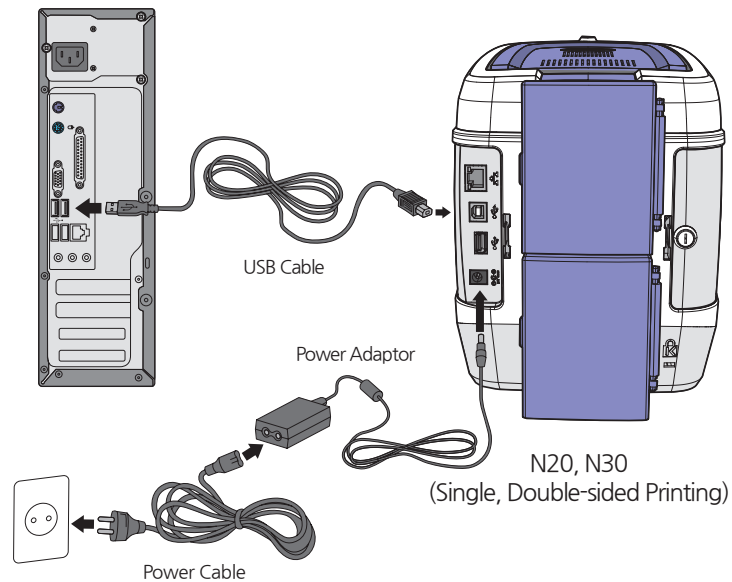

Install Program

-System Requirements

① Supported Operating Systems

- Windows 2000
- Windows XP (32/64bit)
- Windows Vista (32/64bit)
- Windows 7 (32/64bit)
- Windows 8 (32/64bit)
- Windows 10 (32/64bit)
- Windows 2012 R2 Server
- Windows 2008 Server
- Windows 2003 Server (32/64bit)

② Recommended Specifications

- CPU: Pentium III 1 Ghz (Pentium IV 1.5 Ghz is recommended)
- Memory: 128 MB (512 MB is recommended)
- HDD: 1 GB (5 GB is recommended)
- Internet Explorer 5.5 or higher (6.0 is recommended)



Note

You need to log in as an Administrator to install or uninstall the driver on Windows 2000/XP/Vista/7/8.

-Install Software



Caution

It is recommended to close all programs before installing the software.

① Install Software Using Local Port(USB)

1. Insert the CD into the PC's CD-ROM drive, and the setup program will start automatically. If the program does not start automatically, then go to the CD-ROM drive's root directory and run "install.exe" manually.

2. The initial screen of the Card Printer Driver is displayed as shown in the picture. Click **“Start”** to install the program.

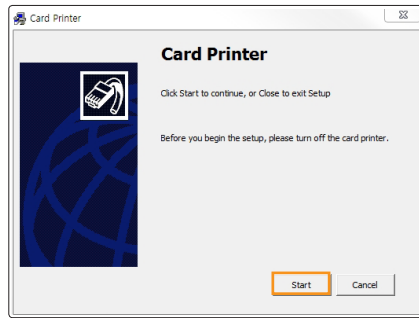

3. Select the software to install and click **“Next”** to proceed. (Card Designer Software, Card Printer Driver)



4. Read the Terms of Use and check **“Agree”**. Then, click **“Next”** to proceed.

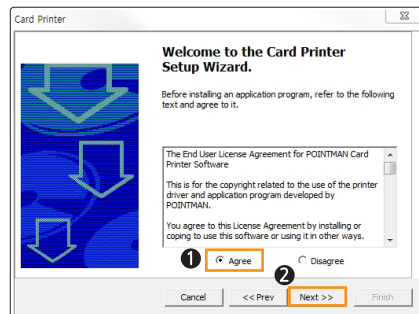

5. Specify the Port Type and click **“Next”**. (Select **“CITIUSB”** when connecting the printer directly to the PC using a USB cable.)

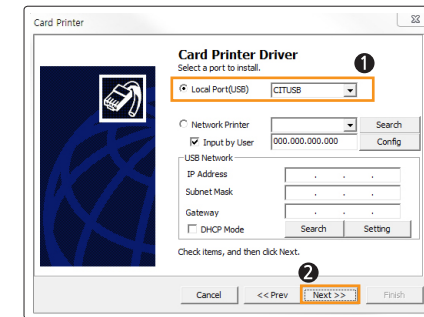

6. Click **“Finish”** to complete the installation process.

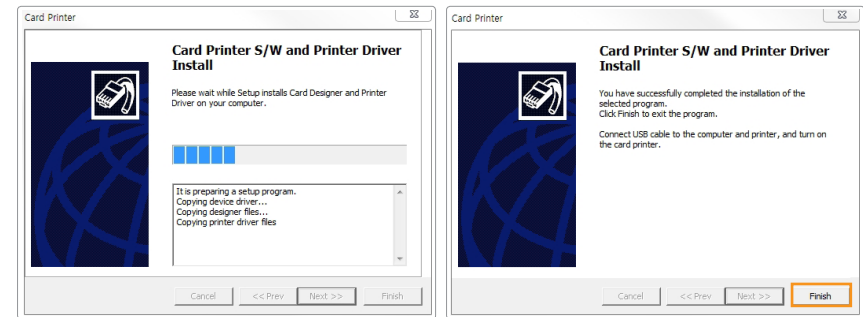

7. Make sure that the following programs are installed.

For **“Card Designer Software”**, check:
“Start → All Programs → POINTMAN → Card Designer”

For **“Card Printer Driver”**, check:
“Start → All Programs → POINTMAN → Printer”
 Go to **“Devices and Printers”** and make sure **“Card Printer”** has been installed.

② Install Software for Network Printer



Caution

Conect the LAN cable between the Ethernet port and the router/server PC should be connected to network.

1. Insert the CD into the PC’s CD-ROM drive and the setup program will start automatically. If the program does not start automatically, then go to the CD-ROM drive’s root directory and run **“install.exe”** manually.

2. The initial screen of Card Printer Driver is displayed as shown in the picture. Click **"Start"** to install the program.

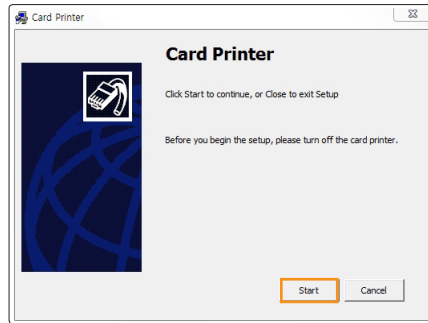

3. Select the Printer Driver & Network Driver options to install and click **"Next"** to proceed. (Connect a LAN cable to the NUVIA series-NX0 with Ethernet option and select **"Network Software"**.)



4. Read the Terms of Software and check **"Agree"**. Then, click **"Next"** to proceed.

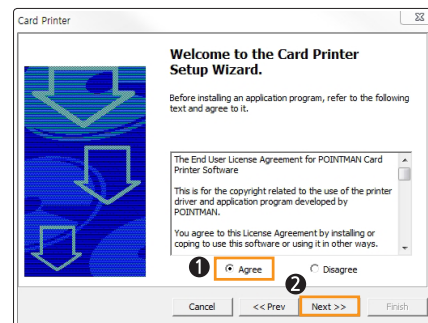

5. Click **"Finish"** to complete the installation process. Finish.

5. Install Network Printer

5-1. Auto Installation

Select **"Network Printer"** and the printer IP address will be displayed if it is connected to the network. Click **"Next"** to continue.

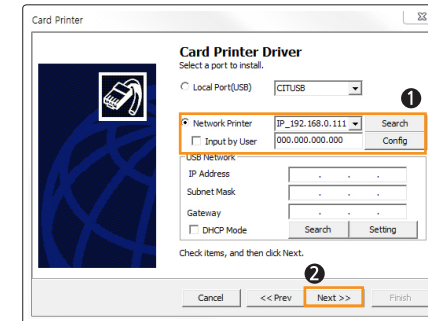

5-2. Manual Installation

If the printer's IP address is not shown as in the picture, then check the following. (Make sure that the printer is in the same IP range.)

(1) If they are in the same IP range

For example, if your PC's IP address is 192.168.0.xxx, then the printer's IP address must be 192.168.0.yyy.

If they are not in the same IP range, check **"Input by user"** and enter the printer's IP address. Then, click **"Next"** to proceed.

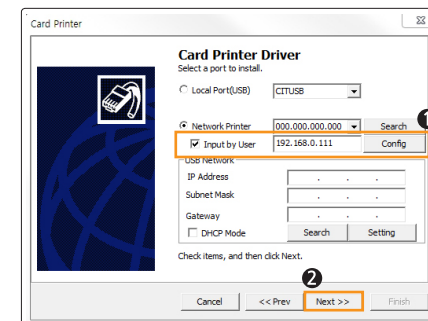

(2) If they are in the same IP range, but the printer cannot be found
Check "Input by user" and click "Setting".

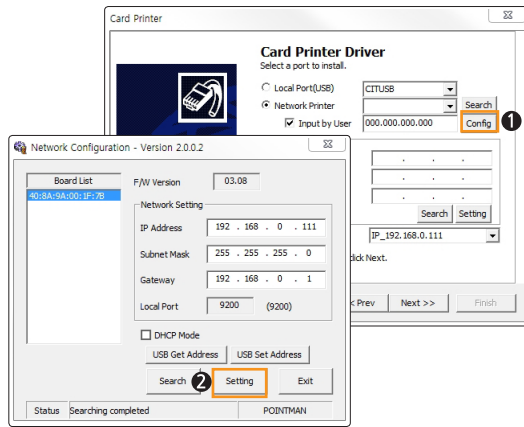

When the Network Configuration window pops up, the available printers will be displayed.

Check the IP Address, Subnet Mask and Gateway and click "Setting".

Check DHCP to enable DHCP mode and click "Setting". If the settings are entered correctly, the printer will initialize.

If the IP address and Board List are not specified in the Network Configuration window, then they may be in a different IP address range or the printer is not connected to the network. You will need to check your network settings.

5-3. Manual Installation (Connect to the printer using a USB connection)

If the printer is not automatically detected, connect to the printer using a USB connection and configure the network settings.

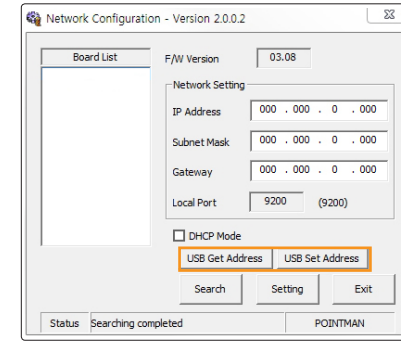

(1) Retrieve Address via USB

Connect the printer to a PC using USB connection and click "USB Get Address" to check the device's IP Address, Subnet Mask, Gateway and MAC address.

(2) Set Address via USB

Check the values retrieved through "Retrieve Address via USB". Enter the IP Address, Subnet Mask, and Gateway, and click "Retrieve Address via USB"

6. Click "Finish" to complete the installation process.

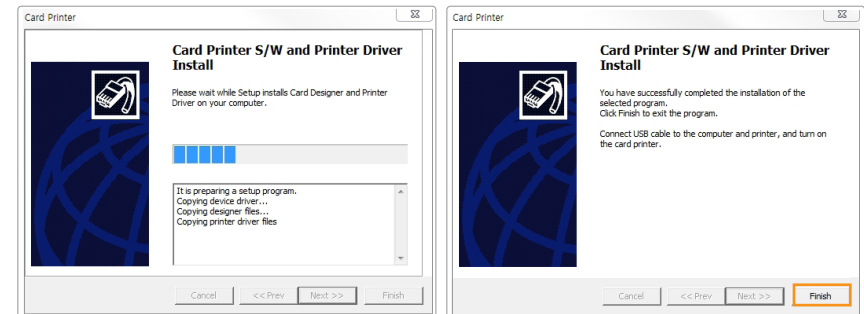

③ Configure Network Settings

After installing the printer driver, go to the following path to configure network settings. (This feature is only supported by some models.)

"Start → All Programs → POINTMAN → Network"

"Start -> Apps (by name) -> Pointman -> Network setting"

1) Network Configuration Window

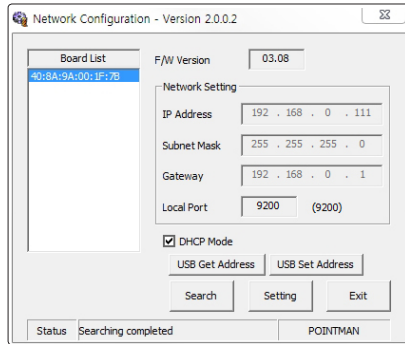

Item	Description	
Board List	Displays a list of detected printers.	
Firmware Version	Displays the firmware version of the selected network board.	
Network Setting	IP Address	Displays the IP address of the selected network board.
	Subnet Mask	Displays the subnet mask of the selected network board.
	Gateway	Displays the gateway of the selected network board.
	Local Port	Sets the port of the network printer.
DHCP Mode	Sets the IP address automatically for network environments that support DHCP. Otherwise, you need to retrieve the allocated IP address and enter manually.	
USB Get Address	Retrieves the printer's network address USB.	
USB Set Address	Sets the printer's network address via USB.	
Search	Searches the printer's network.	
Setting	Saves the new network information to the printer. After the settings are applied, the printer reboots. This reboot takes about 10 seconds.	
Exit	Exit the program.	

2) DHCP (Dynamic Host Configuration Protocol)?

DHCP (Dynamic Host Configuration Protocol)?

DHCP is a network protocol that automatically allocates TCP/IP to the client PC.

The DHCP server sends the client's network settings (e.g. IP Address, Subnet Mask, Gateway, DNS server) automatically.

If "Obtain an IP Address automatically" is set in your TCP/IP settings, it means that DHCP Mode is enabled.

3) Network Setting - Automatic (DHCP supported)

1. Go to "Start → All Programs → POINTMAN → Network" and click OK to open the settings window.

2. In the Network Configuration window, click "Search" to search the connected network board.

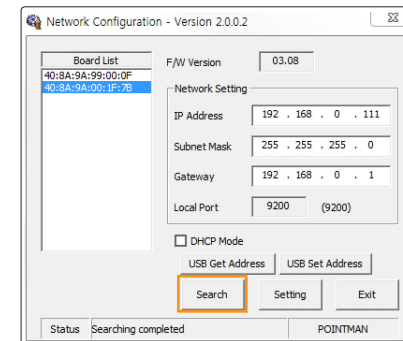

3. Select the MAC Address from the Board List.

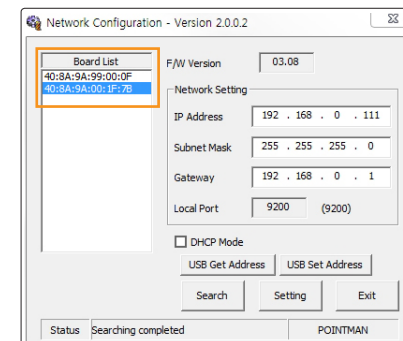

4. The IP Address, Subnet Mask and Gateway are allocated automatically by the DHCP server, and there is no need to set the values.

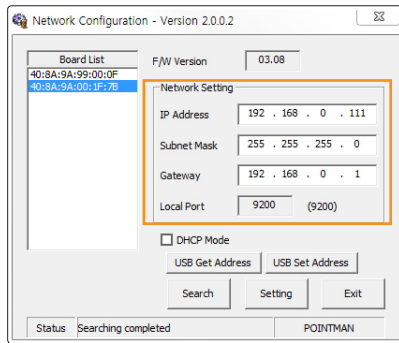

5. Set the Local Port to 9200 (cannot be changed).

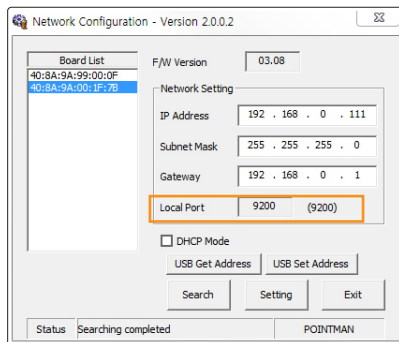

6. Check the DHCP Mode.

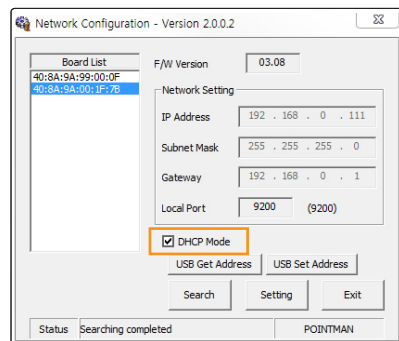

7. Click "Setting". This takes about 30 seconds. When the settings complete, the printer reboots automatically and retrieves a new IP address from the server.

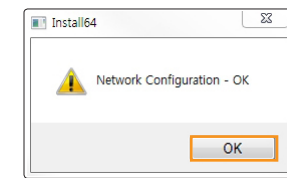
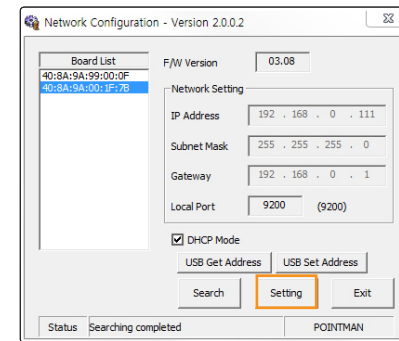

8. Click "Exit" to complete the network configuration process.

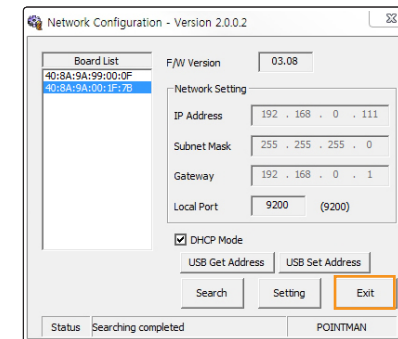

4) Network Setting - Manual

Retrieve the IP Address, Subnet Mask and Gateway to be used by the printer from the network administrator.

1. Go to "Start → All Programs → POINTMAN → Network" and click "OK" to open the settings window.

2. Select the MAC address from the Board List.

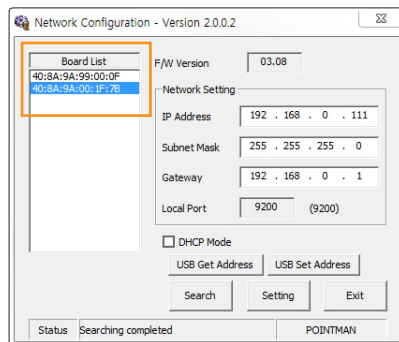

3. Enter IP Address, Subnet Mask and Gateway.

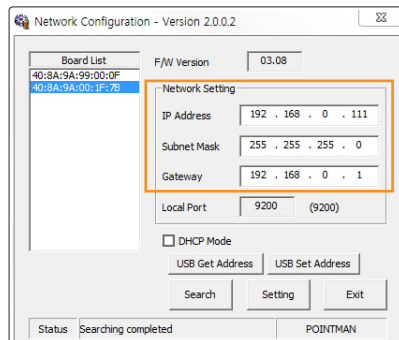

4. Set the Local Port to 9200 (cannot be changed).

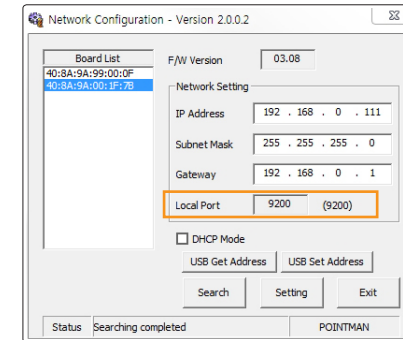

5. Do not check the DHCP Mode. Make sure to leave the box unchecked.

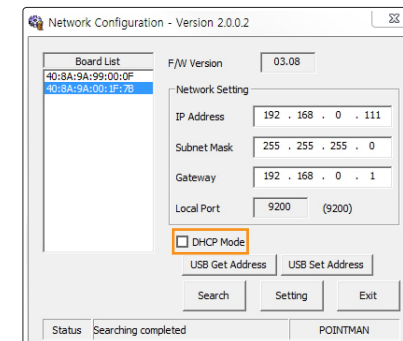

6. Click "Setting". This takes about 30 seconds. When the settings complete, the printer reboots automatically.

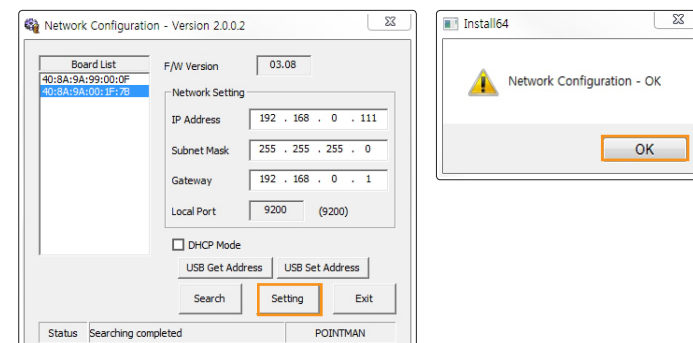

7. Click "Search" to check the network configuration.

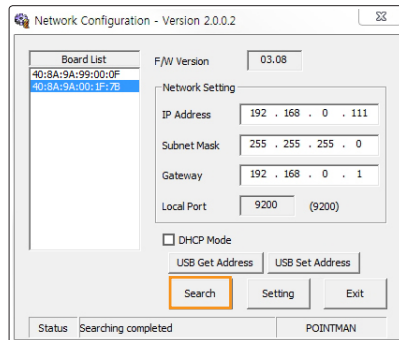

8. Click "Exit" to complete the network configuration process.

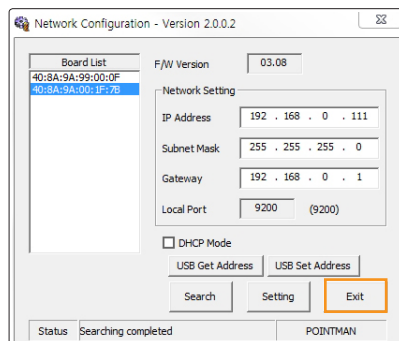

Uninstall Program

1. Go to Control panel → Uninstall Program → Select "Card Printer" on the list → Select "Uninstall"

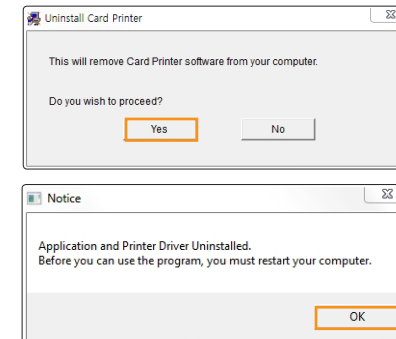

Print Cards

-Set as Default Printer

You can change the printer settings using the functions provided by the printer driver.

1. Go to "Hardware and Sound → Devices and Printers" in the "Control Panel".
2. Right-click "Card Printer" and select "Set as default printer".

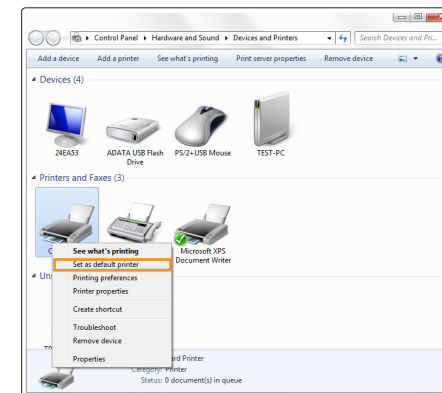

Note

Use this printer settings when there are no other printers connected to your PC.

-Change Printer Port (Using the Printer Driver)

1. Go to “Hardware and Sound → Devices and Printers” in the “Control Panel”.
2. Right-click “Card Printer” and select “Properties (or Printer Properties)”.

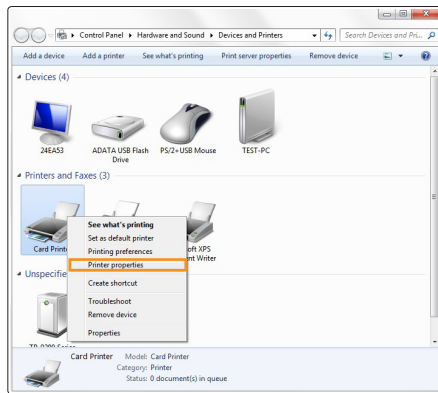

3. Select “Ports (or Advanced)” tab in the “Card Printer Properties”.

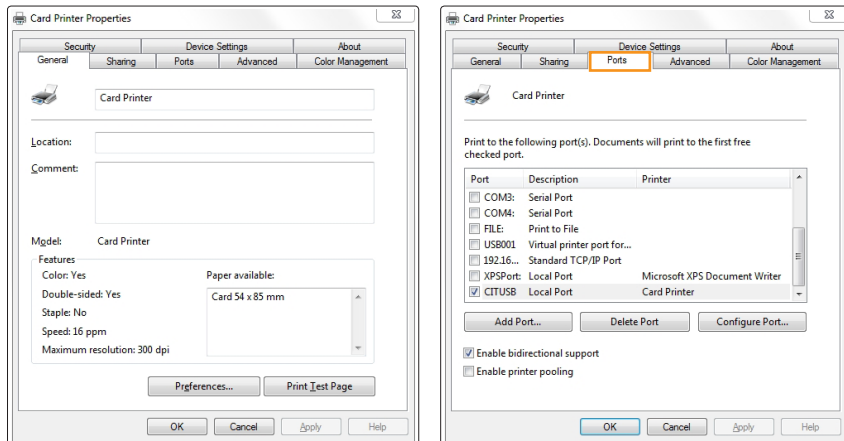

4. Select the port you want to use and click “OK”.
- USB Port: CITUSB (Local Port)

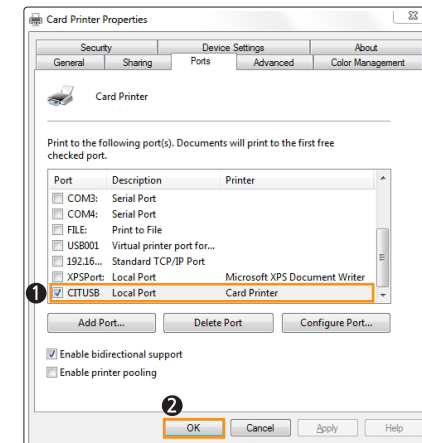

Network Port: Refer to “Configure Network Settings” (P40) and select the port (IP Address) accordingly.

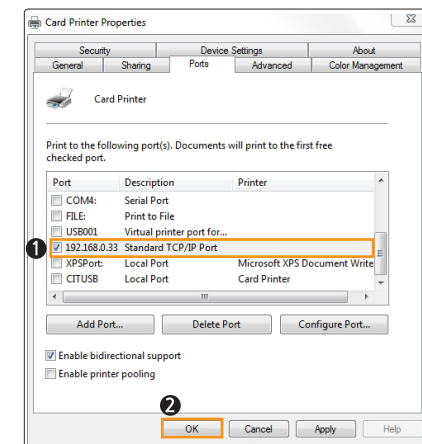

Note

When the driver is installed successfully, “Two-Way Communication” will be selected automatically. If there is any problem printing through the network port, make sure to disable “Two-Way Communication”.

OPTION

-Select Input Hopper in the Printer Settings

1. Go to “Hardware and Sound → Devices and Printers” in the “Control Panel”.
2. Right-click “Card Printer” and select “Printing Preferences”.

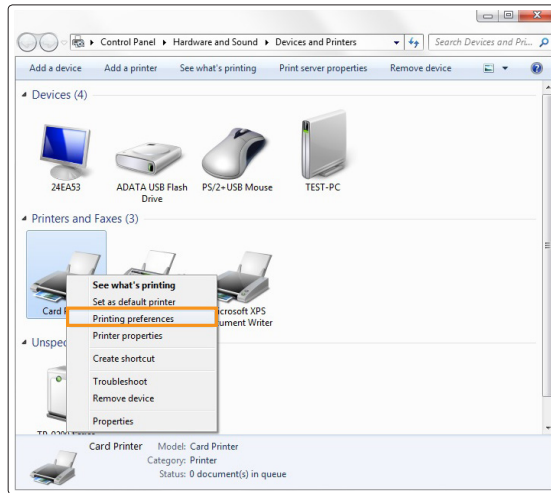

3. Go to “Paper” tab.

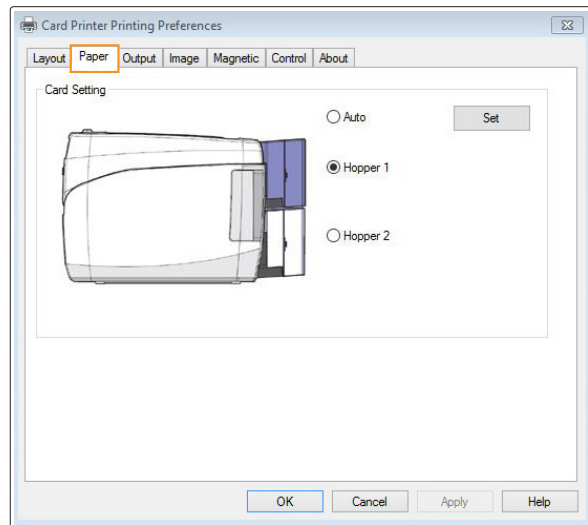

(Dual Hoppers will be appeared when a dual hopper printer is connected only)

4. Select the Card Source.

If the printer(Nuvia N20 or N30) has two input hoppers, you are able to select the card hopper. Default value is Auto.

Item	Description
Auto	Usually dispensing the card from the upper hopper. If there is no card at the upper hopper, dispensing the card from the lower hopper.
Hopper 1	Only dispensing the card from the upper hopper.
Hopper 2	Only dispensing the card from the lower hopper.

Print Using Application Programs & Configure Driver Settings

-Print Using Application Programs

1. Specify the paper as 53.98mm x 85.60mm to print cards using application programs e.g. Excel, Word.
2. Click "Print" in the "File" menu to open the print settings. Select "Card Printer" in the settings and click "Print" or "OK" to print.

Make sure that the orientation of the image matches the print settings. You can use the preview option to confirm the print output.



Note

- You can cancel print jobs from either the application program or print spooler.
- If the card is jammed while printing, then press the "EJECT" button in the front side of the printer.

-Configure Printer Default Settings in Application Programs

Each time you change the print settings in the application program, it will be reset to the default settings when you exit the program.

Click "Print" in the "File" menu to open the print settings. Go to "Printer Properties → Card Printer Printing Properties" in the printer section and change the settings in the "Layout, Paper, Output, Image, Magnetic, Control and About" tabs. (Click each tab to open the settings.)

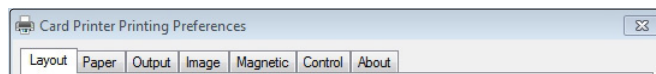

Caution

The card printer does not use the "Paper/Quality" tab in the Card Printer Document Properties.

Click "OK" to complete the process.

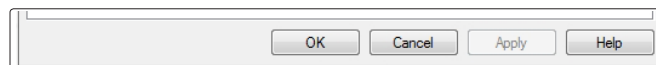

① Layout

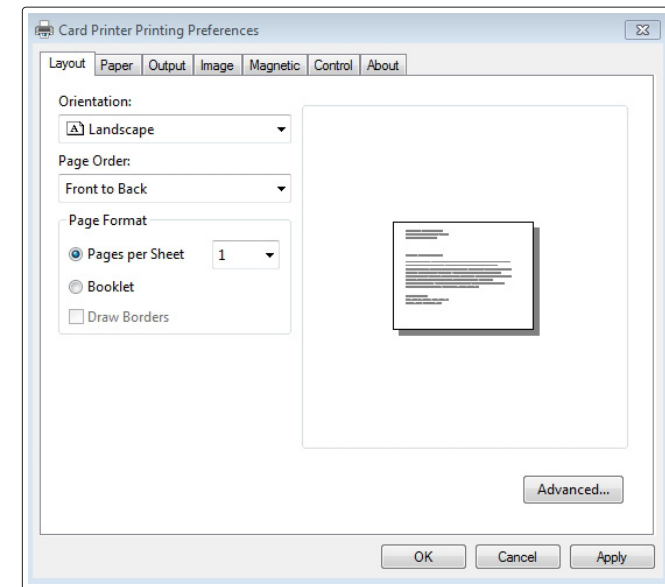

Item	Description
Orientation	Sets the card orientation Portrait or Landscape.
Page Order	Sets the page sequence.
Page Format	Not applicable.

② Paper

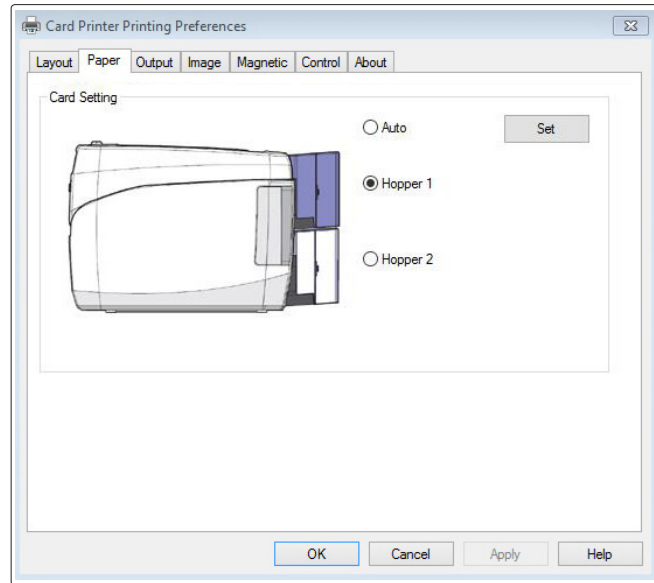

Select the Card Source.
If the printer(Nuvia N20 or N30) has two input hoppers, you are able to select the card hopper.
Default value is Auto.

Item	Description
Auto	Usually dispensing the card from the upper hopper. When cards in the upper hopper run out, it starts to feed a card from the lower card hopper automatically.
Hopper 1	Only dispensing the card from the upper hopper.
Hopper 2	Only dispensing the card from the lower hopper.

③ Output

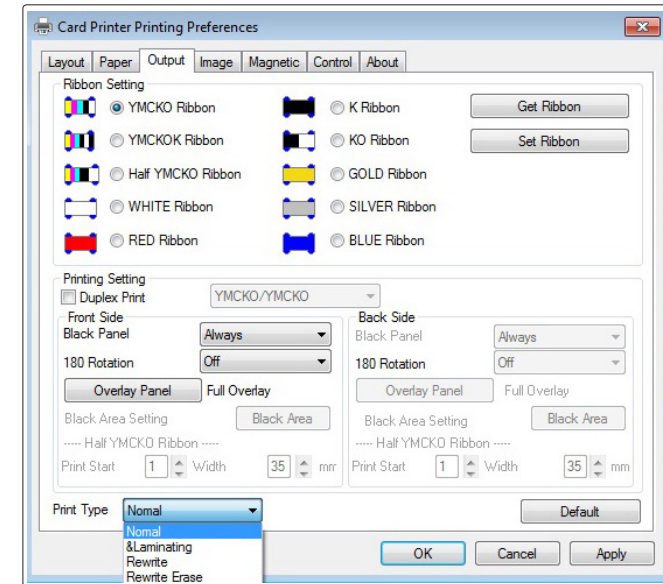

Item		Description
Ribbon Setting		Sets the type of ribbon.
Printer Setting	Duplex Print	Prints on both sides of the card.
	Black Panel	Selects the K panel for printing black text and black & white images included in the document.
	180 Rotation	Rotates the document 180 degrees.
	Overlay Panel	Sets the type of overlay panel for protecting the printed card. -Full Overlay /No Overlay /Selected Area /Use Image File -Smart Card ISO /Smart Card AFNOR /Magnetic Card
Print Type	Normal	Normal Card Printing Mode
	& Laminating	Connect NL200 series card laminator to the printer and can laminate a card after printing.
	Rewrite	Rewrite a card. Please unlock rewrite function before use and remove a ribbon from the printer.
	Rewrite Erase	Can erase a rewritten card. Please unlock rewrite function before use and remove a ribbon from the printer.

④ Image

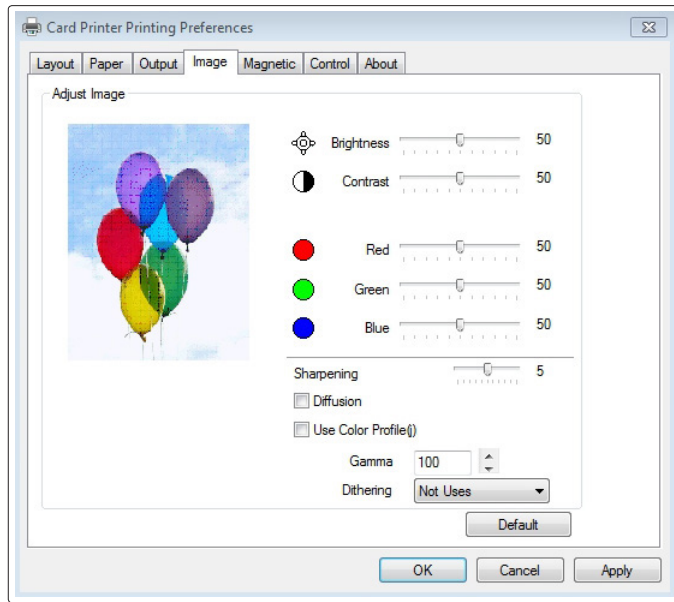

	Item	Description
Adjust Image	Brightness	Sets the brightness of the printed card.
	Contrast	Sets dark areas as darker and bright areas as brighter.
	Sharpening	Increases the contrast of adjacent pixels to make the image look sharper.. This filter adjusts the contrast of the edge details and creates brighter and darker lines on each plane of the edge, resulting in a sharper image with clearer outlines.
	Diffusion	Mixes the pixels of an image and makes it look blurry. This filter mixes pixels in such a way to minimize the change of colors.
	Use Color Profile	Supports more colors by using the color profile.
	Gamma	Control the lightness of images
	Dithering	Apply special effect in processing of digital image. This function is used for gray scale image.
	Default	Restore the values to the default setting

⑤ Magnetic

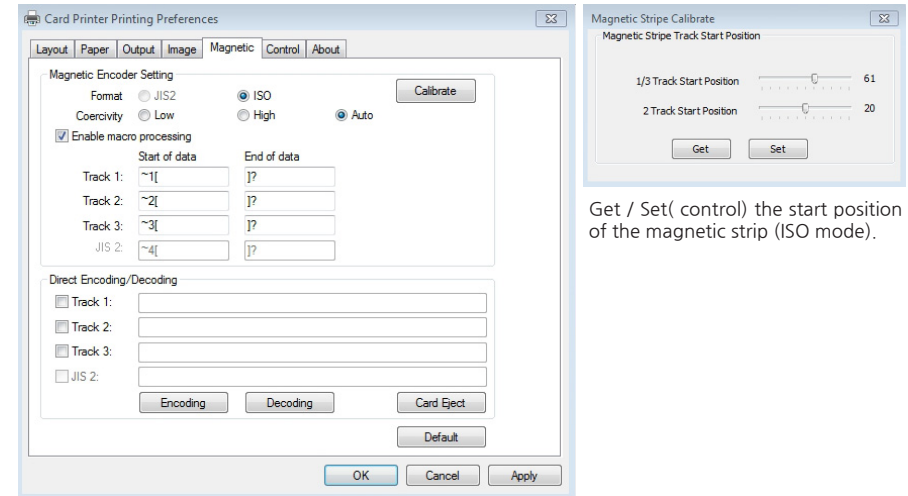

Get / Set(control) the start position of the magnetic strip (ISO mode).

	Item	Description
Magnetic Encoder Settings	Format	Sets the encoder format of the magnetic stripe.
	Coercivity	Sets the coercivity type of magnetic stripe.
	Enable macro processing	Sends data to the magnetic stripe. When enabled, it detects the start and end of the encoding data from text format and processes it with Magnetic Stripe Encoding data.
	Magnetic strip Calibrate	Get / Set(control) the start position of the magnetic strip
Direct Encoding /Decoding	Encoding	Writes the data of selected track to the magnetic stripe. Track 1, 2, 3: Inputs the data to write on the magnetic stripe card.
	Decoding	Reads the data of the selected track from the magnetic stripe. Track 1, 2, 3: Displays the data read from the magnetic stripe card.
	Card Eject	Ejects any card inside the printer.

In case of the Japanese window only, JIS2 button is enabled.

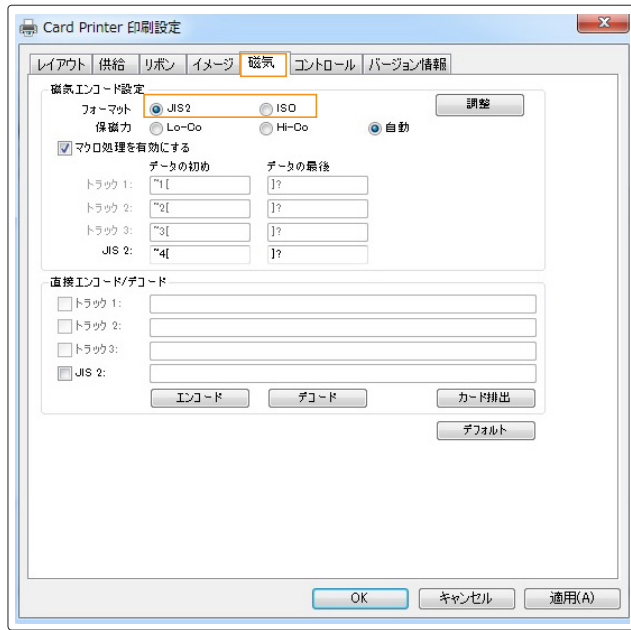

⑥ Control

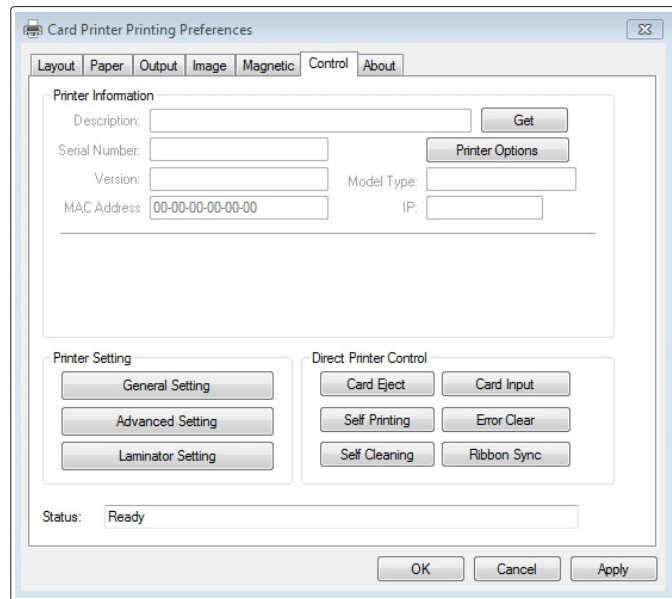

Item		Description
Printer Information	Get	Retrieves and displays the information from the printer.
Printer Setting	General Setting	Retrieves/changes the printer settings. - Auto Ribbon Sync: No, Yes - Card Ready Position: Eject, Internal - Card Input Ready: External, Internal - Card Input Option: External, Internal - Card Eject Time: 0 - 30 seconds - Card Eject Option - Card Insert Time: 2 - 20 seconds - LCD Contrast - LCD Backlight Mode
	Advanced Setting	Retrieves/changes the printer settings. -TPH Resistance: 2400 ~ 3600 - Card Margin Setting: X-Start, X-End, Y-Offset - Intensity: Color/Mono Ribbon - Ribbon Sensor Value Get/Set
	Laminator Setting	-Laminator F/W version -Film Type -Film Remaining Counts -Pass Mode -Temperature -Start Position -Power Saving Time
Direct Printer Control	Card Eject	Ejects the card inside the printer.
	Card Input	Inserts the card placed in the slot.
	Self Printing	Prints a self-test card.
	Self Cleaning	Initializes the cleaning cycle. Make sure that the cleaning card is available.
	Ribbon Sync	Synchronizes the ribbon. It performs the same function as the "RIBBON SET" button.
	Error Clear	Removes the error status of the printer. This does not solve any errors, but only removes the status so it can process the next command.

(1) Get the information of the installed modules.

“Control” tab → “Get button” at the printer information

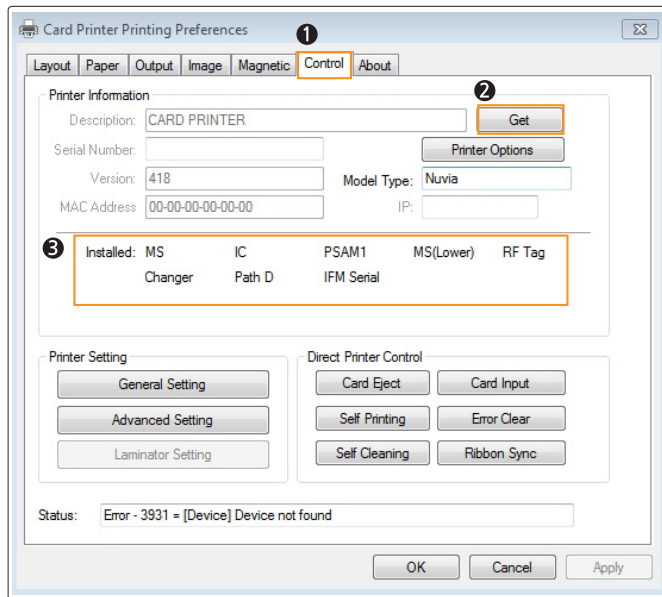

Displayed	Installed Module	Descriptions
MS	MS module	Magnetic stripe encoding /decoding option
IC	Contact Smart Card option	IC contact module
Hopper A	Upper Hopper	
Hopper B	Lower Hopper	
IFM Serial	IC Card Interface Module	Serial protocol IC Card interface module installed
IFM PCSC	IC Card Interface Module	PC/SC compliant IC Card interface module is installed

Displayed	Installed Module	Descriptions
Flipper		Enable to print the dual side
Divert		Enable to eject the card both a input section and output hopper.
Path D	Not reserved	
Laminator	Laminator module	
Mobile SIM	Mobile SIM slot	Mobile SIM contact module.
WIFI	WIFI module	Enable to use wireless network.

(2) Configure Laminator

Go to the printer properties → “Control” tab → “Laminator setting” button.

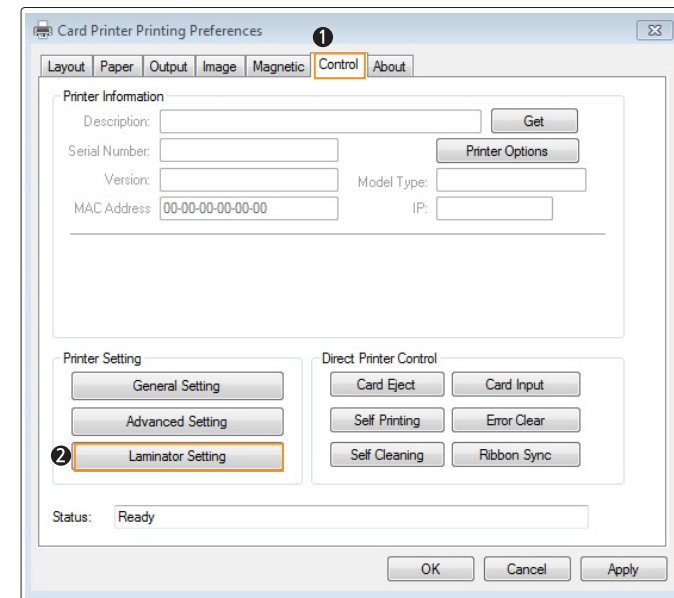

Laminator information Dialog.

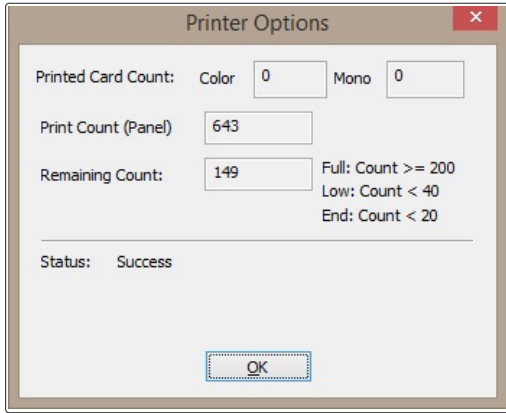
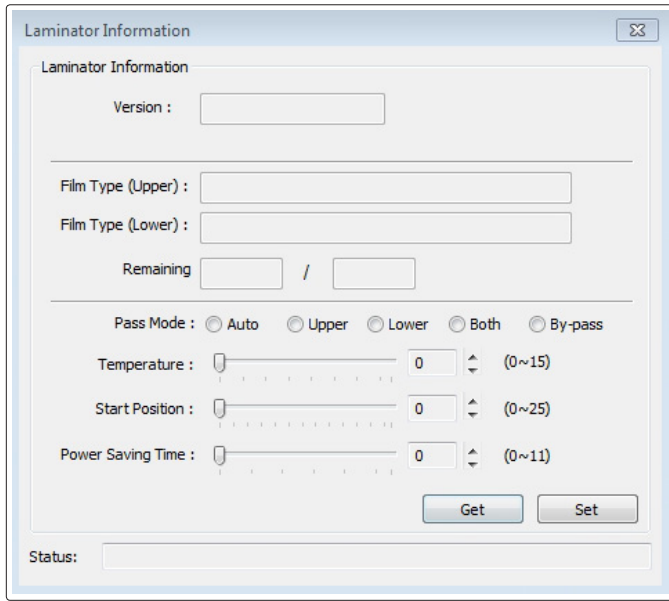

	Item	Description
Printer Option	Printed Card Count	It shows how many cards are printed on the connected
	Print Count (Panel)	It shows how many panles are printed in the connected
	Remaining count	It shows the level of remaing capacity of the installed ribbon.

Item	Description	
Version	Display the version of the Laminator's F/W	
Mode	Printer → Laminator	The Laminator is connected to the Nuvia.
	PC → Laminator	The Laminator is connected with the PC directly. Standalone type.
Film Type (Upper)	Display the installed film type at the upper cassette.	
Film Type (Lower)	Display the installed film type at the lower cassette.	
Remaining	Get the remaining counts of the loaded film.	
Pass Mode	How to operate the laminator.	
Temperature	Set the laminating temperature.	
Start Position	Set the start position of laminating.	
Power Saving Time	Set the duration of power saving mode.	

⑦ About

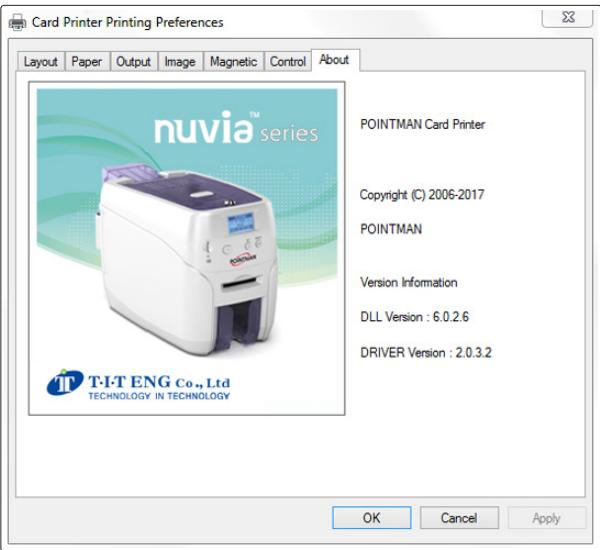

This tab displays the version information.

Check IP Address & Print Test Card

-Check IP Address

1. Hold down both the "EJECT" and "RIBBON SET" buttons until "USER MODE" is indicated in the LCD display.

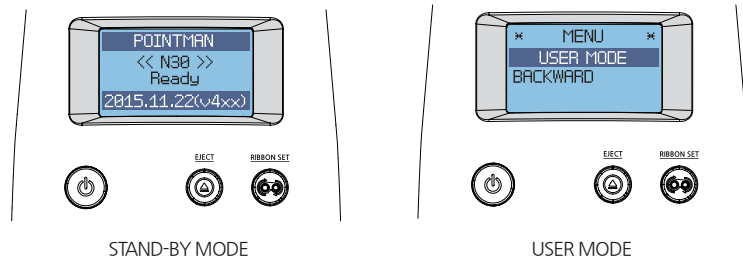

2. When "USER MODE" is indicated on the LCD display, press the "RIBBON SET" button to go into "3. SET MODE". Then, hold down the "RIBBON SET" button.

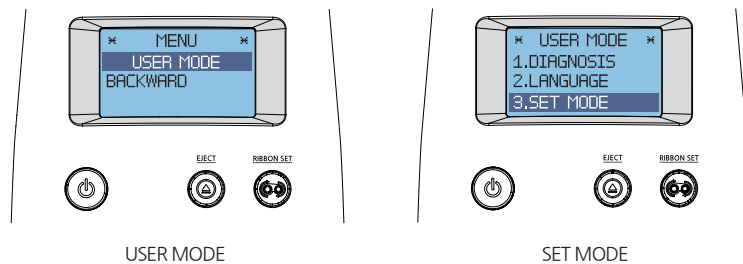

Check

Go up the menu: Press the "EJECT" button.
Go down the menu: Press the "RIBBON SET" button.

3. When "SET MODE" is indicated in the LCD display, press the "RIBBON SET" button several times to go to "4. NETWORK CONFIG". Then, hold down the "RIBBON SET" button until the IP address displays on the screen.

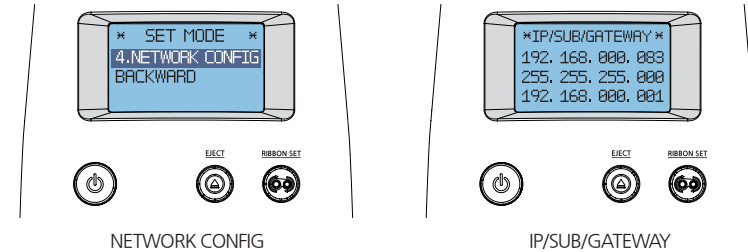

4. To go into STAND-BY mode, hold down both the "EJECT" button and "RIBBON SET" button together to go to the previous menu ("4. NETWORK CONFIG"). Then, hold down the "EJECT" button to enter STAND-BY mode.

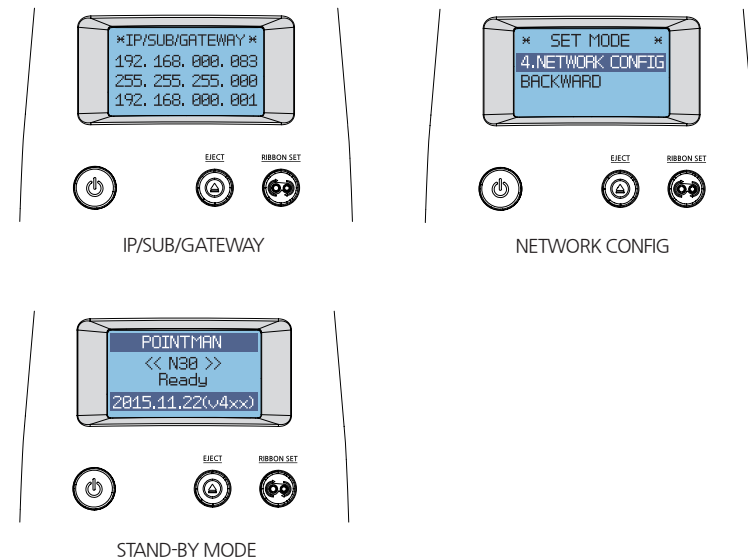

-Print Self-Test Card

① If Connected to a PC

1. Turn on the printer connected to a PC.
2. Load the ribbon and press the "RIBBON SET" button.
3. Insert a single card into the slot or load it on the Input Hopper.
4. Go to "Hardware and Sound → Devices and Printers" in the "Control Panel".
5. Select "Card Printer" and Right click → Printing preferences → Control tab → Direct Printer Control → Self Printing.

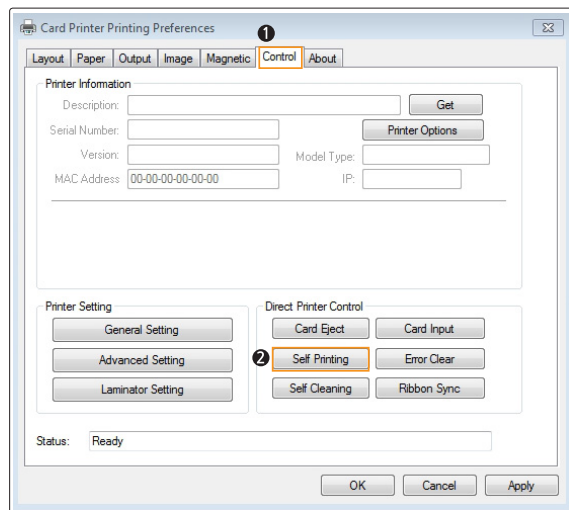

6. "Self Printing" is indicated on the LCD display as a test card is printed so that you can check the printing quality.

② If Not Connected to a PC: User Mode

1. Turn on the printer (there is no need to connect it to a PC).
2. Insert a single card into the slot or load it on the Input Hopper and load the ribbon.
3. Hold down both the "EJECT" and "RIBBON SET" buttons until "USER MODE" is indicated on the LCD display.

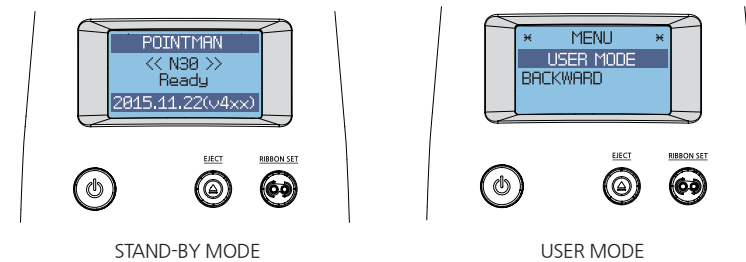

4. Hold down the "RIBBON SET" button in the USER MODE, and go into the "1. DIAGNOSIS" menu.

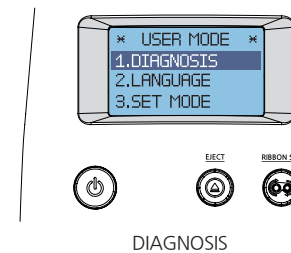

5. Hold down the "RIBBON SET" button in the "DIAGNOSIS → 1. SELF PRINT" menu to start printing a test card.

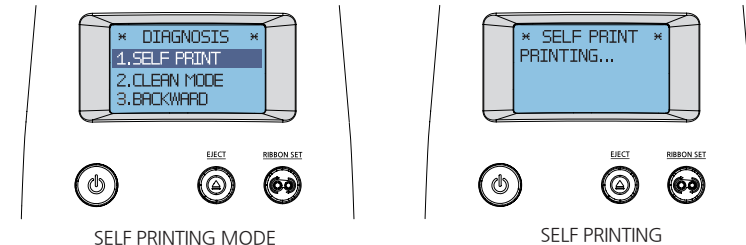

6. The printing progress is indicated on the LCD display. The card will be ejected when the printing is completed.

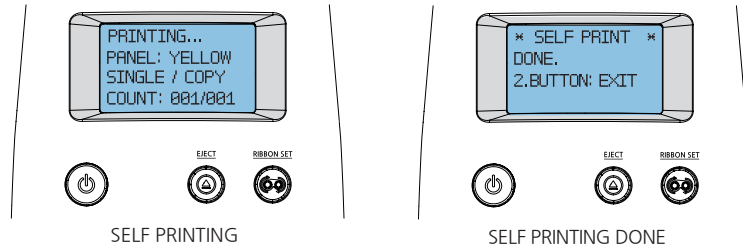

7. When the "SELF PRINTING DONE" message displays, hold down both the "EJECT" and "RIBBON SET" buttons to go back to the "DIAGNOSIS-SELF PRINT MODE" mode. To go into STAND-BY mode, hold down the "EJECT" button.

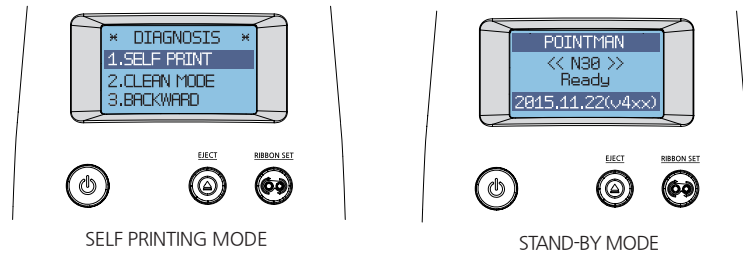

Maintenance Instructions

-Supported Cards

This card printer may not support certain types of PVC cards. Please use the following PVC cards to prevent any issues and achieve the highest printing quality.

① Size

- International Standard (ISO CR80-ISO7810)
- 53.98mm (W) x 85.60mm (L)/3.375"x2.215"

② Thickness

- Minimum: 0.4mm
- Standard: 0.76mm
- Maximum: 1.2mm

③ Acceptable Cards

- Glossy white
- Free of dirt or grease
- Not contaminated
- Free of scratches or dents
- Completely flat
- Static Free

④ Unacceptable Cards

- Heavily damaged
- Stained or contaminated
- Scratched
- Bent or deformed
- Embossed



Caution

Do not load or use cards considered as unacceptable as they may damage the parts including the head, sensor, TPH, and roller.

Clean the Printer

-Clean the Exterior

- Clean the printer with a soft, damp cloth. Make sure to unplug the power adapter before cleaning it.
- Do not allow any liquid to drip inside the printer.
- Make sure that the printer is dry before turning it on.



Caution

Do not use any liquid / gel containing a high content of alcohol or solvent to clean the printer as it may cause discoloration or fissure on its surface.

-Clean Inside the Printer Using Cleaning Kit

Clean inside the printer using the cleaning kit every month or every 1000 cards

Make sure to follow the instructions provided below on a regular basis as dusts or contaminants may affect the printing quality or damage the parts.

① Cleaning Kit & Use



1) CR80 Cleaning Card:

Use for cleaning the printer path, roller, and feeding roller.



2) Long-T Cleaning Card:

Use for cleaning the printer path, roller, and feeding roller.



3) Alcohol Swab:

Use for cleaning the interior case and sensor.



4) Cleaning Pen:

Use for cleaning the TPH and sensor.

② Clean the Printer Using CR80 Cleaning Card / Long-T Cleaning Card



Caution

CR80 Cleaning Card : insert the card to the Single Card Slot.

T Cleaning Card : remove the Input Hopper and insert the card through the tray.

Using the cards in any other way may cause an error.

1) Check the Proper Use of CR80 Cleaning Card / T Cleaning Card

CR80 Cleaning Card

N10/N20/N30

Insert the CR80 Cleaning Card to Single Card Slot as shown in the picture

N15

Insert the CR80 Cleaning Card to the card tray as shown in the picture

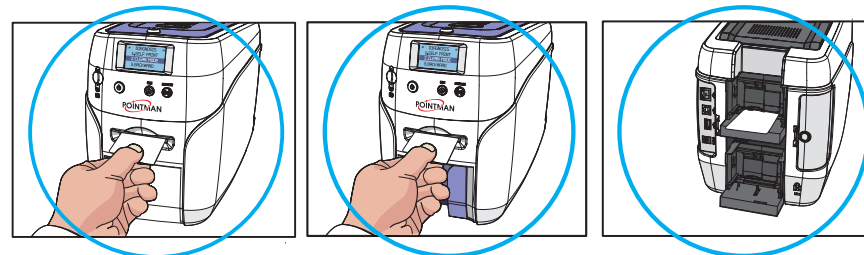

Caution

How to clean N15 Card printer with CR80 Cleaning card.

Long-T Cleaning Card

N10/N20/N30

Once you insert the T-Cleaning card to the manual feeding card slot, it will clean the printer automatically. Not require any additional setting.

N15

Can't use Long T-Cleaning Card on N15 model

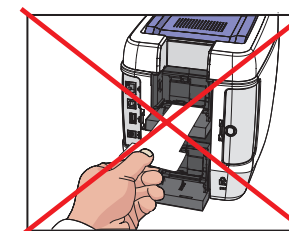
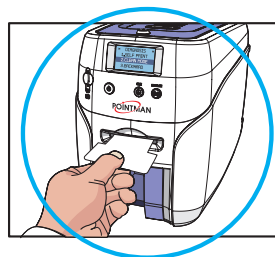

2) Not Connected to a PC: User Mode

1. Open the TOP Cover and remove the ribbon, close the cover.
2. Press the "EJECT" button located in front of the printer to eject any card inside the Single Card Slot. For the cards in the Input Hopper, open the cover to remove them.
3. Insert the cleaning card to the feeding slot (Single Card Slot, Input Hopper).
4. Hold down both the "EJECT" and "RIBBON SET" buttons together until the LCD display indicates that the printer is in "USER MODE".

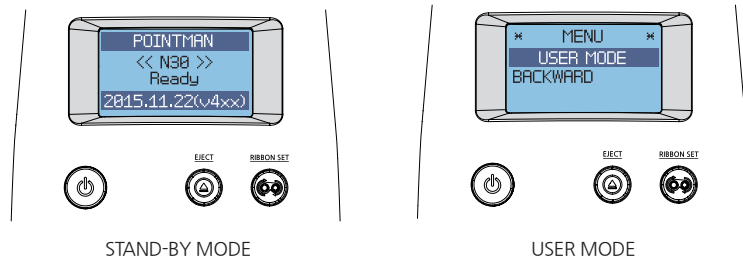

5. Hold down the "RIBBON SET" button in the "USER MODE" to go into "1. DIAGNOSIS".

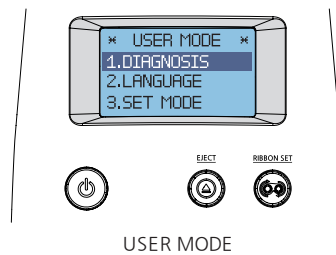

6. When the LCD display indicates "1. DIAGNOSIS", press the "RIBBON SET" button to go into "2. CLEAN MODE".

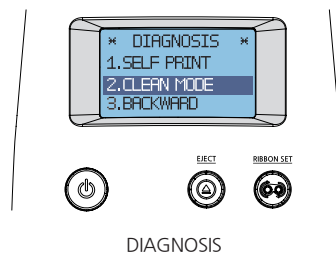

7. Hold down the "RIBBON SET" button until cleaning starts. The cleaning card will be ejected after it moves back and forth 10 times.

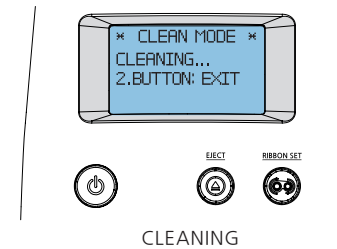

8. When the LCD display indicates "CLEAN COMPLETE", remove the cleaning card. Then, press both the "EJECT" and "RIBBON SET" buttons to go back to the "DIAGNOSIS" menu.

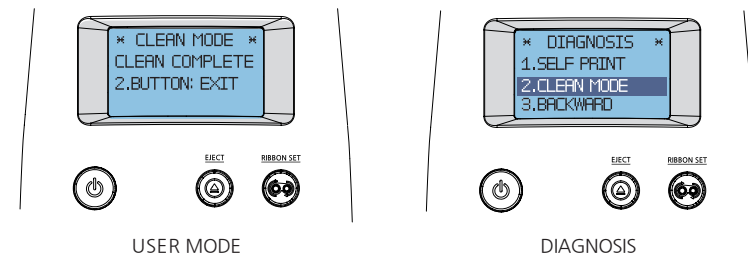

Caution

Do not use the printer for 2-3 minutes until the alcohol solution is fully dried.

9. Hold down the "EJECT" button to go into Stand-by Mode.

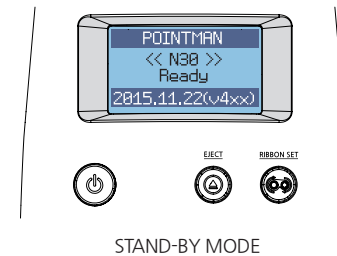

3) Connected to a PC

1. Turn off the printer and open cover, remove ribbon and all cards and close the cover. And turn it on.
2. Go to "Control Panel → Hardware and Sound → Devices and Printers" and right-click the "Card Printer" driver icon. Then, select "Printing preferences".
3. Go to "Card Printer Printing preferences → Control" and click "Self-Cleaning".

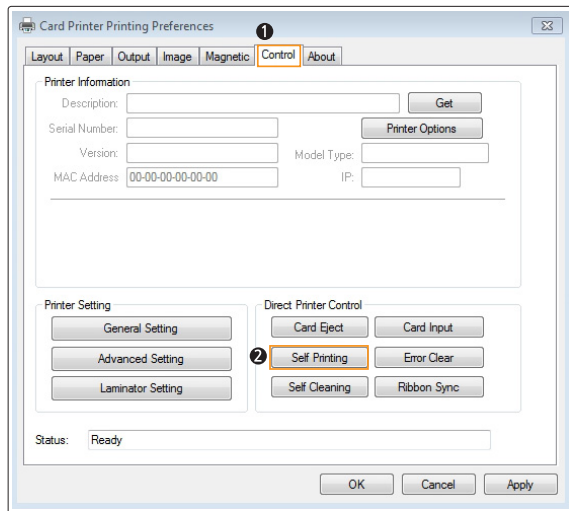

4. Insert a cleaning card when prompted by the "Insert a cleaning card" message, and then click "Yes".

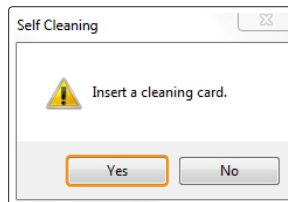

5. The cleaning card will be ejected after it moves back and forth 10 times.
6. Do not use the printer for 2-3 minutes until the alcohol solution is fully dried.

③ Clean the Printer Using Alcohol Swab and Cleaning Pen

You can clean the printer's TPH and sensor and wipe the ink and dusts using an alcohol swab and cleaning pen.



Caution

Do not use any liquid / gel containing a high content of alcohol or solvent to clean the printer as it may cause discoloration or fissure on its surface. Make sure to use authorized alcohol swabs and cleaning pen only.

1) Clean the Inside of the Printer Using Alcohol Swab

1. Open the Top Cover and remove the ribbon. Press the "EJECT" button located in front of the printer to eject any card inside the printer. .
2. Turn off the printer connected to a PC, and unplug the power adapter.
3. Take out an alcohol swab from the Cleaning Kit and fold it at the end as shown in the picture.

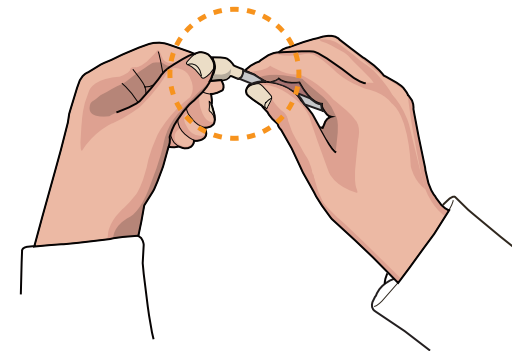

4. Squeeze the transparent part until liquid comes out. Then, clean places in the printer where you cannot reach with your hands.



Caution

Do not use the printer for 2-3 minutes until the alcohol solution is fully dried.

2) Clean the Printer's TPH Using Cleaning Pen and Alcohol Swab

It is recommended to clean the printer at least once a month or whenever you replace the ribbon.

1. Turn off the printer connected to a PC and unplug the power adapter.
2. Clean the main body of the TPH using the cleaning pen or cotton swab before cleaning its head.
3. Make sure to clean the ceramic edge of the printhead, as shown in the picture.



Caution

Do not touch the TPH head with your hands as this can damage it.

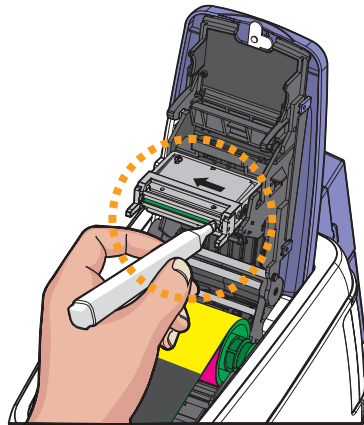

4. Make sure that the TPH is fully dried before turning the printer on; otherwise, the TPH may get damaged.



Important The Cleaning Pen is only included in the Advanced set sold by Pointman.

-Clean the Blue Cleaning Roller

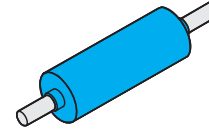

Blue Cleaning Roller

This cleaning tool is designed to remove any unwanted materials from the surface of cards, and it can be used semi-permanently since it can be washed. It is recommended to clean it at least once every two weeks or every 200 cards.

1. Remove the cleaning roller from the printer.
2. Wash it under running water.
3. Make sure that it is fully dried before installing it into the printer.

Troubleshooting

Some of the problems you may encounter while using the printer can be fixed by referring to the following troubleshooting guide. If the problem persists, then please contact your local dealer.

-Errors

① TPH

Code	Code Name	Description	Solution
10	Top Cover (TPH Module)	The Cover opens while printing	Check that the cover is closed properly. Replace the TPH open checking sensor.
11	TPH Up/Down Failure	The TPH up/down movement fails or is interrupted.	Check the TPH up/down module.
13	Abnormal TPH Thermistor Temperature	The TPH thermistor Temperature is abnormal.	Check the temperature of the TPH thermistor (operating temp.: 0c°~70c°). Replace the TPH.

1) Replace the TPH

1. Detach the earth cable on TPH as shown in the below pictures.

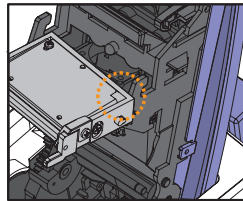
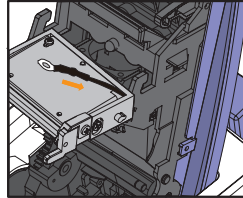
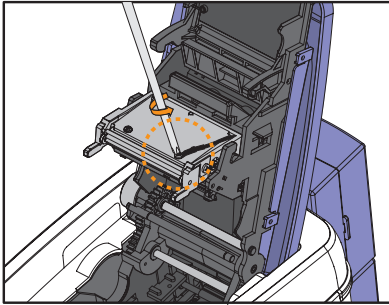

2. While pressing down the black bar above printhead, push the TPH by its body upwards and forwards. Taking care not to touch the ceramic edge of the printhead.

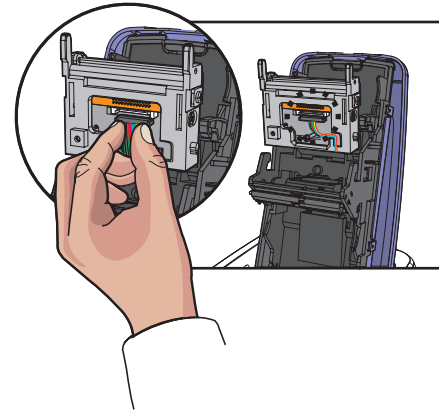
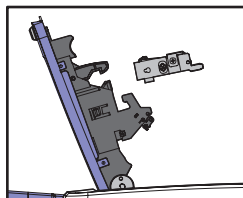
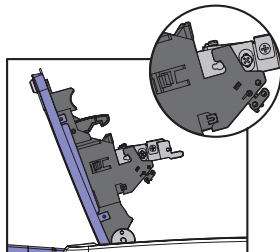
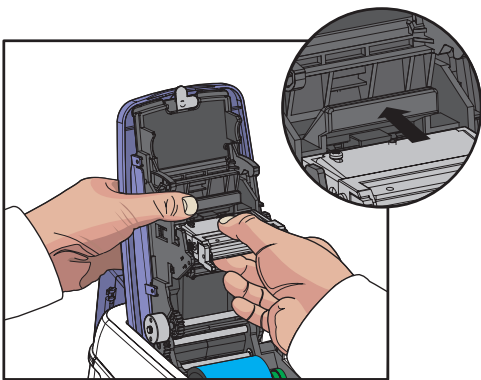

3. Remove the TPH's connector by lifting it.

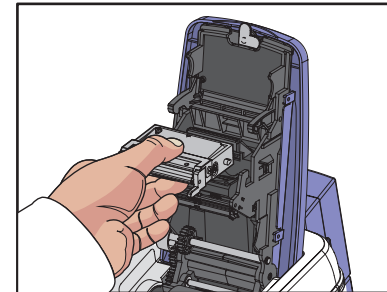

4. Pull it towards you to remove, and then replace it with a new one. (Install the TPH in reverse order of the removal steps.)

② Card Feeding

Code	Code Name	Description	Solution
12	Card Jammed	The card is jammed in the path.	Check the path to see if the card is jammed.

1) Remove Jammed Card (Single-sided Printing)

1. Open the side cover by holding the area highlighted by the circle and pushing it towards the front of the printer as shown in the picture.

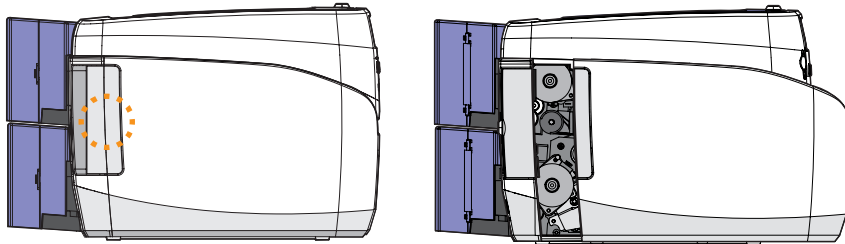

2. Rotate the knob to remove any jammed card the path as shown in the picture.

This method can only be used for single-sided printing models (without the flipper only).

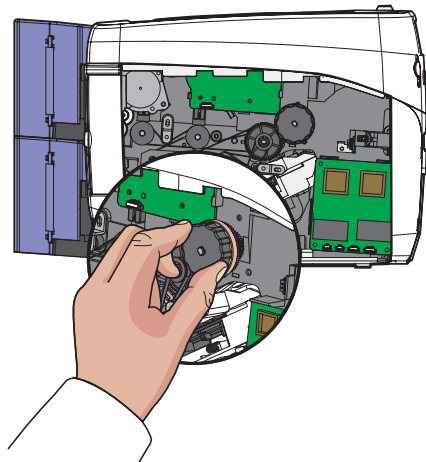

2) Remove Jammed Card (Double-sided Printing)

1. Turn off the printer and open the cover. Remove the ribbon inside.

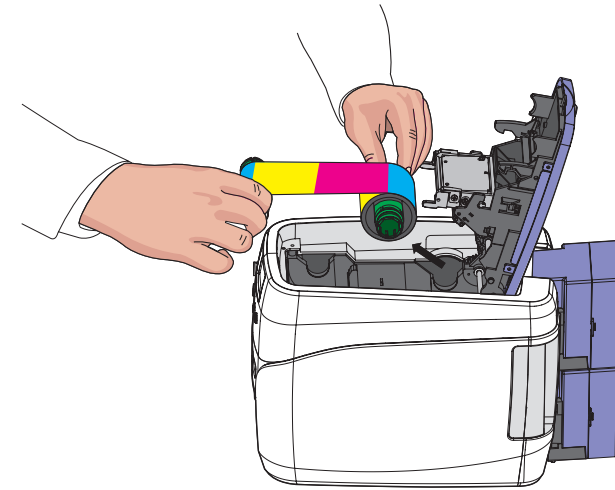

2. Keep the cover open and remove the output card hopper (stacker).
(For NUVIA N10, remove the front cover deco)

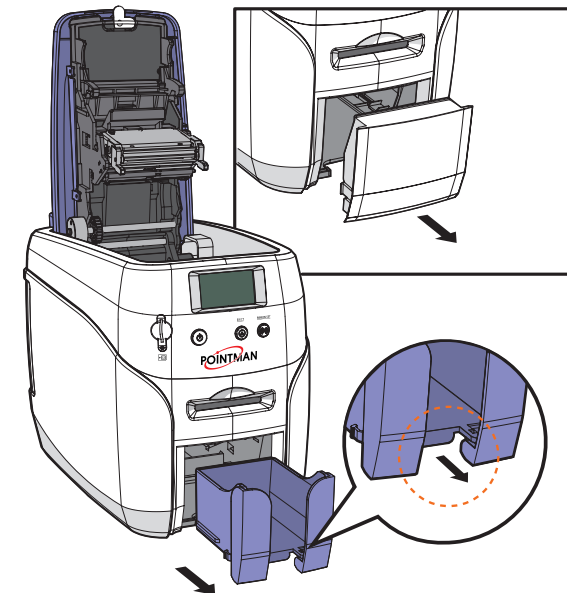

3. Push the card to the front of the printer and then press the card to down. Tilt the card 70~90 degree down in order to eject the card easily.

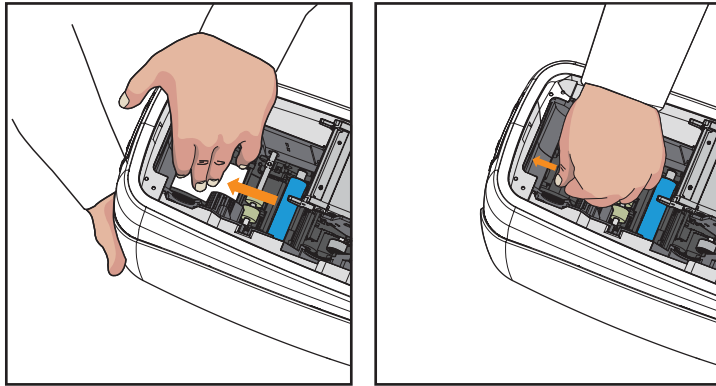

Caution

When the flipper is rotating, a card can be moved back and forth. Hold a card tightly in order to prevent any movement of a card.

4. Pull out the card inside manually as shown in the below pictures.

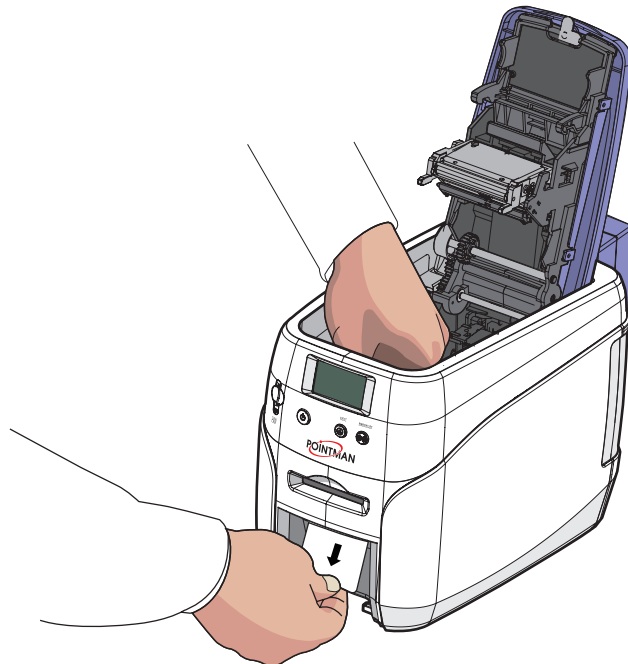

③ Ribbon

Code	Code Name	Description	Solution
14	Ribbon Encoder Error	Disconnected ribbon, Ribbon end or encoder error occurs.	Check the Ribbon and Ribbon encoder status.

④ Card

Code	Code Name	Description	Solution
17	IC Module Up/Down Error	IC Content module position error occurs.	Repair service is required.
50	[Changer] Module Response Timeout	Flipper communication error occurs.	Turn off → Remove any cards → Reboot
51	[Changer] Module Transmission Timeout	Flipper communication error occurs	Turn off → Remove any cards → Reboot
52	[Changer] Home Position Failure	An error occurs at the Flipper home position.	Turn off → Remove any cards → Reboot
53	[Changer] Card Flipper Failure	An error occurs at the Flipper turn up.	Turn off → Remove any cards → Reboot
54	[Changer] Card Input Timeout	The printer stops when the card is entering the Flipper.	Turn off → Remove any cards → Reboot
55	[Changer] Card Input Jam	The card fails to enter the Flipper on time.	Turn off → Remove any cards → Reboot
56	[Changer] Card Output Jam	A card is jammed in the Flipper.	Turn off → Remove any cards → Reboot
57	[Changer] Card Exist	An abnormal card is found in the Flipper.	Turn off → Remove any cards → Reboot
58	[Changer] Position unknown error	Position error	Turn off → Remove any cards → Reboot

⑤ Miscellaneous

Code	Code Name	Description	Solution
15	Media Error	The media error occurs.	Check the card (media) and path sensor status.
16	EEPROM Error	An EEPROM read/write error occurs.	Reboot or replace the EEPROM.

-Warning

① Card

Code	Code Name	Description	Solution
23	[IC] Contact Error	IC fails to make contact.	Check the IC contact module.
24	[MS] Encoder Error	An MS encoding error occurs.	Check the MS module.
25	[MS] Read Error	Fail to read mag. stripe track.	Check the MS module.
26	[MS] Read STX Error	No STX is found in the MS reading.	Check the MS feeding.
27	[MS] Read Parity Error	A parity error occurs in the MS reading.	Check the MS feeding
28	[MS] Read ETX Error	No ETX is found in the MS reading.	Check the MS feeding.
29	[MS] Read LRC Error	LRC is inconsistent in the MS reading.	Check the MS feeding and replace the MS card.
30	IC Module Response Timeout	IC module communication fails.	Check the IFM B/D.
31	RF Module Response Timeout	RF module communication fails.	Check the IFM B/D.
33	Card Eject Error	Flipper module communication fails.	Check the Flipper and Flipper B/D.
34	Card Input Timeout	The card input is interrupted.	Check the Input Hopper and for any jammed cards.
182	Adjust Error	Ribbon adjust error	Check sensor and get correct sensor value.

② Ribbon

Code	Code Name	Description	Solution
35	Ribbon Near to End	The ribbon life is reduced to 10% or less.	Prepare to replace the ribbon.
36	Ribbon End	The ribbon is fully consumed.	Replace the ribbon with a new one.
38	RF Tag Ribbon Error	The ribbon is not installed properly.	Check the ribbon and tag authentication.

③ Miscellaneous

Code	Code Name	Description	Solution
20	Command Error	The command is not compliant with the specifications.	Send compliant command.
21	Parameter Error	The parameter is not valid.	Send the parameter command.
22	Main Communication Part Timeout	The command is not sent on time.	Send the command.



One of the following steps must be taken to recover the printer from the error state:

- 1) Press the "RIBBON SET" button with the ribbon installed.
- 2) Press the "EJECT" button.
- 3) Turn off and on the power.

Caution

-Additional Errors

Errors	Solution
The ribbon is frequently cut at the top of the card.	- Check the X-coordinate in the printer driver. - The recommended starting value for the X - coordinate is 9~10 + 1~2
The printer is unable to find the Card Designer or other programs.	- Make sure that the printer driver is installed correctly. - Check the connections of communication cables. - Reboot the PC.

Ribbon Specifications

-Color Ribbons

Ribbon Type	Specifications	TP-9X00 Series	NX0 Series
YMCKO	200 Prints/Roll	○	○
1/2YMCKO	400 Prints/Roll	○	○
YMCKO-K	167 Prints/Roll	○	○
YMCKO	250 Prints/Roll	○	○

-Monochrome Ribbons

Ribbon Type	Specifications	TP-9X00 Series	NX0 Series
Blue	1000 Prints/Roll	○	○
Black	1000 Prints/Roll	○	○
Red	1000 Prints/Roll	○	○
Green	1000 Prints/Roll	○	○
White	1000 Prints/Roll	○	○
Metallic gold	1000 Prints/Roll	○	○
Metallic silver	1000 Prints/Roll	○	○
KO(black overlay)	500 Prints/Roll	○	○
Black	1500 Prints/Roll	X	○

Printer Specifications

-Product Features

2 Input Hoppers

- Load up to 200 cards with an optional Input Hopper.
- Load 2 different types of cards at the same time.
(The card type can be selected before printing.)

Compact & Light

- Only requires a small space.
- Easy to carry (NUVIA series-N20/N30: 4.5kg)

High Level of Security

- The ribbon and card input hopper can be locked optional locks as a physical locking device (high level of security for card printers)

Versatile Usage

- Support PCs, smartphones, tablet PCs, and other mobile devices
(Wi-Fi option is required)

-Standard Specifications

① Printing Type

- Thermal Transfer/Dye-sublimation

② Printing Function

- Single/Double-Sided, Edge-to-Edge Printing

③ Resolution

- 300 dpi (11.8 DPM), 16.7 Million Colors

④ Printing Speed

1) Color Printing

- Single-Sided: 180~200 cards/hr.
- Double-Sided: 100 cards/hr.

2) Monochrome Printing

- 900 cards/hr.

⑤ Card Capacity

- Auto Feed Input: 100 standard format cards (0.76mm)
Up to 200 cards with optional input hopper.
- Output Stacker : 50~60 cards (0.76mm)
- Single Card Printing Input/Output: 1 card

-Optional Accessories

- Optional Input Hopper(increase the capacity from 100 to 200 cards)
- Input Hopper Lock (N20/N30)
- Ribbon Lock
- Wi-Fi

-Printer Specifications

① Dimensions (Width x Length x Height) & Weight

1) N10 (Manual Feed)

- Dimensions: 305.6mm (L) x 184mm (W) x 228mm (H)
- Weight: 3.7kg

2) N15/N20/N30(Auto feed)

- Dimensions: 366mm (L) x 184mm (W) x 228mm (H)
- Weight: 4.5kg

② Power Adapter

- Manufacturer: CHANNEL WELL TECHNOLOGY
- Model No.: KLP-060M-VI
- Input: 100-240V ~ 50/60Hz 1.7A /Output: + 24V 2.5A 60W



Caution

Only use power adapters provided by the manufacturer; otherwise, it may affect the printing quality.

③ Font

- MS Windows Type Fonts

④ Memory

- 128 MB RAM

⑤ Interface

- USB 2.0 (High-Speed), RS-232 (Only Debugging), Built in 10/100 Ethernet

⑥ PC Specifications

- Windows 2000, Windows XP (32/64bit), Windows Vista (32/64bit), Windows 7 (32/64bit), Windows 8 (32/64bit), Windows 10 (32/64bit), Windows 2012 R2 Server, Windows 2008 Server, Windows 2003 Server (32/64bit)

⑦ Software

- Card Designer 2.0

Regulatory

-FCC



FCC IDENTIFIER : XTNNUVIA
Name of Grantee : TIT ENG Co.,Ltd.
Equipment Class : Part 15 Low Power Communication Device Transmitter
Notes : ID Card Printer

FCC Statement

CAUTION: Changes or modifications not expressly approved by the party responsible for compliance could void the user's authority to operate the equipment.

NOTE: This equipment has been tested and found to comply with the limits for a Class B digital device, pursuant to Part 15 of the FCC Rules. These limits are designed to installation. This equipment generates uses and can radiate radio frequency energy and, if not installed and used in accordance with the instructions, may cause harmful interference to radio communications. However, there is no guarantee that interference will not occur in a particular installation. If this equipment does cause harmful interference to radio television reception, which can be determined by turning the equipment off and on, the user is encouraged to try to correct the interference by one or more of the following measures.

- Reorient or relocate the receiving antenna.
- Increase the separation between the equipment and receiver.

-EU

This product is CE marked according to the provision of the R.E.D Directive (2014/53/EU). Here by T.I.T ENG Co., Ltd. Declares that this product is in compliance with the essential requirement and other relevant provisions of Directive 2014/53/EU.



-CCC



-VCCI



-EAC



-RoHS



We hereby guarantee that all products that POINTMAN will deliver directly or through any third party to you, do not contain Pb, Cd, Hg, CR+6, PBB, PBDE to the best of our knowledge, Thereby our products are in accordance with RoHS2 Directive.

- Directive 2002/95/EC
- Directive 2005/717/EC
- Directive 2005/747/EC

-Energy Star



This document is the copyright of T.I.T ENG Co., Ltd. and may not be reproduced in full or in part by any means, electronic or otherwise, without the prior written consent of T.I.T ENG Co., Ltd.

The Company would be very grateful if any accidental inaccuracies could be pointed out to us, as well as any other constructive criticism which might lead to a better understanding.



www.pointman.co.kr

-Main Office : T.I.T ENG Co.,Ltd, (POINTMAN)

7th floor, Shin-do B/D, 215, Jungdae-ro, Songpa-gu, Seoul, Korea (ZIP: 05702)
TEL : +82 2 3431 2370, FAX : +82 2 3431 2371, www.pointman.co.kr
sales@pointman.co.kr

-U. S. A Office : POINTMAN Technologies Inc.

260 Maple Court Suite 277, Ventura, CA 93003,
TEL : +1 844 384 3279, www.pointmanusa.com

-China Office : POINTMAN Trading Co.,Ltd

Room 10G, Building B, Zhongyangdadao, Baoyuan Road 2004,
Xixiang Street, Bao an district, Shenzhen, China (ZIP: 518102)
TEL : +86 755 2397 2483, FAX : +86 755 8275 5963, www.pointmanchina.com