

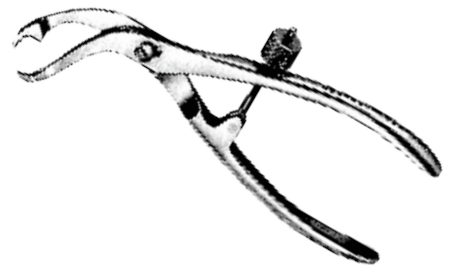

BC
Orthopedic

BC
Orthopedic





Orthopedic
Plaster-of-Paris Knives
Gipsmesser
Chuc hillos



Esmarch
BA300118
18 cm / 7"



Reiner
BA300518
18.5 cm / 7¼"



Hopkins
BA301020
20 cm / 8"



BA301521
21 cm / 8¼"

Orthopedic
Bandage Scissors
Verbandscheren
Tijeras Para Vendajes



For more bandage scissors, also see page 69



Smith
(Mod. USA)
BA302020
20 cm / 8"

Bruns
BA039824 Plain
23.5 cm / 9 1/4"
BA202524T Serrated
24 cm / 9 1/2"
Open shanks with pin

Bruns
BA302524
23.5 cm / 9 1/4"
Closed shanks, serrated

Bruns
BA303024
24 cm / 9 1/2"
Open shanks with pin, serrated



Orthopedic
Bandage Scissors
Verbandscheren
Tijeras para Vendajes

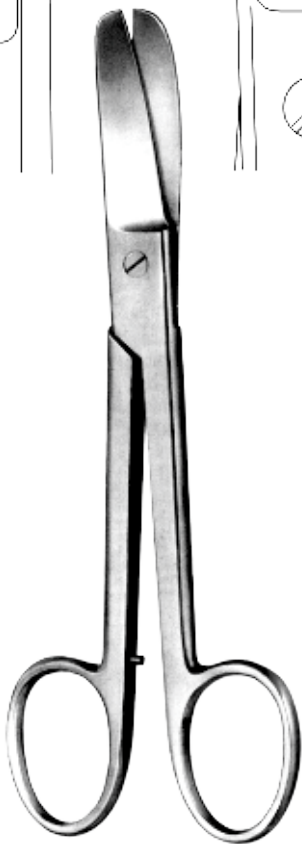
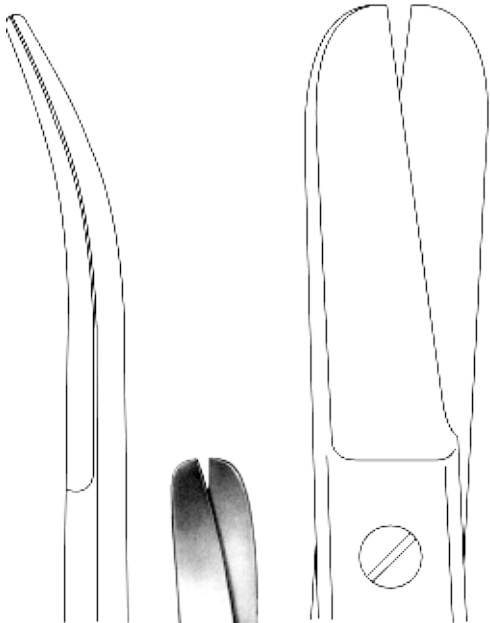

Lorenz
BA303523
23 cm / 9"

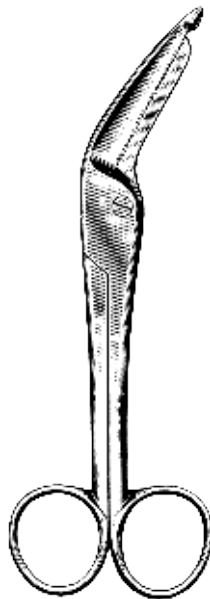
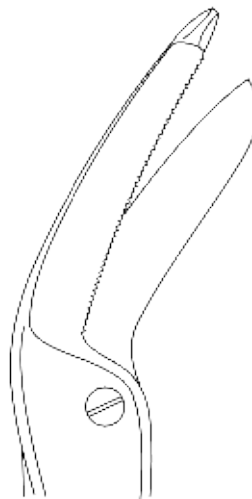

Excentric
BA304016 16 cm / 6¼"
BA304019 19 cm / 7½"

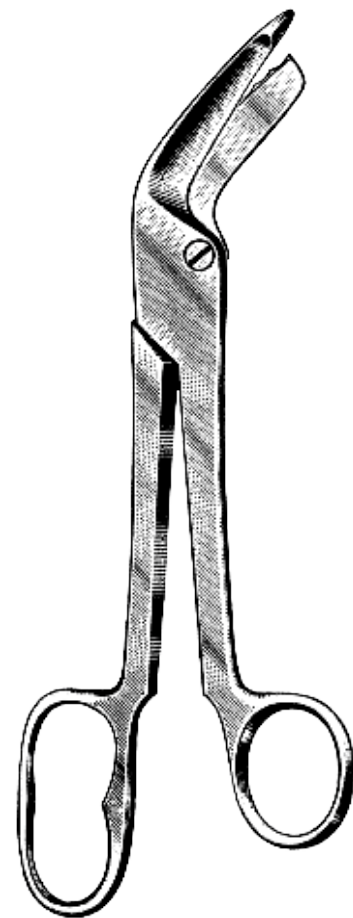
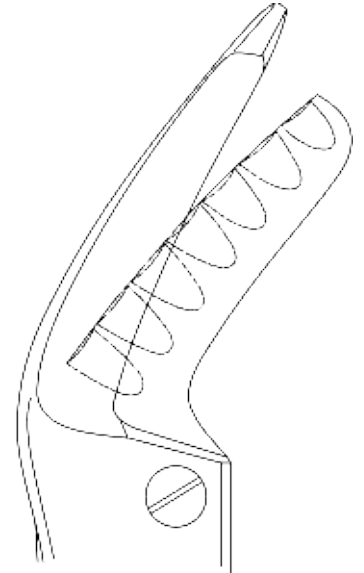

Tornado
BA304524
24 cm / 9½"
Undulated cutting edge

Orthopedic
 Bone Cutting Forceps
 Knochenschneidezangen
 Pinzas Para Cortar Huesos

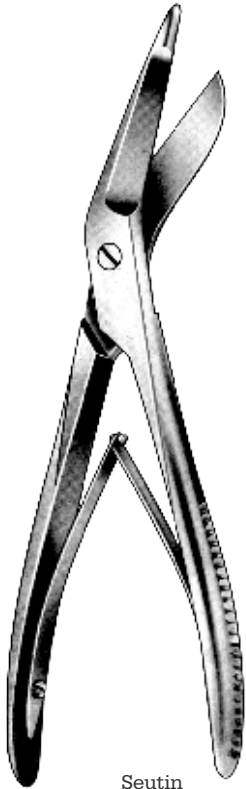

Seutin
 BC300123
 23 cm / 9"

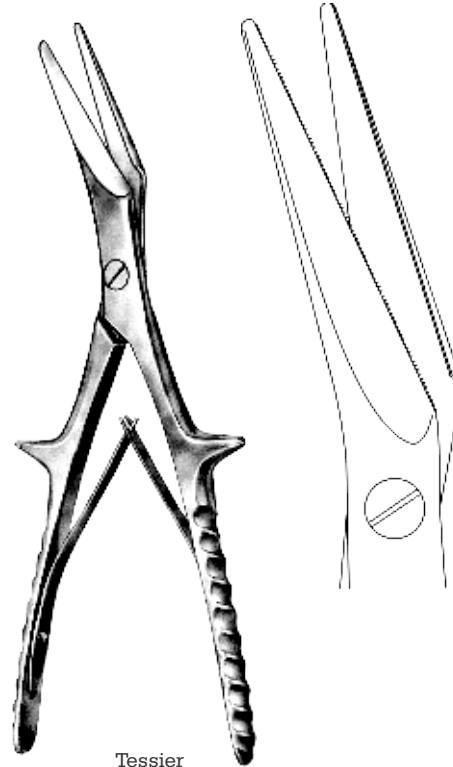

Tessier
 BC300519
 19.5 cm / 7 3/4"
 1 serrated cutting edge

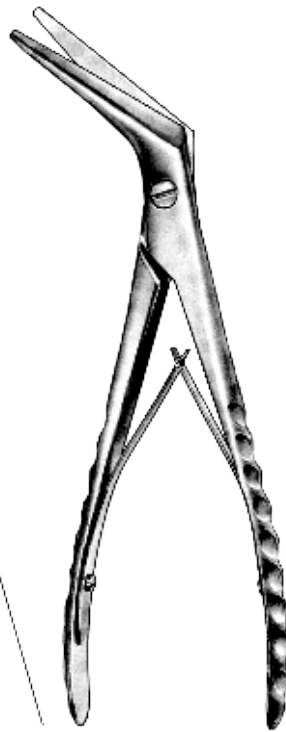
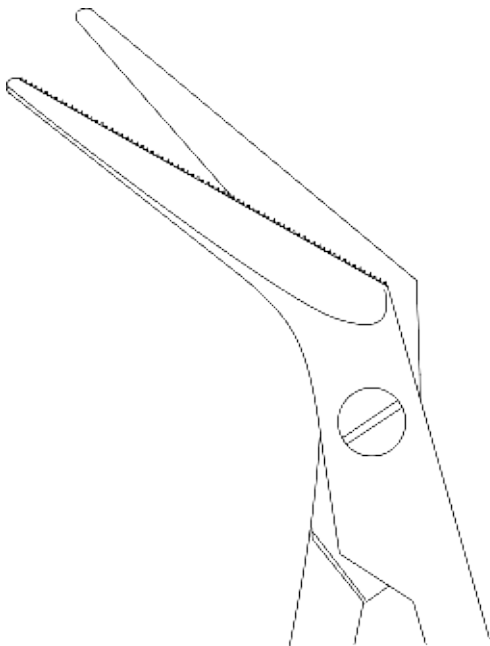

Tessier
 BC301019
 19 cm / 7 1/2"
 1 serrated cutting edge

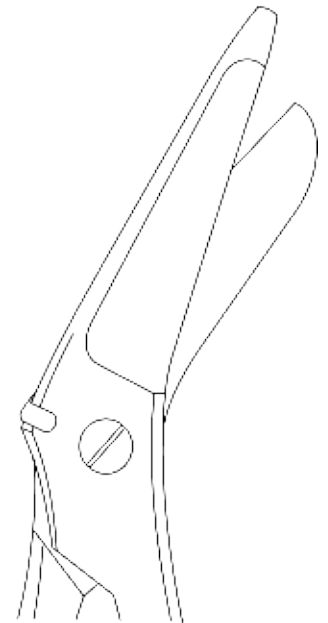

Universal
 BC301520
 20 cm / 8"



Orthopedic
Plaster Cast Spreaders
Gipsspreizer
Separadores para yeso



BC302018
18 cm / 7"

Wolff



BC302024
24 cm / 9½"

Beeson
BC302530
30 cm / 12"

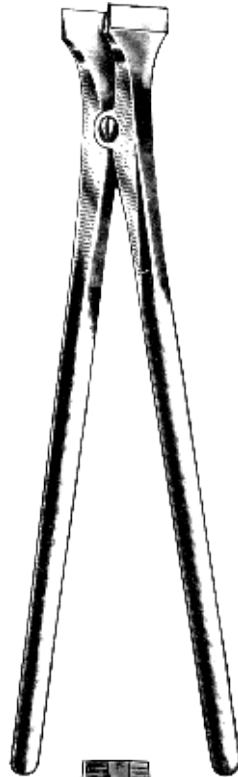

Hennig
BC303028
28 cm / 11"

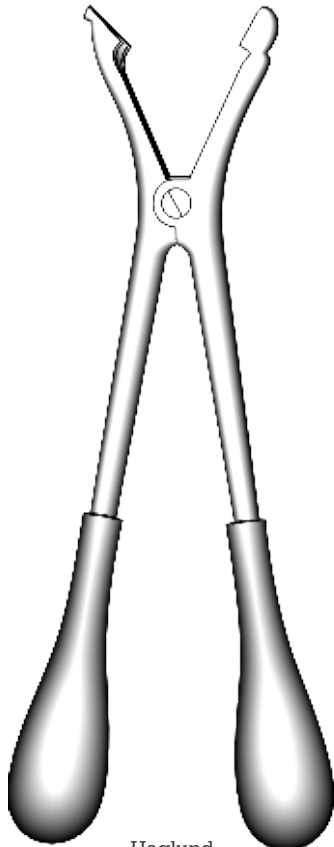
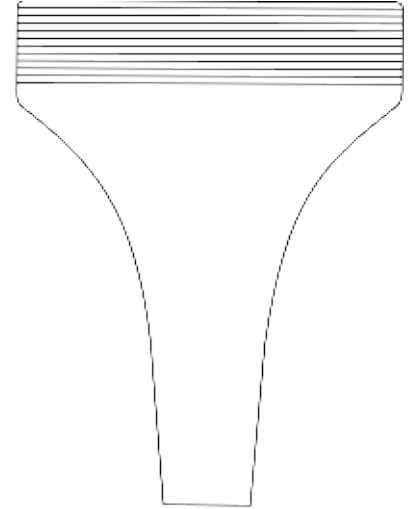

Haglund
BC303528
28 cm / 11"

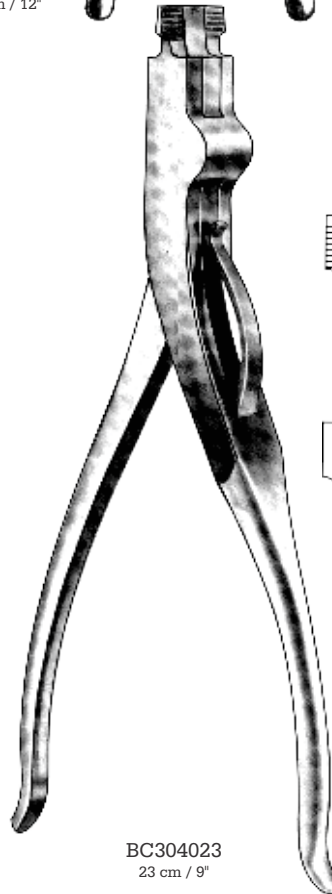

BC304023
23 cm / 9"

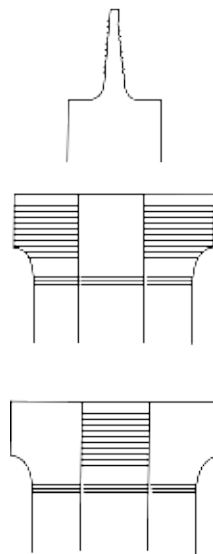

Smith
BC304523
23.5 cm / 9½"

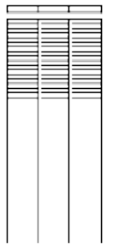

Orthopedic

Plaster of Paris Shears

Gipsscheren

Cizallas para vendajes enyesados

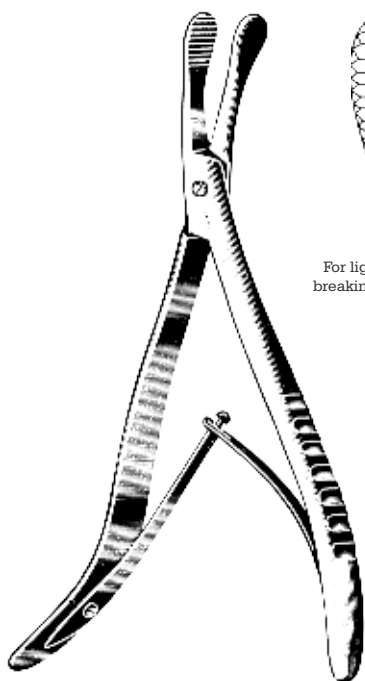

Masson
BC305018
18 cm / 7"
Pediatric cast breaker
deep serrated tips



For lightweight cast
breaking and trimming



Stille
BC305524
24 cm / 9½"



Stille-Mini
BC306020
Blade with reinforced back
BC306120
Blade without reinforced back
20 cm / 8"



Stille

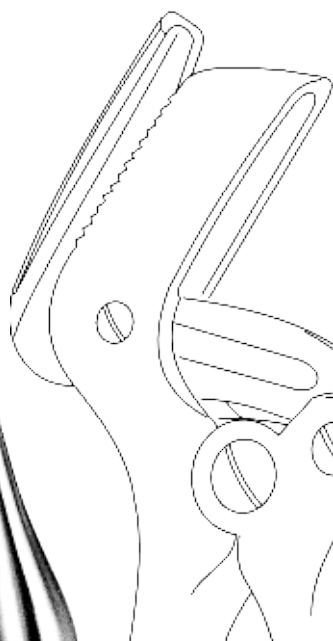

BC306523
Blade with reinforced back
BC306623
Blade without reinforced back
23 cm / 9"

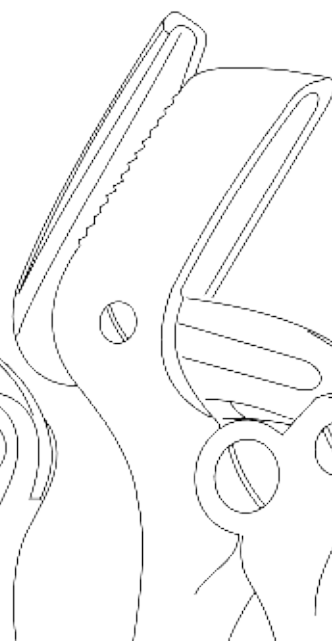

BC306526
Blade with reinforced back
BC306626
Blade without reinforced back
26 cm / 10¼"

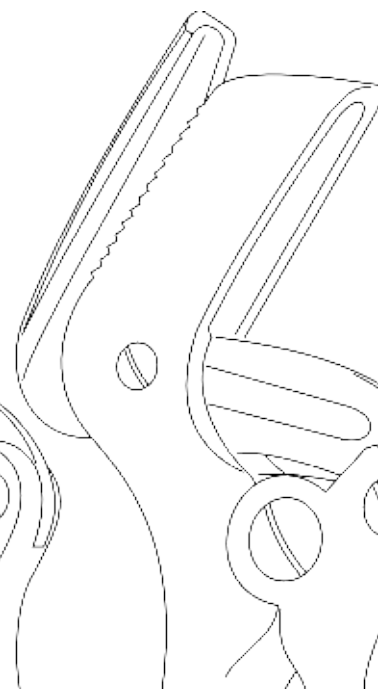

BC306537
Blade with reinforced back
BC306637
Blade without reinforced back
37 cm / 14½"



Orthopedic Mallets Hammer Martillos y Mazos

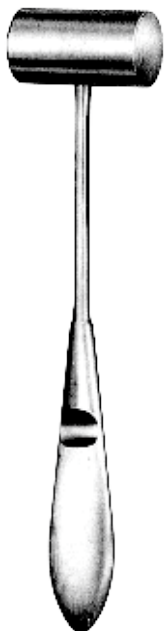

BC031701
16.5 cm / 6½"
140 gm / 5 oz, 20 mm Ø

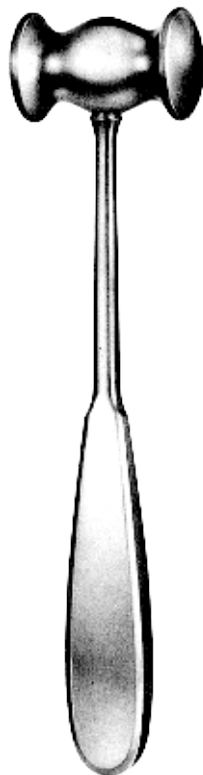

Collin
BC030920
20 cm / 8"
220 gm / 7¾ oz, 30 mm Ø

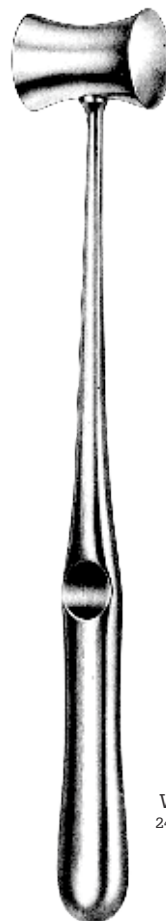

BC030101
26 mm Ø
300 gm / 10½ oz

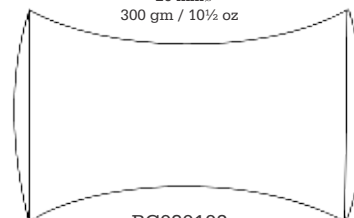
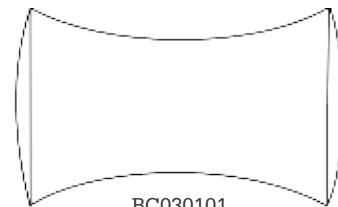

BC030102
28 mm Ø
340 gm / 12 oz

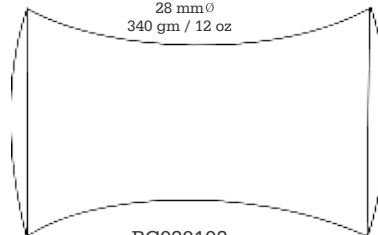

BC030103
30 mm Ø
400 gm / 14 oz

Williger
24 cm / 9½"

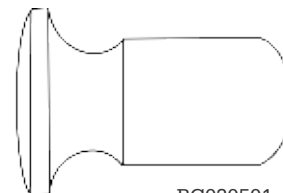

BC030501
25 mm Ø
120 gm / 4½ oz

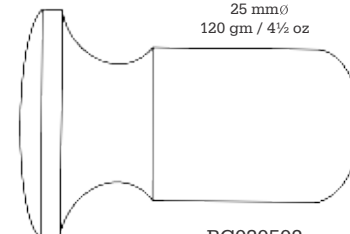

BC030502
30 mm Ø
180 gm / 6½ oz

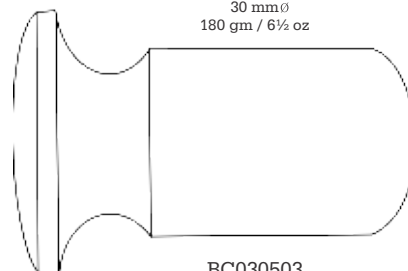

BC030503
35 mm Ø
260 gm / 9 oz

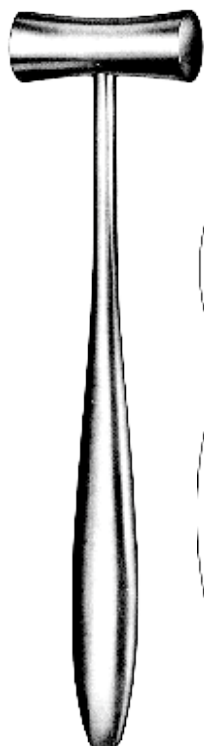

BC031501
19 mm Ø
230 gm / 8 oz

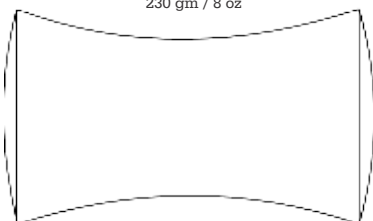

BC031502
25 mm Ø
260 gm / 9 oz

Lucae
19 cm / 7½"



Doyen
21 cm / 8¼"

Orthopedic
Mallets
Hammer
Martillos Y Mazos

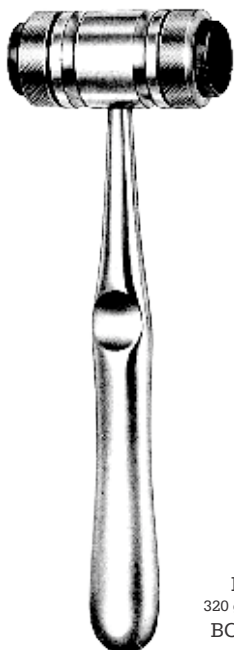

Mead
320 gm, 26 mm ϕ
BC307017
Solid
BC307117
17 cm / 6 $\frac{3}{4}$ "
Ferrozell faces only, pair

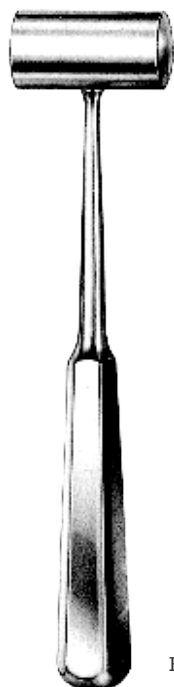

Partsch
22 mm ϕ
BC307518
18 cm / 7"
200 gm
BC307616
16 cm / 6 $\frac{1}{4}$ "
165 gm
BC307718
18 cm / 7"
220 gm

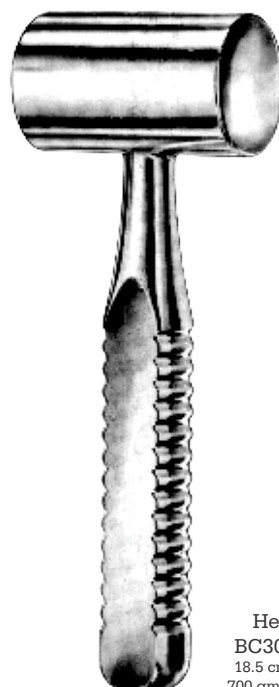

Heath
BC308018
18.5 cm / 7 $\frac{1}{2}$ "
700 gm, 40 mm ϕ
Cooper filled head

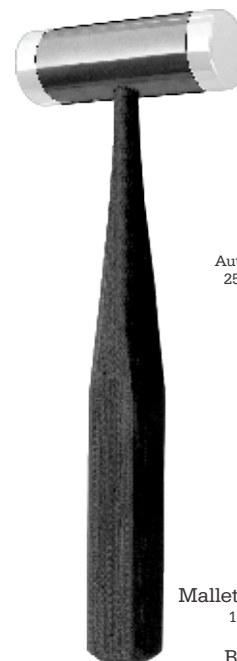

Autoclavable to
250°F (121°C)

Mallet Lightweight
19 cm / 7 $\frac{1}{2}$ "
25 mm ϕ
BC308519
140 gm
BC308619
Two replaceable nylon caps
Total weight: 7 oz.
Head weight: 4 oz



Autoclavable to
250°F (121°C)

Combination Mallet
19 cm / 7 $\frac{1}{2}$ "
BC309019
Total weight: 9 oz
Head weight: 5 oz
26 mm ϕ
BC309119
Total weight: 12 oz
Head weight: 8 oz
38 mm ϕ
One side nylon cap



BC309500
1000 gm
BC309600
700 gm
BC309700
500 gm

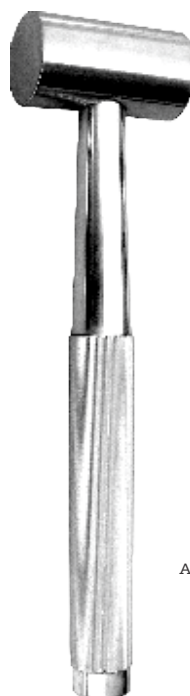

Aluminium handle
BC310000
600 gm, 22 oz
Heavy
BC310100
300 gm, 11 oz



Cottle
BC310519
19 cm / 7 $\frac{1}{2}$ "
240 gm, 30 mm ϕ



Orthopedic Mallets Hammer Martillos Y Mazos



Gerzog
BC311018
18 cm / 7"
250 gm



Kirk
BC311519
19 cm / 7½"
750 gm

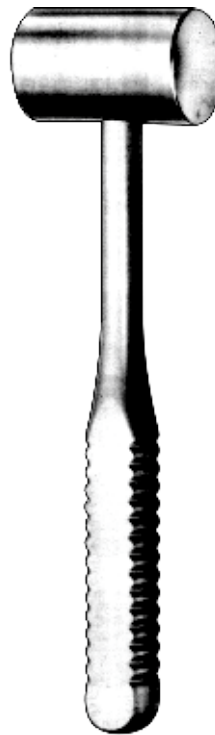

Ombredanne
BC312024
24 cm / 9½"
550 gm, 40 mm Ø



Bergmann
BC312524
24.5 cm / 9¾"
300 gm, 45 mm Ø

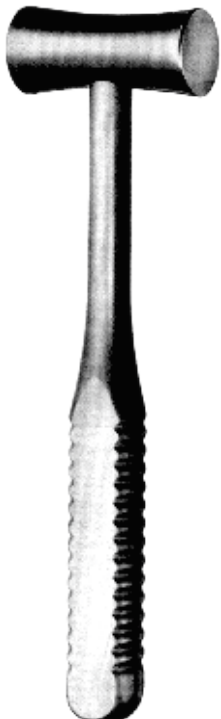

Bergmann
BC313023
23.5 cm / 9¼"
300 gm, 30 mm Ø

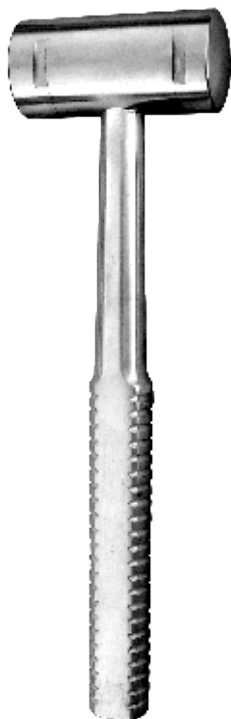

Wagner
BC313523
23.5 cm / 9¼"
35 mm Ø

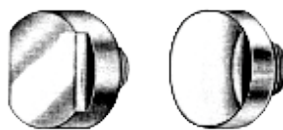

Metal head
BC314000
230 gm, 35 mm Ø

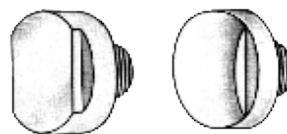

Plastic head
BC314100
32 gm, 35 mm Ø



Quisling
BC314500

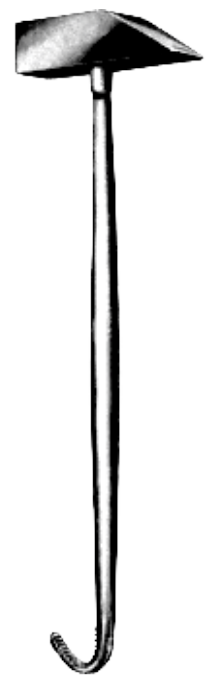

BC315023
23.5 cm / 9¼"

Orthopedic
Mallets
Hammer
Martillos y Mazos



BC315526 450 gm
BC315626 900 gm
26 cm / 10½"



BC316026
26 cm / 10½"
510 gm / 18 oz
30 mm Ø



BC316500
Head weight 550 gm
Total weight 750 gm
40 mm Ø



BC317000
Head weight 350 gm
Total weight 550 gm
35 mm Ø



BC317500
Head weight 300 gm
30 mm Ø



BC318000
Head weight 300 gm
Total weight 500 gm
30 mm Ø



BC318500
Medium size hammer
Full aluminum
Total weight 200 gm



BC319000
Small hammer aluminum handle
with stainless steel head
with rubber side (changeable)
Total weight 125 gm



Orthopedic
Bone Files
knochenfeile
Lima para Huesos



15.5 cm / 6"



BC029902
2 mm \emptyset



BC029903
3 mm \emptyset



BC029904
4 mm \emptyset



BC029905
5 mm \emptyset



BC029906
6 mm \emptyset



BC029908
8 mm \emptyset



BC029910
10 mm \emptyset



Kienny
BC319517
17.5 cm / 7"



Trillat
BC320120 9 x 9 mm
BC320220 9 x 19 mm
20 cm / 8"



Cylindriques Double
BC320516 8 x 15 mm \emptyset
16 cm / 6 1/4"
BC321021 6 x 8 mm \emptyset
BC321121 10 x 12 mm \emptyset
21 cm / 8 1/4"

Orthopedic
Bone Files
Knochenfeile
Lima para Huesos

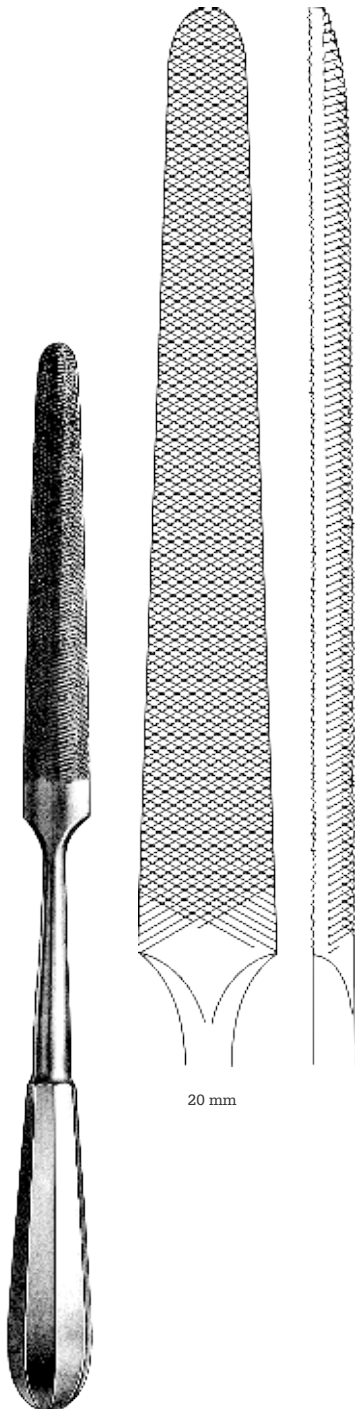

20 mm

BC321528
28 cm / 11"

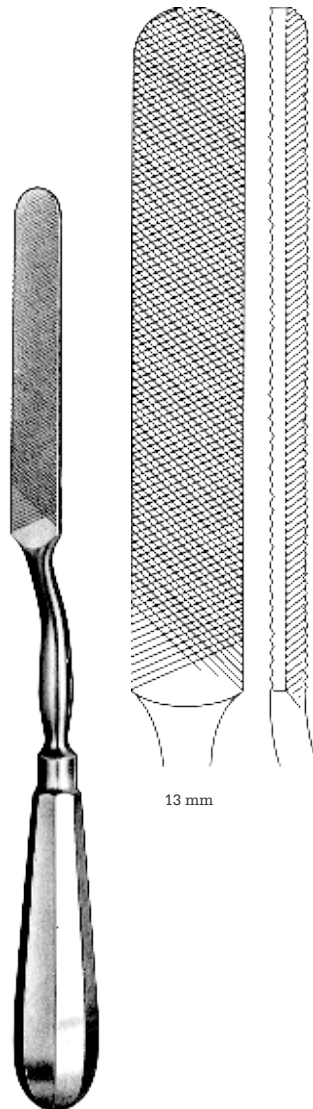

13 mm

BC322024
24.5 cm / 9 3/4"

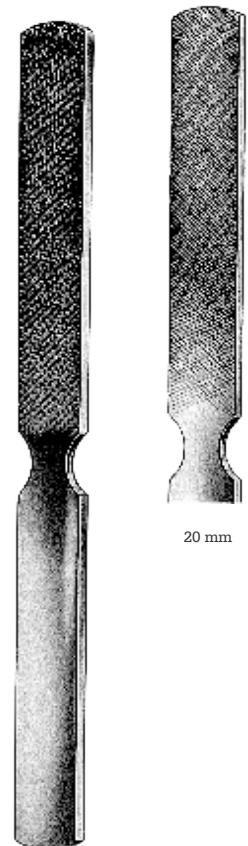

20 mm

BC322522
22 cm / 8 3/4"



Orthopedic
 Bone Files, Bone Levers
 Knochenfeile, Knochenhebel
 Lima para Huesos, Elevadores para hueso

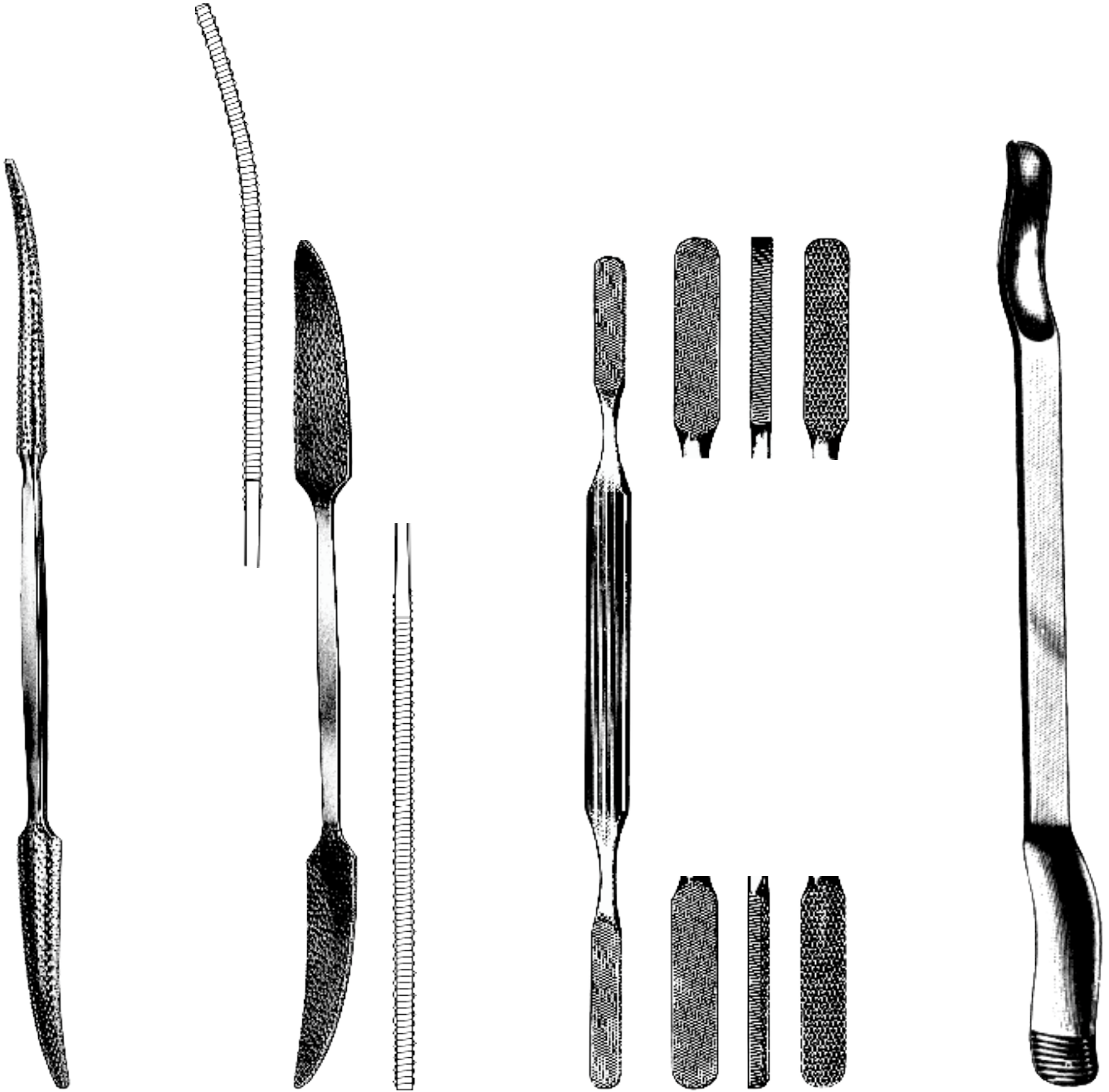

Putti
 BC323030
 30 cm / 12"

Putti
 BC323527
 27 cm / 10½"

Fomon
 BC324021
 21 cm / 8¼"
 Double ended, fine and
 coarse teeth 4-side, convex and flat
 blades 8 mm width

Murphy-Lane
 BC324530
 30 cm / 12"
 Bone skid

Orthopedic

Nasal Rasp, Bone Files

Nasenraspeln, Knochenfeile

Escofinasnasanes, Lima Para Huesos

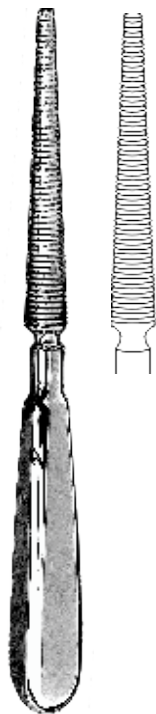

Trochlear
BC325017
17 cm / 6½"
Stainless steel



Maltz Improved
BC325521
21 cm / 8¼"
Double ended, forward and
backward cutting, 8 mm width



Aufricht
21 cm / 8¼"



BC326021
Single ended
forward cutting
9 mm width



BC326121
Single ended
backward cutting
9 mm width



Maltz
18 cm / 7"
Single ended
10 mm width

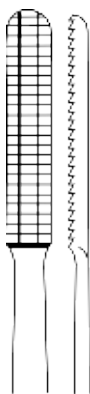

BC326518
34 x 7 mm
Backward cutting

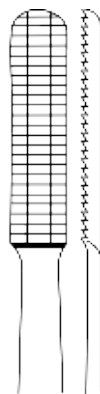

BC326618
34 x 7 mm
Forward cutting



Excision Arthroplasty
BC327017
17 cm / 6½"
Stainless steel

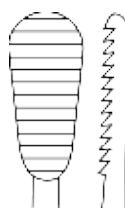

Joseph
BC327516
16 cm / 6¼"
Single ended, 8 mm at wide
point, fine cross serrations

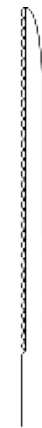



Orthopedic
Bone Files
Knochenfeile
Lima Para Huesos



Lewis Rasp
19 cm / 7½"



BC328019
Fine, single ended
8 mm width

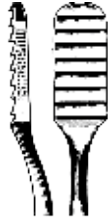

BC328119
Coarse, single ended
8 mm width
plain serrations



Cottle Rasp
BC328520
20.5 cm / 8"
Single ended, backward cutting
9 mm width
plain serrations



Miller-Colburn
BC059101
18 cm / 7"
Double ended, plain serrations

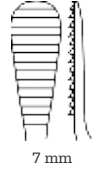

5 mm

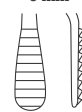

Miller-Colburn
BC329018
18 cm / 7"
Double ended, 5 mm width

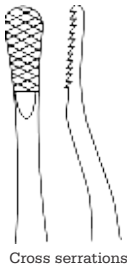

Cross serrations

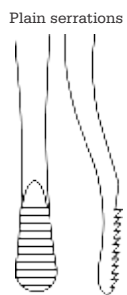

Plain serrations



Miller-Colburn
BC329518
18 cm / 7"
Double ended, cross serrations

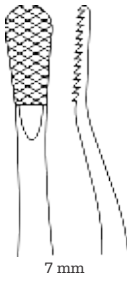

7 mm

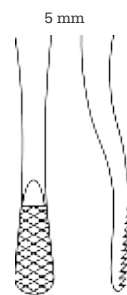

5 mm



Miller-Colburn
BC330121
21.5 cm / 8½"
Double ended, 13 mm width
Cross serrations, for rapid shaping of bone

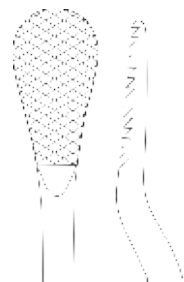

Fine serrations

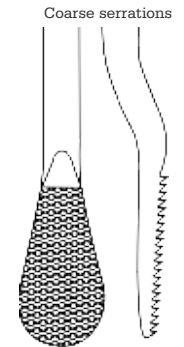

Coarse serrations

Orthopedic

Bone Files

Knochenfeile

Lima Para Huesos

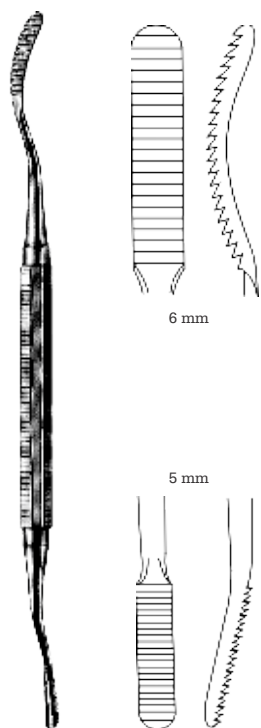

Miller-Colburn
BC059102
18.5 cm / 7¼"
Double ended, plain serrations

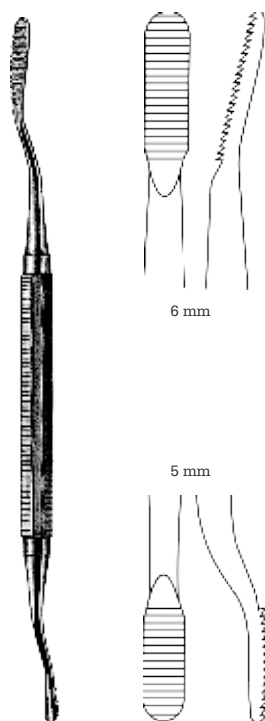

Miller-Colburn
BC059104
18 cm / 7"
Double ended, plain serrations

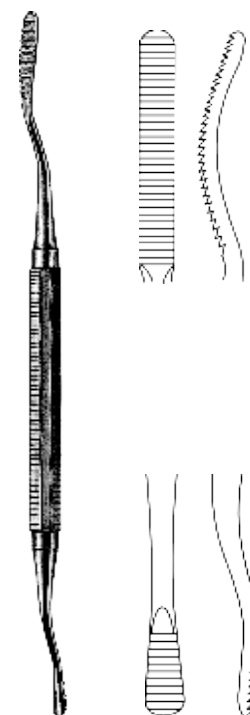

Miller-Colburn
BC059103
18 cm / 7"
Double ended, 5 mm width,
plain serrations



Polokoff Rasp
Double ended, plain serrations

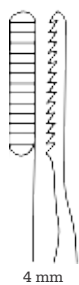

BC330518
18 cm / 7"

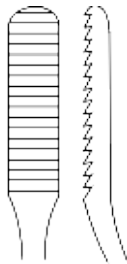

BC330521
21.5 cm / 8½"
6 mm width

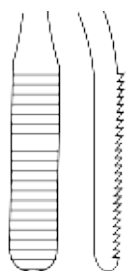

Miller-Colburn
BC331018
18 cm / 7"
Double ended

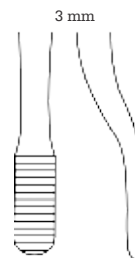
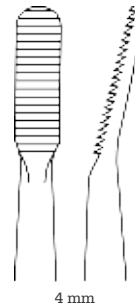



Orthopedic

Bone Drills, Reamers & Wire Saws
Bohrinstrumente, Perieme und Drahtsagen
Instrumental Para Perforar, Escariador Y Sierras de hilo

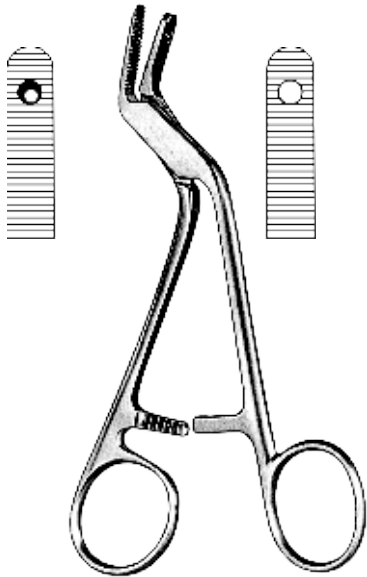

Adson
BC331515
15 cm / 6"
Drill guide

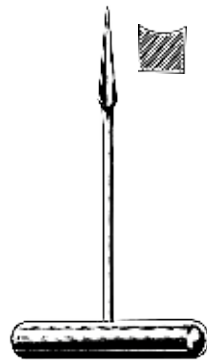

BC332014
14 cm / 5½"

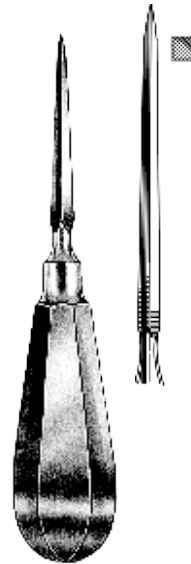

BC332514
14 cm / 5½"

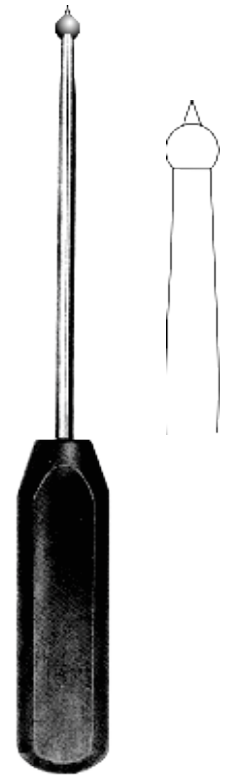

BC333030
30 cm / 12"
Straight ball spike



Perthes
BC333518
18 cm / 7"

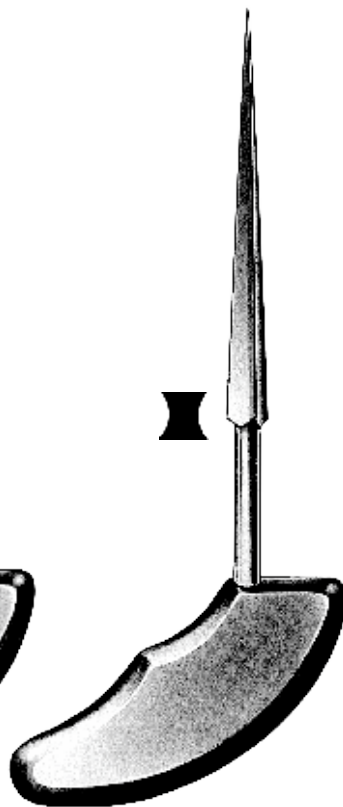

Perthes
BC334021
21 cm / 8¼"

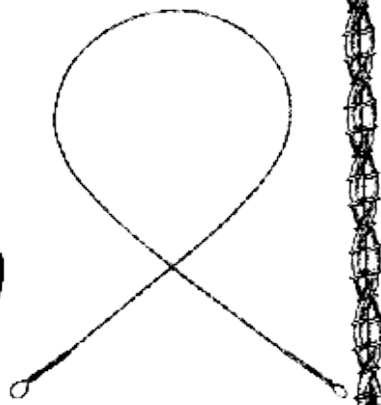

Olivecrona
BC334530 30 cm / 12"
BC334540 40 cm / 16"
BC334550 50 cm / 20"
BC334570 70 cm / 28"

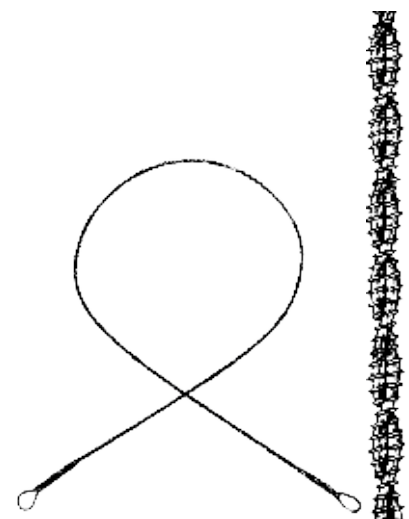

Gigli
BC335030 30 cm / 12"
BC335040 40 cm / 16"
BC335050 50 cm / 20"
BC335150 50 cm / 20"
Fine, 6 wires twisted

Orthopedic

Amputating, Resection Saws & Handles
 Amputation, Resektionssagen und griffe
 Ampvtacion, Sierras Para Reseccion Y Mangos



Gigli
 BC335500
 Handle

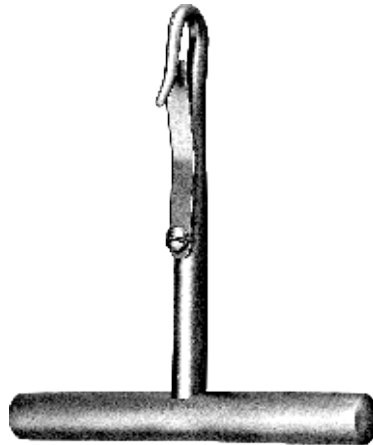

Gigli
 BC336000
 Handle with lock

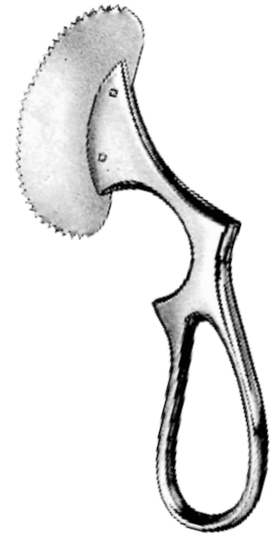

Engel
 BC336500



Lindemann
 BC337020
 20 cm / 8"



Langenbeck
 BC337523
 23 cm / 9"

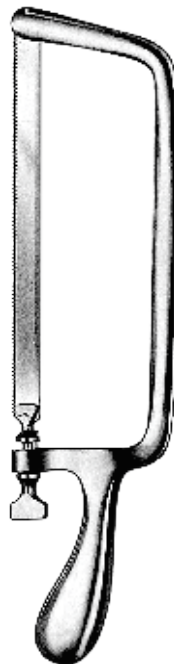

Charriere
 BC338035
 35 cm / 14"

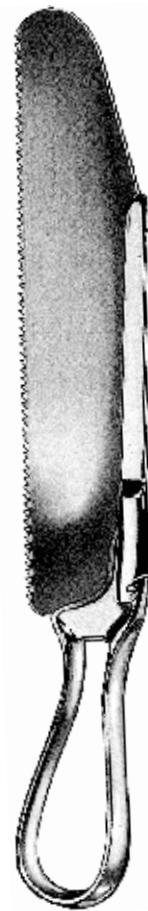

Charriere
 BC338527 27 cm / 10 1/2"
 BC338530 30 cm / 12"
 BC338534 34 cm / 13 1/2"

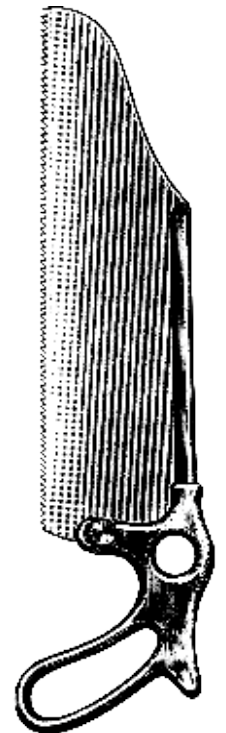

Satterlee
 BC339030
 30 cm / 12"
 Blade 23 cm / 9"



Orthopedic
 Retractor, Amputation and Resection Saws
 Wundhaken, Amputation-Und Resektionsagen
 Separadores, Sierras Para Ampvtacion Y Reseccion

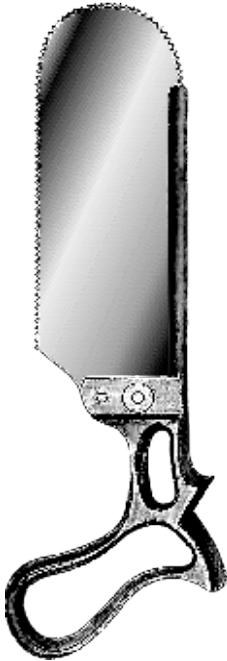

BC339530
 30 cm / 11 $\frac{3}{4}$ "
 Blade 20 cm
 Post mortem saw



Butcher
 BC340100
 Blade 45 cm
 Post mortem saw



BC340500
 Blade 40 cm
 Post mortem saw

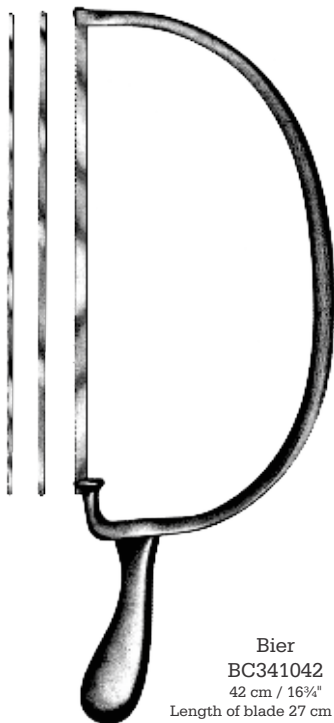

Bier
 BC341042
 42 cm / 16 $\frac{3}{4}$ "
 Length of blade 27 cm / 10 $\frac{1}{2}$ "
 Complete with one saw blade each
 4 mm, 6 mm, 8 mm



Rust
 BC341539
 39 cm / 15 $\frac{1}{2}$ "
 Length of blade
 Complete with one saw blade
 each 8 mm, 12 mm

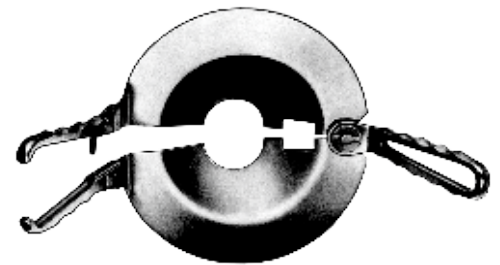

Percy

Orthopedic
Hand Drills
Handbohrapparate
Perforadores De Mano



Hudson
BC343500
Extension piece



BC343600
9 mm \varnothing
Conical burr



BC343700
14 mm \varnothing
Conical burr



BC343800
16 mm \varnothing
Spherical burr



BC343900
22 mm \varnothing
Spherical burr

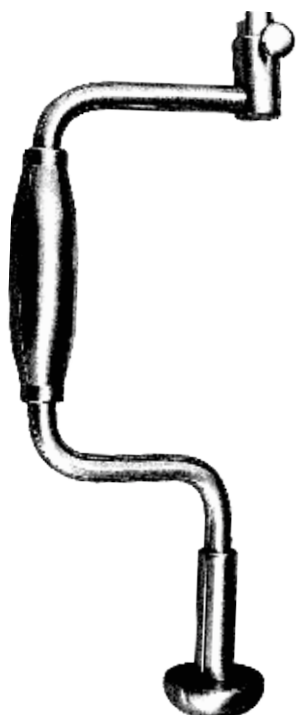

Hudson
27 cm / 10 $\frac{3}{4}$ "
BC342527
Complete set with Stainless steel handles
BC342627
Complete set with Ferrozell handles
BC342727
Complete set with Teflon handles



BC344000
14 mm \varnothing
Flat trephine



BC344100
2 mm \varnothing
Twist drill



BC344200
13 mm \varnothing
Burr



BC344300
16 mm \varnothing
Burr

Hudson
27 cm / 10 $\frac{3}{4}$ "
BC343027
BC343127
BC343227

Brace only with Stainless steel handles
Brace only with Ferrozell handles
Brace only with Teflon handles



Orthopedic
Hand Drills
Handbohrapparate
Perforadores De Mano

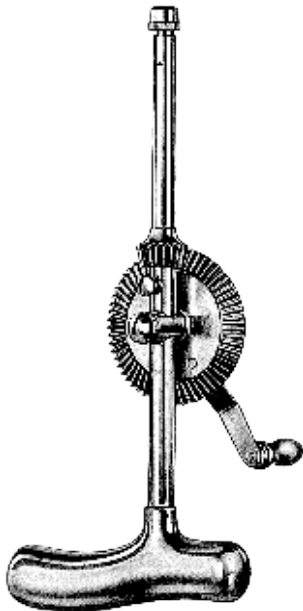

Stille-Sherman
BC344524
24 cm / 9½"

BC344500
Complete set



BC345000
2.5 mm ϕ
Twist Drill



BC345100
3 mm ϕ
Twist Drill



BC345200
3.5 mm ϕ
Twist Drill



BC345600
2.5 mm ϕ
Twist Drill



BC345700
3 mm ϕ
Twist Drill



BC345800
3.5 mm ϕ
Twist Drill



BC345900
4 mm ϕ
Twist Drill



BC346000
10 mm ϕ
Trephine



BC346100
5 mm ϕ
Spherical Burr

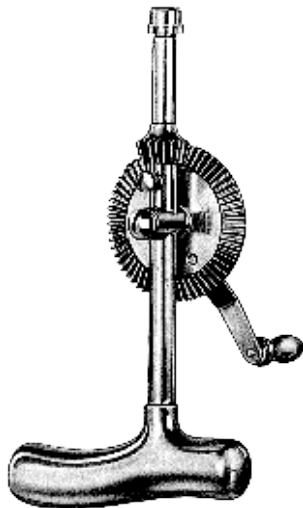

Stille
BC345520
20 cm / 8"

BC345500
Complete set



BC346200
8 mm ϕ
Spherical Burr

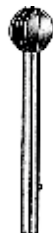

BC346300
12 mm ϕ
Spherical Burr



BC346400
16 mm ϕ
Spherical Burr



BC346500
1 mm ϕ
Twist Drill



BC346600
1.5 mm ϕ
Twist Drill



BC346700
2 mm ϕ
Twist Drill

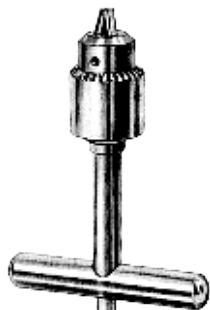

BC347000
Handle with chuck and key, accomodating up to 6.35 mm (1/4"), perforated, for inserting and extracting nails, guide pins and wire guide drills.

BC347600
Key only

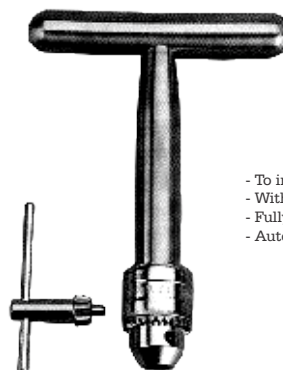

- To introduce bone pin
- With jacob chuck
- Fully cannulated
- Autoclaveable

Pin Chuck
BC347515 6.35 mm
15 cm / 6"
BC347514 4.50 mm
14 cm / 5 1/2"

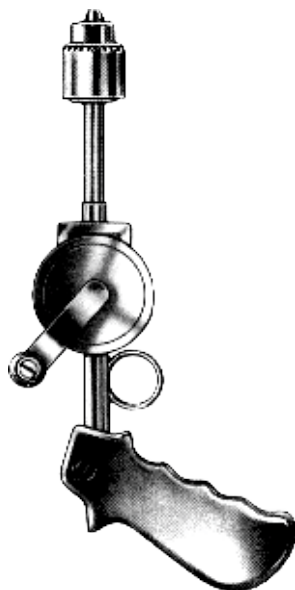

BC348000

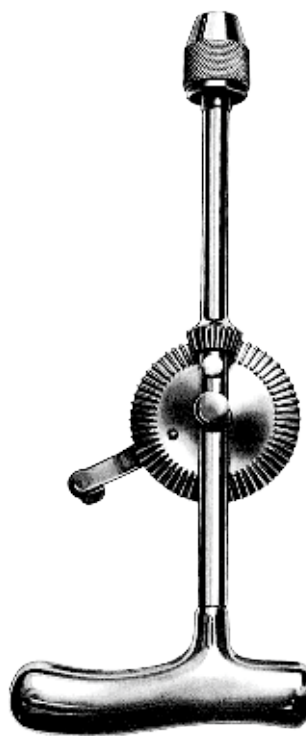

Moore
BC348500



BC348600
9 cm
3.2 mm Ø



BC348700
7 cm
3.2 mm Ø

BC348800
Complete with a set of
twist drill ref.
BC348600, BC348700



Orthopedic
Hand Drills and Chuck
Handbohrapparate und Griffe
Perforadores De Mano Y Mandril

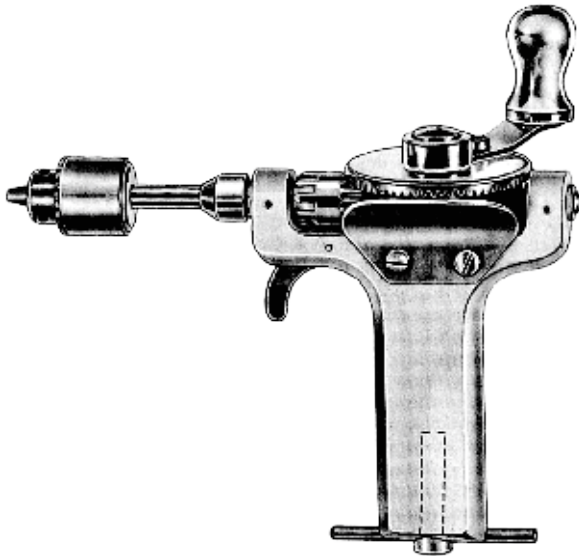

Bunnell
BC349024
24 cm / 9½"

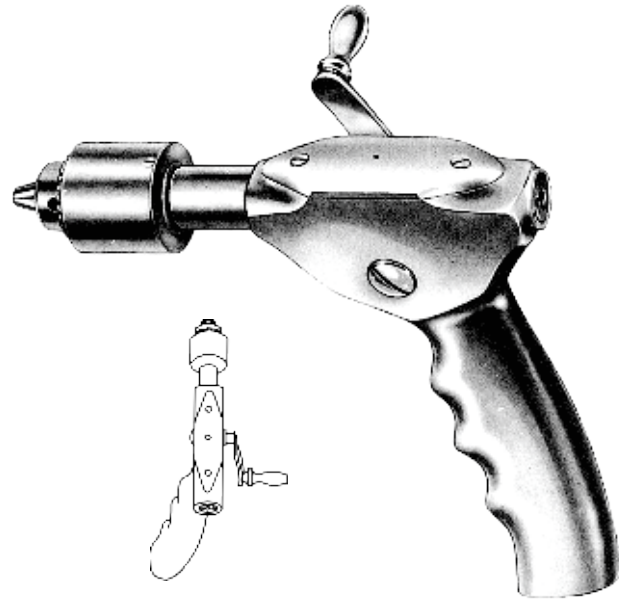

Ralk
BC349500
Normal shaft
BC349600
Long shaft



Jacobs
BC350100 Small
BC350200 Large
Stainless steel

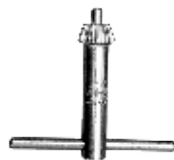

BC350500
Key for jacobs chuck
Stainless steel



BC351000 Small
BC351100 Large
Chuck chrome plated

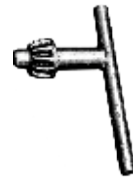

BC351200
Key for
chrome plated chuck

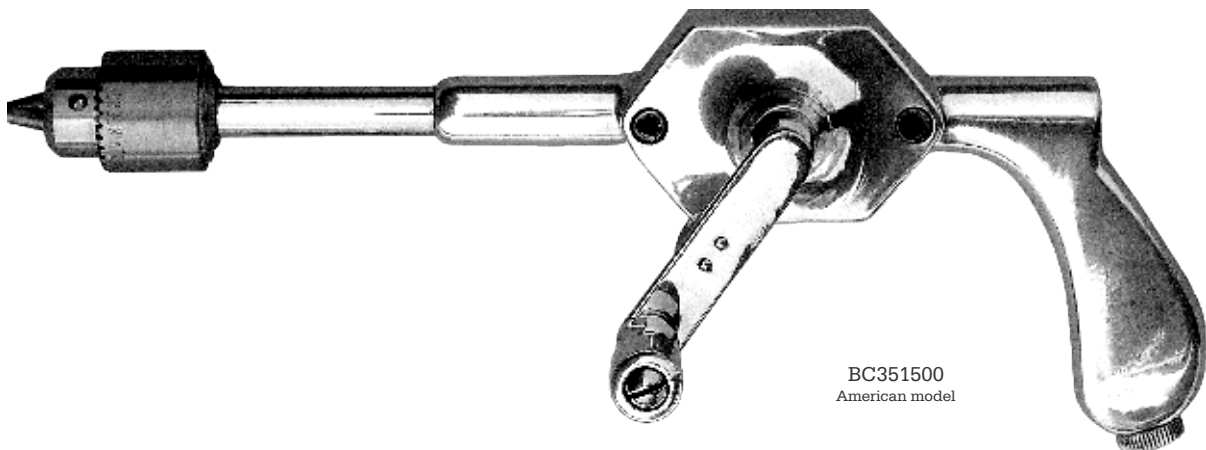

BC351500
American model

Orthopedic
Screw Drivers
Schraubenzieher
Destornilladores



Williams
BC352024
24 cm / 9½"



2.5 mm



3.5 mm



4.5 mm



BC356500
Sleeve only



BC356600
2.5 mm



BC352517
17 cm / 6¾"
Ferrozell handle

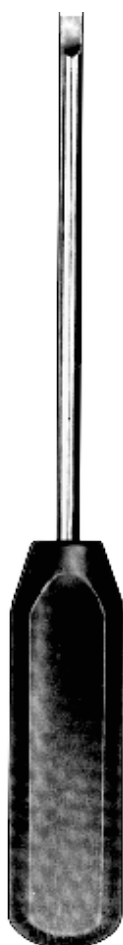

Lane
BC353025
25 cm / 10"
Ferrozell handle



BC353517
17 cm / 6¾"
BC353525
25 cm / 10"
Ferrozell handle



BC354017
17 cm / 6¾"
BC354025
25 cm / 10"
Ferrozell handle



Hexagon
BC354517
17 cm / 6¾"
BC354525
25 cm / 10"
Ferrozell handle

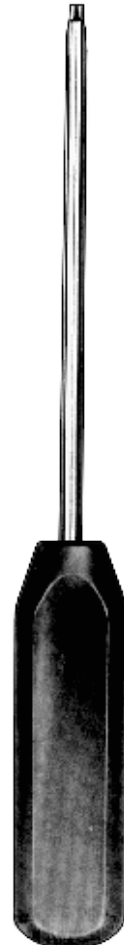

Hexagon
BC355017
17 cm / 6¾"
BC355025
25 cm / 10"
Ferrozell handle

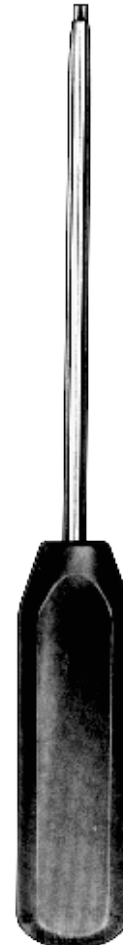

Hexagon
BC355517
17 cm / 6¾"
BC355525
25 cm / 10"
Ferrozell handle



BC356700
3.5 mm



BC356800
4.5 mm

Hexagon
BC356018
18 cm / 7"
1.5 mm tip
With sleeve



Orthopedic
Lead Hand
Bleihände
Manoplas de plomo



BC357000 For children
BC357100 For adults

Orthopedic

Nail Instruments, Finger Ring Saws
 Instrumente Für Finger-und Zehennagel, Fingerringen
 Instrumentos Para Unas, Sierras Para Abrir Anillos



BC357517
 17 cm / 6 3/4"
 Ring cutter



Walton
 BC358016
 16 cm / 6 1/4"
 BC358116
 Spare blade for ring cutters



BC358517
 17 cm / 6 3/4"
 Ring cutter

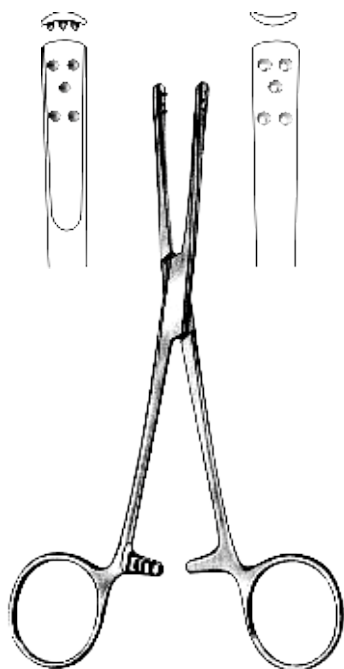

Penner
 BC359015
 15.5 cm / 6"

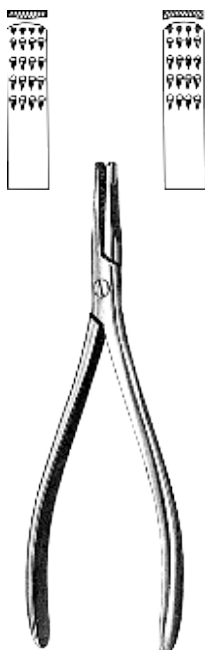

Radolf
 BC359513
 13.5 cm / 5 1/4"

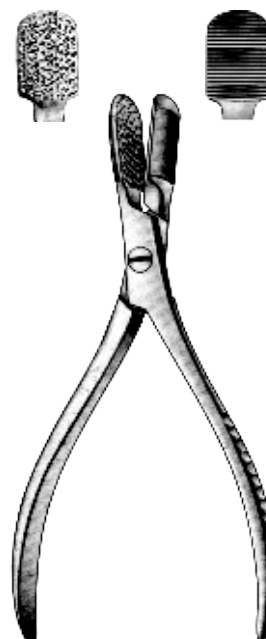

BC360114
 14.5 cm / 5 3/4"
 Nail extracting forceps

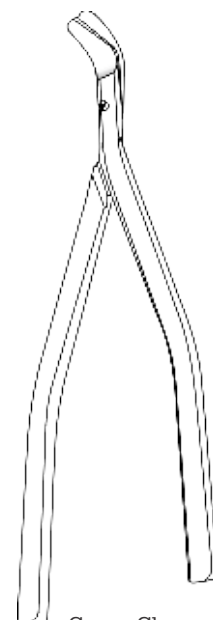

Coupe Clamp
 BC360514
 14 cm / 5 1/2"
 Plastic



Orthopedic
 Bone Curettes, Double Ended
 Scharfe Doppeloffel
 Cucharillas de doble extremo



BC361021
 21 cm / 8 1/4"



Williger
 13.5 cm / 5 1/4"



BC045900
 Fig. 00/0



BC045901
 Fig. 0/1



BC045912
 Fig. 1/2

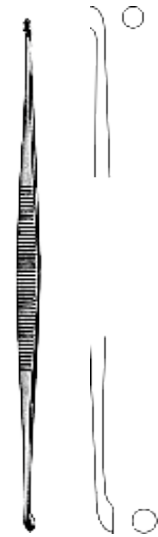

Martini
 BC361514
 14 cm / 5 1/2"



Volkman



BC362013
 13 cm / 5"



BC362014
 14 cm / 5 1/2"



BC362017
 17 cm / 6 3/4"



Volkman



BC362513
 13 cm / 5"



BC362516
 16 cm / 6 1/4"

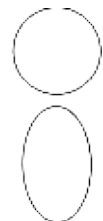

BC362520
 20 cm / 8"

Orthopedic
Bone Curettes
Scharfe Löffel
Cucharillas Cortantes



Volkmann
17 cm / 6 3/4"

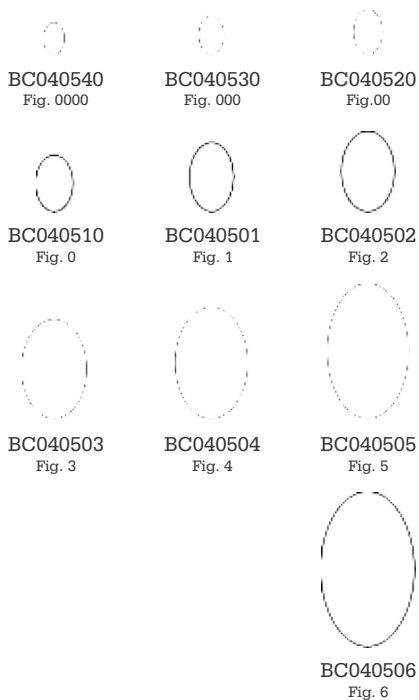

Spratt
17 cm / 6 3/4"

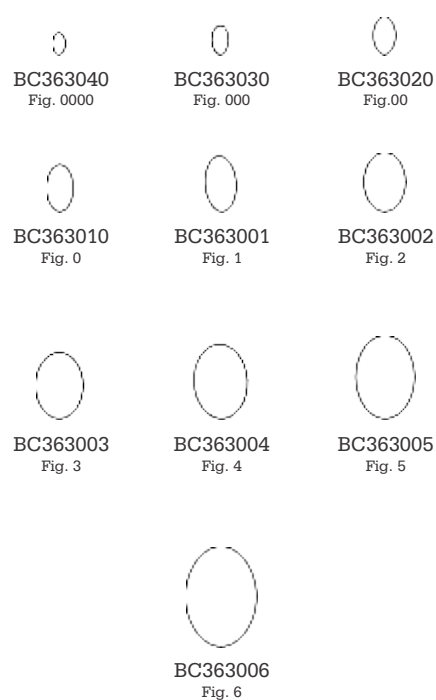

Bruns
17 cm / 6 3/4"

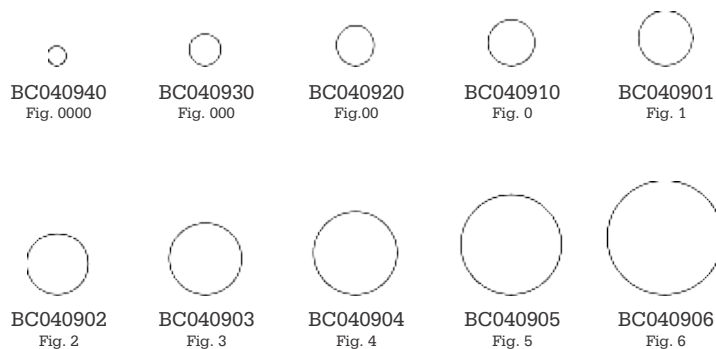



Orthopedic
Bone Curettes
Scharfe Löffel
Cucharillas Cortantes



Scheide

BC363530
Fig. 000

BC363520
Fig.00

BC363510
Fig. 0

BC363501
Fig. 1

BC363502
Fig. 2

BC363503
Fig. 3

BC363504
Fig. 4



BC364025



BC364125



BC364225



Williger
17.5 cm / 7"

BC205500
Fig. 00

BC205600
Fig. 00

BC205501
Fig. 0

BC205601
Fig. 0

BC205502
Fig. 1

BC205602
Fig. 1

BC205503
Fig. 2

BC205603
Fig. 2



25 cm / 9 3/4"

Orthopedic
 Bone Curettes
 Scharfe Löffel
 Cucharillas Cortantes



BC364524
 Fig. 1

BC364624
 Fig. 2

BC364724
 Fig. 3

BC364824
 Fig. 4

BC364924
 Fig. 5

BC365024
 Fig. 6



Simon
 24 cm / 9½"



BC044501
 Fig. 1

BC044504
 Fig. 4



BC044601
 Fig. 1

BC044604
 Fig. 4



BC044801
 Fig. 1

BC044804
 Fig. 4

BC044502
 Fig. 2

BC044505
 Fig. 5

BC044602
 Fig. 2

BC044605
 Fig. 5

BC044802
 Fig. 2

BC044805
 Fig. 5

BC044503
 Fig. 3

BC044506
 Fig. 6

BC044603
 Fig. 3

BC044606
 Fig. 6

BC044803
 Fig. 3

BC044806
 Fig. 6



Mod. USA
 16 cm / 6¼"

BC365521
 Fig. 1

BC365621
 Fig. 2

BC365721
 Fig. 3







































Halle
 21 cm / 8¼"



Orthopedic Bone Curettes Scharfe Löffel Cucharillas Cortantes

Add "N" to the item code for Teflon Handle.

	BC038140 Fig. 0000		BC366027 Fig. 0		BC367023 BC368023 Fig. 000	Straight Angled 45°		BC369028 BC370028 Fig. 000	Straight Angled 45°
	BC038130 Fig. 000		BC366127 Fig. 1		BC367123 BC368123 Fig. 00	Straight Angled 45°		BC369128 BC370128 Fig. 00	Straight Angled 45°
	BC038120 Fig. 00		BC366227 Fig. 2		BC367223 BC368223 Fig. 0	Straight Angled 45°		BC369228 BC370228 Fig. 0	Straight Angled 45°
	BC038110 Fig. 0		BC366327 Fig. 3		BC367323 BC368323 Fig. 1	Straight Angled 45°		BC369328 BC370328 Fig. 1	Straight Angled 45°
	BC038101 Fig. 1		BC366427 Fig. 4		BC367423 BC368423 Fig. 2	Straight Angled 45°		BC369428 BC370428 Fig. 2	Straight Angled 45°
	BC038103 Fig. 3				BC367523 BC368523 Fig. 3	Straight Angled 45°		BC369528 BC370528 Fig. 3	Straight Angled 45°
	BC038104 Fig. 4				BC367623 BC368623 Fig. 4	Straight Angled 45°		BC369628 BC370628 Fig. 4	Straight Angled 45°
	BC038105 Fig. 5				BC367723 BC368723 Fig. 5	Straight Angled 45°		BC369728 BC370728 Fig. 5	Straight Angled 45°
	BC038106 Fig. 6				BC367823 BC368823 Fig. 6	Straight Angled 45°		BC369828 BC370828 Fig. 6	Straight Angled 45°



Volkman
17 cm / 6 3/4"
Ferozell handle



Volkman
27 cm / 10 3/4"
Ferozell handle



Brun
23 cm / 9"
With solid hexagonal handle



Cobb
28 cm / 11"
Knurled handle
Stainless steel

Orthopedic

Bone Osteotomes Chisels And Gouges
 Meibei Und Osteotome
 Cinceles Y Gubias Para Huesos

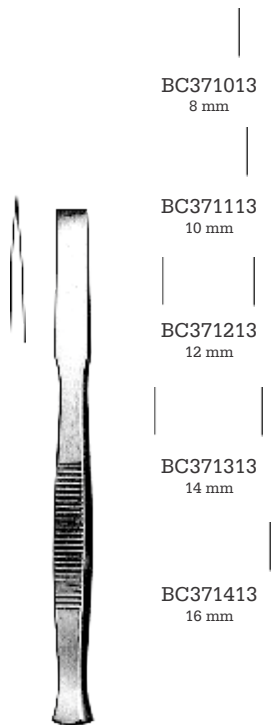

13.5 cm / 5 1/4"
Osteotomes

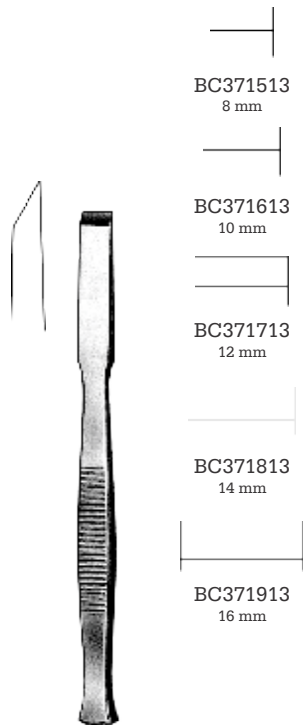

13.5 cm / 5 1/4"
Chisels

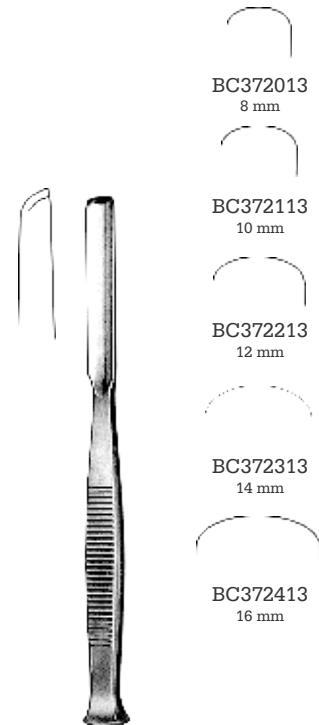

13.5 cm / 5 1/4"
Gouges

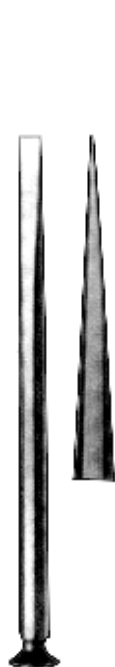

Gillies
 C372514 5 mm
 C372614 7 mm
 C372714 9 mm
 14 cm / 5 1/2"
Osteotomes



Partsch
 BC373017 3 mm
 BC373117 4 mm
 BC373217 5 mm
 BC373317 6 mm
 BC373417 7 mm
 17 cm / 6 3/4"
Chisels

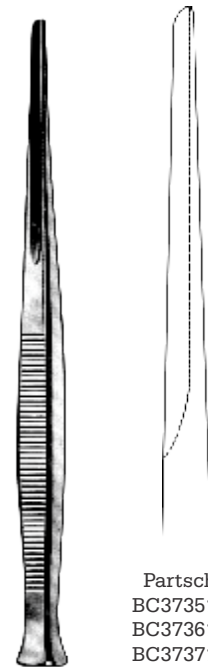

Partsch
 BC373517 3 mm
 BC373617 4 mm
 BC373717 5 mm
 BC373817 6 mm
 BC373917 7 mm
 17 cm / 6 3/4"
Gouges



Orthopedic Bone Osteotomes Chisels And Gouges Meibel Und Osteotome Cinceles Y Gubias Para Huesos



BC020602
13.5 cm / 5¼"
2 mm



BC020702
17 cm / 6¾"
2 mm



BC020603
13.5 cm / 5¼"
3 mm



BC020703
17 cm / 6¾"
3 mm



BC020604
13.5 cm / 5¼"
4 mm



BC020704
17 cm / 6¾"
4 mm



BC020605
13.5 cm / 5¼"
5 mm



BC020705
17 cm / 6¾"
5 mm



BC020606
13.5 cm / 5¼"
6 mm



BC020706
17 cm / 6¾"
6 mm



BC021002
13.5 cm / 5¼"
2 mm



BC021102
17 cm / 6¾"
2 mm



BC021003
13.5 cm / 5¼"
3 mm



BC021103
17 cm / 6¾"
3 mm



BC021004
13.5 cm / 5¼"
4 mm



BC021104
17 cm / 6¾"
4 mm



BC021005
13.5 cm / 5¼"
5 mm



BC021105
17 cm / 6¾"
5 mm



BC021006
13.5 cm / 5¼"
6 mm



BC021106
17 cm / 6¾"
6 mm



Partsch
Chisels

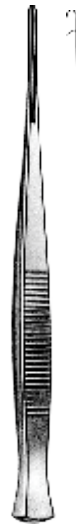

Partsch
Gouges



BC374018
4 mm



BC374118
6 mm



BC374218
8 mm



BC374318
10 mm

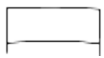

BC374418
12 mm

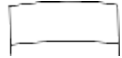

BC374518
14 mm



BC375018
4 mm



BC375118
6 mm



BC375218
8 mm



BC375318
10 mm



BC375418
12 mm



BC375518
14 mm



Alexander
18 cm / 7"
Chisels



Alexander
18 cm / 7"
Gouge

Orthopedic

Bone Osteotomes Chisels And Gouges

Meibei Und Osteotome

Cinceles Y Gubias Para Huesos



Lucas
BC376016 4 mm
BC376116 6 mm
16 cm / 6 1/4"



Lucas
BC376516 3 mm
BC376616 5 mm
16 cm / 6 1/4"



Cottle
BC377018 4 mm
BC377118 6 mm
BC377218 8 mm
BC377318 10 mm
BC377418 12 mm
18 cm / 7"
With depth markings

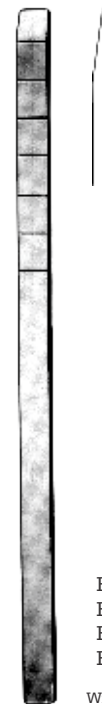

Cottle
BC378018 4 mm
BC378118 7 mm
BC378218 9 mm
BC378318 12 mm
18 cm / 7"
With depth markings



Cottle
BC378518
18 cm / 7"
8 mm

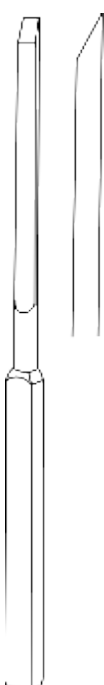

East Grinstead (Ward)
BC379018 3 mm
BC379118 5 mm
18 cm / 7"



Eastmann
BC379519 3 mm
BC379619 5 mm
19 cm / 7 1/2"

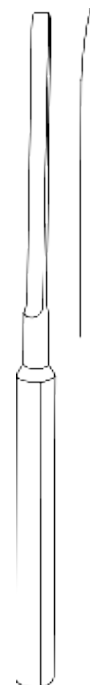

East Grinstead (Ward)
BC380018 3 mm
BC380118 5 mm
18 cm / 7"

Fishtail chisel, with protected ends



Orthopedic
Bone Osteotome Chisels
Meibel
Cinceles Para Huesos

	BC380512 3 mm	BC380612 4 mm	BC380712 6 mm		BC381517 3 mm	BC381617 4 mm	BC381717 6 mm
	BC380812 8 mm	BC380912 10 mm	BC381012 12 mm		BC381817 8 mm	BC381917 10 mm	BC382017 12 mm
	BC381112 15 mm				BC382117 15 mm		
	Mini-Lambotte 12.5 cm / 5" Osteotome				Mini-Lambotte 17 cm / 6 3/4" Osteotome		
		BC382524 15 mm				BC383524 15 mm	
		BC382624 20 mm			BC383624 20 mm		
		BC382724 25 mm			BC383724 25 mm		
		BC382824 30 mm			BC383824 30 mm		
		BC382924 38 mm			BC383924 38 mm		
		BC383024 44 mm			BC384024 44 mm		
		BC383124 50 mm			BC384124 50 mm		
Lambotte 24 cm / 9 1/2" Straight Osteotome			Lambotte 24 cm / 9 1/2" Curved Osteotome				

Orthopedic
Bone Osteotome Chisels
Meibel
Cinceles Para Huesos



Add "N" to the item code for Teflon Handle.



Tessier
20 cm / 7 3/4"

For taking grafts from ilium and tibia



BC384520
10 mm



BC384620
15 mm



BC384720
20 mm



BC384820
30 mm

Straight



BC385020
10 mm



BC385120
15 mm



BC385220
20 mm



BC385320
30 mm

Curved

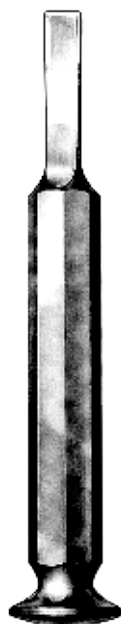

Tessier
16 cm / 6 1/4"

For taking grafts from the calva



BC385516
10 mm

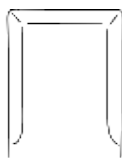

BC385616
15 mm



Straight

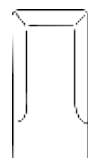

BC386016
10 mm

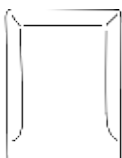

BC386116
15 mm



Curved



Key

BC386519 19 cm / 7 1/2"

BC386521 21 cm / 8 1/4"

Periosteal elevator

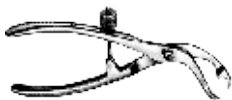

Orthopedic Bone Osteotome Chisels And Gouges Meibel Und Osteotome Cinceles Y Gubias Para Huesos

Add "N" to the item code for Teflon Handle.

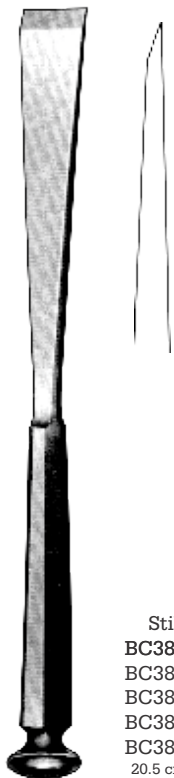

Stille
BC387020 10 mm
BC387120 12 mm
BC387220 15 mm
BC387320 20 mm
BC387420 25 mm
20.5 cm / 8"
Chisels

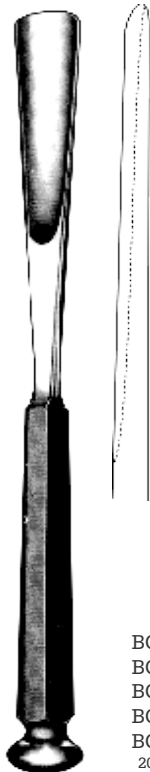

Stille
BC388020 10 mm
BC388120 12 mm
BC388220 15 mm
BC388320 20 mm
BC388420 25 mm
20.5 cm / 8"
Gouges

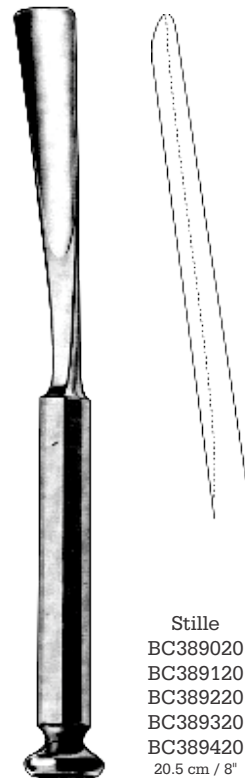

Stille
BC389020 10 mm
BC389120 12 mm
BC389220 15 mm
BC389320 20 mm
BC389420 25 mm
20.5 cm / 8"
Gouges
For taking grafts from the ribs

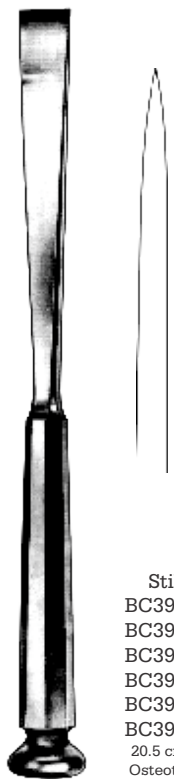

Stille
BC390020 8 mm
BC390120 10 mm
BC390220 12 mm
BC390320 15 mm
BC390420 20 mm
BC390520 25 mm
20.5 cm / 8"
Osteotomes



Stille
BC391020 10 mm
BC391120 12 mm
BC391220 15 mm
BC391320 20 mm
BC391420 25 mm
20.5 cm / 8"
Osteotomes, straight

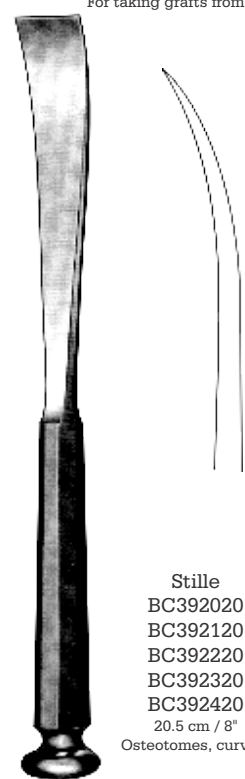

Stille
BC392020 10 mm
BC392120 12 mm
BC392220 15 mm
BC392320 20 mm
BC392420 25 mm
20.5 cm / 8"
Osteotomes, curved

Orthopedic

Osteotome And Gouges

Osteotome, HohlmeiBel

Osteotomos, Gubias



Add "N" to the item code for Teflon Handle. Add "Z" to the item code for Ferrozell Handle.

BC393020
6 mm

BC394020
6 mm

BC393120
9 mm

BC394120
9 mm

BC393220
13 mm

BC394220
13 mm

BC393320
16 mm

BC394320
16 mm

BC395020
9 mm

BC395520
9 mm

BC393420
19 mm

BC394420
19 mm

BC395120
14 mm

BC395620
14 mm

BC393520
25 mm

BC394520
25 mm

BC395220
19 mm

BC395720
19 mm

BC393620
32 mm

BC394620
32 mm

BC395320
25 mm

BC395820
25 mm

Smith Peterson
20 cm / 8"

Smith Peterson
20 cm / 8"

Smith Peterson
20 cm / 8"

Smith Peterson
20 cm / 8"



Orthopedic Bone Chisels and Osteotome MeiBel und Osteotome Cinceles para huesos

Add "N" to the item code for Teflon Handle. Add "Z" to the item code for Ferrozell Handle.



BC396024 24 cm / 9½"
BC396518 18 cm / 7"
6 mm



BC396124 24 cm / 9½"
BC396618 18 cm / 7"
13 mm



BC396224 24 cm / 9½"
BC396718 18 cm / 7"
19 mm



BC396324 24 cm / 9½"
BC396818 18 cm / 7"
25 mm



BC396424 24 cm / 9½"
32 mm



6 mm 10 mm 13 mm 16 mm



19 mm 25 mm

32 mm



Hibbs / Hilder
Chisel



Hibbs / Hilder
Osteotome

BC397024	6 mm	BC399024
BC397124	10 mm	BC399124
BC397224	13 mm	BC399224
BC397324	16 mm	BC399324
BC397424	19 mm	BC399424
BC397524	25 mm	BC399524
BC397624	32 mm	BC399624
24 cm / 9½"		24 cm / 9½"
Straight		Curved
BC398018	6 mm	BC400118
BC398118	10 mm	BC400218
BC398218	13 mm	BC400318
BC398318	16 mm	BC400418
BC398418	19 mm	BC400518
BC398518	25 mm	BC400618
BC398618	32 mm	BC400718
18 cm / 7"		18 cm / 7"
Straight		Curved

Orthopedic

Gouges
Hohlmeißel
Gubias



Add "N" to the item code for Teflon Handle. Add "Z" to the item code for Ferrozell Handle.

BC401018	6 mm	BC401023
BC401118	13 mm	BC401123
BC401218	19 mm	BC401223
BC401318	25 mm	BC401323
BC401418	32 mm	BC401423
18 cm / 7"		23 cm / 9"
Straight		Straight

Hilder
Gouge

BC402018	6 mm	BC402023
BC402118	13 mm	BC402123
BC402218	19 mm	BC402223
BC402318	25 mm	BC402323
BC402418	32 mm	BC402423
18 cm / 7"		23 cm / 9"
Curved		Curved

Hilder
Gouge



Orthopedic Chisels FlachmeiBel Cinceles

Add "N" to the item code for Teflon Handle. Add "T" to the item code for Ferrozell Handle.



Farabeuf
21 cm / 8 1/4"
Osteotome

BC403021
10 mm

BC403121
15 mm

BC403221
20 mm

BC403321
25 mm

BC403421
30 mm



Farabeuf
25 cm / 10"
Chisel

BC404025
6 mm

BC404125
8 mm

BC404225
10 mm

BC404325
12 mm

BC404425
15 mm

BC404525
20 mm

BC404625
25 mm

BC404725
30 mm



Hautant
13 cm / 5"
Chisel

BC405013
2 mm

BC405113
4 mm

BC405213
5 mm

BC405313
6 mm

BC405413
8 mm

BC405513
10 mm

BC405613
12 mm



Judet
22 cm / 8 3/4"
Chisel

BC406022
10 mm

BC406122
15 mm

BC406222
20 mm

BC406322
25 mm

BC406422
30 mm

BC406522
35 mm

BC407035
6 mm



Letourne
35 cm / 14"
Gouge

Orthopedic

Chisels
Flachmeißel
Cinceles



Add "N" to the item code for Teflon Handle. Add "T" to the item code for Ferrozell Handle.

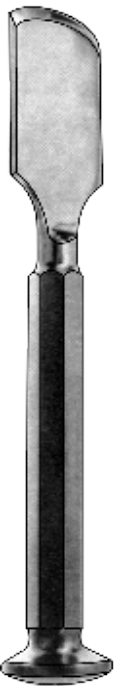

BC407521
35 mm

Laucas Championniere
21 cm / 8¼"



BC408020
10 mm

BC408120
15 mm

BC408220
20 mm

Maceven
20 cm / 8"



BC408513
3.5 mm

Mante
13 cm / 5"



BC409014
10 mm

BC409114
15 mm

BC409214
20 mm

Ombredanne
14 cm / 5½"



BC410000 14 cm
BC410500 17 cm
2 mm

BC410100 14 cm
BC410600 17 cm
3 mm

BC410200 14 cm
BC410700 17 cm
4 mm

BC410300 14 cm
BC410800 17 cm
6 mm

BC410400 14 cm
BC410900 17 cm
8 mm

Partsch



BC411516
4 mm

BC411616
6 mm

BC411716
8 mm

BC411816
10 mm

BC411916
12 mm

BC412016
14 mm

Poirier
16 cm / 6¼"



BC412516
6 mm

BC412616
8 mm

BC412716
10 mm

BC412816
12 mm

Portmann
16 cm / 6¼"



Orthopedic Gouges Hohlmeißel Gubias

Add "N" to the item code for Teflon Handle. Add "Z" to the item code for Ferrozell Handle.



- BC413030
Straight
- BC413130
Half curved
- BC413230
Curved

- BC413528
8 mm

- BC413616
10 mm

- BC413716
12 mm



- BC414024
2 mm

- BC414124
4 mm

- BC414224
6 mm

- BC414324
8 mm

Cobb
30 cm / 11 3/4"
Blade 6 mm

- BC414513
2 mm

- BC414613
4 mm

- BC414713
5 mm

- BC414813
6 mm

- BC414913
8 mm

- BC415013
10 mm

- BC415113
12 mm



Cobb
28 cm / 11"

- BC415529
Straight

- BC415629
Concave

- BC415729
Convex



Hautant
13 cm / 5"



Honton
29.5 cm / 5"

Guillaume
24 cm / 9 1/2"

Orthopedic

Gouges
Hohlmeißel
Gubias



Add "N" to the item code for Teflon Handle. Add "Z" to the item code for Ferrozell Handle.



Poirier-Trillat
20 cm / 8"

BC416020
4 mm

BC416120
6 mm

BC416220
8 mm

BC416320
10 mm

BC416420
12 mm

BC416520
14 mm



Poirier
16 cm / 6 1/4"

BC417016
2 mm

BC417116
4 mm

BC417216
6 mm

BC417316
8 mm

BC417416
10 mm

BC417516
12 mm

BC417616
14 mm



Postel
25 cm / 10"



BC418025 Straight
BC418125 Angled 135°
BC418225 Angled 150°
8 mm



Putti
25 cm / 10"



BC418525
30 mm



Orthopedic Osteotomes And Gouges Osteotome und Hohlmeißel Osteotomos Y Gubias

Add "N" to the item code for Teflon Handle. Add "Z" to the item code for Ferrozell Handle.



Smith - Petersen
23.5 cm / 9 1/4"

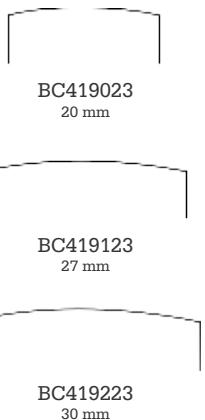

Stagnara
30 cm / 12"

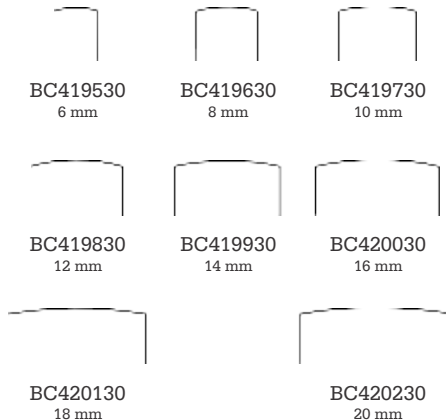

Cauchoix
25 cm / 10"

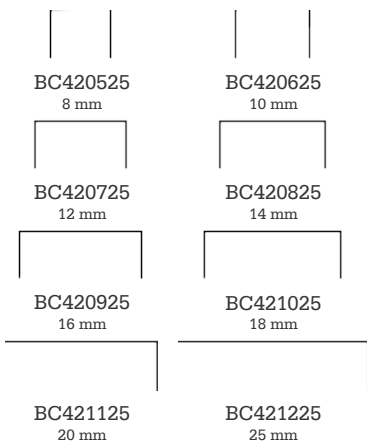

Farabeuf
21 cm / 8 1/4"

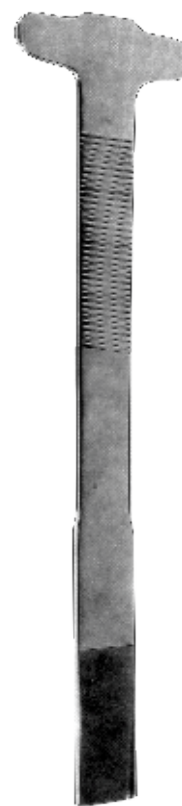
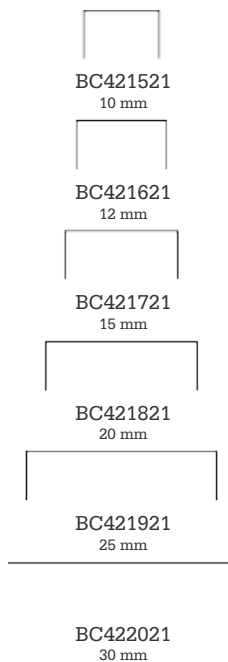

Robin
16 cm / 6 1/4"

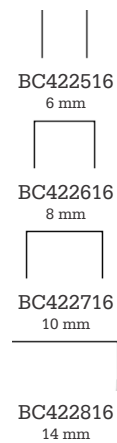

Orthopedic

Bone Chisels and Gouges

MeiBel und Osteotome

Cinceles y Gubias para Huesos



Add "N" to the item code for Teflon Handle. Add "Z" to the item code for Ferrozell Handle.

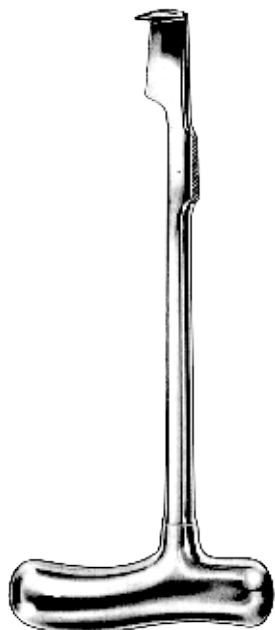

Lebsche
BC423024
24.5 cm / 9 3/4"

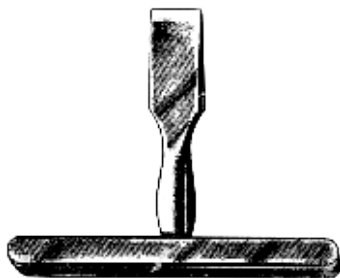

Virchow
BC423500
Skull breaker



BC426128
Straight



BC426228
Medium curve



BC424022
22 cm / 8 3/4"



Brunetti
BC424528
28 cm / 11"
Left



Brunetti
BC425028
28 cm / 11"
Right



Cobb
BC425529 Tip 10 mm
BC425629 Tip 13 mm
BC425729 Tip 19 mm
29 cm / 11 1/2"
Spinal elevator



Cobb
BC426028
28 cm / 11"
Spinal gouge
7 mm blade width



BC426328
Strong curve



BC426428
Reverse curve



Orthopedic Bone Osteotomes Chisels and Gouges Osteotome und Hohlmeißel Cinceles y Gubias para huesos

Add "N" to the item code for Teflon Handle.



Mini-Lexer
18 cm / 7"
Ferrozell handle

BC023304 4 mm
BC023306 6 mm
BC023308 8 mm

BC023310 10 mm
BC023312 12 mm



Mini-Lexer
18 cm / 7"
Ferrozell handle

BC023404 4 mm
BC023406 6 mm
BC023408 8 mm

BC023410 10 mm
BC023412 12 mm



Lexer
22 cm / 8 3/4"
Ferrozell handle

BC427022 7 mm
BC427122 10 mm
BC427222 15 mm

BC427322 20 mm
BC427422 25 mm

BC427522 30 mm



Lexer
22 cm / 8 3/4"
Ferrozell handle

BC428022 7 mm
BC428122 10 mm
BC428222 15 mm

BC428322 20 mm
BC428422 25 mm

BC428522 30 mm

Orthopedic

Wedge Osteotomes, Blade Osteotomes
 Keilosteotome, Blattosteotome
 Osteotomos de Cuna, Osteotomos de Hojas



Add "N" to the item code for Teflon Handle.



BC429022
8 mm

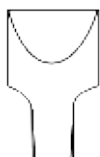

BC429122
12 mm

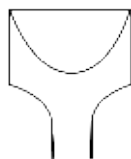

BC429222
16 mm



BC429522
8 mm



BC429622
12 mm



BC429722
16 mm

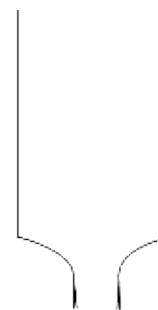

BC429822
20 mm



Obwegeser
22 cm / 8³/₄"



Obwegeser
22 cm / 8³/₄"



Orthopedic
Spongiosa Gouges
SpongiosaentnahmemeiBel
Cinceles de esponjosa

Add "N" to the item code for Teflon Handle.

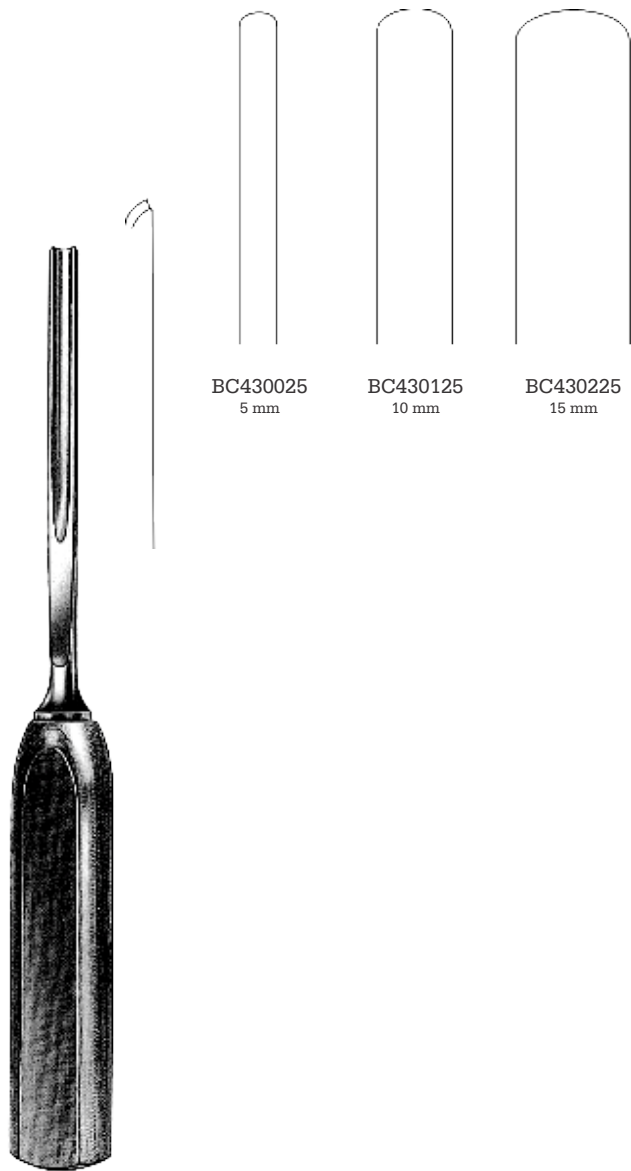

BC430025
5 mm

BC430125
10 mm

BC430225
15 mm

Lexer
25 cm / 10"
Ferozell handle

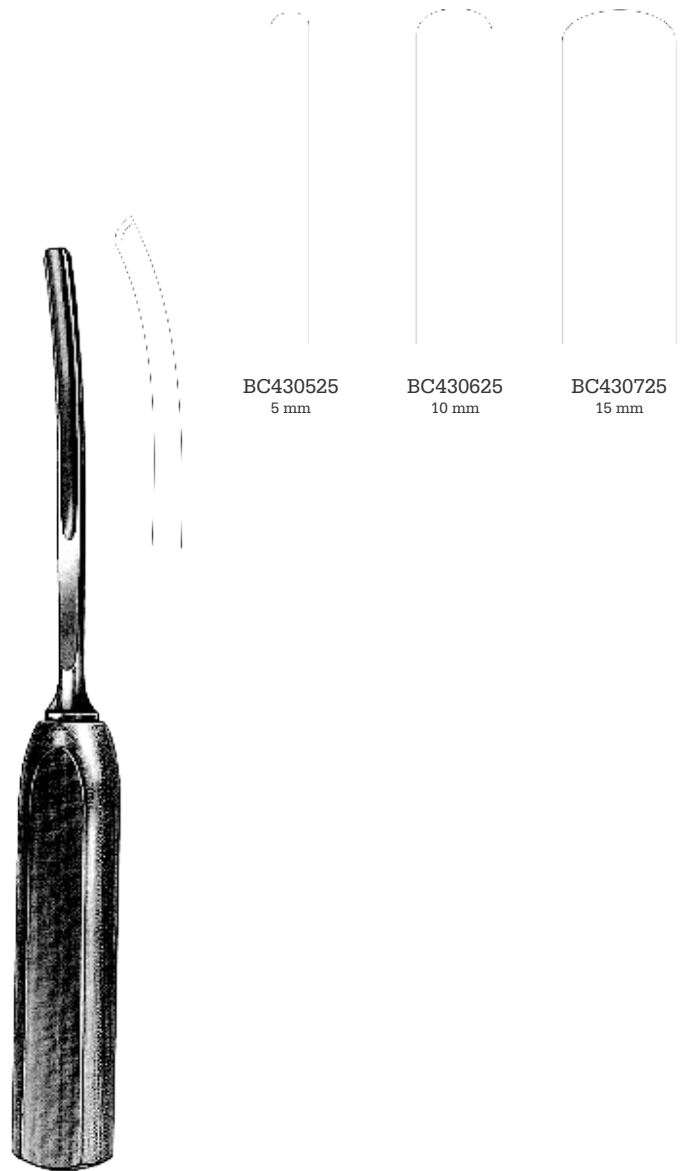

BC430525
5 mm

BC430625
10 mm

BC430725
15 mm

Lexer
25 cm / 10"
Ferozell handle

Orthopedic

Bone Osteotome Chisels And Gouges
 Meibel Und Osteotome
 Cinceles Y Gubias Para Huesos



Add "N" to the item code for Teflon Handle.

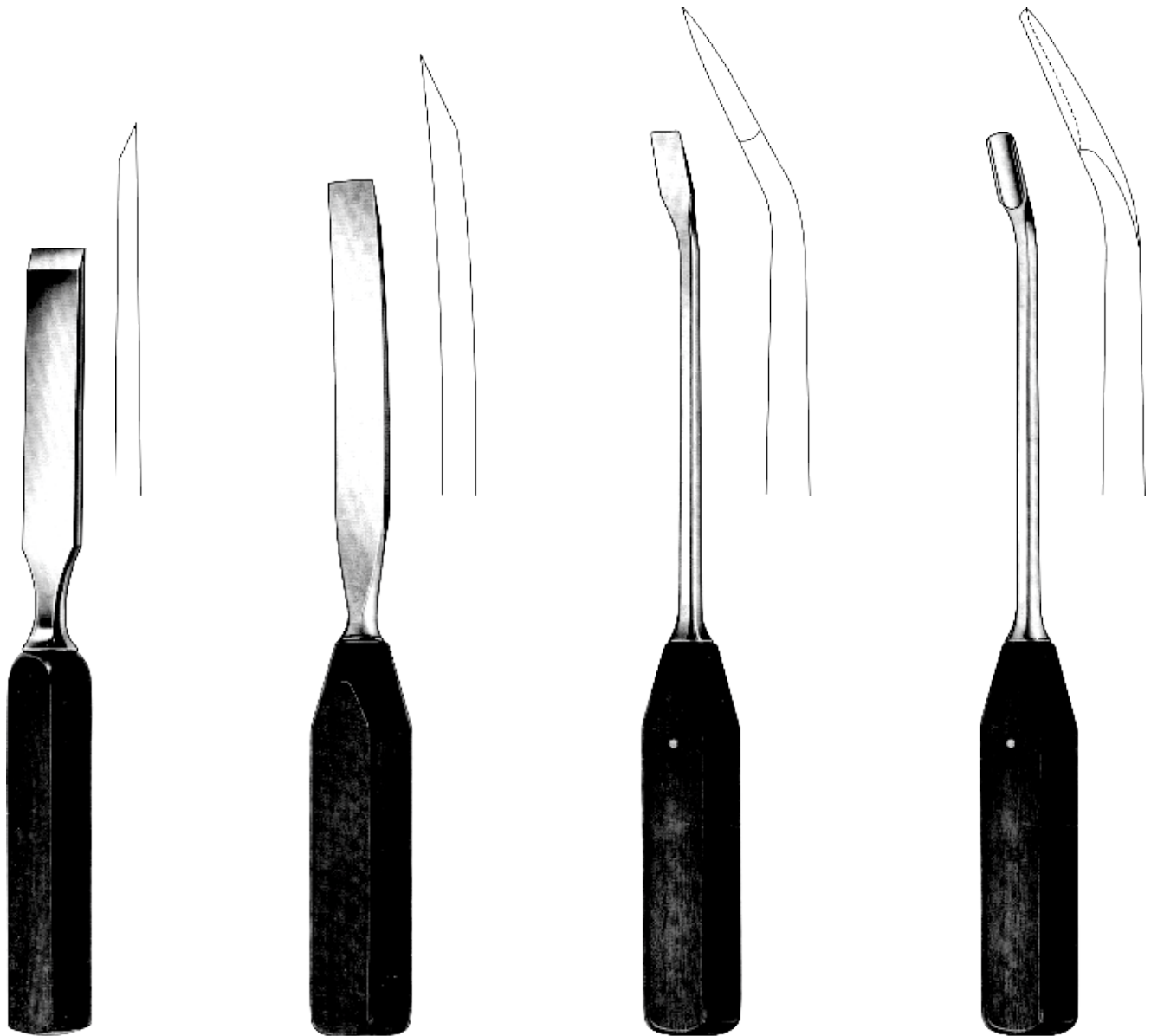

BC431024
 24.5 cm / 9 3/4"
 20 mm
 Ferrozell handle

BC431526
 26.5 cm / 10 1/2"
 16 mm
 Ferrozell handle, curved

Lexer
 BC432027 10 mm
 BC432127 15 mm
 27.5 cm / 10 3/4"
 Ferrozell handle

Lexer
 BC432527 10 mm
 BC432627 15 mm
 27.5 cm / 10 3/4"
 Ferrozell handle



Orthopedic
Spongiosa Gouges
SpongiosaentnahmemeiBel
Cinceles de esponjosa

Add "N" to the item code for Teflon Handle.

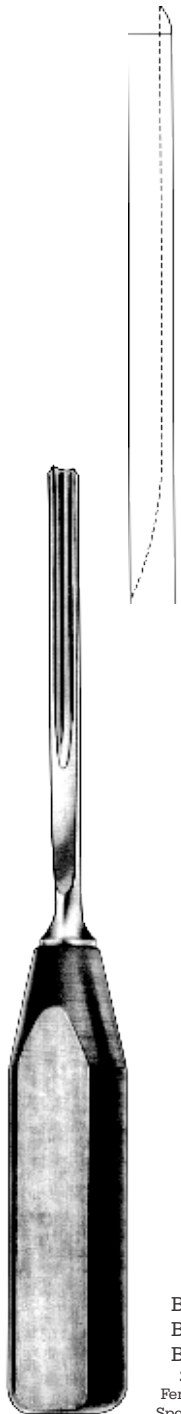

BC433025 5 mm
BC433125 10 mm
BC433225 15 mm
25 cm / 10"
Ferozell handle
Spongiosa gouge

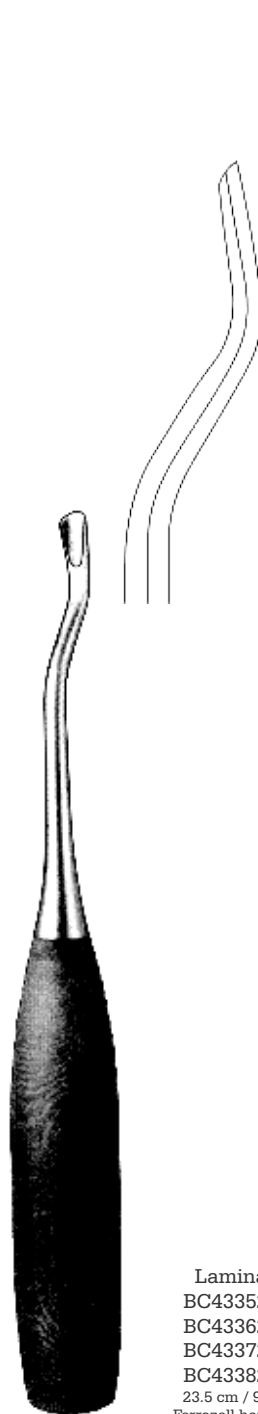

Lamina
BC433523 6 mm
BC433623 8 mm
BC433723 11 mm
BC433823 16 mm
23.5 cm / 9 1/4"
Ferozell handle

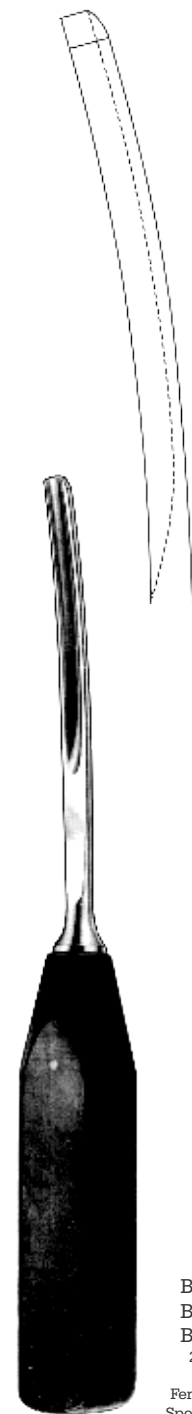

BC434025 5 mm
BC434125 10 mm
BC434225 15 mm
25 cm / 10"
Curved
Ferozell handle
Spongiosa gouge

Orthopedic

Gouges
Hohlmeißel
Gubias



Add "N" to the item code for Teflon Handle.

BC434528

BC434628

9 mm

15 mm

30 mm

BC435034	9 mm	BC435534	9 mm	BC436034	9 mm
BC435134	15 mm	BC435634	15 mm	BC436134	15 mm
BC435234	30 mm	BC435734	30 mm	BC436234	30 mm
Inclined forward		Inclined backward		Straight	

Lexer
28 cm / 11"
Ferozell handle
Spongiosa gouge

Wagner
34 cm / 13½"
Ferozell handle

Long handled thin concave osteotomes for removal of osteophytes as well as for creating small notches throughout the acetabular surface. The instruments can also be used for removing bone cement from the narrow cavity when removing a total hip prosthesis.



Orthopedic

Chisel Blades, Chisel Handle

MeiBelklingen, MeiBelgriff

Hojas de cincel, Mango para hojas de cincel

Add "N" to the item code for Teflon Handle.



BC436518
18.5 cm / 7¼"
Handle, only
Ferrozell handle



5 mm
BC436608
8.5 cm / 3¼"



10 mm
BC436708
8.5 cm / 3¼"



16 mm
BC436808
8.5 cm / 3¼"



25 mm
BC436908
8.5 cm / 3¼"

Osteotome blades,
interchangeable



5 mm
BC437008
8.5 cm / 3¼"



10 mm
BC437108
8.5 cm / 3¼"

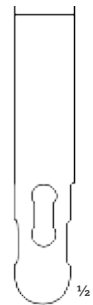

16 mm
BC437208
8.5 cm / 3¼"



25 mm
BC437308
8.5 cm / 3¼"

Chisel blades,
interchangeable

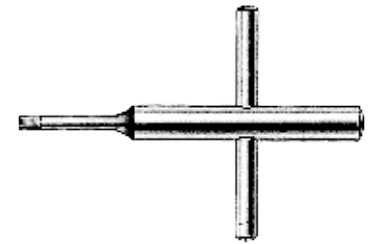

BC437509
9 cm / 3½"
Key
BC437600
Spare screw



Gouge blades,
interchangeable

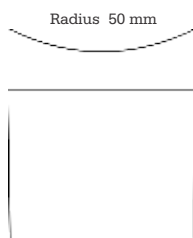

Radius 50 mm
25 mm
BC438013
13.5 cm / 5¼"

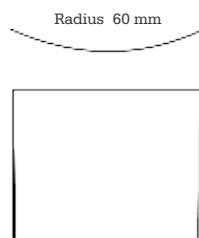

Radius 60 mm
25 mm
BC438113
13.5 cm / 5¼"

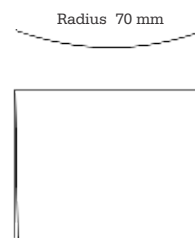

Radius 70 mm
25 mm
BC438213
13.5 cm / 5¼"

Orthopedic

Bone Hooks

Knochenhaken

Gancho para huesos

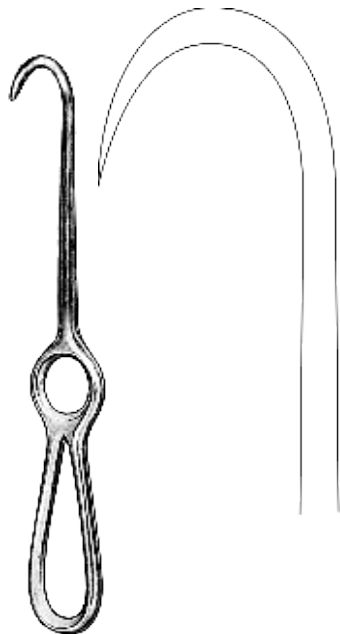

Volkmann
BC438520
20 cm / 8"
19 x 27 mm
Sharp

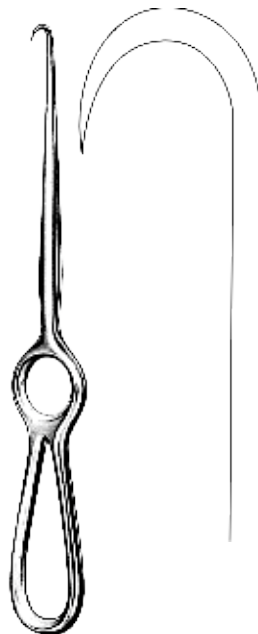

Volkmann
BC439023
23 cm / 9"
15 x 20 mm
Sharp

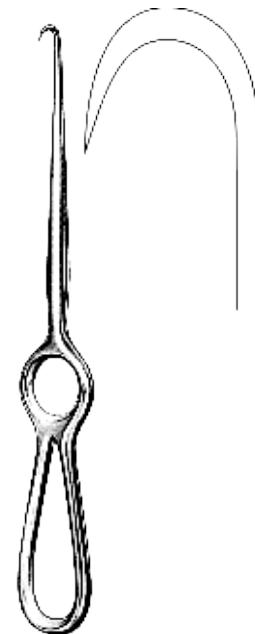

Volkmann
BC439525
25 cm / 9 1/4"
15 x 20 mm
Sharp



23 cm / 9"
Sharp
Bone hook with grip handle

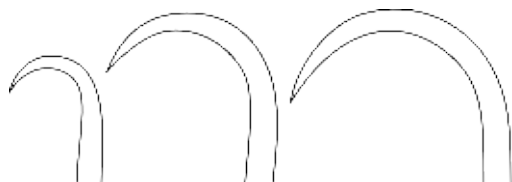

BC440023
6 x 10 mm
Small

BC440123
11 x 18 mm
Medium

BC440223
12 x 30 mm
Large



BC440518
18 cm / 7"
18 x 21 mm
Sharp with T-handle
large, for femurs



Zygoma
BC441017
17 cm / 6 3/4"

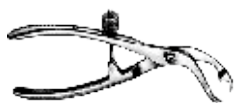

Orthopedic Elevators Elevatori Elevadores



Williger
 BC441516 Tip 4 mm
 BC441616 Tip 5 mm
 BC441716 Tip 6 mm
 BC441816 Tip 7 mm
 16 cm / 6 1/4"



Langenbeck
 20 cm / 8"



BC442020
 Tip 8 mm



BC442120
 Tip 10 mm



BC444517
 17 cm / 6 3/4"



8 mm



Langenbeck



BC445017
 17 cm / 6 3/4"
 5 mm



BC445117
 17 cm / 6 3/4"
 7 mm



BC445020
 20 cm / 8"
 8 mm



BC445120
 20 cm / 8"
 10 mm



Adson
 17 cm / 6 3/4"



BC445517



BC445617



BC445717



BC445817

Orthopedic
 Periosteal Raspatories
 Raspatorien
 Legras Periostotomos

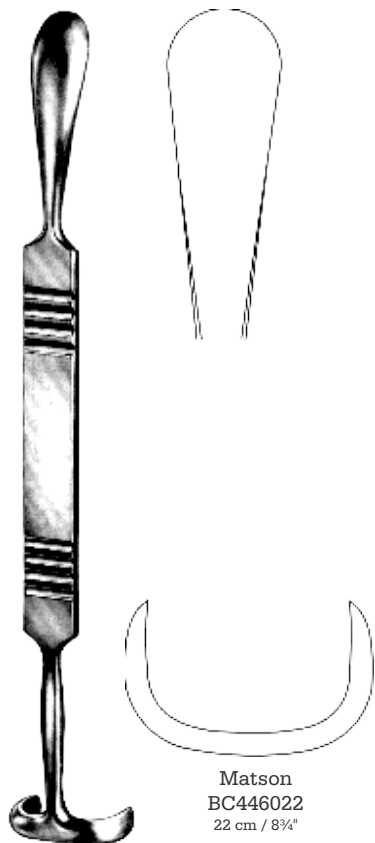

Matson
 BC446022
 22 cm / 8 3/4"

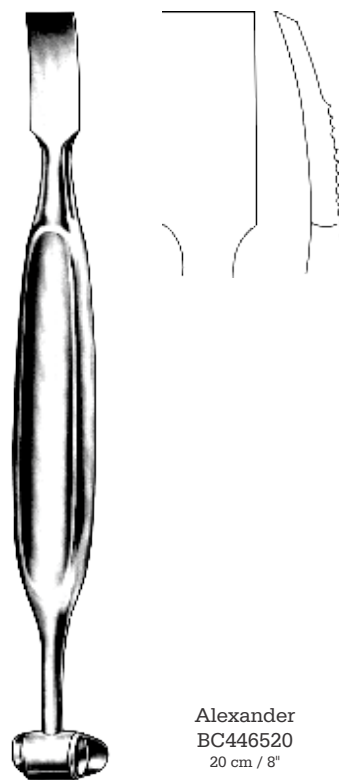

Alexander
 BC446520
 20 cm / 8"



Semb



BC447017
 17.5 cm / 7"



BC447121
 21 cm / 8 1/4"



BC447217
 17.5 cm / 7"



BC447321
 21 cm / 8 1/4"



BC447420
 20.5 cm / 8"



Orthopedic
 Periosteal Elevators
 Raspatorien
 Periostotomos, Legras



Doyen
 17 cm / 6 3/4"

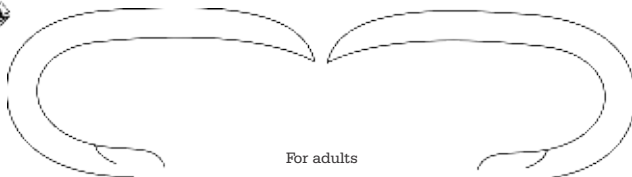

BC448017
 Right

BC448117
 Left

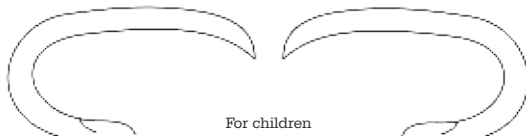

BC448217
 Right

BC448317
 Left



Williger
 BC448513
 13 cm / 5"
 5 mm

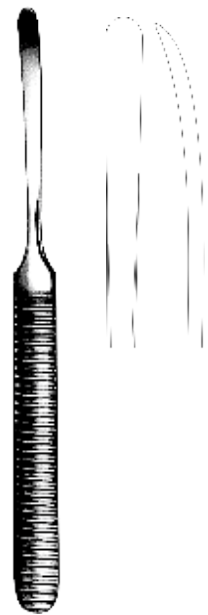

Williger
 BC449016 4 mm
 BC449116 5 mm
 BC449216 6 mm
 BC449316 7 mm
 16 cm / 6 1/4"

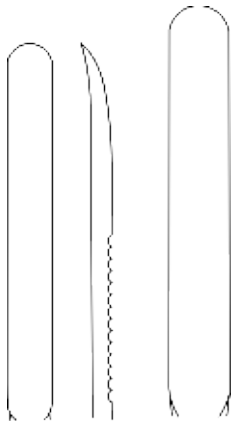

BC449517
 6 mm

BC449617
 8 mm



Lambotte
 21 cm / 8 1/4"



BC450121
 10 mm



BC450221
 15 mm

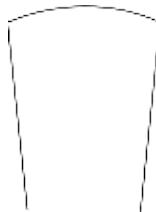

BC450321
 20 mm



BC450421
 25 mm



5 mm



Konig
 BC450515
 15.5 cm / 6"

17 cm / 6 3/4"

Orthopedic
 Periosteal Elevators
 Raspatorien
 Periostotomos

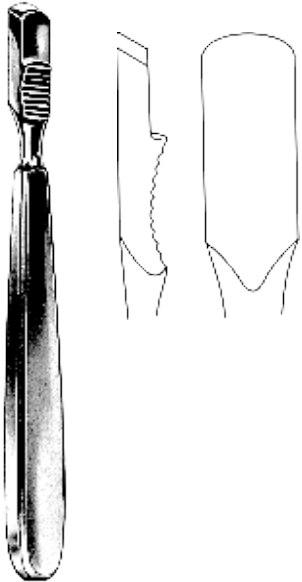

Farabeuf
 BC451015
 15 cm / 6"
 Straight

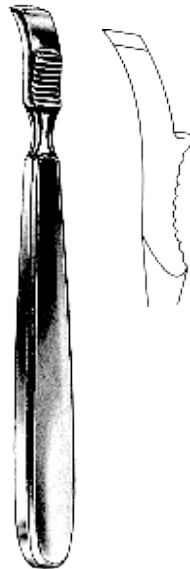

Farabeuf
 BC451515
 15 cm / 6"
 Curved

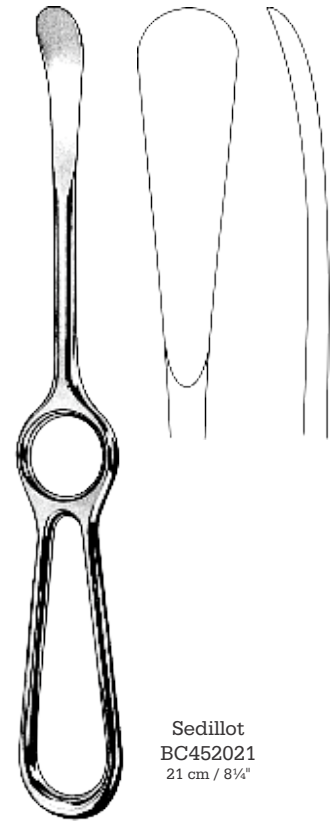

Sedillot
 BC452021
 21 cm / 8 1/4"



16 cm / 6 1/4"
 Delicate, Solid

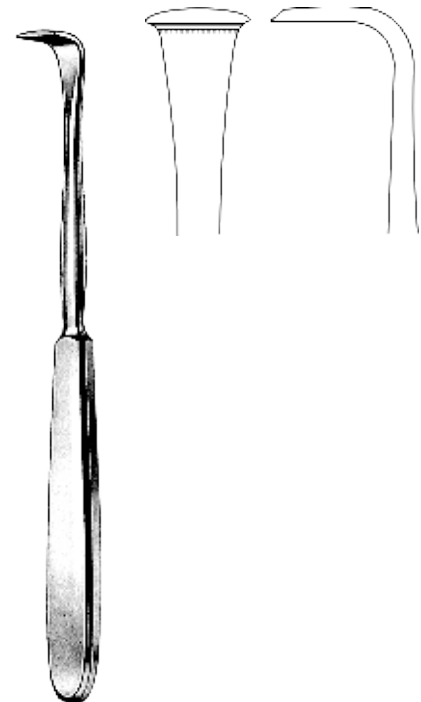

Langenbeck
 BC452518
 18 cm / 7"



Orthopedic
 Periosteal Elevators
 Raspatorien
 Periostotomos

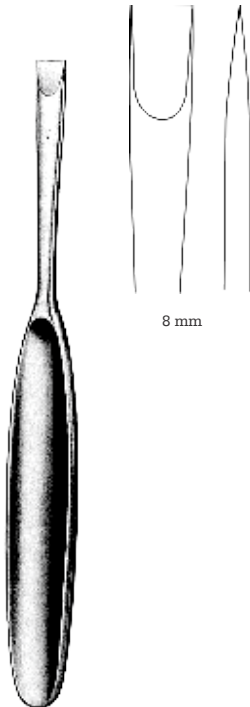

8 mm

Cushing
 BC453017
 17 cm / 6 3/4"



Cushing

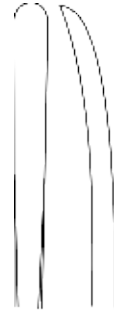

BC453517
 17 cm / 6 3/4"
 4 mm



BC453617
 17 cm / 6 3/4"
 6 mm



BC453719
 19.5 cm / 7 3/4"
 5 mm



BC453819
 19.5 cm / 7 3/4"
 7 mm



Langenbeck



BC454019
 19 cm / 7 1/2"
 16 mm



BC454119
 19 cm / 7 1/2"
 16 mm

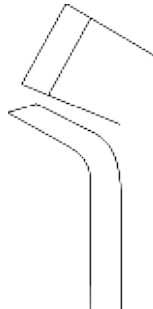

BC454219
 19 cm / 7 1/2"
 12 mm

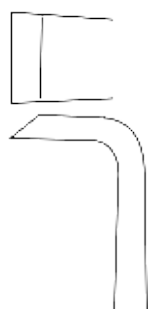

BC454318
 18 cm / 7"
 12 mm



Hoen



BC454516
 16 cm / 6 1/4"
 7 mm



BC454518
 18 cm / 7 1/4"
 15 mm



BC454520
 19 cm / 7 1/2"
 20 mm

Orthopedic
 Periosteal Elevators
 Raspatorien
 Periostotomos



Add "N" to the item code for Teflon Handle. Add "Z" to the item code for Ferrozell Handle.

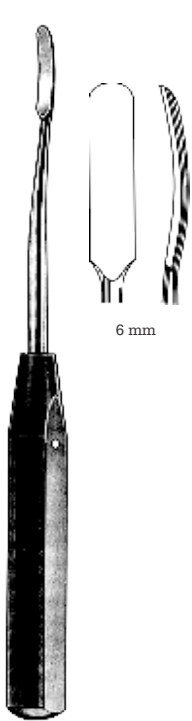

6 mm

BC455018
 18 cm / 7"
 Ferrozell handle

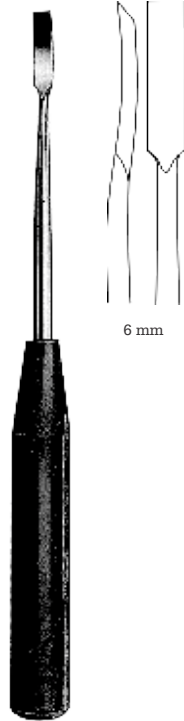

6 mm

BC455518
 18 cm / 7"
 Ferrozell handle

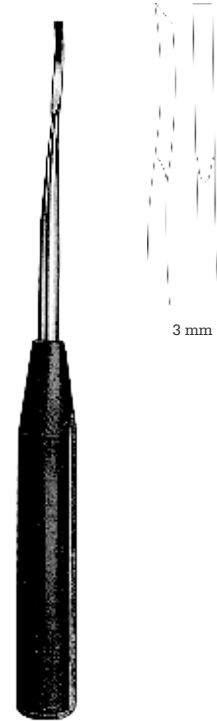

3 mm

BC456018
 18 cm / 7"
 Ferrozell handle

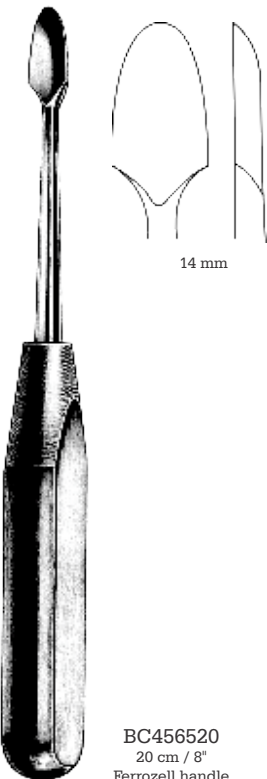

14 mm

BC456520
 20 cm / 8"
 Ferrozell handle

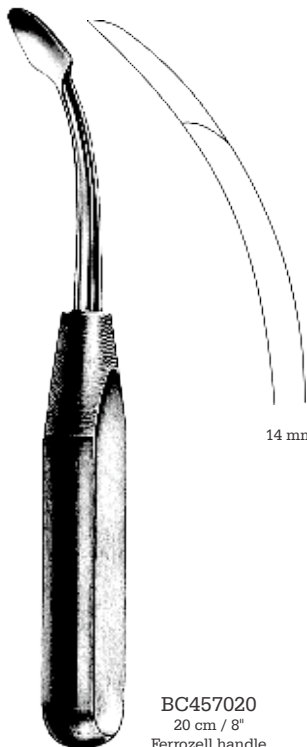

14 mm

BC457020
 20 cm / 8"
 Ferrozell handle

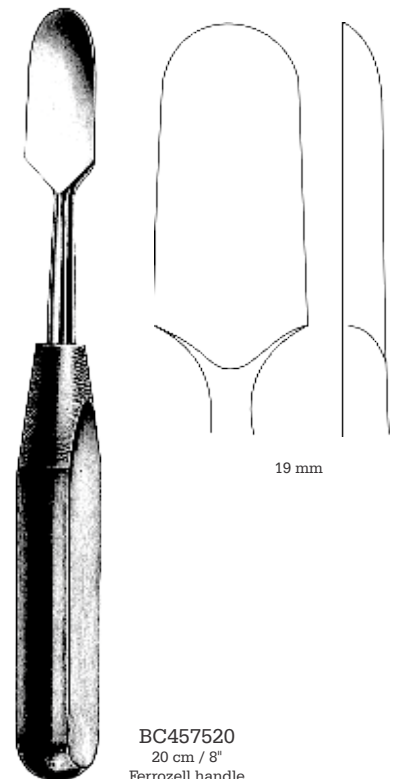

19 mm

BC457520
 20 cm / 8"
 Ferrozell handle



Orthopedic
Bone Levers
Knochenhebel
Elevadores para huesos

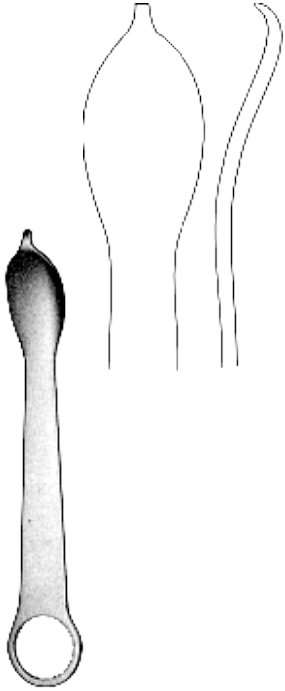

BC458000
16 mm

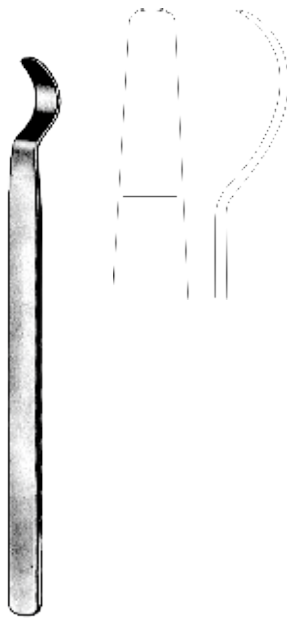

BC458514
14 cm / 5½"



BC459015
15 cm / 6"
5 mm

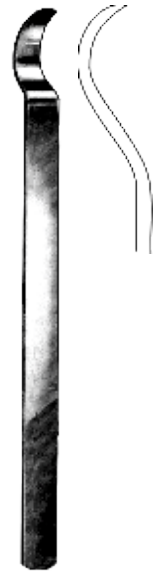

BC459515
15 cm / 6"
7 mm

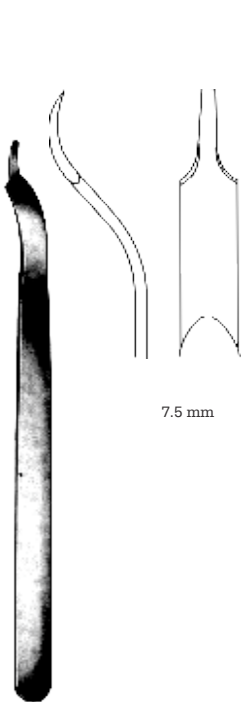

7.5 mm

Buck-Gramcko
BC460115
15 cm / 6"

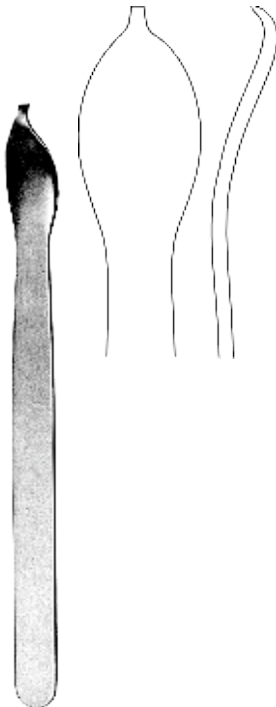

BC460500
15 mm

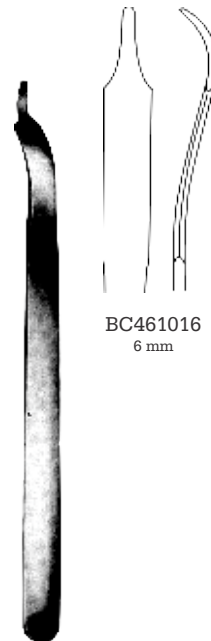

BC461016
6 mm

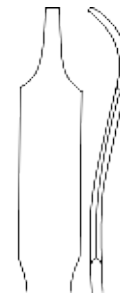

BC461116
8 mm

Mini-Hohmann
16 cm / 6¼"



Freer
BC461518
18.5 cm / 7¼"
Sharp/Blunt

Orthopedic
 Bone Levers
 Knochenhebel
 Elevadores para huesos

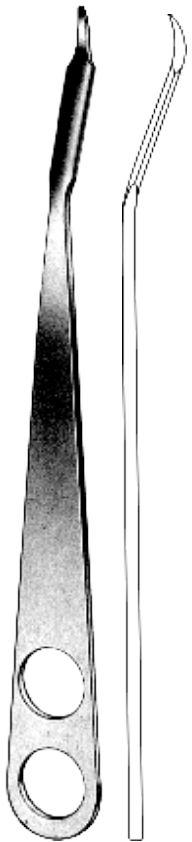

Hohmann
 BC462000
 22 cm / 8³/₄"
 8 mm

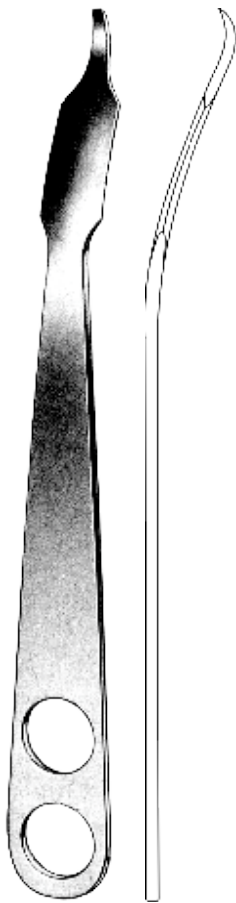

Hohmann
 BC462500
 23.5 cm / 9¹/₄"
 18 mm

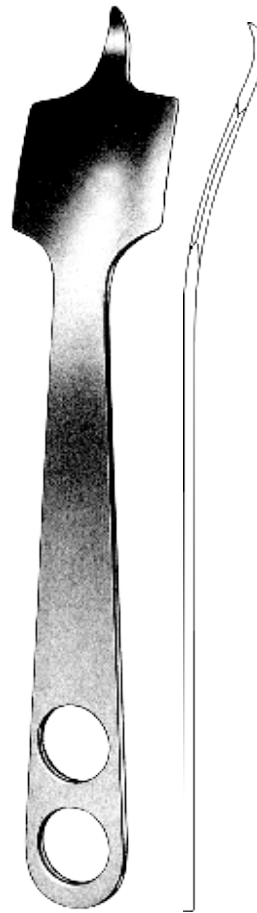

Hohmann
 BC463000
 23.5 cm / 9¹/₄"
 43 mm

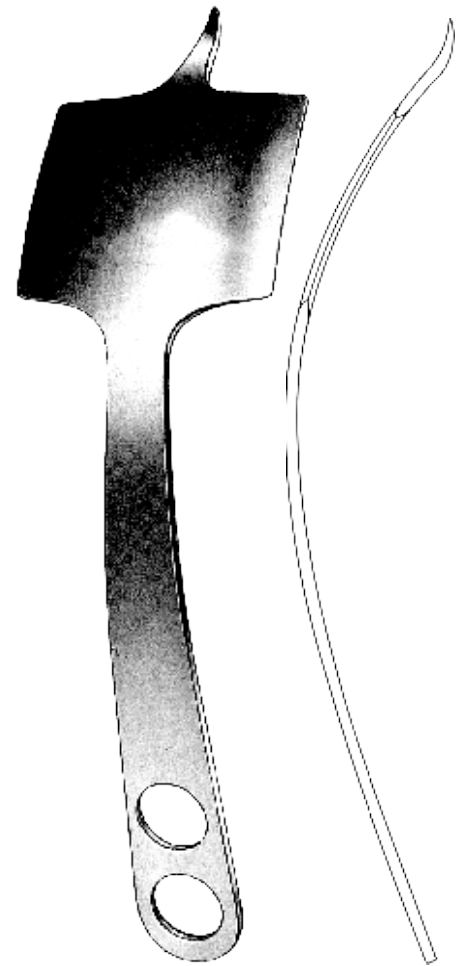

Hohmann
 BC463500
 23.5 cm / 9¹/₄"
 70 mm



Orthopedic
Bone Levers
Knochenhebel
Elevadores para huesos

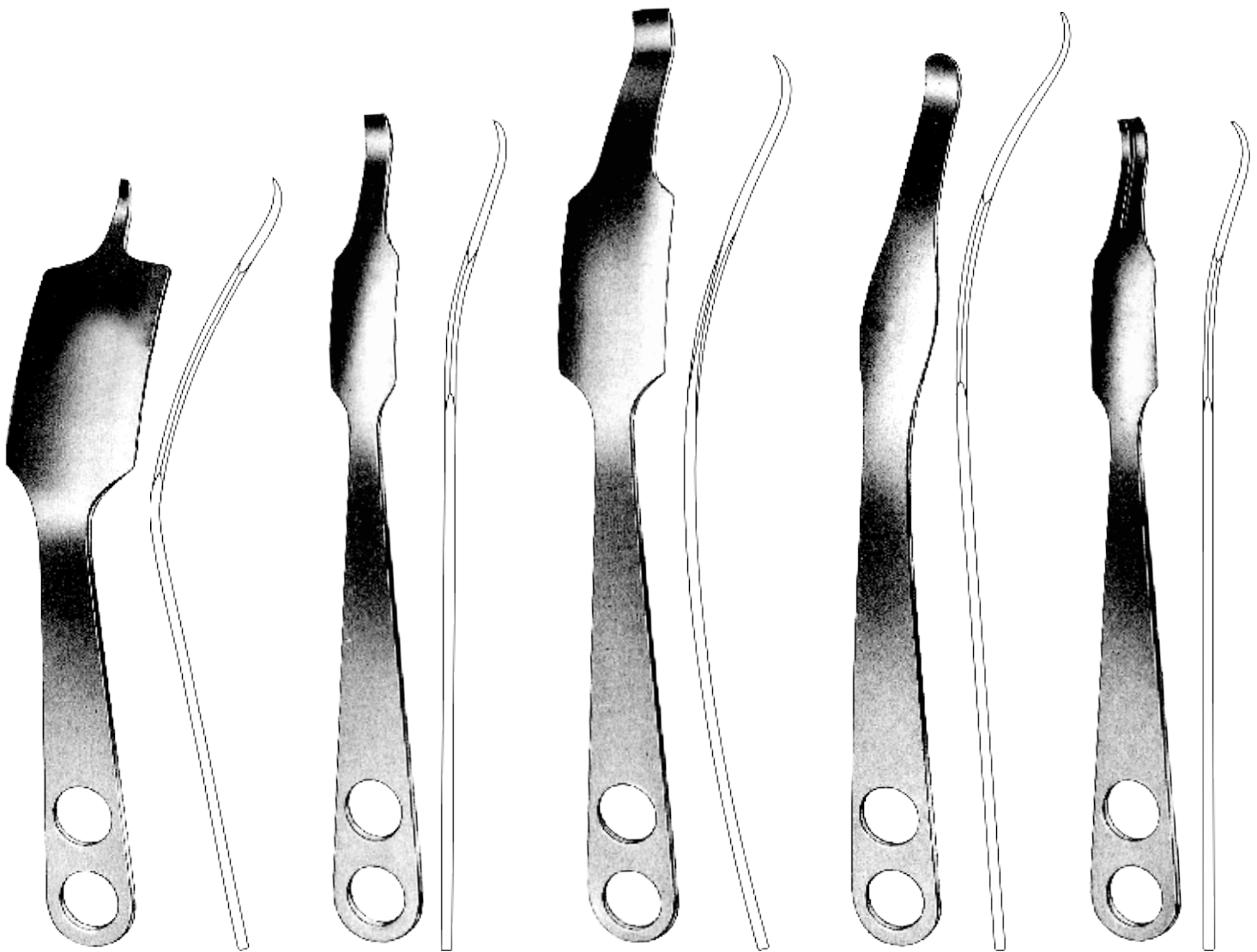

Hohmann
BC464000
23.5 cm / 9¼"
43 mm

Hohmann
BC464500
25.5 cm / 10"
22 mm

Hohmann
BC465000
29 cm / 11"
33 mm

Hohmann
BC465500
27.5 cm / 10¾"
24 mm

Lange-Hohmann
BC466000
25.5 cm / 10"
22 mm

Orthopedic

Bone Levers, Retractors

Knochenhebel, Wundhaken

Elevadores para huesos, Separadores

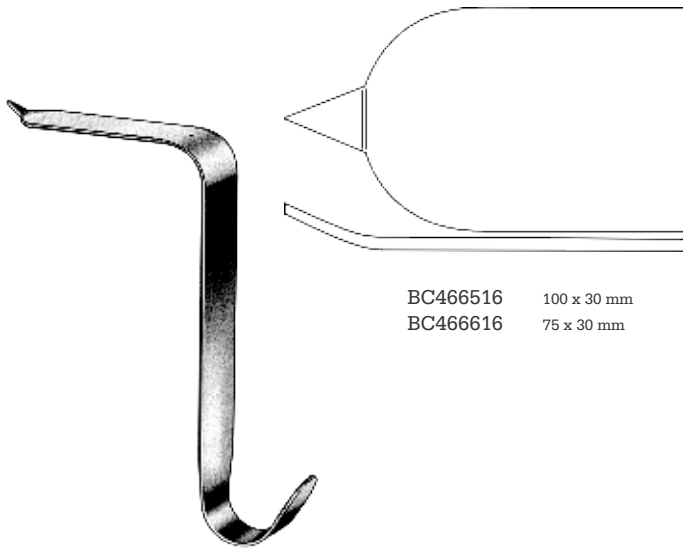

BC466516 100 x 30 mm
BC466616 75 x 30 mm

Taylor
16.5 cm / 6½"

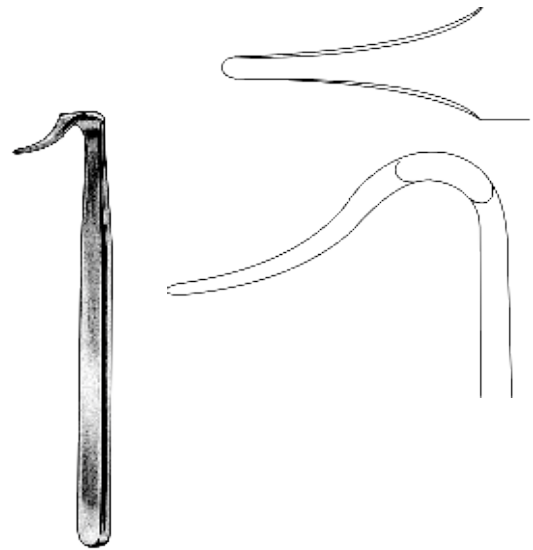

Blount
BC467017
17.5 cm / 7"



Bennett
BC467524 Small
BC467624 Large
24 cm / 9½"



Blount
BC468026
26 cm / 10¼"



Blount
BC468526
26 cm / 10¼"
Blunt



Orthopedic
Meniscotomy Knives
Meniskotome
Bisturies para meniscos

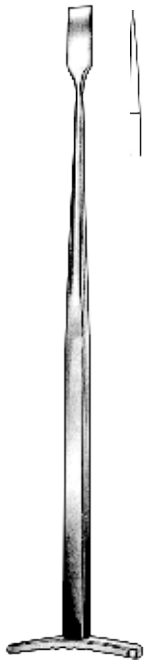

Smillie
BC469017
17 cm / 6 $\frac{3}{4}$ "

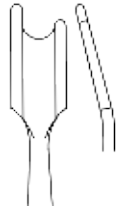

BC469117
Curved left



BC469217
Curved right



17 cm / 6 $\frac{3}{4}$ "



BC469517



BC469617



Bircher
19 cm / 7 $\frac{1}{2}$ "



BC470119



BC470219



Salenius
BC470522
22 cm / 8 $\frac{3}{4}$ "



Salenius
BC471022
22 cm / 8 $\frac{3}{4}$ "

Orthopedic
Meniscotomy Knives
Meniskotome
Bisturies para meniscos

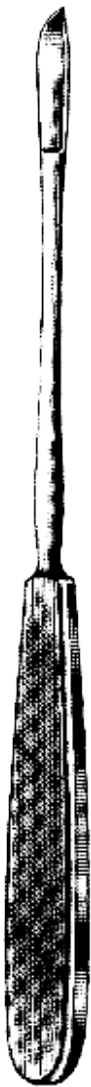

BC471522



BC471622



BC472018
18 cm / 7"

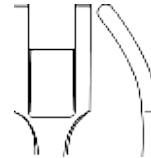

Lowe-Breck
BC472525
25 cm / 10"

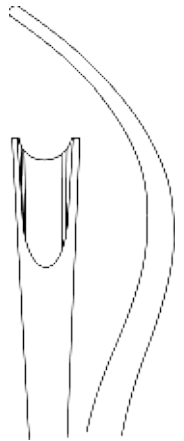

Downing
BC473025
25 cm / 10"



Orthopedic
Tendon Seizing Instruments
Sehnenfabinstrumente
Instrumentos para coger tendones

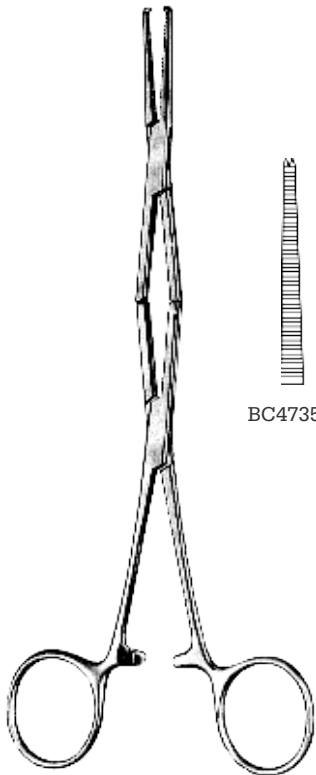

20 cm / 8"



BC473520



BC473620

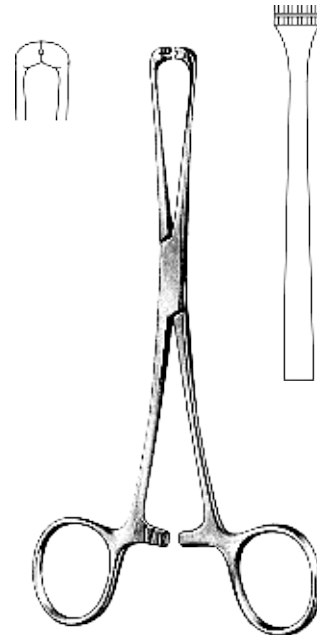

Steinmann
BC474016
16 cm / 6 1/4"

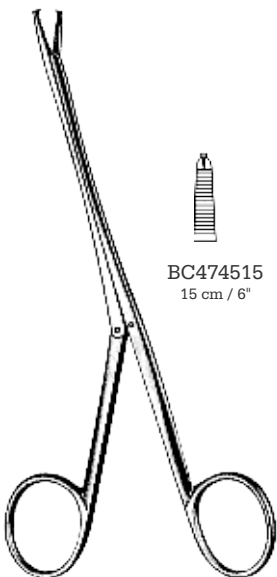

Brand



BC474515
15 cm / 6"



BC474519
19 cm / 7 1/2"



BC474524
24 cm / 9 1/2"



10 cm / 4"



BC475010
1.5 mm



BC475110
2.5 mm



BC475210
4.5 mm



BC475310
5.5 mm

Orthopedic

Bone Holding & Reduction Forceps

Knochenhalte-
zangen

Pinzas para huesos

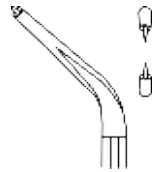
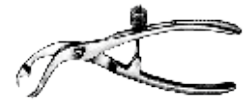

BC475509

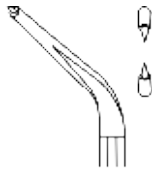

BC475609

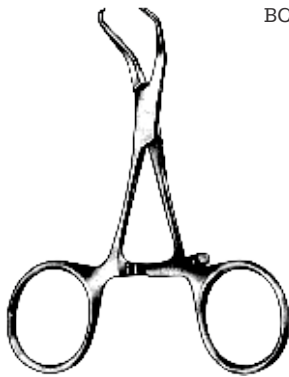

9.5 cm / 3 3/4"
Reposition forceps
with stepped tips

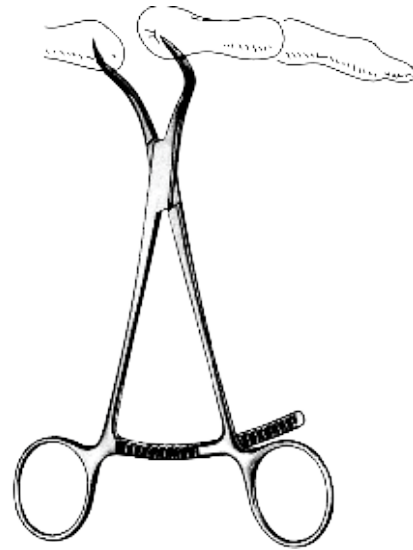

BC476013
13.5 cm / 5 1/2"

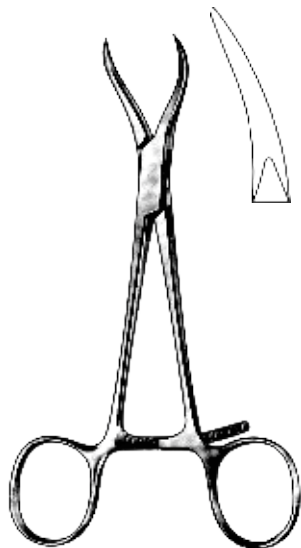

BC476513
13.5 cm / 5 1/4"
Reposition forceps,
especially for maxillary reposition

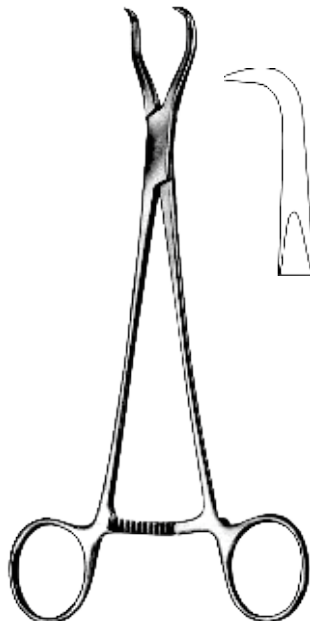

Haase
BC477016
16.5 cm / 6 1/2"
Reposition forceps
for mandibular fractures

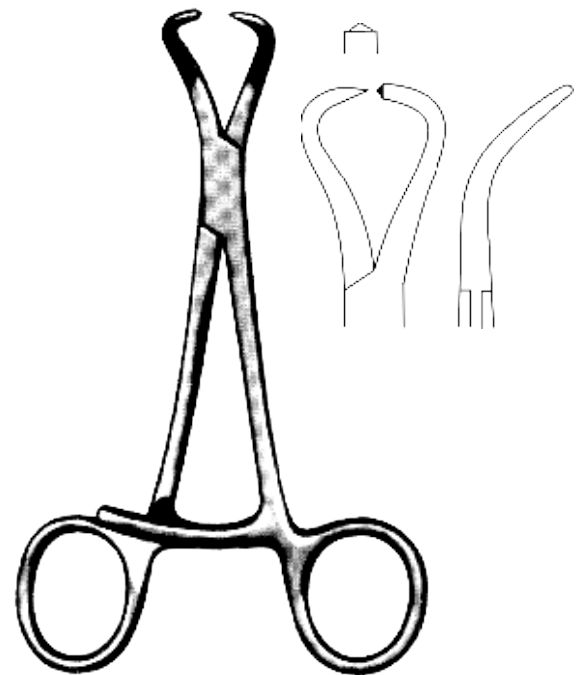

BC477514 14 cm / 5 1/2"
BC477516 16.5 cm / 6 1/2"
Curved
Bone reduction forceps



Orthopedic
Bone Holding & Reduction Forceps
Knochenhaltezaugen
Pinzas para huesos

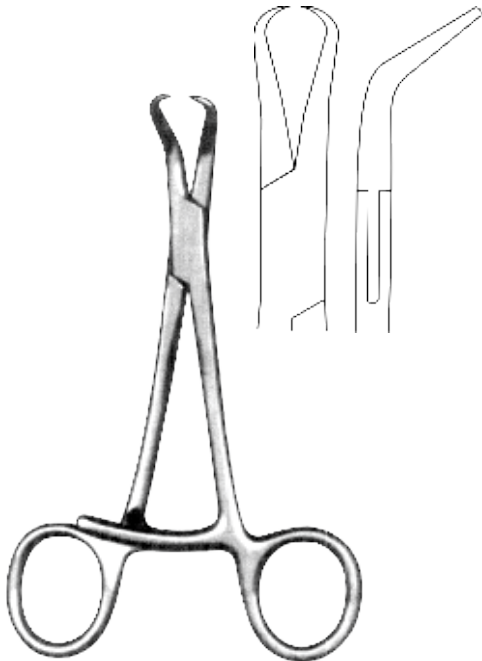

Stagbeetle
BC478012
12 cm / 4 3/4"
Bone reduction forceps
Curved, pointed tips

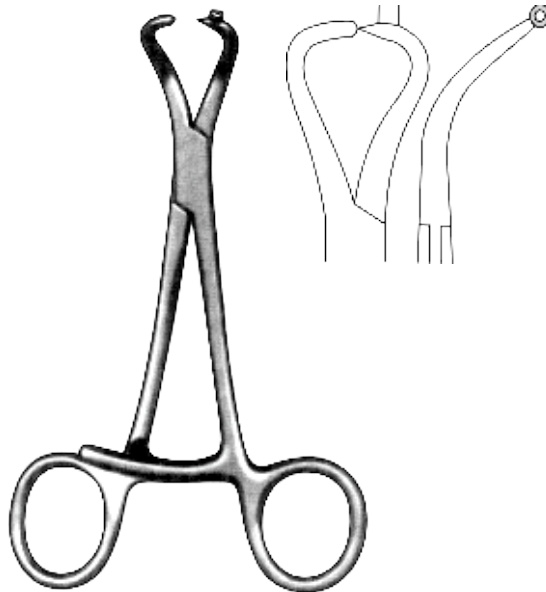

BC478513
13 cm / 5 1/4"
Bone holding forceps
Curved, with 1.6 mm k-wire guide

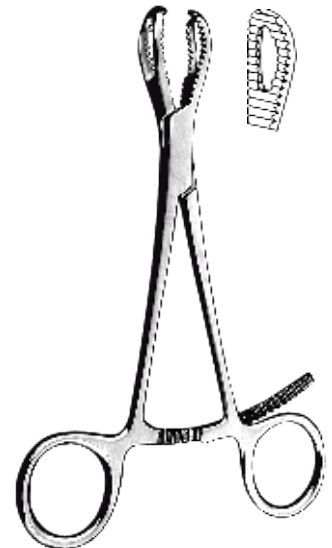

BC479000
Bone holding forceps

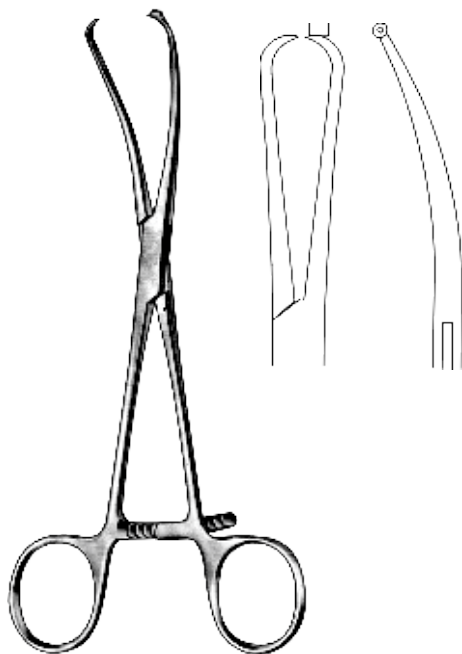

BC479517
17 cm / 6 3/4"
Bone holding forceps
Curved, with 1.1 mm k-wire guide

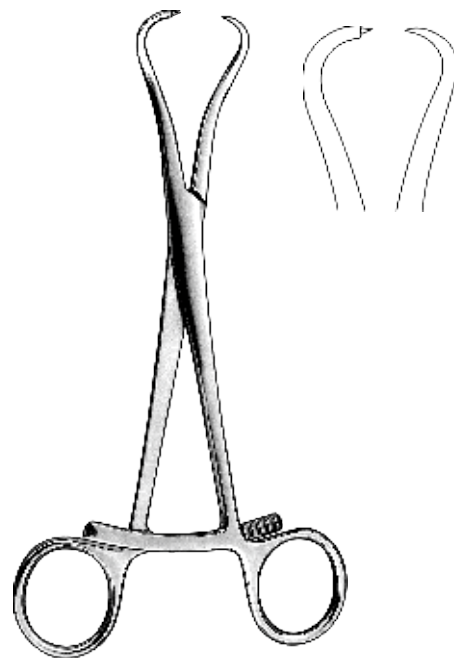

BC480015 15 cm / 6"
BC480017 17.5 cm / 7"
BC480020 20 cm / 8"

Orthopedic

Bone Holding & Reduction Forceps

Knochenhaltezaugen

Pinzas para huesos

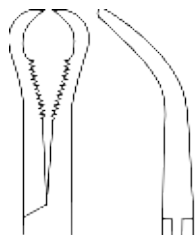
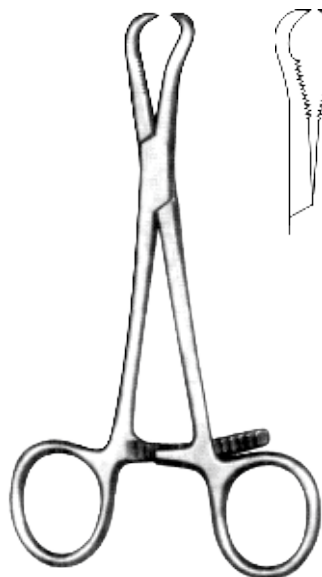

BC480512
12.5 cm / 5"

Bone holding forceps
Serrated with pointed tips
curved

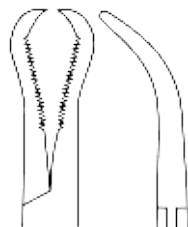

BC480514
14 cm / 5½"

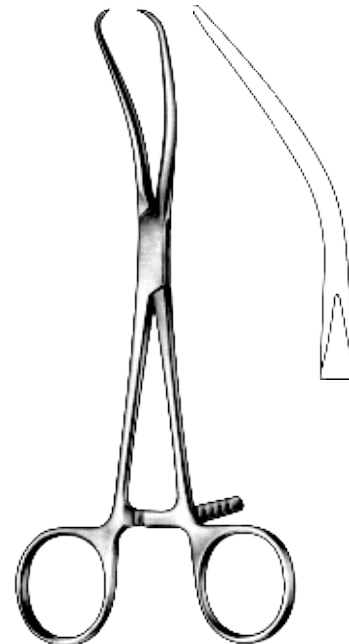

Reill
BC481017
17.5 cm / 7"
Bone reposition forceps
curved, pointed tips

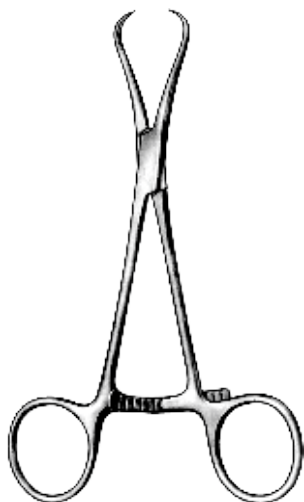

Steinhauser
BC481513
13 cm / 5"

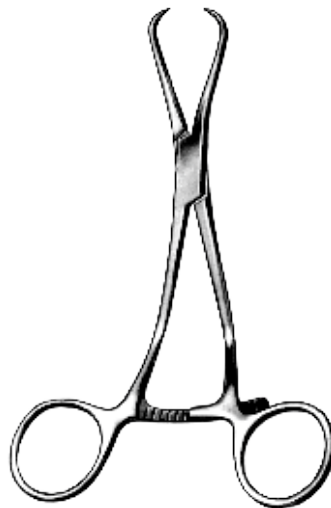

Steinhauser
BC482013
13 cm / 5"

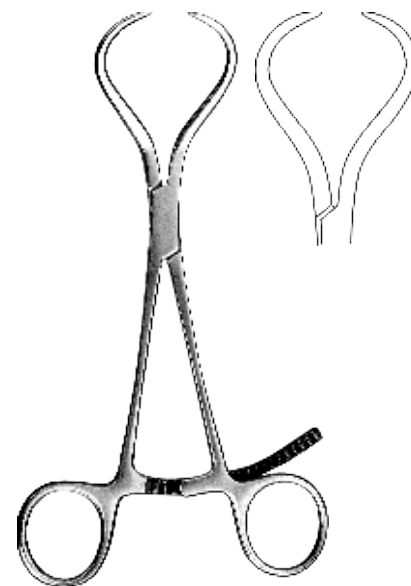

BC482516
16 cm / 6¼"
Bone fragment forceps



Orthopedic
Bone Holding & Reduction Forceps
Knochenhaltezangen
Pinzas para huesos

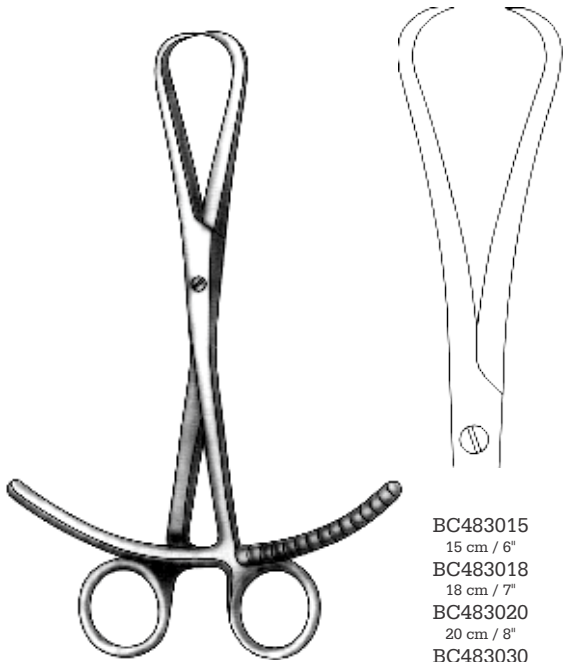

BC483015
 15 cm / 6"
 BC483018
 18 cm / 7"
 BC483020
 20 cm / 8"
 BC483030
 30 cm / 12"
 Bone reduction forceps

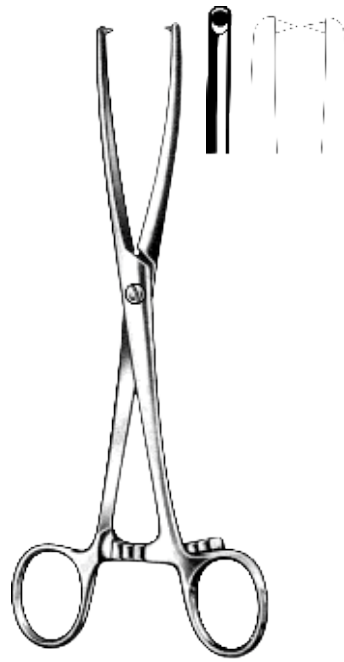

Malleolar
 BC483521
 21 cm / 8 1/4"
 1 x 1 sharp points.
 Grasping forceps for small bones

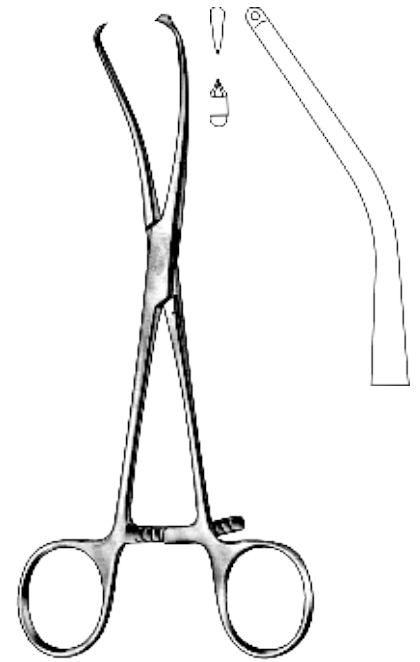

Meyer
 BC484017
 17 cm / 6 3/4"
 Reposition forceps for gers,
 with drill guide for Kirschner wires
 up to diameter 1.0 mm

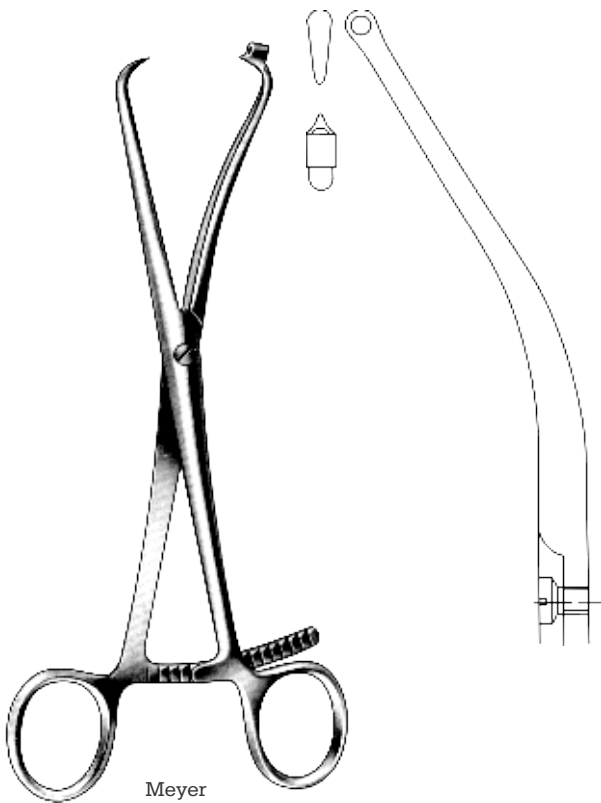

Meyer
 BC484520
 20.5 cm / 8"
 Reposition forceps
 with drill guide for kirschner
 wires up to diameter 2.0 mm

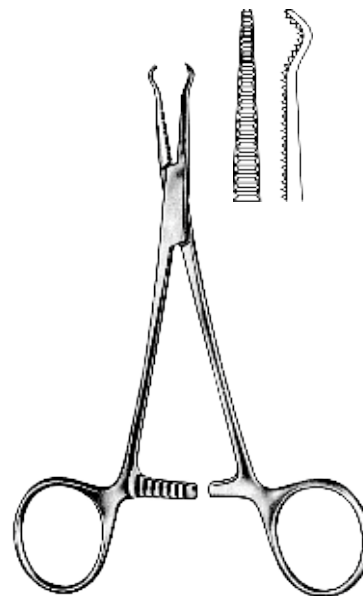

BC485014
 14 cm / 5 1/2"

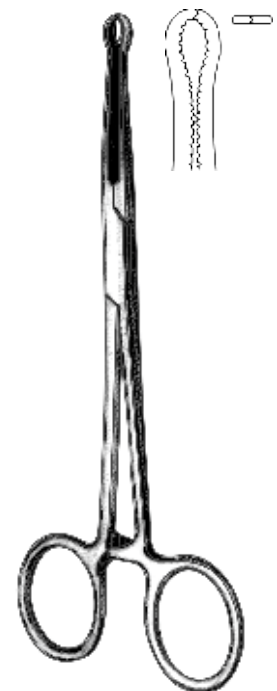

Locke
 BC485515
 15 cm / 6"
 Phalangeal forceps serrated jaws
 1:1 Teeth

Orthopedic

Bone Holding & Reduction Forceps

Knochenhaltezaugen

Pinzas para huesos

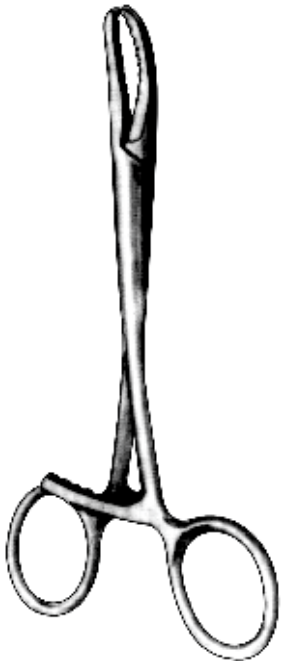

BC486014
14 cm / 5 1/4" small
Bone reduction forceps
curved, ratchet length 1 1/4"

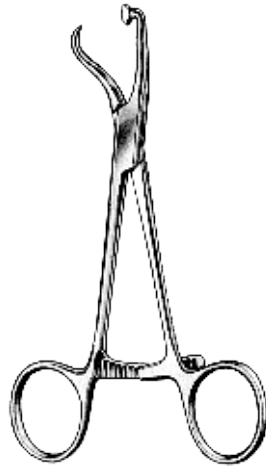

BC486512
12 cm / 4 3/4"



BC487014
14 cm / 5"
BC487019
19 cm / 7 1/2"

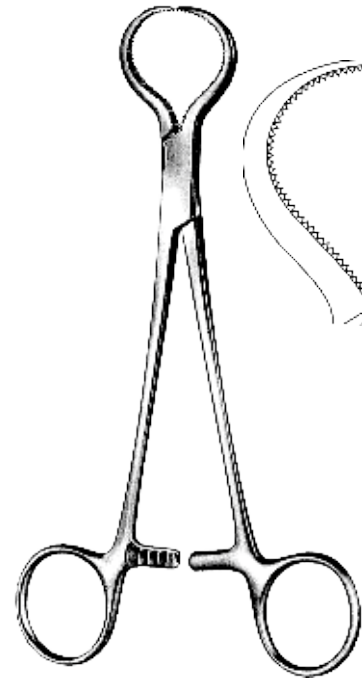

Lewin
BC487517
17.5 cm / 7"

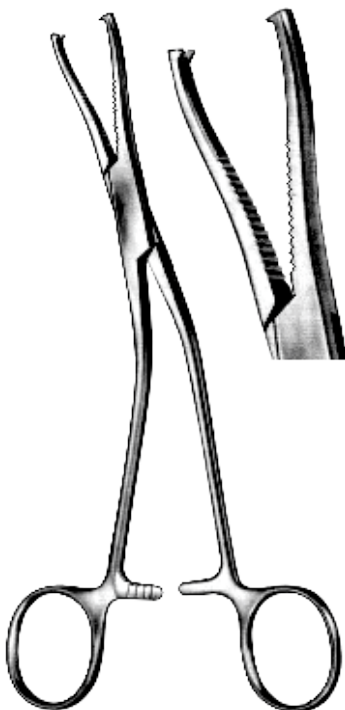
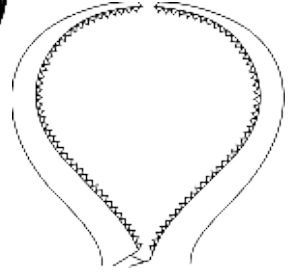

Dingmann
BC488018
18.5 cm / 7 1/4"

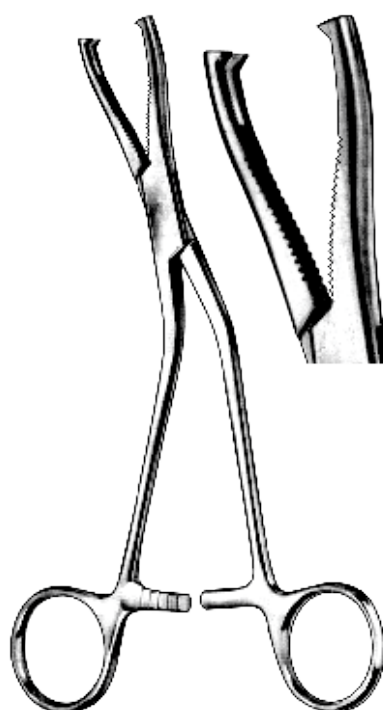

Dingmann
BC488518
18.5 cm / 7 1/4"

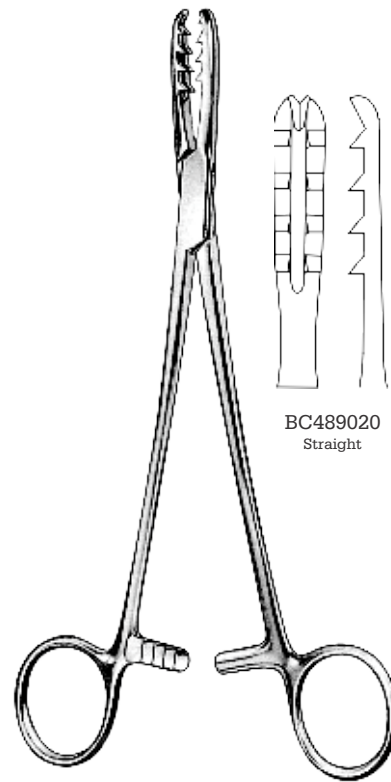

Bircher-Ganske
20 cm / 8"

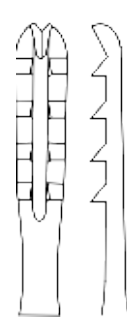

BC489020
Straight

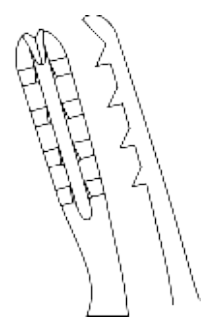

BC489120
Curved



Orthopedic
Bone Holding & Reduction Forceps
Knochenhaltezaugen
Pinzas para Huesos

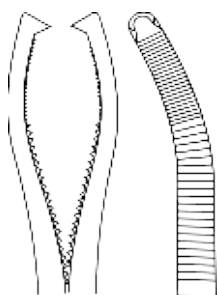

BC489518
Light pattern

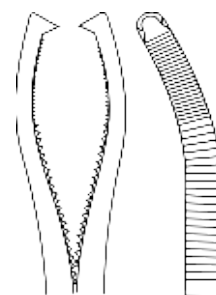

BC490118
Heavy pattern



Jeter Van Sickels
18 cm / 7"
For sagittal split procedure

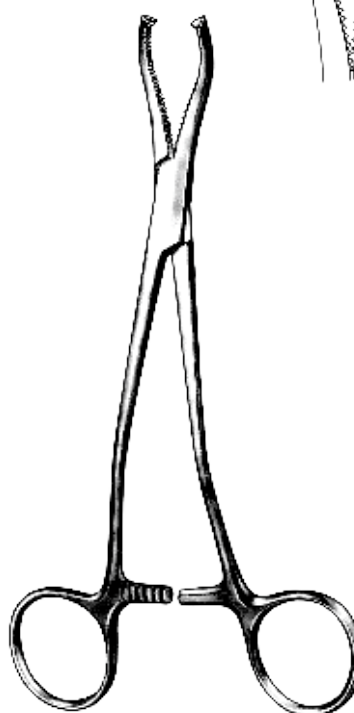

Jeter Van Sickels
18 cm / 7"
For sagittal split procedure

Orthopedic
 Bone Holding Forceps
 Knochenhalte­zangen
 Pinzas para huesos

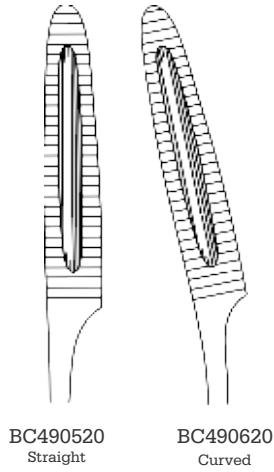
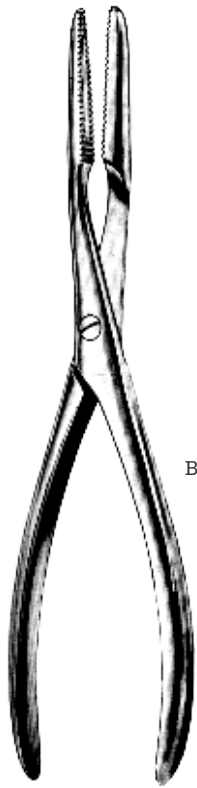

BC490520
 Straight

BC490620
 Curved

Requestrum
 20 cm / 8"



Van Buren
 BC491023
 23 cm / 9"

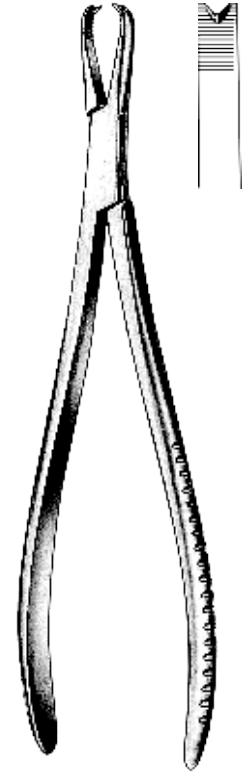

BC491520
 20 cm / 8"

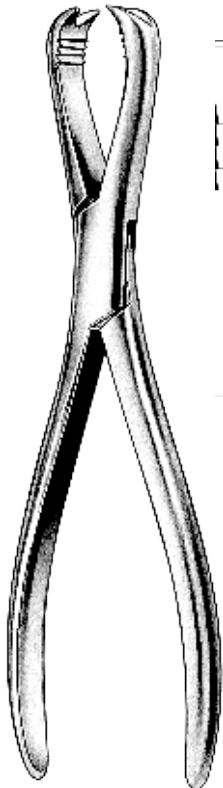

Langenbeck
 BC492021
 21 cm / 8 1/4"

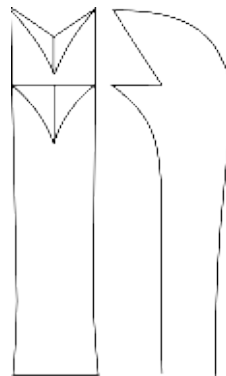
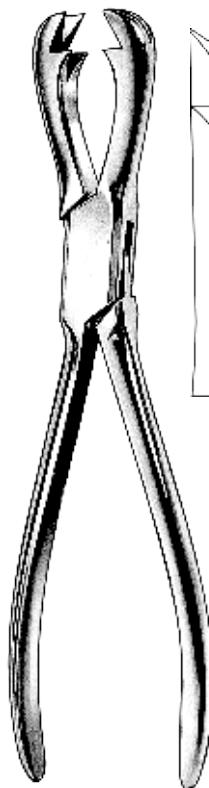

Fergusson
 BC492521
 21 cm / 8 1/4"

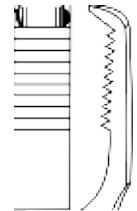
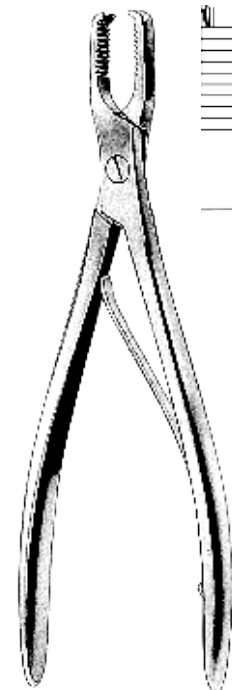

Frosch
 BC493018
 18 cm / 7"



Orthopedic
Bone Holding Forceps
Knochenhaltezaugen
Pinzas para huesos

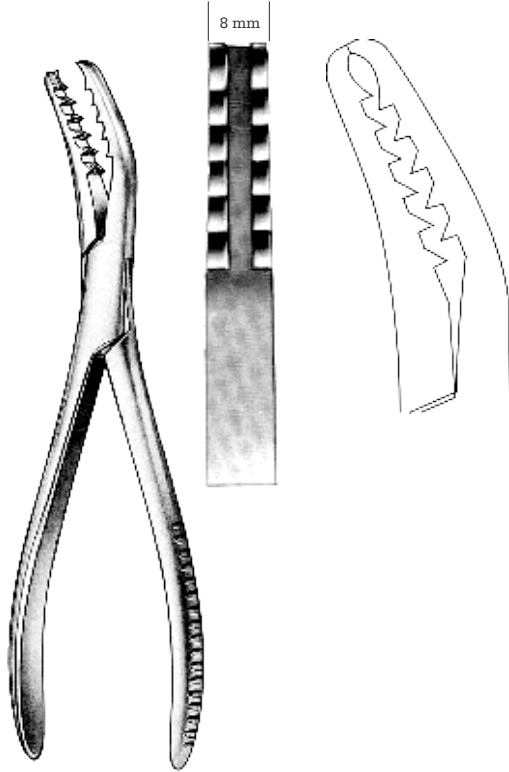

Semb
BC493519
19 cm / 7½"
Without ratchet

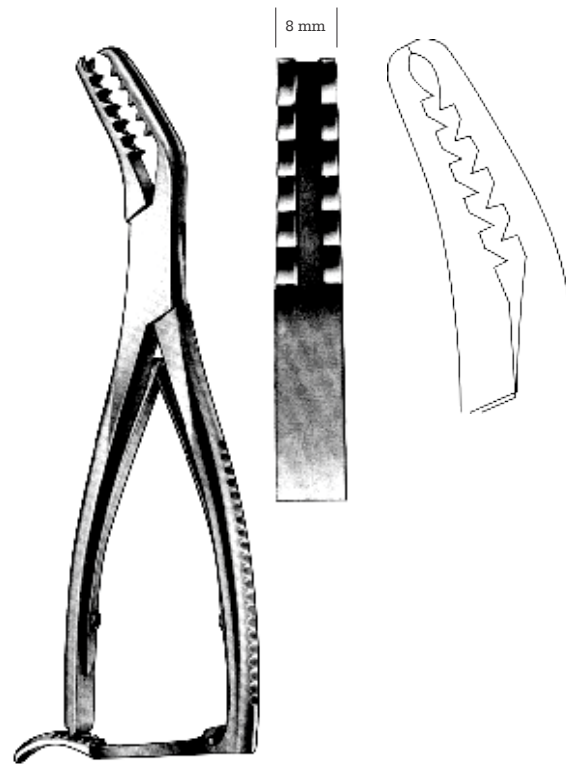

Semb
BC494019
19 cm / 7½"
Curved sideways
BC494020
20 cm / 8"
Deep teeth with ratchet



Kern
BC494512 12 cm / 4¾"
BC494515 15 cm / 6"
BC494517 17 cm / 6¾"
BC494521 21 cm / 8¼"
Without ratchet

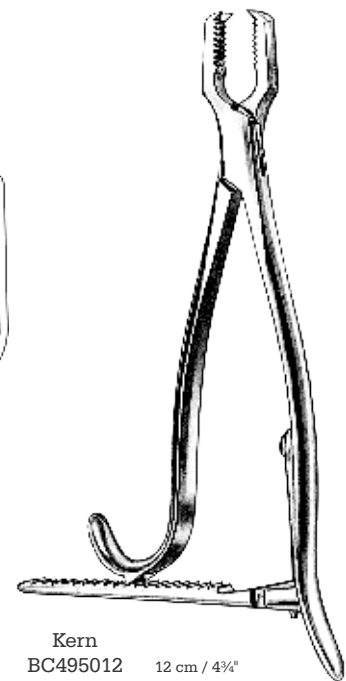
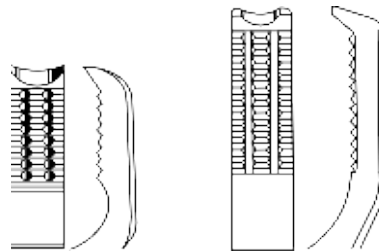

Kern
BC495012 12 cm / 4¾"
BC495015 15 cm / 6"
BC495017 17 cm / 6¾"
BC495021 21 cm / 8¼"
BC495023 23 cm / 9"
With ratchet

Orthopedic
Bone Holding Forceps
Knochenhalte­zangen
Pinzas para huesos

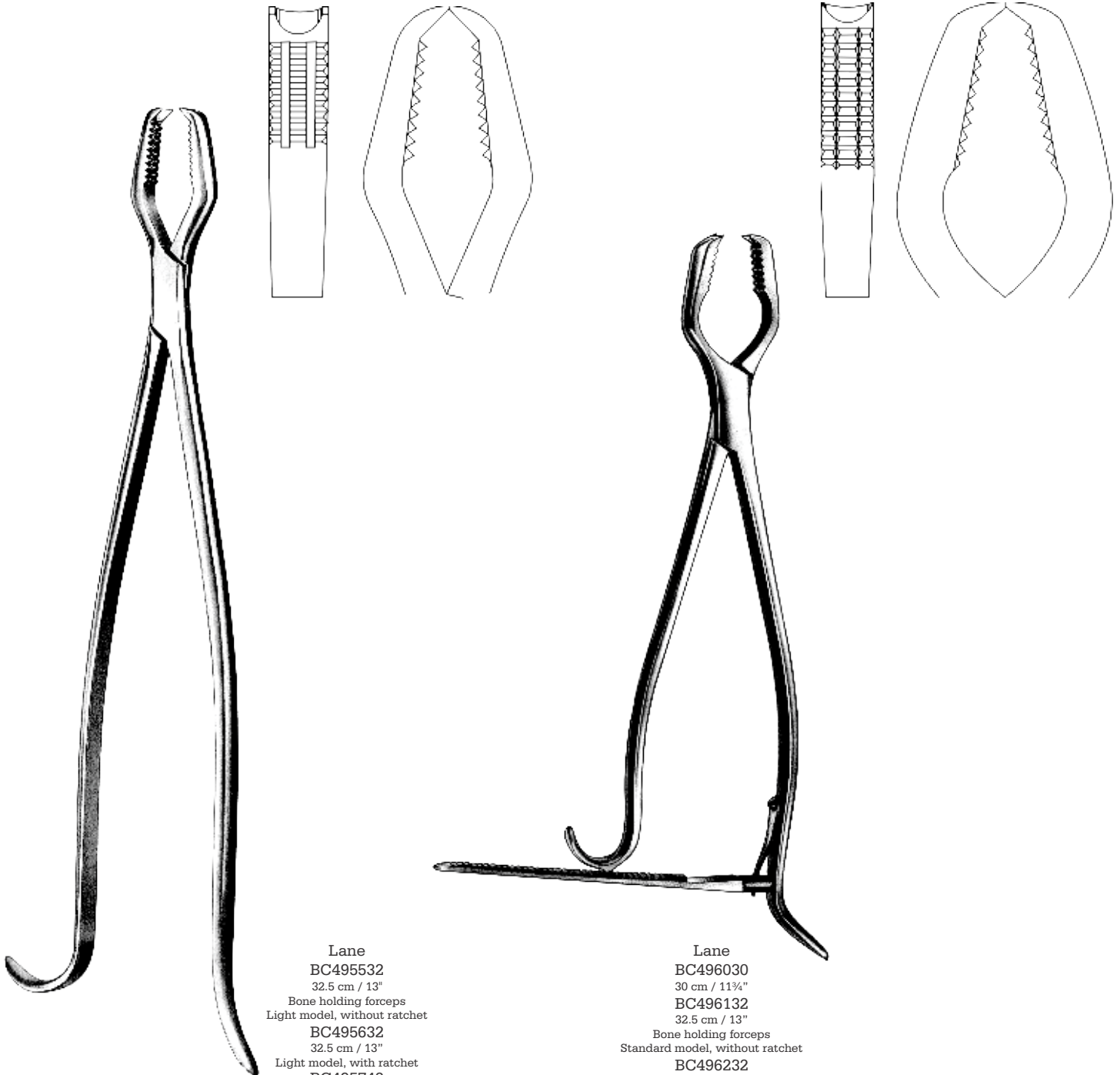

Lane
BC495532
32.5 cm / 13"
Bone holding forceps
Light model, without ratchet
BC495632
32.5 cm / 13"
Light model, with ratchet
BC495742
42.5 cm / 17"
Without ratchet

Lane
BC496030
30 cm / 11¾"
BC496132
32.5 cm / 13"
Bone holding forceps
Standard model, without ratchet
BC496232
32.5 cm / 13"
Standard model, with ratchet
BC496342
42.5 cm / 17"
With ratchet



Orthopedic
Bone Holding Forceps
Knochenhaltezaugen
Pinzas para huesos

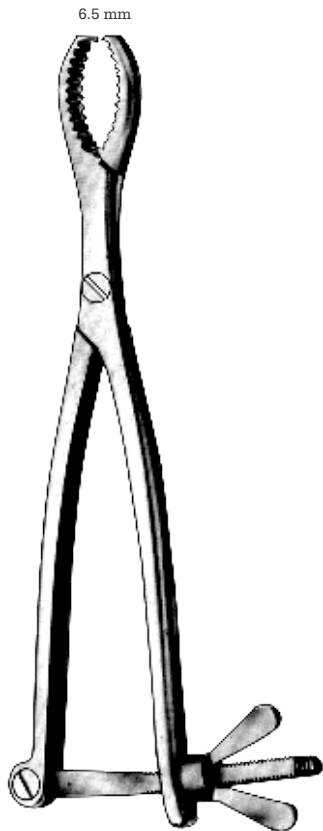

Hey Groves
BC496521
21 cm / 8 $\frac{1}{4}$ "



Hey Groves
BC497025 25 cm / 10"
BC497027 27 cm / 10 $\frac{3}{4}$ "



Hey Groves
BC497530
30.5 cm / 12"

Orthopedic
Bone Holding Forceps
Knochenhalte­zangen
Pinzas para huesos



Verbrugge
16 cm / 6 1/4"



BC498016
Both jaws serrated



BC498116
1 jaw serrated
1 jaw plain



Verbrugge Prehenseur
BC498518 18 cm / 7"
BC498524 24 cm / 9 1/2"
BC498526 26 cm / 10 1/4"
BC498528 28 cm / 11"
Serrated jaws



Orthopedic
Bone Holding Forceps
Knochenhaltezaugen
Pinzas para huesos

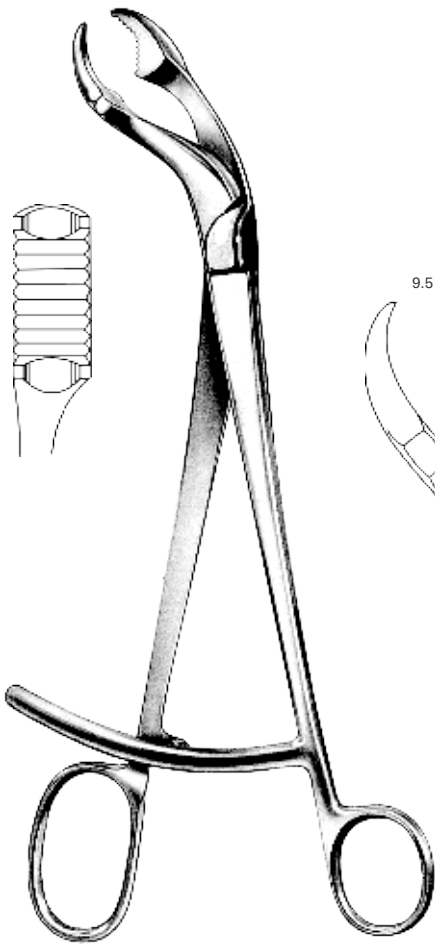

Verbrugge

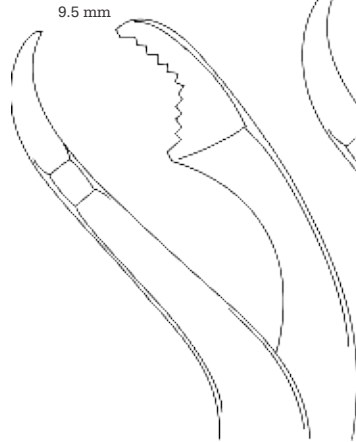

BC499025
25 cm / 10"

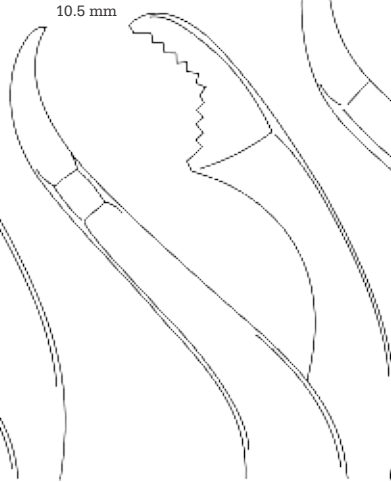

BC499026
26 cm / 10½"



BC499027
27 cm / 11"

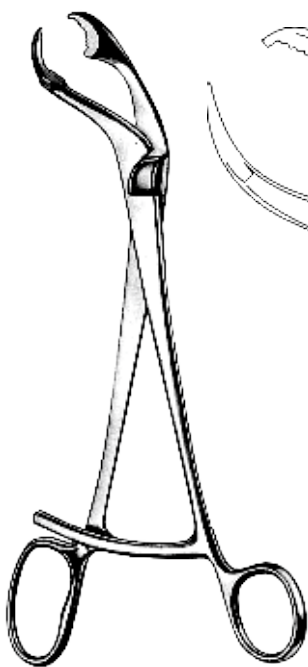

Verbrugge
17.5 cm / 6¾"
BC499517
BC499617
Screw joint

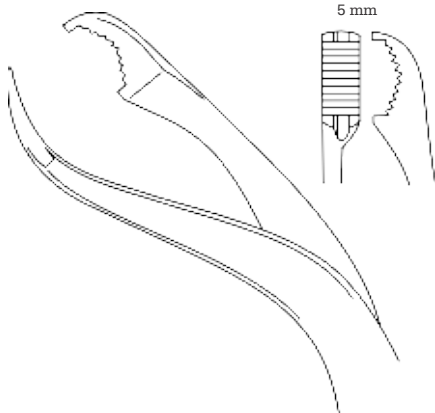

5 mm



Bishop
Adjustable jaw

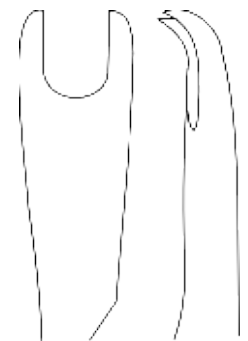

BC500123 23 cm / 9"
BC500132 32.5 cm / 13"

Orthopedic
 Bone Holding Forceps
 Knochenhalte­zangen
 Pinzas para huesos

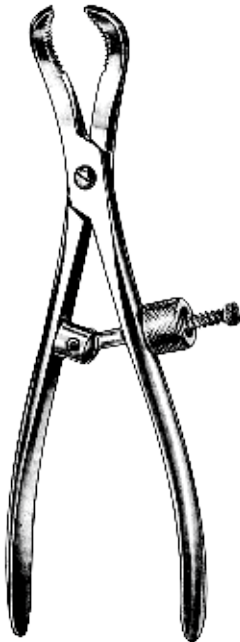

BC500516
 16 cm / 6 1/4"

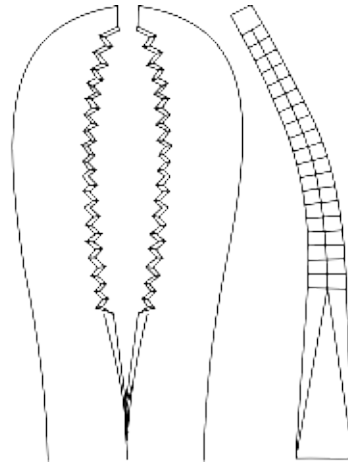
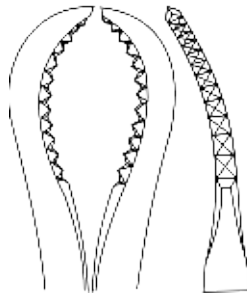

BC500524
 24 cm / 9 1/2"

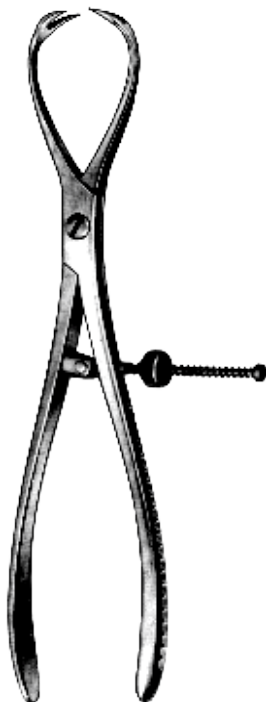

Patella Forceps
 BC501018
 18 cm / 7"
 2 x 2 sharp teeth
 with speed lock

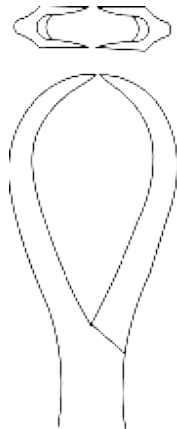

Ollier
 BC501519 19 cm / 7 1/2"
 BC501522 22 cm / 8 3/4"
 BC501527 27 cm / 10 3/4"



**Orthopedic
Bone Holding Forceps
Knochenhaltezaugen
Pinzas para huesos**

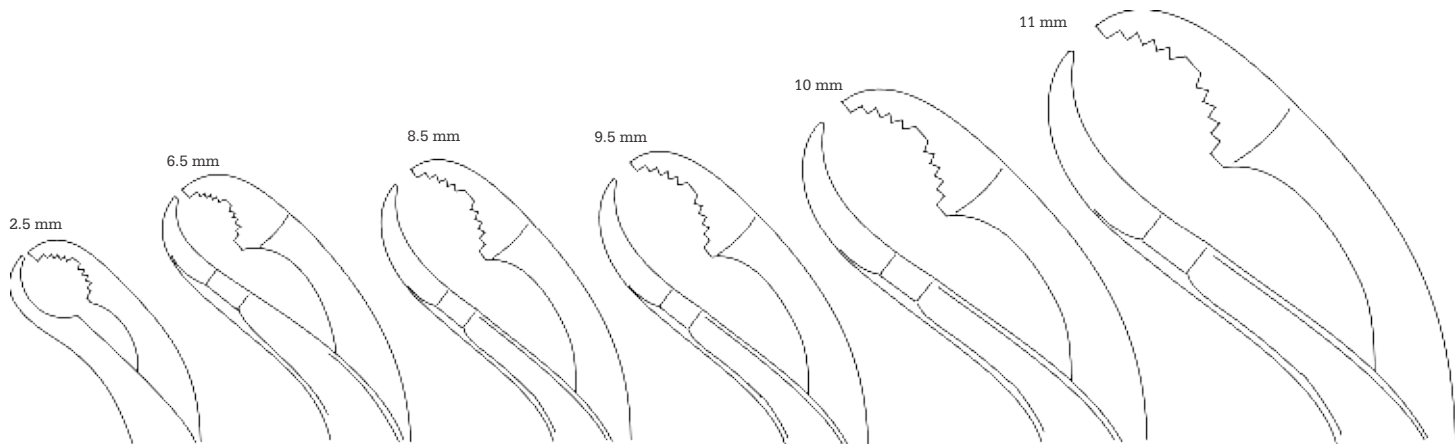

BC502515
Standard jaws
BC502615
Reverse jaws
BC502715
Moveable jaws
15 cm / 6"

BC502519
Standard jaws
BC502619
Reverse jaws
BC502719
Moveable jaws
19 cm / 7½"

BC502522
Standard jaws
BC502622
Reverse jaws
BC502722
Moveable jaws
22 cm / 8½"

BC502524
Standard jaws
BC502624
Reverse jaws
BC502724
Moveable jaws
24 cm / 9½"

BC502526
Standard jaws
BC502626
Reverse jaws
BC502726
Moveable jaws
26 cm / 10¼"

BC502528
Standard jaws
BC502628
Reverse jaws
BC502728
Moveable jaws
28 cm / 11"

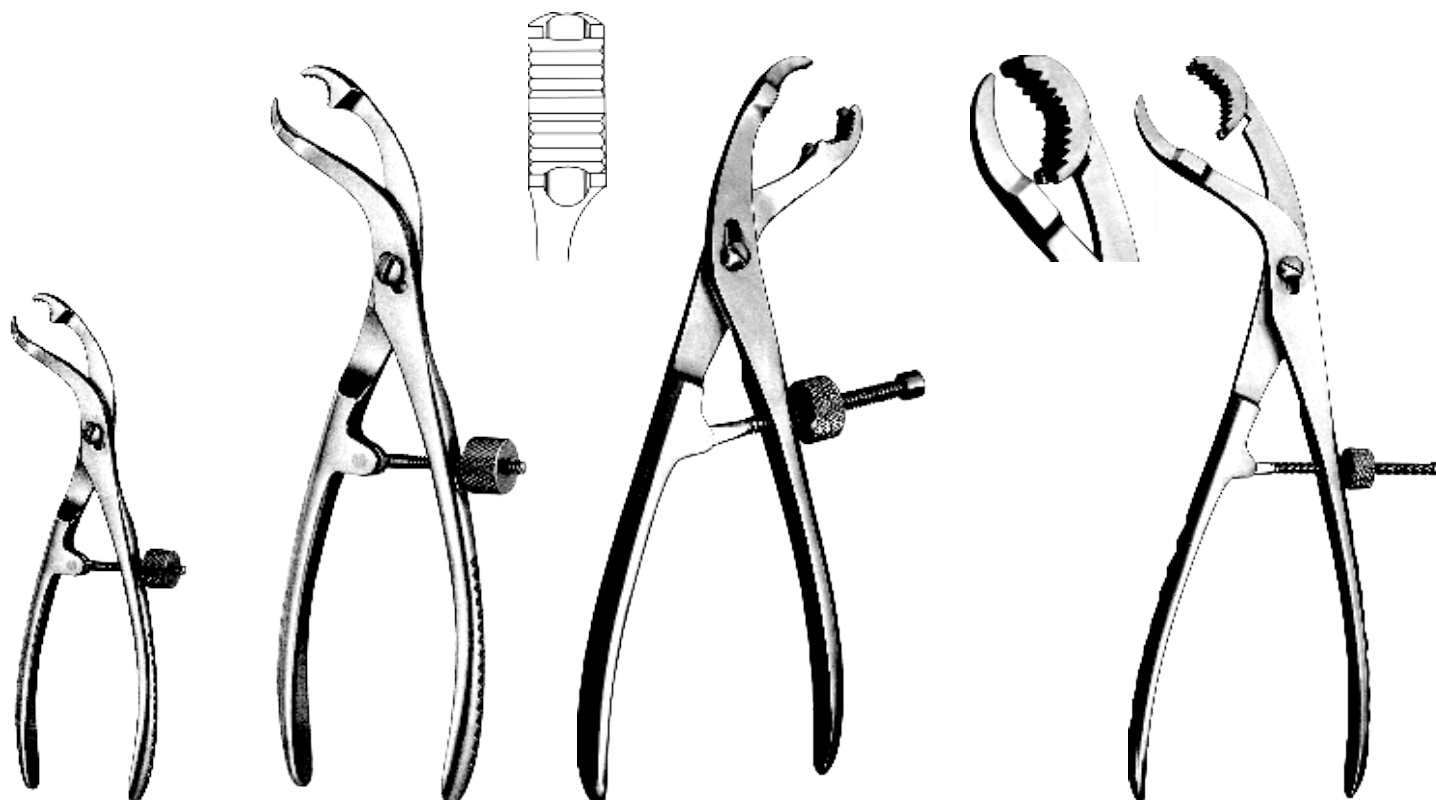

Mini
BC502012
12 cm / 4¾"
Special size

Self-Centering Forceps
Standard jaws

Self-Centering Forceps
With thread fixation
Reverse jaws

Verbrugge
28 cm / 11"
With moveable jaws

Orthopedic
 Bone Holding Forceps
 Knochenhaltezangen
 Pinzas para huesos

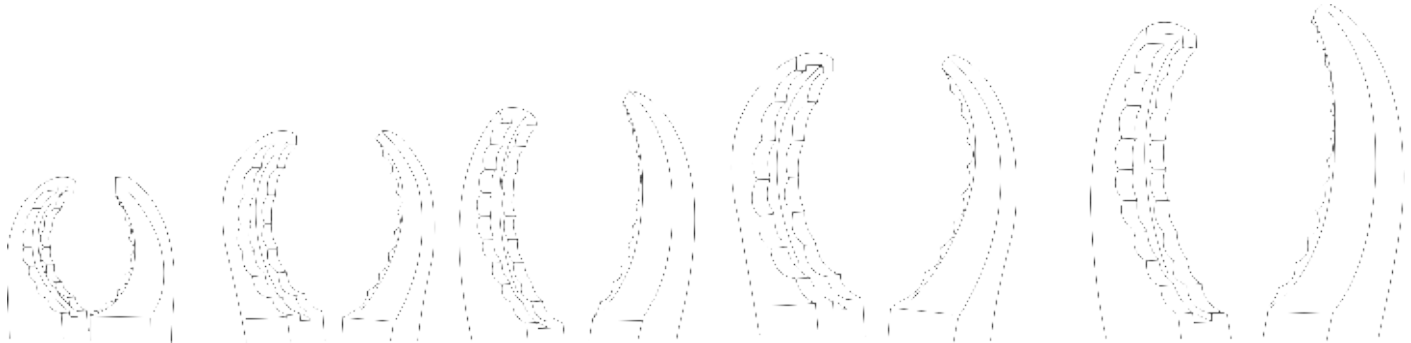

15 cm / 6"
Mini

18 cm / 7 1/4"

23 cm / 9"

25 cm / 10"

27 cm / 11"

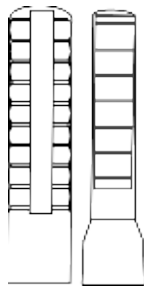
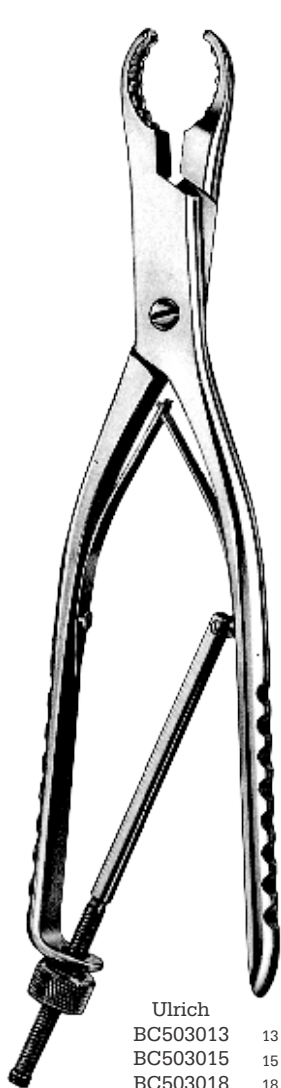

Ulrich
 BC503013 13 cm / 5", Mini
 BC503015 15 cm / 6"
 BC503018 18 cm / 7 1/4"
 BC503023 23 cm / 9"
 BC503025 25 cm / 10"
 BC503027 27 cm / 11"

Straight



Ulrich
 BC503513 13 cm / 5", Mini
 BC503515 15 cm / 6"
 BC503518 18 cm / 7 1/4"
 BC503523 23 cm / 9"
 BC503525 25 cm / 10"
 BC503527 27 cm / 11"

Angled

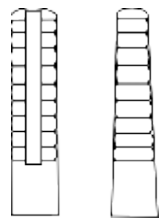
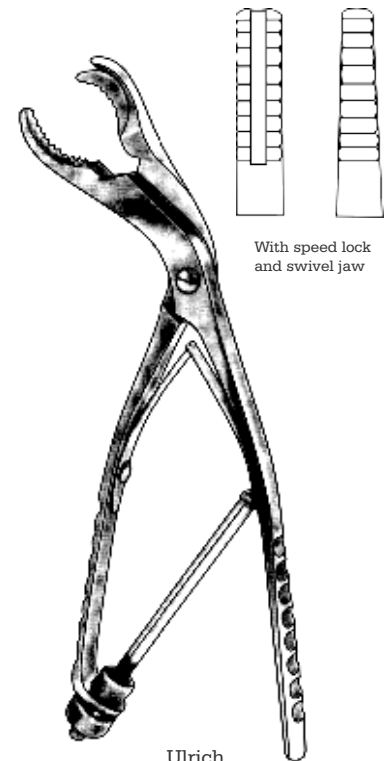

With speed lock
and swivel jaw

Ulrich
 BC504027
 27 cm / 11"
 Self-retaining forceps
 angular, moveable jaw



Orthopedic
Bone Holding Forceps
Knochenhaltezaugen
Pinzas para huesos

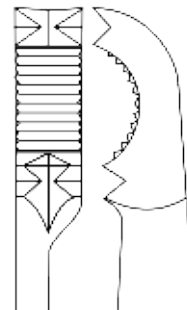
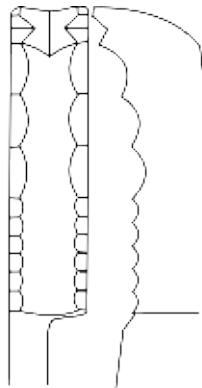
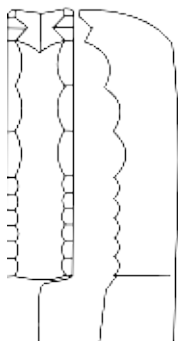

Farabeuf
BC504519 19 cm / 7½"
BC504523 23 cm / 9"
BC504526 26 cm / 10¼"
Adjustable

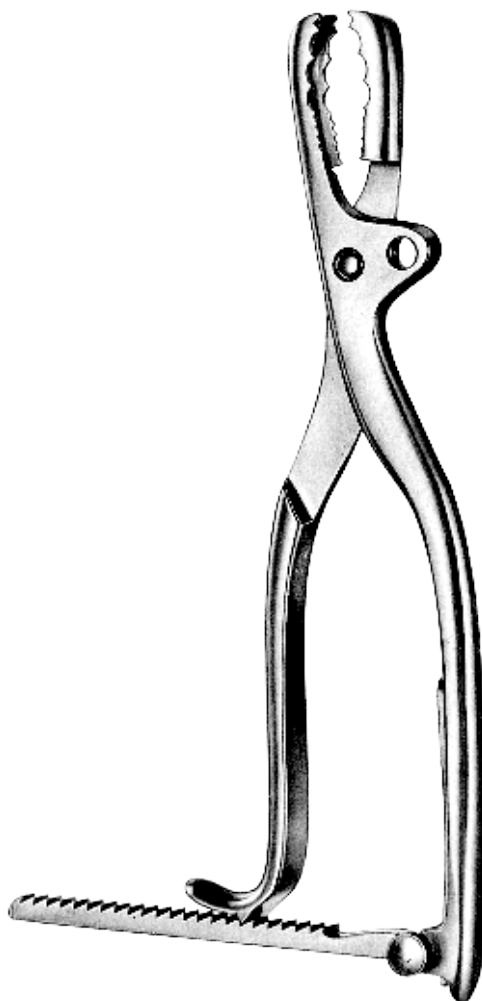

Farabeuf Lambotte
BC505019 19 cm / 7½"
BC505023 23 cm / 9"
BC505026 26 cm / 10¼"
Adjustable

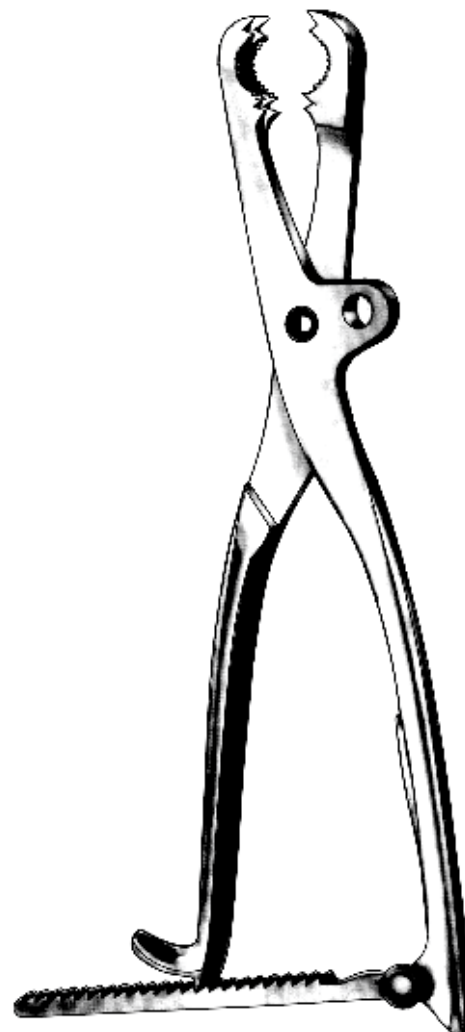

Tuffier
BC505527
27 cm / 10½"
Adjustable

Orthopedic
Bone Holding Forceps
Knochenhalte­zangen
Pinzas para huesos

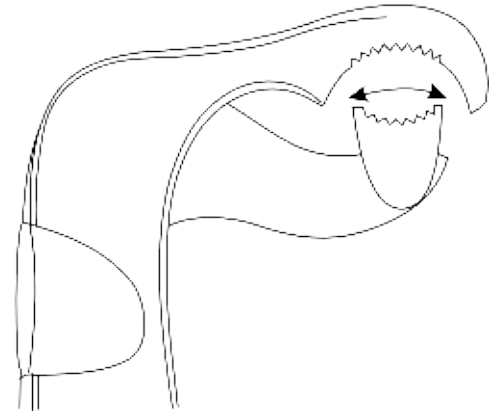
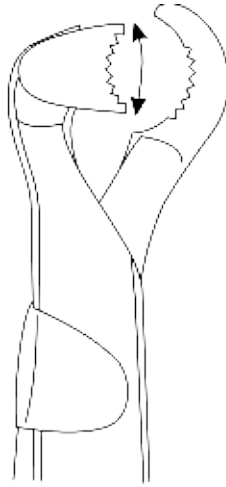
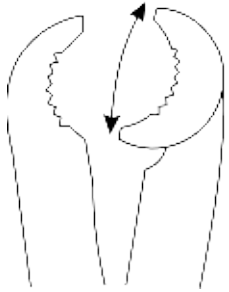

Lambotte
BC506022 22 cm / 8¾"
BC506027 27 cm / 10½"
BC506030 30 cm / 12"
Adjustable

Lambotte
BC506522 22 cm / 8¾"
BC506526 26 cm / 10¼"
BC506533 33 cm / 13"

Lambotte
BC507019 19 cm / 7½"
BC507023 23 cm / 9"
BC507026 26 cm / 10¼"



Orthopedic

Bone Holding Clamps, Traction Bar
 Knochenhalteklammern, Distractionsklammer
 Pinzas porta huesos, Barra de traccion

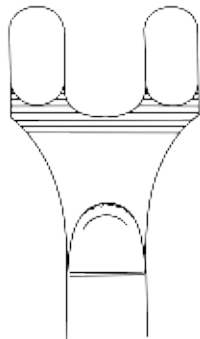
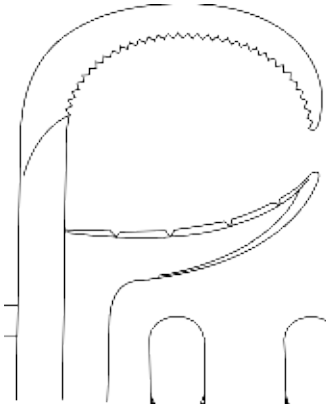

BC507508
 8.5 cm / 3 1/4"
 Special mini

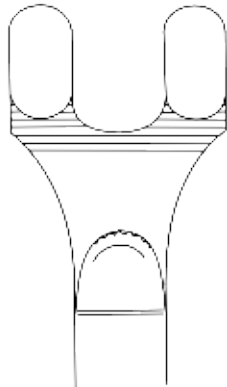

BC507512
 12 cm / 4 3/4"

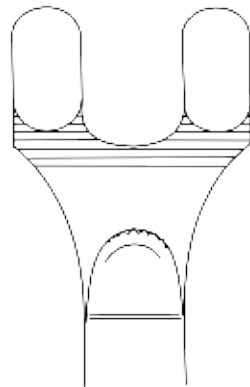

BC507518
 18 cm / 7"

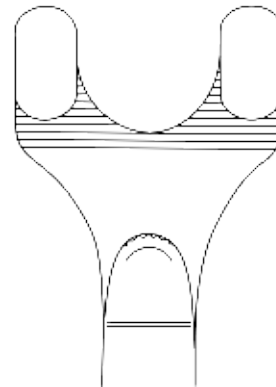

BC507520
 20 cm / 8"

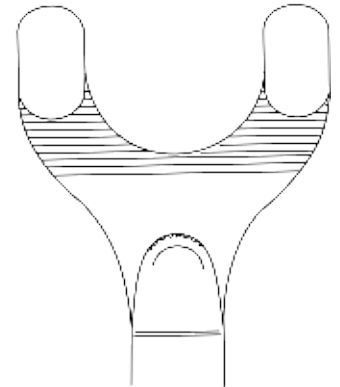

BC507522
 22 cm / 8 3/4"



Gerster - Lowmann
 1 x 2 jaws

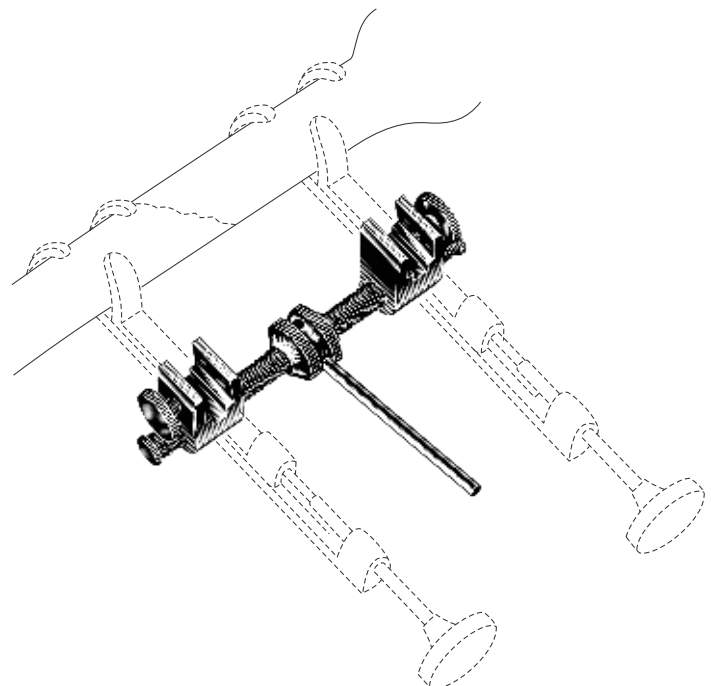

Gerster
 BC508000

Orthopedic
Bone Holding Clamps
Knochenhalteklammern
Pinzas porta huesos

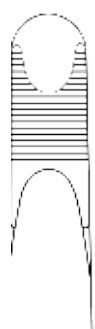

BC508512
12 cm / 4¾"

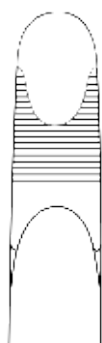

BC508518
18 cm / 7¼"

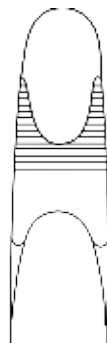

BC508520
20 cm / 8"

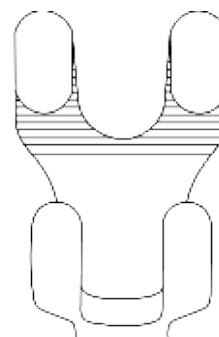

BC509018
18.5 cm / 7¼"

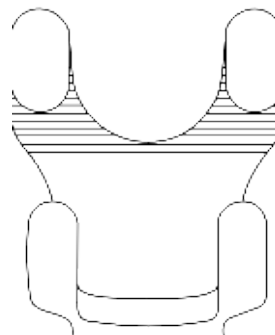

BC509020
20 cm / 8"



Lowmann
Bone clamp
1 x 1 jaws



Lowmann
Bone clamp
2 x 2 jaws

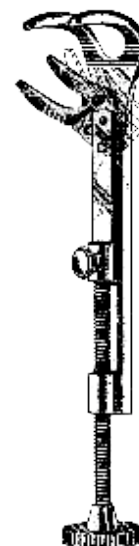

Lowman Hoglund
BC509512 12 cm / 4¾"
BC509518 18 cm / 7¼"
BC509520 20 cm / 8"
Moveable jaws



Orthopedic Pelvic Reposition Forceps



BC510119 19 cm / 7½"
BC510123 23 cm / 9"
BC510125 25 cm / 10"

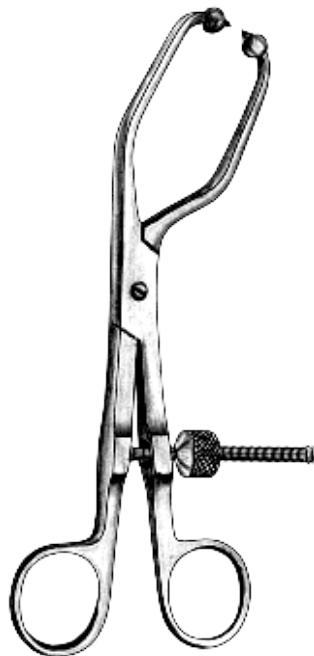

BC510523 23 cm / 9"
BC510525 25 cm / 10"

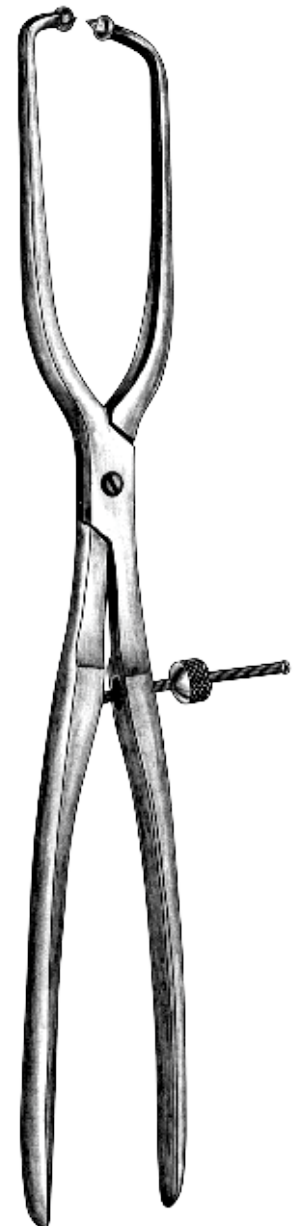

BC511040
40 cm / 16"

Orthopedic
Pelvic Reposition Forceps

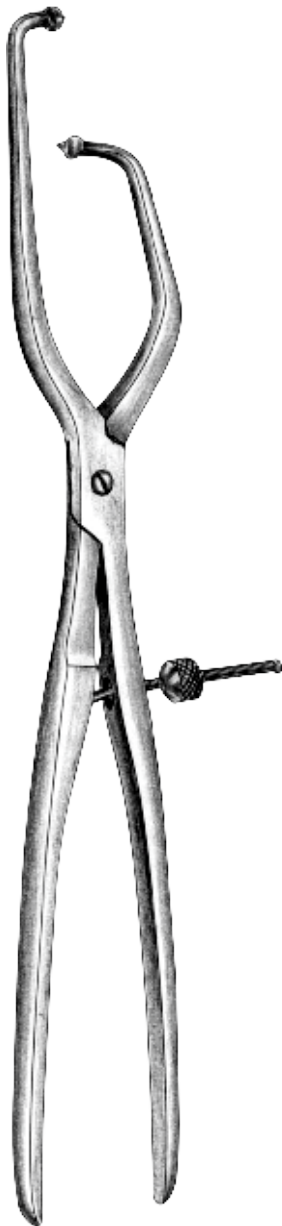

BC511540
40 cm / 16"

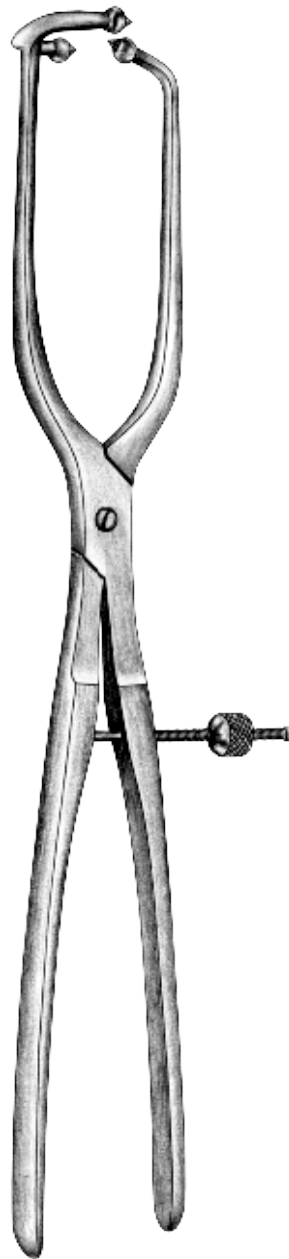

BC512040
40 cm / 16"

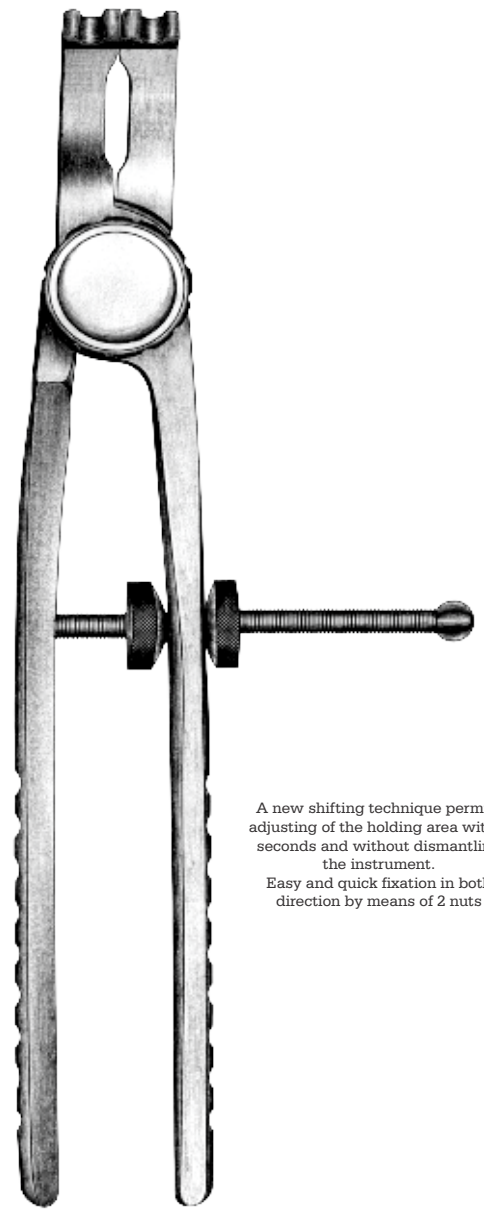

BC512500
Reposition forceps

A new shifting technique permits adjusting of the holding area within seconds and without dismantling the instrument.
Easy and quick fixation in both direction by means of 2 nuts



Orthopedic
Bone Rongeur Forceps
Hohlmeißelzangen
Pinzas-gubias



Mini-Friedman
BC090012
12.5 cm / 5"

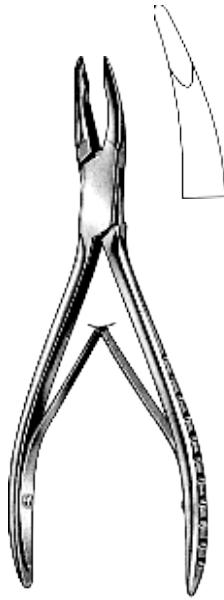

Friedman
BC090214
14 cm / 5½"

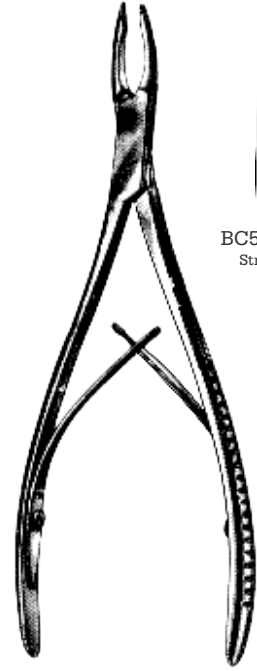

Micro Friedman
15 cm / 6"
2 x 6 mm bite
Delicate



BC514015
Straight



BC514115
Curved



Micro- Friedman
14 cm / 5½"
Extremely delicate



BC514514
1.5 x 5 mm bite
Straight



BC514614
1.5 x 5 mm bite
Angled 30°



BC514714
1.5 x 5 mm bite
Angled 90°

For soft tissue and cancellous bone only

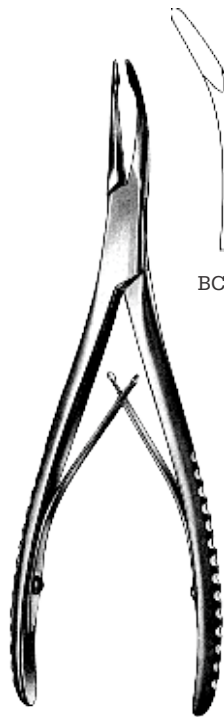

Stellbrink
17 cm / 6¾"



BC515017



BC515117



Universal
BC515513
13.5 cm / 5¼"

Orthopedic
 Bone Rongeur Forceps
 Hohlmeißelzangen
 Pinzas-gubias

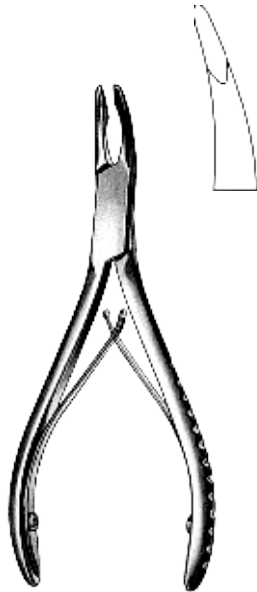

Mead
 BC516016
 16.5 cm / 6½"

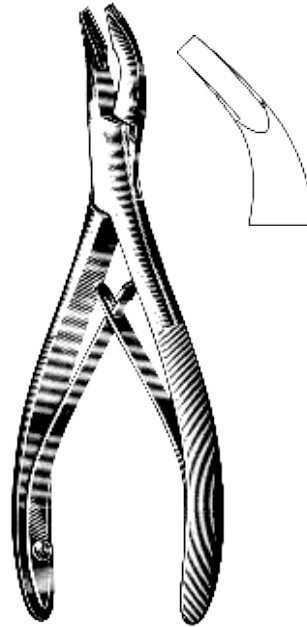

Mead
 BC516516
 16.5 cm / 6½"



Mead
 BC517016
 16.5 cm / 6½"

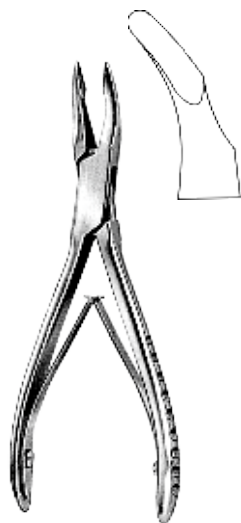

Cleveland
 BC090614
 14.5 cm / 5½"



Cleveland
 BC090817
 17 cm / 6¾"

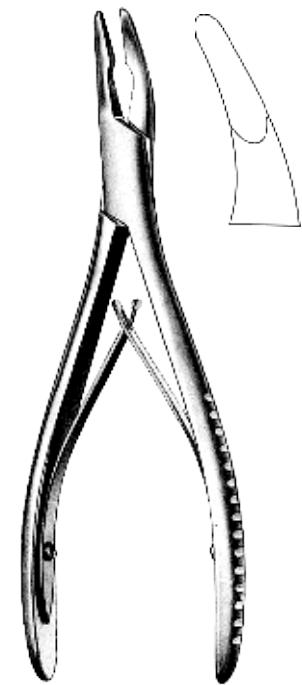

Hartmann
 BC092018
 18.5 cm / 7¼"



Orthopedic
Bone Rongeur Forceps
Hohlmeißelzangen
Pinzas-gubias



Jansen
18 cm / 7"



BC517518



BC517618



BC517718

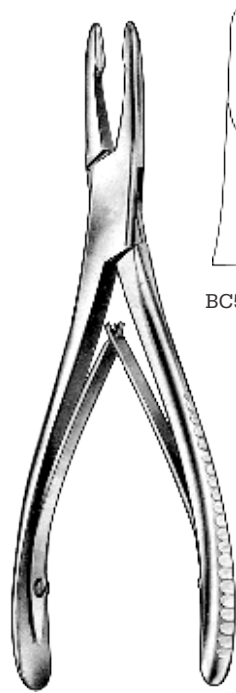

Jansen
18 cm / 7"



BC518018



BC518118

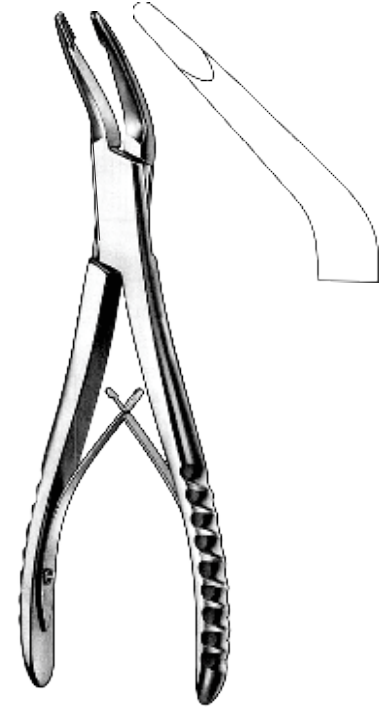

Marchac
BC518518
18 cm / 7"



Blumenthal
15 cm / 6"



BC093615



BC093815

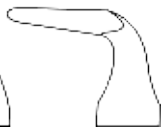

BC094015

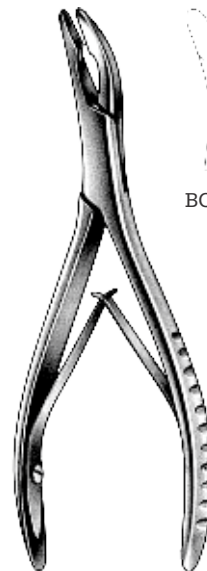

Luer
15 cm / 6"



BC095415



BC096515



BC096615

Orthopedic
Bone Rongeur Forceps
Hohlmeißelzangen
Pinzas-gubias

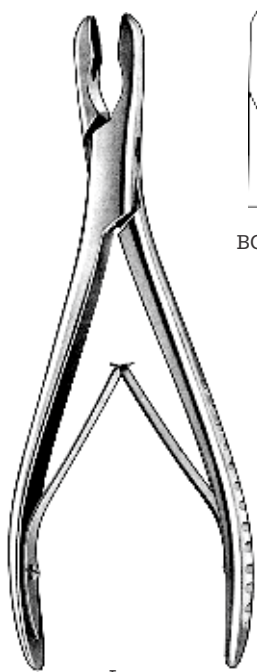

Luer
17 cm / 6 3/4"



BC519017



BC519117

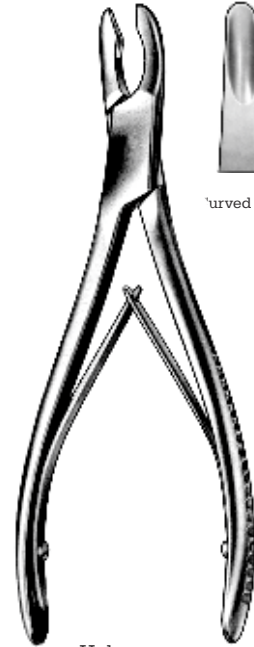

Hakansson
BC519517
17 cm / 6 3/4"



Curved to side



Alexander
BC520114
14 cm / 5 1/2"



Jansen
BC520519
19 cm / 7 1/2"



Beyer
BC214518
18 cm / 7"

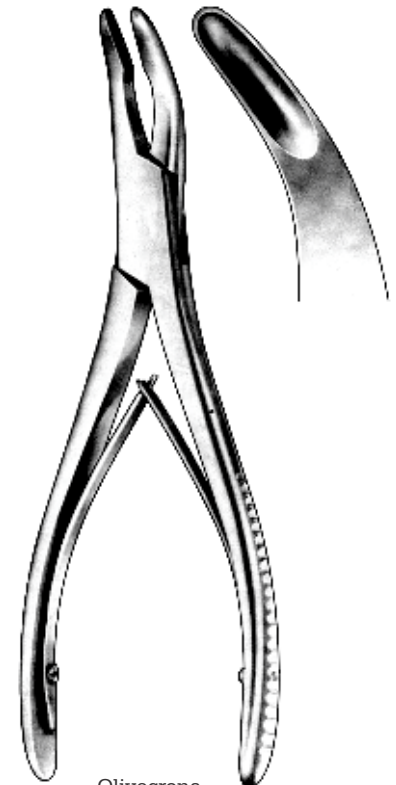

Olivecrona
BC521020
20.5 cm / 8"



Orthopedic
Bone Rongeur Forceps
Hohlmeißelzangen
Pinzas-gubias

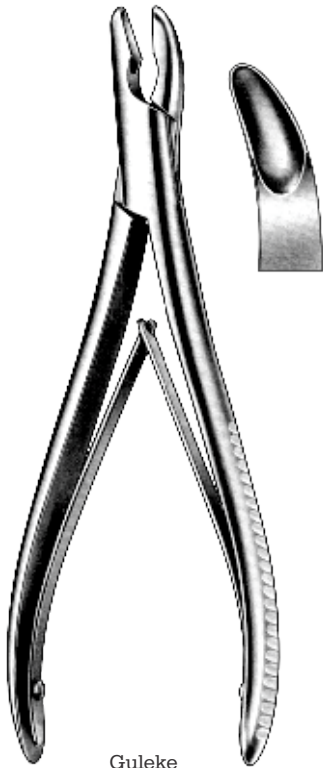

Guleke
BC521520
20.5 cm / 8"

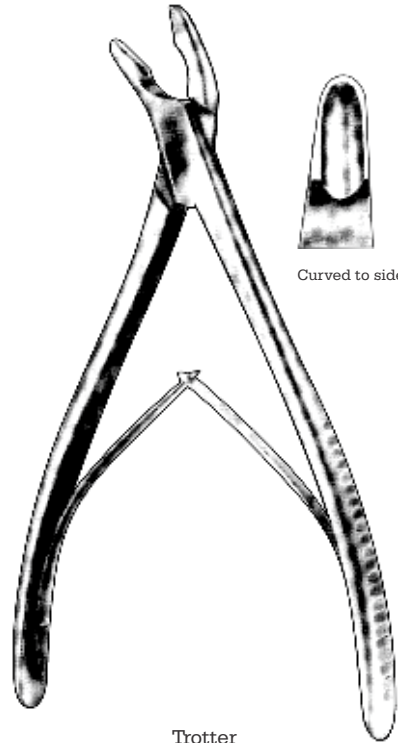

Curved to side

Trotter
BC522020
20.5 cm / 8"

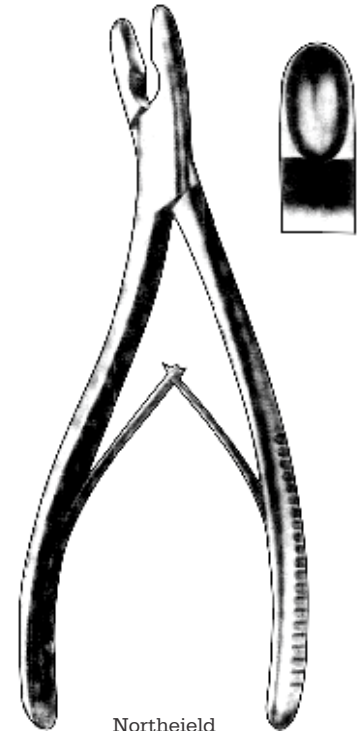

Northield
BC522520
20.5 cm / 8 1/4"



Pennybacker
BC523020
20.5 cm / 8"

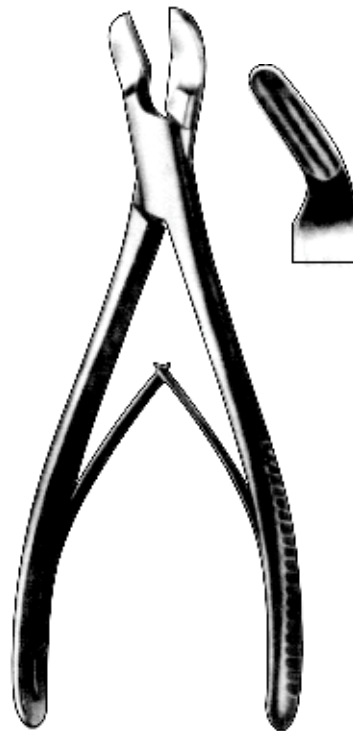

Wilms
BC523521
21 cm / 8 1/4"

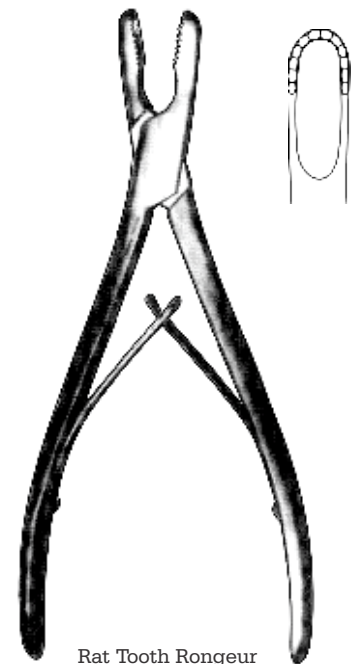

Rat Tooth Rongeur
BC524020
20.5 cm / 8"
With teeth 8 x 15 mm bite
Straight

Orthopedic
 Bone Rongeur Forceps
 Hohlmeißelzangen
 Pinzas-gubias

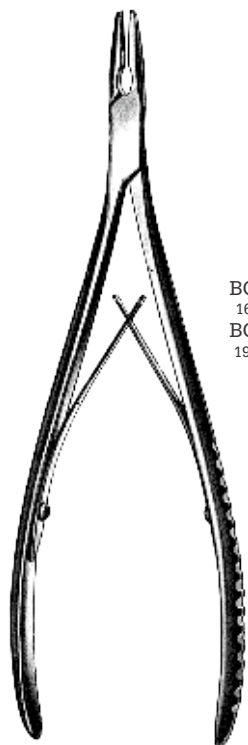

Lempert
2.5 mm bite



BC524516
16 cm / 6 1/4"
BC524519
19 cm / 7 1/2"
Straight



BC524616
16 cm / 6 1/4"
BC524619
19 cm / 7 1/2"
Curved



Juers-Lempert
Straight jaws on curved handles, delicate, 2.5 mm bite



BC525016
16 cm / 6 1/4"
BC525018
18.5 cm / 7 1/4"
Straight



BC525116
16 cm / 6 1/4"
BC525118
18.5 cm / 7 1/4"
Curved

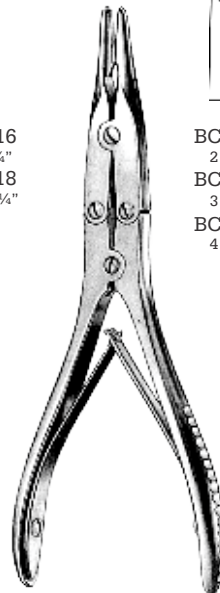

Bohler
15 cm / 6"



BC525515
2 mm tip
BC525615
3 mm tip
BC525715
4 mm tip



BC526015
2 mm tip
BC526115
3 mm tip
BC526215
4 mm tip

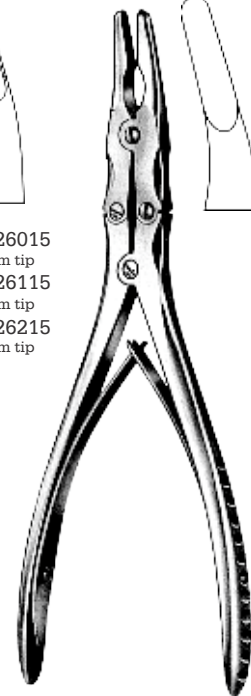

Zaufal-Jansen
BC098018
18 cm / 7"



Mayfield
BC526517
17 cm / 6 3/4"



BC527018
Straight

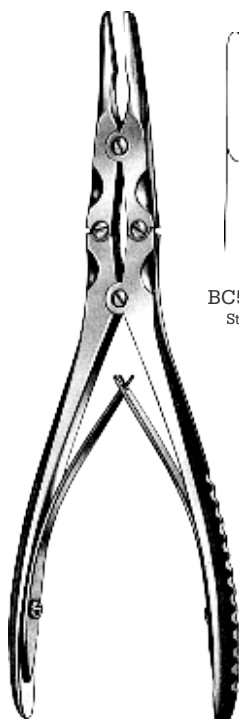

Beyer
18 cm / 7"

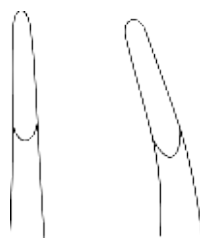

BC527118
Curved

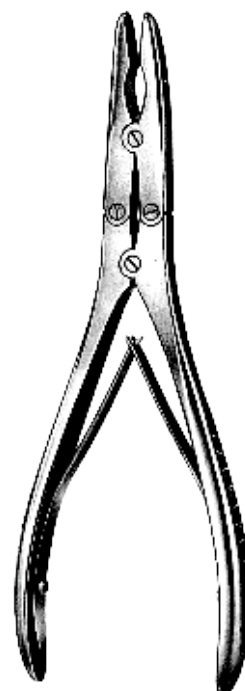

Ruskin
Delicate



BC215015 2 mm
BC527515 3 mm
BC527615 4 mm
15 cm / 6"
BC528018 2 mm
BC215518 3 mm
BC528118 4 mm
BC528218 6 mm
BC528318 8 mm
17.5 cm / 7"



BC529515 2 mm
BC529615 3 mm
BC529715 4 mm
15 cm / 6"
BC530018 2 mm
BC098818 3 mm
BC530118 4 mm
BC530218 6 mm
BC530318 8 mm
17.5 cm / 7"

BC528520 2 mm
BC528620 3 mm
BC528720 4 mm
BC528820 6 mm
BC528920 8 mm
20 cm / 8"
Straight

BC530520 2 mm
BC530620 3 mm
BC530720 4 mm
BC530820 6 mm
BC530920 8 mm
20 cm / 8"
Curved



Orthopedic
Bone Rongeur Forceps
Hohlmeißelzangen
Pinzas-gubias

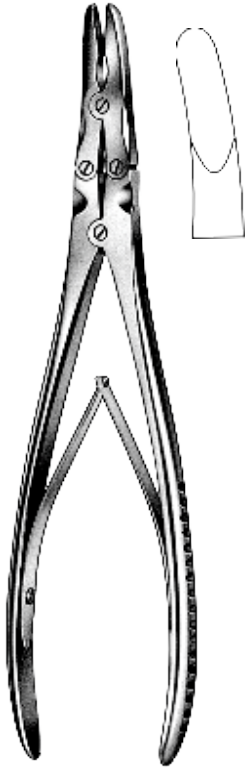

Ruskin
BC531523
23 cm / 9"

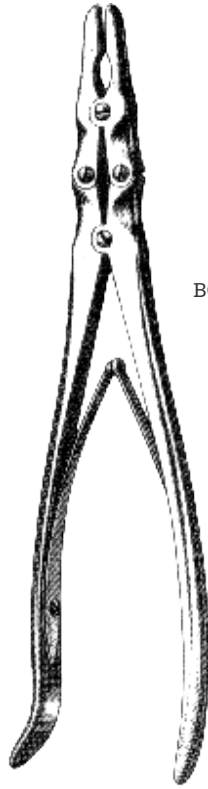

Smith-Peterson
24 cm / 9½"
3 x 16 mm bite
Laminectomy rongeur

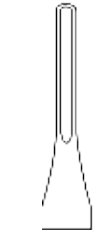

BC532024
Straight



BC532124
Curved



BC532224
Full curved

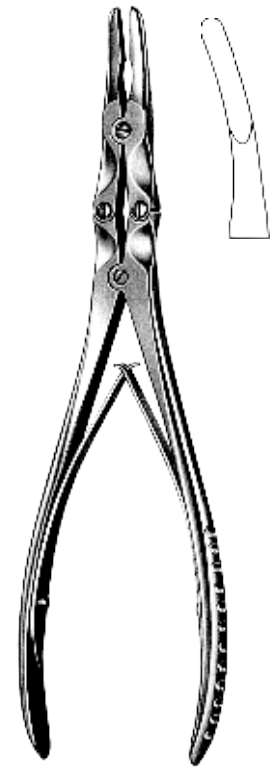

Marquard
BC532520
20 cm / 8"

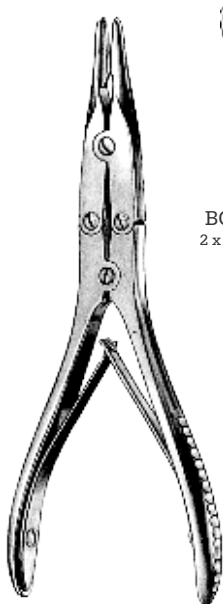

BC533015
2 x 13 mm bite



BC533115
3 x 13 mm bite

Kleinert-Kutz
15 cm / 6"
Synovectomy rongeur
Slight curve, delicate

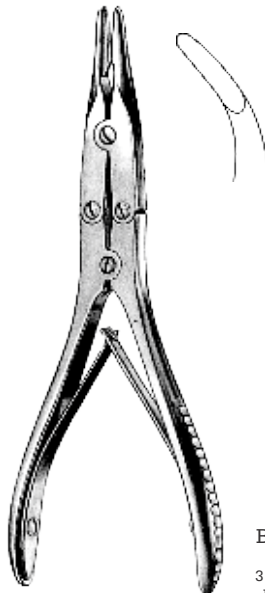

BC533515
15 cm / 6"
3 x 8 mm bite
Full curved
Delicate

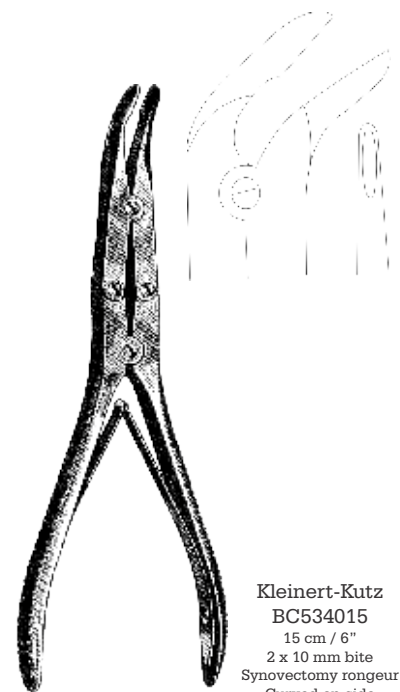

Kleinert-Kutz
BC534015
15 cm / 6"
2 x 10 mm bite
Synovectomy rongeur
Curved on side
Delicate

Orthopedic
Bone Rongeur Forceps
Hohlmeißelzangen
Pinzas-gubias



BC534523
2 mm

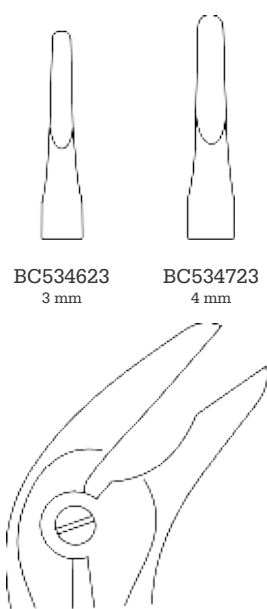

BC534623
3 mm



BC534723
4 mm

Echlin
23 cm / 9"



Stille-Ruskin
BC535023
23 cm / 9"

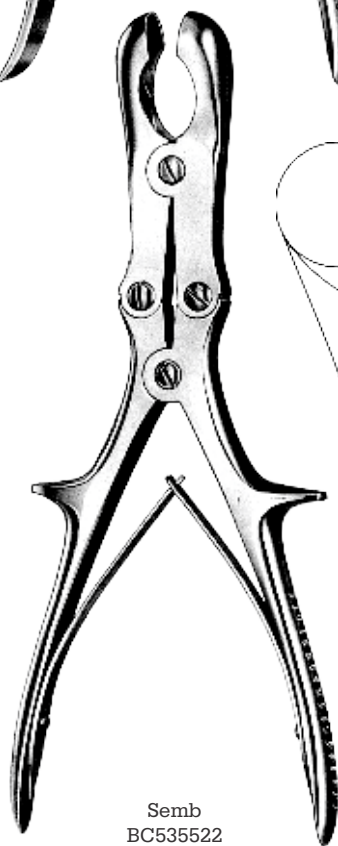

Semb
BC535522
22.5 cm / 9"

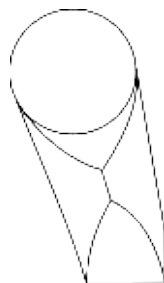

Stille
BC536023
23 cm / 9"



Frykholm
BC536524
24 cm / 9 1/2"





Orthopedic
Bone Rongeur Forceps
Hohlmeißelzangen
Pinzas-gubias

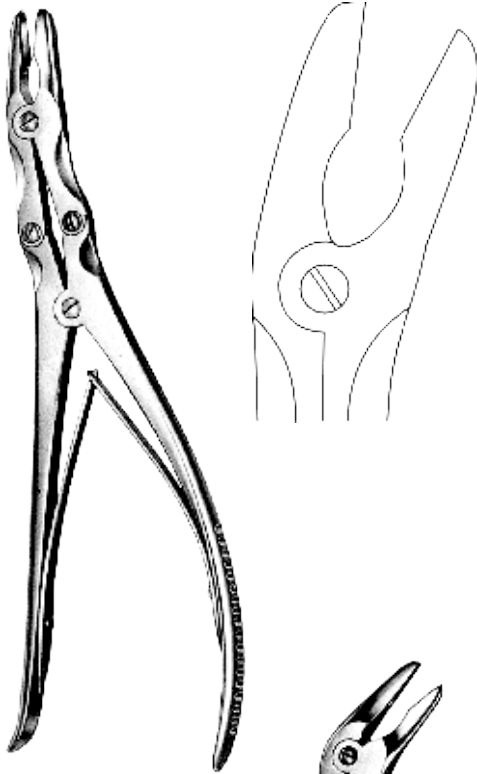

Leksell-Stille
 24 cm / 9½"
 Curved 15°



Leksell
 23 cm / 9"
 Curved 50°



BC537024
 3 x 16 mm bite



BC537124
 4 x 16 mm bite



BC537224
 5 x 16 mm bite



BC537324
 6 x 16 mm bite



BC537424
 7 x 16 mm bite

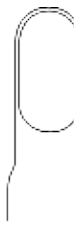

BC537524
 8 x 16 mm bite



BC538023
 3 x 13 mm bite

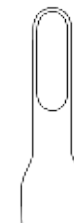

BC538123
 4 x 13 mm bite



BC538223
 5 x 13 mm bite



BC538323
 6 x 13 mm bite

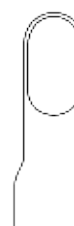

BC538423
 7 x 13 mm bite



BC538523
 8 x 13 mm bite

Orthopedic
 Bone Rongeur Forceps
 Hohlmeißelzangen
 Pinzas-gubias

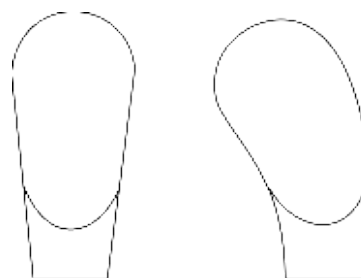

BC540123	23 cm / 9"	BC540223
BC540127	27 cm / 10½"	BC540227

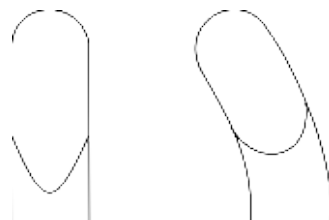

BC539022	4 mm	BC539522
BC539122	6 mm	BC539622
BC539222	8 mm	BC539722
BC539322	10 mm	BC539822
BC539422	12 mm	BC539922



Stille-Luer
 22 cm / 8½"
 8 mm

Stille-Luer



Orthopedic
Bone Rongeur Forceps
Hohlmeißelzangen
Pinzas-gubias

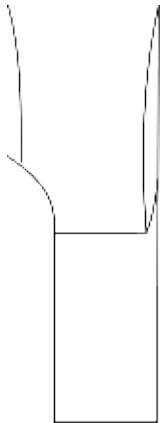

BC540530



BC540630

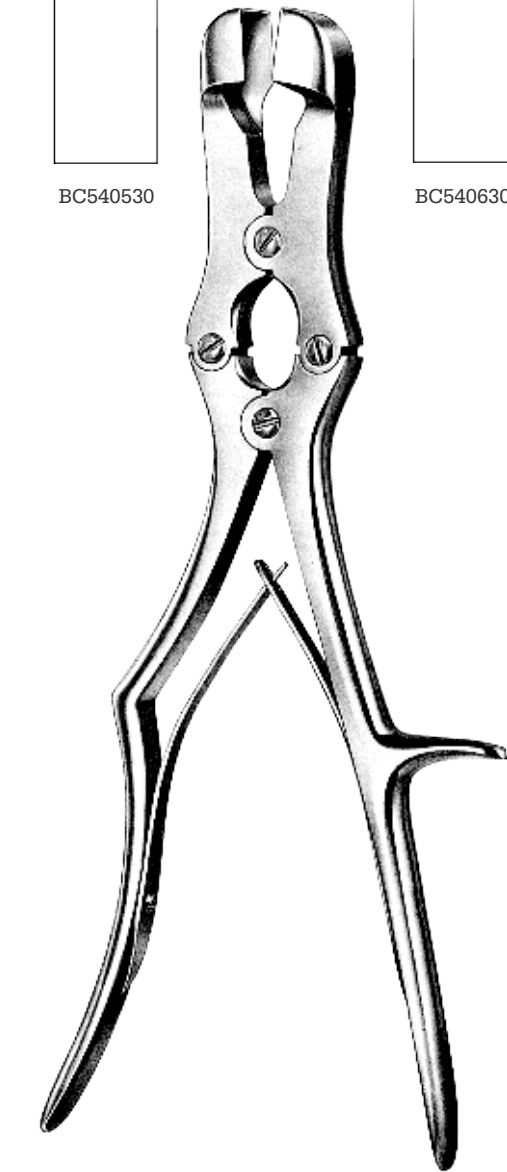

Sauerbruch
 30 cm / 12"

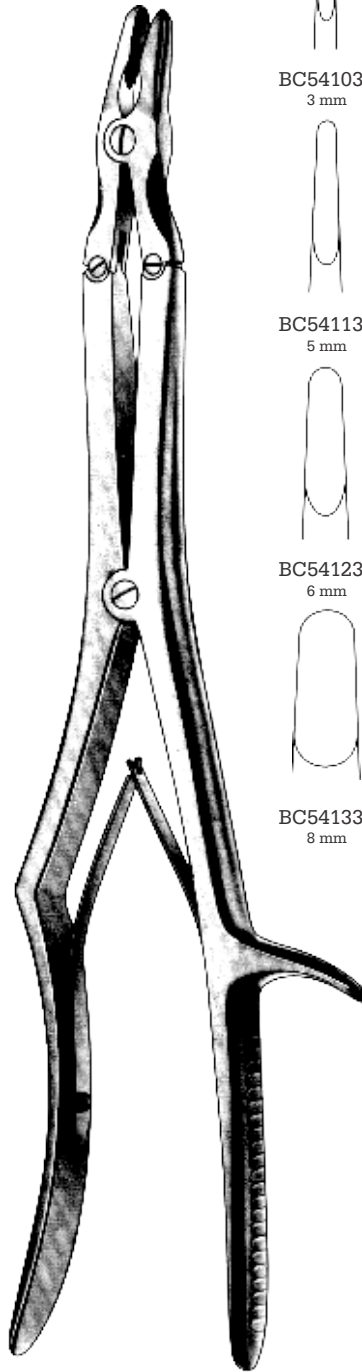

Syvert
 36 cm / 14½"



BC541036
 3 mm



BC541136
 5 mm



BC541236
 6 mm

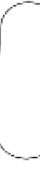

BC541336
 8 mm

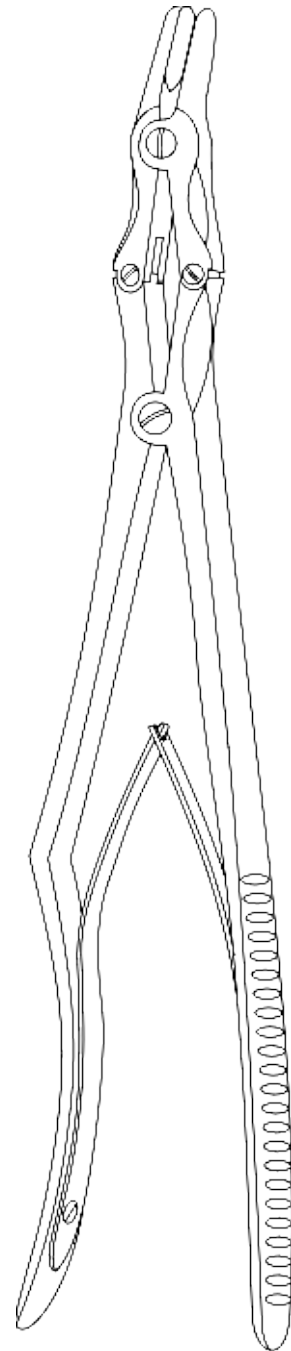

Dale



BC541500
 3 mm



BC541600
 5 mm



BC541700
 6 mm



BC541800
 8 mm

Orthopedic

Bone Cutting Forceps

Knochensplitterzangen

Pinzas cortantes para huesos

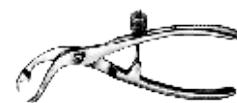

Liston



BC542014
14 cm / 5½"



BC542017
17 cm / 6¾"



BC542019
19 cm / 7½"



BC542022
22 cm / 8¾"



Liston



BC542514
14 cm / 5½"



BC542517
17 cm / 6¾"



BC542519
19 cm / 7½"



BC542522
22 cm / 8¾"

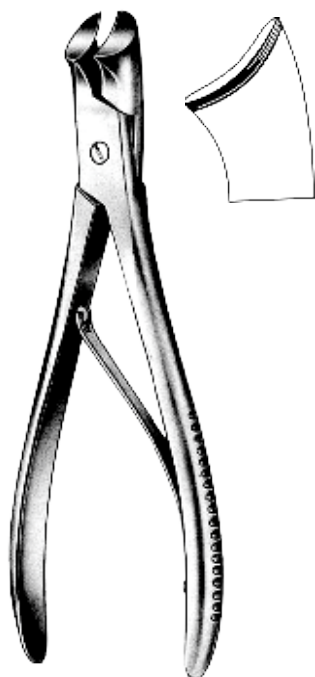

Markwalder
BC543012
12 cm / 4¾"

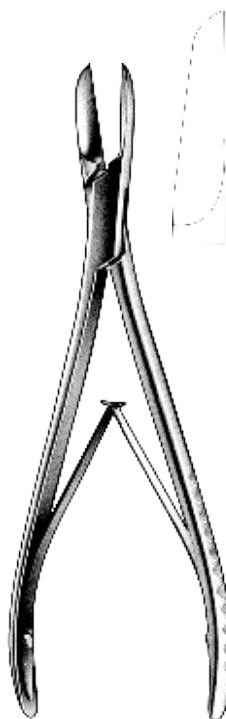

Cleveland
BC543515
15 cm / 6"

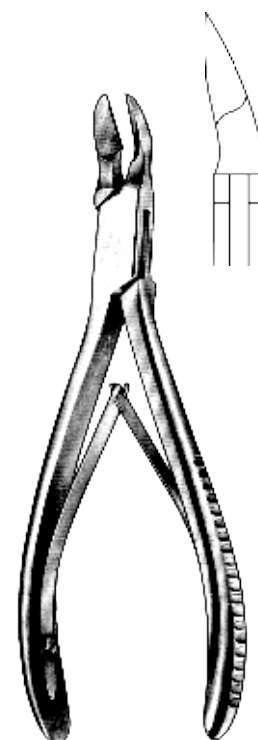

Cleveland
BC104017
17 cm / 6¾"
BC104015
15 cm / 6"



Orthopedic
Bone Cutting Forceps
Knochensplitterzangen
Pinzas cortantes para huesos



Stamm
BC544015
15 cm / 6"

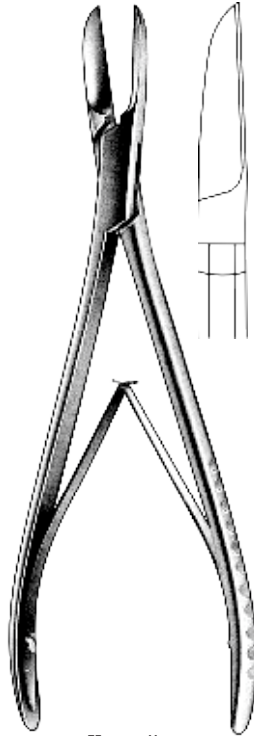

Kazanjian
BC544518
18.5 cm / 7 1/4"

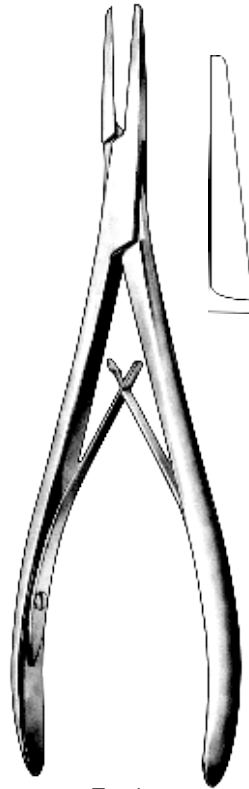

Tessier
BC545020
20.5 cm / 8"
Slim pattern

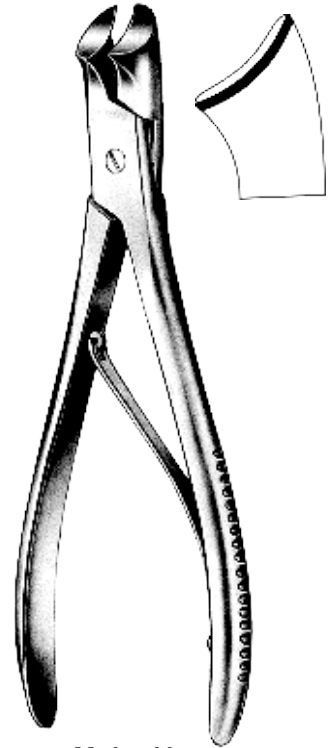

Markwalder
BC545520
20 cm / 8"

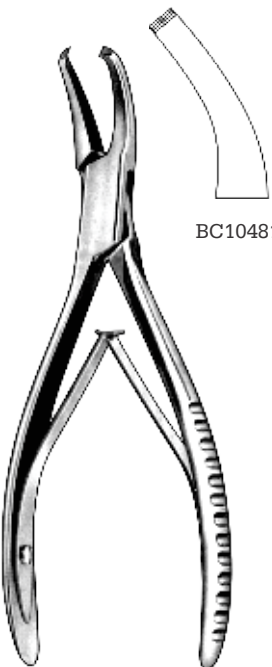

Cleveland
16 cm / 6 1/4"



BC104816

BC546016



Bohler
BC546515
15 cm / 5 3/4"

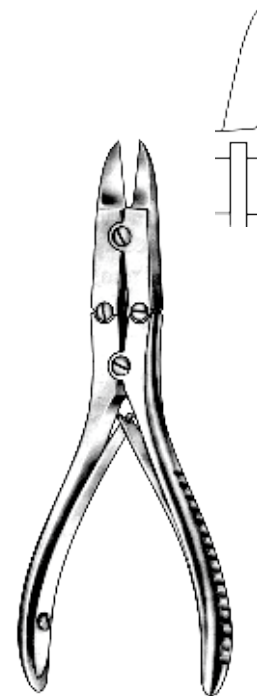

Bohler
BC547014
14.5 cm / 5 3/4"

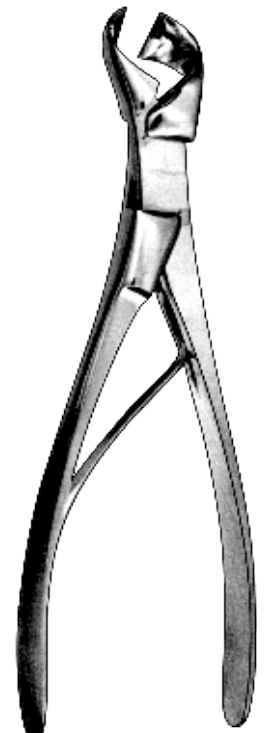

Velpeau
BC547524
24 cm / 9 1/2"

Orthopedic

Bone Cutting Forceps

Knochensplitterzangen

Pinzas cortantes para huesos

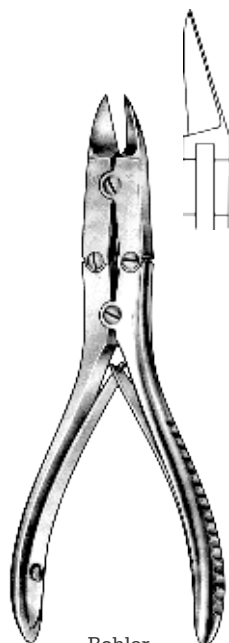

Bohler
BC548014
14.5 cm / 5 3/4"

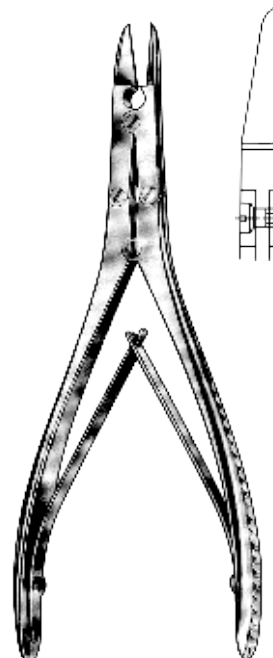

BC548517
17 cm / 6 3/4"

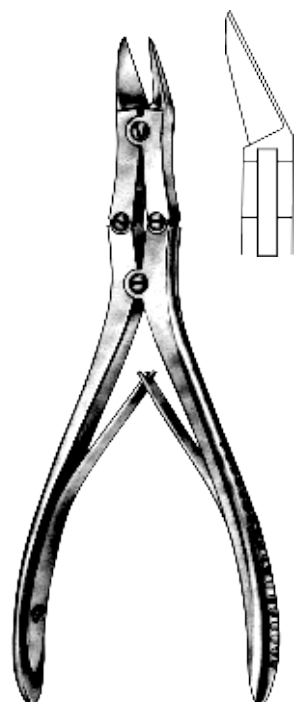

Mc Indoe
BC549017
17.5 cm / 7"

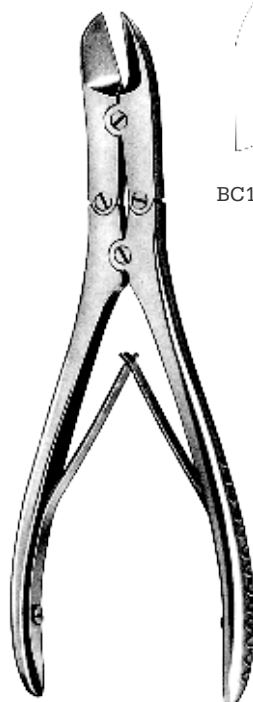

Ruskin-Liston
18.5 cm / 7 1/4"

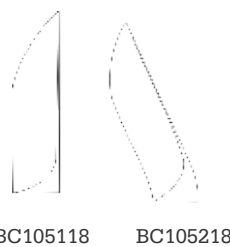

BC105118

BC105218

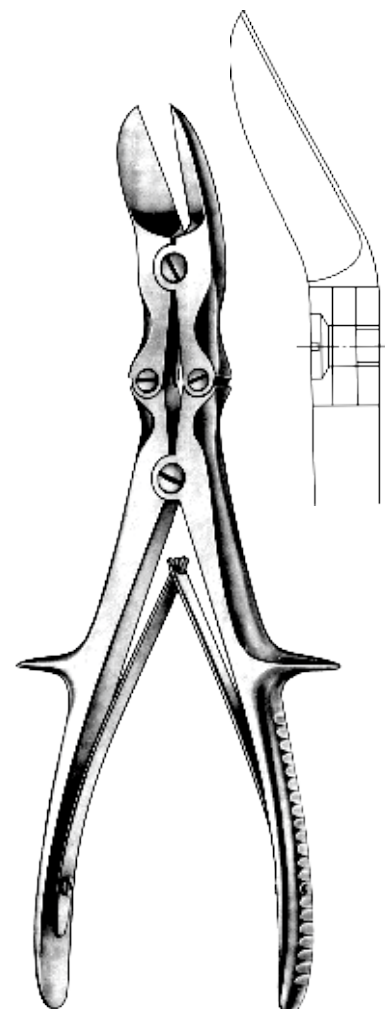
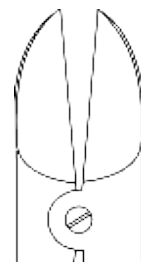

Liston
BC549524
24 cm / 9 1/2"



Orthopedic
Bone Cutting Forceps
Knochensplitterzangen
Pinzas cortantes para huesos

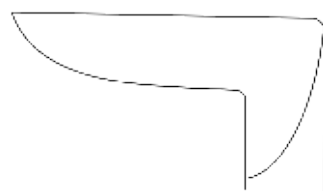

Stille-Liston
BC550127
27 cm / 10½"



Stille-Liston
BC550527
27 cm / 10½"

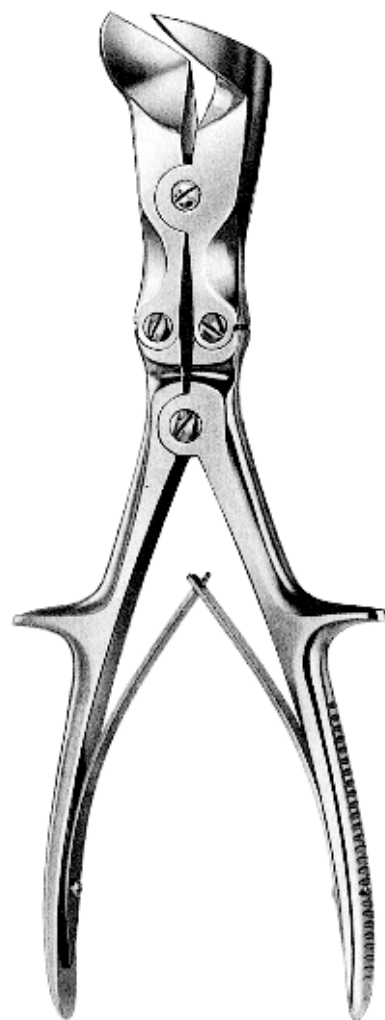

Stille-Liston
BC551027
27 cm / 10½"

Orthopedic

Bone Cutting Forceps

Knochensplitterzangen

Pinzas cortantes para huesos

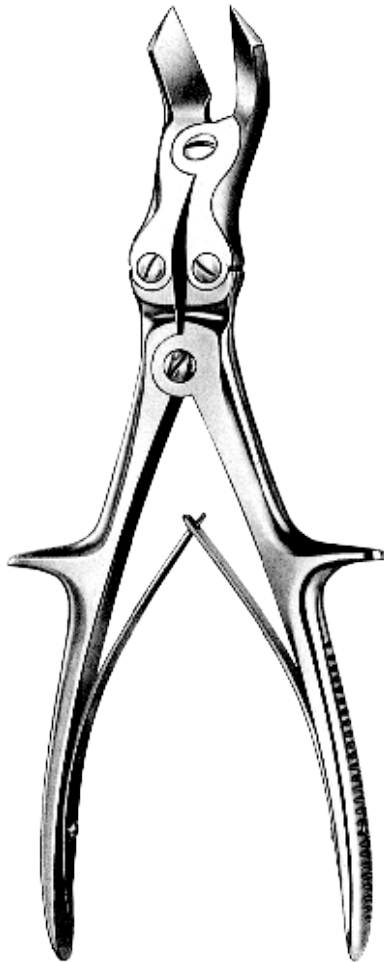
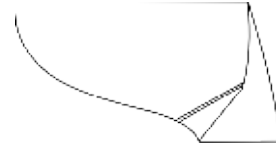
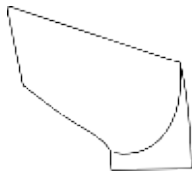

Liston-Key
BC551527
27 cm / 10½"

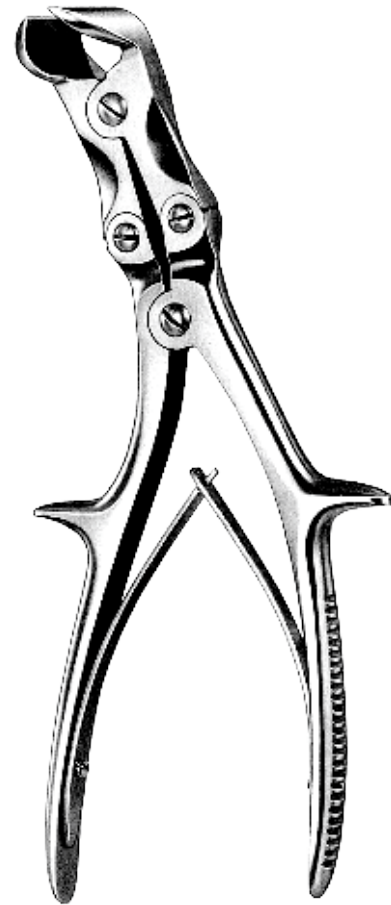

Semb
BC552024
24 cm / 9½"



Orthopedic
Wire Twisting Forceps
Draht-Zangen
Pinzas para torcer hilos

Instruments with Tungsten Carbide Inserts

Tc Gold

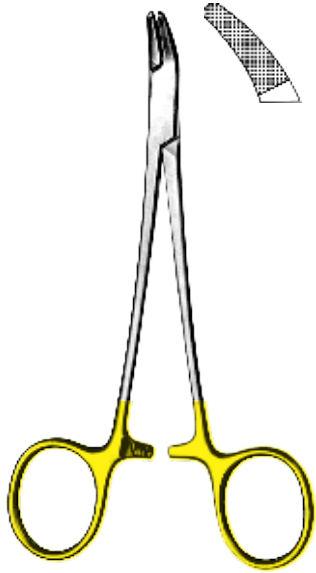

BC552515T
15.5 cm / 6"



Corwin
BC553016T
16 cm / 6 1/4"



BC060115T
15 cm / 6"

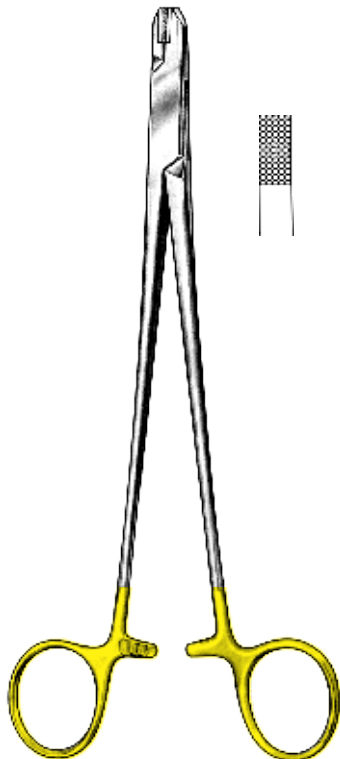

BC062120T
20 cm / 8"

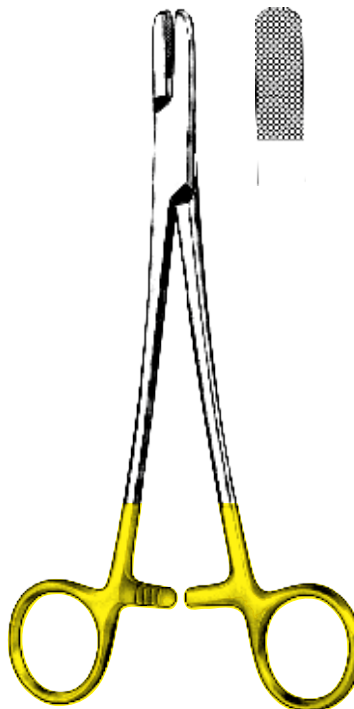

BC553520T
20 cm / 8"

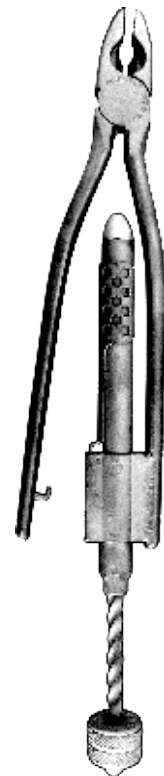

BC554000T
Jet wire twister

Orthopedic

Wire Tightening Pliers, Flat Nose Pliers
 Drahtspannerzangen, Flachzangen
 Tensor cierra-hilo, Alicates de pico plano



BC555017T

17 cm / 6 3/4"

Holding forceps for cerclage wire, with lateral jaws to avoid wire slipping off

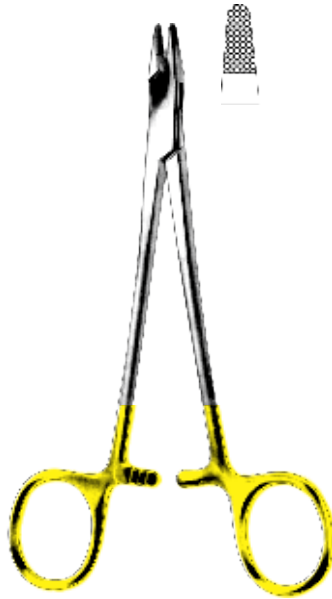

BC554515T

15 cm / 6"

Wire tightening pliers
ligature pliers



Baumgartner

BC556020T

20 cm / 8"

Wire twister, ligature forceps

Instruments with Tungsten Carbide Inserts
Tc Gold



18 cm / 7"
Parallel grip



BC556518T



BC556618T



BC556718T

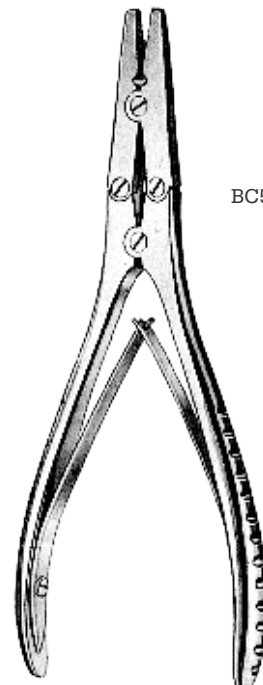

18 cm / 7"
Parallel grip



BC557018T



BC557118T

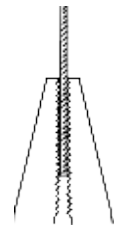



Orthopedic

Wire Twister, Flat Nose Pliers, Wire Cutting Pliers
 Flachzangen, Draht-Kneifzangen
 Alicates planos, Alicates para cortar alambre



BC557516
 16 cm / 6¼"
 Heavy pattern



BC558015
 15 cm / 6"
 For bending & cutting

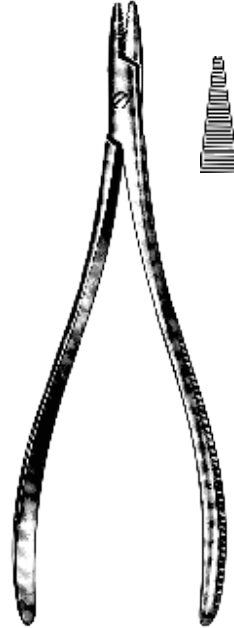

BC558516
 16.5 cm / 6½"

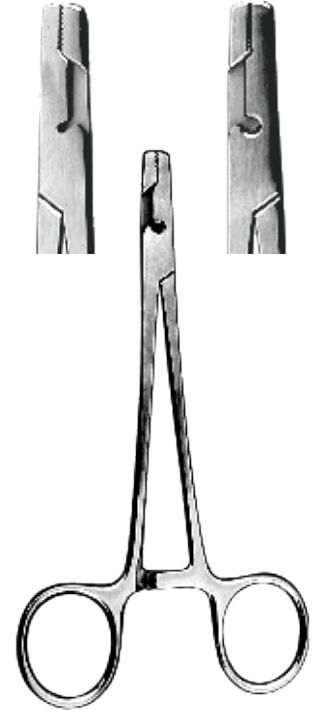

BC559000
 Wire twister / Shear cutter
 cuts wire up to 18g, twisted double

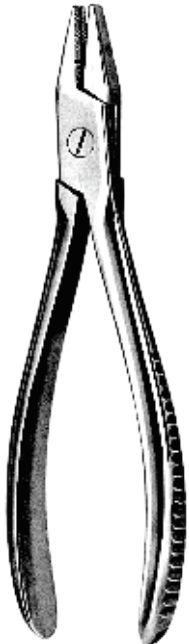

17 cm / 6¾"



BC559517



BC559617
 With crosswise
 groove



Hakstock
 BC560116
 16 cm / 6¼"

With longitudinal groove

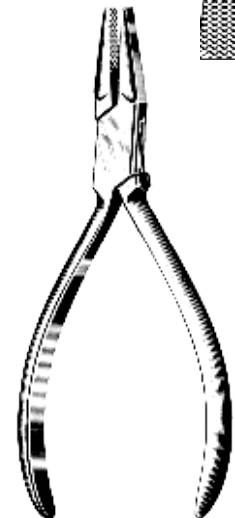
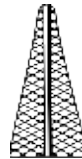

BC560514
 14 cm / 5½"



Orthopedic

Flat Nose & Wire Twisting Pliers

Flachzangen, Draht-Kneifzangen

Alicates planos, Alicates para cortar alambre

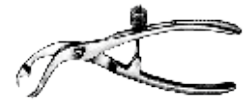

BC561014
14 cm / 5 1/2"
Delicate

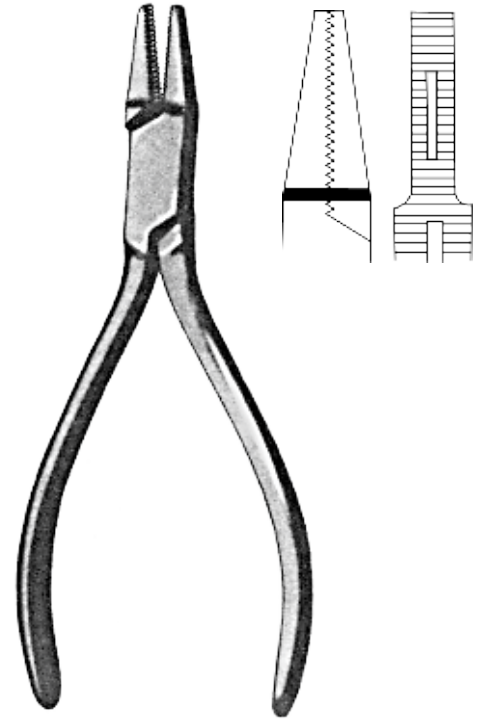

BC561514
14 cm / 5 1/2"
Flat nose plier
Broad

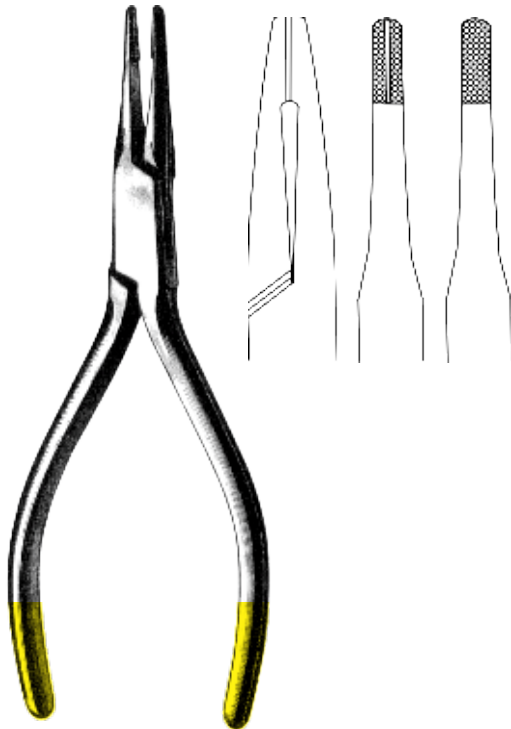

BC562014T
14 cm / 5 1/2"
4 mm tip
Pin pulling plier

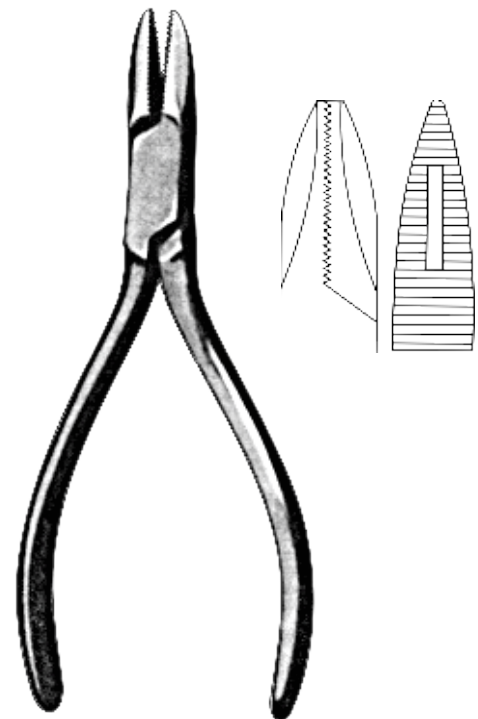

BC562314
14 cm / 5 1/2"
2 mm tip
Needle nose plier



Orthopedic

Flat Nose Pliers, Wire Cutting & Twisting Pliers
 Flachzangen, Draht-Kneifzangen und Drahtzangen
 Alicates planos, Alicates para cortar alambre



BC562515
 15 cm / 6"
 Flat nose plier
 2 mm tip for cerclage wire
 Delicate

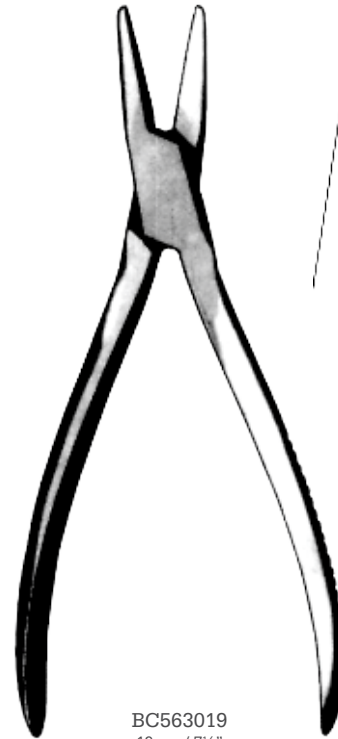
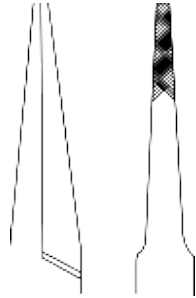

BC563019
 19 cm / 7½"
 3 mm tip
 Narrow nose
 wire pulling forceps

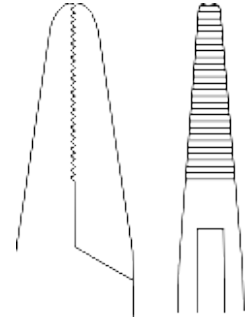

BC563516
 16.5 cm / 6½"
 3 mm tip
 Flat nose plier

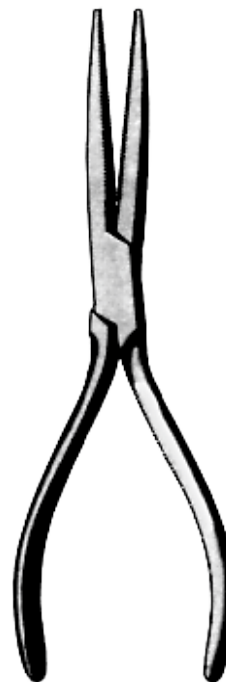
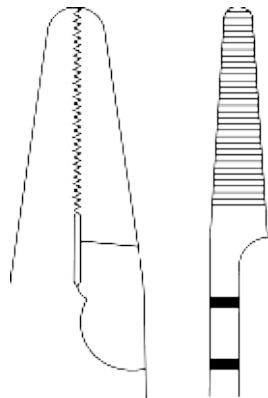

BC564018
 18 cm / 7"
 Jaw length: 2½"
 2 mm tip
 Parallel grooved jaws
 Long jaw needle nose plier

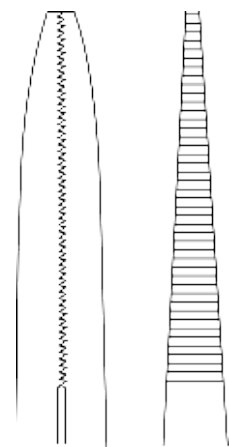

Orthopedic

Wire Tighteners and Drill Chucks, Wire Twisters
 Draht Spann und spannfutter, Drahtzwirbel
 Tensores cirra-hilo y mandril de sujecion, Torcer de alambre



Jacobs
 BC350100 Small
 BC350200 Large
 Stainless steel

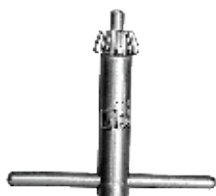

BC350500
 Key for jacobs chuck
 Stainless steel

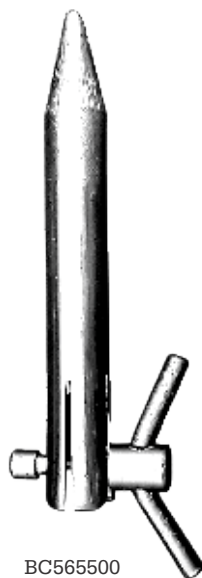

BC565500
 Wire tightener



BC351000 Small
 BC351100 Large
 Chuck chrome plated

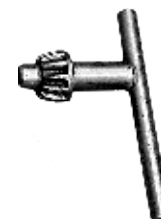

BC351200
 Key for
 chrome plated chuck



BC567018
 18 cm / 7"
 Small cerclage wire twister
 anodized aluminum handle



BC567500
 Large
 anodized aluminum handle



BC568000



BC568500
 Wire twister small
 Stainless steel



BC569018
 18 cm / 7"
 Large cerclage wire twister
 anodized aluminum handle
 Stainless steel tip



Orthopedic
 Drill Guide, Wire Twister & Wire Cutting Pliers
 Flachzangen, Draht-Kneifzangen
 Alicates planos, Alicates para cortar alambre

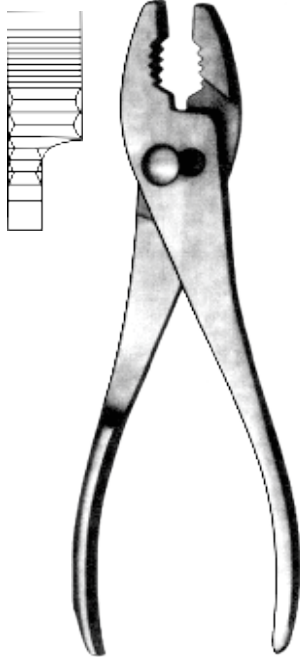

BC569520
 20 cm / 8"
 Slip joint plier
 10 mm tip
 Maximum opening 2"



BC570100
 Drill guide

- BC570200 2.0 mm
- BC570300 2.7 mm
- BC570400 3.5 mm
- BC570500 4.5 mm

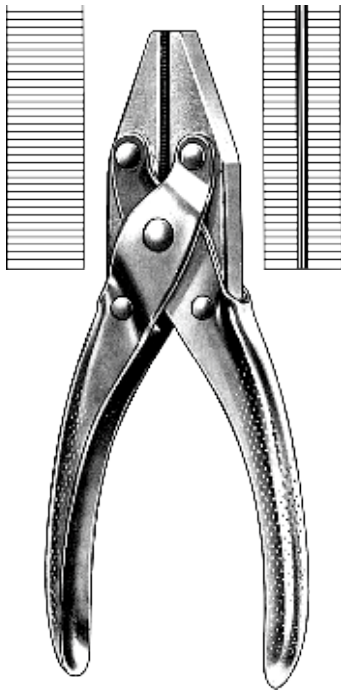

BC571013 13 cm / 5 1/2"
BC571017 17 cm / 6 1/2"



BC571517 17 cm / 6 1/2"
BC571512 12.5 cm / 5"
 With side cutter

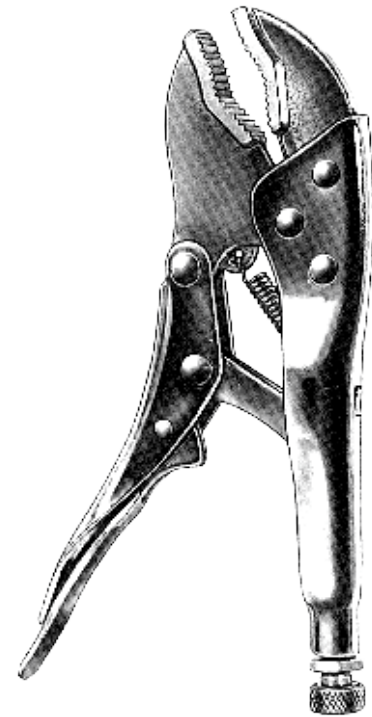

BC572018
 18 cm / 7"

Orthopedic
Trepine & Depth Gauge
Trepine
Trepano

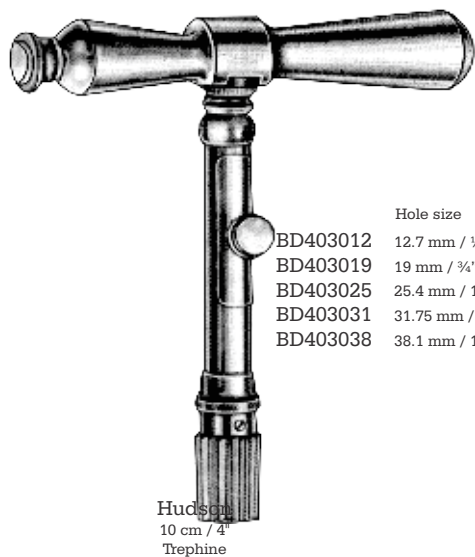

Hudson
10 cm / 4"
Trepine

	Hole size
BD403012	12.7 mm / 1/2"
BD403019	19 mm / 3/4"
BD403025	25.4 mm / 1"
BD403031	31.75 mm / 1 1/4"
BD403038	38.1 mm / 1 1/2"

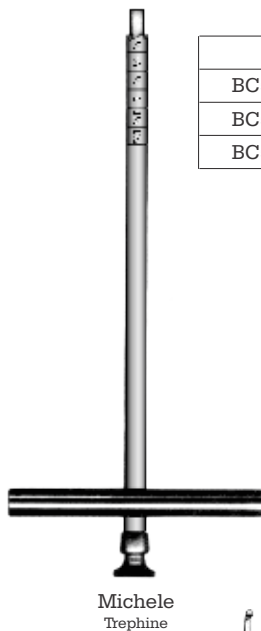

Michele
Trepine

		Inside ∅	Outside ∅
BC573000	Small	3 mm	5 mm
BC573100	Medium	4 mm	6 mm
BC573200	Large	6 mm	8 mm

Facilitates removal of wire and broken bone screws.



BC573500
Depth length 100 mm
Depth length 50 mm
Aluminum type



BC574000
40 mm



BC574500
60 mm



BC575000
80 mm



BC575500
110 mm



Orthopedic Wire Twisting Forceps Draht-Zangen Pinzas para torcer hilos

Heavy Duty Locking Pliers & Needle Nose Locking Pliers with a new reinforced, more durable jaw.

- Heavy duty jaws lock securely onto pins.
- Reinforced jaw hinge and jousing are more rigid to
- Help prevent side to side shifting.
- Made from 300 and 400 series Surgical grade
- Stainless steel.
- Will not chip or contaminate other instrumentation
- Adjustment screw for easy control of jaw opening
- One handed, quick release self-locking lever.
- Available in three sizes.

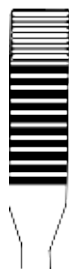

BC576017
17.5 cm / 6¾"
Tip width 7 mm
Maximum opening 1"
Small

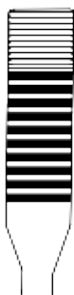

BC576020
20 cm / 8"
Tip width 9 mm
Maximum opening 1"
Medium



BC576025
25.5 cm / 10"
Tip width 13 mm
Maximum opening 1"
Large



BC576524
24 cm / 9½"
Length of jaw 2½"
Tip width 5 mm
Jaws are parallel at 3 mm

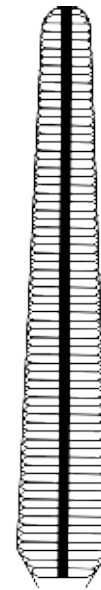

BC576530
30 cm / 12"
Length of jaw 3"
Tip width 7 mm
Jaws are parallel at 5 mm
Large

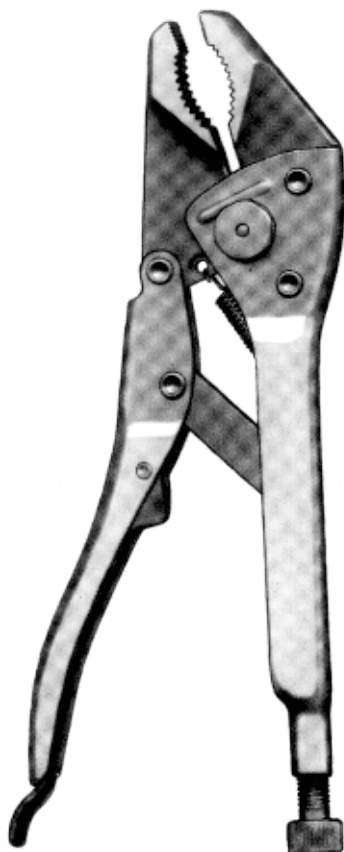

Locking plier



Needle nose locking plier

Orthopedic

Wire Cutting Pliers

Draht-Kneifzangen

Alicates para cortar alambre

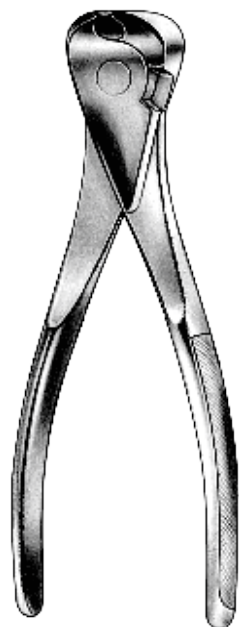

BC577016
16 cm / 6 1/4"

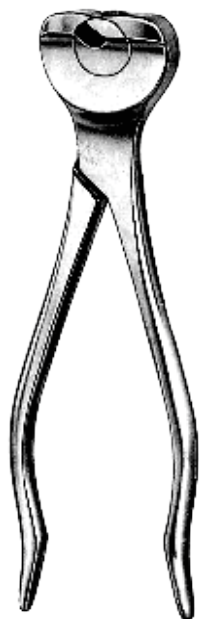

"Diamant"
BC577516
16 cm / 6 1/4"
for soft wires up to 2.5 mm Ø
for hard wires up to 2.0 mm Ø

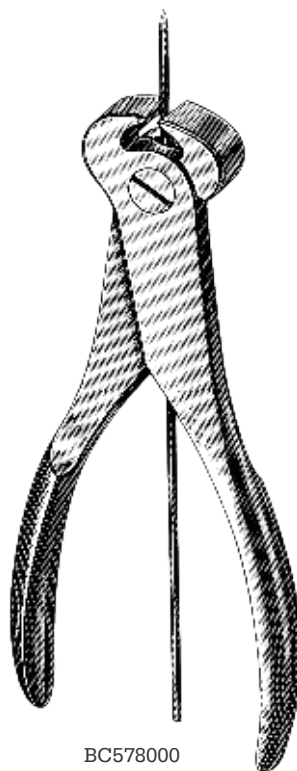

BC578000
16 cm / 6 1/4"
for soft wires up to 2.4 mm Ø
for hard wires up to 1.8 mm Ø



Instruments with Tungsten Carbide Inserts
Tc Gold



BC578516T 16 cm / 6 1/4"
BC578518T 18 cm / 7"
BC578520T 20 cm / 8"

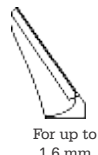
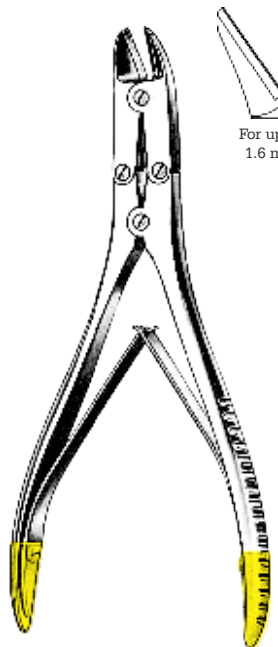

For up to
1.6 mm

BC579014T 14 cm / 5 1/2"
BC579016T 16 cm / 6 1/4"
BC579018T 18 cm / 7"

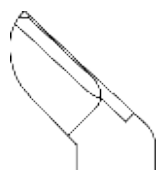
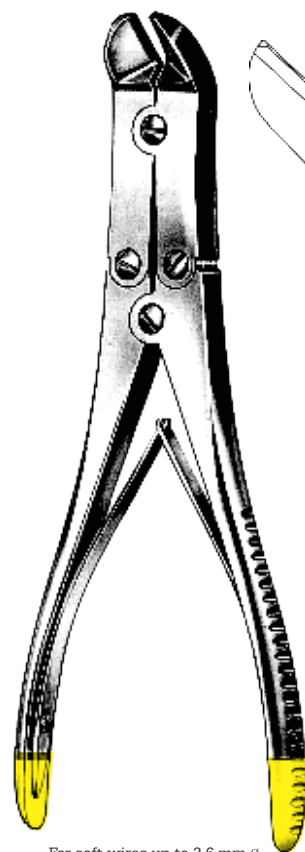

For soft wires up to 2.6 mm Ø
For hard wires up to 2.2 mm Ø

BC579522T
22 cm / 8 3/4"

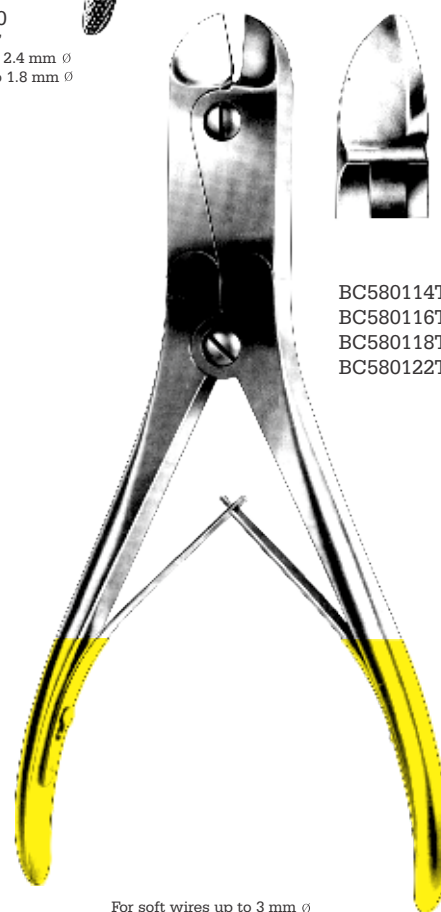

BC580114T 14 cm / 5 1/2"
BC580116T 16 cm / 6 1/4"
BC580118T 18 cm / 7"
BC580122T 22 cm / 8 3/4"

For soft wires up to 3 mm Ø
For hard wires up to 2.2 mm Ø



Orthopedic
Wire Cutting Pliers
Draht-Kneifzangen
Alicates para cortar alambre

Instruments with Tungsten Carbide Inserts
Tc Gold

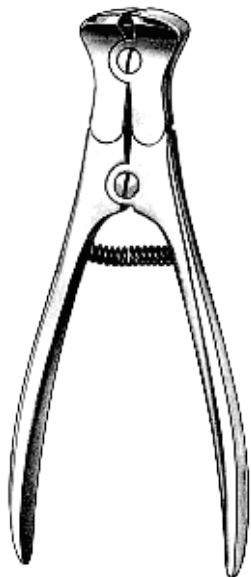

BC580515
15 cm / 6"
For soft wires up to 2.0 mm Ø
For hard wires up to 1.2 mm Ø



BC581024
24 cm / 9½"

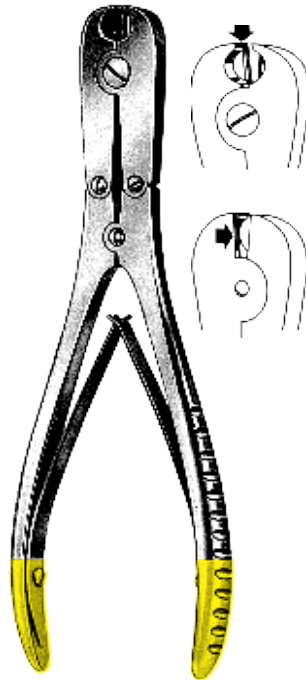

BC581518T
18 cm / 7"
For soft wires up to 2 mm Ø
For hard wires up to 1.5 mm Ø

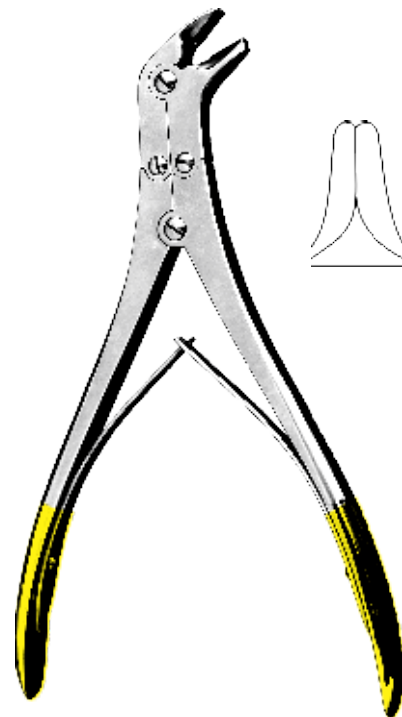

BC582017T
17 cm / 6½"
Angled slender pattern for wire removal (for soft wire up to diameter 0.9 mm) after sternum suture

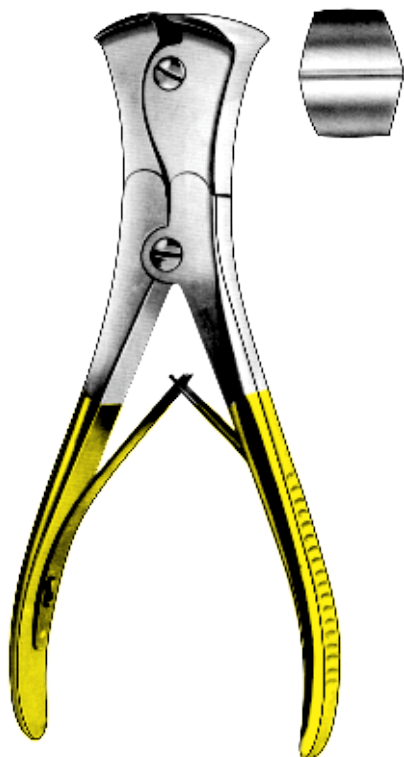

BC582522T
22 cm / 8¾"
For soft wire up to 3.5 mm Ø
For hard wire up to 2.5 mm Ø

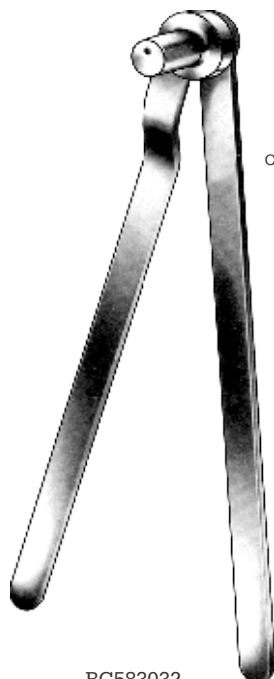

BC583032
32 cm / 12¾"
For soft wire up to 3.0 mm Ø
For hard wire up to 3.0 mm Ø

Cutter for cutting off kirschner wires
tibia head screws, bolts & pins
up to 3 mm Ø



BC583532
32 cm / 12¾"
Cut three wires at once
For soft wire up to 4.0 mm Ø
For hard wire up to 3.0 mm Ø

New pattern with three holes
cuts three wires at once
2 mm, 3 mm, 4 mm Ø

Orthopedic
Wire Cutting Pliers
Draht-Kneifzangen
Alicates para cortar alambre



Instruments with Tungsten Carbide Inserts

Tc Gold

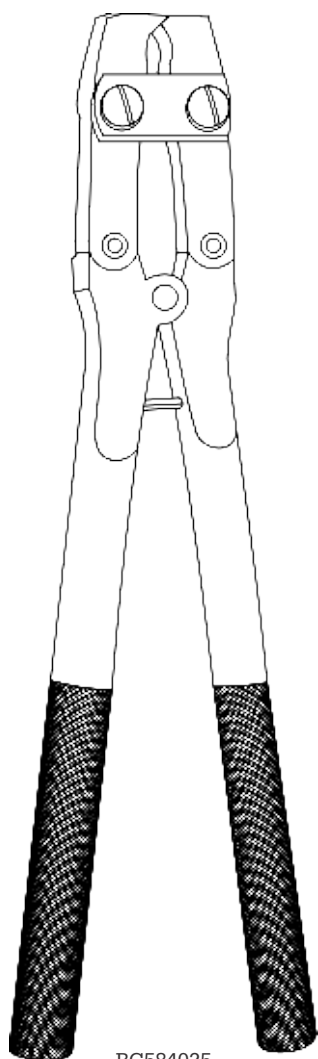

BC584025
25 cm / 10"
For wires up to 3.0 mm
Head cutter

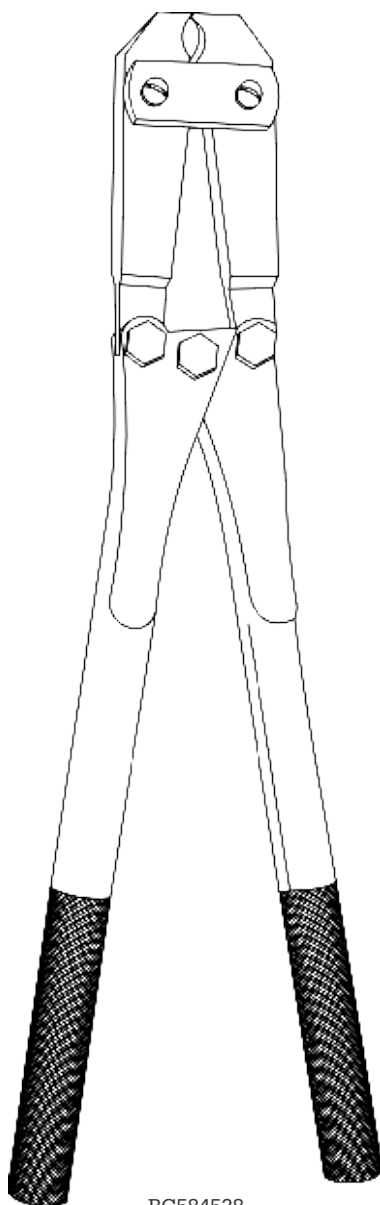

BC584538
38 cm / 15"
For wires up to 4.0 mm
Head cutter

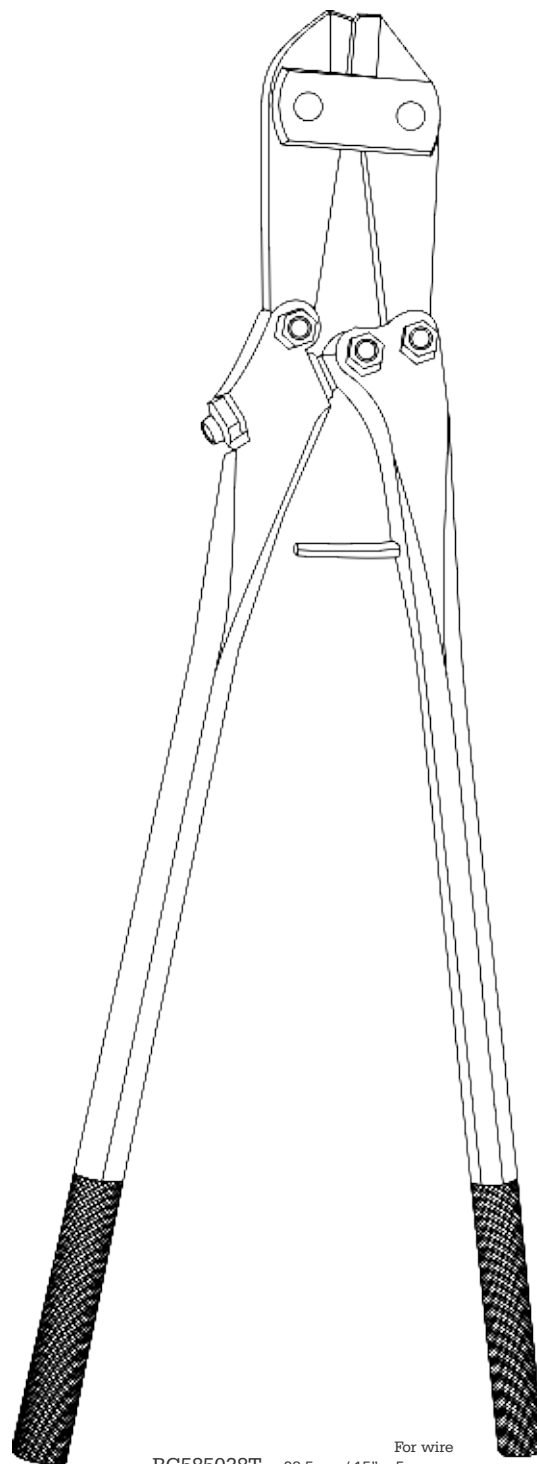

BC585038T	38.5 cm / 15"	For wire	5 mm
BC585045T	45 cm / 17 3/4"		6 mm
BC585056T	56 cm / 22"		7.5 mm
TC wire cutter			



Orthopedic
Wire Cutting Pliers
Draht-Kneifzangen
Alicates para cortar alambre

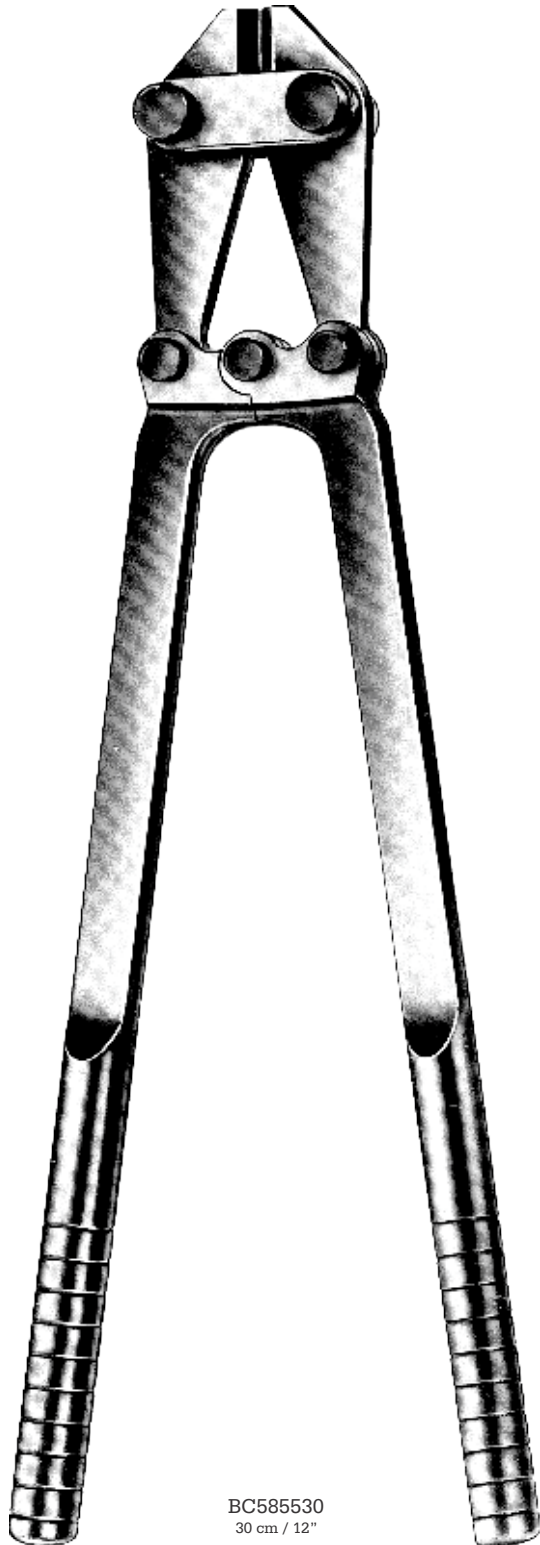

BC585530
30 cm / 12"
BC585547
47 cm / 18½"

Cutter for cutting off kirschner wires,
tibia head screws
bolts, pins up to 6 mm Ø

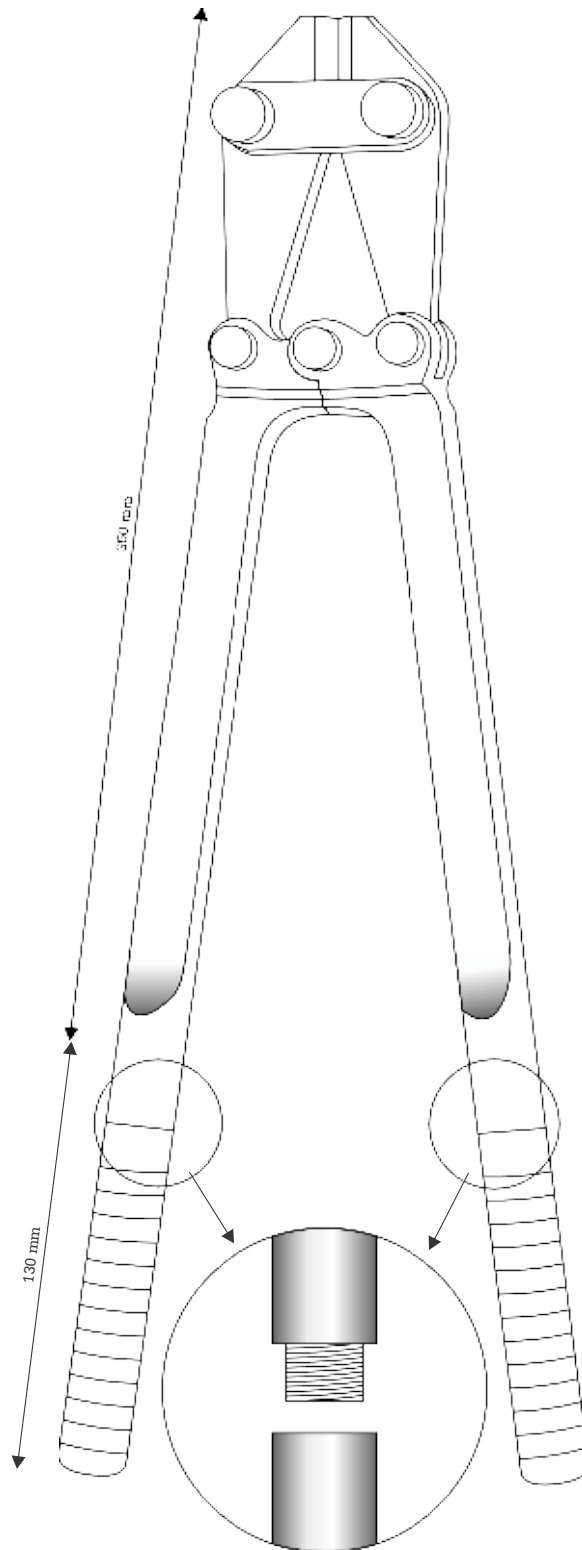

BC586048
48 cm / 19"

Cutter for cutting off wires,
head screws
and pins up to 6 mm

Orthopedic

Wire Cutting Pliers

Draht-Kneifzangen

Alicates para cortar alambre

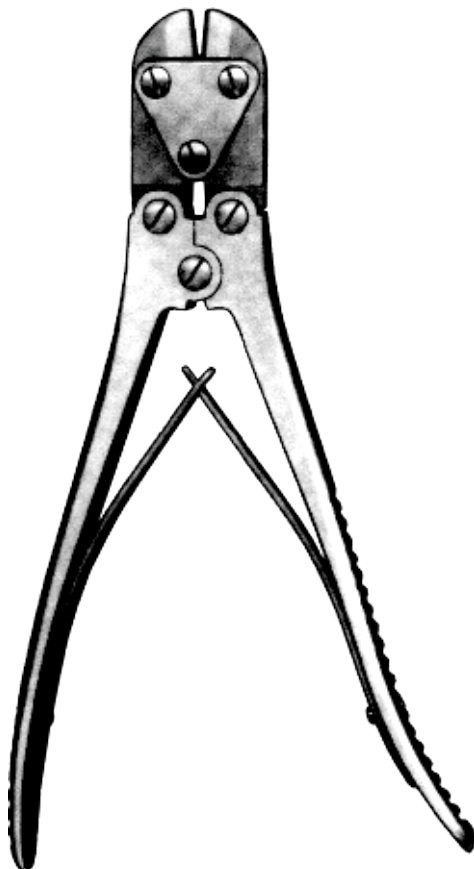
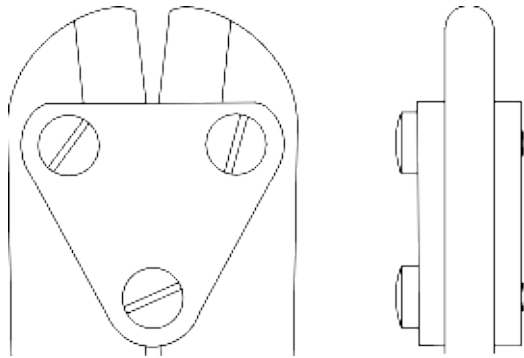

BC586524
24 cm / 9½"
Plate cutting forceps
For cutting stainless steel
mini plates up to 1 mm

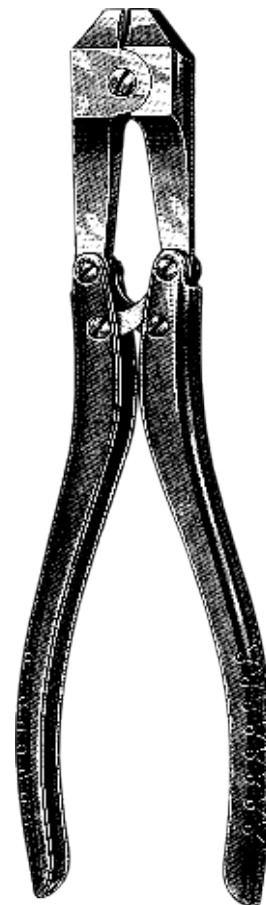

BC587038
38 cm / 15"
Surgeon double action pin cutter
Heavy duty with Carb-N-Sert cutting blades
cut upto 3/16"
Stainless steel



Orthopedic
Extension Bows
Extensionbugel
Extrijos para extension

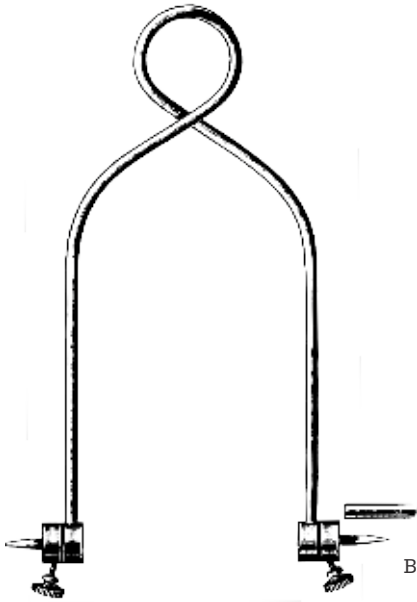

- BC587509 16 x 9 cm, 6¼" x 3½"
For arm
- BC587511 21 x 11 cm, 8¼" x 4½"
For thigh and knee
- BC587515 21 x 15 cm, 8" x 6"
For femur and knee
- 10 BC587512 8.5 x 12 cm, 3½" x 4¾"
- 10 BC587517 11 x 17 cm, 4¼" x 6¾"
- 10 BC587523 15 x 23 cm, 6" x 9"

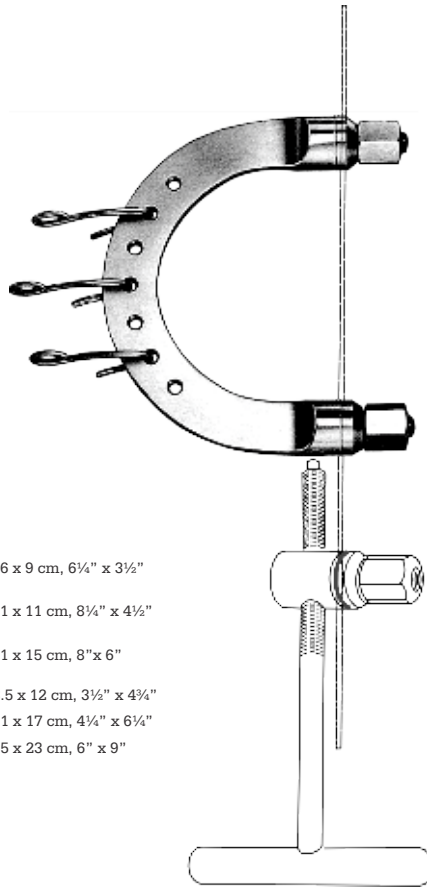

BC588500

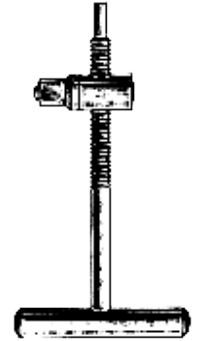

BC589000

- | Kirschner | H x B |
|-----------|----------------|
| BC588007 | 9.5 x 7.0 cm |
| BC588010 | 10.5 x 10.5 cm |
| BC588012 | 12.0 x 12.0 cm |
| BC588015 | 15.5 x 15.5 cm |
| BC588115 | 20.0 x 15.5 cm |

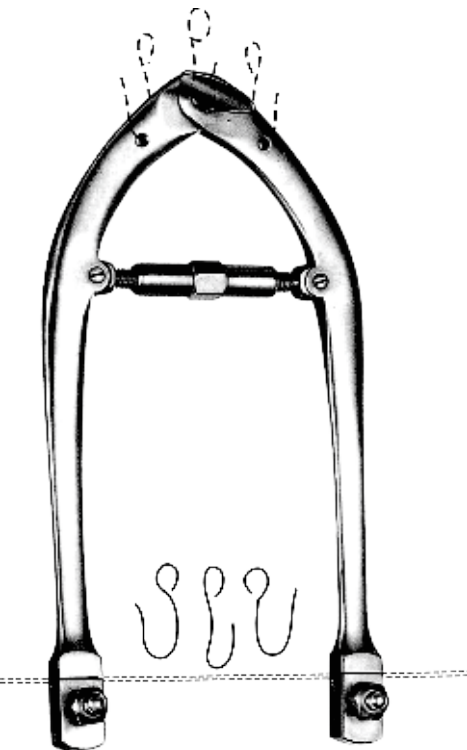

- | | h x b |
|----------|------------|
| BC589510 | 18 x 10 cm |
| BC589516 | 27 x 16 cm |

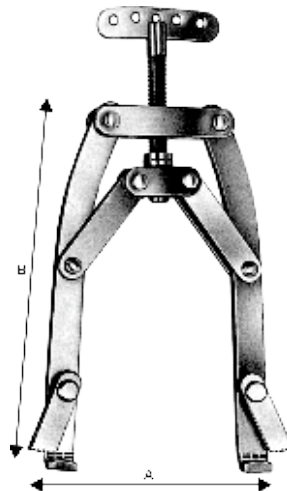

- | Kirschner U.S. | | A x B |
|----------------|---------|----------------|
| BC590120 | Small | 100 13 x 20 cm |
| BC590227 | Medium | 150 20 x 27 cm |
| BC590300 | Large | |
| BC590400 | X-Large | |



BC590500
Traction hooklet
for extension bows



BC590600
Traction hooklet
for extension bows

Orthopedic

Bone Wire Guides & Graft Passer
 Drahtumfuhrungsnadeln
 A ugujas Pass-hiles

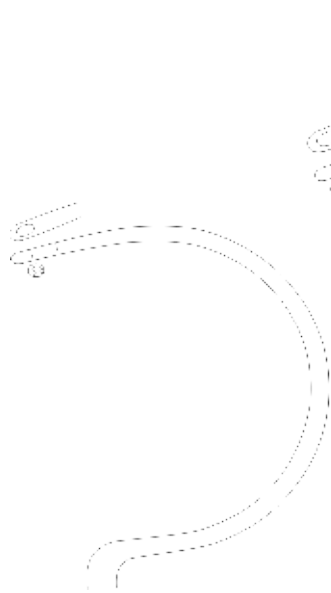

BC591027
 27.5 cm / 10¾"
 Fig. 3

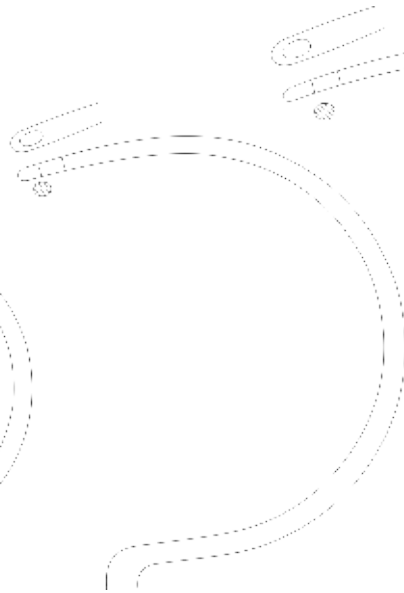

BC591028
 28.5 cm / 11¼"
 Fig. 2

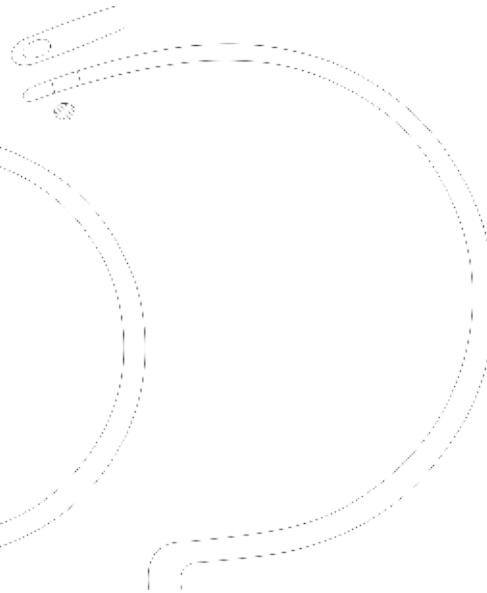

BC591030
 30.5 cm / 12"
 Fig. 1

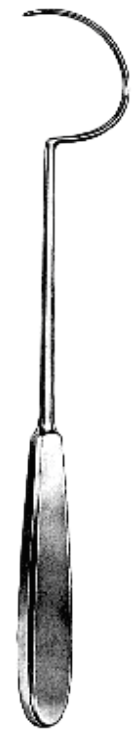

Demel
 Wire guides

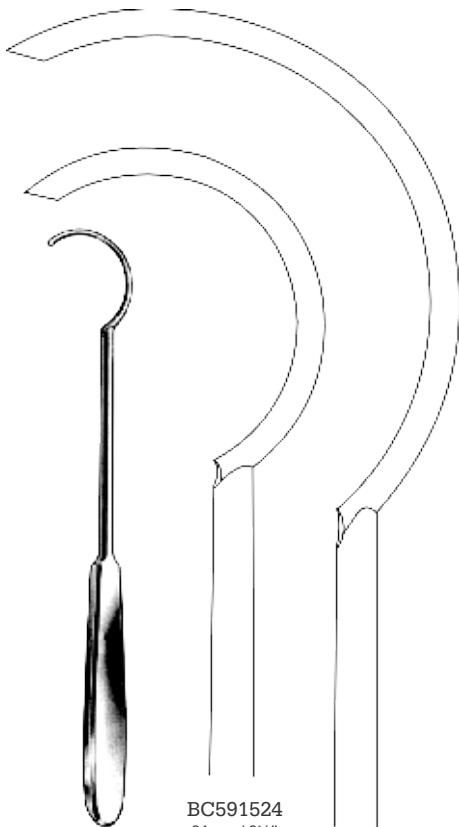

BC591524
 24 cm / 9½"

BC591527
 27 cm / 10¼"

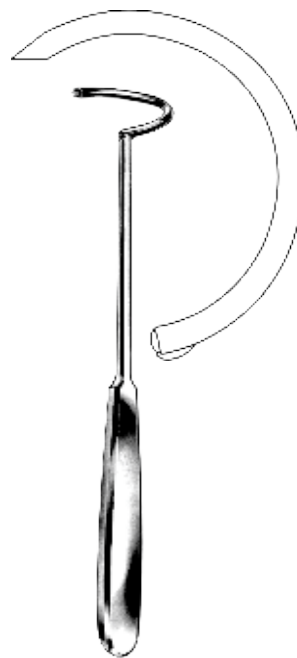

BC592022
 22.5 cm / 9"

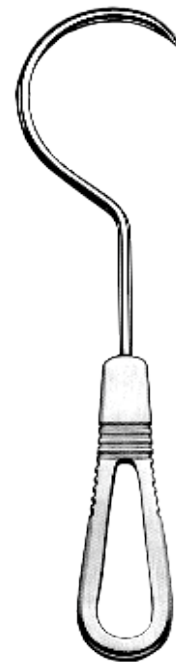

Graft Passer
 BC592500
 XL-Large
 Curved
 Slot cut into head



BC592600
 X-Small



BC592700
 Small



BC592800
 Large

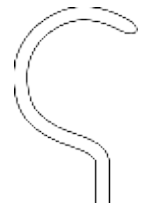

BC592900
 X-Large



Orthopedic
Bone Wire Tighteners, Wire Passers & Bone Nailing
Drahtspanninstrumente
Tensores cierra-hilo

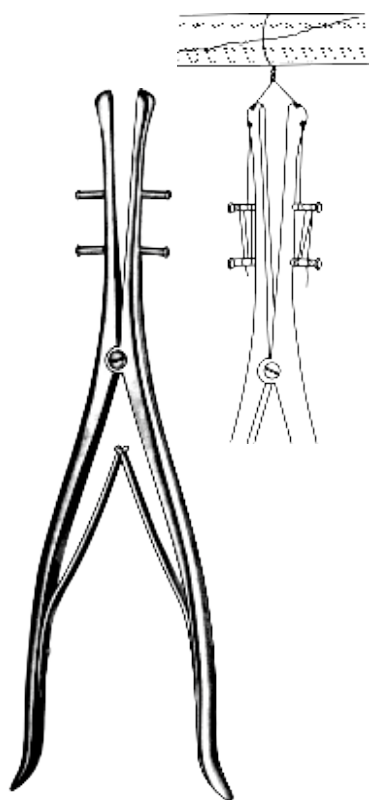

Demel
BC593028
28 cm / 11"

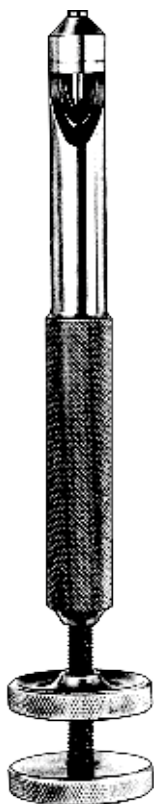

Loute
BC593521
21 cm / 8 1/4"



BC594000
Cerclage wire passer



BC594500
45 mm Ø



BC595000
70 mm Ø



Kuentscher
26 cm / 10 1/4"
BC595526 8 mm
BC595626 10 mm
BC595726 12.5 mm



Kuentscher
BC596035
35 cm / 14"



BC596500
BC596600

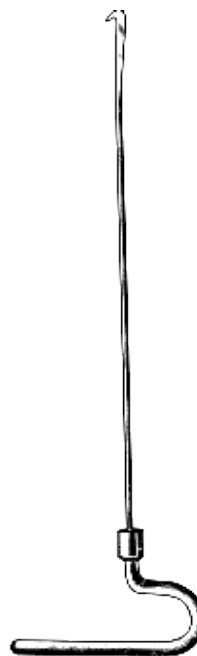

BC597029 29 cm / 11 1/2"
BC597037 37 cm / 14 3/4"
BC597042 42 cm / 16 1/2"
BC597049 49 cm / 19 1/2"

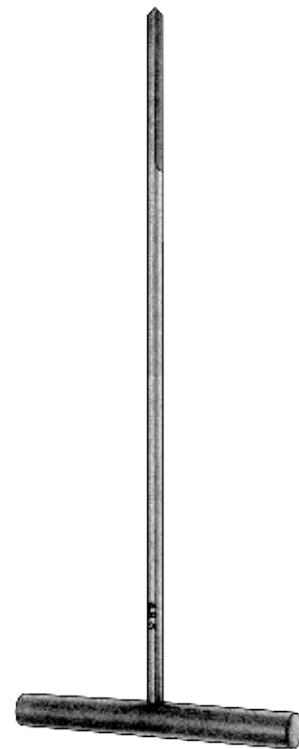

BC597500 2.4 mm Ø
BC597600 3.2 mm Ø
BC597700 4.8 mm Ø
BC597800 6.4 mm Ø

Orthopedic
Bone Nailing Instruments



BC598000
2.4 mm ϕ



BC598500
3.2 mm ϕ



BC599000
4.8 mm ϕ



BC599500
6.4 mm ϕ



BC600100 2.4 mm ϕ
BC600200 3.2 mm ϕ
BC600300 4.8 mm ϕ
BC600400 6.4 mm ϕ



BC600521
21 cm / 8 1/4"



Kuentscher
BC601021
21 cm / 8 1/4"



Kuentscher
BC601521
21 cm / 8 1/4"



BC602100



BC602200



BC602300



BC602400



Kuentscher
BC602063
63 cm / 25 1/4"

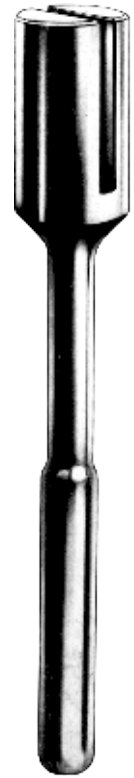

BC602500



Orthopedic Bone Plate Benders



3.5 mm
4.5 mm
6 mm

4.5 mm
3.5 mm
4 mm

BC603020 3.5 mm, 4.5 mm
BC603120 4.5 mm, 3.5 mm
20 cm / 8"
BC603225 6 mm, 4 mm
25 cm / 8"

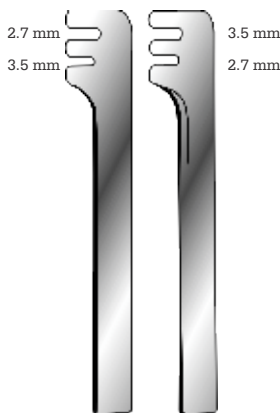

2.7 mm 3.5 mm 3.5 mm 2.7 mm

BC603514
14 cm / 5½"
Plate benders
Pair



1.5 mm
1.8 mm
2 mm

BC604013 1.5 mm
BC604113 2 mm
13 cm / 5¼"
BC604212 1.8 mm
12 cm / 4¾"

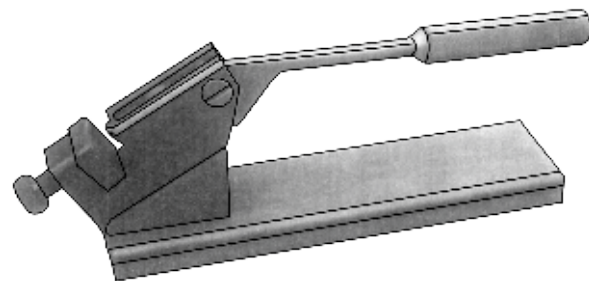

BC604500
Large bone plate press
BC604600
Small bone plate press

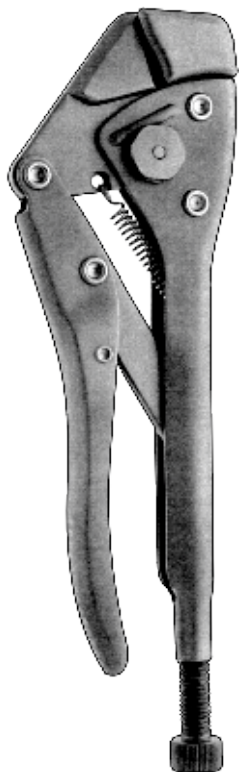

BC605022
22 cm / 8¾"

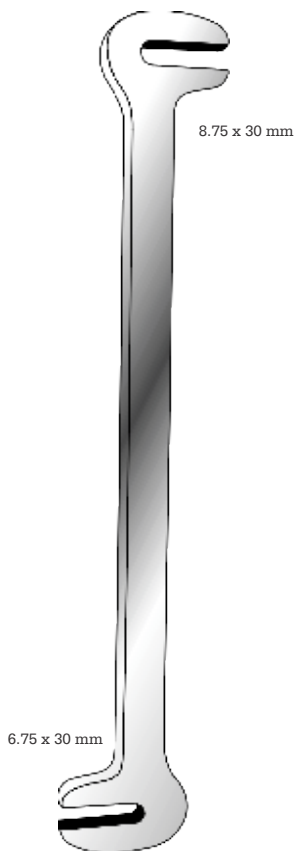

8.75 x 30 mm

6.75 x 30 mm

BC605523 23 cm / 9"
BC605518 18 cm / 7"
Thickness 14 mm
Wide 9 mm
Bone plate bender

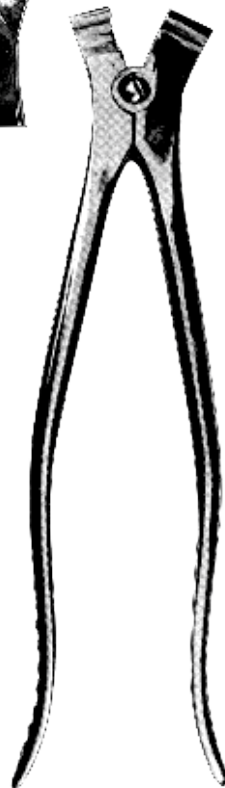

BC606000
Plate bending plier



BC606500
Plate bending plier