



AC

Artery Forceps

AC
Artery Forceps



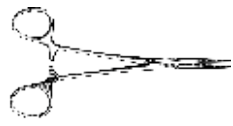

Artery Forceps Bulldog Clamps Bulldogklemmen Clamps Bulldog

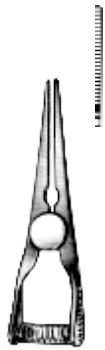

AC300103
3.5 cm / 1½"



AC300503
3.5 cm / 1½"



AC301004
4.5 cm / 1¾"



AC301504
4.5 cm / 1¾"



Dieffenbach
AC302003 3.8 cm / 1½"
AC302004 4.8 cm / 2"



Dieffenbach
AC302503
AC302504



Dieffenbach
AC303005
5.8 cm / 2¼"



Dieffenbach
AC303505
5.8 cm / 2¼"



Johns-Hopkins
AC304005 5 cm / 2"
AC304006 6.5 cm / 2½"
AC304007 7.5 cm / 3"

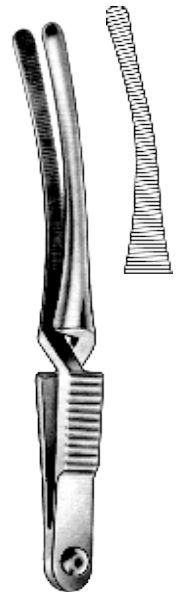

AC304505
AC304506
AC304507

Artery Forceps

Artery Forceps
Arterienklemmen
Pinzas Hemostaticas

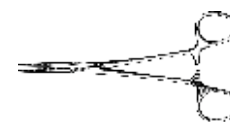

Halsted-Mosquito
Normal



Normal

AC305009	9 cm / 3½"
AC040710	10 cm / 4"
AC305012	12 cm / 4¾"
AC041112	12.5 cm / 5"
AC305018	18 cm / 7"
AC305020	21 cm / 8¼"



Normal

AC305109	
AC040810	
AC305112	
AC041212	
AC305118	
AC305120	



Normal

AC305209	9 cm / 3½"
AC305210	10 cm / 4"
AC305212	12 cm / 4¾"
AC041312	12.5 cm / 5"
AC305218	18 cm / 7"
AC305220	21 cm / 8¼"

1:2 Teeth



Normal

AC305309	
AC305310	
AC305312	
AC041512	
AC305318	
AC305320	

1:2 Teeth



Micro-Mosquito



Micro

AC305509	9 cm / 3½"
AC042110	10 cm / 4"
AC042112	12 cm / 4¾"



Micro

AC305609	
AC042210	
AC042212	



Micro

AC305709	9 cm / 3½"
AC042310	10 cm / 4"
AC042312	12 cm / 4¾"

1:2 Teeth



Micro

AC305809	
AC042410	
AC042412	

1:2 Teeth

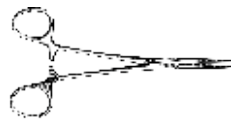

Artery Forceps Artery Forceps Arterienklemmen Pinzas Hemostaticas

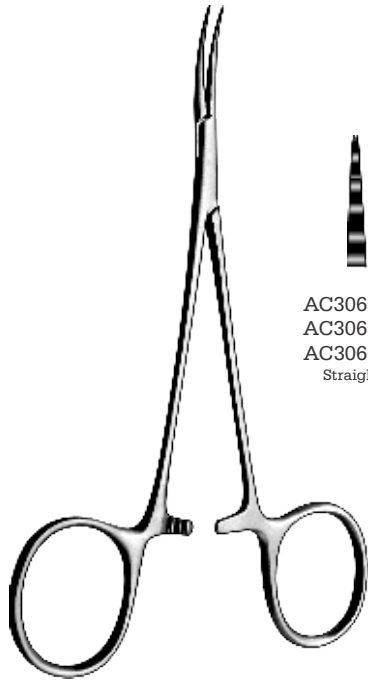

Mosquito
Extra extra micro



AC306009 9 cm / 3½"
AC306010 10 cm / 4"
AC306012 12 cm / 4¾"
Straight



AC306109
AC306110
AC306112
Curved



Providence-Hospital
14 cm / 5½"



AC042514
Straight



AC042614
Curved

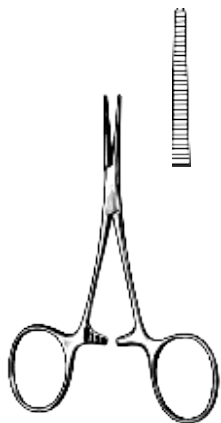

Carrel
AC306510
10 cm / 4"

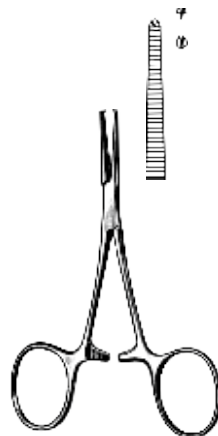

Terrier
AC307010
10 cm / 4"
1:2 Teeth

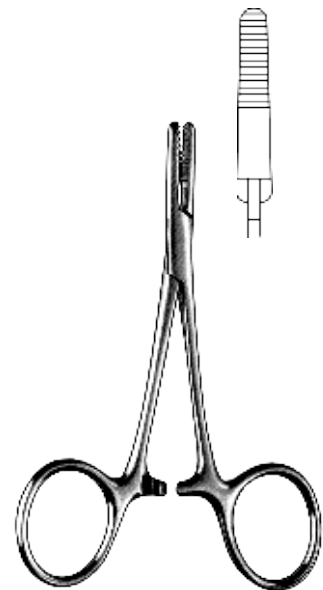

Terrier
AC307512
12 cm / 4¾"



Artery Forceps

Artery Forceps
Arterienklemmen
Pinzas Hemostaticas

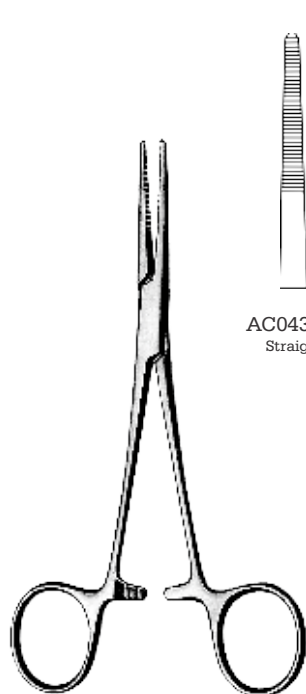
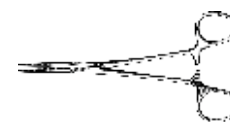

Kelly
14 cm / 5½"

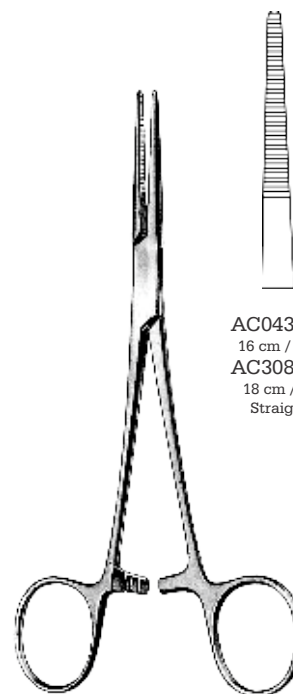
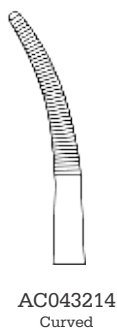

Kelly-Rankin

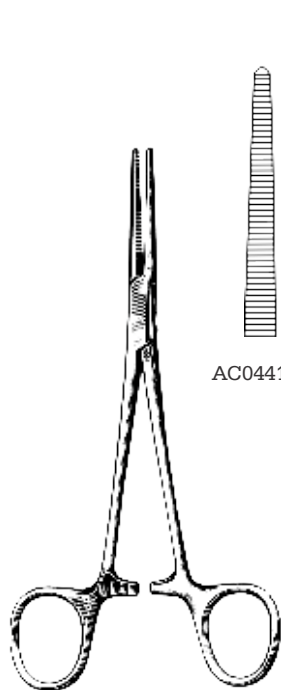
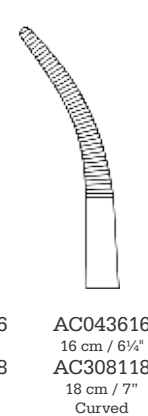
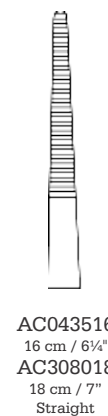

Crile
14 cm / 5½"

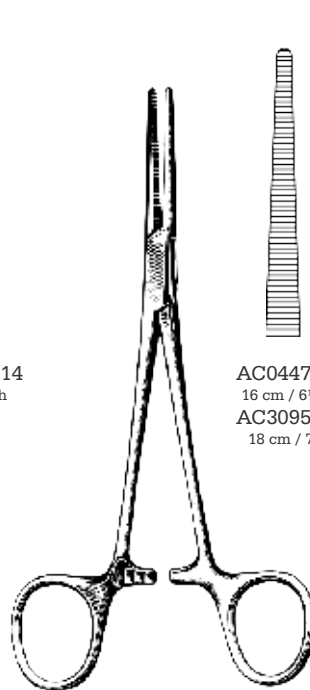
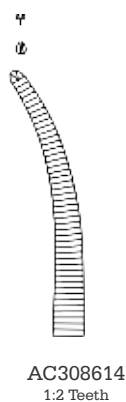
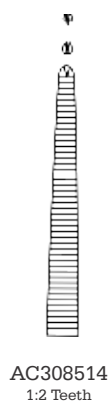
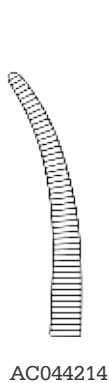

Crile-Rankin

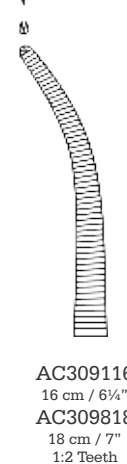
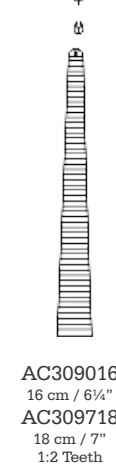
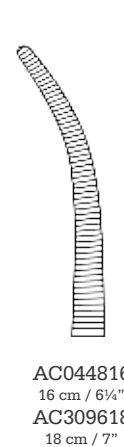



Artery Forceps Artery Forceps, Delicate Arterienklemmen Pinzas Hemostaticas

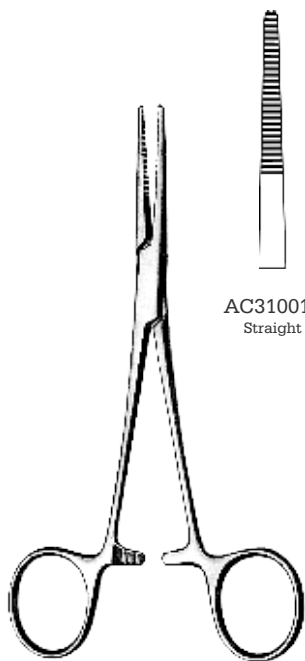

Kelly
14 cm / 5½"
Delicate

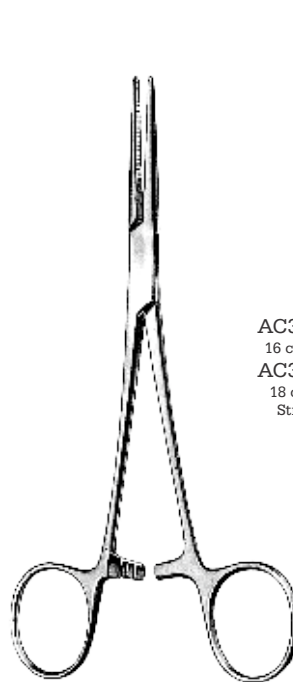

Kelly-Rankin
Delicate

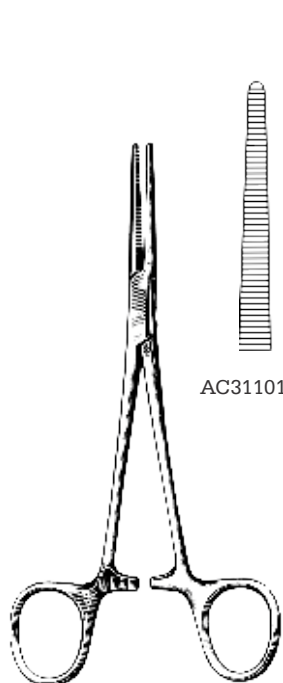
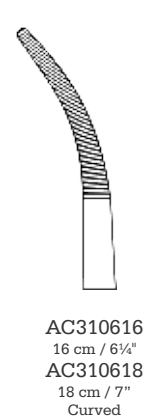

Crile
14 cm / 5½"
Delicate

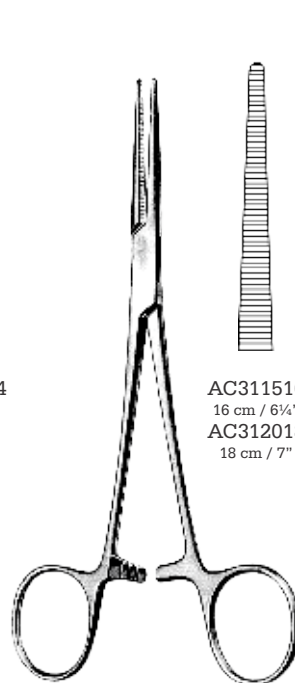
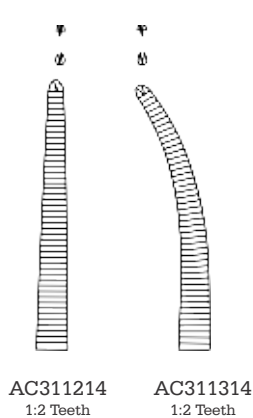
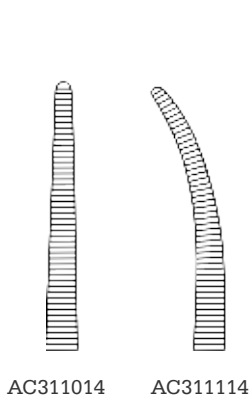

Crile-Rankin
Delicate

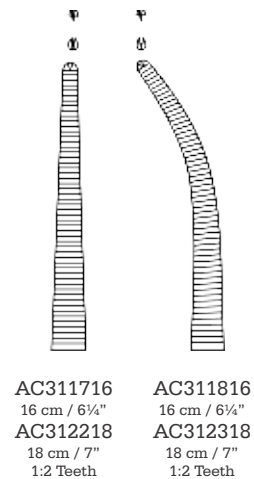
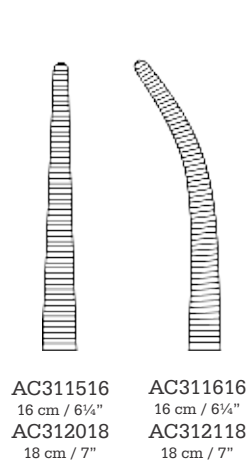

Artery Forceps

Artery Forceps
Arterienklemmen
Pinzas Hemostaticas

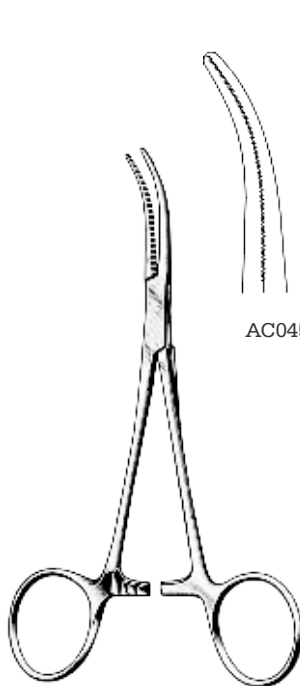
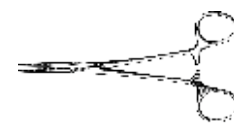

Dandy
14 cm / 5½"
Curved side ways

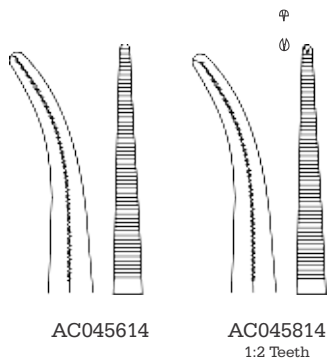

AC045614

AC045814
1:2 Teeth

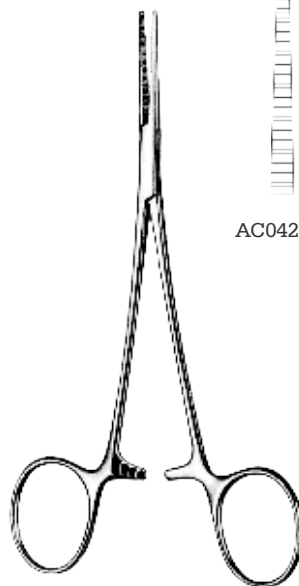

Leriche
15 cm / 6"

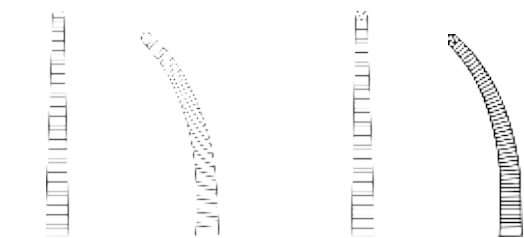

AC042715

AC042815

AC042915
1:2 Teeth

AC043015
1:2 Teeth

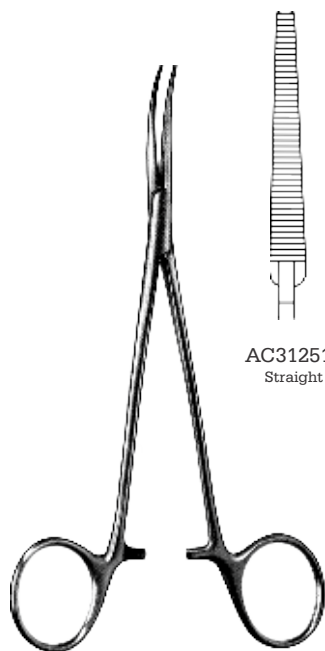

Christophe
16 cm / 6¼"

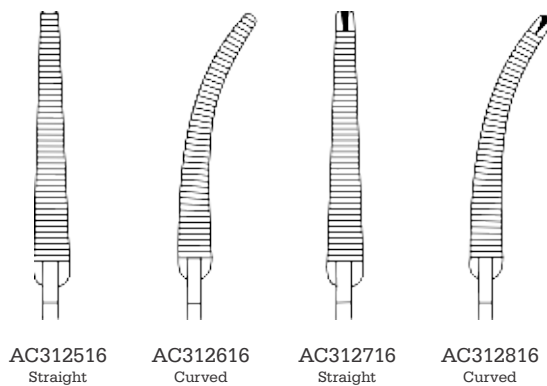

AC312516
Straight

AC312616
Curved

AC312716
Straight

AC312816
Curved



Kilner
AC313014 Straight
AC313114 Curved
14 cm / 5½"

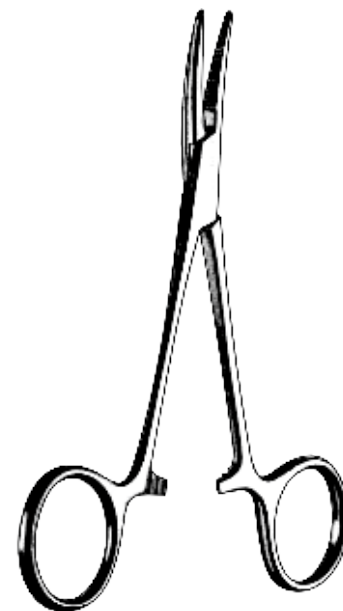

Dunhill
AC313512
12.5 cm / 5"

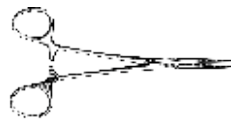

Artery Forceps

Artery Forceps
Arterienklemmen
Pinzas Hemostaticas

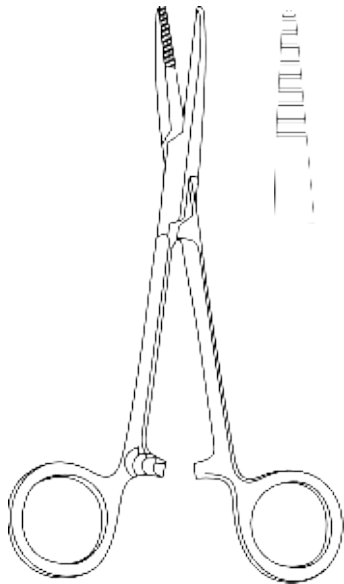

Grey-Turner
AC314015 Straight
AC314115 Curved
15 cm / 6"

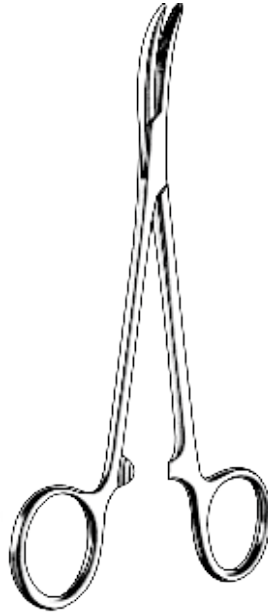

Cairns
AC314514 Straight
AC314614 Curved
14.5 cm / 5 7/8"

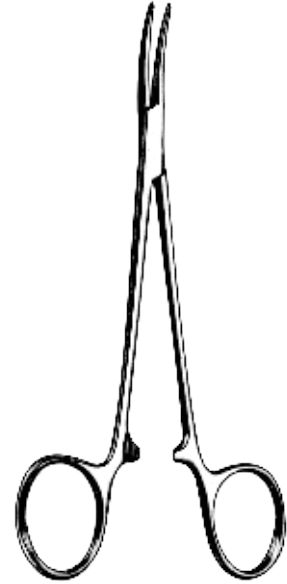

Cushing
AC315014 Straight
AC315114 Curved
14.5 cm / 5 7/8"

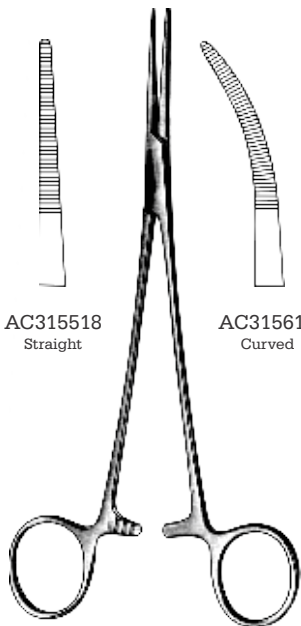

AC315518
Straight

AC315618
Curved

Birkett
18.5 cm / 7 1/4"

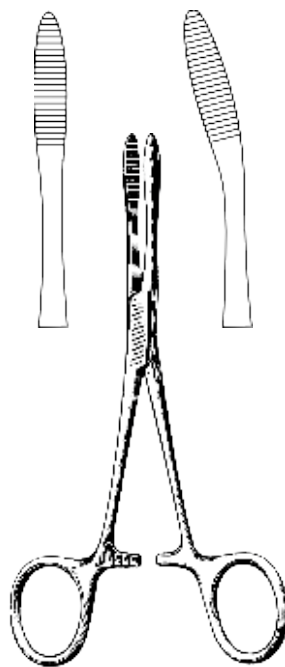

Pean
AC316012 12.5 cm / 5" AC316112
AC316014 14 cm / 5 1/2" AC316114
AC316016 16 cm / 6 1/4" AC316116
Straight Curved

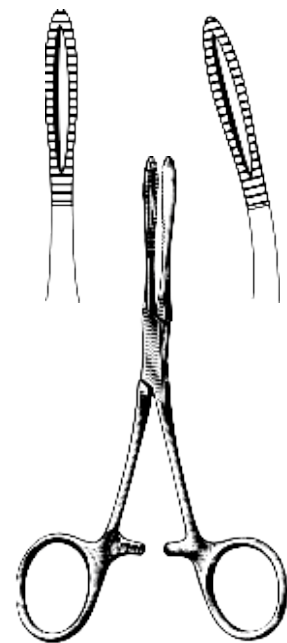

Kroenlien
AC316514 Straight
AC316614 Curved
14 cm / 5 1/2"

Artery Forceps

Artery Forceps, Haemostatic Forceps

Arterienklemme

Pinzas Hemostaticas

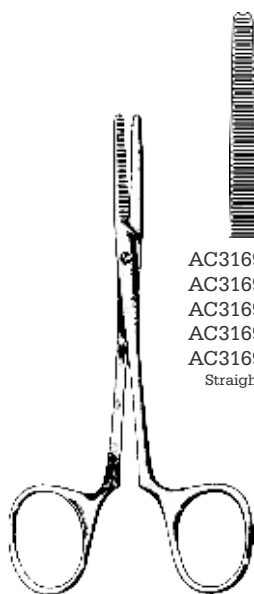
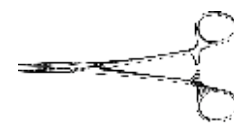

Spencerwells

AC316912	12.5 cm / 5"
AC316915	15 cm / 6"
AC316918	18 cm / 7"
AC316920	20 cm / 8"
AC316923	23 cm / 9"
Straight	



AC317012	
AC317015	
AC317018	
AC317020	
AC317023	
Curved	

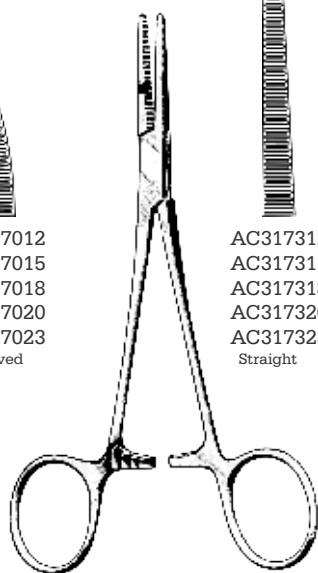

Spencerwells

AC317312	12.5 cm / 5"
AC317315	15 cm / 6"
AC317318	18 cm / 7"
AC317320	20 cm / 8"
AC317323	23 cm / 9"
Straight	



AC317412	
AC317415	
AC317418	
AC317420	
AC317423	
Curved	

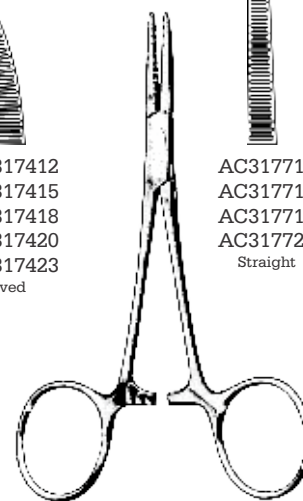

Jones

AC317712	12.5 cm / 5"
AC317715	15 cm / 6"
AC317718	18 cm / 7"
AC317720	20 cm / 8"
Straight	



AC317812	
AC317815	
AC317818	
AC317820	
Curved	

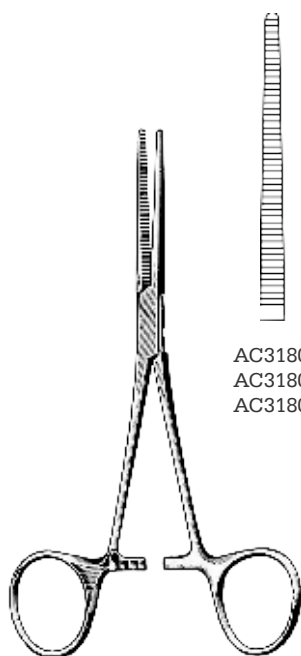

AC318013	13.5 cm / 5 1/4"	AC318113
AC318014	14.5 cm / 5 3/4"	AC318114
AC318017	17 cm / 6 3/4"	AC318117

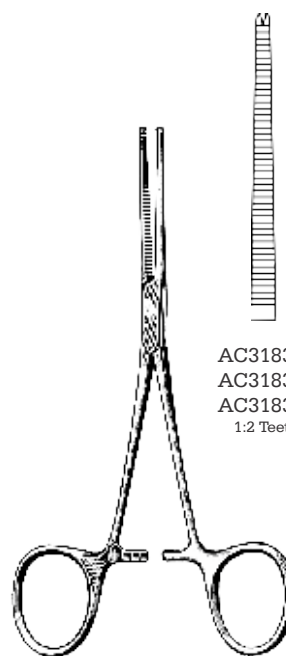
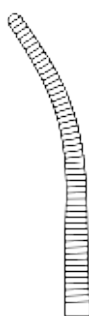

AC318313	13 cm / 5"	AC318413
AC318314	14 cm / 5 1/2"	AC318414
AC318316	16 cm / 6 1/4"	AC318416
1:2 Teeth		1:2 Teeth





Artery Forceps Delicate Artery Forceps Arterienklemmen Pinzas hemostaticas

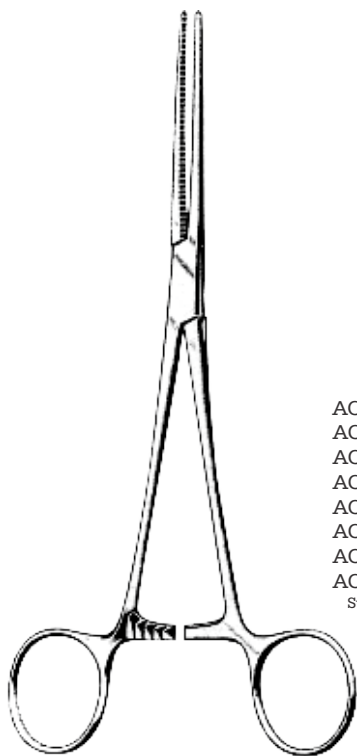

Rochester-Pean

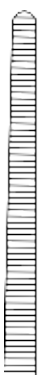
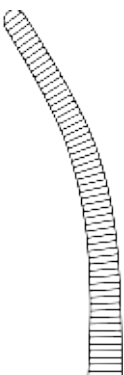
		
AC051114	14 cm / 5½"	AC051214
AC051116	16 cm / 6¼"	AC051216
AC051118	18 cm / 7"	AC051218
AC051120	20 cm / 8"	AC051220
AC051122	22 cm / 8¾"	AC051222
AC051124	24 cm / 9½"	AC051224
AC051126	26 cm / 10½"	AC051226
AC051130	30 cm / 12"	AC051230
	Straight	Curved

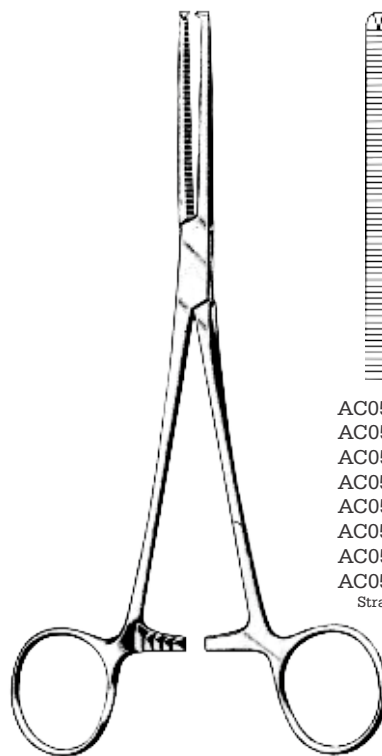

Rochester-Ochsner

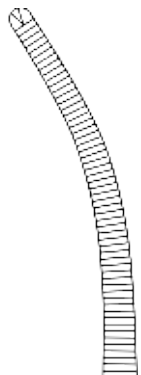
		
AC051514	14 cm / 5½"	AC051614
AC051516	16 cm / 6¼"	AC051616
AC051518	18 cm / 7"	AC051618
AC051520	20 cm / 8"	AC051620
AC051522	22 cm / 8¾"	AC051622
AC051524	24 cm / 9½"	AC051624
AC051526	26 cm / 10½"	AC051626
AC051530	30 cm / 12"	AC051630
	Straight	Curved

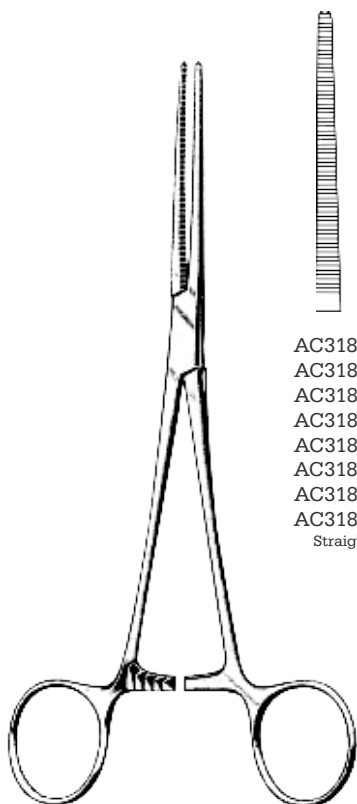

Rochester-Pean
Delicate

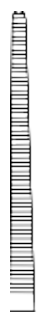
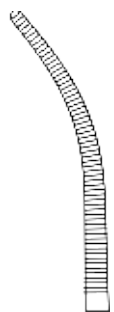
		
AC318614	14 cm / 5½"	AC318714
AC318616	16 cm / 6¼"	AC318716
AC318618	18 cm / 7"	AC318718
AC318620	20 cm / 8"	AC318720
AC318622	22 cm / 8¾"	AC318722
AC318624	24 cm / 9½"	AC318724
AC318626	26 cm / 10½"	AC318726
AC318630	30 cm / 12"	AC318730
	Straight	Curved

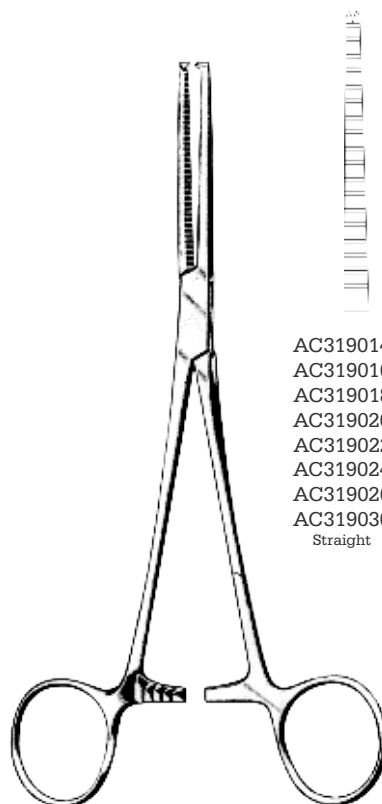

Rochester-Ochsner
Delicate

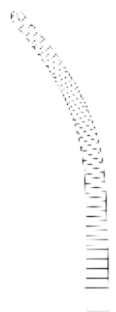
		
AC319014	14 cm / 5½"	AC319114
AC319016	16 cm / 6¼"	AC319116
AC319018	18 cm / 7"	AC319118
AC319020	20 cm / 8"	AC319120
AC319022	22 cm / 8¾"	AC319122
AC319024	24 cm / 9½"	AC319124
AC319026	26 cm / 10½"	AC319126
AC319030	30 cm / 12"	AC319130
	Straight	Curved

Artery Forceps

Artery Forceps
Arterienklemmen
Pinzas Hemostaticas

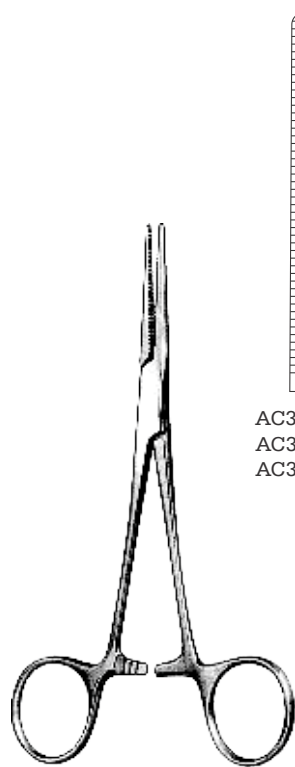
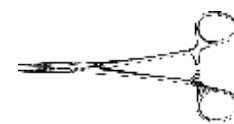

Pean-Nippon



AC319314 14.5 cm / 5 3/4"
AC319316 16.5 cm / 6 1/2"
AC319318 18.5 cm / 7 1/4"

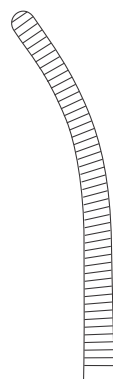

AC319414
AC319416
AC319418

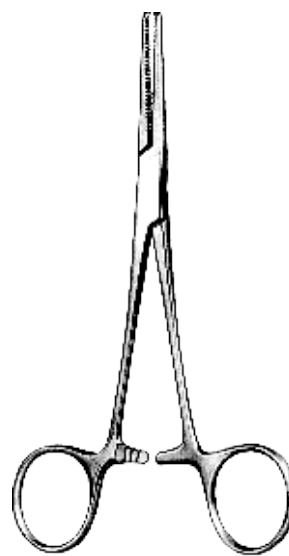

Kocher-Nippon
1:2 Teeth



AC319714 14.5 cm / 5 3/4"
AC319716 16.5 cm / 6 1/2"
AC319718 18.5 cm / 7 1/4"



AC319814
AC319816
AC319818

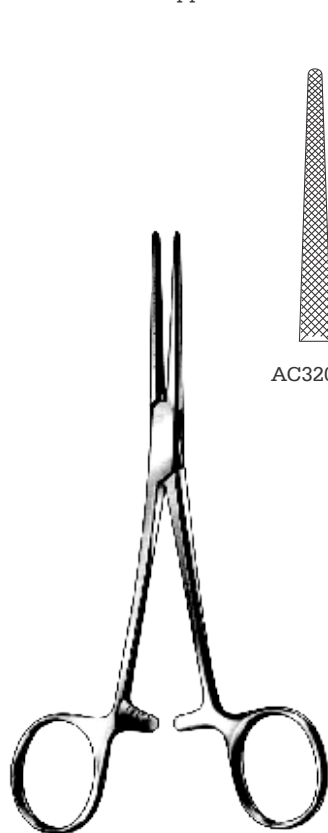

Dixon-Lovelace
16 cm / 6 1/4"



AC320016



AC320116
1:2 Teeth

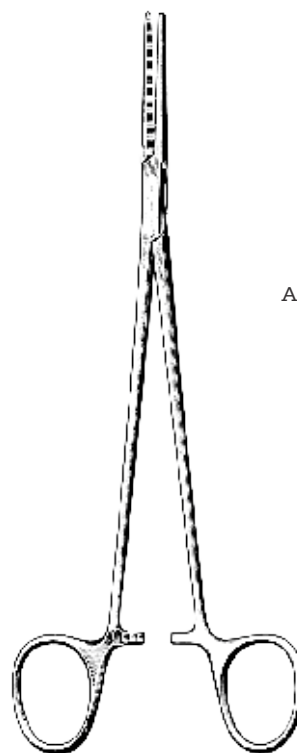

Heiss
20 cm / 8"



AC320301

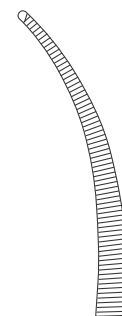

AC320302

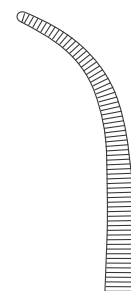

AC320303



AC320401
1:2 Teeth



AC320402
1:2 Teeth



Artery Forceps Artery Forceps Arterienklemmen Pinzas Hemostaticas

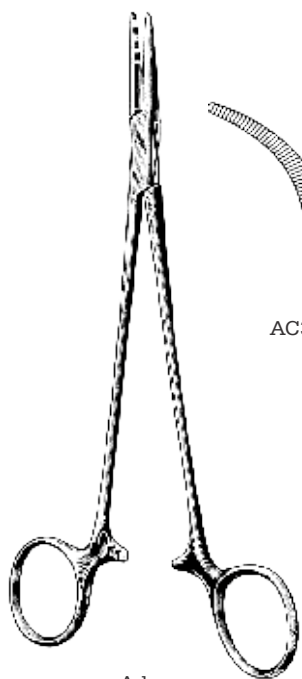

Adson
18 cm / 7"

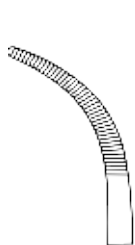

AC320518



AC320618



AC320718

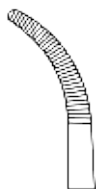

AC320818

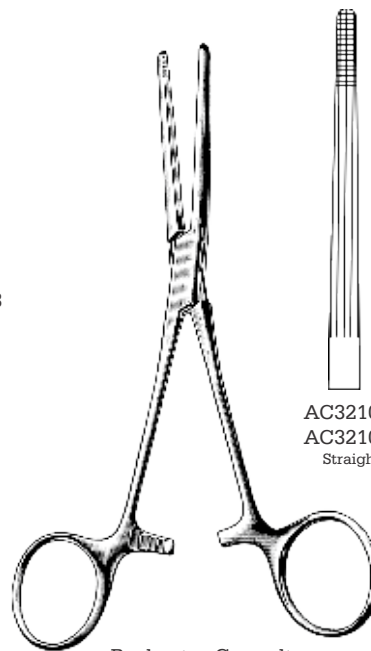

Rochester-Carmalt



AC321016
AC321020
Straight

16 cm / 6 1/4"
20 cm / 8"



AC321116
AC321120
Curved

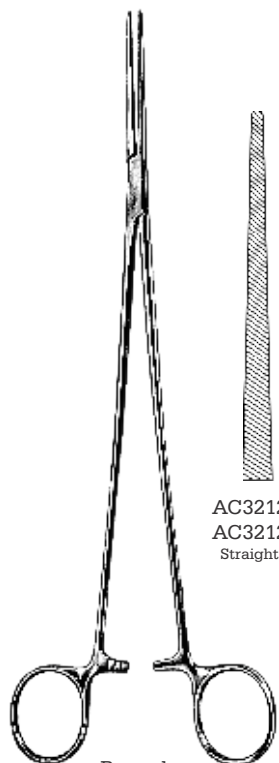

Bengolea



AC321220
AC321226
Straight

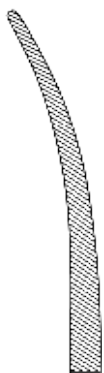

AC321320
AC321326
Curved

20 cm / 8"
26 cm / 10 1/4"



AC321420
AC321426
Straight
1:2 Teeth

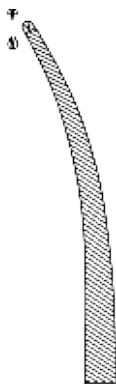

AC321520
AC321526
Curved
1:2 Teeth

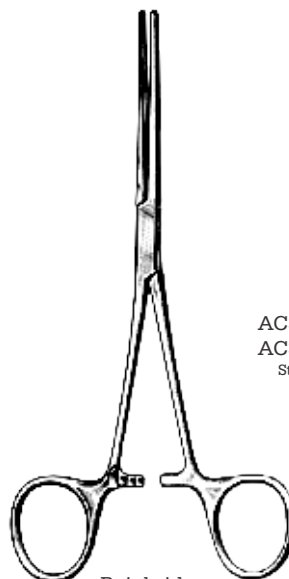

Bainbridge



AC321815
AC321818
Straight

15 cm / 6"
18.5 cm / 7 1/4"



AC321915
AC321918
Curved

Artery Forceps

Tissue & Organ Grasping Forceps

Gewebe und Organfazzangen

Pinzas para tejidos Y para sacar organos

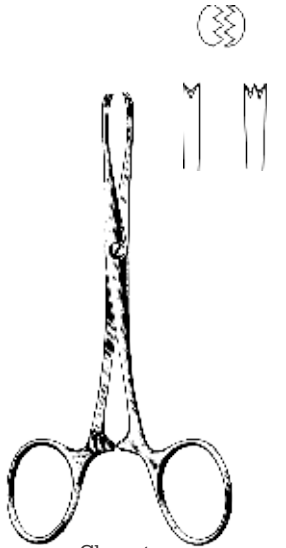
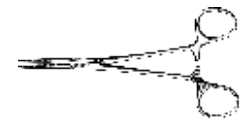

Chaput
AC322013 13 cm / 5"
AC322016 16 cm / 6¼"



Tuffier
AC322513
13 cm / 5"

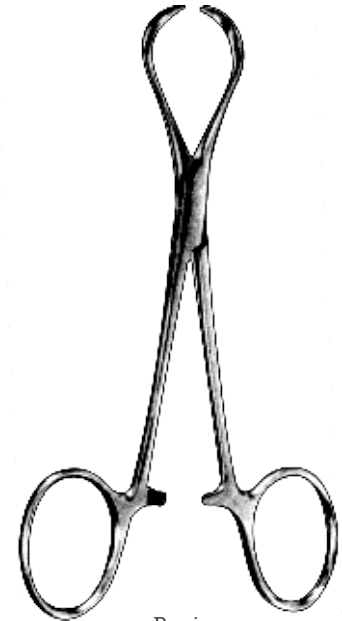

Porrier
AC323012 12.5 cm / 5"
AC323018 18 cm / 7"

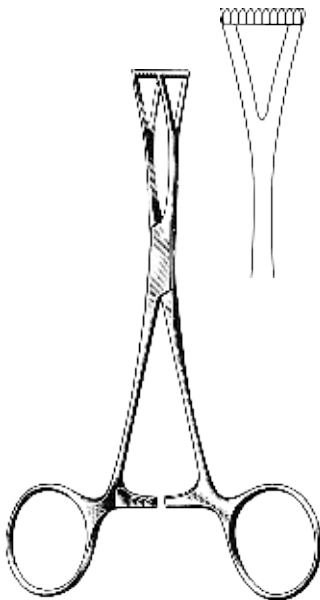

Collin
AC323514
14 cm / 5½"

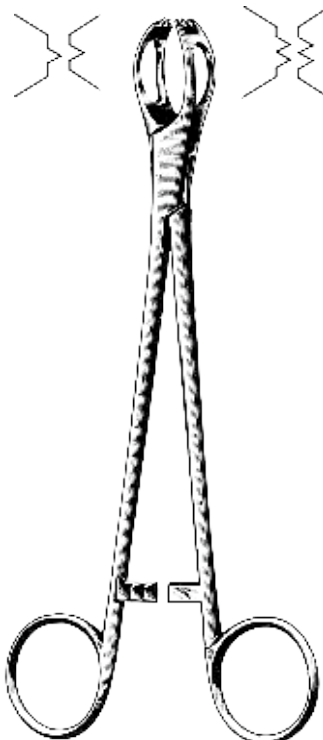

Lane
AC324012 12.5 cm / 5" AC324112
AC324015 15 cm / 6" AC324115
AC324019 19 cm / 7½" AC324119
1:2 Teeth 2:3 Teeth

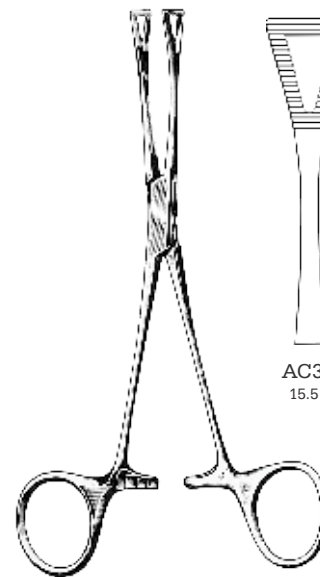

Pennington

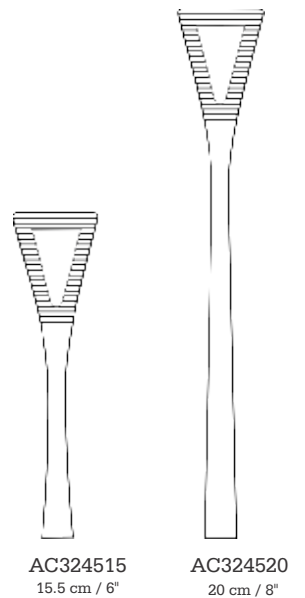

AC324515
15.5 cm / 6"

AC324520
20 cm / 8"



Artery Forceps

Tissue & Organ Grasping Forceps
Gewebe und Organfazzangen
Pinzas para tejidos Y para sacar organos



AC325012



AC325112

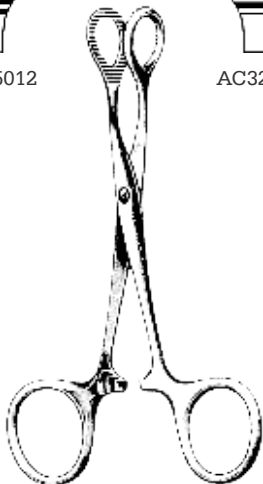

Pean
12 cm / 4¾"

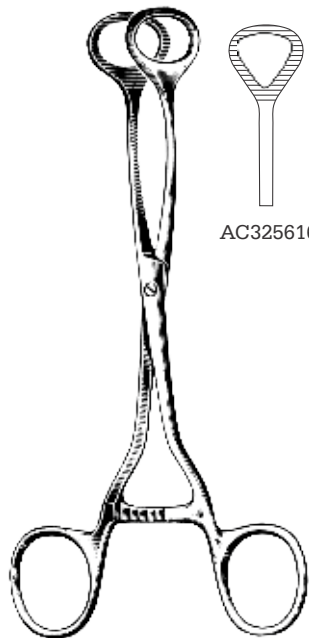

Collin
AC325516
16 cm / 6¼"

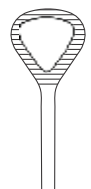

AC325616

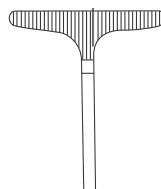

AC325716



AC325816

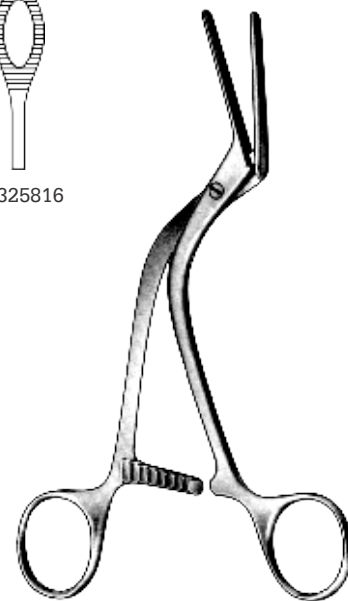

Hopfner
AC326016
16 cm / 6¼"
Vessel clamps

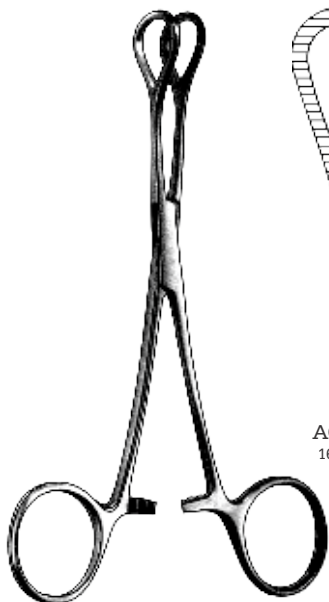

Coeur

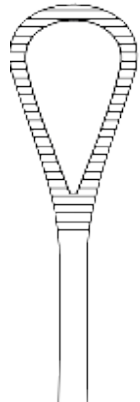

AC326516
16 cm / 6¼"

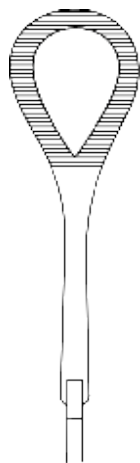

AC326618 18 cm / 7"
AC326620 20 cm / 8"
AC326622 22 cm / 9"

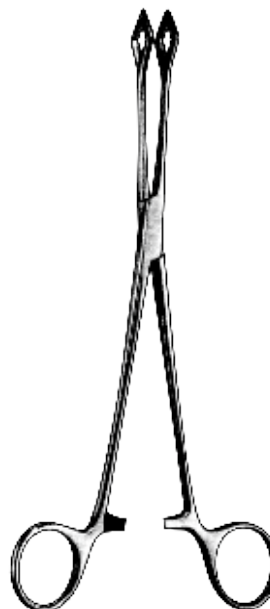

Gregoire



AC327016 16 cm / 6¼"
AC327018 18 cm / 7"
AC327020 20 cm / 8"
AC327022 22 cm / 9"

Artery Forceps

Tissue, Organ Grasping Forceps & Angiotribs
 Gewebe, Organfasszangen und Druckklemmen
 Tejidos, Sacar organos Y para clamp de persion progresiva

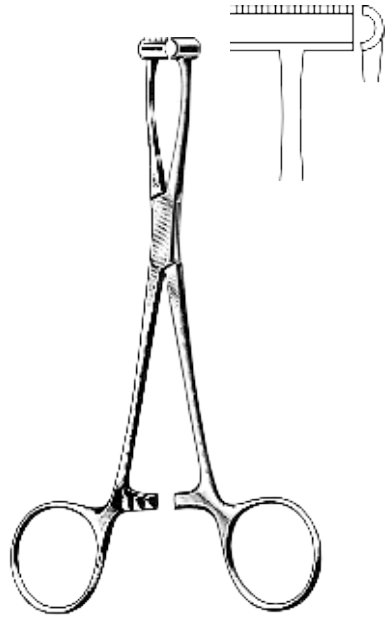
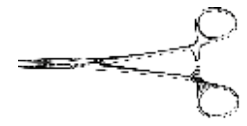

Pratt
 AC327515
 15 cm / 6"

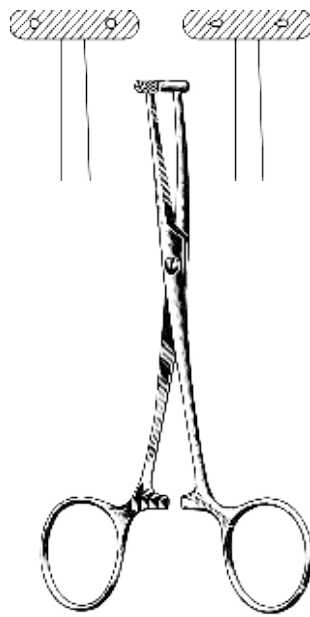

Martel
 AC328014
 14 cm / 5½"
 Face lift forceps

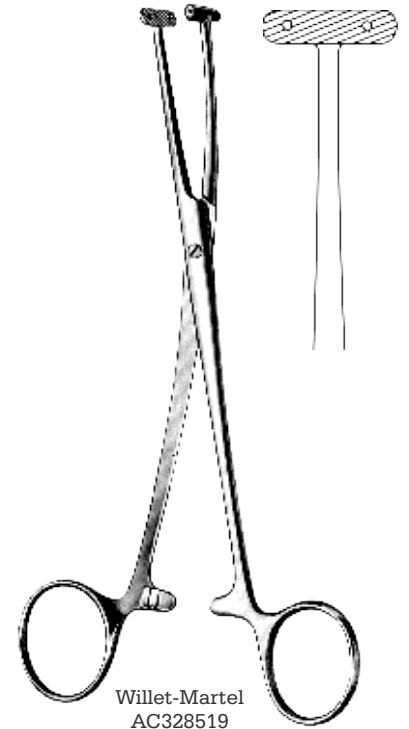

Willet-Martel
 AC328519
 19 cm / 7½"

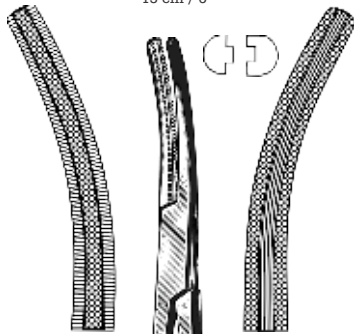

Buie
 AC329021
 21 cm / 8¼"

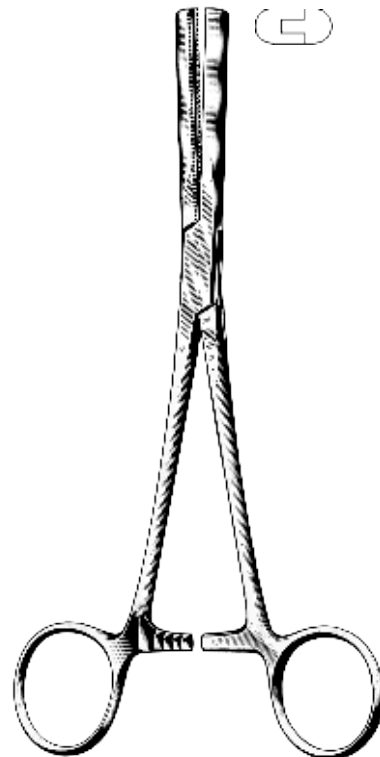

Fergusson

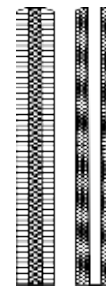

AC329517
 17 cm / 6¾"

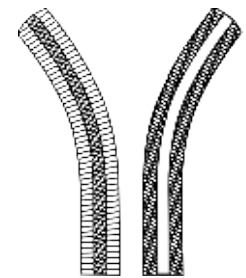

AC329617
 17 cm / 6¾"

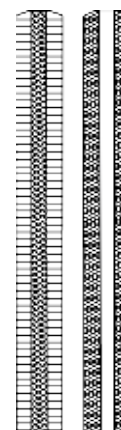

AC329520
 20 cm / 8"

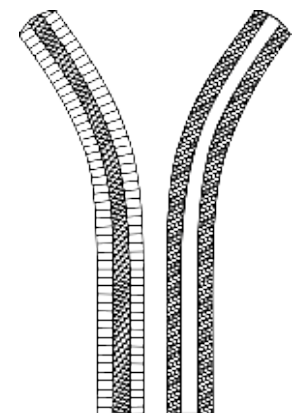

AC329620
 20 cm / 8"



Artery Forceps

Artery Forceps, Dissecting and Ligature Forceps
 Arterienklemmen, Präparierenklemmen
 Pinzas hemostaticas, Pinzas para preparaciones Y ligaduras

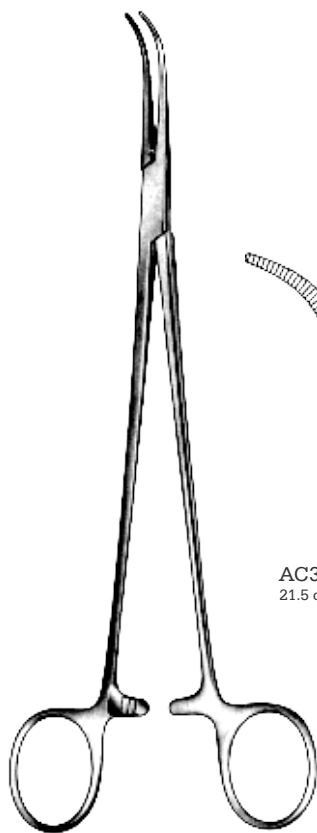

Overholt
 Fine pattern

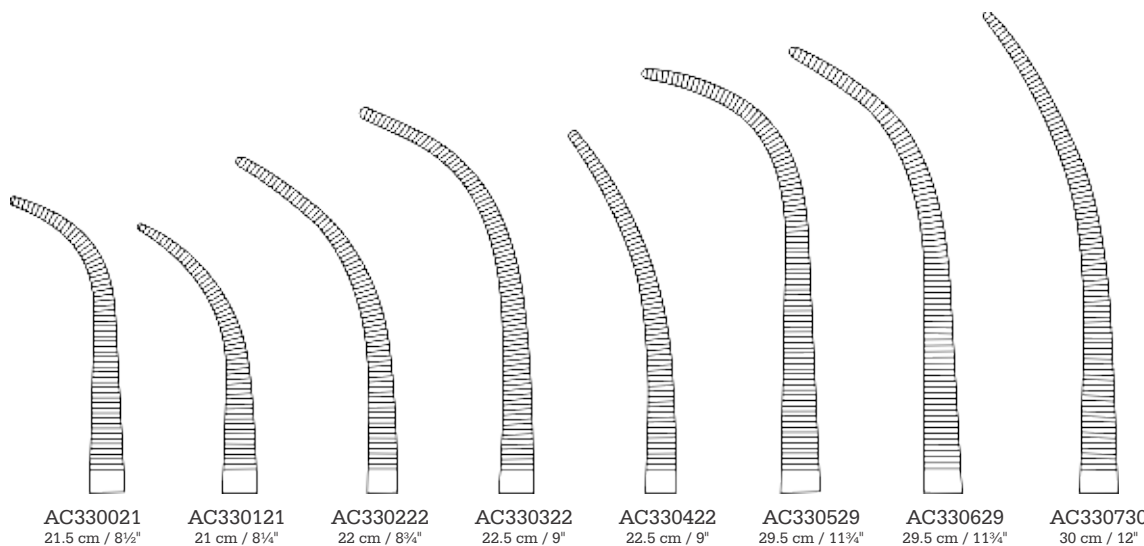

AC330021 21.5 cm / 8½"	AC330121 21 cm / 8¼"	AC330222 22 cm / 8¾"	AC330322 22.5 cm / 9"	AC330422 22.5 cm / 9"	AC330529 29.5 cm / 11¾"	AC330629 29.5 cm / 11¾"	AC330730 30 cm / 12"
---------------------------	-------------------------	-------------------------	--------------------------	--------------------------	----------------------------	----------------------------	-------------------------

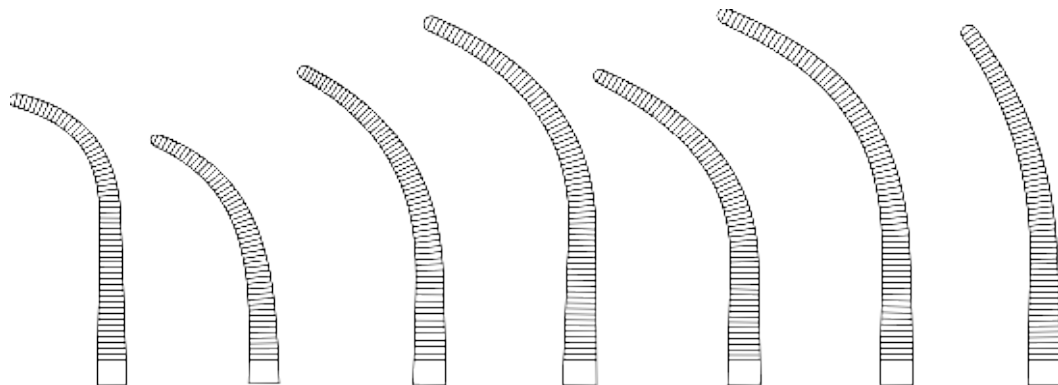

AC331021 21 cm / 8¼"	AC331121 21 cm / 8¼"	AC331221 21 cm / 8¼"	AC331321 21 cm / 8¼"	AC331421 21 cm / 8¼"	AC331521 21 cm / 8¼"	AC331621 21 cm / 8¼"
AC331027 27 cm / 10¾"	AC331127 27 cm / 10¾"	AC331227 27 cm / 10¾"	AC331327 27 cm / 10¾"	AC331427 27 cm / 10¾"	AC331527 27 cm / 10¾"	AC331627 27 cm / 10¾"

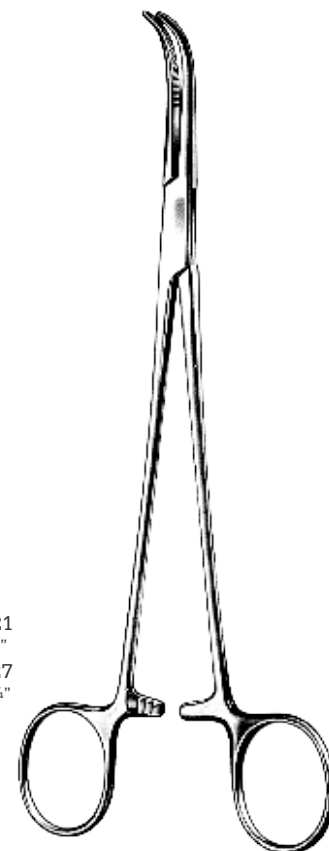

Overholt-Geissendoerfer

Artery Forceps

Dissecting & Ligature Forceps

Preparierenklemmen

Pinzas para preparaciones Y ligaduras

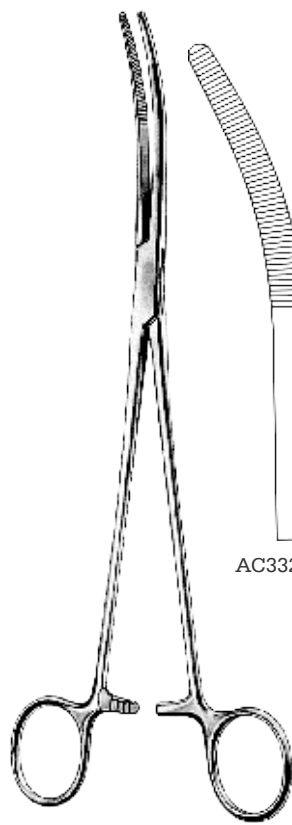
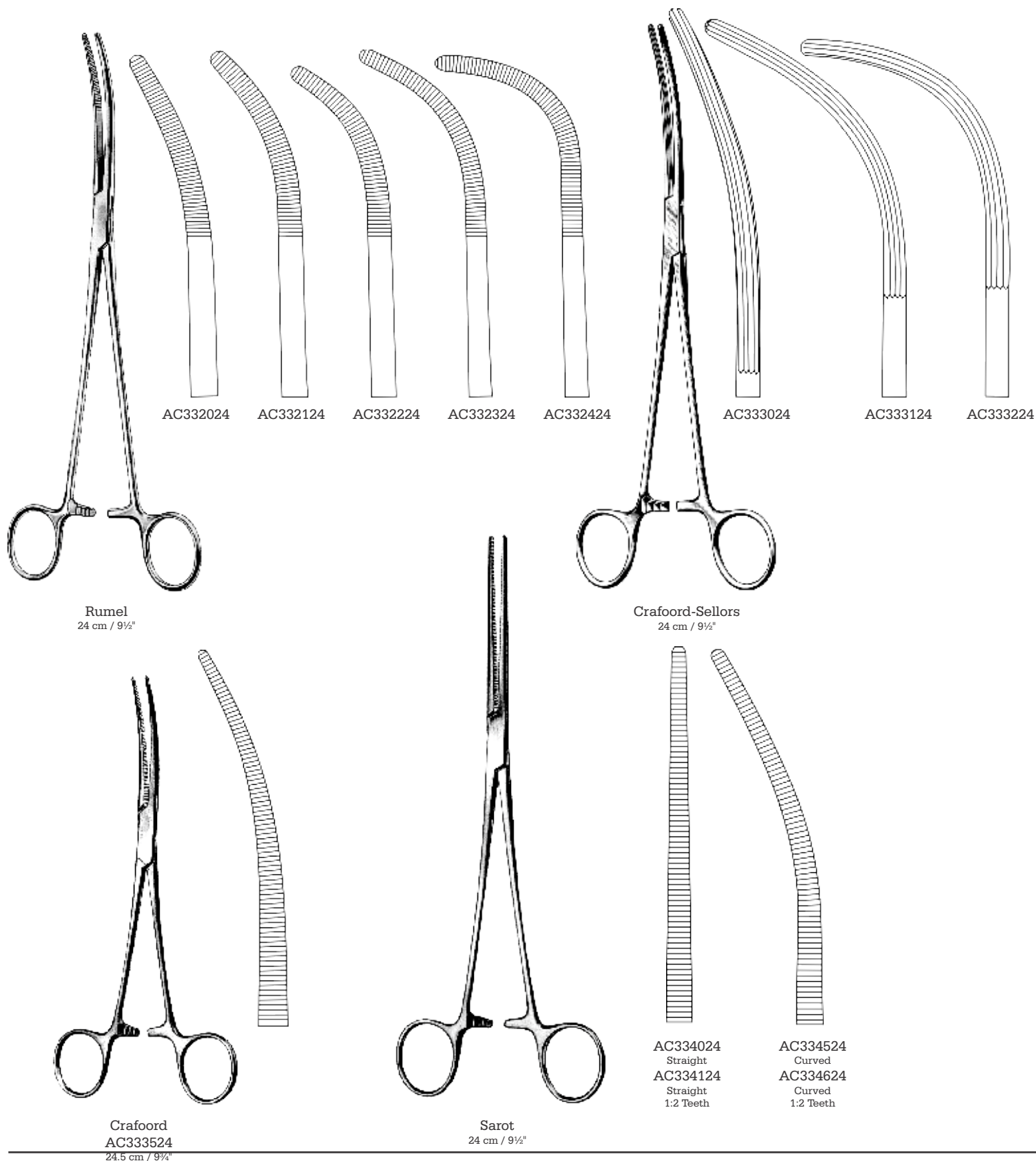
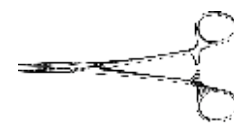

Rumel
24 cm / 9½"

AC332024

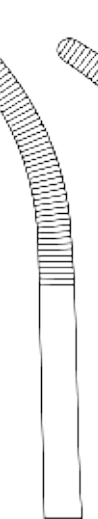

AC332124

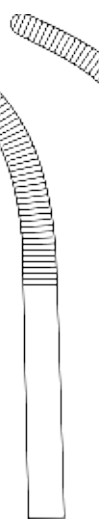

AC332224

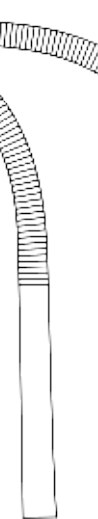

AC332324

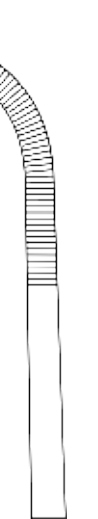

AC332424

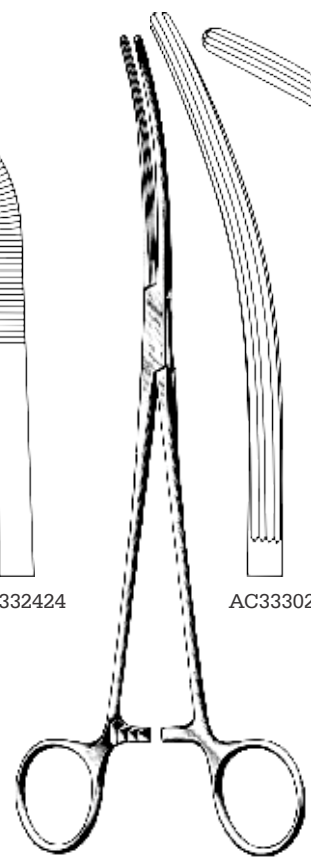

Crafoord-Sellors
24 cm / 9½"

AC333024



AC333124



AC333224

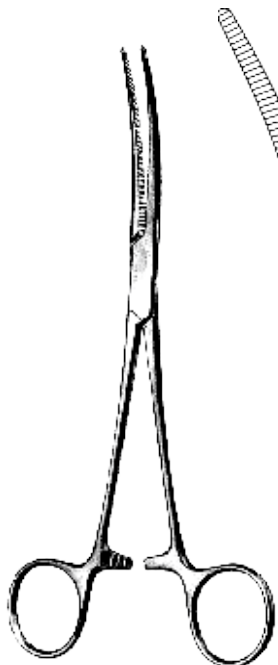

Crafoord
AC333524
24.5 cm / 9¾"

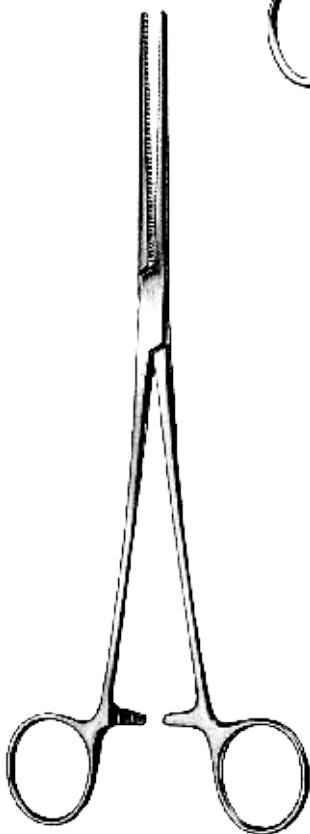
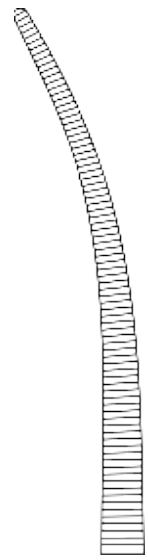

Sarot
24 cm / 9½"



AC334024
Straight

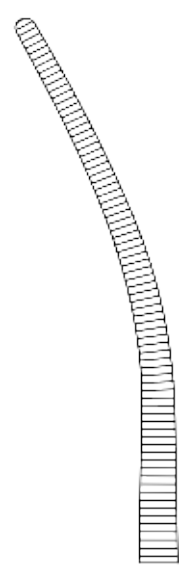

AC334124
Straight
1:2 Teeth

AC334524
Curved
AC334624
Curved
1:2 Teeth



Artery Forceps
 Dissecting and Ligature Forceps
 Präparienklemmen
 Pinzas para Preparaciones Y ligaduras

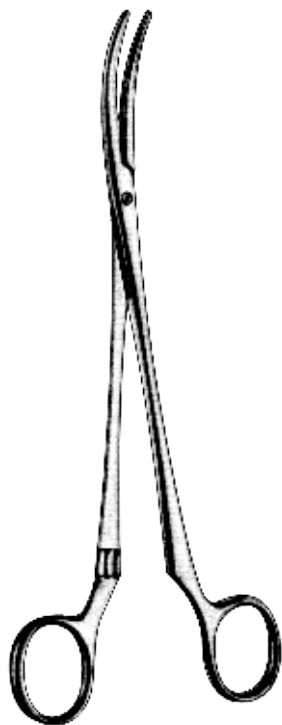

Roberts
 AC335023 Straight
 AC335123 Curved
 23 cm / 9"

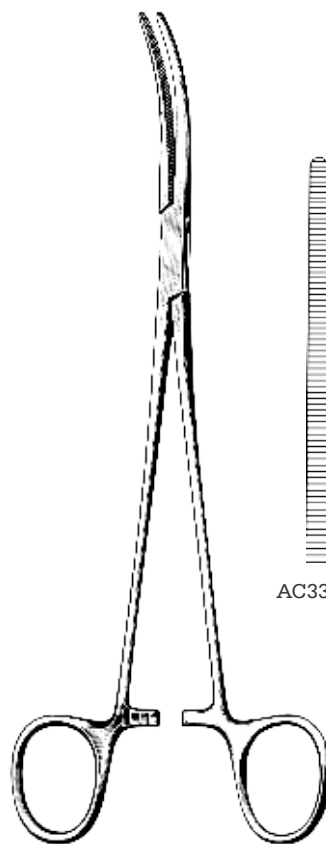

Roberts
 22 cm / 8 3/4"



AC335522

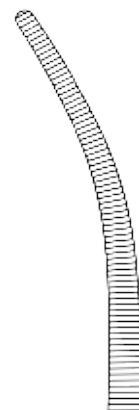

AC335622

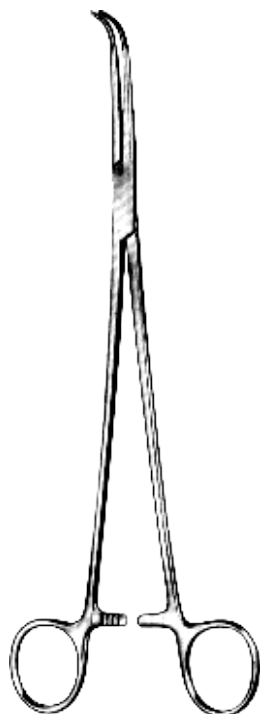

Gemini



AC336013
 13 cm / 5"

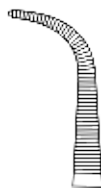

AC336116
 16 cm / 6 1/4"

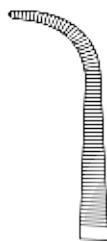

AC336218
 18 cm / 7"

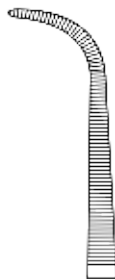

AC336320
 20 cm / 8"



AC336423
 23 cm / 9"



AC336525
 25 cm / 10"



AC336628
 28 cm / 11"

Artery Forceps

Dissecting and Ligature Forceps

Preparierenklemmen

Pinzas para Preparaciones Y ligaduras

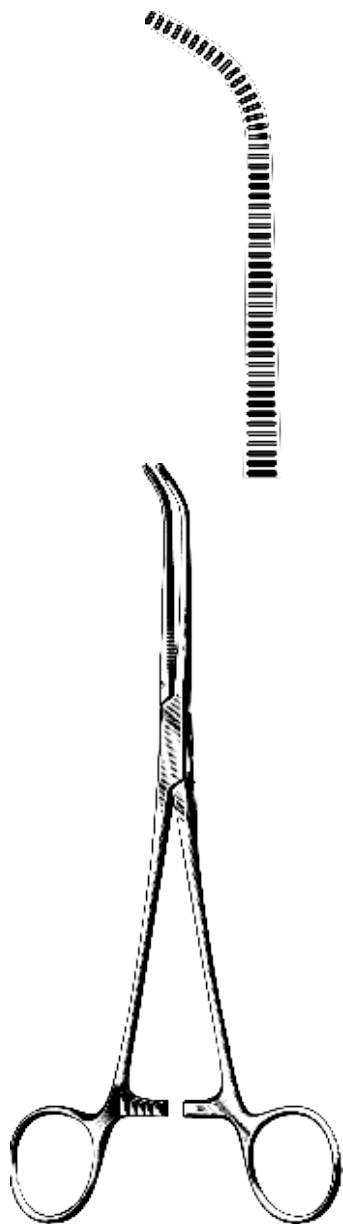
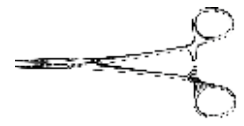

Johns Hopkins
AC337020
20 cm / 8"



Lawrence
AC337527
27 cm / 10 3/4"

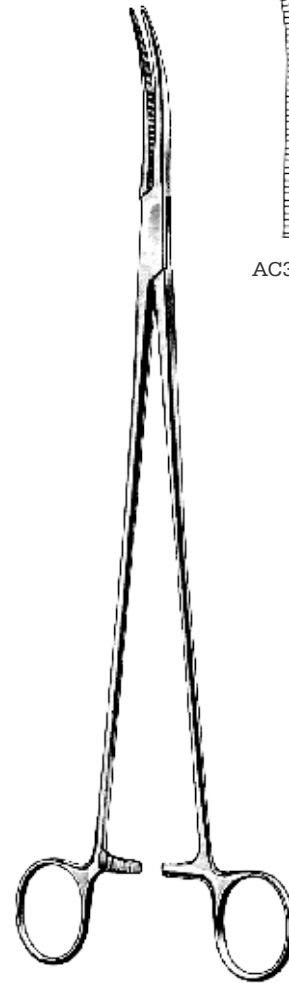

Zenker
29.5 cm / 11 1/2"

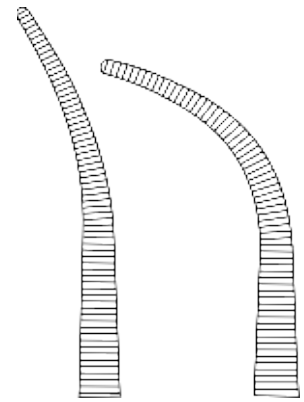

AC338029

AC338129



Artery Forceps
 Dissecting and Ligature Forceps
 Präparienklemmen
 Pinzas para Preparaciones Y ligaduras

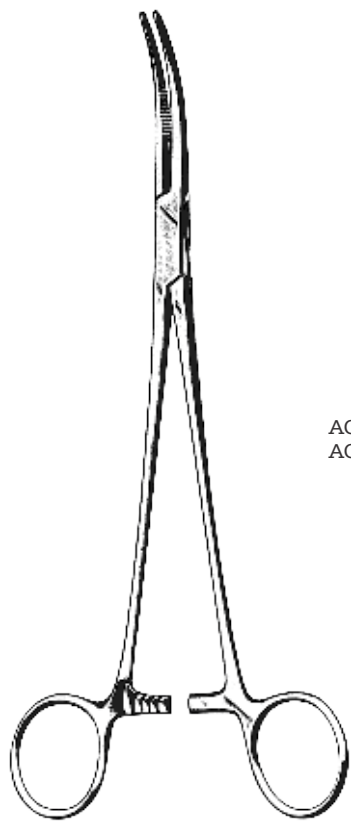

Toennis



AC338521 21 cm / 8 1/4"
 AC338526 26 cm / 10 1/4"

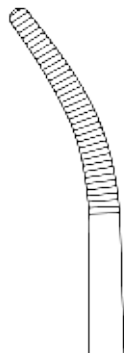

AC338621
 AC338626



AC338721 21 cm / 8 1/4"
 AC338726 26 cm / 10 1/4"
 1:2 Teeth

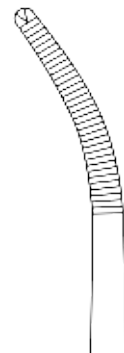

AC338821
 AC338826
 1:2 Teeth

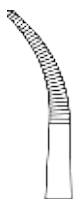

AC339014

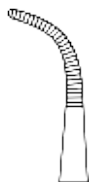

AC339114



AC339514



AC052018

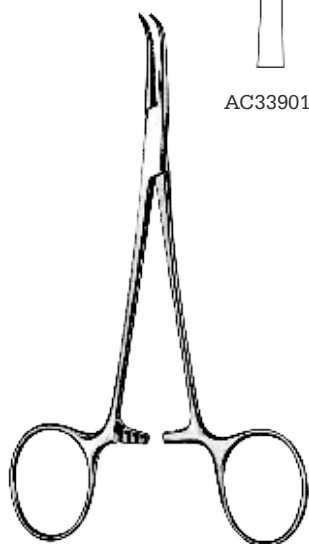

Baby-Mixer
 14 cm / 5 1/2"

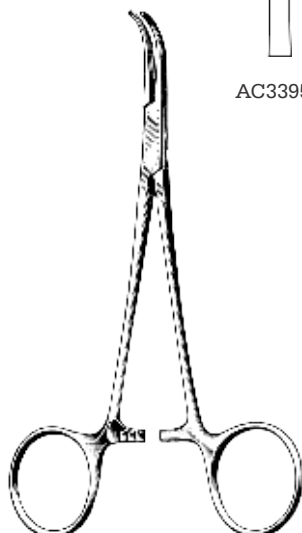

Mixer
 14 cm / 5 1/2"

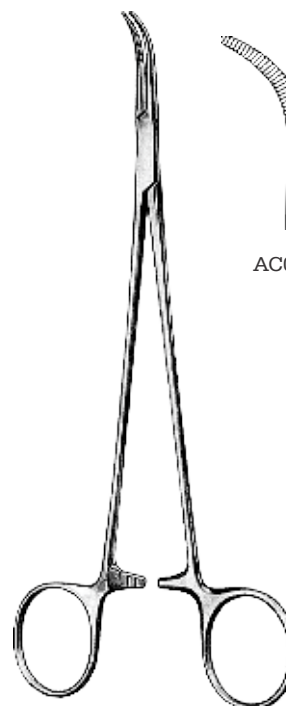

Mixer-Baby
 18 cm / 7"

Artery Forceps

Dissecting and Ligature Forceps

Praparienklemmen

Pinzas para Preparaciones Y ligaduras

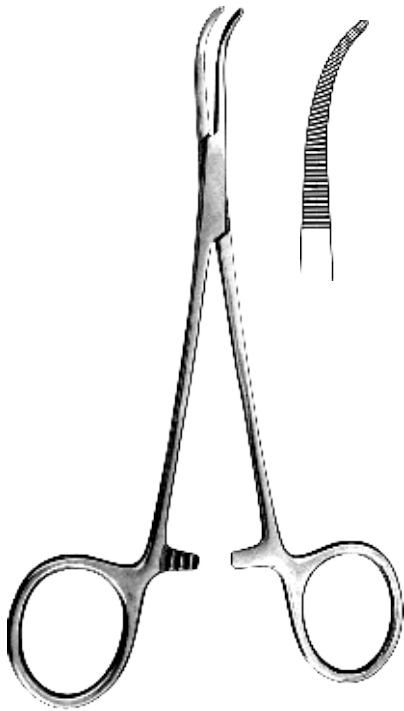
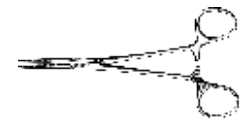

Jacobson Mixer Forceps
AC340015
15.5 cm / 6"
Extra delicate

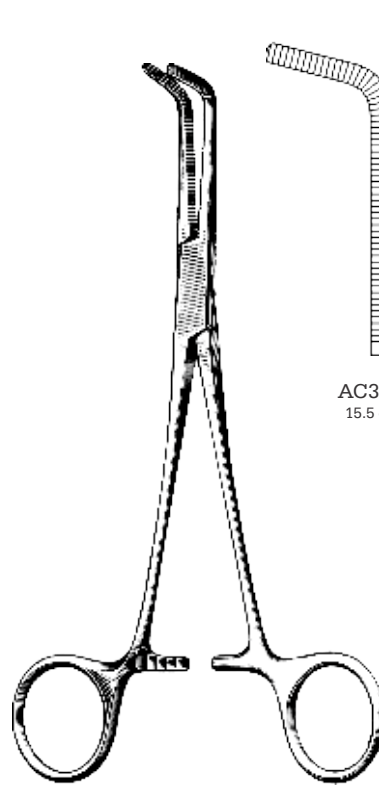

Mixer

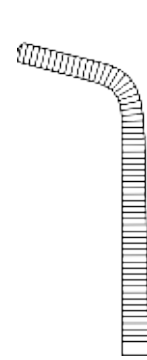

AC340515
15.5 cm / 6"

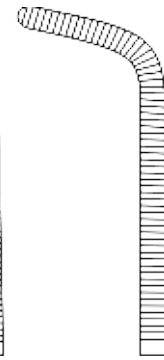

AC340518
18 cm / 7"

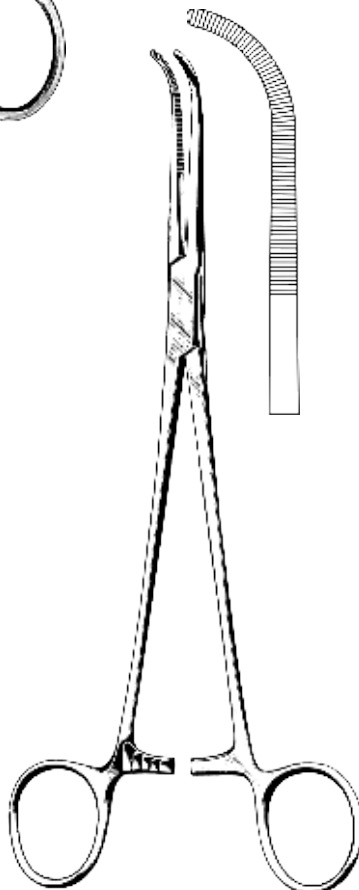

Mixer
AC341022
22 cm / 8 3/4"



Mixer
AC341523
23 cm / 9"

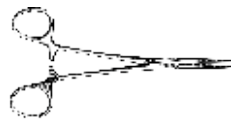

Artery Forceps

Dissecting & Ligature Forceps, Bile Duct Clamps
 Präparierklemmen, Gallenkanaklemmen

Pinzas pra preparacion y ligadura, Pinzas para conducto biliar

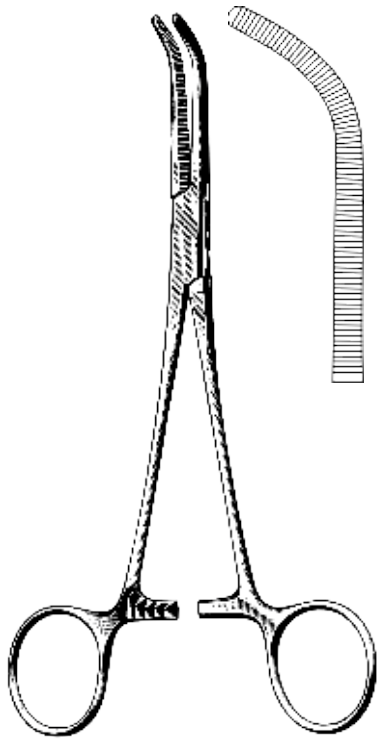

Mixer-O,Shaughnessy
 AC342018
 18 cm / 7"

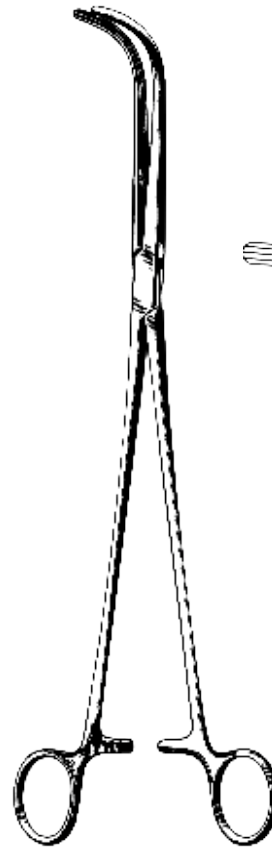

Mixer

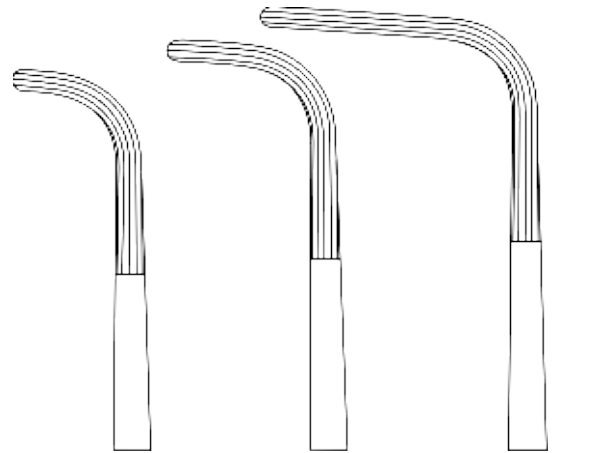

AC342522
 22 cm / 8 3/4"

AC342525
 25 cm / 10"

AC342528
 28 cm / 11"

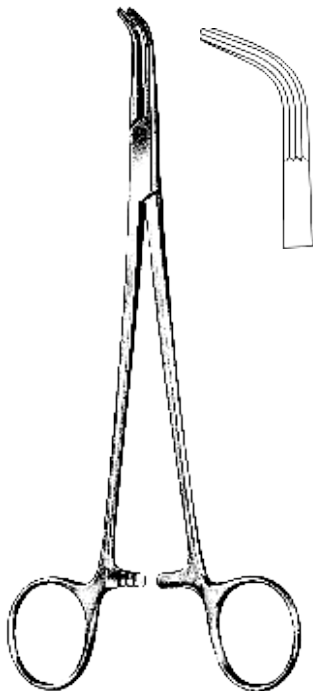

Lower
 AC343018
 18 cm / 7"

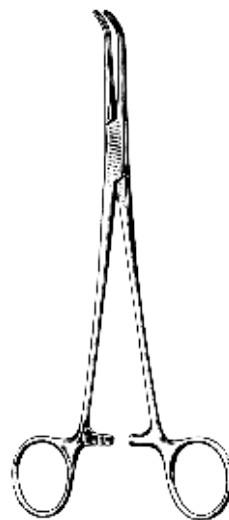

Lahey



AC343519
 19 cm / 7 1/2"

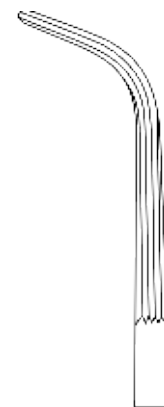

AC343523
 23 cm / 9"

Artery Forceps

Dissecting & Ligature Forceps, Haemostatic Forceps
 Präparienklemmen, Arterienklemmen
 Pinzas pra preparacion y ligadura, Pinzas hemostaticas

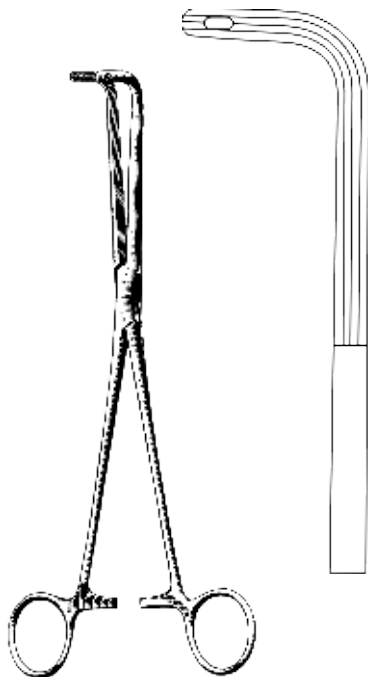

Finocchietto
 AC344024
 24 cm / 9½"

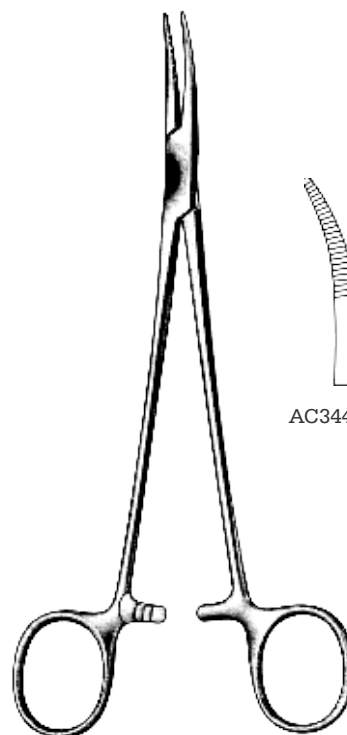

AC344519

AC344619

Schmidt
 19 cm / 7½"



AC345019

AC345119

Schmidt
 19 cm / 7½"



AC345518

AC345618

Sawtell
 18.5 cm / 7¼"

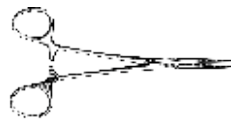

Artery Forceps

Artery Forceps, Kidney Pedicle Clamp Forceps
Arterienklemmen, Nierenstieklemmen

Pinzas Hemostaticas, Pinzas-Clamps Para Pedunculos Renales



AC346019

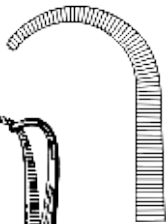

AC346119

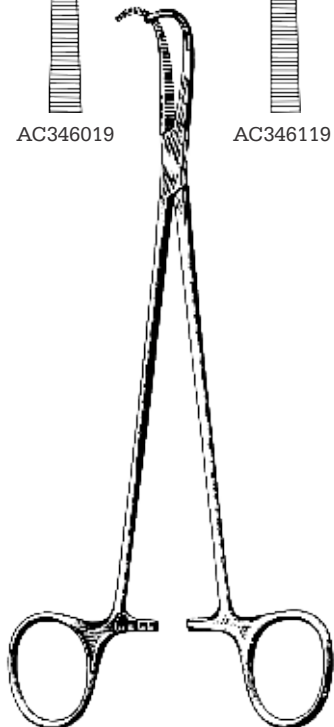

Negus
19 cm / 7½"



AC346520
20 cm / 8"



AC346522
22 cm / 8¾"

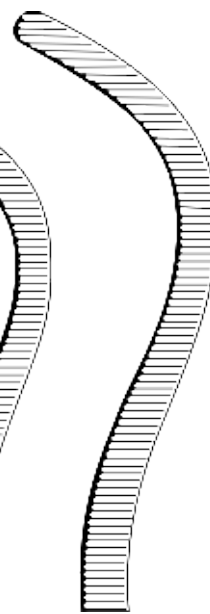

AC346524
24 cm / 9½"

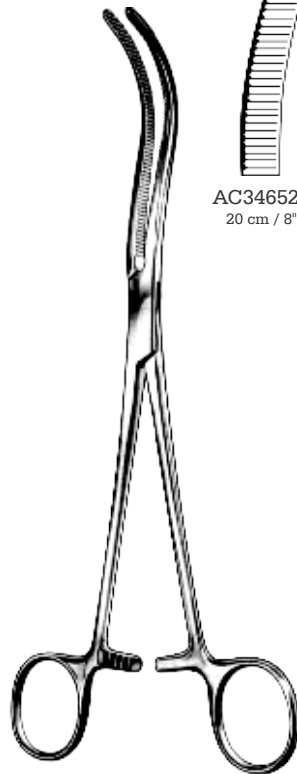

Guyon

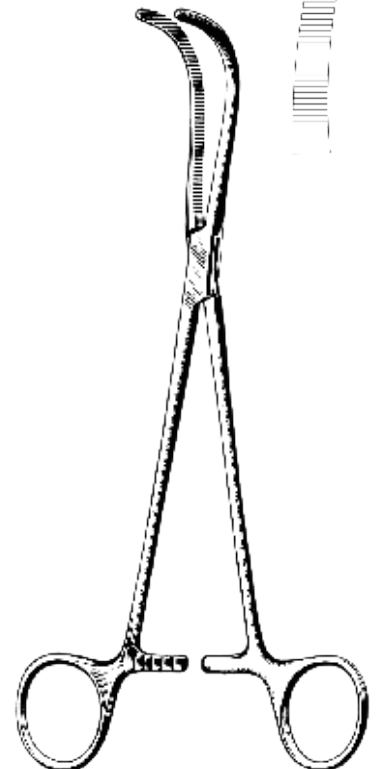
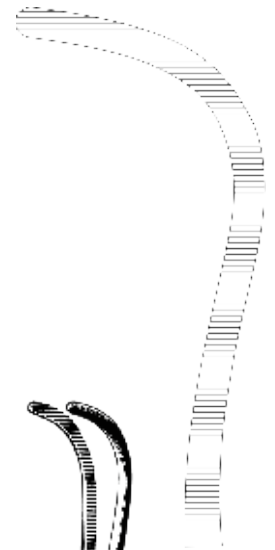

Guyon
AC347023
23 cm / 9"

Artery Forceps

Kidney Pedicle Clamp Forceps

Nierenstieklemmen

Pinzas-Clamps Para Pedunculos Renales

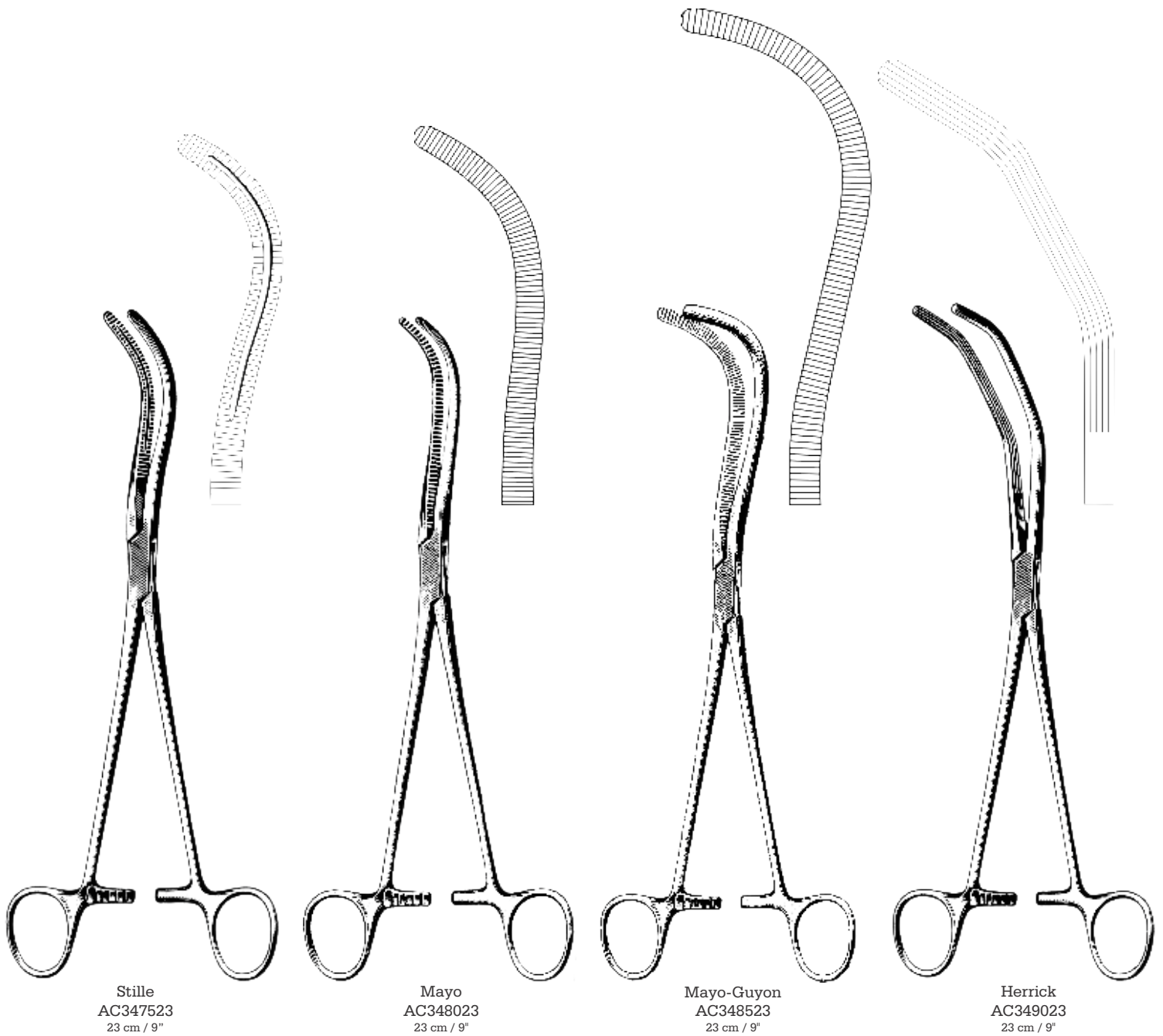
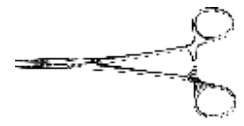

Stille
AC347523
23 cm / 9"

Mayo
AC348023
23 cm / 9"

Mayo-Guyon
AC348523
23 cm / 9"

Herrick
AC349023
23 cm / 9"

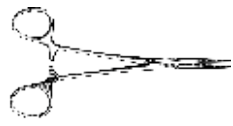

Artery Forceps
 Gall Duct Clamps
 Gallenkanalklemmen
 Pinzas Para Conducto Billar

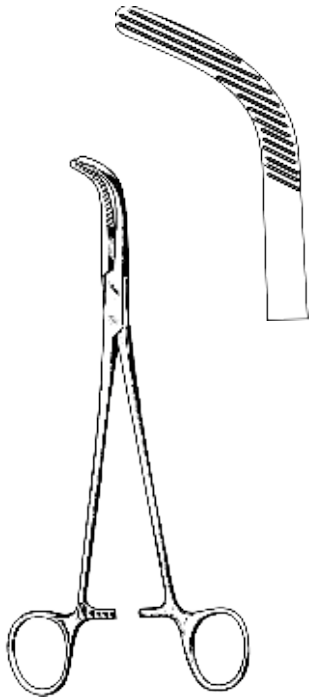

Crile
 AC349520
 20 cm / 8"

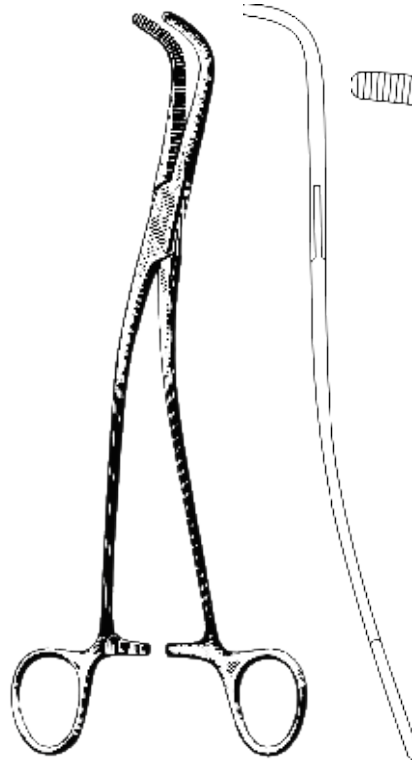

Gray

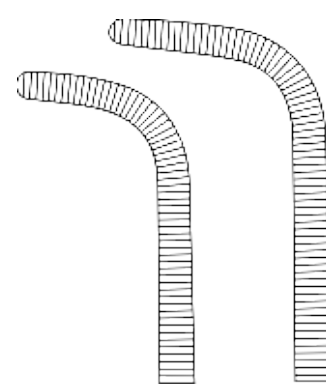

AC350022
 22 cm / 8 3/4"

AC350023
 23 cm / 9"

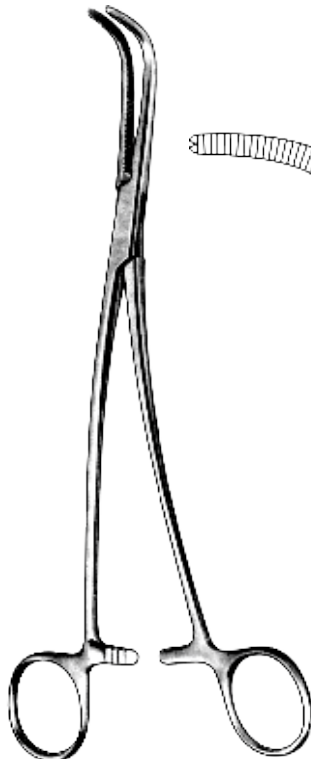

Gray

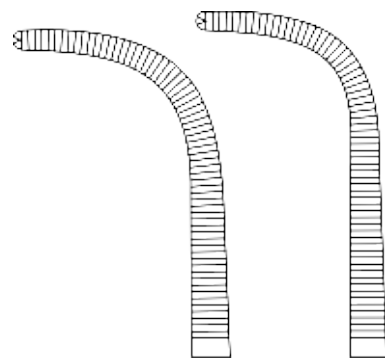

AC350522
 22 cm / 8 3/4"

AC350523
 23 cm / 9"

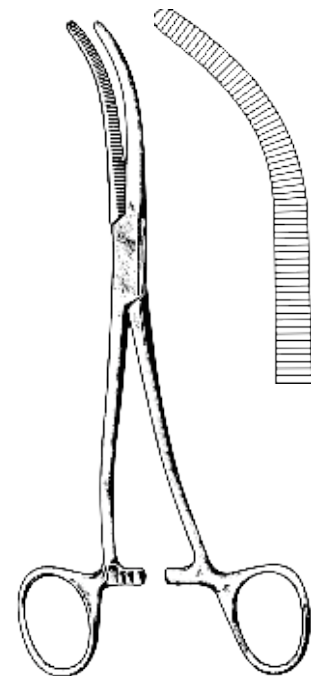

Dean-Shallcross
 AC351018
 18 cm / 7"

Artery Forceps

Gall Duct Clamps, Peritoneal Clamp Forceps
 Gallenkanaklemmen, Peritoneumklemmen
 Pinzas para conducto biliar, Pinzas-Clamps Para Peritoneo

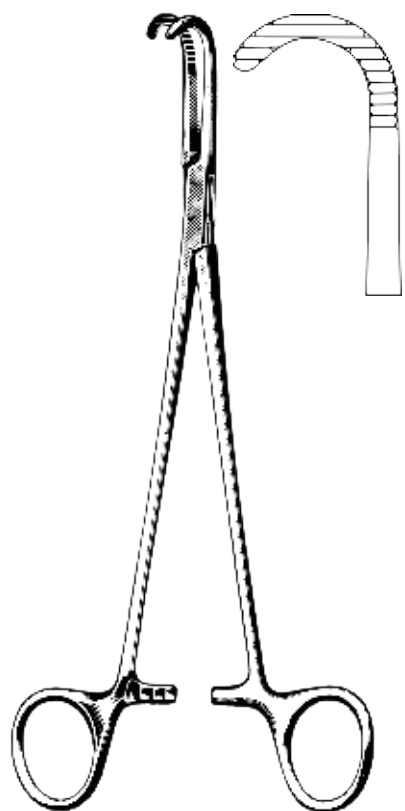

Desjardins
 AC351521
 21 cm / 8 1/4"

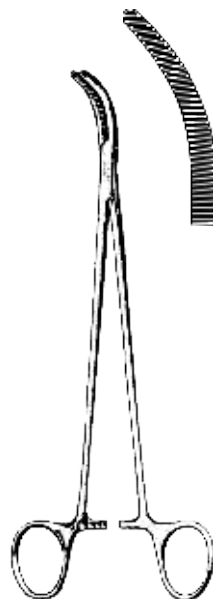

Desjardins
 AC352021
 21 cm / 8 1/4"

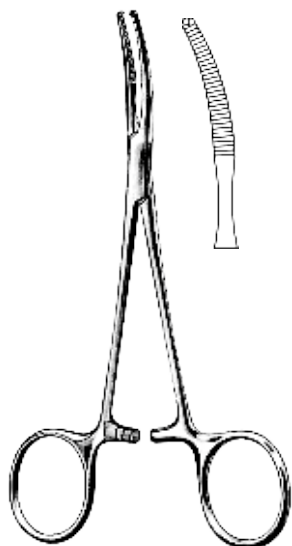

Baby-Mikulicz
 AC352514
 14 cm / 5 1/2"

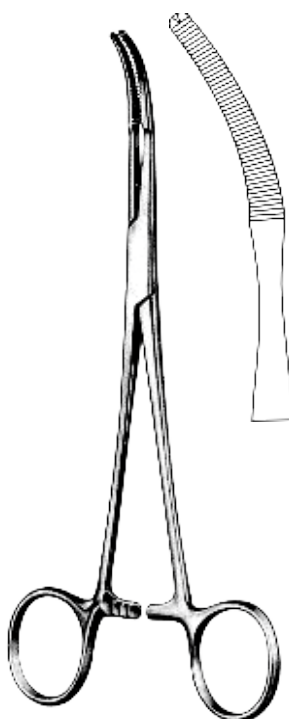

Mikulicz
 AC353020
 20 cm / 8"

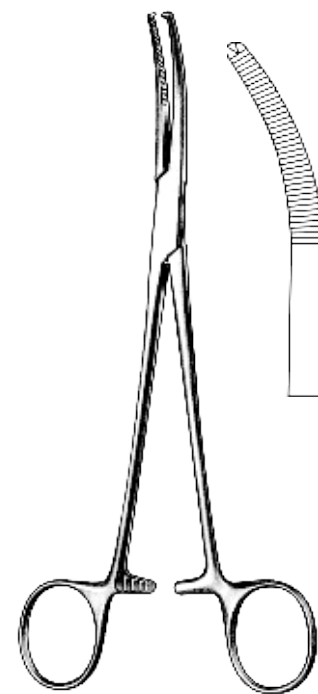

Mikulicz
 AC353520
 20 cm / 8"

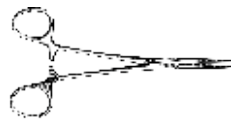

Artery Forceps Hysterectomy & Vaginal Clamp Forceps Hysterektomieklemmen, Vaginalklemmen Pinzas-clamps para histerectomia y vaginales

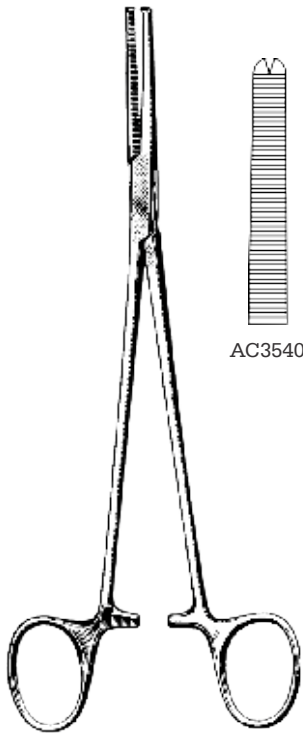

Phaneuf
21 cm / 8½"
1:2 Teeth



AC354021

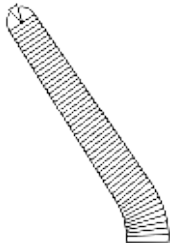

AC354121

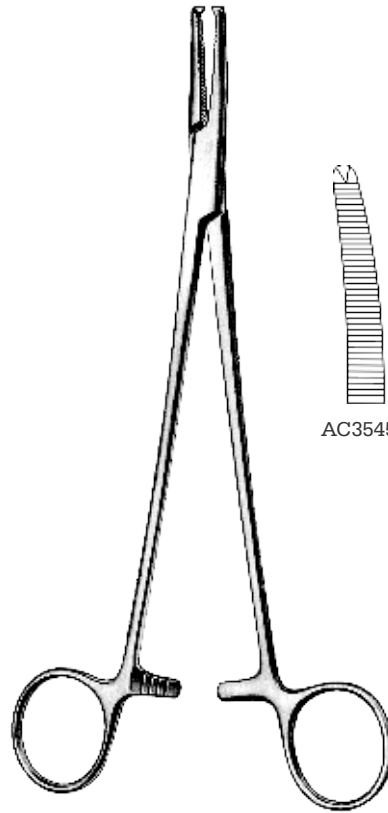

Faure
20 cm / 8"
1:2 Teeth



AC354520

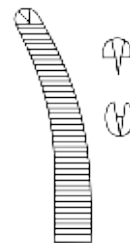

AC354620

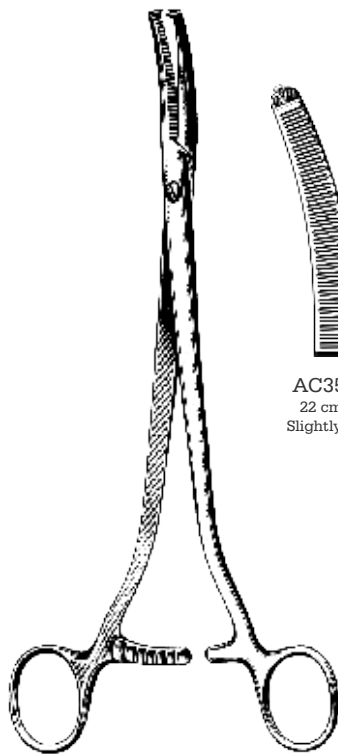

Wertheim
1:2 Teeth



AC355022
22 cm / 8¾"
Slightly curved



AC355023
23 cm / 9"
More curved

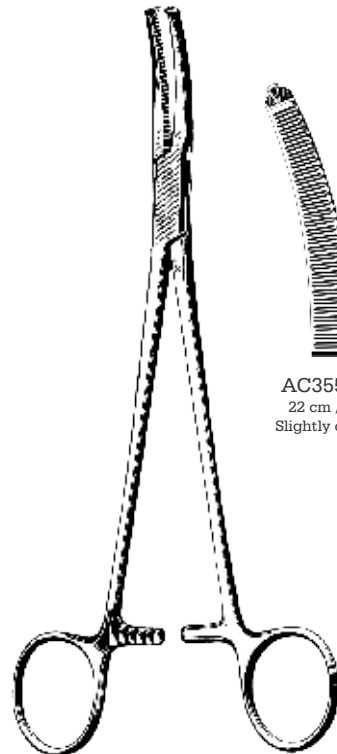

Wertheim
1:2 Teeth



AC355522
22 cm / 8¾"
Slightly curved



AC355523
23 cm / 9"
More curved

Artery Forceps

Hysterectomy & Vaginal Clamp Forceps
 Hysterektomieklemmen, Vaginalklemmen
 Pinzas-clamps para histerectomia y vaginales

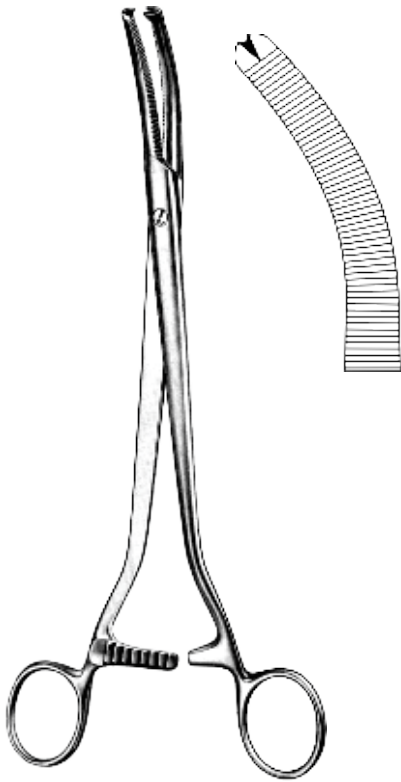
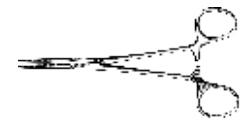

Werheim
 AC356024
 24 cm / 9½"
 Extra strong

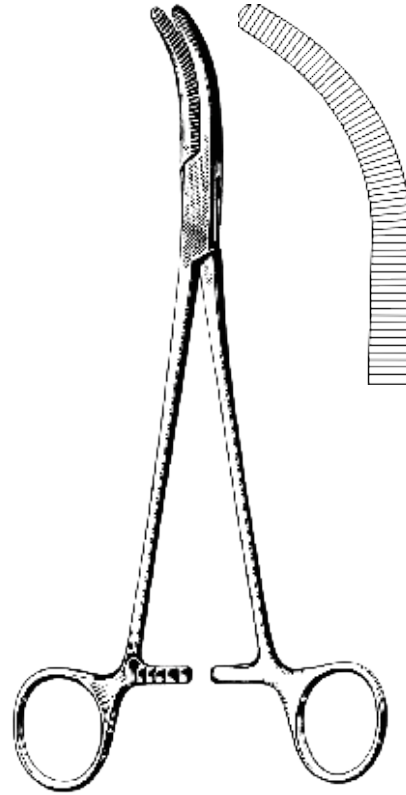

Werheim
 AC356525
 25 cm / 10"

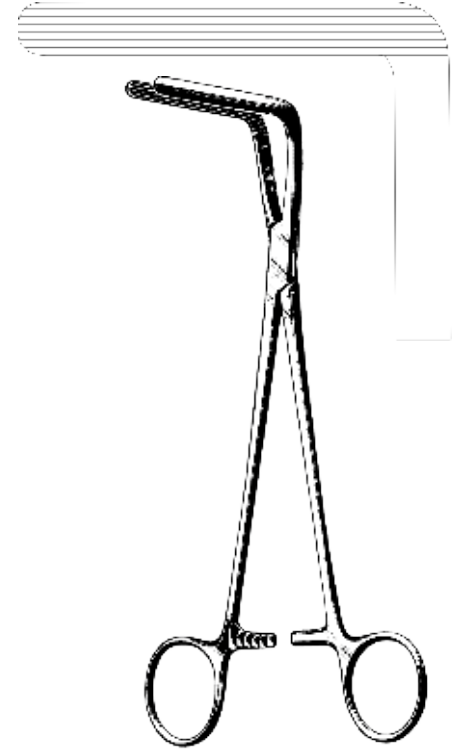

Werheim Cullen
 AC357021
 21.5 cm / 8½"

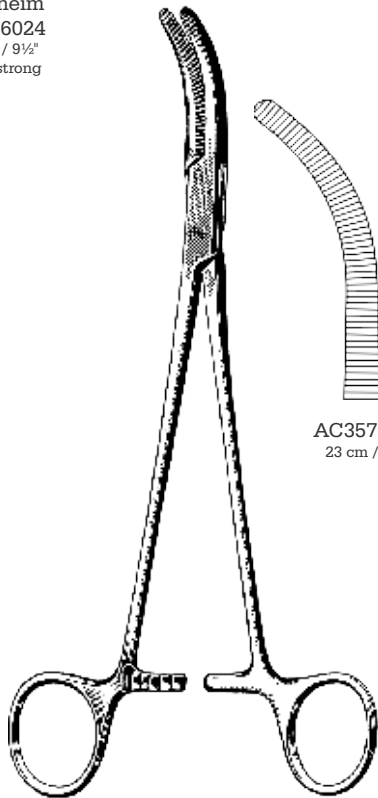

Moynihan

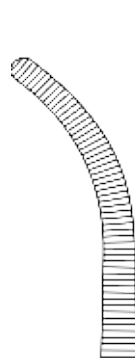

AC357523
 23 cm / 9"

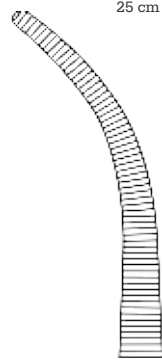

AC357524
 24 cm / 9½"

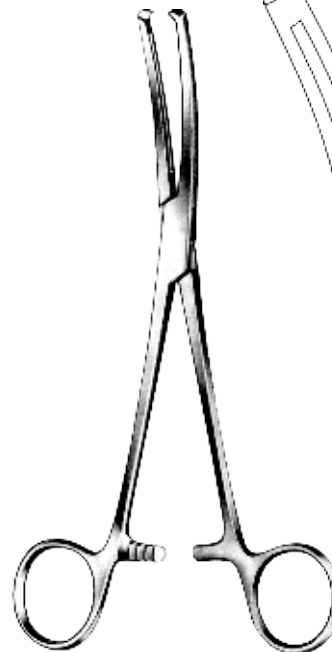

Maingot



AC358020
 20.5 cm / 8"



AC358025
 25 cm / 10"



Artery Forceps

Hysterectomy & Vaginal Clamp Forceps
 Hysterektomieklemmen, Vaginalklemmen
 Pinzas-clamps para histerectomia y vaginales

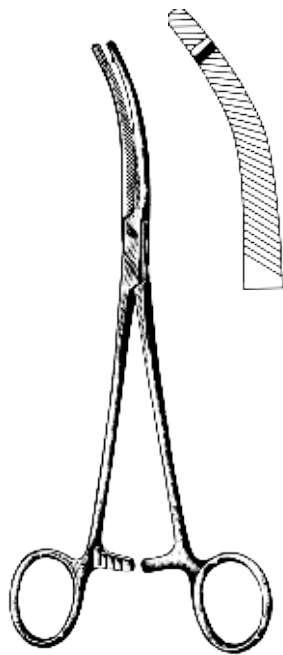

Heaney
 AC358519 19 cm / 7½"
 AC358521 21 cm / 8¼"
 AC358524 24.5 cm / 9¾"
 Hysterectomy forceps
 Heavy pattern, single tooth
 Curved

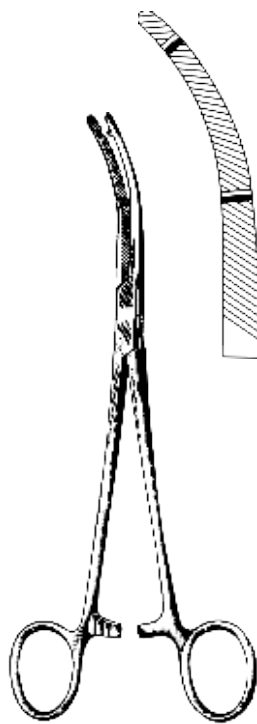

Heaney
 AC359019 19 cm / 7½"
 AC359021 21 cm / 8¼"
 Heavy pattern
 AC359024 24.5 cm / 9¾"
 Extra heavy pattern
 Hysterectomy forceps
 double tooth, curved

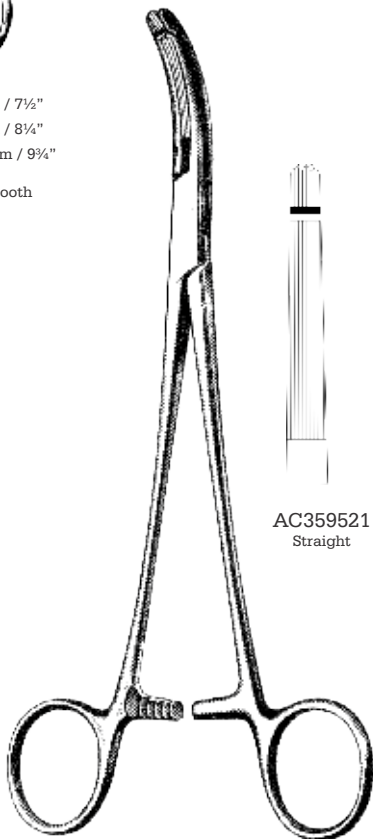

Heaney-Ballentine
 21 cm / 8¼"
 Longitudinal serrations, single tooth



AC359521
 Straight

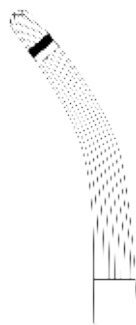

AC359621
 Curved

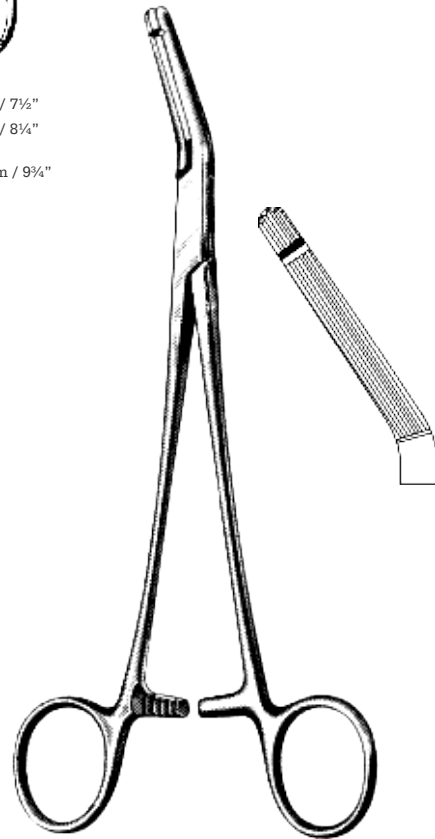

Ballentine
 AC360021
 Garland
 AC360121
 21 cm / 8¼"
 Longitudinal serrations,
 single tooth, angled on flat

Artery Forceps

Hysterectomy & Vaginal Clamp Forceps
 Hysterektomieklemmen, Vaginalklemmen
 Pinzas-clamps para histerectomia y vaginales

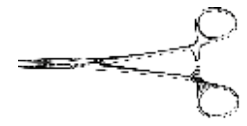

ATRAUMA



Heaney

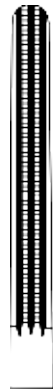

AC360522
22.5 cm / 9"



AC360621
21.5 cm / 8½"

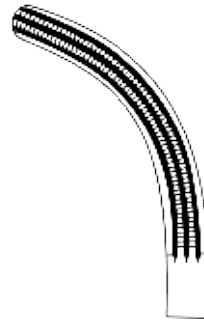

AC360722
22 cm / 8½"

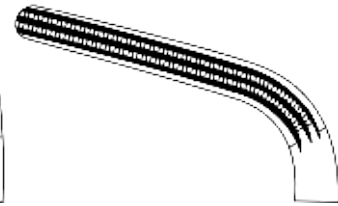

AC360820
20.5 cm / 8"

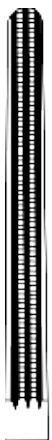

AC361025
25 cm / 10"

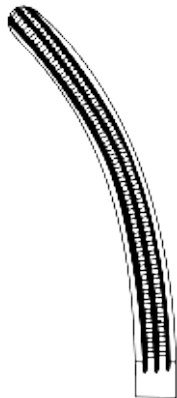

AC361124
24.5 cm / 9¾"

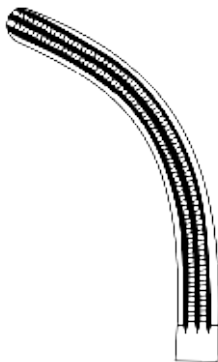

AC361224
24 cm / 9½"

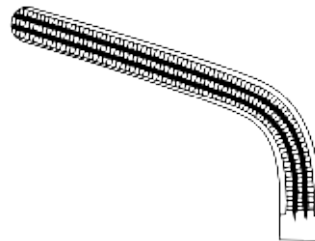

AC361322
22 cm / 8¾"



Wertheim
Parametrium clamps

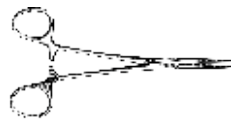

Artery Forceps

Hysterectomy & Vaginal Clamp Forceps
 Hysterektomieklemmen, Vaginalklemmen
 Pinzas-clamps para histerectomia y vaginales

ATRAUMA

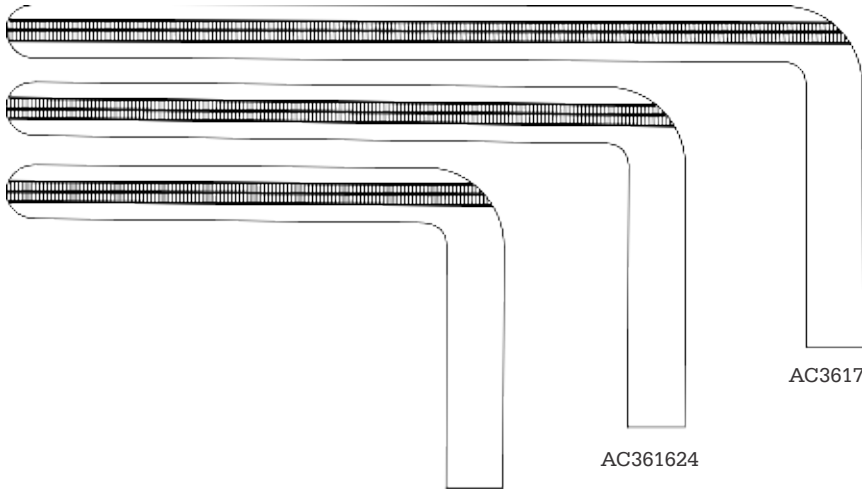

AC361524

AC361624

AC361724

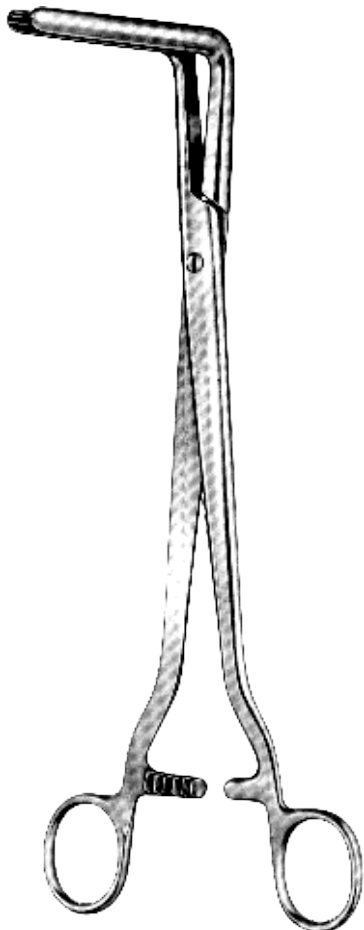

Wertheim
24 cm / 9 1/2"

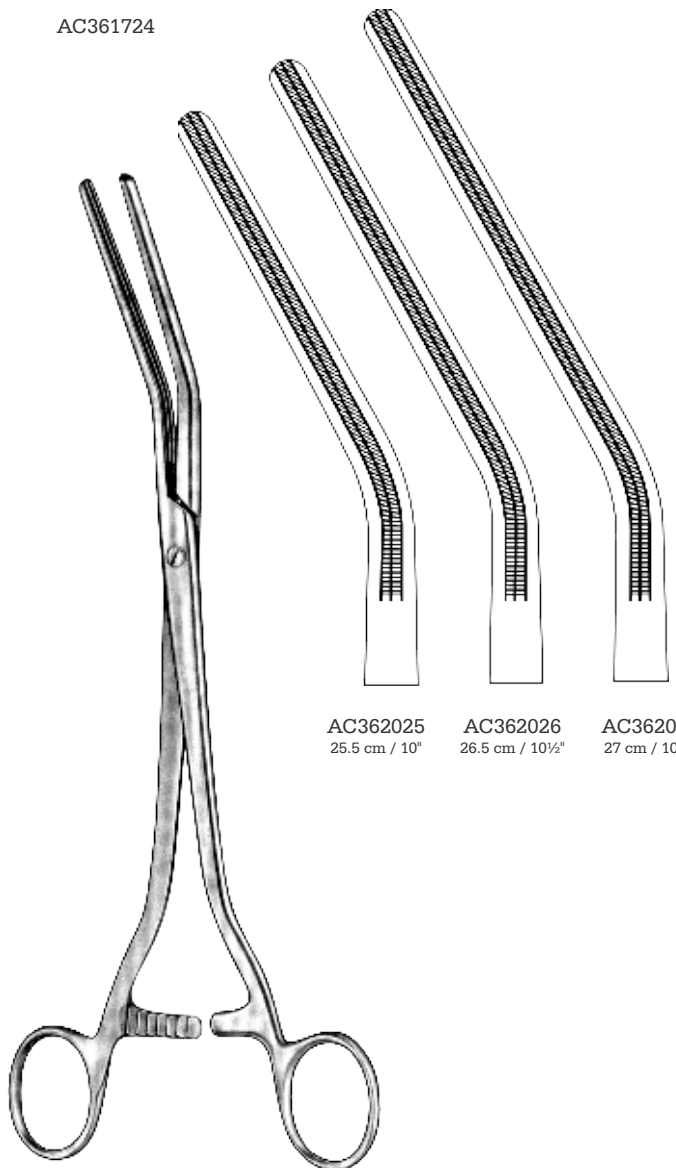

AC362025
25.5 cm / 10"

AC362026
26.5 cm / 10 1/2"

AC362027
27 cm / 10 3/4"

Dick

Artery Forceps

Towel Forceps

Tuchklemmen

Pinzas para compresas, Pinzas de campo

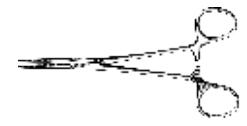

Jones
AC098205 5 cm / 2"
AC098209 9 cm / 3½"



Schaedel
AC097609
9 cm / 3½"



English Model
AC362509
9 cm / 3½"

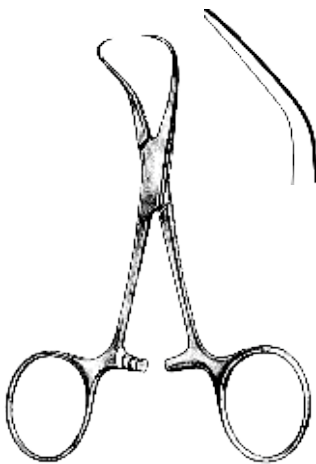

Backhaus
AC101609 9 cm / 3½"
AC101611 11 cm / 4¼"
AC101613 13 cm / 5"
AC101615 15 cm / 6"

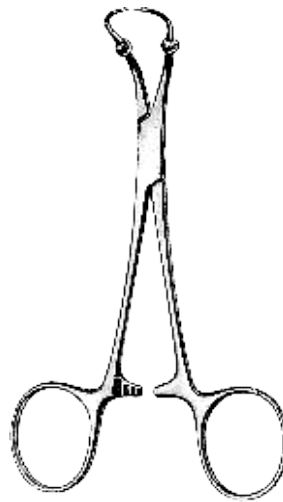

Roeder
AC363011 11 cm / 4¼"
AC363013 13 cm / 5"
AC363015 15 cm / 6"

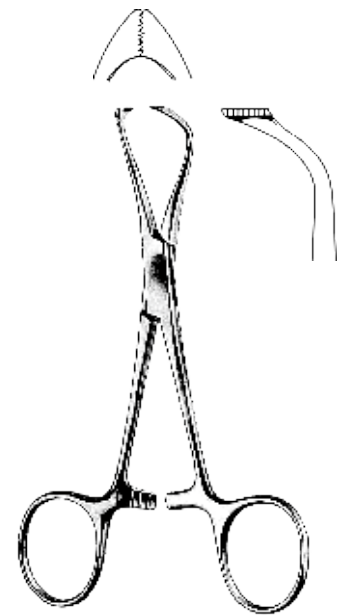

Lorna
AC102010 10 cm / 4"
AC102013 13 cm / 5"



Artery Forceps

Towel Forceps

Tuchklemmen

Pinzas para compresas, Pinzas de campo

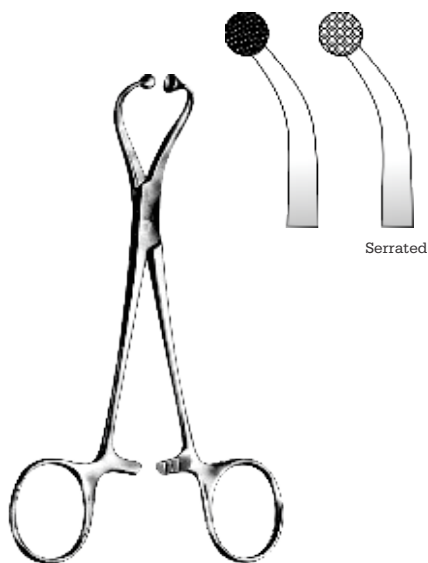

Serrated

Ball-Socket

AC363511 11 cm / 4½"

AC363514 14 cm / 5½"

For paper cloths

AC363611 11 cm / 4½"

AC363614 14 cm / 5½"

Serrated



Tohoku

AC102410 10 cm / 4"

AC102413 13 cm / 5¼"

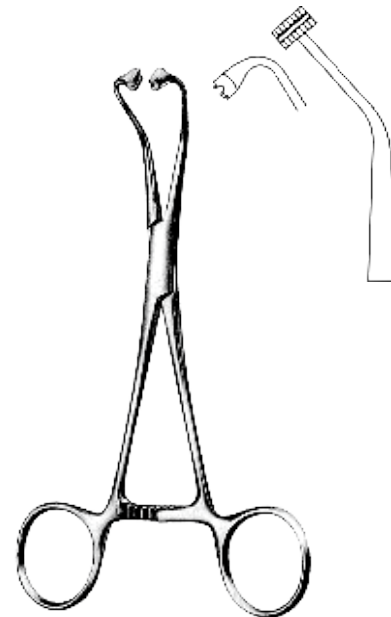

Peer's-Bertram

AC364015

15 cm / 6"

For paper cloths

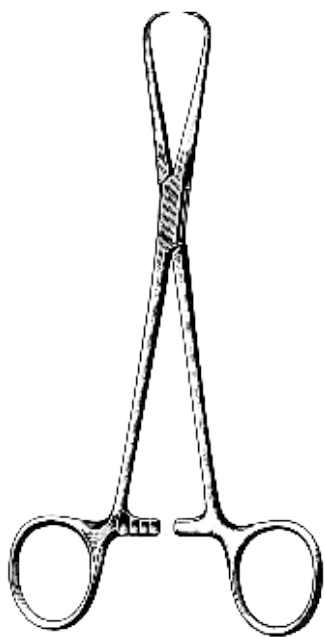

Bernhard

AC364516

16.5 cm / 6½"

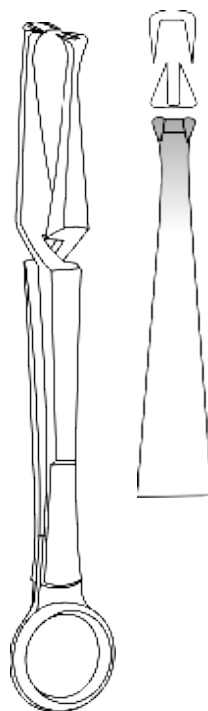

Doyen

AC365018

18 cm / 7"



Jayle

AC365513

13 cm / 5"

Tubing Clamps

Tubing Clamps
Schlauchklemmen
Pinzas para tubos

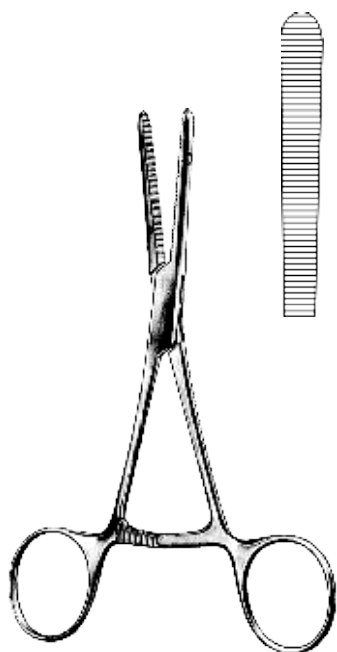

AC366014
14.5 cm / 5 3/4"
With extra long ratchet

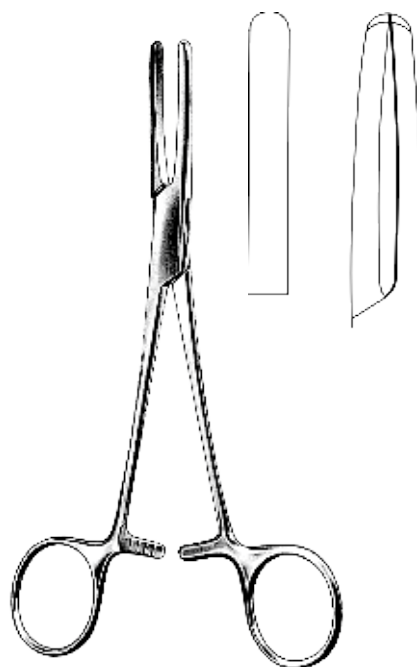

AC366514 14.5 cm / 5 3/4"
AC366516 16 cm / 6 1/4"
AC366518 18 cm / 7"



AC367016
With stainless steel rollers
AC367116
With teflon rollers
16 cm / 6 1/4"

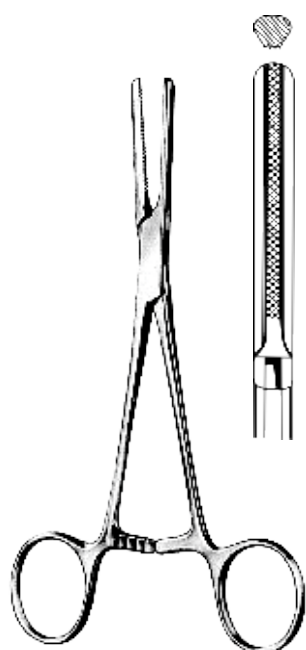

Standard
AC367514 14 cm / 5 1/2"
AC367515 15 cm / 6"
AC367518 18 cm / 7"
AC367520 20 cm / 8"

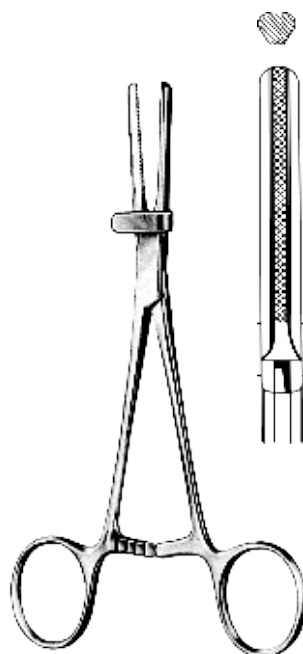

AC368014 14 cm / 5 1/2"
AC368015 15 cm / 6"
AC368018 18 cm / 7"
AC368020 20 cm / 8"
With guard



Gunnar
AC368518
With stainless steel rollers
AC368618
With teflon rollers
18.5 cm / 7 1/4"



Cotton Swab Forceps

Dressing, Cotton Swab Holding Forceps
Korn-und Tupferzangen
Pinzas para Vendajes Y tapones

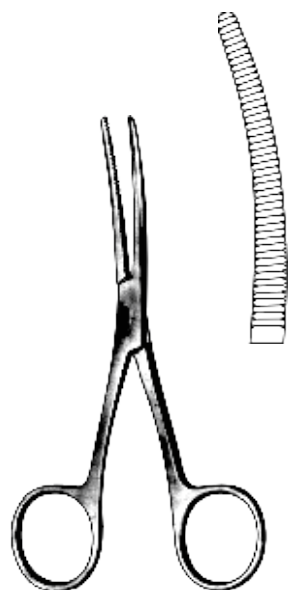

Bryant
AD300113
AD300213
13 cm / 5 1/4"
Serrated jaws

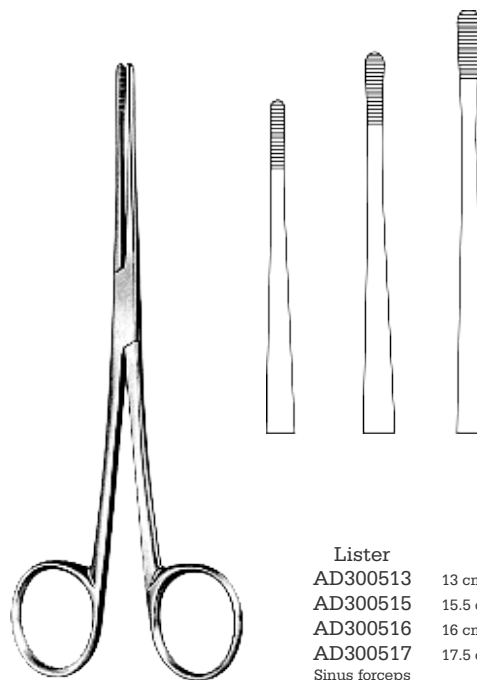

Lister
AD300513 13 cm / 5"
AD300515 15.5 cm / 6"
AD300516 16 cm / 6 1/4"
AD300517 17.5 cm / 7"
Sinus forceps



Gross-Maier

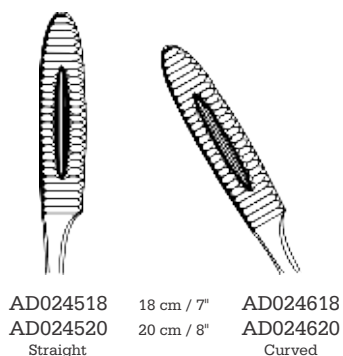

AD024518 18 cm / 7"
AD024520 20 cm / 8"
Straight
AD024618
AD024620
Curved

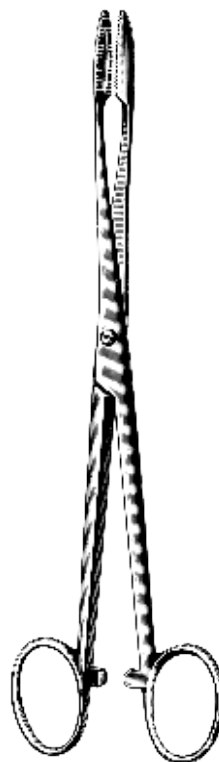

Gross-Maier

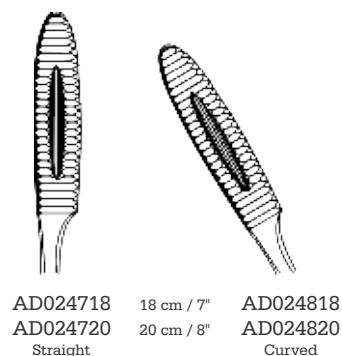

AD024718 18 cm / 7"
AD024720 20 cm / 8"
Straight
AD024818
AD024820
Curved

Cotton Swab Forceps

Polypus, Dressing and Cotton Swab Forceps
 Korn-(Polypen-)Zengen, Tupferzangen
 Pinzas para polipos Y vendajes, Pinzas para tapones

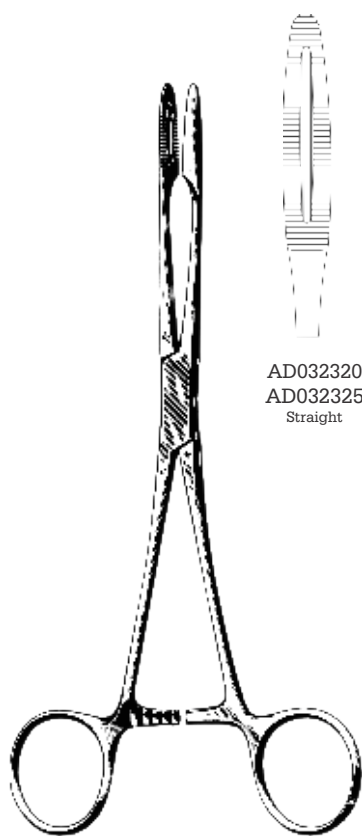
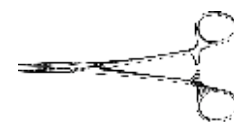

Gross-Maier



AD032320
 AD032325
 Straight

20 cm / 8"
 25 cm / 10"



AD032420
 AD032425
 Curved

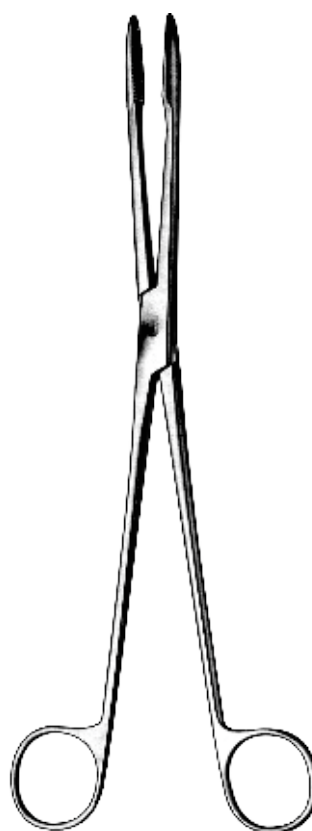

Maier
 Without ratchet



AD200120
 AD200125
 AD200126
 Straight

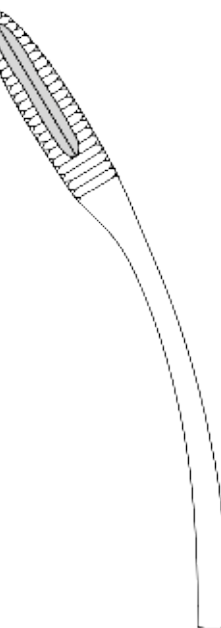

20 cm / 8"
 25 cm / 10"
 26.5 cm / 10½"
 Curved

AD200520
 AD200525
 AD200526
 Curved

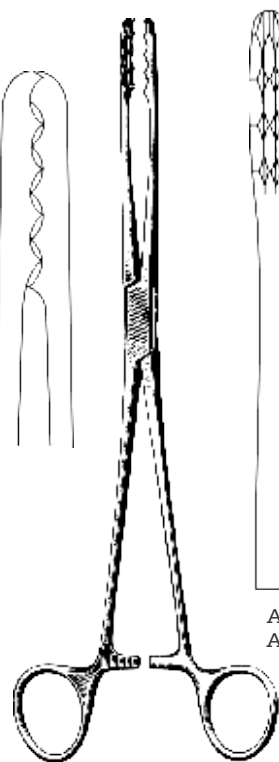

Ulrich

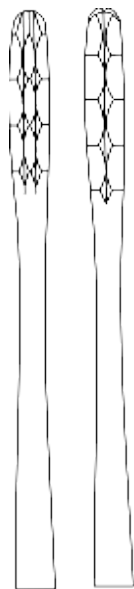

AD301022
 AD301026
 Straight

22 cm / 8¾"
 26.5 cm / 10½"



AD301122
 AD301126
 Curved

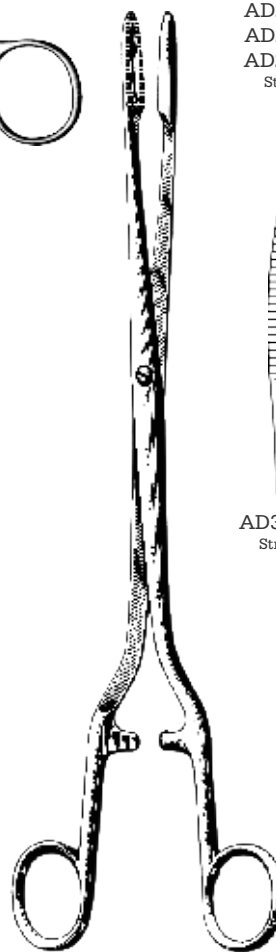

Sims-Maier
 28 cm / 11"



AD301528
 Straight



AD301628
 Curved



Cotton Swab Forceps

Polypus, Dressing, Cotton Swab & Foreign Body Forceps
Korn-(Polypen-)Zengen, Tupferzangen und Fremdkörperzangen
Polpos, vendajes, Taponos Y Pinzas para cuerpos extraños

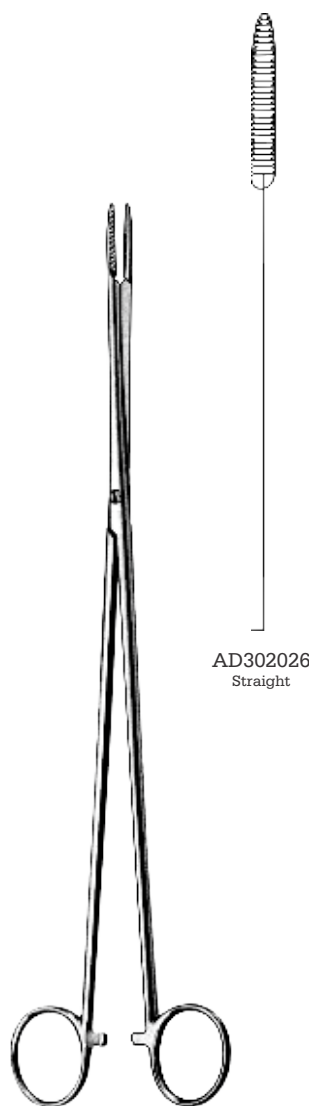

AD302026
Straight



AD302126
Curved

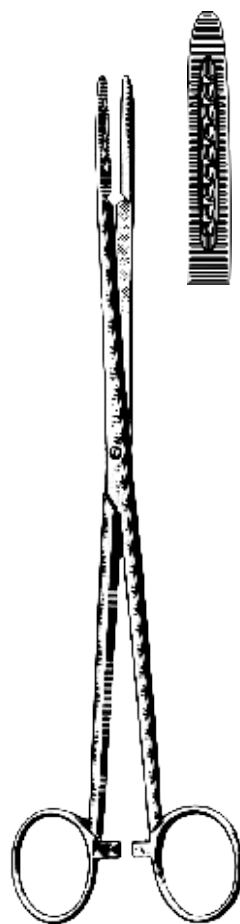

Maier
AD302525
25 cm / 10"



Collin
AD303025
25 cm / 10"

Cotton Swab Forceps

Derssing Forceps, Sponge Forceps

Kornzangen, Schwammzangen

Pinzas para vendajes, Pinzas para tapones

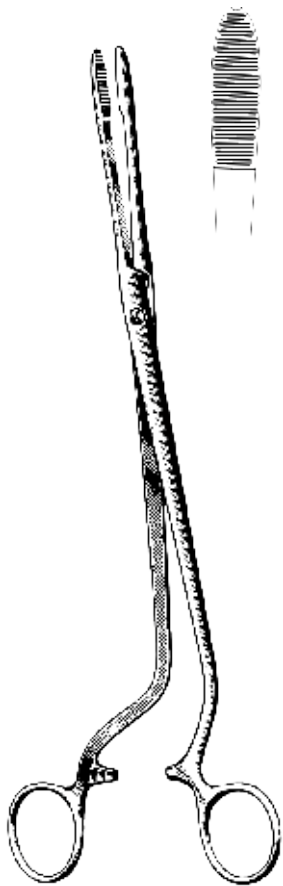
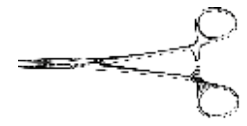

Cheron
AD303525
25 cm / 10"

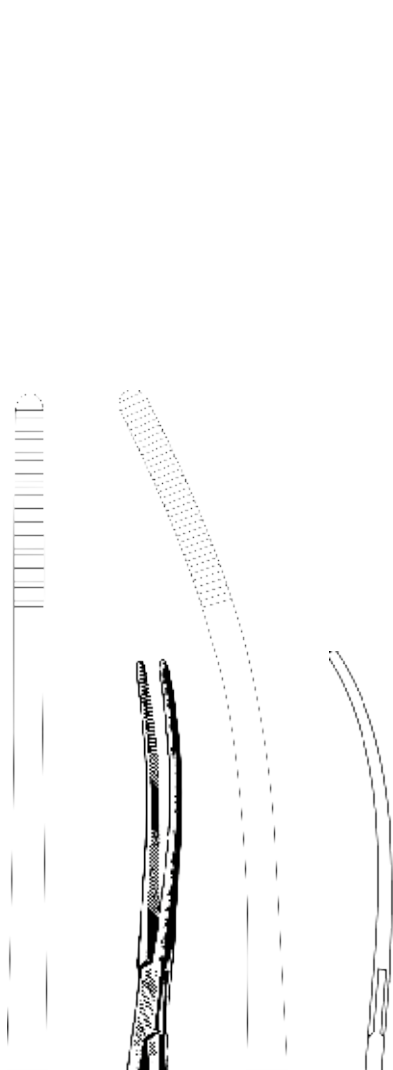

AD304026
Straight

AD304126
Curved

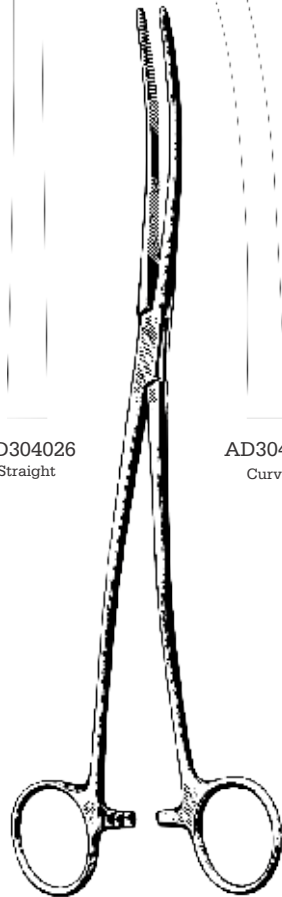

Bozemann
26 cm / 10 1/4"

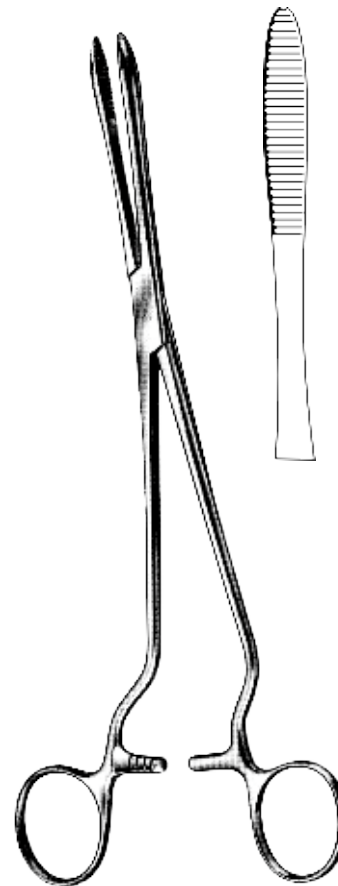

Cheron
AD304524
24 cm / 9 1/2"
Handles laterally angled

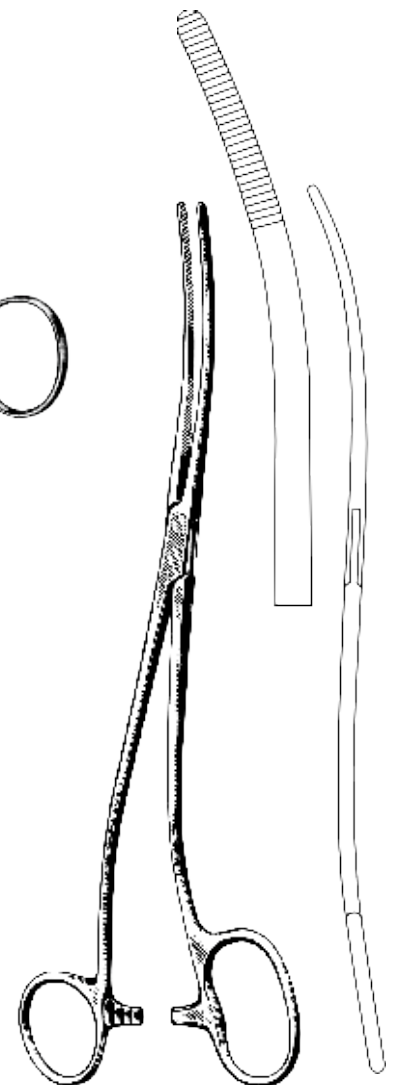

Bozemann-Douglas
AD305026
26 cm / 10 1/4"
One ring large



Cotton Swab Forceps
Sponge Forceps
Schwammzangen
Pinzas para tapones

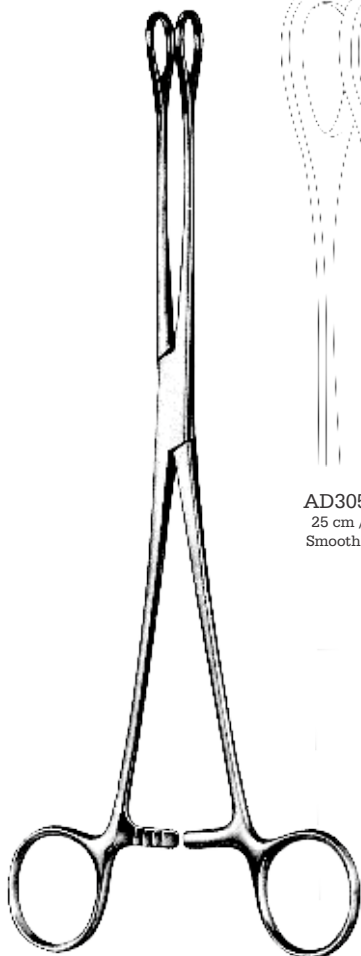

Foerster



AD305525
25 cm / 10"
Smooth jaws

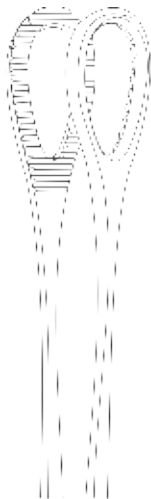

AD305618 18 cm / 7"
AD305620 20 cm / 8"
AD305625 25 cm / 10"

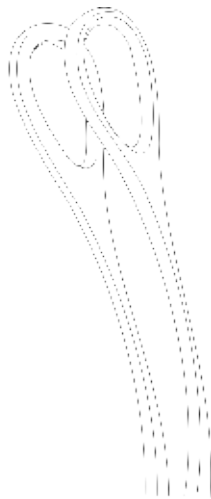

AD305725
25 cm / 10"
Smooth jaws

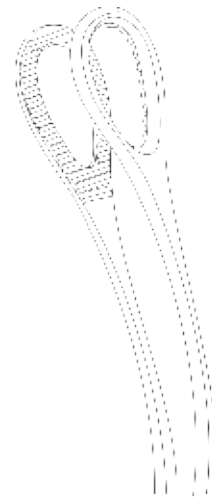

AD305818 18 cm / 7"
AD305820 20 cm / 8"
AD305824 25 cm / 10"

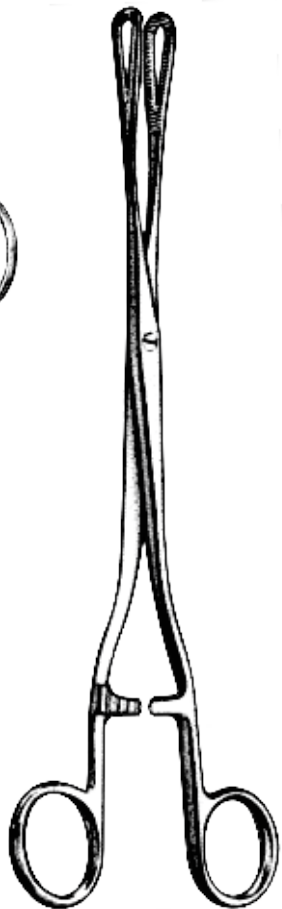

Rampley
AD306018 18 cm / 7"
AD306025 25 cm / 10"

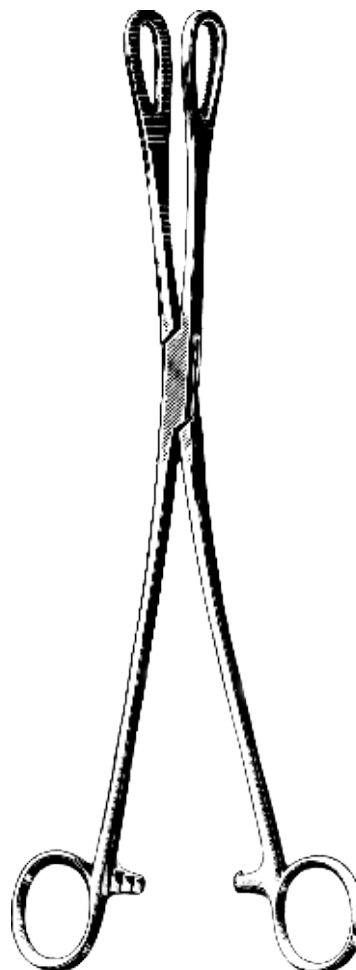

Rampley

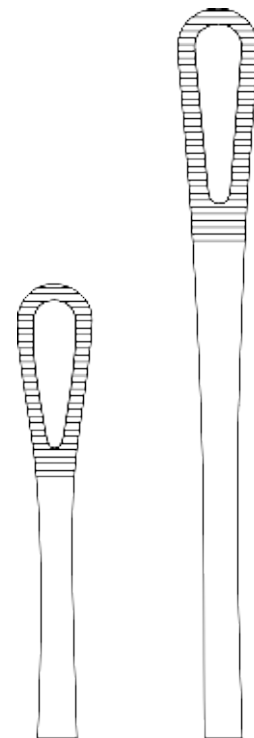

AD306518 18 cm / 7"
AD306524 25 cm / 10"
Box lock
AD306618 18 cm / 7"
AD306624 25 cm / 10"
Screw lock