

MPU 100

MPU 100 offers a unique combination of mechanical strength, biocompatibility, and sterilizability.

Table of Contents

Standard Technical Data Sheet:	Page 2-3
Extended Technical Data Sheet:	Page 4-17
- Mechanical Properties	Page 5
- Thermomechanical Properties	Page 6
- UV Aging	Page 7
- Biocompatibility Guide	Page 9-16
- Biocompatibility Testing	Page 17

Tensile Properties	Test Standard	Metric	US
Tensile Modulus	ASTM D638 Type I 50 mm/min	1300 MPa	190 ksi
Yield Strength (0.2% Offset)		15 MPa	2 ksi
Ultimate Tensile Strength		35 MPa	5 ksi
Elongation at Break		15%	15%
Tensile Modulus	ASTM D638 Type V 10 mm/min	1200 MPa	170 ksi
Yield Strength (0.2% Offset)		15 MPa	2 ksi
Ultimate Tensile Strength		35 MPa	5 ksi
Elongation at Break		25%	25%

Flexural Properties ASTM D790-B	Test Standard	Metric	US
Flexural Stress at 5% strain	ASTM D790-B	40 MPa	6 ksi
Flexural Modulus (Chord, 0.5-1%)		1000 MPa	145 ksi

Impact Properties	Test Standard	Metric	US
Unnotched Charpy	ISO-179-1/eU	35 kJ/m ²	15 ft-lb/in ²
Notched Charpy (Machined Notch)	ISO 179-1/1eA	2.2 kJ/m ²	1.0 ft-lb/in ²
Unnotched Izod	ASTM D4812	650 J/m	12 ft-lb/in
Unnotched Izod (-30C)		630 J/m	12 ft-lb/in
Notched Izod (Machined Notch)	ASTM D256	30 J/m	0.6 ft-lb/in
Notched Izod (Machined Notch) (-30C)		20 J/m	0.4 ft-lb/in

The information in this document includes values derived from printing various parts, reflects an approximation of the mean value of a range of values, and is intended for reference and comparison purposes only. This information should not be used for testing, design specification or quality control purposes. End-use material performance can be impacted by, but not limited to, design, processing, color treatment, operating and end-use conditions, test conditions, etc. Actual values will vary with build conditions. In addition, product specifications are subject to change without notice.

This information and Carbon's technical advice are given to you in good faith but without warranty. The application, use and processing of these and other Carbon products by you are beyond Carbon's control and, therefore, entirely your own responsibility. Carbon products are only to be used by you, subject to the terms of the written agreement by and between you and Carbon.

You are responsible for determining that the Carbon material is safe, lawful, and technically suitable for the intended application, as well as for identifying the proper disposal (or recycling) method consistent with applicable environmental laws and regulations. CARBON MAKES NO WARRANTIES OF ANY KIND, EXPRESSED OR IMPLIED, INCLUDING, BUT NOT LIMITED TO, THE WARRANTIES OF MERCHANTABILITY, FITNESS FOR A PARTICULAR USE, OR NON-INFRINGEMENT. Further, it is expressly understood and agreed that you assume and hereby expressly release Carbon from all liability, in tort, contract or otherwise, incurred in connection with the use of Carbon products, technical assistance and information. No license with respect to any intellectual property is implied.

Parts were processed using an M series printer and a Smart Part Washer with VF 1 as the solvent.

Thermal Properties	Test Standard	Metric	US
Heat Deflection Temperature at 0.455 MPa/66 psi	ASTM D648	50 °C	120 °F
Heat Deflection Temperature at 1.82 MPa/264 psi		40 °C	100 °F
Coefficient of Thermal Expansion (-60, 50 °C)	ASTM E831	110 ppm/°C	60 ppm/°F

Dielectric/Electric Properties	Test Standard	Metric	US
Dielectric Strength	ASTM D149	14 kV/mm	356 V/mil
Dielectric Constant	ASTM D150	3.7	3.7
Dissipation Factor		0.022	0.022

General Properties	Test Standard		
Hardness	ASTM D2240	81, Shore D	
Bulk Density	ASTM D792	1.12 g/mL	
Taber Abrasion	ASTM D4060, CS-17, 1 kg, 100% vacuum	30 mg/ 1000 cycles	
Water Absorption, Short Term (24 hours)	ASTM D570	< 1%	
Water Absorption, Long Term (14 days)		< 2%	

Liquid Properties	
Liquid Density (Part A)	1.05 g/mL
Liquid Density (Part B)	0.98 g/mL
Liquid Density (Part A+B)	1.05 g/mL
Part A:B Volume Ratio (Mass Ratio)	10.0 (10.7)
25 °C Viscosity (Part A)	4500 cP
25 °C Viscosity (Part B)	70 cP
25 °C Viscosity (Part A+B)	3300 cP

The information in this document includes values derived from printing various parts, reflects an approximation of the mean value of a range of values, and is intended for reference and comparison purposes only. This information should not be used for testing, design specification or quality control purposes. End-use material performance can be impacted by, but not limited to, design, processing, color treatment, operating and end-use conditions, test conditions, etc. Actual values will vary with build conditions. In addition, product specifications are subject to change without notice.

This information and Carbon's technical advice are given to you in good faith but without warranty. The application, use and processing of these and other Carbon products by you are beyond Carbon's control and, therefore, entirely your own responsibility. Carbon products are only to be used by you, subject to the terms of the written agreement by and between you and Carbon.

You are responsible for determining that the Carbon material is safe, lawful, and technically suitable for the intended application, as well as for identifying the proper disposal (or recycling) method consistent with applicable environmental laws and regulations. CARBON MAKES NO WARRANTIES OF ANY KIND, EXPRESSED OR IMPLIED, INCLUDING, BUT NOT LIMITED TO, THE WARRANTIES OF MERCHANTABILITY, FITNESS FOR A PARTICULAR USE, OR NON-INFRINGEMENT. Further, it is expressly understood and agreed that you assume and hereby expressly release Carbon from all liability, in tort, contract or otherwise, incurred in connection with the use of Carbon products, technical assistance and information. No license with respect to any intellectual property is implied.

Parts were processed using an M series printer and a Smart Part Washer with VF 1 as the solvent.

MPU 100

Extended TDS

MPU 100 Mechanical Properties

Representative Tensile Curve

ASTM D638, Type I, 50 mm/min

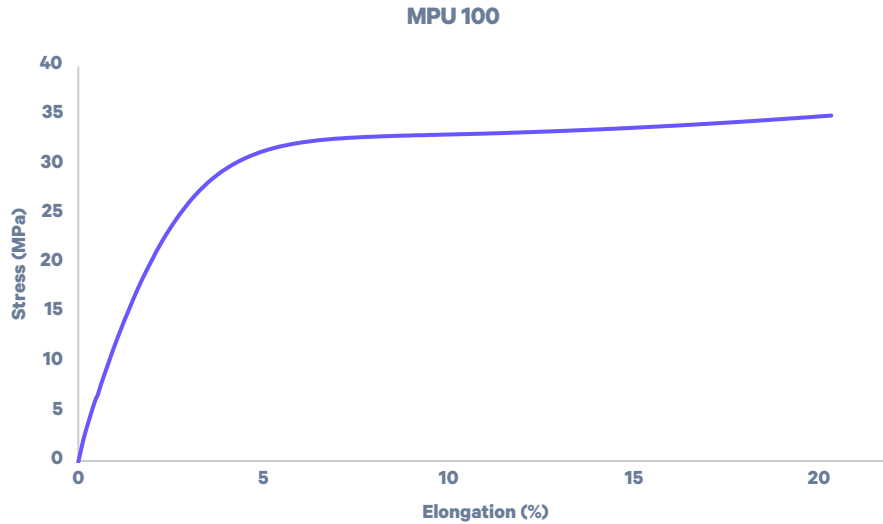

Representative Flexural Curve

ASTM D790-B

Samples are tested to 5% extension.

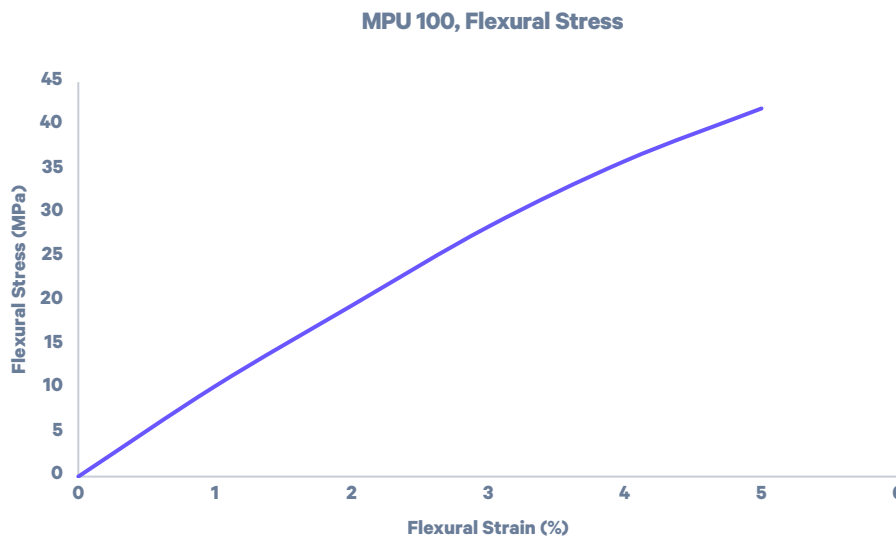

MPU 100 Dynamic Mechanical Analysis (DMA)

Dynamic mechanical analysis provides insight into the resin's viscoelastic properties across a range of temperatures. The figure below shows a temperature ramp of MPU 100. The peak in the $\tan(\delta)$ curves indicates that the glass transition temperature of MPU 100 is approximately 75 °C.

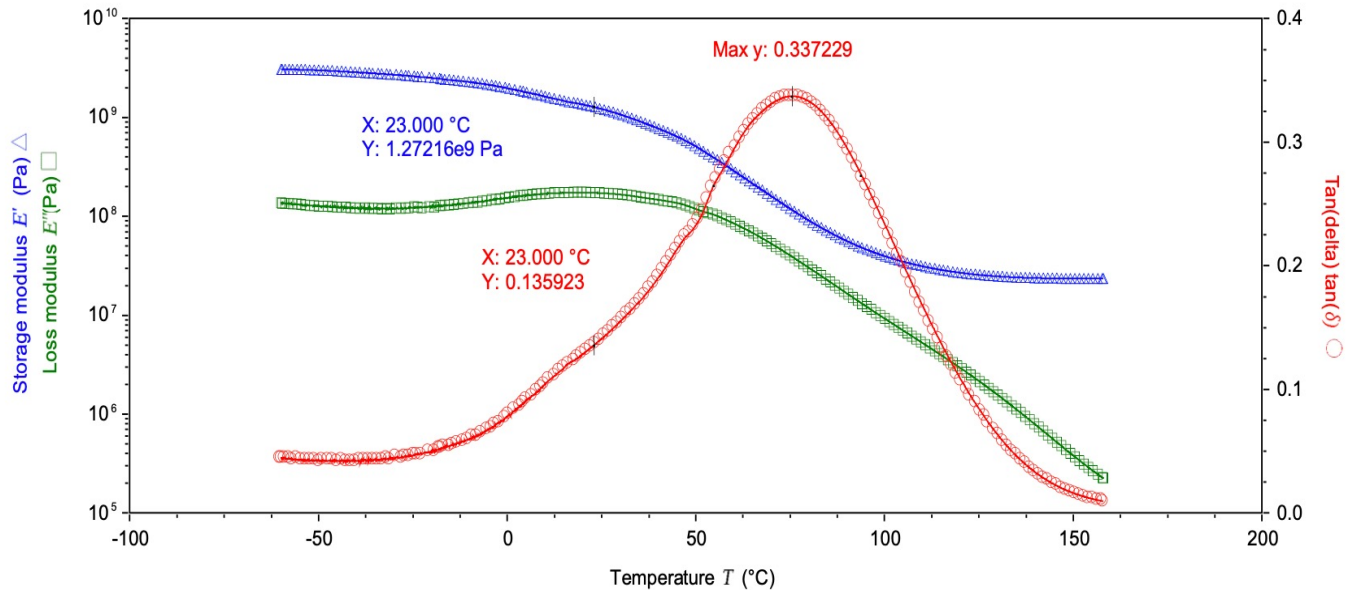

Standard: ASTM D4065

Instrument: TA DMA Q800

DMA Mode: Tension

Sample Dimensions: L=20 mm, W=10 mm, t=1 mm (rectangular block)

Strain Amplitude: 0.1% (linear regime of viscoelasticity)

Oscillation frequency: 1 Hz

Temperature Range: -60 °C to 150 °C

Ramp Rate: 1.5 °C/min

Print Conditions: Samples were hand-wiped and not washed with solvent. The thermal cure for all materials complies with the Carbon user manual. Values may differ based on post processing conditions.

MPU 100 UV Aging

Natural polymer aging can occur in the presence of light, sun, and heat. Carbon evaluated the UV aging performance of MPU 100 using ASTM D4459, which is intended to simulate indoor exposure of solar radiation through glass. Discoloration can also occur as a reaction to UV aging. Below is an example of the corresponding color changes taken over 360 hours of UV exposure according to ASTM D4459.

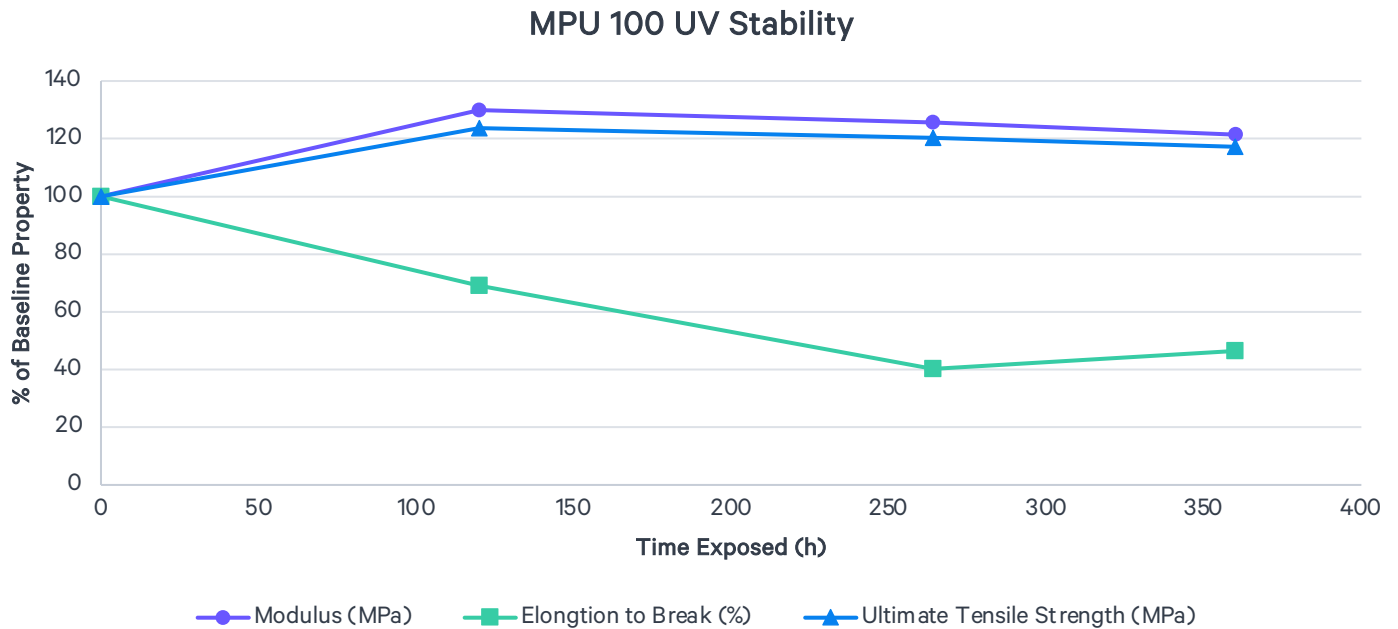

ASTM D4459: Q-Sun XE-1, 0.8 W/m² at 420 nm, 55 °C

ASTM D638: Type V, 500 mm/min, average values represented

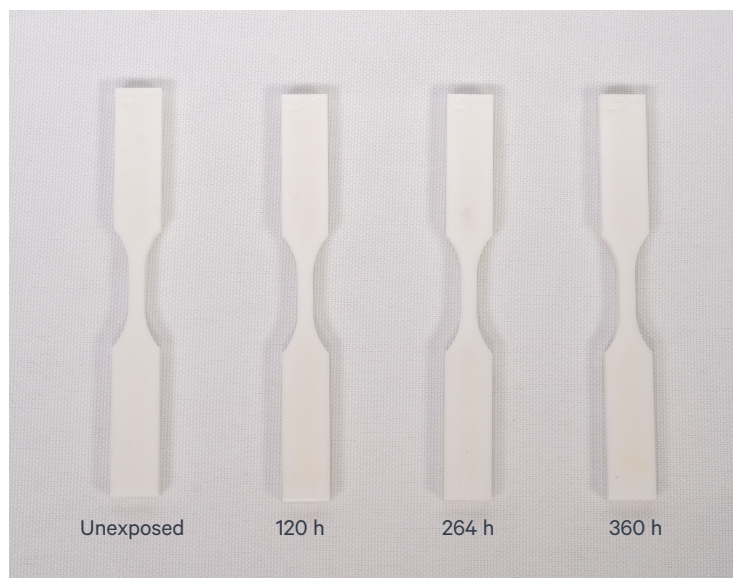

MPU 100 Biocompatibility Guide

Cleaning Agents Chemical Compatibility

MPU 100 Chemical Compatibility

MPU 100 is compatible with a range of commonly used hospital disinfectant agents including ethanol, bleach, chlorhexidine gluconate (CG), and benzalkonium chloride (BC). Carbon evaluated MPU 100's compatibility with these reagents applied using two application methods: Wipe only and 24 Hours soak. In this evaluation, compatibility was evaluated based on change in weight, color, and tensile properties of Type V tensile specimens.

Procedure

Parts were processed using an M series printer and a Smart Part Washer with VF 1 as the solvent. The following concentrations (% by weight) were used in the evaluation:

- (1) 5% Bleach
- (2) 70% Ethanol
- (3) 5% Chlorhexidine gluconate
- (4) 0.13% Benzalkonium chloride

Control samples were also generated to serve as the baseline.

Disinfectant Application: Wipe Only Protocol

The surface of a tensile dogbone specimen was wiped with a cotton swab saturated with the disinfectant reagent and subsequently rinsed in tap water and wiped dry. This procedure was repeated every five minutes for 20 applications. The samples were left to dry overnight before testing.

Disinfectant Application: 24 Hours Soak

Tensile dogbone specimens were completely submerged in each disinfectant solution for 24 hours at room temperature. After 24 hours, the samples were rinsed in tap water, wiped dry, and left to dry overnight.

Results

Overall, the results indicate that MPU 100 is compatible with the four tested disinfectants, showing minimal changes to the tensile properties and no change in mass, dimensions, or color.

MPU 100 Biocompatibility Guide

Cleaning Agents Chemical Compatibility cont.

Chemical Compatibility: Tensile Properties

The mechanical properties of MPU 100 was evaluated after exposure to various chemical disinfectants. The impact of the reagent on the mechanical properties was related to how the reagent was applied. As summarized in the table below, reagents applied by wiping on the tensile specimen surface showed minimal mechanical properties change compared to the control.

By contrast, tensile specimens that were soaked led to some changes in the mechanical property. Specifically, soaking MPU 100 in ethanol showed the largest deviation in mechanical properties compared to the control with a decrease in modulus and ultimate tensile strength.

ASTM D638 Type V	Wipe Only				24 Hours Soak			
	Modulus (MPa)	Ultimate Tensile Strength (MPa)	0.2% Offset Yield Strength (MPa)	Elongation at Break (%)	Modulus (MPa)	Ultimate Tensile Strength (MPa)	0.2% Offset Yield Strength (MPa)	Elongation at Break (%)
Bleach	1100	40	15	35	1000	40	15	35
Ethanol	1200	40	15	30	700	35	10	30
CG	1100	40	15	30	1000	40	10	35
BC	1100	40	15	30	1000	45	15	40
Control	1200	45	15	35	1200	45	15	35

MPU 100 Biocompatibility Guide

Ethylene Oxide Sterilization and Cytotoxicity

MPU 100 is a versatile material suitable for a potential range of medical applications. MPU 100 shows excellent response to ethylene oxide (EtO) sterilization with moderate change in physical properties and rapid reduction in EtO levels post-sterilization. For ionizing radiation sterilization (gamma and e-beam) MPU 100 shows some change in mechanical properties.

Ethylene Oxide (EtO) Sterilization

Carbon prepared n=10 test specimens and provided these samples to Nelson Laboratories for EtO exposure and extraction studies. The samples were conditioned at 52 °C, 55% relative humidity, and 1.3 psi for 60 minutes. The samples were then exposed to 100% EtO at 52 °C for 240 minutes. The samples were allowed to aerate for 24 hours and residuals were measured every hour for 170 hours post sterilization.

MPU 100 is compatible with EtO sterilization, showing a 30% increase in elongation at break, a 10% drop in modulus, and a < 5% drop in ultimate strength. Furthermore, there is a rapid reduction in EtO levels post-sterilization, with all EtO levels measuring below limits for prolonged contact after standard 24 h of aeration.

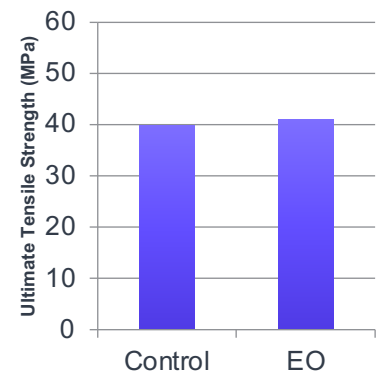
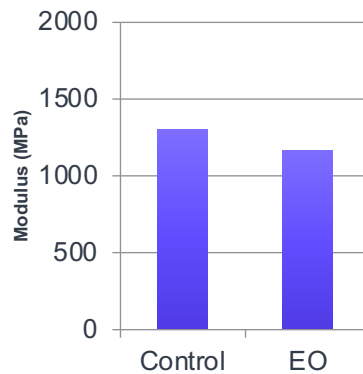
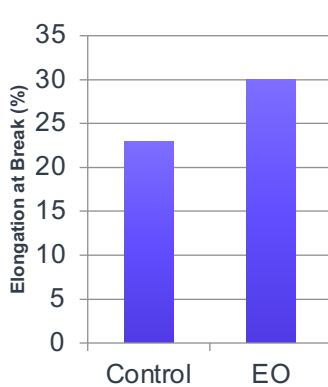

MPU 100 Biocompatibility Guide

Ethylene Oxide Sterilization and Cytotoxicity

Post EtO Sterilization Cytotoxicity

After one cycle of sterilization, samples were tested for cytotoxicity (ISO 10993-5, *Biological evaluation of medical devices – Part -5 Tests for in vitro cytotoxicity*). The results show that post-sterilization, there is no observed cytotoxicity.

EtO Dissipation

Time axis: Hours post sterilization (first time point at 24 hours after exposure)

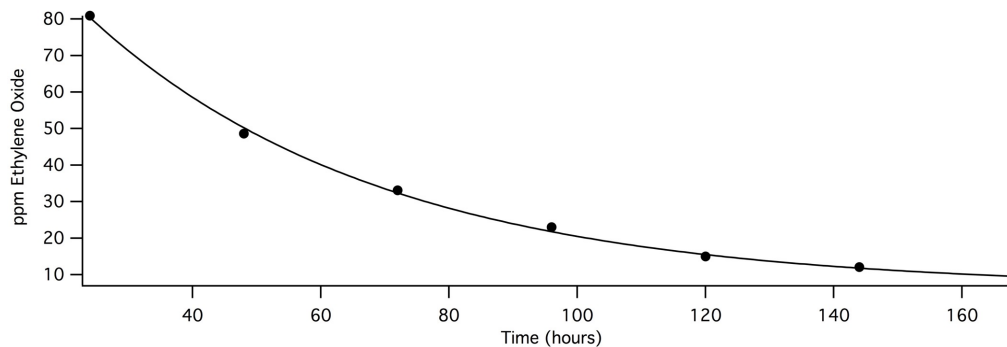

Fitting equation:

$$\text{ppm EtO} = 6.38 + 124.9 e^{-0.022t}$$

Mean Lifetime = 45.8 hours (based on exponential decay model, ppm EtO released versus time in hours).

Ethylene oxide release for a hypothetical 100 g device would be 3 mg at 24 hours and cumulative (30 days) of 7.4 mg. Average release rate is 0.25 mg/day from day 2 to 30, and 0.093 mg/day from day 4 to 30. MPU 100 meets the requirements per ISO 10993-7: *Ethylene oxide sterilization residuals*.

The samples show no observable change in color post-EtO sterilization. The samples had a yellowness index (E313, D65/10) of 18.0 pre-sterilization (control) and 17.7 after EtO sterilization.

MPU 100 Biocompatibility Guide

E-beam Sterilization and Cytotoxicity cont.

E-beam Sterilization

Carbon prepared n=10 test specimens and provided these samples to Steris for e-beam sterilization. The samples were exposed to 33.9 – 36.6 kGy e-beam radiation (measured by dosimeter).

When exposed to e-beam sterilization, MPU 100 demonstrates 22% reduction in elongation at break, a 40% increase in modulus, and a 23% increase in ultimate strength. The test specimens also show some yellowing post-sterilization. The samples had a yellowness index (E313, D65/10) of 18.0 pre-sterilization (control) and 22.5 after e-beam sterilization.

Post e-Beam Sterilization Cytotoxicity

After 1 cycle of sterilization, samples were tested for cytotoxicity per ISO 10993-5, *Biological evaluation of medical devices – Part 5: Tests for in vitro cytotoxicity*. The results show that post-sterilization, there is no observed cytotoxicity.

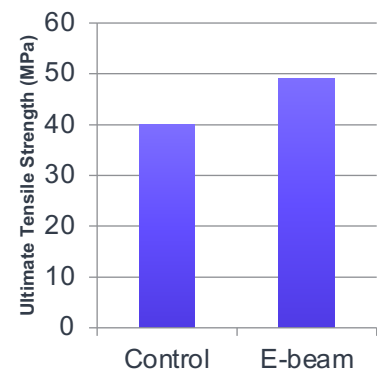
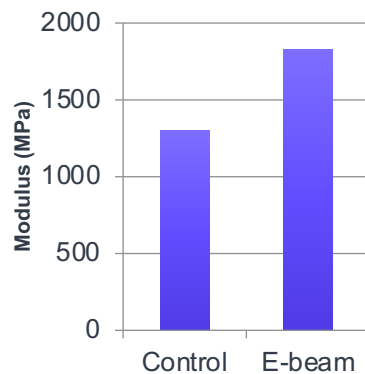
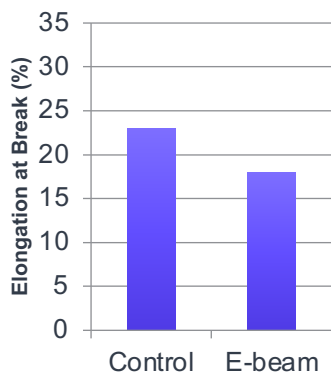

MPU 100 Biocompatibility Guide

Gamma Sterilization and Cytotoxicity

Gamma Sterilization

Carbon prepared n=10 test specimens and provided these samples to Steris for gamma sterilization. The samples were exposed to 34.12 – 35.61 kGy gamma radiation (measured via dosimeter).

When exposed to gamma sterilization, MPU 100 demonstrates a 13% reduction in elongation at break, a 38% increase in modulus, and a 25% increase in ultimate strength. The test specimens also show some yellowing post-sterilization. The samples had a yellowness index (E313, D65/10) of 18.0 pre-sterilization (control) and 22.6 after gamma sterilization.

Post Gamma Sterilization Cytotoxicity

After one cycle of sterilization, samples were tested for cytotoxicity per ISO 10993-5, *Biological evaluation of medical devices – Part 5: Tests for in vitro cytotoxicity*. The results show that post-sterilization, there is no observed cytotoxicity.

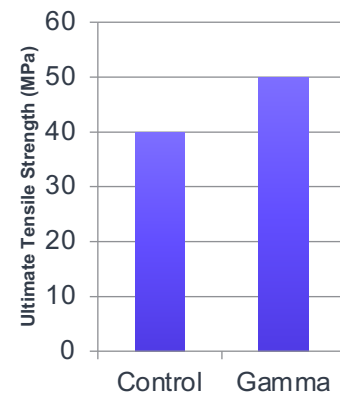
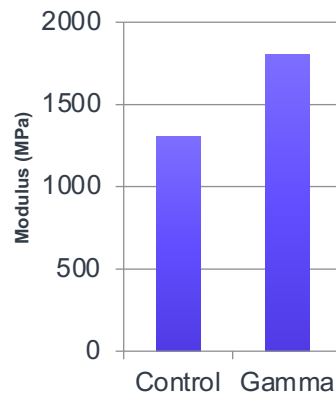
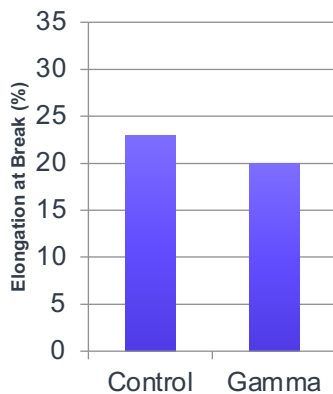

MPU 100 Biocompatibility Guide

Autoclave Sterilization and Cytotoxicity

Autoclave Sterilization:

Carbon prepared tensile specimens which underwent five cycles of sterilization consisting of ten minutes autoclave at 131 °C followed by three min wash in 5% Deconex LIQ.

When exposed to a single autoclave cycle, MPU 100 demonstrates a 5% increase in elongation at break, a 14% drop in modulus, and a 14% drop in ultimate strength. After five cycles of autoclave, MPU 100 demonstrates an overall 35% decrease in elongation at break, a 35% drop in modulus, and a 31% drop in ultimate tensile strength.

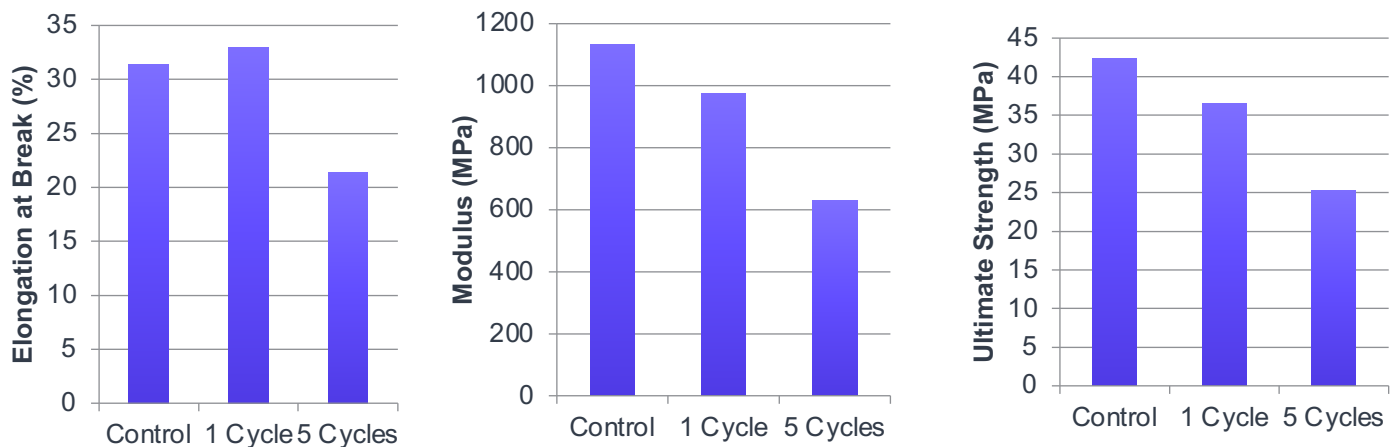

Autoclave Sterilization Impact on Part Geometry

MPU 100's heat deflection temperature (48 °C for a load of 0.455 MPa) is below typical autoclaving temperatures. While this can lead to warpage in part geometry, it is possible to autoclave MPU 100 and maintain part dimensions if the part experiences zero load during the entire autoclaving process including the cool down stage. To assess this, we subjected a "U-shaped" geometry to two successive autoclave cycles and monitored the change in mass and dimensions after each cycle. The general geometry of this part is similar to the drawing on the right and the dimensions, D1 to D4, are monitored.

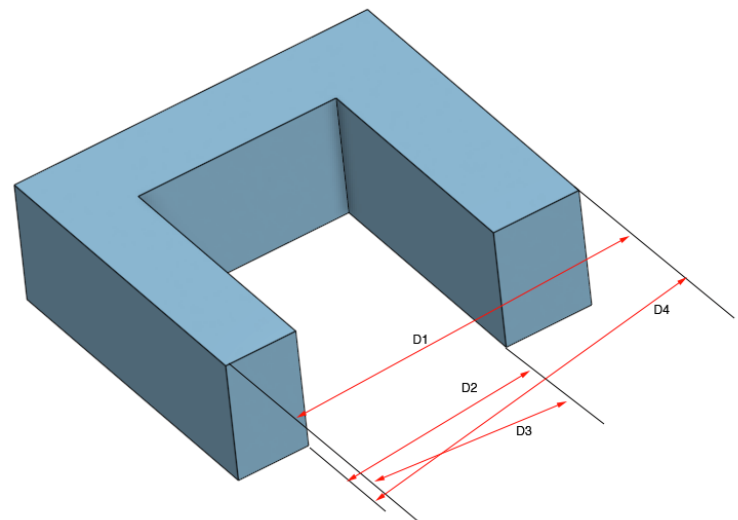

MPU 100 Biocompatibility Guide

Autoclave Sterilization and Cytotoxicity cont.

Autoclave Sterilization: Part Geometry cont.

D1 and D2 will be most affected by “splay”, an opening of the “U”, whereas changes in D3 and D4 are sensitive to loss of planarity. Volumetric swelling could also contribute to changes in these distances. Five parts (containing four reference points to facilitate digital caliper measurement) were autoclaved at 131 °C for 10 minutes. After each autoclave cycle, the parts were allowed to return to room temperature prior to handling (5-10 minutes). These were compared with five control samples held at room temperature.

Part Mass After Autoclave Cycles:

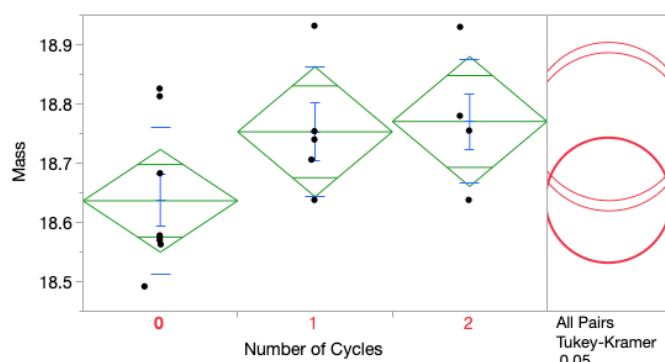

No statistically significant change in mass (0.7% mass increase) was observed. Note that after the initial autoclave, no further water uptake was noted in the second cycle.

Part Dimensions (D1 – D4) After Autoclave Cycles:

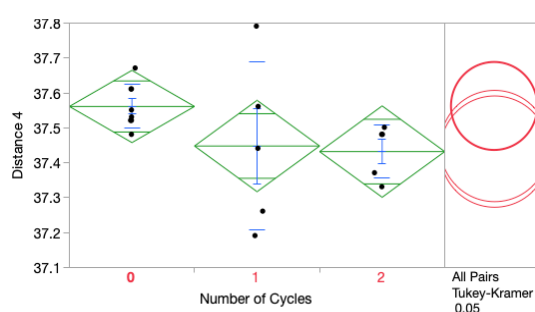
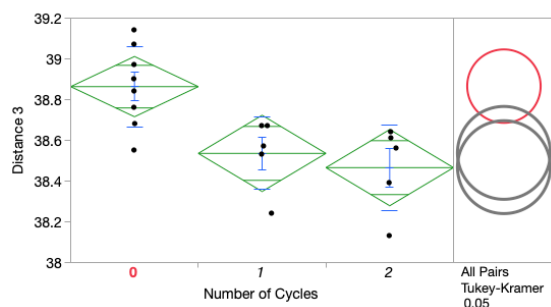
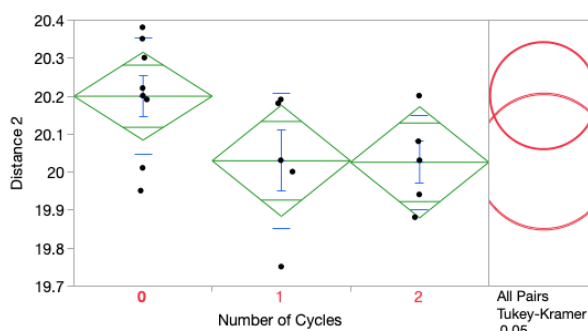
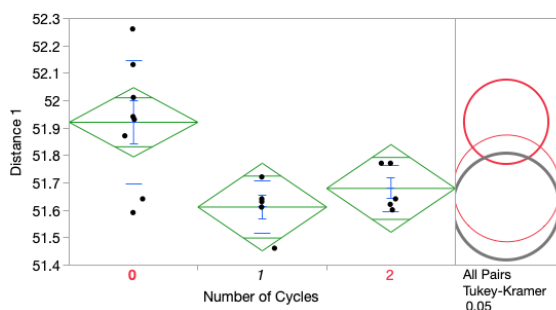

MPU 100 Biocompatibility Guide

Autoclave Sterilization and Cytotoxicity

Autoclave Sterilization: Part Geometry cont.

Dimension	Measurement	% Change
D1	-310 ± 250 microns	-0.6%
D2	-170 ± 240 microns	-0.8%
D3	-328 ± 300 microns	-0.8%
D4	-113 ± 240 microns	-0.3%

(All data presented at the 95% confidence limit, ±2 SD)

For the "U-shaped" part used in this study, the dimensional change after autoclave cycles were minimally impacted; however, dimensional changes during autoclave sterilization can be geometry dependent. It is the responsibility of the Subscriber or manufacturer of the final end-use part to demonstrate that dimensional changes are acceptable post-autoclave sterilization.

Post-Autoclave Cytotoxicity

Both samples subjected to one and two autoclave cycles were tested for cytotoxicity per ISO 10993-5, *Biological evaluation of medical devices – Part 5: Tests for in vitro cytotoxicity*. The results showed no observed cytotoxicity post-autoclave sterilization.

Summary

MPU 100 appears to be an acceptable material for single-use medical device applications, provided that the device is of suitable geometry and not under static load during autoclave. Parts should be allowed to cool completely prior to handling. Static loads would include, but not be restricted to:

- interference fits
- snaps and clasps
- parts in tension due to fasteners
- parts with long “cantilevered” components

Testing of MPU 100 suitability for use with autoclave sterilization is the sole responsibility of the Subscriber or manufacturer of the end-use product.

MPU 100 Biocompatibility Guide

Biocompatibility Testing

Biocompatibility Testing

Printed parts were provided to NAMSA for evaluation in accordance with:

ISO 10993-5, *Biological evaluation of medical devices - Part 5: Tests for in vitro cytotoxicity*

ISO 10993-10, *Biological evaluation of medical devices - Part 10: Tests for irritation and skin sensitization (GPMT)*.

ASTM F756, Standard Practice for Assessment of Hemolytic Properties of Materials

& ISO 10993-4, *Biological evaluation of medical devices - Part 4: Selection of tests for interactions with blood*.

USP, General Chapter <88>, *Biological Reactivity Tests, In Vivo. Systemic Toxicity, Muscle Implantation*

The results indicated that MPU 100 passed the requirements for biocompatibility according to the above tests. Parts were processed using an M series printer and a Smart Part Washer with VF 1 as the solvent. **Carbon makes no representation and is not responsible for the results of any biocompatibility tests other than those specified above.**

Disclaimer

Biocompatibility and sterilization results may vary if protocols are used other than those outlined in this document.

Subscriber acknowledges the contents of this document are subject to the Terms and Conditions outlined in the Subscription Agreement, including the Restrictions on Use section.

DO NOT USE CARBON MATERIALS IN MEDICAL APPLICATIONS INVOLVING IMPLANTATION IN THE HUMAN BODY OR CONTACT WITH BODY FLUIDS OR TISSUES UNLESS THE MATERIAL HAS BEEN PROVIDED FROM CARBON UNDER A WRITTEN CONTRACT THAT IS CONSISTENT WITH THE CARBON POLICY REGARDING MEDICAL APPLICATIONS AND EXPRESSLY ACKNOWLEDGES THE CONTEMPLATED USE. CARBON MAKES NO REPRESENTATION, PROMISE, EXPRESS WARRANTY OR IMPLIED WARRANTY CONCERNING THE SUITABILITY OF THESE MATERIALS FOR USE IN IMPLANTATION IN THE HUMAN BODY OR IN CONTACT WITH BODY FLUIDS OR TISSUES.

If Carbon has permitted in the Subscription Agreement use of the Carbon printer for applications that require sterilization, Subscriber acknowledges that it is the responsibility of Subscriber, its respective customers and end-users to determine the biocompatibility of all printed parts for their respective uses.

Carbon, Inc. | www.carbon3d.com

1089 Mills Way

Redwood City, CA 94063

1 (650) 285-6307