

24

FANTIN

Uno (1973)

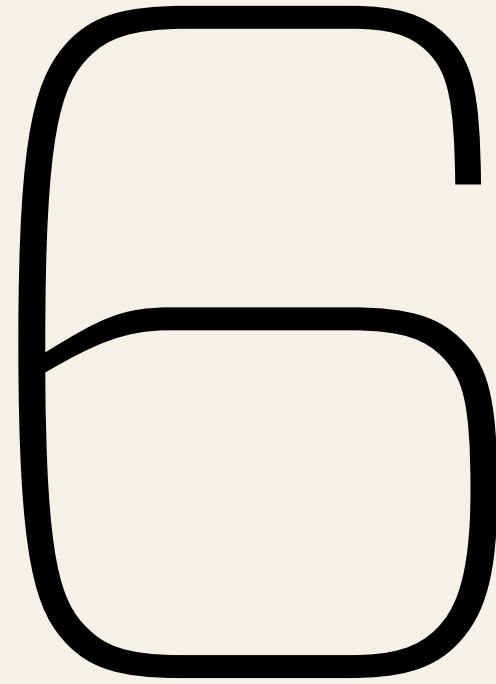

Values
Valori
Werte

Long-standing dedication Storia e passioni Geschichte und Passion

Fantin was founded in 1968 in Bannia near Fiume Veneto, in the heart of one of the most important industrial areas in Italy and the whole of Europe. The helm of the company has always remained in the hands of the Fantin family. They have shaped it into a specialist manufacturer of metal furniture and solutions that are renowned on the market for one key value: quality, which in this case means a blend of visual appeal, solidity, functionality and sustainability.

Fantin viene fondata nel 1968 a Bannia di Fiume Veneto, nel cuore di una delle più importanti aree industriali italiane ed europee. La famiglia Fantin, da sempre alla guida dell'azienda, ha creato una realtà specializzata nella produzione di arredi e soluzioni in metallo, riconosciuti dal mercato per un valore imprescindibile: la qualità, intesa come sintesi fra bellezza e solidità, funzionalità e sostenibilità.

Fantin wurde 1968 im Ortsteil Bannia des Städtchens Fiume Veneto gegründet, also in einem der bedeutendsten Industriegebiete Italiens und Europas. Die Familie Fantin, die das Unternehmen seitdem leitet, hat sich auf die Produktion von Möbeln und Einrichtungslösungen aus Metall spezialisiert, die sich auf dem Markt aufgrund ihres unverzichtbaren Erkennungszeichens einen Namen gemacht haben: die Qualität als Synthese aus Ästhetik und Solidität, Funktionalität und Nachhaltigkeit.

Metal and ingenuity Metallo e ingegno Metall und Genialität

We have vast experience of working with metal, which we have been doing devotedly for over 50 years. The collections that we conceive and produce stem from tireless research and ongoing development of design skills and solutions. They are enhanced by mechanical manufacturing processes and we always strive to strike a balance between industrial approaches and craftsmanship, efficient production and attention to detail.

Il metallo è il materiale che lavoriamo con passione da oltre 50 anni, e dal quale abbiamo maturato la nostra esperienza. Ideiamo e produciamo le nostre collezioni grazie alla continua ricerca e allo sviluppo di soluzioni e competenze progettuali, valorizzate dalla qualità delle lavorazioni meccaniche, in un equilibrio tra industria e artigianato, efficienza produttiva e cura del dettaglio.

Wir verarbeiten seit 50 Jahren Metall mit großer Begeisterung und verdanken ihm unsere Erfahrung. Wir entwerfen unsere Kollektionen, realisieren sie mithilfe der ständigen Suche nach Lösungen und entwickeln neue Projektkompetenzen, die durch die Qualität der mechanischen Verarbeitungen in einem ausgewogenen Verhältnis zwischen industrieller und handwerklicher Herstellung, produktiver Effizienz und Liebe zum Detail aufgewertet werden.

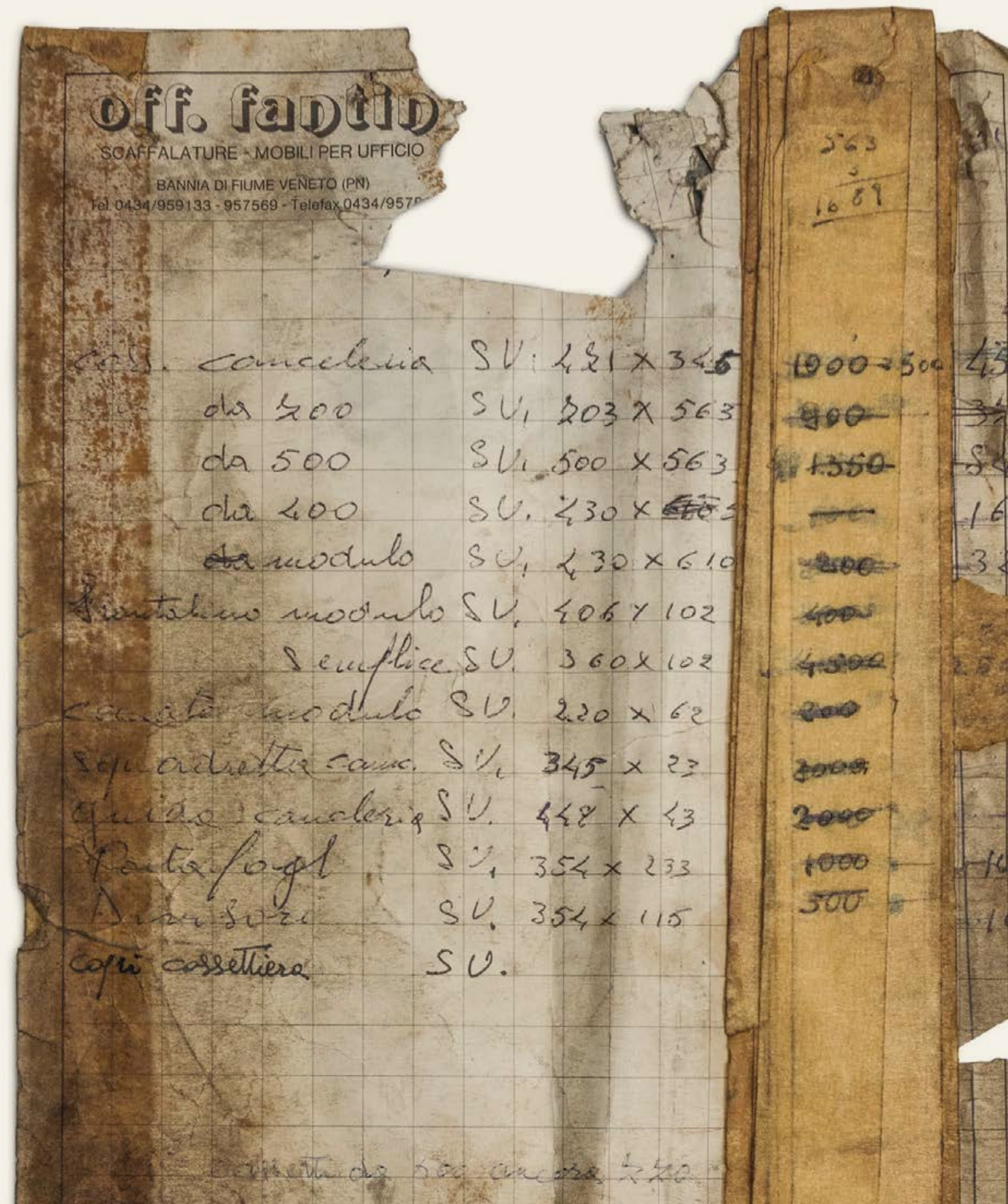

Versatile looks Estetica versatile Vielseitige Ästhetik

The clean-cut designs intelligently combine versatility and visual appeal. The attractive, practical items of furniture are the perfect match for every setting: from homes to offices, from shops to factories. Our goal is to help to create environments where people feel comfortable, by catering to their needs and reflecting their personalities.

Il design essenziale combina con intelligenza l'estetica alla versatilità. Arredi belli, funzionali e perfetti in ogni contesto: dalla casa all'ufficio, dal negozio all'industria. Vogliamo contribuire a creare ambienti in cui le persone possano sentirsi a proprio agio, interpretando i bisogni e la personalità di chi li vive.

Das nüchterne Design verbindet die Ästhetik auf intelligente Art mit der Vielseitigkeit. Schöne, funktionelle Möbel, die für jeden Kontext ideal sind: im eigenen Heim und im Büro, im Geschäft oder Industriebetrieb. Wir haben uns das Ziel gesetzt, ein Ambiente zu schaffen, in dem sich jeder wohlfühlt, deshalb interpretieren wir die Bedürfnisse und die Persönlichkeit des jeweiligen Bewohners.

Balanced colours Equilibrio cromatico Chromatisches Gleichgewicht

For all of our collections, we have a breathtaking colour palette consisting of more than 30 different finishes. Ranging from neutral tones to the brightest hues, they provide the scope for numerous aesthetic solutions. Through surfaces, we endeavour to breathe life into metal and bring to fruition the creative hopes and dreams of even our most imaginative and visionary customers.

Per tutte le nostre collezioni offriamo una sorprendente palette cromatica composta da più di 30 finiture, dai colori neutri ai più intensi, che permettono molteplici soluzioni estetiche. Il nostro obiettivo è dare un'anima al metallo attraverso la superficie, per soddisfare la creatività e i sogni dei nostri clienti, anche i più curiosi e visionari.

Für all unsere Kollektionen bieten wir eine erstaunliche Farbpalette, die mehr als 30 Finishes umfasst – von eher neutralen bis zu kräftigeren Nuancen – für unzählige ästhetische Lösungen. Wir wollen dem Metall mithilfe der Oberfläche eine Seele einhauchen, um die Kreativität unserer Kunden zu befriedigen und ihre Träume zu erfüllen, selbst wenn sie ungewöhnlich und visionär sind.



Flexible production Produzione flessibile Flexible Produktion

The entire production cycle takes place in our facilities: from the arrival of the raw materials to mechanical cutting, punching, bending, tack welding, final welding, powder coating, assembly and packaging for delivery. This enables us to be flexible and satisfy individual product needs while also carrying out more complex activities for the contract market.

All'interno del nostro stabilimento ha luogo l'intero ciclo produttivo: dall'arrivo delle materie prime alle lavorazioni meccaniche di taglio, punzonatura, piegatura, puntatura e saldatura, fino alla verniciatura a polveri e al montaggio e imballaggio per la spedizione. Ciò consente una gestione flessibile, che soddisfa sia la richiesta del singolo prodotto sia le più complesse attività legate al contract.

In unserem Werk findet der gesamte Produktionszyklus statt: von der Anlieferung der Rohstoffe bis zu den mechanischen Verarbeitungsprozessen wie Schneiden, Pressen, Biegen, Stanzen, Schweißen sowie Pulverlackierung, Montage und Verpackung für den Versand. Das heißt, dass wir den Betrieb flexibel verwalten können, um die Nachfrage nach einzelnen Produkten genauso wie komplexere Aktivitäten für den Contract-Bereich befriedigen zu können.

Sustainable outlook Filosofia sostenibile Nachhaltiges Denken

With the close ties between human well-being and the environment in mind, we have a sustainable outlook that takes concrete form in all of our collections. Our products are made of 100% recyclable metal, all of our powder coatings are non-toxic and we have short supply chains (all suppliers are based within 25 km of our premises). In addition, our solid, durable products help to reduce waste in terms of resources, raw materials and energy, thus lowering their environmental impact.

Riconoscendo lo stretto legame esistente tra il benessere umano e l'ambiente, promuoviamo una filosofia sostenibile, che si concretizza in tutte le nostre collezioni: prodotti realizzati in metallo 100% riciclabile; verniciatura a polveri esclusivamente atossiche; filiera corta dei fornitori (entro 25 km dalla nostra sede); solidità e durabilità dei prodotti, che garantiscono un minore utilizzo di risorse, materie prime ed energia e, di conseguenza, un minor impatto ambientale.

Da wir die enge Beziehung zwischen der Gesundheit des Menschen und der Umwelt kennen, unterstützen wir eine Philosophie der Nachhaltigkeit, die vor allem in unseren Kollektionen umgesetzt wird: Wir verwenden für unsere Produkte 100% recyceltes Metall, die Lackierung erfolgt ausschließlich mit ungiftigen Pulvern. Wir haben kurze Lieferketten, d.h. unsere Lieferanten befinden sich in nächster Nähe (in 25 km Entfernung), unsere Produkte sind robust und langlebig, sodass weniger Ressourcen, Rohstoffe und Energie verbraucht werden und folglich die Umweltbelastung geringer ist.



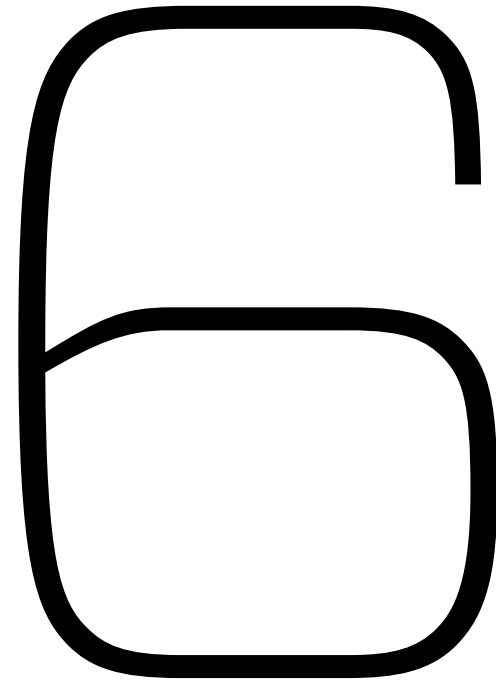
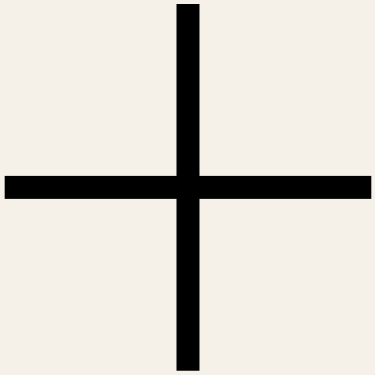

Environments
Contesti
Umgebungen

home



work



retail



community



outdoor



scenography



67.24

Pink clay / Argilla rosa / Rosa ton

Embossed / Goffrato / Gaufriert

FANTIN 2024

Frame

Bookcase system 16

- **Kitchens & workbenches** 32

Tall units 52

- **Stools** 60

Sideboards & cupboards 66

Beds 78

Tables & desks 90

Hug

- **Tables & stools** 98

Hangers 110

Wave

Desks & add-ons 114

- **Still** 120

Uno 130

Uno living 142

Ali 146

Just 154

Cambio 162

- **Run** 174

Mya 178

- **Classic** 182

Essenza 188

Binaria 194

Vela 202

Discovery 210

Ad hoc 220

Indoor finishes 232

Outdoor finishes 240

- Some models are suitable for outdoor use.
Alcuni modelli sono disponibili per esterni.
Einige Modelle sind für den Außenbereich.

Frame

Bookcase system

Salvatore Indriolo, 2019



The distinguishing characteristics of the Frame bookcase selection are rational right-angled lines and endless composition possibilities: three lengths of shelves with six different heights can be freely combined with backboards, sides and compartments with top and bottom opening doors, all of which are inset in the frame. The system has been designed with no visible holes or screws, thus shining the spotlight on the clean-cut appearance of every detail.

Il sistema di librerie Frame si caratterizza per la razionalità delle linee ortogonali e per le infinite possibilità compositive: tre lunghezze di ripiani su sei altezze, dove poter disporre in libertà schienali, fianchi e vani con ante a ribalta e rialza, sempre in luce al telaio. Il sistema, inoltre, è stato disegnato senza forature e viti di giunzione in vista, così da lasciare spazio alla pulizia formale di ogni dettaglio.

Das Regalsystem Frame besteht mit seinen zweckmäßigen, orthogonalen Linien und den unzähligen Kombinationsmöglichkeiten: Einlegeböden in drei Längen bei sechs Höhen, die beliebig mit Rückwänden, Seitenteilen, Fächern sowie Dreh-Kipp- und Hebe-Türen – stets im Lichtmaß des Rahmens – kombiniert werden können. Das System wurde außerdem ohne sichtbare Bohrlöcher und Verbindungsschrauben gestaltet, um der formalen Klarheit jedes Details den nötigen Raum zu geben.

Uprights / Spalle / Pfosten

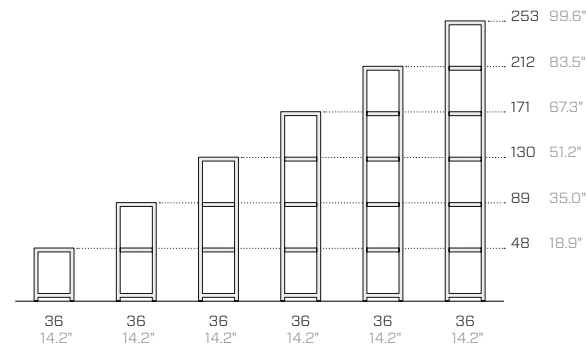

Shelves / Ripiani / Regalböden



The Frame bookcase selection is suitable for use in offices in all of its possible forms. It was designed with no visible holes or screws, thus shining the spotlight on the clean-cut appearance of every detail.

Il sistema libreria Frame, adatto in contesti ufficio in tutte le sue possibilità compositive, è stato disegnato senza forature e viti di giunzione a vista, così da lasciare spazio alla pulizia formale di ogni dettaglio.

Das Regalsystem Frame ist mit all seinen kompositorischen Möglichkeiten für den Einsatz im Büro geeignet und wurde ohne sichtbare Lochungen und Verbindungen entwickelt, um Raum für die formale Sauberkeit jedes Details zu lassen.



Back panels / Schiene / Rückwände

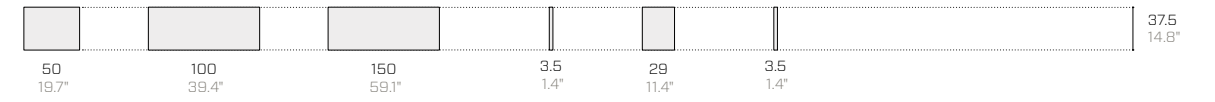

Sides / Fianchi / Seitenteile

Vertical opening doors / Ante a rialza / Hebe-Türen

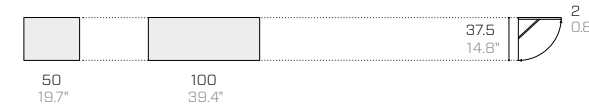

Tilt & turn doors / Ante a ribalta / Dreh-Kipp-Türen

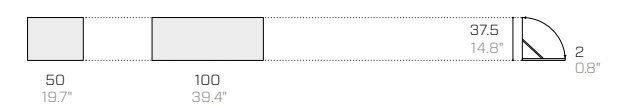











Frame

Kitchens & workbenches

Salvatore Indriolo, 2018



archiproducts
AWARDS
WINNER

archiproducts
AWARDS
WINNER
SUSTAINABILITY



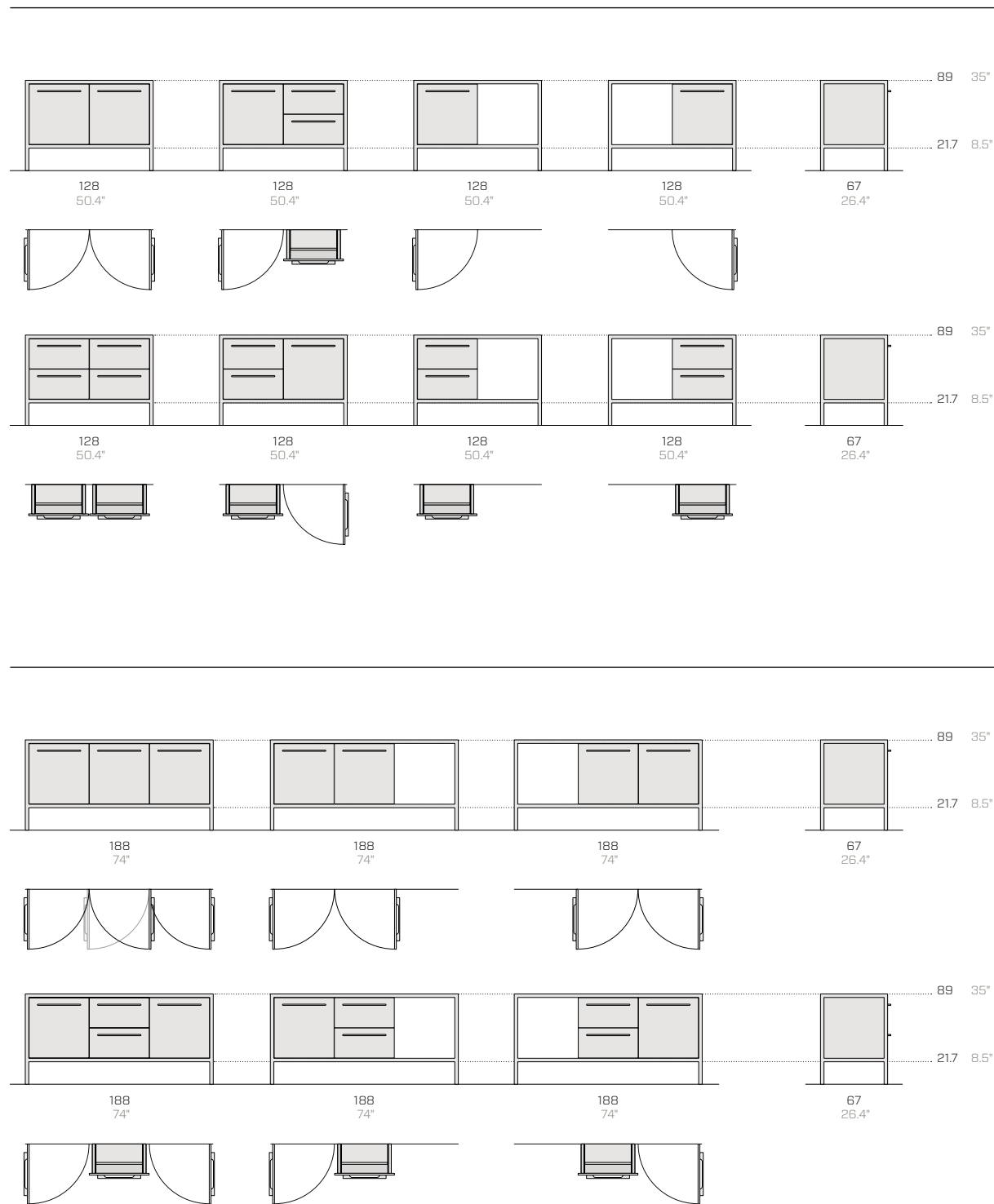

Frame kitchens come with 2 or 3 units and feature tops made of 4 mm Barazza steel - with either a Vintage or satin finish - that can be matched with all Fantin finishes. Rounding off the options are open compartments and wall panelling in versions with and without a shelf with built-in lighting, which optimize space while adding plenty of personality.

Le cucine Frame sono proposte a 2 o 3 moduli, con top in acciaio Barazza da 4 mm - nelle finiture Vintage e satinata - abbinabili con tutte le finiture Fantin. Completano l'offerta i vani a giorno e le boiserie a parete, nelle varianti con o senza mensola con illuminazione integrata, ottimizzando lo spazio con personalità.

Die Küchen Frame sind mit 2 oder 3 Modulen und Arbeitsplatten aus 4 mm starkem Stahl Barazza in den Ausführungen Vintage und satiniert erhältlich, die zu allen Oberflächen von Fantin passen. Das Angebot wird durch offene Fächer und Wandelemente in den Varianten mit oder ohne Ablage und integrierter Beleuchtung ergänzt, die den Raum auf individuelle Weise optimieren.









dancing



18.21 Dusty blue + G18.23 Dusty blue



19.18 Gentian blue + G19.23 Gentian blue



20.19 Steel blue + G20.23 Steel blue



Frame Kitchen is also available in outdoor versions, thanks to a cataphoresis treatment that guarantees high resistance to weather conditions.

Frame Kitchen è disponibile anche in versioni per esterni, grazie a un trattamento di cataforesi che garantisce un'elevata resistenza agli agenti atmosferici.

Frame Kitchen ist auch in der Version Outdoor mit Kataphorese-Behandlung, die der hohe Beständigkeit gegen Witterungseinflüsse garantiert, erhältlich.





Frame workbenches come with three top options: Barazza steel with a thickness of 4 mm – in a vintage or satin finish – or metal. The welded square tube frames are always visible, thus underlining the exceptional solidity of the units.

I banconi Frame sono proposti con tre possibilità di top: in acciaio Barazza da 4 mm di spessore – in finitura Vintage o satinata – o in metallo. Il telaio, in tubo quadro saldato, è sempre a vista ed è garanzia di grande solidità.

Die Werkbänke Frame werden mit drei Abdeckungs-Optionen angeboten: aus 4 mm dickem Stahl Barazza – mit Vintage-Finish oder satiniert – oder Metall. Der Rahmen aus geschweißtem Vierkanthrohr ist stets sichtbar und gewährleistet hohe Stabilität.

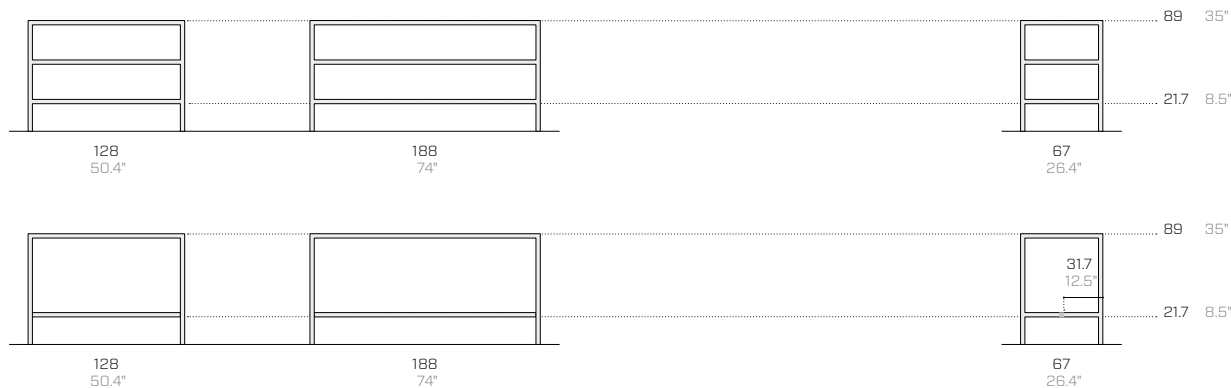

Frame

Tall units

Salvatore Indriolo, 2020

archiproducts
AWARDS
WINNER



Frame tall units come in two widths and two heights. Doors, deep drawers and inside drawers can be arranged freely within them and accessories and appliances can be slotted into them. There are no fewer than 35 different finishes on offer in the breathtaking colour palette, so the products can be customized to suit any setting.

Le colonne Frame sono proposte in due larghezze e in due altezze, permettendo la libera composizione di ante, cassettoni e cassetti interni, oltre all'integrazione di accessori ed elettrodomestici. La sorprendente palette cromatica - composta da 35 finiture - consente di personalizzare il prodotto, adattandolo a ogni ambiente.

Die Säulen Frame werden in zwei Breiten und zwei Höhen angeboten, so dass die beliebige Kombination mit Türen, großen und kleinen Schubladen sowie die mögliche Integration von Zubehör und Geräten möglich sind. Die erstaunliche Farbpalette - bestehend aus 35 Finishes - erlaubt die individuelle Gestaltung des Produkts und die Anpassung an jedes Ambiente.

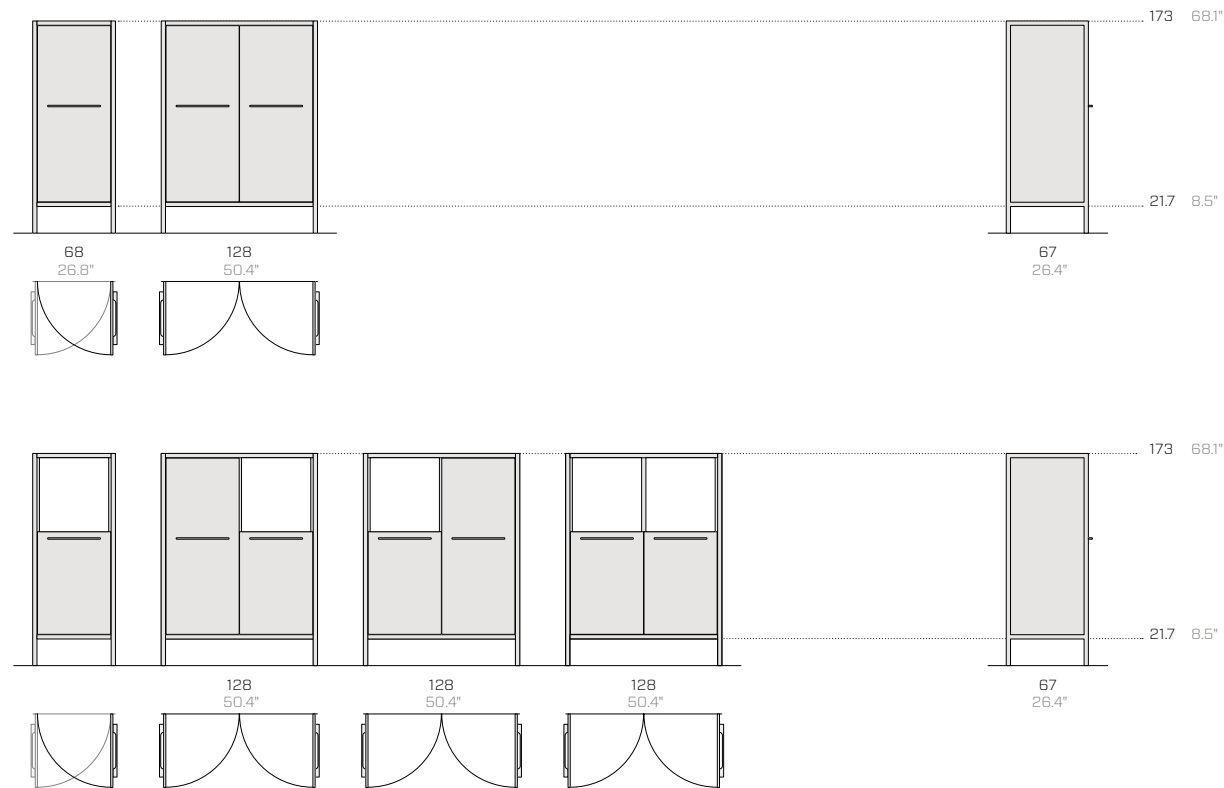





The compact Tall Units reach a height of just 169 cm and they are ideal for bridging the gap with living rooms. One way in which this can be done is with free-standing units. A range of appliances can be slotted into them, including ovens, microwaves, dishwashers, coffee machines and wine coolers.

Le Tall Units compatte sono alte solo 169 cm e si prestano per soluzioni in continuità verso l'area living, anche in modalità free-standing. È possibile integrare elettrodomestici come il forno, il microonde o la lavastoviglie, fino alla macchina per il caffè e alla cantinetta per il vino.

Die kompakten Tall Units sind nur 169 cm hoch und eignen sich – auch freistehend – für kontinuierliche Lösungen zum Wohnbereich. Geräte wie Backöfen, Mikrowellenherde und Geschirrspüler bis hin zu Kaffeemaschine und Weinregal können integriert werden.

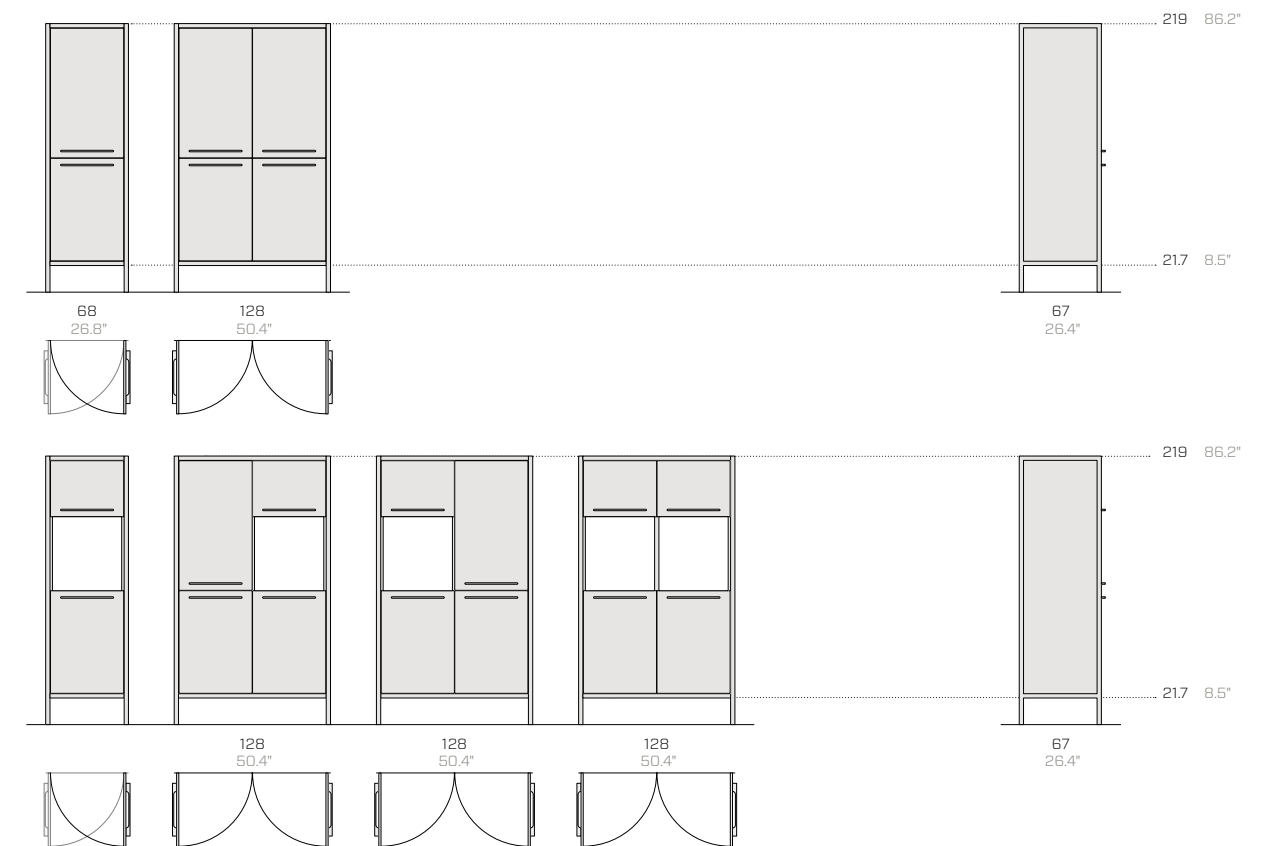

Frame Stools

Salvatore Indriolo, 2022

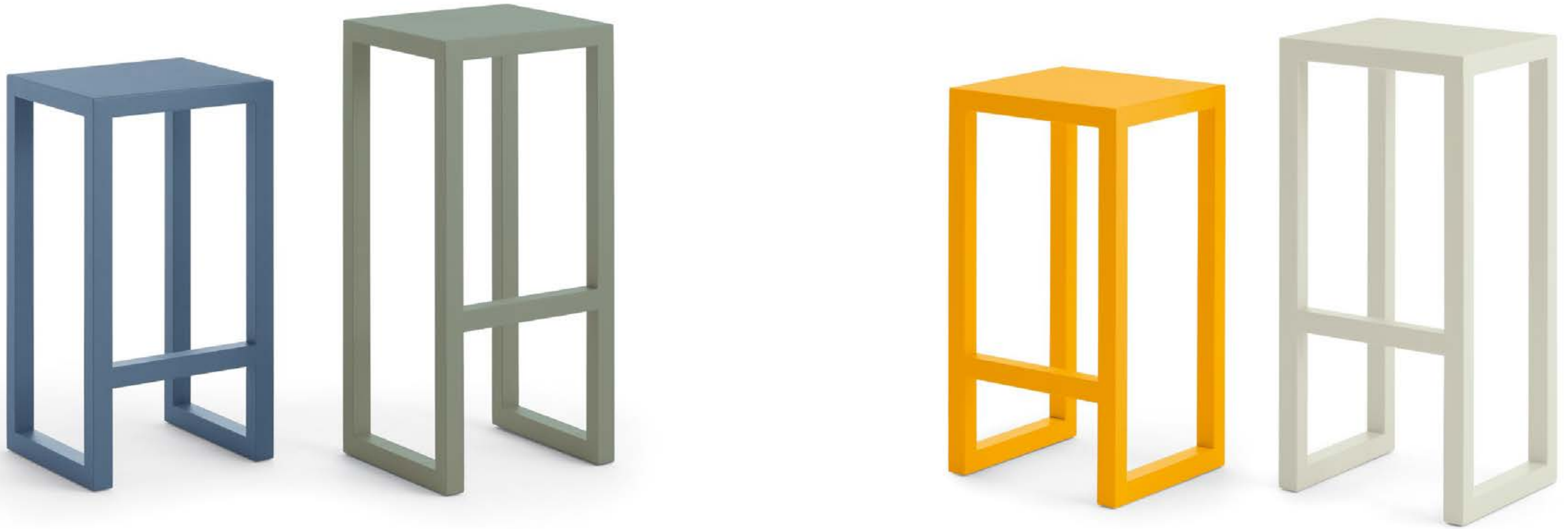

Frame stools have solid, iconic shapes. Ideal for use in conjunction with Frame Workbenches, they come in two heights and are highly versatile thanks to the range of 35 finishes in the broad colour palette, including 15 that are suitable for utilization both indoors and outdoors. They run the gamut from cloud grey for sophisticated, minimal style, to vibrant melon yellow for more eclectic locations.

Gli sgabelli Frame hanno una forma solida e iconica. Abbinabili alle Frame Workbenches, sono disponibili in due altezze e costituiscono un complemento d'arredo trasversale grazie all'ampia palette Fantin, composta da 35 finiture, 15 delle quali adatte anche per l'outdoor: si può spaziare da una soluzione in grigio nuvola per un ambiente elegante e minimale, fino a un energico giallo melone per gli spazi più eclettici.

Die Hocker Frame haben eine solide und ikonische Form. Sie können mit den Workbenches Frame kombiniert werden, sind in zwei Höhen erhältlich und bilden dank der breiten Palette von Fantin mit 35 Oberflächen, darunter 15, die für auch für die Verwendung im Freien geeignet sind, eine transversale Einrichtungsergänzung: vom Wolkengrau für ein elegantes und minimalistisches Ambiente bis hin zu einem dynamischen Melonengelb für eklektische Wohnbereiche.

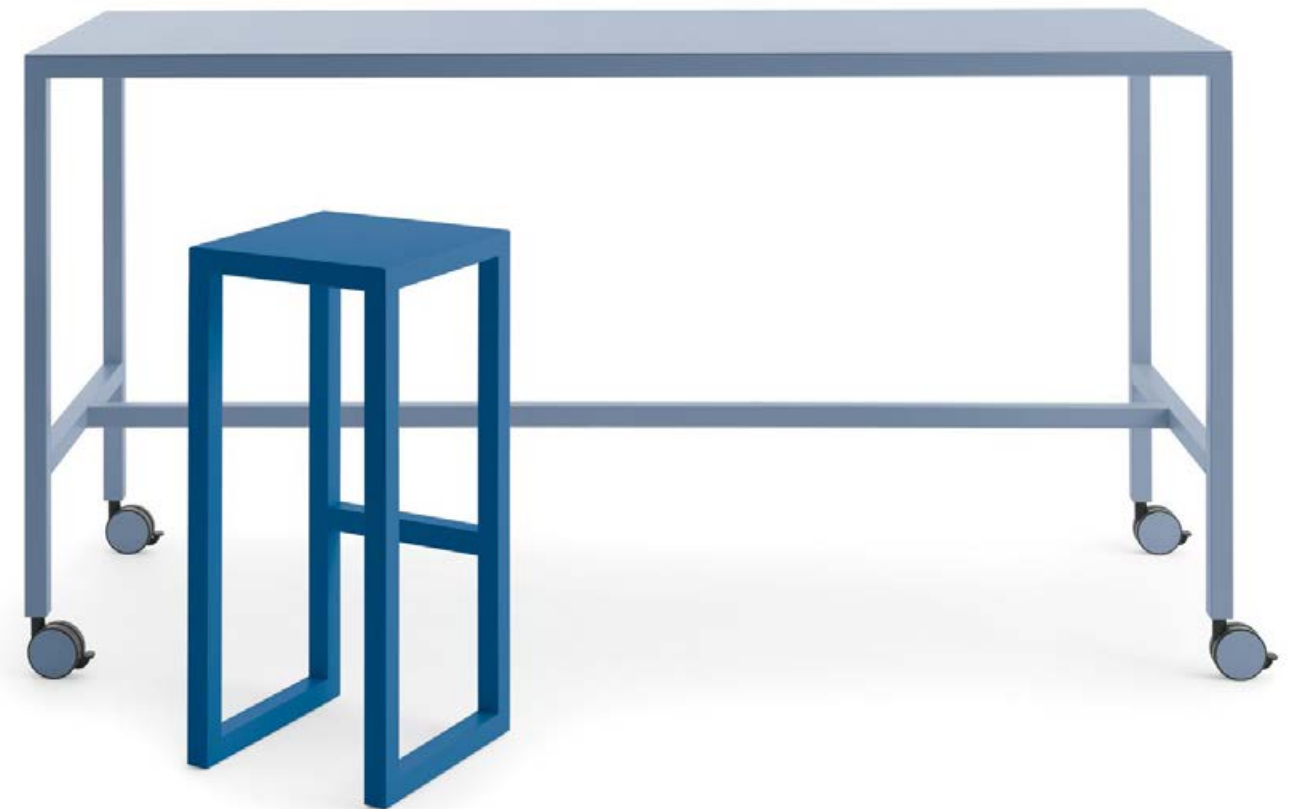
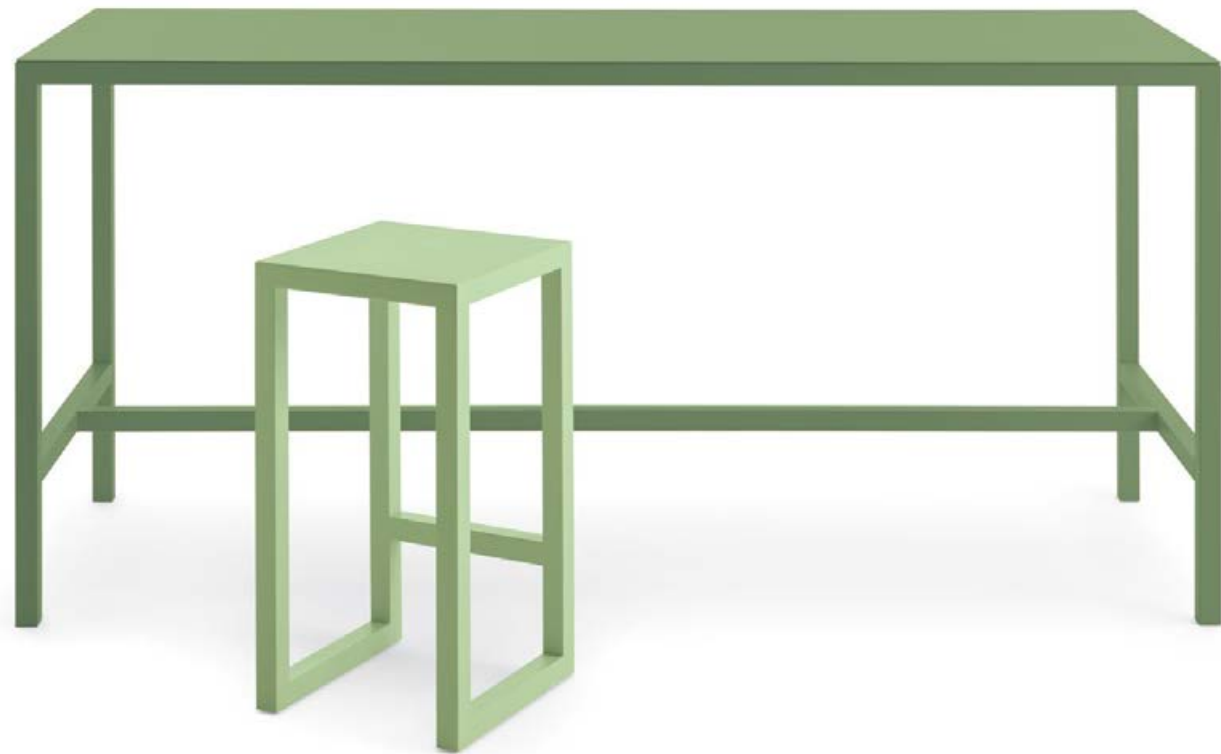
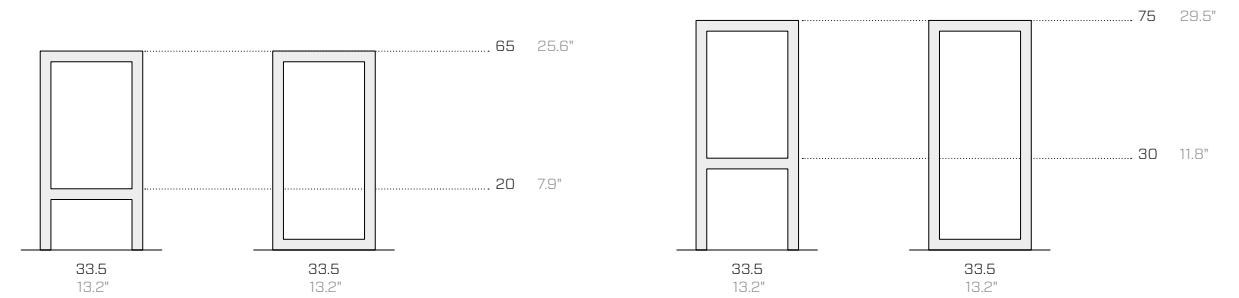



11.21

Melon yellow / Giallo melone / Melonengelb

Embossed / Goffrato / Gaufriert

Frame

Sideboards & cupboards

Salvatore Indriolo, 2018



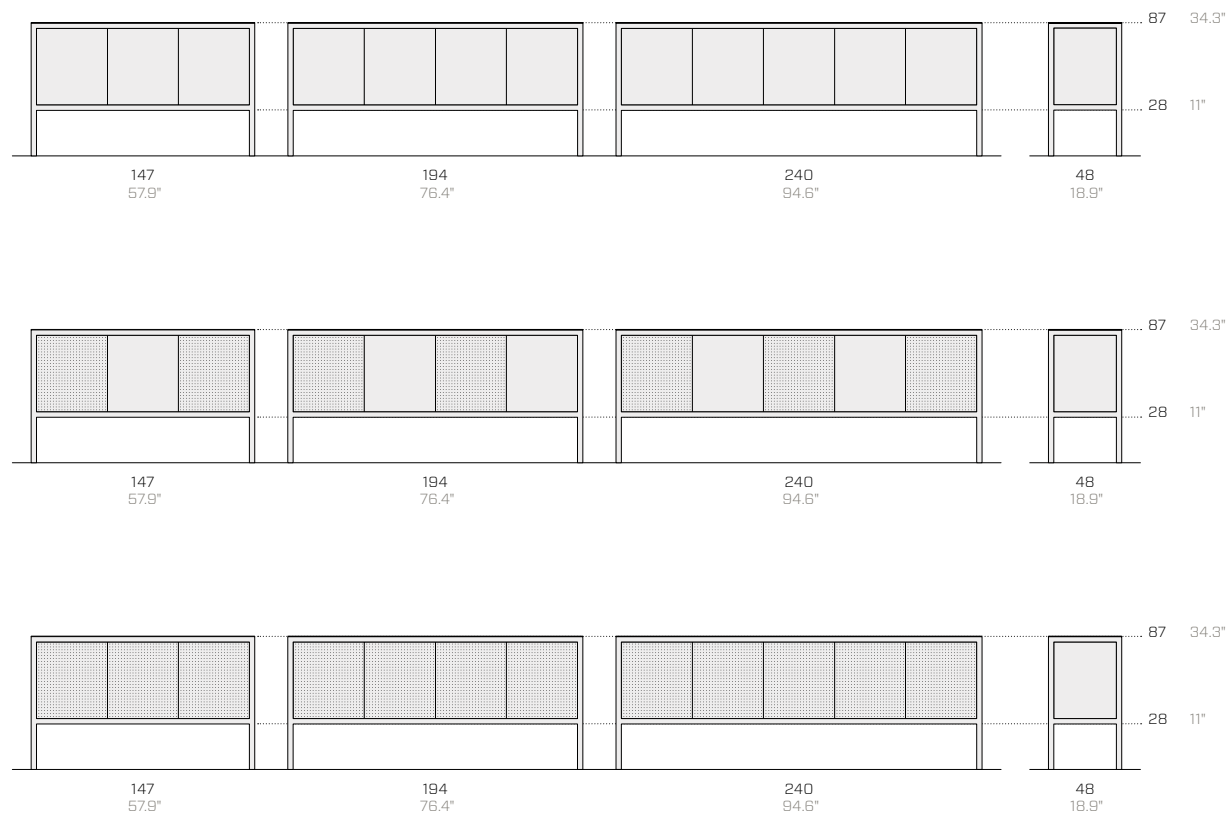

The Frame collection of sideboards and cupboards features a minimal design, with square tube frames that are always visible. The slender tops are just a few millimetres thick and it is made of metal, as are the two different types of doors: solid and perforated. They provide the scope for a range of modular solutions and the variety of compositions – together with the breathtaking selection of 35 Fantin finishes – means that the collection is ideally suited to all settings.

La collezione di madie e credenze Frame è contraddistinta da un design minimale, con il telaio in tubo quadro sempre a vista. Il top, sottile pochi millimetri, è in metallo, così come le due versioni di ante – piena e forata – che permettono diverse composizioni modulari e che rendono la collezione adatta in qualsiasi contesto, grazie anche alla sorprendente scelta fra le 35 finiture Fantin.

Die Kollektion Frame mit Anrichten und Küchenbuffets zeichnet sich durch ein minimalistisches Design mit einem Rahmen aus Vierkantrohrrahmen aus, der immer sichtbar ist. Die wenige Millimeter starke Abdeckplatte ist aus Metall wie auch die beiden Türversionen – blind und perforiert – die unterschiedliche Kompositionen aus den verschiedenen Modulen ermöglichen und die Kollektion zusammen mit der erstaunlichen Auswahl von Fantin – 35 Finishes – für jeden Kontext geeignet machen.







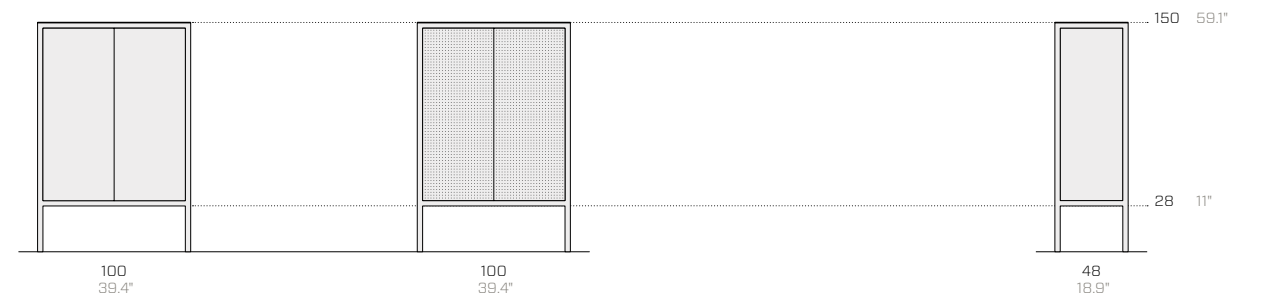



Frame Beds

Salvatore Indriolo, 2022



The beds and bases in the Frame selection have the trademark square tube running around the bottom of the mattress and solid lower sides for secure frame support, with housing inset by 7 cm or 12 cm. The visible frame running around the perimeter also takes in the headboard, which can be made of metal or soft padded fabric. The beds can be complemented by two different accessories: integrated overhanging bedside tables and a back for the headboard, for striking free-standing solutions. The combination of the minimal design and the 35 finishes in the Fantin palette mean that Frame Beds are suitable for use not only at home but also in accommodation facilities.

I letti e i sommier del programma Frame sono contraddistinti dal giroletto, costituito dal caratteristico tubo quadro e da solide sponde inferiori per l'appoggio in sicurezza delle reti, con un incasso di 7 o 12 cm. La testiera è sempre accolta dal telaio perimetrale a vista, ed è in metallo o in morbido tessuto imbottito. Gli accessori che arricchiscono l'offerta sono i comodini integrati a sbalzo e lo schienale per la testiera, per soluzioni freestanding di grande impatto. Le 35 finiture della palette Fantin, applicate al design minimale, rendono i letti Frame adatti sia per la casa che per soluzioni ricettive.

Die Betten und Sommier des Programms Frame sind von einem Gestell gekennzeichnet, das aus dem charakteristischen Vierkantrohr und massiven Unterprofilen für die sichere Auflage der Bettröste mit einer Aussparung von 7 oder 12 cm besteht. Der Kopfteil befindet sich immer innerhalb des sichtbaren, umlaufenden Rahmens und ist aus Metall oder weichem Polster gefertigt. Weiteres Zubehör wie die Nachttische und die Rückenlehne für den Kopfteil ergänzt das Angebot und ermöglicht effektvolle, freistehende Lösungen. Die 35 Oberflächen der Palette von Fantin bieten zusammen mit dem minimalistischen Design geeignete Lösungen für das Heim wie auch für Beherbergungsbetriebe.





61.24 Pale Gold



52.18 Moss



43.21 Bronze



47.21 Platinum + T1.22 Smoke



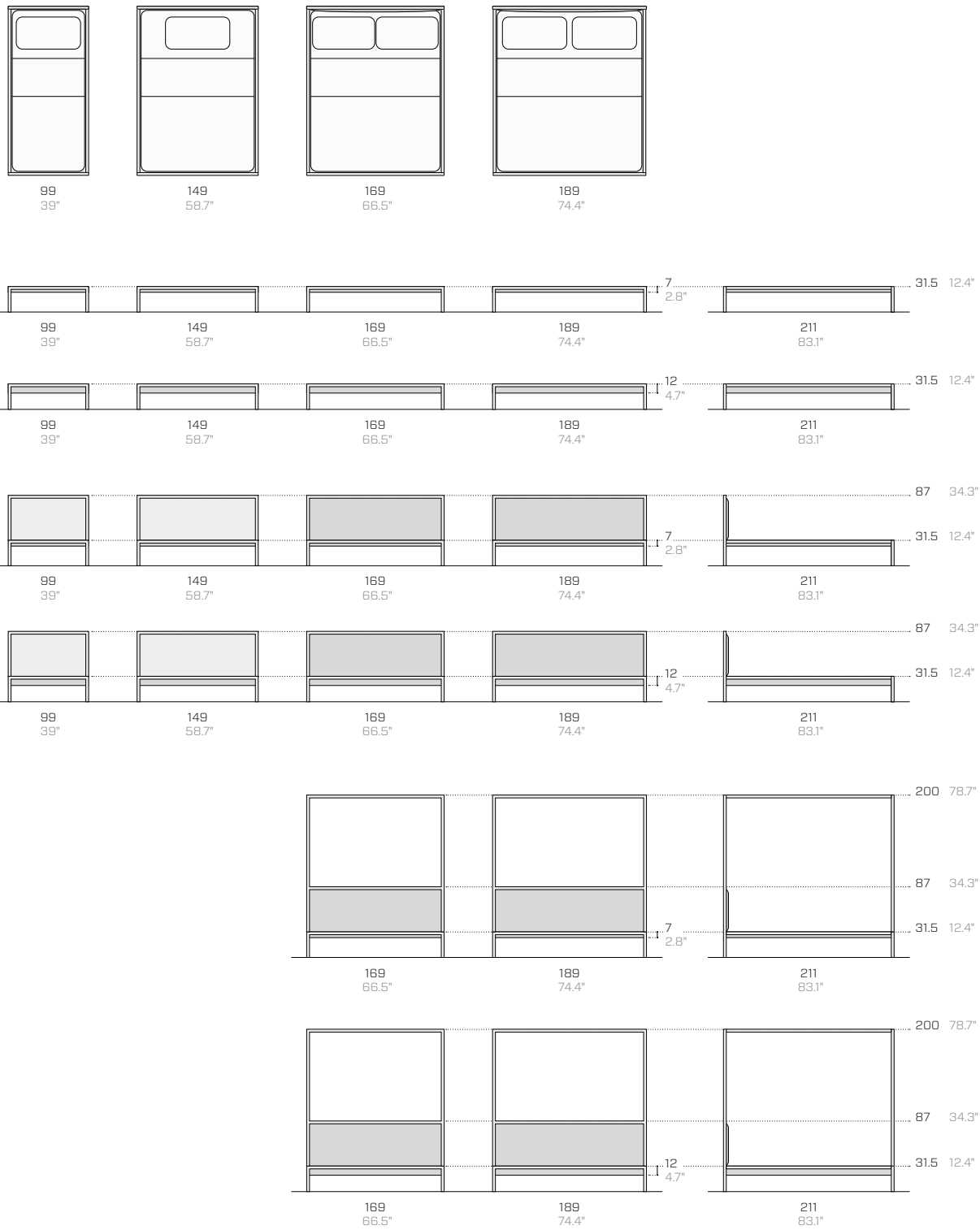



Frame

Tables & desks

Salvatore Indriolo, 2018



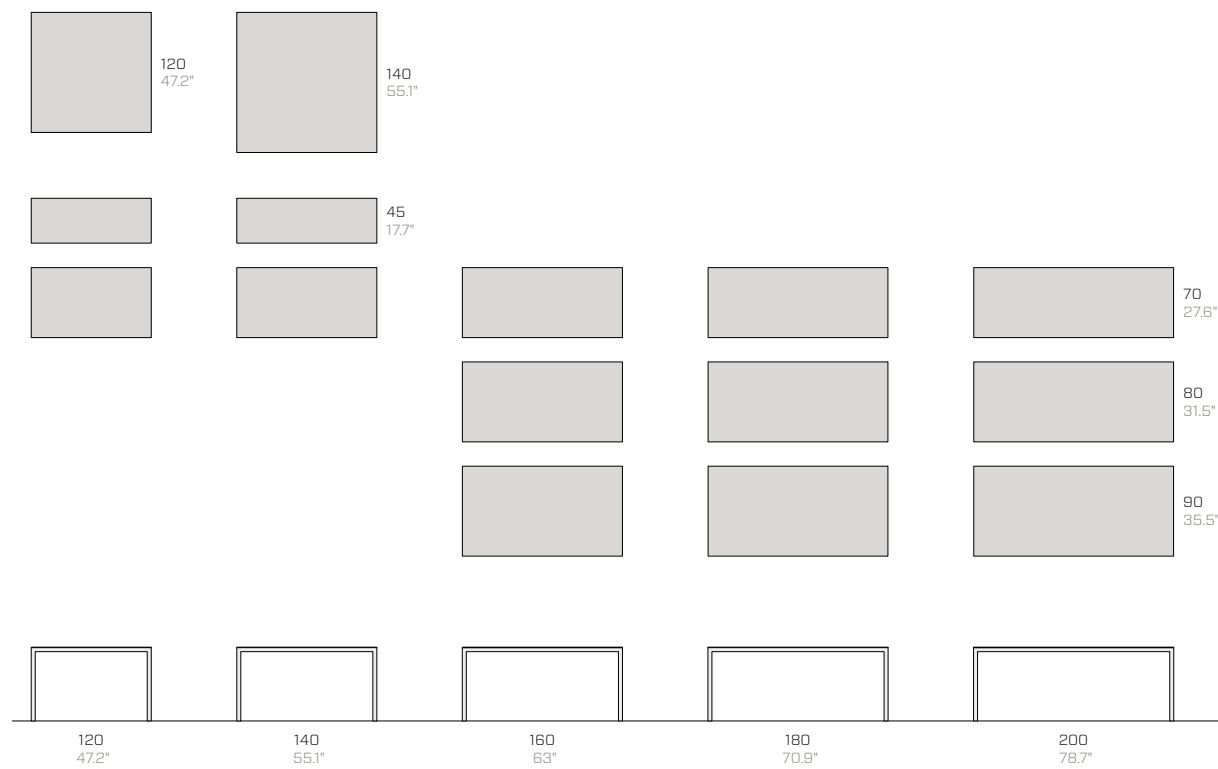

The key distinguishing feature of the minimal design for the Frame tables and desks is the relationship between the solid square tube frames and the extremely slender tops. In addition, the items are made of metal, so all of the Fantin finishes are available and the collection is suitable for use in all settings.

Nel design minimale dei tavoli e degli scrittoi Frame, la vera caratteristica distintiva è il rapporto fra il solido telaio in tubo quadro e il sottilissimo top. L'utilizzo del metallo, inoltre, permette di avere un oggetto monomaterico declinabile in tutte le finiture Fantin, il che rende questa collezione adatta in tutti gli ambienti.

Im Minimaldesign der Tische und Schreibtische Frame ist das wahre Unterscheidungsmerkmal das Verhältnis zwischen dem stabilen Rahmen aus Vierkantrohr und der sehr dünnen Arbeitsplatte. Durch die Verwendung von Metall erhält man zudem einen Gegenstand aus einem einzigen Material, wodurch alle Finishes von Fantin in verschiedenen Ausführungen erhältlich sind und diese Kollektion für alle Umgebungen geeignet macht.







Hug

Tables & stools

Giulio Iacchetti, 2022-23

archiproducts
AWARDS
WINNER
SUSTAINABILITY



Joints play a crucial part in structures of all kinds: although they are not usually conspicuous and sometimes not even visible at all, they give stability and solidity. The design deliberations behind Hug tables revolved around them. The frame literally hugs the legs, clinching them in the curves running around its outline. The joints comprehensively perform their structural role while also giving the tables a highly distinctive look. In addition, its position within easy reach just under the table top means that the frame also serves another purpose by supporting a selection of three accessories that can be moved around and attached freely: a bag hanger, a tray and a pen holder.

In ogni tipo di struttura, le giunzioni rappresentano un elemento cruciale: benché poco visibili o talvolta nascoste, garantiscono stabilità e solidità. Su di esse si è focalizzata la riflessione progettuale per i tavoli Hug. Il telaio abbraccia letteralmente le gambe, che si trovano così innestate nelle sue curve perimetrali. Le giunzioni assolvono pienamente al ruolo strutturale, conferendo al tavolo una forte connotazione estetica. Inoltre, grazie alla sua posizione "a portata di mano" appena sotto al piano, il telaio risponde a un'ulteriore funzione, offrendosi come sostegno per una serie di tre accessori – un gancio portaborse, un vassoio e un contenitore portapenne – da agganciare e spostare liberamente.

Bei jeder Struktur sind die Verbindungen entscheidende Elemente: Sie sind zwar kaum sichtbar oder manchmal verborgen, aber sorgen für Stabilität und Solidität. Diese Überlegungen stehen hinter dem Design der Tische Hug: Der Rahmen umschließt die Beine, die in den abgerundeten Ecken des umlaufenden Rahmens stecken, wie in einer Ummarmung. Die Verbindungen erfüllen ihre strukturelle Aufgabe und verleihen dem Tisch eine starke ästhetische Wirkung. Außerdem dient der Rahmen dank seiner „handlichen“ Position direkt unter der Tischplatte einer zusätzlichen Funktion als Träger von drei Zubehörteilen – Taschenhaken, Tablett und Stifthalter – die eingehängt und beliebig verschoben werden können.





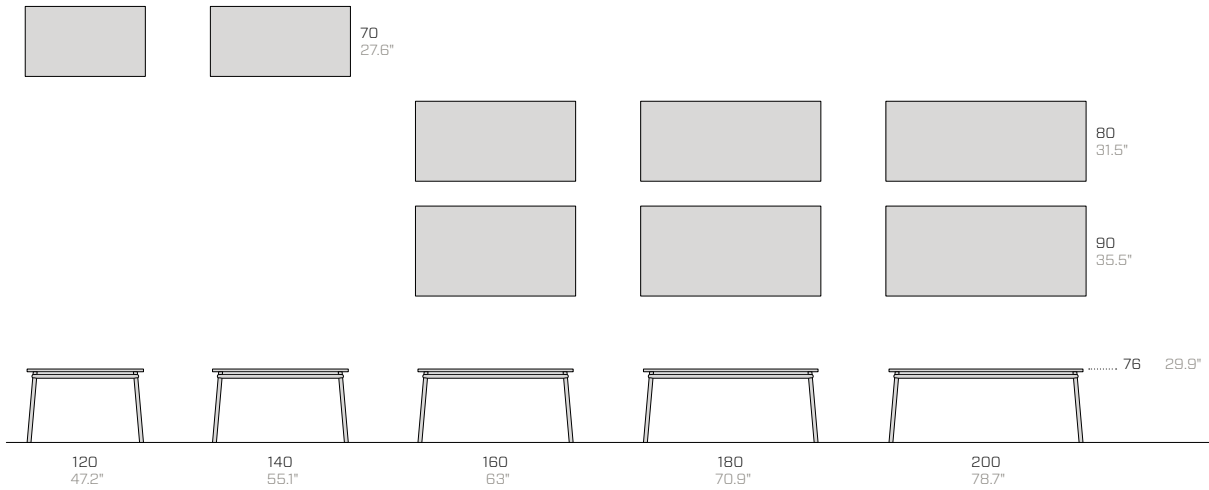
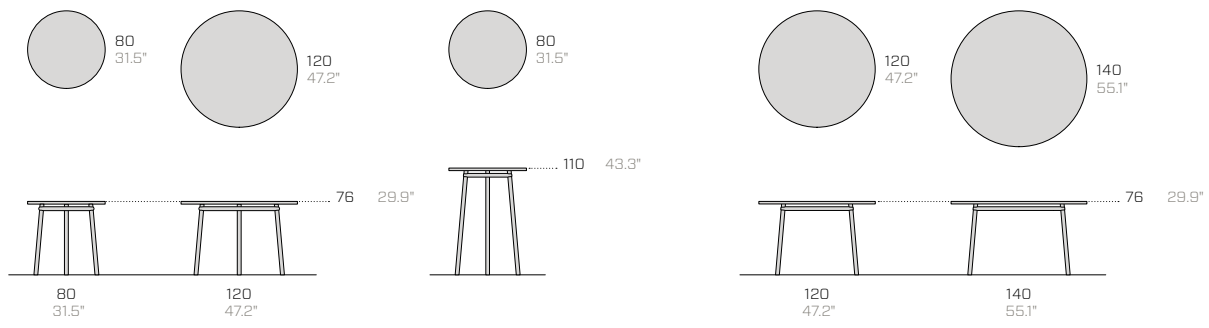



Hug stools extend Giulio lacchetti's collection for Fantin. With a 35 cm circular seat and three heights – 42, 65 and 75 cm – they provide both comfort and style. The distinctive junction between legs and frame forms three symbolic “hugs” ensuring structural stability and a unique aesthetic. Customizable in 35 non-toxic colors, Hug stools are a versatile solution, perfect for residential and contract environments.

Gli sgabelli Hug ampliano la collezione di Giulio lacchetti per Fantin. Con seduta circolare di 35 cm e tre altezze – 42, 65 e 75 cm – offrono comfort e stile. La particolare giunzione tra le gambe e telaio sono tre simbolici “abbracci”, che conferiscono stabilità strutturale e un'estetica unica. Personalizzabili in 35 colori atossici, gli sgabelli Hug sono una soluzione versatile, perfetta per ambienti residenziali e contract.

Die Hug-Hocker erweitern die Kollektion von Giulio lacchetti für Fantin. Mit einer runden Sitzfläche von 35 cm und drei Höhen – 42, 65 und 75 cm – bieten sie Komfort und Stil. Die besondere Verbindung zwischen Beinen und Rahmen bildet drei symbolische “Umarmungen”, die strukturelle Stabilität und eine einzigartige Ästhetik verleihen. Anpassbar in 35 ungiftigen Farben sind die Hug-Hocker eine vielseitige Lösung, ideal für Wohn- und Vertragsumgebungen.

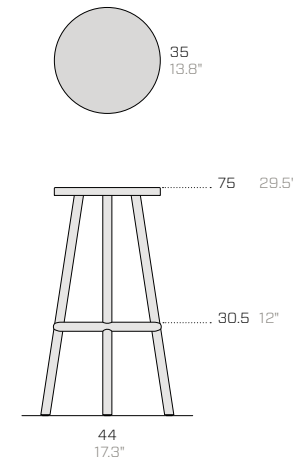
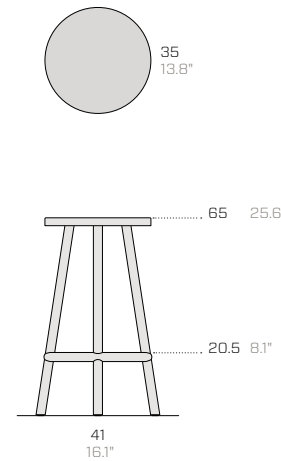
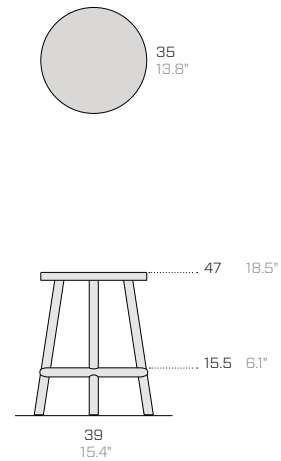

Hug Hangers

Giulio Iacchetti, 2024



Single hanger / Appendiabiti singolo / Einzel-Kleiderbügel

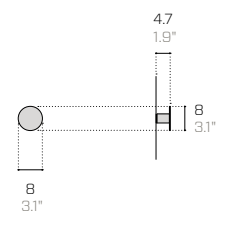

Hatbox / Cappelliera / Hutschachtel

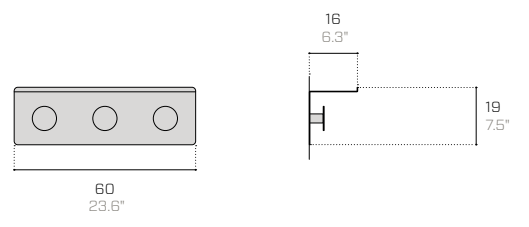

Floor coat hanger / Appendiabiti da terra

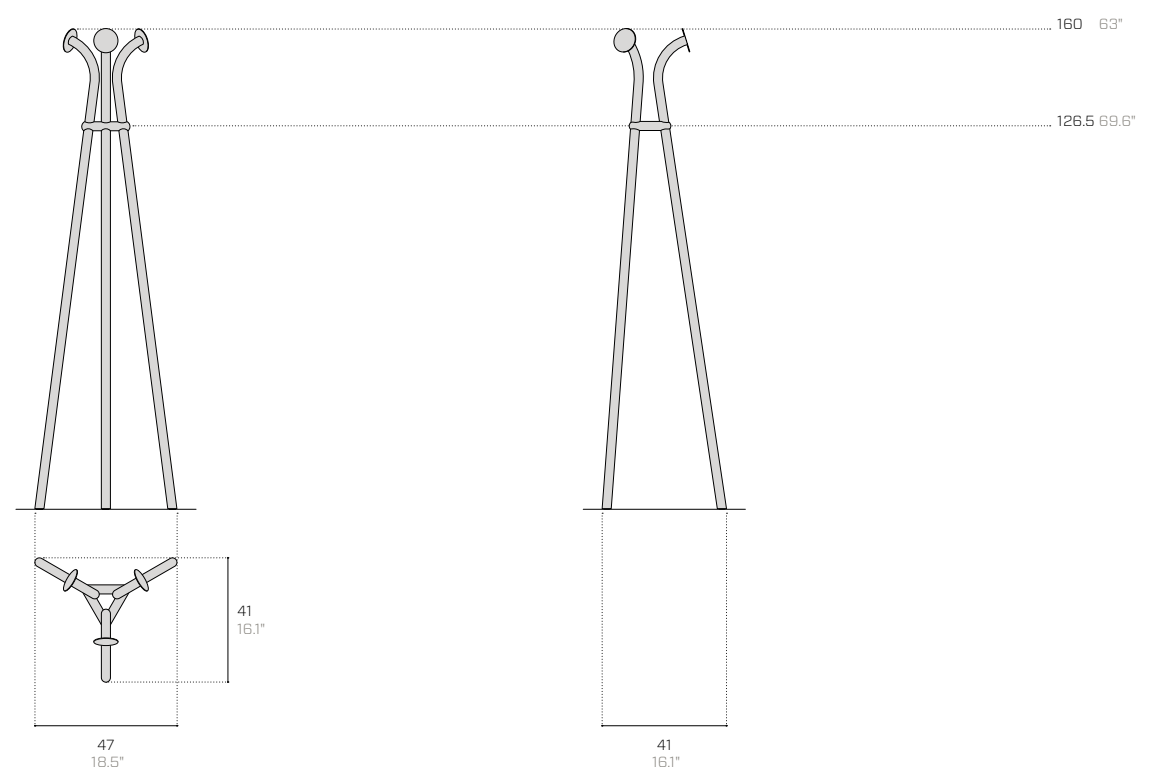

Wave

Desks & add-ons

ruga.perisinotto, 2024



Wave is a collection of accessories that uses the curve as a decorative and functional element of the object.

The volumes, almost two-dimensional, are made by bending sheets of metal, employing a characteristic production method always present in Fantin.

The collection consists of a desk, shelves, and bookends.

Wave è una collezione di complementi che utilizza la curva come elemento decorativo e identificativo della funzionalità dell'oggetto.

I volumi, quasi bidimensionali, sono realizzati piegando fogli di metallo, impiegando una caratteristica produttiva da sempre presente in Fantin.

La collezione si compone di uno scrittoio, mensole e reggilibri.

Wave ist eine Kollektion von Accessoires, die die Kurve als dekoratives und funktionales Element des Objekts nutzt.

Die Volumina, fast zweidimensional, werden durch Biegen von Metallblechen hergestellt und verwenden dabei eine charakteristische Produktionsmethode, die bei Fantin schon immer vorhanden war.

Die Kollektion besteht aus einem Schreibtisch, Regalen und Buchstützen.

Desks / Scrittoi / Schreibtischen

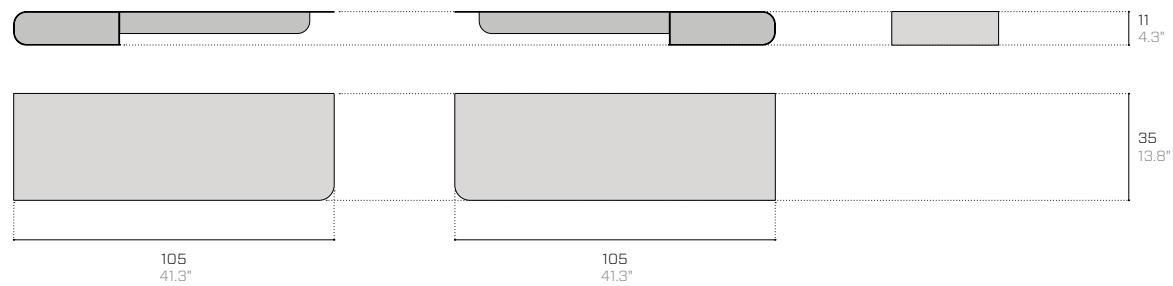

Desks with drawer / Scrittoi con cassetto / Schreibtischen mit Schublade

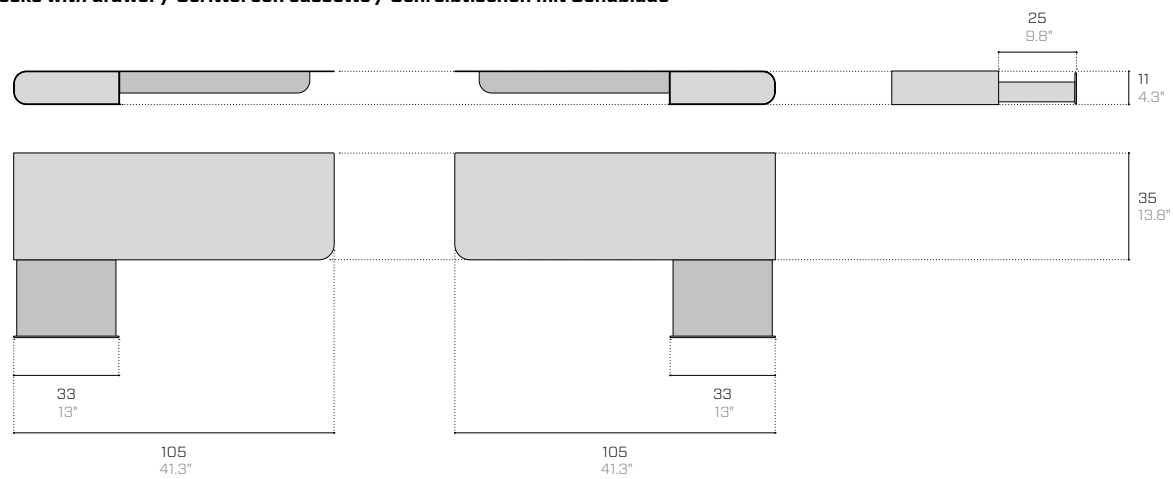

Shelves with side / Mensole con sponda / Regale mit Seiten

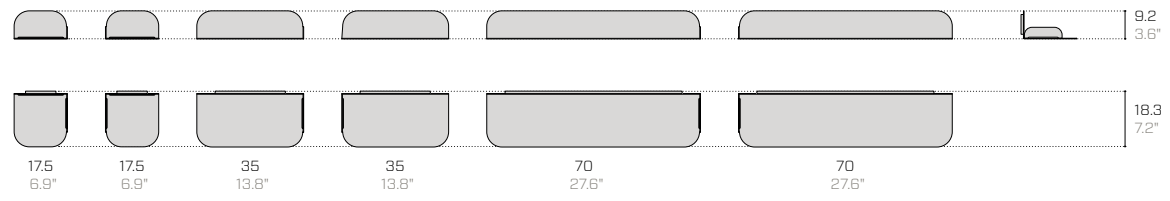

Bookend / Reggilibri / Einzel-Kleiderbügel

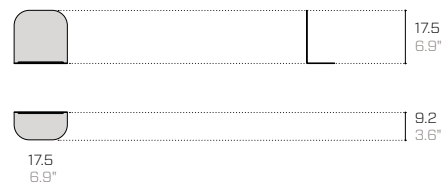

Bookend with side / Reggilibri con sponda / Buchstützen mit Seite



Wave bookend / Reggilibri a onda / Wellenbuchstützen



Still

Sandro Fantin, 2014



The design of the Still table emphasizes its great solidity, which is its main feature. It has pure, simple lines and the structure supporting the top is made of square tubes. It is made from metal, so it has been possible to produce a monomaterial object that is available with all of the colour options for the Fantin collection.

Il design del tavolo Still richiama la sua più importante caratteristica: una grande solidità. Caratterizzato da linee semplici e rigorose, è composto da una struttura in tubolare quadrato che sostiene il top. L'utilizzo del metallo permette di avere un oggetto monomaterico, in tutte le declinazioni cromatiche della collezione Fantin.

Das Design des Tisches Still wird durch seine wichtigste Eigenschaft gekennzeichnet: die große Festigkeit. Gezeichnet durch einfache und rigorose Linien besteht er aus einer Metallvierantrohr-Struktur, die die Tischplatte stützt. Die Verwendung des Metalls kreiert ein Monomaterial-Objekt, das in allen Farbtönen der Fantin-Kollektion erhältlich ist.



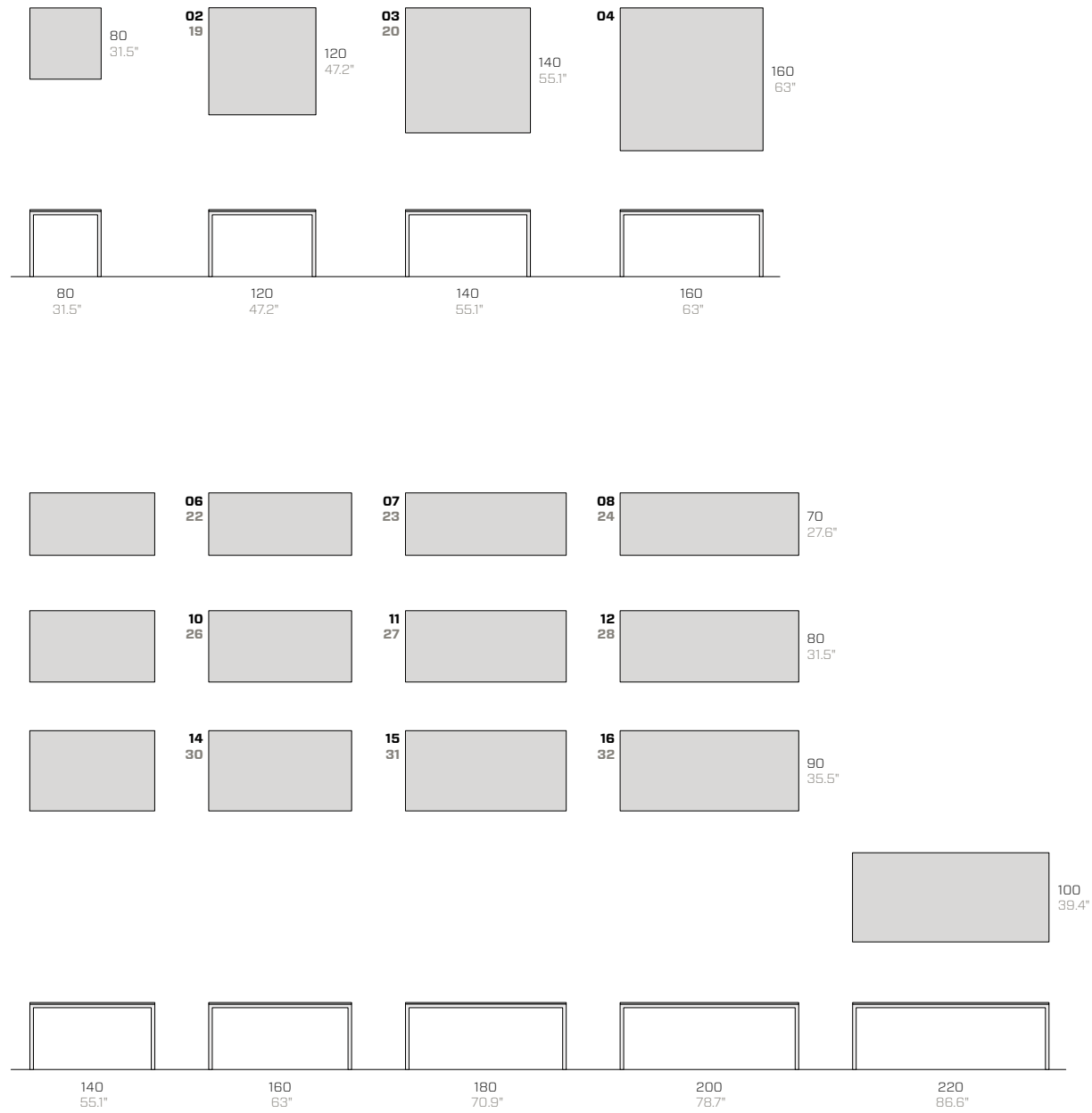





JUST QUACK.

Uno

Dorino Fantin, 1973



Solid modularity: Uno is a versatile and potentially infinite system. The click-fastening assembly system means extended shelving systems can be put up in no time, safely and without the use of screws or bolts. The reinforced shelves are built to withstand heavy loads and, when placed side-by-side, they guarantee convenient continuity. A host of accessories and a broad range of colours mean that Uno can be used in any setting and, when you move, the system can be taken down and adapted to the new environment, even in different configurations. It is also available with LED lighting.

Solida modularità: Uno è un sistema versatile e potenzialmente infinito. Il sistema di assemblaggio a ganci permette di montare scaffalature molto estese in poco tempo, in sicurezza e senza l'utilizzo di viti o bulloni. I piani rinforzati permettono carichi pesanti e, se affiancati, garantiscono una comoda continuità. Tanti accessori e un'ampia gamma colori permettono di utilizzare Uno in qualsiasi ambiente e, in caso di trasloco, il sistema si può smontare e riadattare al nuovo ambiente anche in configurazioni differenti. È disponibile anche con illuminazione a LED.

Solider modularer Aufbau: Uno ist ein vielseitiges und theoretisch unendlich erweiterbares System. Das Montagesystem mit Haken ermöglicht den Aufbau sehr großer Regalwände in kürzester Zeit, und das in vollkommener Sicherheit und ohne Zuhilfenahme von Schrauben und Bolzen. Die verstärkten Böden eignen sich für schwere Lasten und bieten eine praktische durchgehende Ablagefläche bei Montage nebeneinander. Dank zahlreicher Zubehörteile und einer breiten Farbpalette fügt sich Uno in jede Umgebung ein. Im Falle eines Umzugs kann das System einfach auseinander gebaut und an die neue Umgebung gegebenenfalls auch in unterschiedlicher Zusammenstellung angepasst werden. Es ist auch mit LED-Beleuchtung geben.

Uprights / Montanti / Pfosten

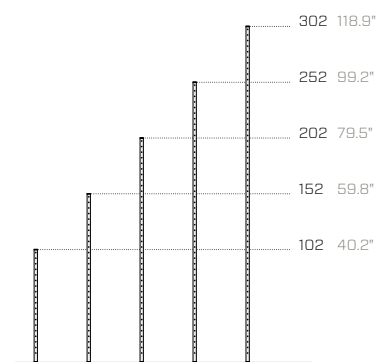

Slot pitch / Passo fori / Bohrungsabstand = 5 cm / 1.9"

Shelves / Ripiani / Regalböden











Uno living

Dorino e Sandro Fantin, 2017



This modular bookcase is made entirely of metal. Fantin's long-standing fastener-based shelving system has been complemented by the addition of overhanging shelves, allowing all settings to be furnished optimally, with boundless versatility.

Libreria componibile, interamente in metallo. Lo storico sistema di ripiani a ganci Fantin è arricchito dall'inserimento dei ripiani a sbalzo, che permettono di arredare al meglio e con una versatilità senza limiti.

Modulares Bücherregal, komplett aus Metall. Das bewährte Regalsystem von Fantin mit Haken wird durch den Einbau von Kragarmregalen ergänzt, die eine optimale Raumgestaltung mit unbegrenzten Möglichkeiten erlauben.

Uprights / Montanti / Pfosten

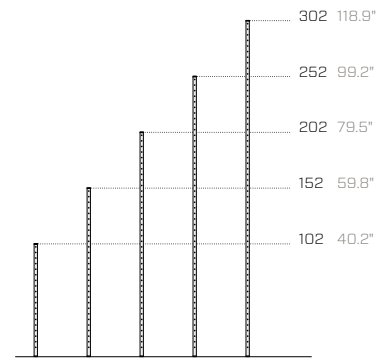

Slot pitch / Passo fori / Bohrungsabstand = 5 cm / 1.9"

Standard shelves / Ripiani standard / Standard-Regalböden

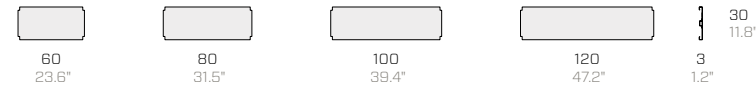

Overhanging shelves / Ripiani a sbalzo / Auskragende Regalböden

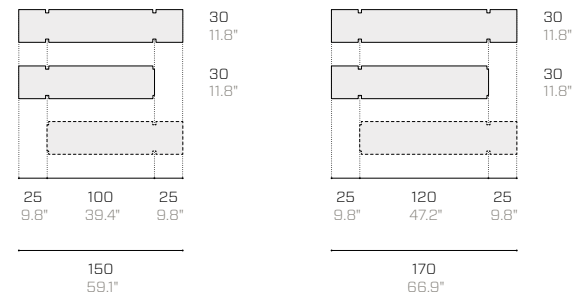

550
216.5"



370
145.7"



Ali

Salvatore Indriolo, 2016





The drawer units and cabinets in the Ali Collection have distinctive handle grips which not only serve a simple practical purpose but also add aesthetic appeal. The design concept is based on the idea of a series of drawers and doors that are punctuated by the nuances of lights and shadows. The numerous size options mean that the Ali Collection is suitable for all settings.

Ali Collection è composta da cassettiere e credenze caratterizzate dalla particolare presa maniglia che, da semplice elemento funzionale, si evolve a elemento estetico. Il susseguirsi dei cassetti o delle ante, cadenzato da sfumature di luci ed ombre, è il punto di arrivo del pensiero progettuale. Le numerose varianti dimensionali rendono Ali Collection adatta a tutti gli ambienti.

Ali Collection besteht aus Schubladenschränken und Anrichten, die sich durch den besonderen Handgriff kennzeichnen, der sich vom einfachen funktionellen Element in ein ästhetisches Element verwandelt. Die Aufeinanderfolge der Schubladen oder der Türen mit der gleichmäßigen Nuancierung von Licht und Schatten, ist der Höhepunkt des kreativen Denkens. Aufgrund der zahlreichen unterschiedlichen Größen ist Ali Collection für alle Räumlichkeiten geeignet.

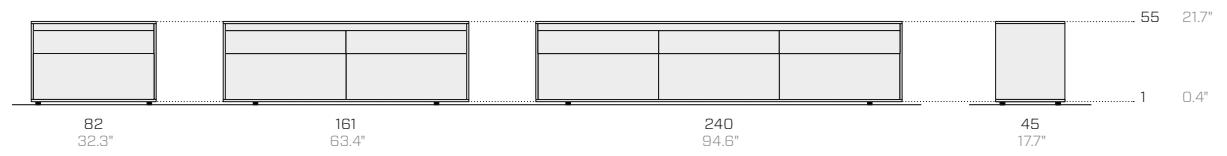
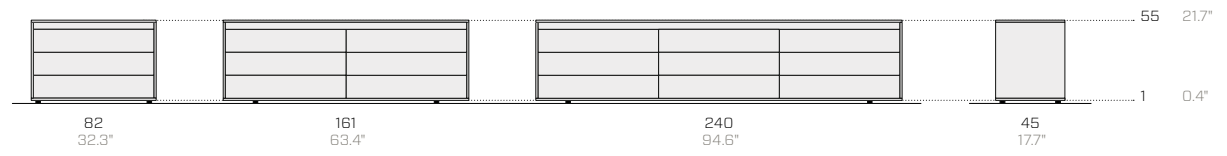



Just

Salvatore Indriolo, 2016



Just takes the classic locker concept to the next level with its contemporary design that is marvelously complemented by every colour in the Fantin range. Great attention to detail is apparent not only in Just's aesthetic appeal but also in its practical solutions. For example, a large number of shelves can be used and freely positioned and the doors can be opened on either the right or the left. The lockers are durable, discreet and suitable for all public and private purposes.

Just è l'evoluzione del classico armadietto, perché arricchito da un design contemporaneo che si esalta con ogni colore della gamma Fantin. Oltre la cura del dettaglio estetico, Just presenta diverse soluzioni pratiche, come la possibilità di avere tanti ripiani posizionabili liberamente e di aprire le porte sia da destra che da sinistra. Solido e discreto, è adatto a tutte le esigenze sia nel pubblico che nel privato.

Just ist die Evolution des klassischen Spindes, weil er mit einem zeitgenössischen Design bereichert ist, das von jeder Farbe der Farbpalette Fantin hervorgehoben wird. Außer der Sorgfalt für das ästhetische Detail, weist Just verschiedene praktische Lösungen auf, wie die Möglichkeit, dass Sie über zahlreiche frei positionierbare Einlegeböden verfügen können und außerdem die Möglichkeit besitzen, die Türen sowohl von rechts als auch von links zu öffnen. Solide und diskret ist dieses Produkt geeignet für alle Bedürfnisse sowohl im öffentlichen als auch im privaten Bereich.



Just One Push Pull

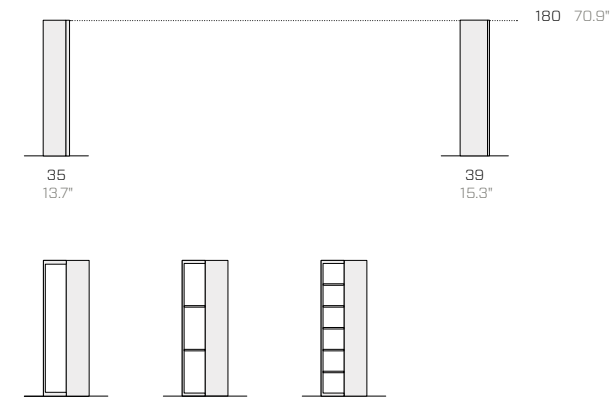

Just One Key

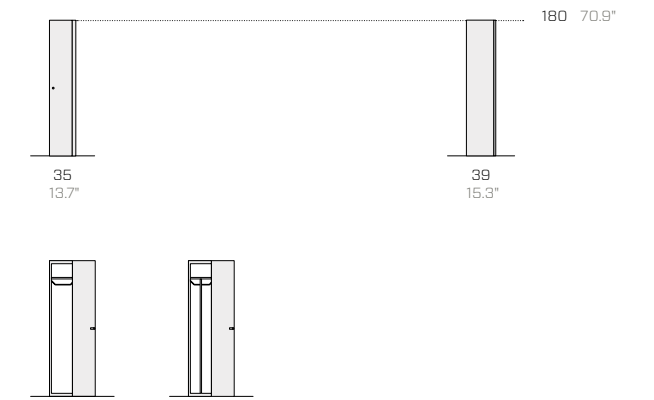

Just Two

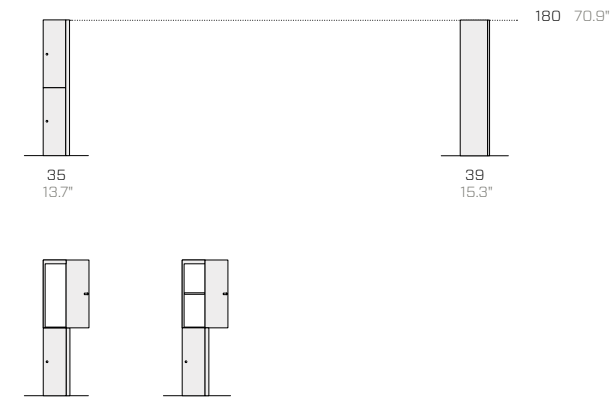

Just Four

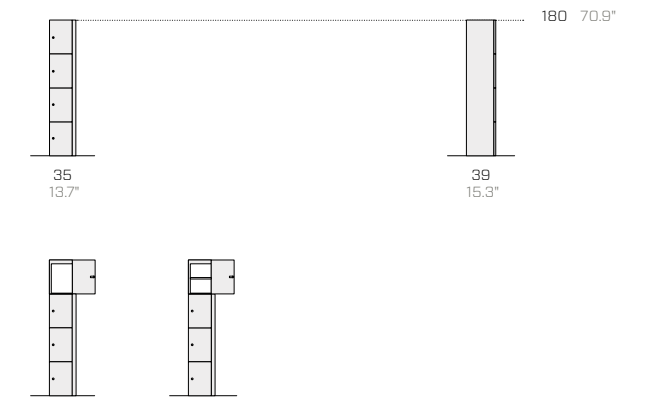



Cambio

Dorino Fantin, 1980



Cambio changing room lockers provide a rational solution for the safekeeping of personal items in communal and operational areas. Practical and sturdy, they come in endless combinations thanks to the ample colour customisation opportunities and to the variety of models with varying storage capacities.

Gli armadi spogliatoio e casellari Cambio risolvono razionalmente la custodia degli oggetti personali negli spazi collettivi ed operativi. Pratici e robusti, hanno combinazioni infinite grazie all'ampia personalizzazione dei colori e alla varietà dei modelli dalle differenti capacità di contenimento.

Die Umkleide- und Fächerschränke Cambio lösen die Aufbewahrung persönlicher Gegenstände in Gemeinschafts- und Betriebsräumen sinnvoll. Diese praktischen und robusten Schränke lassen sich dank der umfassenden Farbauswahl und der Vielzahl an Modellen mit unterschiedlichem Stauraum in unzähligen Kombinationen zusammenstellen.





Standard

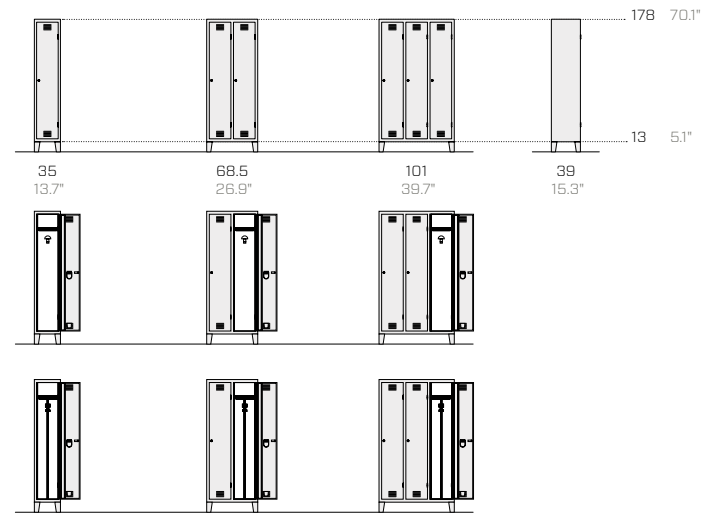

Plus

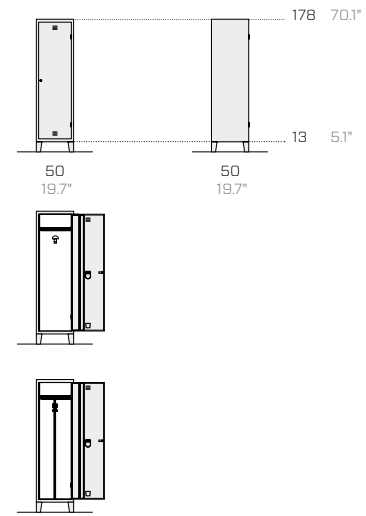

Palestra

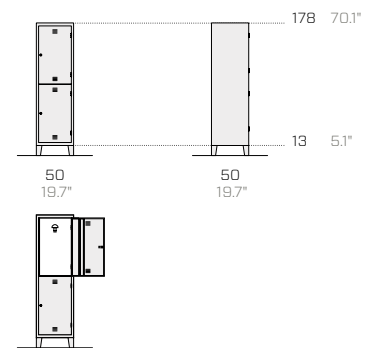
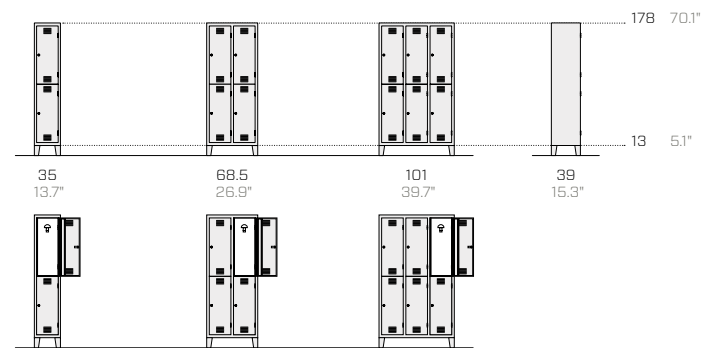

Casellario

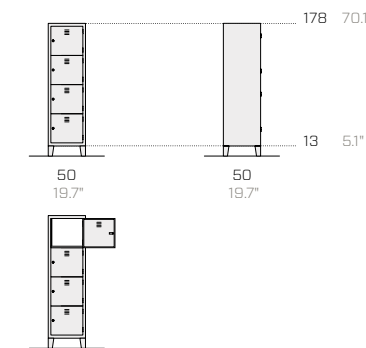
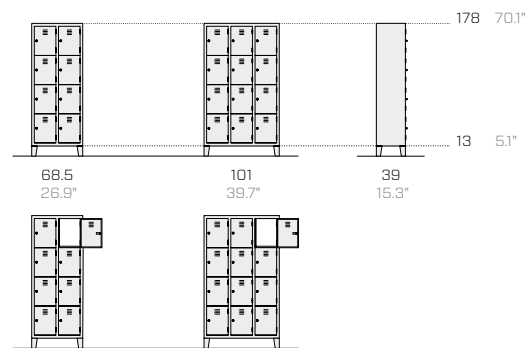



© Ottavio Tommasini



10 BUONI MOTIVI PER SCEGLIERE RAFFLES MILANO ISTITUTO MODA E DESIGN

1. UN AMBIENTE INTERNAZIONALMENTE
2. UNA FACILE DI ANALISI
3. UNO DEI MIGLIORI
4. UNO DEI MIGLIORI
5. UNO DEI MIGLIORI
6. UNO DEI MIGLIORI
7. UNO DEI MIGLIORI
8. UNO DEI MIGLIORI
9. UNO DEI MIGLIORI
10. UNO DEI MIGLIORI

RafflesMilano

Run

Dorino e Ferruccio Fantin, 1987



Run trolleys were created more than 30 years ago for work on the go. Thanks to their solid metal frames, they can carry loads of all kinds. Swivel castors make them easy to move around in complete safety. There is a choice between standard wheels with an industrial look and others featuring metal rims that are the same colour as the framework, which are better suited to household environments.

I carrelli Run sono stati creati oltre trent'anni fa per le lavorazioni in movimento. Grazie alla solida struttura in metallo, permettono infatti il trasporto di qualsiasi carico. La facilità di spostamento in totale sicurezza è garantita dalle ruote piroettanti, che sono disponibili in versione standard, dall'estetica industriale, oppure con disco in metallo in tinta con il telaio, per una maggiore adattabilità agli ambienti domestici.

Die Rollwagen Run wurden vor mehr als dreißig Jahren für die Arbeitsgänge entworfen, die eine Materialbewegung erforderten. Dank der soliden Metallstruktur erlauben sie die Beförderung jeglicher Fracht. Die Leichtigkeit und Sicherheit der Handhabung wird von den drehbar gelagerten Rollen garantiert, die in der Standardausführung mit industriellem Erscheinungsbild sowie mit Metallreifen in der Farbe des Rahmens erhältlich sind, also besser ins häusliche Ambiente passen.

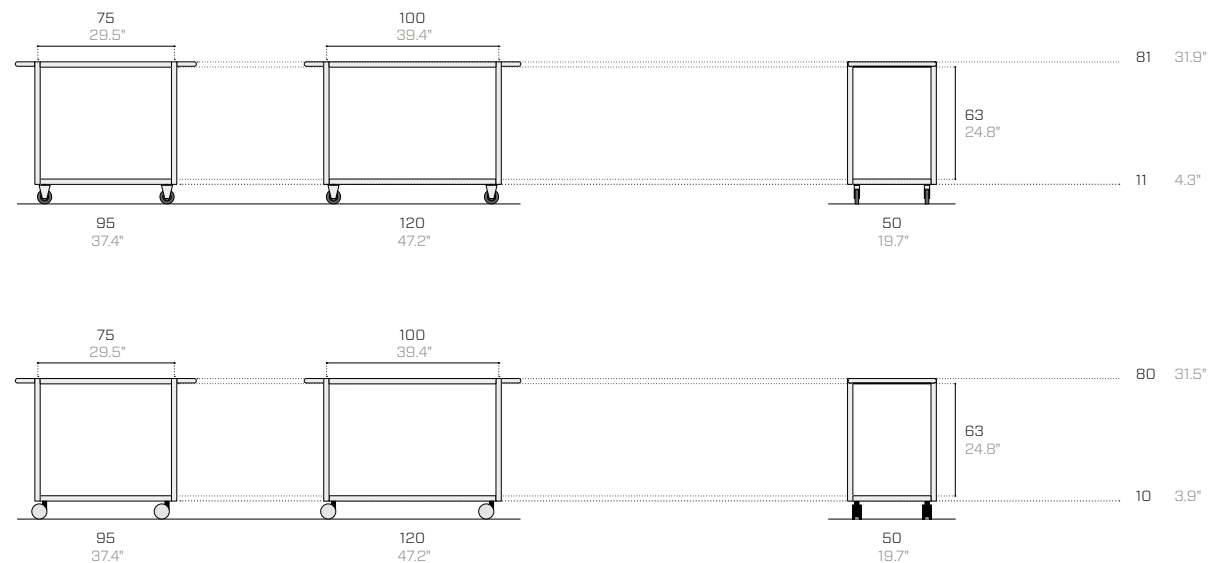

Mya

Sandro Fantin, 2019

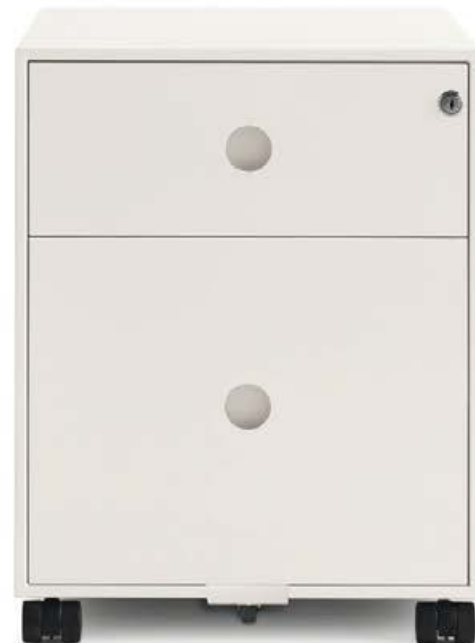

Mya is a drawer unit on castors that slides silently, thanks to the top-quality materials and to the use of the best ball bearing runners. Designed to minimise the external dimensions – while providing the same drawer storage capacity – it has distinctive, practical inset handles with a diameter of 4 cm.

Mya è una cassettera scorrevole e silenziosa, grazie alla qualità dei materiali e all'utilizzo delle migliori guide a sfere. Progettata per ridurre al minimo le dimensioni esterne – a parità di capacità di contenimento dei cassetti – si caratterizza per la pratica maniglia ad incasso dal diametro di 4 cm.

Der Schubladenschrank Mya ist dank der hochwertigen Materialien und erstklassigen Kugellager, die verwendet werden, rollbar und leise. Das Design von Mya bietet bei möglichst geringem Platzbedarf das gleiche Fassungsvermögen der Schubladen – und ist mit einem praktischen Muldengriff (Durchmesser 4 cm) ausgestattet.

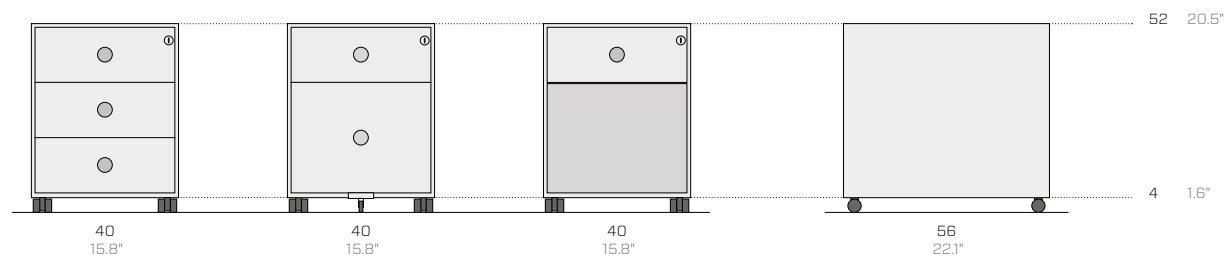

Classic

Dorino e Ferruccio Fantin, 1980-2020



The Classic collection is a timeless success, thanks to its sturdiness and well-proportioned shapes. It is available in a variety of sizes, with hinged or sliding doors, and it is suitable both for office archiving as well as for use as alternative storage for shops and the home. As in all the products in its collections, Fantin guarantees ease of assembly and ample colour customisation possibilities.

Classic è una collezione dal successo intramontabile, grazie alla robustezza e alle proporzioni delle forme. Disponibile in diverse misure, con ante battenti o scorrevoli, è adatto sia all'archiviazione in ufficio che ad altre soluzioni per i negozi e la casa. Come in tutti i prodotti delle sue collezioni, Fantin garantisce la facilità di montaggio e un'ampia personalizzazione dei colori.

Die Kollektion Classic ist aufgrund ihrer Robustheit und der Proportionen der Formen von zeitlosem Erfolg. Die in verschiedenen Größen mit Flügel- oder Schiebetüren erhältlichen Schränke sind für die Archivierung im Büro, aber auch andere Einsatzmöglichkeiten in Geschäften oder zu Hause geeignet. Wie für alle Produkte seiner Kollektionen gewährleistet Fantin eine unkomplizierte Montage und eine individuelle Farbgestaltung durch eine breite Farbauswahl.





Cabinets with hinged doors / Armadi con ante a battente / Schränke mit Drehtüren

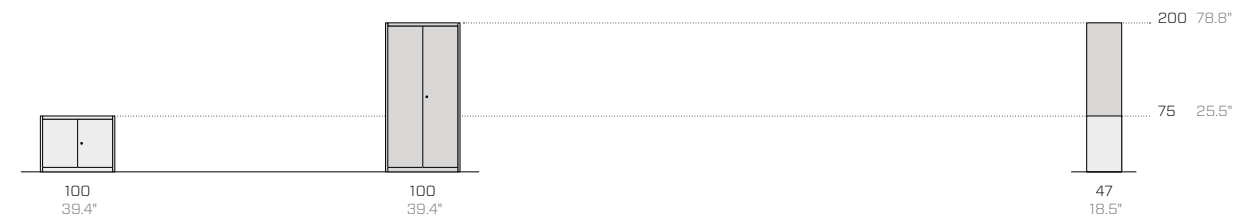

Cabinets with sliding doors / Armadi con ante scorrevoli / Schränke mit Schiebetüren

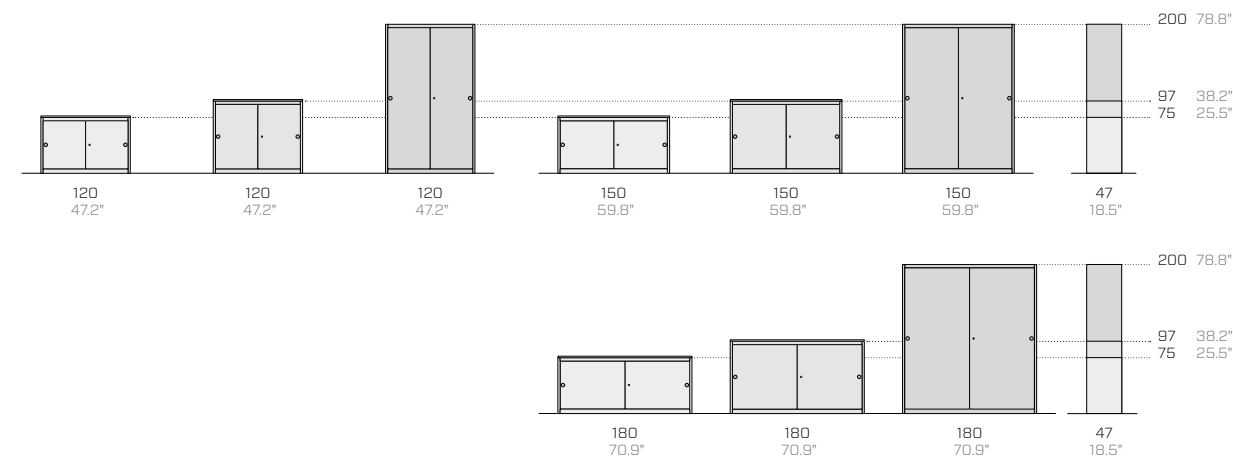

Outdoor cabinets with hinged doors / Armadi con ante a battente outdoor / Außenschränke mit Flügeltüren

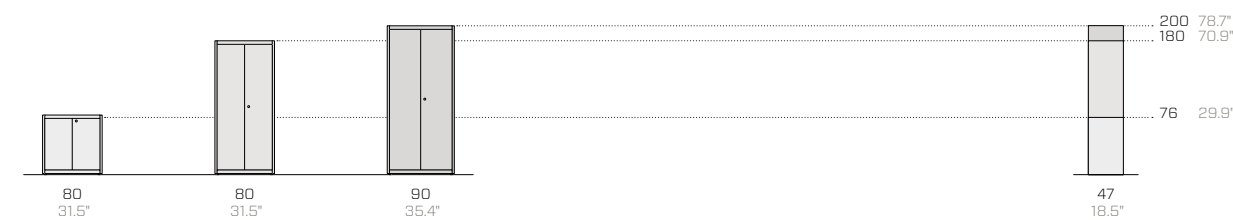

Essenza

Sandro Fantin, 2006



The Essenza collection has a slim thickness and minimal silhouettes refined down to the smallest detail, to accommodate the needs of the most demanding customers. The strength of metal guarantees solidity and durability, while a broad range of colours make for a versatile adaptation to the most sophisticated environments. The broad choice of internal accessories means all sorts of contents can be archived, while the use of just eight screws confirms that it is exceptionally easy to assemble, while nonetheless guaranteeing reliability over time, a feature, which distinguishes all Fantin products.

La collezione Essenza ha spessori sottili e linee minimali rifinite nei dettagli, per soddisfare le richieste più esigenti. La forza del metallo garantisce solidità e durevolezza, mentre un'ampia gamma colori consente un versatile adattamento negli ambienti più raffinati. L'ampia possibilità di accessori interni permette di archiviare correttamente qualsiasi tipologia di contenuto, mentre l'utilizzo di sole otto viti conferma una facilità di montaggio eccezionale, garantendo comunque quell'affidabilità nel tempo che caratterizza non solo Essenza, ma tutti i prodotti Fantin.

Die geringe Stärke der Elemente und die bis ins Detail ausgearbeiteten schlichten Linien sind wesentliche Merkmale der Kollektion Essenza, die höchsten Ansprüchen gerecht wird. Die Festigkeit des Metalls gewährleistet Robustheit und Langlebigkeit und dank einer breiten Farbpalette lassen sich die Schränke selbst in anspruchsvollsten Umgebungen vielseitig einsetzen. Die umfassende Auswahl an Innenzubehör erlaubt die Archivierung jeder Art von Material, während durch die Verwendung von nur acht Schrauben eine extrem unkomplizierte Montage sichergestellt ist. Dennoch bietet Essenza die langfristige Zuverlässigkeit, die allen Produkten von Fantin gemein ist.

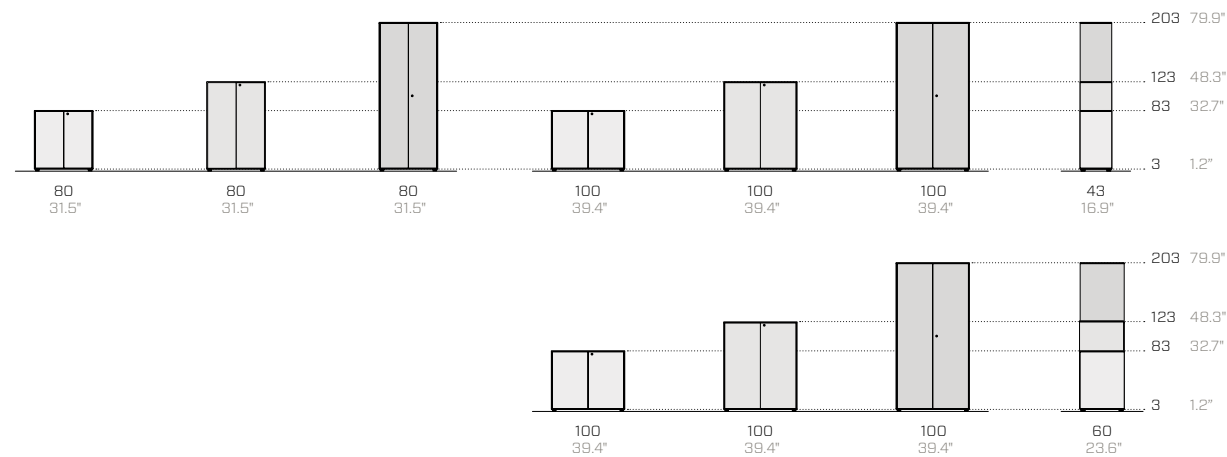



51.18

Sand / Sabbia / Sand

Embossed / Goffrato / Gaufriert



Binaria

Salvatore Indriolo, 2013



The sophisticated shapes and painstaking care for technical details make Binaria the ideal solution for both public and private environments, even for new and unusual uses. The ergonomic recessed groove handle on the modules, which is achieved by removing some of the material from the décor panel, is the characteristic styling detail which sets out this system from the other collections available on the market today. In the version with the upright frame, Binaria truly becomes a small interior architecture, which plays the starring role of its setting.

La raffinatezza delle forme e la cura dei dettagli tecnici rendono Binaria una soluzione adatta in ambienti pubblici e privati anche per nuove ed inusuali destinazioni d'uso. L'ergonomica presa maniglia dei moduli, ottenuta per sottrazione dei volumi, è la caratteristica estetica che differenzia questo sistema dalle altre collezioni presenti oggi sul mercato. Nella versione con ponte, Binaria diventa una piccola architettura da interni, protagonista al centro della scena.

Raffinierte Formen und sorgfältig ausgearbeitete technische Details machen Binaria zu einer sowohl für den öffentlichen als auch privaten Bereich geeigneten Lösung, selbst im Falle neuer und ungewöhnlicher Verwendungszwecke. Der ergonomische Griff der Module, der durch eine Aussparung zum Eingriff realisiert wurde, ist das ästhetische Merkmal, das dieses System von anderen heute auf dem Markt erhältlichen Kollektionen unterscheidet. In der Version mit Brücke wird Binaria zu einem Innenarchitekturelement, das bewusst in den Mittelpunkt der Szene rückt.

Static module depths
Profondità moduli fissi
Tiefen feste Module
30 cm
11.8"

Sliding module depths
Profondità moduli mobili
Tiefen bewegliche Module
60 cm
23.6"

Module heights
Altezze moduli
Modulhöhen
214 / 254 cm
84.3" / 100"

Passage length
Lunghezza corridoio
Länge des Korridors
80 / 100 / 120 cm
31.5" / 39.4" / 47.2"



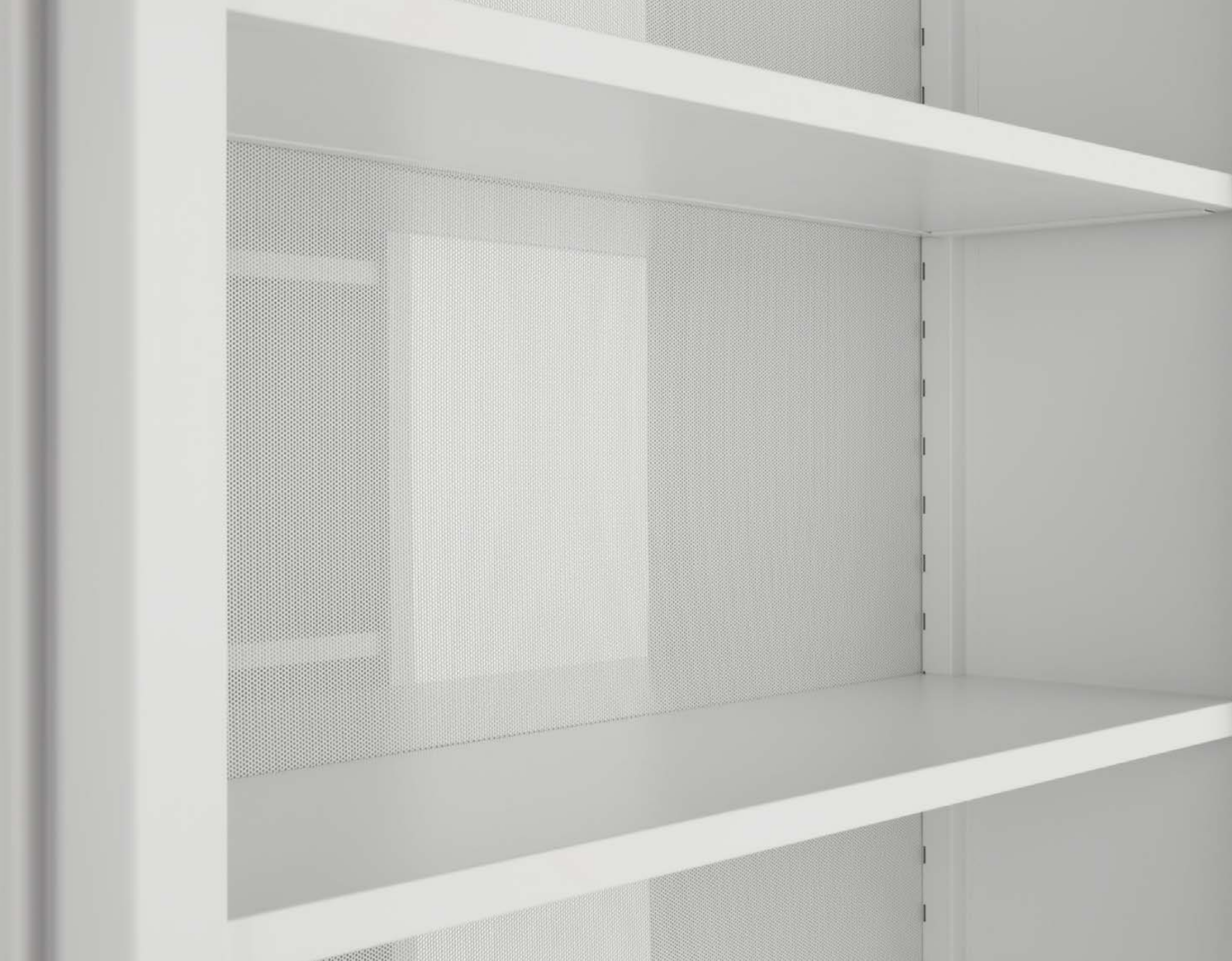

Great attention to detail is shown both outside and inside Fantin compactable wardrobes. This photo shows how the micro-perforated backboards add lightness to the appearance of the whole system. The height of the shelves can be adjusted at 5 cm (2") intervals, for maximum personalization of every module. New design solutions can also be proposed to cater to specific storage needs.

Gli armadi compattabili Fantin sono curati nei minimi dettagli anche internamente. In questa foto, si può apprezzare l'utilizzo di schiene microforate, che regalano leggerezza visiva all'intero sistema. I ripiani, regolabili in altezza con passo 5 cm (2"), garantiscono la massima personalizzazione di ogni modulo. Inoltre, sono possibili soluzioni di nuova progettazione, per specifiche esigenze contenitive.

Die mobilen Schränke von Fantin sind bis ins kleinste Detail, auch innen, sorgfältig verarbeitet. Auf diesem Foto kann man die Anwendung von Lochrückwänden schätzen, die dem gesamten System visuelle Leichtigkeit verleihen. Die in einem Abstand von 5 cm (2") höhenverstellbaren Einlegeböden sorgen für maximale Personalisierung eines jeden Moduls. Darüber hinaus sind neu konzipierte Lösungen für spezifischen Aufbewahrungsbedarf möglich.



Vela

Salvatore Indriolo, 2013



Vela is distinguished by practical full-height handles, which mark the rhythm of the modules. The fundamental and ergonomic design of this model make it ideal for use in offices and professional practices, adding a touch of class to its surroundings. It can be installed free-standing, for free access from either side of the module, while at the same time turning into a practical partition for open-plan settings.

Vela è caratterizzato da comode maniglie a tutta altezza, che scandiscono il ritmo dei moduli. L'essenzialità e l'ergonomia lo rendono ideale in uffici e studi professionali, valorizzando l'ambiente in cui viene collocato. Può essere posizionato in modalità free-standing, per il libero accesso da entrambi i lati e diventando, al contempo, un comodo divisorio in soluzioni open-space.

Vela zeichnet sich durch seine über die gesamte Höhe reichenden bequemen Griffe aus, die die Schrankaufteilung optisch unterstreichen. Durch seine Schlichtheit und Ergonomie lässt sich Vela in jedem Büro – sei es im Unternehmen oder freiberuflich – ideal einsetzen und eine Aufwertung der Umgebung erzielen. Vela kann freistehend zum bequemen Zugang von beiden Seiten aufgestellt werden. Dadurch ist auch eine Verwendung als praktisches Trennelement im Falle von Open-Space-Lösungen möglich.

Static module depths
Profondità moduli fissi
Tiefen feste Module
30 cm
11.8"

Sliding module depths
Profondità moduli mobili
Tiefen bewegliche Module
60 cm
23.6"

Module heights
Altezze moduli
Modulhöhen
214 / 254 cm
84.3" / 100"

Passage length
Lunghezza corridoio
Länge des Korridors
80 / 100 / 120 cm
31.5" / 39.4" / 47.2"

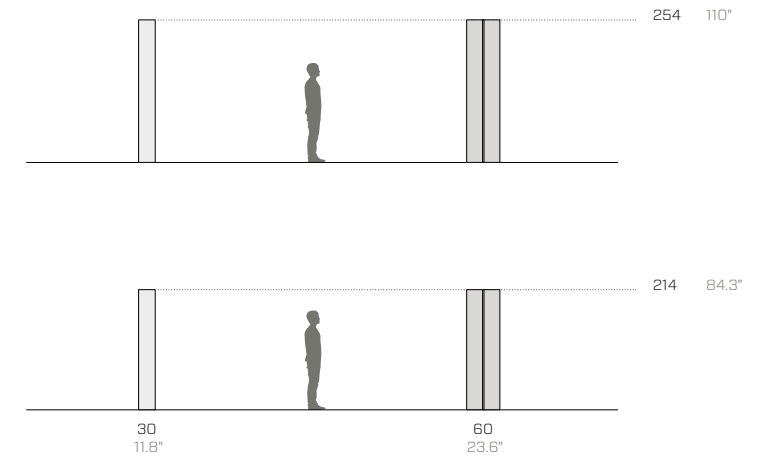





Discovery

Salvatore Indriolo, 2013



Discovery is the perfect solution for those who want both contemporary design and ample storage space. The pure and minimal silhouettes mean it blends in seamlessly not only in hidden environments, which is the case for the majority of these systems, but also when visible to clients in professional practices, top-end shops or other settings where appearance is all-important.

Discovery è ideale per chi richiede contemporaneamente un design ricercato e importanti volumi di contenimento. Le linee pure e minimali permettono la sua collocazione non solo in ambienti nascosti, come avviene per la maggior parte di questi sistemi, ma anche in vista in studi professionali, negozi d'alta fascia o altre situazioni dove l'aspetto espositivo è importante.

Discovery ist ideal für alle, die sowohl Wert auf gehobenes Design als auch auf großes Stauvolumen legen. Dank seiner klaren, minimalistischen Linien braucht sich dieser Schrank nicht zu verstecken, wie dies bei den meisten dieser Systeme der Fall ist. Stattdessen kann er gut sichtbar in Büros, exklusiven Geschäften und anderen Umgebungen aufgestellt werden, wo der Ausstellungsaspekt wichtig ist.







Static module depths
Profondità moduli fissi
Tiefen feste Module
 30 / 35 / 40 / 45 / 50 cm
 11.8" / 13.8" / 15.7" / 17.7" / 19.7"

Sliding module depths
Profondità moduli mobili
Tiefen bewegliche Module
 60 / 70 / 80 / 90 / 100 cm
 23.6" / 27.6" / 31.5" / 35.4" / 39.4"

Module heights
Altezze moduli
Modulhöhen
 218.5 / 228.5 / 258.5
 288.5 / 303.5 cm
 86" / 90" / 101.8"
 113.6" / 119.5"

Passage length
Lunghezza corridoio
Länge des Korridors
 163 / 183 / 203 / 223 / 243
 263 / 283 / 303 / 323 / 343
 363 / 383 / 403 / 423 / 443
 463 / 483 / 503 / 523 / 543
 563 / 583 / 603 cm
 64.2" / 72" / 79.9" / 87.8" / 95.7"
 103.5" / 111.4" / 119.3" / 127.2"
 135" / 142.9" / 150.8" / 158.7"
 166.5" / 174.4" / 182.3" / 190.2"
 198" / 205.9" / 213.8" / 221.7"
 229.5" / 237.4"

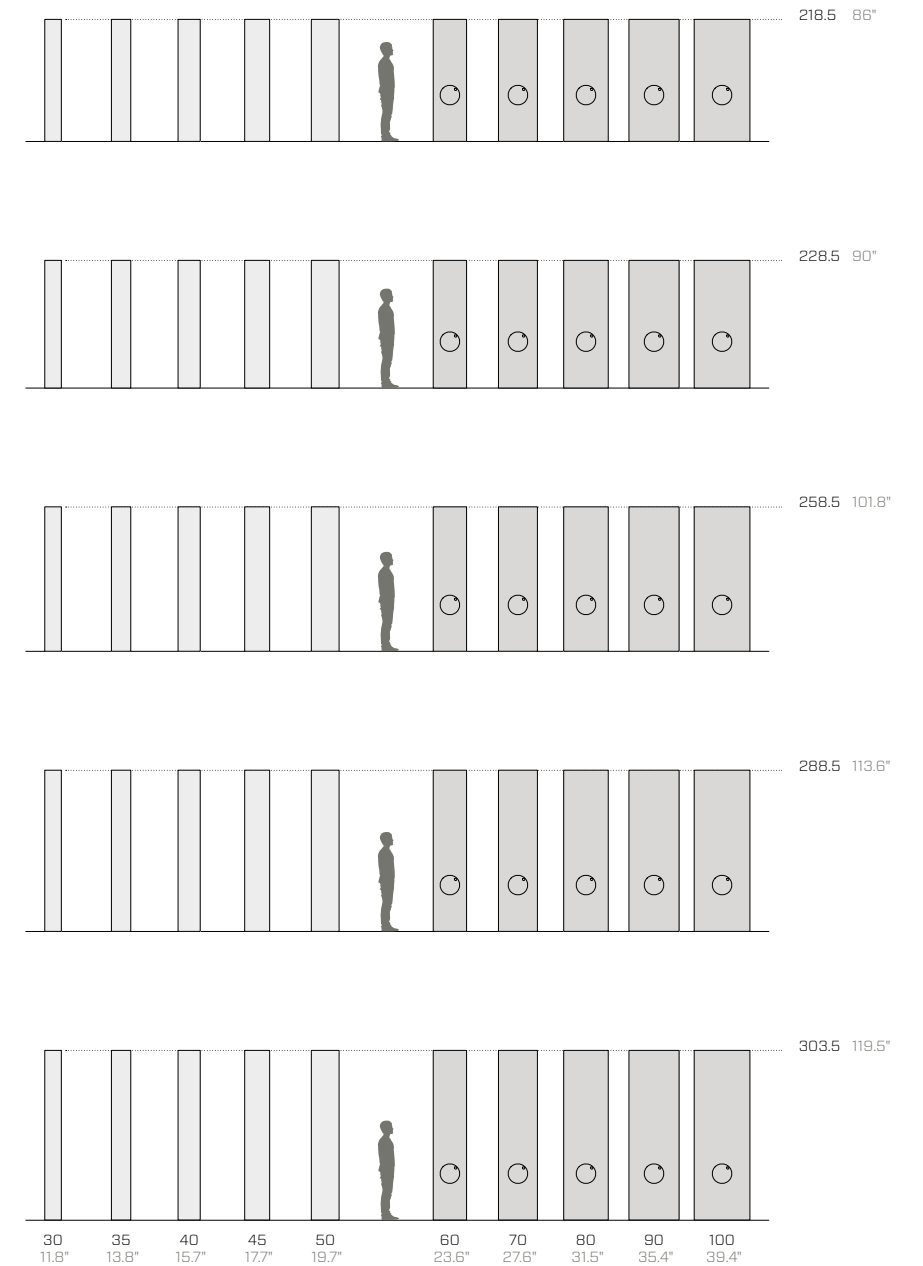



Ad hoc



7.

6.

1998 | 2008

1992 | 1997



1

The Archive

Da luogo statico, legato al passato, l'archivio si trasforma in un sistema multimediale in cui la classificazione storica, di oggetti e progetti, è affiancata da tecnologie digital e social di ultima generazione, dal tablet a Pinterest. In ciascuno dei 9 moduli-scaffale si sviluppa una timeline che parte dagli Anni 50 e arriva a oggi, ricostruendo con oggetti-capofila la storia degli arredi per ufficio: sistemi operativi, lampade, sedute, senza dimenticare la tecnologia, dalle calcolatrici ai computer. Una storia tutta da scoprire, e approfondire, nello storytelling delle bacheche di Pinterest e negli approfondimenti da sfogliare sul device.

Drawing from its static past, the archive transforms into a multimedia system, in which the historical classification of objects is paired with the latest generation of digital and social technologies: from tablets to Pinterest. A timeline within each of the nine shelving units takes you on journey, starting from the 1950s and culminating in the present-day, where the history of office design is reconstructed with iconic objects from the past: operating systems, lamps, chairs, and of course - technology, from calculators to computers. This is a story to discover and explore on Pinterest, by accessing Pinterest boards and by browsing on tablet.

1948 1960





Berengo Showroom, Venice, Italy



© Matteo Piazza

Ad hoc 226-227

Our Vision

A strong Vision supported by a value enhancing business model.

We are the leading partner where innovation, entrepreneurship and educational content are easily combinable, using a digital approach. We support the creation of new business models and the transformation and retention of young people and companies. Founded in January 2006, we were the first in the world to adopt a model that combined investments, business consulting and digitally-driven educational programmes in one place.

We are the human-centered ecosystem based on a 3-pillar business model that (connected together) benefit from synergies and interconnectivity for value creation. Our Campus is an international hub where students and professional entrepreneurs together in the digital transformation process, in a place for sharing ideas and a privileged point of view on the future, on new trends in the marketplace, on technological advancements and on how the digital transformation will change society.



- Intel, Cisco, Audi, Omnicom, SE, Unilever, O, Helix, LG, Praxi, IOT, ASGA Ability, AXIA



Indoor finishes







Finishes for metal / Finiture per metallo / Ausführungen für Metall	Metal essentials	234
	Metal design	235
Finishes in other materials / Finiture in altri materiali / Finishes in anderen Materialien	Glass essentials	236
	Glass design	237
	Stainless steel / Acciaio inox / Edelstahl CNS	238
	Melamine coated / Nobilitato / Melaminbeschichtet	238
	Fabric / Tessuto / Stoff	238
	Technical informations / Informazioni tecniche / Technische Informationen	239

Metal essentials







	01.18 Black (RAL 9005) Nero / Schwarz --- EM ▲		08.20 Rose quartz Rosa quarzo / Rosenquarz --- EM ▲■		15.19 Forest green (RAL 6007) Verde bosco / Waldgrün --- EM ▲●
	02.18 Anthracite (RAL 7021) Antracite / Anthrazit --- EM ▲●■		09.24 Terracotta (RAL 8004) Terracotta / Terrakotta --- EM ▲●■		16.24 Cement (RAL 7033) Cemento / Zement --- EM ▲●■
	03.18 Fantin grey Grigio Fantin / Fantin-Grau --- EM ▲●■		10.21 Flame red (RAL 3000) Rosso fuoco / Feuerrot --- EM ▲		17.24 Slate (RAL 7031) Ardesia / Schiefer --- EM ▲●■
	04.18 Light grey (RAL 7035) Grigio luce / Lichtgrau --- EM ▲●■		11.21 Melon yellow (RAL 1028) Giallo melone / Melonengelb --- EM ▲●		18.21 Dusty blue (RAL 5014) Azzurro polvere / Staubiges blau --- EM ▲■
	05.19 Cloud grey Grigio nuvola / Walkengrau --- EM ▲■		12.19 Zinc yellow (RAL 1018) Giallo zinco / Zinkgelb --- EM ▲■		19.18 Gentian blue (RAL 5010) Blu genziana / Enzianblau --- EM ▲●
	06.18 White (RAL 9016) Bianco / Weiß --- EM ▲■		13.21 Pastel green (RAL 6019) Verde pastello / Weißgrün --- EM ▲●■		20.19 Steel blue (RAL 5011) Blu acciaio / Stahlblau --- EM ▲
	07.21 Milk white (RAL 9001) Bianco latte / Milchweiß --- EM ▲●■		14.18 Sage green (RAL 6021) Verde salvia / Salbeigrün --- EM ▲●■		21.21 Coffee brown (RAL 8019) Marrone caffè / Kaffeebraun --- EM ▲■

Metal design

Metallic

	61.24 Pale gold Oro chiaro / Hellgold --- EM ▲■
	62.24 Copper Rame / Kupfer --- EM ▲●■
	47.21 Platinum Platino / Platin --- EM ▲
	43.21 Bronze Bronzo / Bronze --- EM ▲
	63.24 Graphite Grafite / Graphit --- EM ▲●
	64.24 Silver green Verde argento / Silbergrün --- EM ▲●
	65.24 Silver blue Blu argento / Silberblau --- EM ▲●

Earth

	51.18 Sand Sabbia / Sand --- EM ▲●
	57.21 Clay Creta / Lehm --- EM ▲●
	52.18 Moss Muschio / Moos --- EM ▲●
	66.24 Lichen Lichene / Flechte --- EM ▲■
	67.24 Pink clay Argilla rosa / Rosa Ton --- EM ▲●■
	68.24 Sodalite Sodalite / Sodalith --- EM ▲
	56.21 Ocean Oceano / Ozean --- EM ▲

Surfaces / Superfici / Oberflächen

EM ▲ Embossed / Goffrato / Gaufriert

EM ● Outdoor / Esterni / Außenbereich

EM ■ Food / Alimentare / Lebensmittel

Use / Utilizzo / Verwenden

▲ Tops / Top / Arbeitsplatte











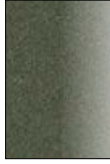

● Outdoor / Esterni / Außenbereich

■ Food / Alimentare / Lebensmittel

Glass essentials

	G01.23 Black (RAL 9005) Nero / Schwarz --- ET ▲ ■		G08.23 Rose quartz Rosa quarzo / Rosenquarz --- ET ▲ ■		G15.23 Forest green (RAL 6007) Verde bosco / Waldgrün --- ET ▲ ■
	G02.23 Anthracite (RAL 7021) Antracite / Anthrazit --- ET ▲ ■		G09.24 Terracotta (RAL 8004) Terracotta / Terrakotta --- ET ▲ ■		G16.24 Cement (RAL 7033) Cemento / Zement --- ET ▲ ■
	G03.23 Fantin grey Grigio Fantin / Fantin-Grau --- ET ▲ ■		G10.23 Flame red (RAL 3000) Rosso fuoco / Feuerrot --- ET ▲ ■		G17.24 Slate (RAL 7031) Ardesia / Schiefer --- ET ▲ ■
	G04.23 Light grey (RAL 7035) Grigio luce / Lichtgrau --- ET ▲ ■		G11.23 Melon yellow (RAL 1028) Giallo melone / Melonengelb --- ET ▲ ■		G18.23 Dusty blue (RAL 5014) Azzurro polvere / Staubiges blau --- ET ▲ ■
	G05.23 Cloud grey Grigio nuvola / Walkengrau --- ET ▲ ■		G12.23 Zinc yellow (RAL 1018) Giallo zinco / Zinkgelb --- ET ▲ ■		G19.23 Gentian blue (RAL 5010) Blu genziana / Enzianblau --- ET ▲ ■
	G06.23 White (RAL 9016) Bianco / Weiß --- ET ▲ ■		G13.23 Pastel green (RAL 6019) Verde pastello / Weißgrün --- ET ▲ ■		G20.23 Steel blue (RAL 5011) Blu acciaio / Stahlblau --- ET ▲ ■
	G07.23 Milk white (RAL 9001) Bianco latte / Milchweiß --- ET ▲ ■		G14.23 Sage green (RAL 6021) Verde salvia / Salbeigrün --- ET ▲ ■		G21.23 Coffee brown (RAL 8019) Marrone caffè / Kaffeebraun --- ET ▲ ■

Glass design

	G61.24 Pale gold Oro chiaro / Hellgold --- ET ▲ ■		G51.23 Sand Sabbia / Sand --- ET ▲ ■
	G62.24 Copper Rame / Kupfer --- ET ▲ ■		G57.23 Clay Creta / Lehm --- ET ▲ ■
	G47.23 Platinum Platino / Platin --- ET ▲ ■		G52.23 Moss Muschio / Moos --- ET ▲ ■
	G43.23 Bronze Bronzo / Bronze --- ET ▲ ■		G66.24 Lichen Lichene / Flechte --- ET ▲ ■
	G63.24 Graphite Grafite / Graphit --- ET ▲ ■		G67.24 Pink clay Argilla rosa / Rosa Ton --- ET ▲ ■
	G64.24 Silver green Verde argento / Silbergrün --- ET ▲ ■		G68.24 Sodalite Sodalite / Sodalith --- ET ▲ ■
	G65.24 Silver blue Blu argento / Silberblau --- ET ▲ ■		G56.23 Ocean Oceano / Ozean --- ET ▲ ■

Surfaces / Superfici / Oberflächen

ET Etched / Acidato / Geätzt

Use / Utilizzo / Verwenden

- ▲ Tops / Top / Arbeitsplatte
- Outdoor / Esterni / Außenbereich
- Food / Alimentare / Lebensmittel

Stainless steel Acciaio inox Edelstahl CNS



**K1.18
Inox Vintage**
Inox Vintage / Inox Vintage

HG ▲ ● ■



**K2.19
Inox Satin**
Inox satinato / Inox satiniert

HG ▲ ● ■

Surfaces / Superfici / Oberflächen

EM Embossed / Goffrato / Gaufriert
MT Matt / Opaco / Matt
HG High Gloss / Lucido / Glänzend

Use / Utilizzo / Verwenden

- ▲ Tops / Top / Arbeitsplatte
- Outdoor / Esterni / Außenbereich
- Food / Alimentare / Lebensmittel

Melamine coated Nobilitato Melaminbeschichtet



**M3.21
Black**
Nero / Schwarz

EM ▲

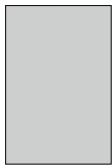

**M1.18
Grey**
Grigio / Grau

EM ▲



**M2.18
White**
Bianco / Weiß

EM ▲

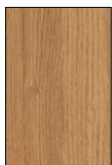

**M4.18
Natural oak**
Rovere naturale / Eiche hell

EM ▲

Fabric Tessuto Stoff



**T1.22
Smoke**
Fumo / Rauch



**T2.22
Hemp**
Canapa / Hanf



**T3.22
Cherry**
Ciliegia / Kirsche



**T4.22
Amber**
Ambra / Bernstein



**T5.22
Leaf**
Foglia / Blatt



**T6.22
Denim**
Denim / Denim



**T7.22
Taupe**
Tortora / Taupe

Technical information

Metal Non-toxic powder coating for interior use, with no heavy metals. Cured in an oven at 190 °C, following degreasing and phosphating. Guaranteed minimum thickness of 50 microns. Minimum resistance to salt spray of 200 hours (in accordance with the ASTM B117 standard). Some finishes are suitable for direct contact with food as required by Italian Law Decree D.M. 21/03/73 and subsequent updates. Requests for other RAL finishes can be considered. On some finishes, any partial discolouration following rubbing and/or abrasion has absolutely no effect on the technical, appearance/colour and chemical/physical characteristics of the product. This phenomenon tends to diminish over the useful life of the product and does not in any case present a health hazard to users.

Glass Extra-clear glass, with a thickness of 6 mm (0.24"), etched on the top, ground with a matt edge. Coated on the back with water-based paint in the 35 Fantin finishes.

AISI 304 stainless steel Kitchen top with a thickness of 4 mm (0.16") with Vintage (exclusive Barazza manual processing, making it quicker and easier to maintain) or satin finish.

Melamine coated Faced top with a fibre-board structure and a coloured or wood-effect melamine finish. Requests for other melamine finishes will be considered.

Fabric Made from GRS-certified 100% recycled yarn. Composition: 75% cotton, 20% acrylic, 5% other fibres. Weight: 328 g/m².

Informazioni tecniche

Metallo Verniciatura per interni a polveri atossiche prive di metalli pesanti, con passaggio in forno a 190 °C, previo trattamento di sgrassaggio e fosfatazione. Spessore minimo garantito 50 micron, resistenza minima in nebbia salina pari a 200 ore (norma ASTM B117). Alcune finiture sono idonee al contatto diretto con alimenti come previsto dal decreto italiano D.M. 21/03/73 e successivi aggiornamenti. Altre finiture RAL valutabili su richiesta. Su alcune finiture, l'eventuale parziale cessione di colore in seguito a strofinamento e/o abrasione non influisce assolutamente sulle caratteristiche tecniche, di aspetto/colore, e chimico-fisiche del prodotto. Tale fenomeno tende a diminuire nel corso della vita utile del manufatto e non comporta in alcun caso pericoli per la salute degli utilizzatori.

Vetro Vetro extra-chiaro di spessore 6 mm (0.24"), acidato superiormente, molato con bordo filo-opaco. Retroverniciato con verniciatura all'acqua nelle 35 finiture Fantin.

Acciaio inox AISI 304 Piano cucina spessore 4 mm (0.16") con finitura Vintage (lavorazione manuale esclusiva Barazza, la cui manutenzione è più semplice e agevole) o satinata.

Nobilitato Piano in nobilitato con struttura in pannello di fibre di legno rivestito da finiture melaminiche colorate o effetto legno. Altre finiture melaminiche sono valutabili su richiesta.

Tessuto Ottenuto da filati 100% rigenerati, certificati GRS. Composizione: 75% cotone, 20% acrilico, 5% altre fibre. Peso 328 g/mq.

Technische Informationen

Metall Die Pulverbeschichtung der gift- und schwermetallfreien Pulverlacke für Innenbereiche erfolgt im Lackierofen bei 190 °C nach vorheriger Entfettung und Phosphatierung. Die garantierte Mindeststärke der Lackschicht beträgt 50 Mikron bei einer Mindestprüfungsdauer von 200 Stunden im Salznebel (ASTM-Norm B117). Einige Oberflächen sind für den direkten Kontakt mit Lebensmitteln geeignet, wie in der Verordnung vorgesehen Italienisch D.M. 21/03/73 und folgende Aktualisierungen. Auf Anfrage können andere RAL-Finishes in Betracht gezogen werden. Bei einigen Ausführungen hat eine teilweise Verfärbung durch Reiben und/oder Abrieb keine Auswirkungen auf die technischen, optischen/farblichen und chemisch-physikalischen Eigenschaften des Produkts. Dieses Phänomen nimmt im Laufe der Nutzungsdauer des Produkts tendenziell ab und stellt in keinem Fall eine Gefahr für die Gesundheit der Benutzer dar.

Glas Extra klares Glas, Stärke 6 mm (0.24"), geätzte Oberseite, geschliffen mit bündiger, matter Kante. Rückseitig beschichtet mit Lack auf Wasserbasis in den 35 Farbtönen von Fantin.

Edelstahl CNS AISI 304 Küchenarbeitsplatte Stärke 4 mm (0.16") mit Vintage-Finish (exklusive Handverarbeitung Barazza, die leicht und bequem zu pflegen ist) oder satiniert.













Melaminbeschichtet Melaminbeschichtete Tischplatte bestehend aus einer Holzfaserverplatte, die mit farbigen Melaminfinishes oder Holzeffektfinishes überzogen ist. Andere Melaminfinishes können auf Anfrage abgewägt werden.

Stoff Das Stoff wird aus 100%ig regenerierten GRS-zertifizierten Garnen gewonnen. Zusammensetzung: 75% Baumwolle, 20% Acryl, 5% andere Fasern. Gewicht: 328 g/m².

Outdoor finishes



Finishes for metal / Finiture per metallo / Finishes für Metall	Metal essentials	242
	Metal design	243
Finishes in other materials / Finiture in altri materiali / Finishes in anderen Materialien	Stainless steel / Acciaio inox / Edelstahl CNS	244
	Technical informations / Informazioni tecniche / Technische Informationen	245

Metal essentials





 <p>02.18 Anthracite (RAL 7021) Antracite / Anthrazit --- EM ▲●■</p>	 <p>09.24 Terracotta (RAL 8004) Terracotta / Terrakotta --- EM ▲●■</p>	 <p>15.19 Forest green (RAL 6007) Verde bosco / Waldgrün --- EM ▲●</p>
 <p>03.18 Fantin grey Grigio Fantin / Fantin-Grau --- EM ▲●■</p>	 <p>11.21 Melon yellow (RAL 1028) Giallo melone / Melonengelb --- EM ▲●</p>	 <p>16.24 Cement (RAL 7033) Cemento / Zement --- EM ▲●■</p>
 <p>04.18 Light grey (RAL 7035) Grigio luce / Lichtgrau --- EM ▲●■</p>	 <p>13.21 Pastel green (RAL 6019) Verde pastello / Weißgrün --- EM ▲●■</p>	 <p>17.24 Slate (RAL 7031) Ardesia / Schiefer --- EM ▲●■</p>
 <p>07.21 Milk white (RAL 9001) Bianco latte / Milchweiß --- EM ▲●■</p>	 <p>14.18 Sage green (RAL 6021) Verde salvia / Salbeigrün --- EM ▲●■</p>	 <p>19.18 Gentian blue (RAL 5010) Blu genziana / Enzianblau --- EM ▲●</p>

Metal design

Metallic

 <p>62.24 Copper Rame / Kupfer --- EM ▲●■</p>	 <p>63.24 Graphite Grafite / Graphit --- EM ▲●</p>	 <p>64.24 Silver green Verde argento / Silbergrün --- EM ▲●</p>	 <p>65.24 Silver blue Blu argento / Silberblau --- EM ▲●</p>
--	---	--	--

Earth

 <p>51.18 Sand Sabbia / Sand --- EM ▲●</p>	 <p>57.21 Clay Creta / Lehm --- EM ▲●</p>	 <p>52.18 Moss Muschio / Moos --- EM ▲●</p>	 <p>67.24 Pink clay Argilla rosa / Rosa Ton --- EM ▲●■</p>
---	--	--	--

All Fantin outdoor products should be placed under a shelter, protected from atmospheric agents. It is advisable to clean the surfaces regularly according to the instructions for use and maintenance.

I prodotti Fantin outdoor devono essere collocati sotto una copertura, al riparo dall'esposizione diretta agli agenti atmosferici. Si consiglia di pulire regolarmente le superfici, seguendo le prescrizioni di uso e manutenzione.

Alle Outdoor Fantin-Produkte müssen vor Witterungseinflüssen unter einem Schutzdach aufzustellen. Es ist ratsam, die Oberflächen regelmäßig unter Beachtung der Gebrauchs- und Wartungsanweisungen zu reinigen.

Surfaces / Superfici / Oberflächen

EM Embossed / Goffrato / Gaufriert

Use / Utilizzo / Verwenden

- ▲ Tops / Top / Arbeitsplatte
- Outdoor / Esterni / Außenbereich
- Food / Alimentare / Lebensmittel

Stainless steel Acciaio inox Edelstahl CNS



K1.18

Inox Vintage

Inox Vintage / Inox Vintage

- - -

HG ▲ ● ■



K2.19

Inox Satin

Inox satinato / Inox satiniert

- - -

HG ▲ ● ■

Surfaces / Superfici / Oberflächen

HG High Gloss / Lucido / Glänzend

Use / Utilizzo / Verwenden

- ▲ Tops / Top / Arbeitsplatte
- Outdoor / Esterni / Außenbereich
- Food / Alimentare / Lebensmittel

Technical information

All Fantin outdoor products must be kept under a shelter and protected from direct exposure to the elements. The surfaces should be cleaned and dried on a regular basis, in accordance with the use and maintenance instructions (see the warranty details in point 7 of the terms and conditions of sale).

Metal Non-toxic powder coating for interior use, with no heavy metals. Cured in an oven at 190°C, following degreasing and phosphating. Guaranteed minimum thickness of 50 microns. Minimum resistance to salt spray of 200 hours (in accordance with the ASTM B117 standard). Some finishes are suitable for direct contact with food as required by Italian Law Decree D.M. 21/03/73 and subsequent updates. Before the coating is added, it is possible to give the products a special treatment to make them more resistant to wear and exposure to the elements. Requests for other RAL finishes can be considered.

AISI 304 stainless steel Kitchen top with a thickness of 4 mm (0.16"), with Vintage (exclusive Barazza manual processing, making it quicker and easier to maintain) or satin finish.

AISI 316 stainless steel Steel top with 6 mm (0.24") slim edge, made with an aluminium honeycomb support, available in Vintage (exclusive Barazza manual processing, making it quicker and easier to maintain) or satin finish. AISI 316 stainless steel – a material suitable for outdoor use – provides better resistance in environments where saltiness is present, particularly in seaside areas. It is also resistant to the corrosive effects of chlorine and particularly aggressive detergents.

Informazioni tecniche

I prodotti Fantin outdoor devono essere collocati sotto una copertura, al riparo dalla esposizione diretta agli agenti atmosferici. Si consiglia di pulire e asciugare regolarmente le superfici, seguendo le prescrizioni di uso e manutenzione (garanzia all'art. 7 nelle condizioni di vendita).

Metallo Verniciatura per interni a polveri atossiche prive di metalli pesanti, con passaggio in forno a 190°C, previo trattamento di sgrassaggio e fosfatazione. Spessore minimo garantito 50 micron, resistenza minima in nebbia salina pari a 200 ore (norma ASTM B117). Alcune finiture sono idonee al contatto diretto con alimenti come previsto dal decreto italiano D.M. 21/03/73 e successivi aggiornamenti. Prima della verniciatura, è possibile l'applicazione di un trattamento al fine di rendere i prodotti più resistenti all'uso e all'esposizione agli agenti atmosferici. Altre finiture RAL sono valutabili su richiesta.

Acciaio inox AISI 304 Piano cucina spessore 4 mm (0.16") con finitura Vintage (lavorazione manuale esclusiva Barazza, la cui manutenzione è più semplice e agevole) o satinata.

Acciaio inox AISI 316 Piano in acciaio con Bordo Slim 6 mm (0.24"), realizzato con un supporto in alveolare di alluminio, disponibile in finitura Vintage (lavorazione manuale esclusiva Barazza, la cui manutenzione è più semplice e agevole) o satinata. L'acciaio inox AISI 316 – materiale idoneo per ambienti esterni – garantisce migliore resistenza in ambienti con presenza di salsedine, in modo particolare nelle zone di mare. È inoltre resistente agli effetti corrosivi del cloro e a detersivi particolarmente aggressivi.

Technische Informationen

Alle Outdoor Fantin-Produkte müssen unter einem Dach aufgestellt werden, damit sie vor den direkten Einflüssen der Witterung geschützt sind. Die Oberflächen sollten regelmäßig unter Beachtung der Hinweise für Pflege und Wartung (Garantie unter Art. 7 der Geschäftsbedingungen) gereinigt und getrocknet werden.

Metall Die Pulverbeschichtung der gift- und schwermetalffreien Pulverlacke für Innenbereiche erfolgt im Lackierofen bei 190°C nach vorheriger Entfettung und Phosphatierung. Die garantierte Mindeststärke der Lackschicht beträgt 50 Mikron bei einer Mindestprüfungsdauer von 200 Stunden im Salznebel (ASTM-Norm B117). Einige Oberflächen sind für den direkten Kontakt mit Lebensmitteln geeignet, wie in der Verordnung vorgesehen Italienisch D.M. 21/03/73 und folgende Aktualisierungen. Vor der Pulverbeschichtung ist es möglich eine Behandlung auf die Oberfläche aufzutragen, um die Produkte für den Gebrauch und gegen Witterungseinflüsse widerstandsfähiger zu machen. Auf Anfrage können andere RAL-Finishes in Betracht gezogen werden.

Edelstahl CNS AISI 304 Küchenarbeitsplatte Stärke 4 mm (0.16") mit Vintage-Finish (exklusive Handverarbeitung Barazza, die leicht und bequem zu pflegen ist) oder satiniert.

Edelstahl CNS AISI 316 Stahlplatte mit 6 mm (0.24") Slim Edge, mit einem Aluminium Wabenträger gefertigt, in Vintage-Finish (exklusive Handverarbeitung Barazza, die leicht und bequem zu pflegen ist) oder satiniert erhältlich. Edelstahl AISI 316 – einem für den Außeneinsatz geeigneten Material – bietet eine bessere Beständigkeit in Umgebungen, in denen Salzigkeit vorhanden ist, insbesondere in Meeresgebieten. Er ist auch beständig gegen die korrosive Wirkung von Chlor und besonders aggressiven Reinigungsmitteln.

Visual index / Indice visivo / Visuelle Index



Frame
-
Bookcase system
16



Frame
-
Tables & desks
90



Uno living
142



Classic
182



Frame
-
Kitchens & workbenches
32



Hug
-
Tables & desks
98



Ali
146



Essenza
188



Frame
-
Tall units
52



Hug
-
Hangers
110



Just
154



Binaria
194



Frame
-
Stools
60



Wave
-
Desks & add-ons
114



Cambio
162



Vela
202



Frame
-
Sideboards & cupboards
66



Still
120



Run
174



Discovery
210



Frame
-
Beds
78



Uno
130



Mya
178

Thanks to our friends:
Grazie ai nostri amici:
Wir danken unseren Freunden:

Billiani

Crassevig

Cucina 33

Dudubags

EligoStudio

FontanArte

Gervasoni

GT Design

Internoitaliano

Kristalia

LaCividina

Lapalma

Rina Menardi

Miniforms

Moroso

Oluce

Once Milano

Paola Paronetto

Twils

Hug hangers (2024)

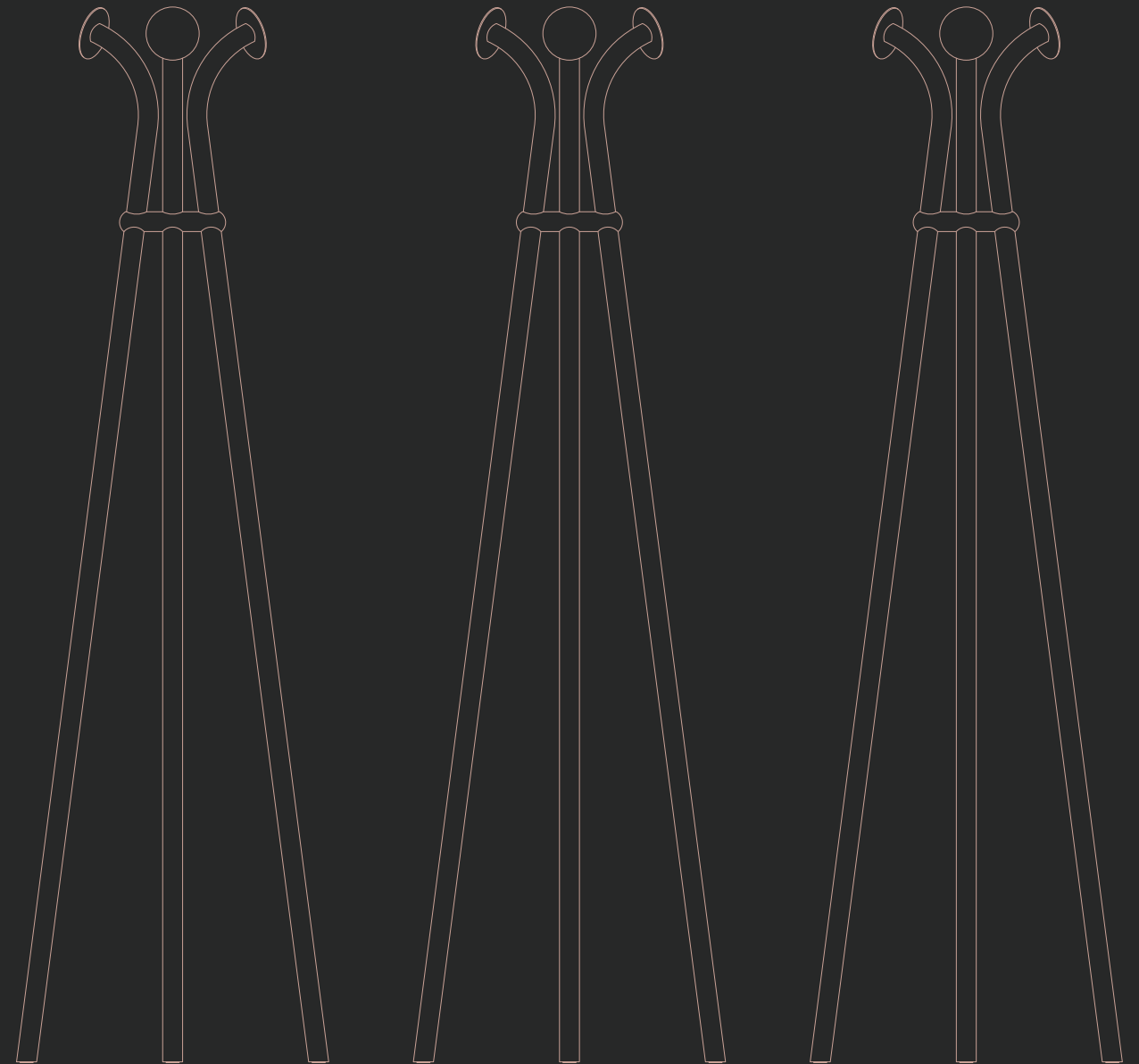

FANTIN

Catalogue 2024

Art direction

Salvatore Indriolo

Graphic design

Giorgio Cedolin

Images

Ikon Srl (studio)

Massimo Spada (location)

Art styling

Claudia Sani (studio)

Daniela Moioli (location)

Fonts

Forza, Vitesse

by Jonathan Hoefler

& Tobias Frere-Jones

Print

Grafiche Antiga Spa

© Fantin Srl

The photographs and drawings in this catalogue are only a representation of products and may be varied and changed without notice.

Our products are designed and built using state-of-the-art techniques, in compliance with the safety provisions specified in Italian Leg. Decree 81/08.

Le immagini e i disegni contenuti nel presente catalogo sono puramente rappresentativi dei prodotti e possono subire variazioni e modifiche anche senza preavviso.

I nostri prodotti sono progettati e realizzati secondo lo stato dell'arte, con relativi adempimenti in materia di sicurezza connessi al decreto italiano D.LGS. 81/08.

Alle in diesem Katalog enthaltenen Abbildungen sind unverbindlich; wir behalten uns das Recht vor, Änderungen oder Verbesserungen ohne Ankündigung durchzuführen.

Entwurf und Herstellung dieses Produkts entsprechen dem Stand der Technik sowie den Bestimmungen zur Arbeitssicherheit gemäß GD Nr. 81/08.



stampato
con il sole

**PREMIUM
COLORPRINT**



UNI EN ISO 9001

Fantin Srl

via San Vito, 43

33080 - Bannia

di Fiume Veneto (PN)

Italia

-

t +39 0434 959 133

-

fantin@fantin.com

www.fantin.com

Spazio Fantin Milano

corso Garibaldi, 34

20121 - Milano

Italia

-

milano@fantin.com

See also:

[Tone on tone](#)

[Places](#)

[Finishes](#)

[Care](#)

Follow us on:

[Instagram](#)

[LinkedIn](#)

[Facebook](#)

