

Experience a safer
and more open world



2022

Product Catalog

U.S. Prices Effective February 1, 2022

Table of Contents

Medeco

Key Control.....	4
How to Order.....	8
Online Tools	9
Record of Authorization (ROA) User Guide	10
Shipping and Returns Policy	13
Warranty	15
Architectural Specifications.....	16
Professional Services	19

Intelligent Key Systems

Medeco XT.....	23
Programming and Management	24
Intelligent Keys.....	26
Intelligent Key Cabinet (IKC).....	27
Access Interface Module (AIM)	32
Traffic Cabinet Lock	33
XT Safe Lock.....	33
XT Guard Tour Reader	34
Rim and Mortise Cylinders.....	34
Dual-Tech Cylinder	35
Dual-Tech Cams.....	35
Interchangeable Core Cylinders	36
Key-In-Knob/Lever Cylinders.....	36
Padlocks.....	38
Cam and Utility Cylinders	39
International Cylinders	40
Specialty Cylinder Formats	40
Keys and Accessories	41
Programmers and Accessories	42
M³ CLIQ®.....	44
Rim and Mortise Cylinders.....	45
Key-In-Knob/Lever Cylinders.....	45
Interchangeable Core Cylinders	47
Deadbolts.....	48
Padlocks.....	49
International Cylinders.....	51
CLIQ™ CONNECT Keys.....	52
CLIQ™ Go	53
Keys and Accessories.....	54
Programming and Management	55
Classic CLIQ®	57
Rim and Mortise Cylinders.....	58
Key-In-Knob/Lever	58
Interchangeable Core Cylinders	61
Padlocks.....	61
Deadbolts.....	62
Cam and Utility Cylinders	63
Retail/Showcase Locks	63
International Cylinders.....	64
Vending Cylinder Formats.....	64
Keys and Accessories	65
Programming and Management	66

Mechanical Technologies

Medeco 4 High Security Locking System	67
BiLevel Technology.....	68
Medeco X4 Technology	69
Medeco B Technology	113

Mechanical Products

Rim and Mortise Cylinders	71
Key-In-Knob/Lever Cylinders	82
Interchangeable Cores	104
LFIC.....	104
SFIC.....	112
Key Management.....	119
Intelligent Key Cabinet (IKC).....	119
T21 Key Management System	121
International Cylinders.....	122
Deadbolts	152
Maxum	153
Residential Maxum	160
Padlocks.....	162
All Weather Padlocks	164
Protector II Series.....	168
System Series.....	171
Hockey Puck.....	182
G8R.....	183
Cam/Cabinet and Switch Locks	184
Cam Locks	186
Removable Core Cam Locks.....	189
Cabinet Locks.....	195
Plunger Locks.....	197
Micro Switch Lock.....	198
Rotary Switch Lock.....	200
Accessories	
Keying Charges.....	202
Keys.....	204
Pin Kits.....	208
Components	211
Tools and Fixtures	212
Key Machines	213
Software and Support.....	213
Product Index.....	214
Finishes.....	223

Key Control

Medeco's Approach

The security of any locking system is dependent upon two very important factors. The first is protection against attacks such as picking, drilling, bumping, and forcing. The second is the ability to control duplication of existing keys. Historically, unauthorized key duplication has played a major role in compromising even the most sophisticated security systems. Anyone with even temporary access to original keys has no problem getting duplicates made for their own use if the keys and key blanks are not patent protected. Even stamping "Do Not Duplicate" on a key merely warns someone not to copy the key – it is not a promise of legal protection or enforcement. The only way to ensure that keys cannot be copied without the consent of the owner is a key system with patent-protected keys.

Medeco has counteracted the key control problem by doing three things:

1. Medeco manufactures cylinders which use keys that must be made on special key cutting machines. These machines are capable of reproducing the angled cuts and critical tolerances necessary to produce a workable Medeco key, and are not found at general hardware stores.
2. Medeco only sells its high-quality, precision machined cylinders and locks to security industry professionals. Every restricted Medeco key blank is custom coined and tracked by Medeco to identify it as an authorized key blank, which protects against unauthorized copies.
3. Medeco invests heavily in research and development to establish strong patents and legal agreements to protect its locks and key blanks from unauthorized distribution or manufacture.. As a result, Medeco can litigate to protect its rights and the security of its customers.

A Key Control Program That's Right for You

Not every user has the same key control needs. That's why Medeco has designed different key control programs and different keyways to meet a wide range of security specifications and key access requirements.



Dealer/Service Center

This program offers instant local access to additional keys with protection from unauthorized copying. Consumers simply return to the security provider from which they purchased the locks. This security professional will have a signature card on file completed by the owner of the key system at the time the system was installed.



Card Programs

Authorized individuals are issued a card with embossed control data and a space for their signature. To obtain key duplicates, card holders present the card to any participating Medeco security professional. The data and signature will be verified and a key can then be issued. A card program is ideal for residences or businesses that need keys available nationwide.



End User Program

The End User program is for large facilities that have their own locksmith on staff and that want to produce Medeco keys themselves. This program offers individualized control over key duplication procedures.



Commercial Program

The Commercial Program is designed for users who use Medeco locks primarily for protection against picking, drilling and other forms of physical attack. Keys may be obtained from any Medeco locksmith without specific authorization.



Factory Program

Additional keys are only available from the Medeco factory and only with the proper signature.









Intelligent Key Systems











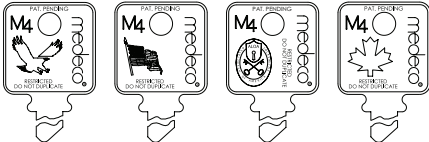





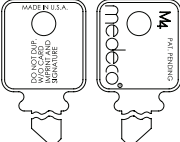

Intelligent Key Systems utilizing eCylinders allow the end user the ability to control their own system to electronically change access to any cylinder or key onsite and to obtain audit information.

Visit our website at www.medeco.com for more information on all key programs.





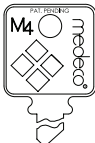





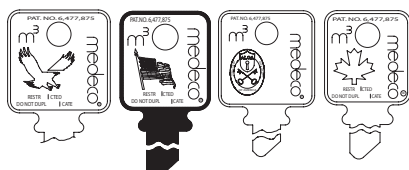



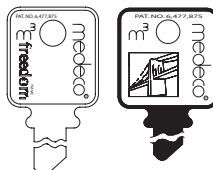

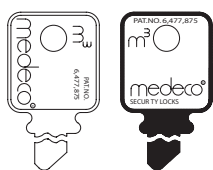

MEDECO® KEY CONTROL PROGRAM REFERENCE CHART

- M4** = Medeco 4 patent expiration date: 2040.
- M3** = Medeco³ patent expiration date: 2021. Upgrading to Medeco 4 recommended.
- BIA** = Biaxial patent expiration date: 2005. Upgrading to Medeco 4 recommended.
- ORG** = Original patent expiration date: 1985. Upgrading to Medeco 4 recommended.
-  = Permission for copying keys is obtained by presenting a signed authorization card, which is matched to proper identification.
-  = Permission for copying keys is provided by identification and signature verification, which must be presented to either the original locksmith provider or the facility manager.
-  = Keys can be cut on-site by dealers or end-users that are contracted to participate in the respective key program.
-  = Keys are ordered locally and cut at a regional service center and then shipped back to the dealer.
-  = Keys are cut at the Medeco factory and shipped to dealer. Authorization is provided by signature verification.
-  = Medeco recommended high security—UL 437 Listed, ultimate Grade 1 strength, and A156.5-2001 and A156.30 Level A Certified.

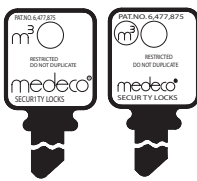



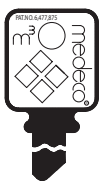





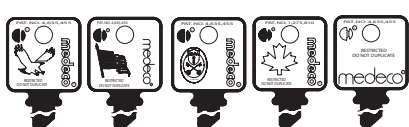

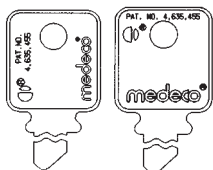
MEDECO 4® KEYWAY PROGRAMS

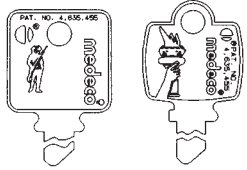
 <p style="text-align: center;">Medeco 4 Dealer</p> <p>M4   </p>	 <p style="text-align: center;">Freedom®</p> <p>M4   </p>	 <p style="text-align: center;">DND</p> <p>M4   </p>
 <p style="text-align: center;">Medeco 4 End-User</p> <p>M4   </p>	 <p style="text-align: center;">Medeco 4 Factory Restricted</p> <p>M4  </p>	











MEDECO³® KEYWAY PROGRAMS

 <p>Medeco³ Dealer</p> <p>M3   </p>	 <p>Freedom® / Gotham™</p> <p>M3   </p>	 <p>DND / NYC</p> <p>M3   </p>
 <p>Medeco³ End-User</p> <p>M3   </p>	 <p>Medeco³ Factory Restricted</p> <p>M3  </p>	

BIAXIAL KEYS

 <p>Biaxial® Dealer</p> <p>BIA  </p>	 <p>Gold (GLD) / Platinum (NUK)</p> <p>BIA  </p>	 <p>Patriot® / Liberty™</p> <p>BIA  </p>
 <p>Biaxial® End-User</p> <p>BIA  </p>	 <p>Biaxial® Factory Restricted</p> <p>BIA </p>	

ORIGINAL KEYS

 <p>Original® Dealer</p> <p>ORG  </p>	 <p>SKY</p> <p>ORG  </p>	 <p>Original® End-User</p> <p>ORG  </p>	 <p>Original® Factory Restricted</p> <p>ORG </p>
-------------------------------------------------------------------------------------------------------------------------------------------------------------------------------------------------------------------------------------------------------------------------------------------------------	------------------------------------------------------------------------------------------------------------------------------------------------------------------------------------------------------------------------------------------------------------------------------------------	------------------------------------------------------------------------------------------------------------------------------------------------------------------------------------------------------------------------------------------------------------------------------------------------------------	-----------------------------------------------------------------------------------------------------------------------------------------------------------------------------------------------------------------------------------

COMMERCIAL KEYS



Commercial
(Original & Biaxial Version)

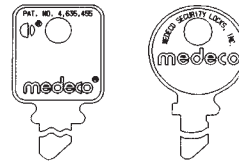

OEM / Other

Medeco keys not found on this chart are most likely from an original equipment manufacturer using Medeco products. Return to the original manufacturer of the product for duplicate keys.

MEDECO X4 KEYS

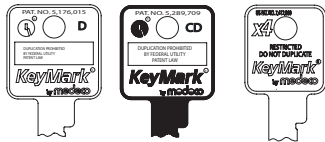

Medeco X4 Dealer

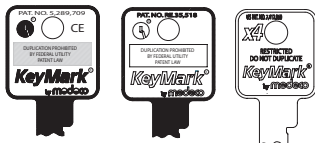

Medeco® KM/X4 End-User





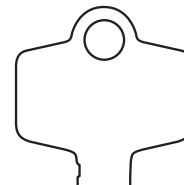

Medeco KM Silver Medeco X4 Chrome



Medeco B

Dealers do not need a contract to purchase Medeco B SFIC. Keys and cores are available through Medeco and authorized distributors.

- X4** = Medeco X4 patent expiration date: 2030.
- KM** = KeyMark patent expiration date: 2011.
-  = Permission for copying keys is obtained by presenting a signed authorization card, which is matched to proper identification.
-  = Permission for copying keys is provided by identification and signature verification, which must be presented to either the original locksmith provider or the facility manager.
-  = Keys can be cut on-site by dealers or end-users that are contracted to participate in the respective key program.
-  = Keys are ordered locally and cut at a regional service center and then shipped back to the dealer.
-  = Keys are cut at the Medeco factory and shipped to dealer. Authorization is provided by signature verification.

Submitting Orders to Medeco:

For greater efficiency and to create the best ordering experience, orders may be submitted through three order channels: eBusiness, Email or Fax.



eBusiness Order Channel

Benefit: Immediately transmit clean orders to reduce entry time to speed up delivery.

EDI

EDI stands for Electronic Data Interchange. It's the easiest method to use for the transmission of orders. Orders are generated directly from your ERP system and sent directly into Medeco's order entry system. EDI allows for instant and accurate transmission.

Medeco WebShop

Online Order Entry is a convenient web-based form which allows customers to easily use drop-down menus and filtering options to assist with product search and selection. A perfect part number is selected every time!

Visit <http://extranet.assaabloydss.com> to access.

Email Order Channel

Benefit: Immediately submit your orders directly into our Digital Filing System to speed up processing time.

In USA and International (except Canada):

orders.medeco@assaabloy.com ; In Canada: orders.medeco.ca@assaabloy.com

Emailing orders in USA and International (except Canada):

orders.medeco@assaabloy.com ; in Canada: orders.medeco.ca@assaabloy.com

This allows customers to submit purchase orders directly into Medeco's Digital Filing System. Once the order is submitted by email, an automatic email notification is sent stating the order has been received by Medeco, thus ensuring the order was not lost in transmission.

Fax Order Channel

Benefit: Immediately submit orders directly into our Digital Filing System to speed up processing time. Typed submissions receive EDI benefits of faster processing and accuracy.

USA Fax: 800.421.6615

Canada Fax: 888.263.3326

International Fax (except Canada): 540-380-1634

Faxing orders in USA: 800.421.6615 ; Canada: 888-263-3326 allows customers to submit purchase orders directly into Medeco's Digital Filing System. If a faxed order is typed versus handwritten, Medeco will be able to use an internal tool to send typed, faxed orders through the EDI portal to create faster order processing and reduce entry errors.

Special Pricing (SP) and Quotations

The SP or quote number must be referenced on the order, when submitted for processing. Any invoiced order that has the incorrect discount applied to it and did not have the SP or quote number written on the order will have a service fee of \$100.00 net DEDUCTED from any sales credit issued for the difference in the discount.

Medeco is continually developing online resources to make ordering, system management and training quicker and easier than ever. Ask your Medeco representative for more information or contact:

In USA: Customer Care Department at 877-633-3261, or customerservice.medeco@assaabloy.com.

In Canada: Customer Care Department at 888-633-3264, or customerservice.medeco.ca@assaabloy.com.

Medeco WebShop

The new online order entry site for Medeco products, Medeco WebShop is the quickest method to submit orders directly to the Medeco factory. It makes ordering your favorite Medeco products easier than ever before! Products are searchable by technology and type, with complete descriptions and photos. Save time by creating custom lists of commonly ordered products.



Medeco Key System Design Studio

The Medeco Key System Design Studio is an online portal that has taken the complexity out of master key design. Users simply answer a few questions about the project's system parameters and system management capabilities. Each click walks the user through the entire process: plan design, products ordering, and processing through Medeco.



- Saves time by eliminating questions and missing information.
- Speeds up master key order and system processing
- Provides real-time master key assistance via integrated chat with a Master Key Specialist
- Allows users to manage their submitted master key systems

Both the Medeco Key System Design Studio and Medeco WebShop are located on the ASSA ABLOY DSS Extranet, in the same location as crcDash. If you do not have a DSS Extranet login, please contact the Medeco Customer Care department for a registration form today!

In USA: Phone: 877-633-3261 • **Email:** customerservice.medeco@assaabloy.com

In Canada: Phone: 888-633-3264 • **Email:** customerservice.medeco.ca@assaabloy.com

ROA Portal Record of Authorization Digitization

The Record of Authorization (ROA) portal allows an end-user to authorize another purchaser on their behalf, instantly. The ROA portal allows an authorized end-user to sign, manage, and authorize ordering restricted Medeco products such as key blanks and pinned cylinders with a few clicks of a button. The ROA portal is the quickest way to reduce processing time with Medeco's authorization requirements. See complete guide to ROA Portal, pages 10-11.

Training

Factory certification is offered on a regular basis at Medeco's Salem, Virginia facility and at other facilities around the United States and Canada.

Medeco® offers factory certification classes with a comprehensive study of our patented Medeco 4 technology used in Medeco® cylinders. Additionally, we offer certification classes for our Medeco X4®, and M³ CLIQ and Medeco XT product lines.

Overviews of other Medeco® technologies and product lines are available online at the ASSA ABLOY Academy. Here you will find installation videos, product overview videos, sales technique videos and many other tools to assist you. To visit the online University, please visit www.assaabloyacademy.com. If you do not already have an account, you will need to register for one. Registration and online classes are complimentary.

Medeco® ROA Portal

Record of Authorization User Guide

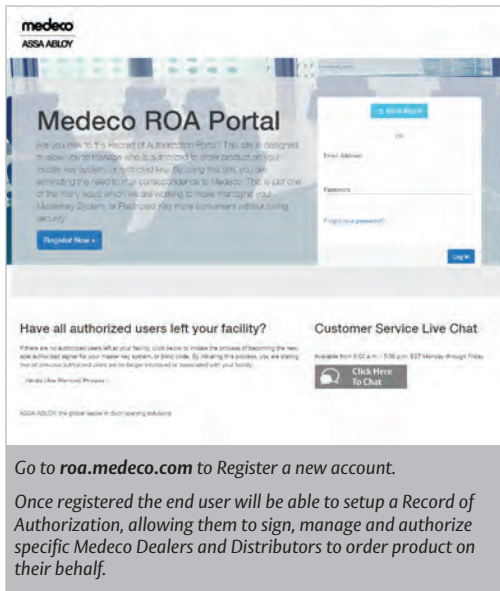

Medeco is working to improve customer experience by streamlining the order authorization process.

Medeco's Record of Authorization (ROA) Portal reduces order processing time by allowing an authorized end-user to sign, manage, and authorize ordering restricted Medeco products such as key blanks and pinned cylinders with a few clicks of a button. The ROA portal also allows an end-user to authorize another purchaser on their behalf, instantly.

Using the ROA portal, you can set up what type of product you're authorizing the Medeco dealer or distributor to order on your behalf: cut keys, pinned product, and/or key records. You can select more than one, or all the options.

You can also add another authorized user under your available registry numbers and/or restricted key codes by selecting the +Add Authorized user button, and providing the email address for the additional authorized signer you would like to add. A live chat function is simply a click away if you have any questions.

The Record of Authorization process via the ROA portal is legally binding and carries the same contractual agreement as a physical letter of authorization. For more information, visit our website or contact the Medeco Customer Care Department.

Register

- Go to ROA.medeco.com and click the "Register Now Button"
- Fill in the required field in the registry form

Note: Information required includes the key system registry number or restricted key code. If the registry number or key code is unknown, click the "Where to Find" button to see where the information can be found. If the registry number or key code still cannot be determined, contact customer service via the Live Chat button or call **877-633-3261** for assistance. Once registration is submitted and approved, an email is sent to the authorized user confirming registration.

Medeco Security Locks
3625 Alleghany Drive
Salem, VA 24153
877.633.3261

www.medeco.com
customerservice.medeco@assaabloy.com

Features:

- Protects against unauthorized duplication of your keys.
- Simplifies the restricted product and key order authorization process without compromising your security.
- Fast, Reliable & Accurate – allows immediate changes to authorization.
- Easily add and remove additional authorized signers within your facility.
- Easily add and remove authorization for a Medeco Dealer/Distributor to purchase on your behalf.
- Speeds up the authorization process.
- Establish a time-constrained record of authorization.
- Set up order-specific authorization for one-time purchase.
- Integrated Chat functionality.

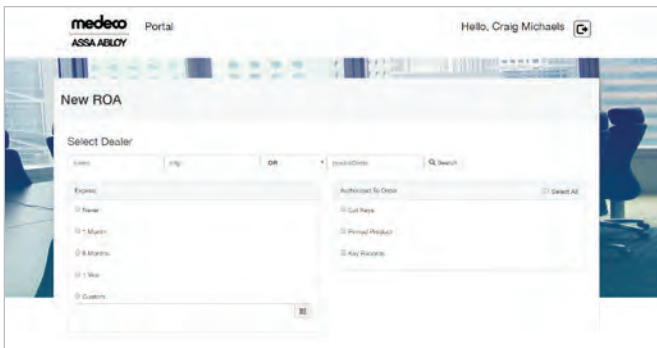

Log In

Use established credentials to log in to the site and begin setting up authorizations. Once logged in, all restricted key codes and registry numbers associated with the account will be displayed. If not all systems and/or codes are visible, contact customer service for assistance.

Set Up Authorizations

Click on "View Authorization" next to the appropriate key code or registry number to set up the record of authorization for that system. Several options for establishing records of authorization will be displayed. They include:

Add ROA

Use to establish a time-constrained ROA, including a blanket authorization.

- Select the dealer to be authorized to purchase on your behalf via the search bar.
 - Select the expiration of the authorization: Never (blanket), 1 month, 6 months, 1 year or custom date.
 - Select what type of product will be purchased on your behalf: cut keys, pinned product, and/or key records.
- Click "Add ROA" to complete the authorization

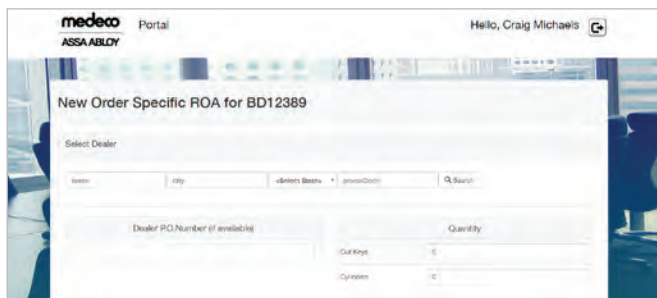

Order Specific ROA

Use to establish a one-time use record of authorization to allow a dealer or distributor for a specific order.

- Select the dealer to be authorized to place the one-time order on your behalf via the search bar.
- If known, provide the Purchase Order (P.O.) number the dealer or distributor will associate with the order.
- Indicate the quantities of the cut keys and/or cylinders that will be ordered.
- Click "Add ROA" to complete the authorization (**Note** the Order Specific ROA will expire after one use and cannot be used as a "blanket" (non-expiring) authorization.

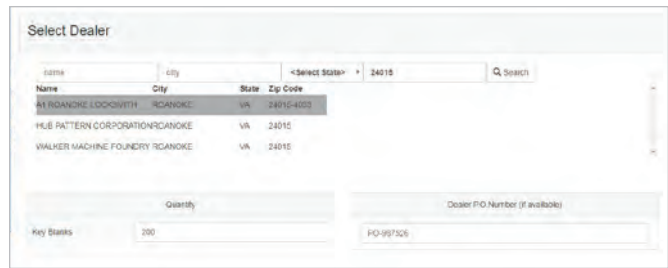

Authorize Keyblanks

Use to establish authorization for a contracted Medeco Dealer or Distributor to purchase keyblanks on your behalf.

- Select the dealer to be authorized to place the order for keyblanks on your behalf via the search bar.
- Specify the quantity of keyblanks that will be authorized for purchase.
- If known, provide the Purchase Order (P.O.) number the dealer or distributor will associate with the order.
- Click "Add ROA" to complete the authorization.

Removing/Adding Authorizations

Once "Add ROA" has been selected, authorization has been established for the Medeco dealer or distributor to order on your behalf. The authorization will remain in effect until expired or will continue indefinitely in the case of a blanket authorization. Authorization to order can be removed at any time.

Remove an Authorization

Use to remove a dealer or distributors authorization to order on your behalf.

- Click the "X" beside the ROA for the dealer or distributor you want to remove. This ROA is now cancelled and will need to be completed again to re-establish.

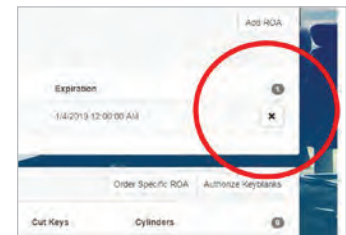

Add an additional authorized user

Additional authorized users within your facility can be added

to restricted key codes or registry systems at any time. There is no limit to the number of authorized users, but Medeco recommends keeping only the minimum number of individuals required as active users for security purposes.

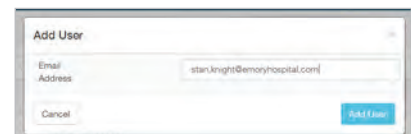

To add a new user:

- Click "+ Add Authorized User" button.
- Provide the email address for the additional authorized user.

The Record of Authorization process via the ROA portal is legally binding and carries the same contractual agreement as a physical letter of authorization.

For more information, visit our website or contact the Medeco Customer Care Department at: customerservice.medeco@assaabloy.com.

Provide All of the Needed Information to Avoid Delays!
Use the Medeco Checklist to Submit Clean Orders for Faster Processing

Medeco Order Checklist for All Orders

- | | |
|----------------------------------------------------|----------------------------------------------|
| <input type="checkbox"/> Account Number | <input type="checkbox"/> Base Part Number |
| <input type="checkbox"/> Purchase Order Number | <input type="checkbox"/> Finish |
| <input type="checkbox"/> Billing Address | <input type="checkbox"/> Keyway |
| <input type="checkbox"/> Shipping Address | <input type="checkbox"/> Cam/Tailpiece |
| <input type="checkbox"/> Shipping Instructions | <input type="checkbox"/> Keying Instructions |
| <input type="checkbox"/> Special Pricing/Quote ID* | <input type="checkbox"/> Quantity |
| <input type="checkbox"/> Special Instructions | |

*The SP or quote number must be referenced on the order.

Any invoiced order that has the incorrect discount applied to it and did not have the SP or quote number written on the order will have a service fee of \$100.00 net DEDUCTED from any sales credit issued for the difference in the discount.

Master Key Checklist

- | | |
|--------------------------------------------------------|------------------------------------------------------------|
| <input type="checkbox"/> New Master Key System: | <input type="checkbox"/> Existing Master Key System |
| <input type="checkbox"/> Master Key Request Form | <input type="checkbox"/> Registry Number |
| <input type="checkbox"/> Name of End User | <input type="checkbox"/> Name of End User |
| <input type="checkbox"/> Electronic Key Schedule | <input type="checkbox"/> Electronic Key Schedule |
| <input type="checkbox"/> Serialization Instructions | <input type="checkbox"/> Serialization Instructions |
| <input type="checkbox"/> Stamping Instructions | <input type="checkbox"/> Stamping Instructions |
| <input type="checkbox"/> Letters of Authorization | <input type="checkbox"/> Letters of Authorization |

M³ CLIQ™ Checklist

- | | |
|-------------------------------------------------|-------------------------------------------------|
| <input type="checkbox"/> New System: | <input type="checkbox"/> Existing System |
| <input type="checkbox"/> End User Name | <input type="checkbox"/> System Number |
| <input type="checkbox"/> End User Email Address | <input type="checkbox"/> End User Name |
| <input type="checkbox"/> Time Zone | <input type="checkbox"/> End User Email Address |
| | <input type="checkbox"/> Time Zone |

Medeco XT Checklist

- | | |
|-------------------------------------------------|-------------------------------------------------|
| <input type="checkbox"/> New System: | <input type="checkbox"/> Existing System |
| <input type="checkbox"/> End User Name | <input type="checkbox"/> System Number |
| <input type="checkbox"/> End User Email Address | <input type="checkbox"/> End User Name |
| | <input type="checkbox"/> End User Email Address |

Hybrid Checklist

- Site Code
- Serial Number

U.S. Customers – Door Security

Phone: 877-633-3261

Mailing address:

Medeco Security Locks, Inc.

P.O. Box 3075

Salem, VA 24153

Attn: Door Security Customer Service

Fax: 800-421-6615

To submit orders:

orders.medeco@assaabloy.com

To email Customer Service:

customerservice.medeco@assaabloy.com

To email Technical Support:

techsupport.medeco@assaabloy.com

Hours of operation:

Monday – Thursday, 8:00 a.m. – 6:00 p.m. ET

Friday, 8:00 a.m. – 5:00 p.m. ET

Canada Customers

Phone: 905-532-4970

Toll-free (in Canada only) 1-888-633-3264

Mailing address:

Medeco Canada

160 Four Valley Drive

Vaughan, ON L4K 4T9 CANADA

Fax: 905-532-4971 or

1-888-263-3326 (in Canada only)

E-mail: orders.medeco.ca@assaabloy.com

Hours of operation:

Monday – Friday, 8:00 a.m. – 4:30 p.m. ET

**Customers Outside the U.S.
(Not including Canada)**

Phone: +1 540-380-1741

or +1 877-633-3261

Fax: +1 540-380-1634

Mailing address:

Medeco Security Locks, Inc.

P.O. Box 3075

Salem, VA 24153

Attn: International Customer Service

E-mail: export@medeco.com

Submit Orders:

orders.medeco@assaabloy.com

Hours of operation:

Monday – Friday, 8:00 a.m. – 5:00 p.m. ET

Medeco Shipping & Returns Policies**Pricing:**

All published prices are subject to change without notice and are not guaranteed. All shipments will be made at prices prevailing at time of shipment. We reserve the right to correct typographical, clerical, editorial, pricing, quantity, or any other errors in this or any publications produced by Medeco Security Locks, Inc. without prior written notice or disclaimer.

**Changes/Cancellations
of Orders Policy:****– Order Changes:**

Changes made to orders after order acknowledgement or scheduling will result in a 10% change fee.

– Rescheduling orders and delayed shipments (blanket purchase orders):

Orders will be scheduled by agreement. However, orders may be rescheduled or delayed by Customer within 7-days (1 week) of initial acknowledgement without a change fee. Orders rescheduled or delayed after the 7-day period will be subject to a 10% change fee. Notification of rescheduling or delay must be in writing via email and can be sent to **orders.medeco@assaabloy.com**. Please reference the order number.

– Order cancellations:

Cancellation of orders after order acknowledgement/scheduling shall result in a 10% cancellation fee. If an order or a portion of an order is cancelled and products have already been manufactured and prepped for shipping, a 50% restocking fee will apply.

Shipping Charges:

For most U.S. customers, published freight rates will apply. Contact Medeco Customer Service for more information about Medeco's shipping and handling charges.

Freight:

All U.S. orders are shipped FOB origin: When delivered to the Transportation Company, Purchaser assumes risk of loss or damage in transit.

Customers Outside the U.S.:

Due to specific taxes, import/export fees, and exchange rates, pricing and shipping will vary from U.S. list prices for customers in Canada and elsewhere outside the United States.

Note: Some products may not be available in Canada as well as some of the programs offered in this price book may differ between the USA and Canada. Please contact your sales representative for more information.

Product Returns:

Medeco accepts product returns if the product is defective from a manufacturing flaw. If you need to make a return, fill out the enclosed RGA Form and fax it to:

In USA: 800-421-6615**In Canada:** 888-263-3326

or email to:

In USA:

orders.medeco@assaabloy.com

In Canada:

Outside the USA (except Canada):

orders.medeco.ca@assaabloy.com

The RGA Number must be visible on the outside of any package returned to Medeco.

Damaged Goods:

All orders are carefully filled, checked, and packaged. However, on rare occasions, a package may be damaged in transit. If this occurs, please make note of it on the delivery receipt before signing. To return merchandise that was damaged during the shipping or delivery process, call Medeco Customer Service.

Partial Shipments:

If all items on your order are not available at the time your order is processed, you must specify whether you want Medeco to hold the shipment until it is complete or send partial shipments as items are available. Orders received without specific shipping instructions will be filled at the discretion of Medeco.



Returned Goods Authorization Request

Medeco USA:
3625 Alleghany Drive
Salem, VA 24153
Phone: 800-839-3157 Fax: 800-421-6615

Medeco Canada:
160 Four Valley Drive
Vaughan, ON L4K 4T9
Phone: 888-263-3326 Fax: 888-263-3326

Date _____

RGA #

Account #

Customer Name

Contact Phone

Ship Address

Contact Fax

City, State, Zip

Sales Rep

Contact Name:

Original Order # or Cust. PO#	Line no.	Quantity	Product (Complete Part Number)	Detailed Reason for Return

\$

If Master Key product, provide required information:

*Registry Number #:

If CLIQ product, provide required information:

*CL #:

**End User's Name:

Key Markings:

***End User's Email:

Cylinder Markings:

****Time Zone:

If Medeco XT product, provide required information:

*CO #:

**End User's Name:

***End User's Email:

Action Requested:

Return product for FULL credit; no re-order.

Replace product returned on this RGA with the product listed below:
(RGA Number is new purchase order no.)

Quantity	Complete Part Number	Quantity	Complete Part Number

Customer's Error or out of Warranty:

Return product for credit less re-stock fee (50%) ; customer pays freight.

Explain reason for request:

In USA: Fax your RGA Request form to 800-421-6615 or Email to orders.medeco@assaabloy.com
In Canada: Fax your RGA Request Form to 888-263-3326 or email to orders.medeco.ca@assaabloy.com

Medeco® Standard and Extended Warranty Mechanical & Intelligent Key Products

Medeco Security Locks Inc. (“Medeco”) warrants to the original purchaser of a Medeco branded lock, lock cylinder, or Intelligent Key hardware product (referred to collectively as “Product”) to be free of defects in material and/or workmanship for a period of two (2) years from the date of original purchase for use. This Warranty may also apply to other specific products. For additional Warranty information or Warranty claim service, contact Medeco Customer Service at (877) 633-3261 or in Canada (888) 633-3264.

An Extended Warranty for Intelligent Key products is available for purchase. Please contact your local Medeco Representative for additional details.

In the event of a defect in material or workmanship during the Warranty period, Medeco will repair or replace (at its option) the Product under the conditions of this Warranty, this action being the sole remedy available to the purchaser under this express limited Warranty.

Limitations, Exclusions and other Rights:

- a. Medeco disclaims liability for implied warranties, including but not limited to those of merchantability or fitness for any particular purpose.
- b. Medeco disclaims liability for indirect, incidental or consequential damage at any time.
- c. Intelligent Key batteries are not covered under this warranty or any extended warranty.
- d. This Warranty gives specific legal rights, and a buyer may also have other rights that may vary from state to state. Some states do not allow limitations on indirect, incidental, and consequential damages or implied warranties so that the above limitations may not fully apply.
- e. Medeco mechanical keyblanks are made from a special nickel silver alloy. Medeco warrants its mechanical keys against defects in workmanship or breakage for the life of the Product. Bitted Medeco keys must be precisely cut to exact angles and depths, and require special duplication. This Warranty shall be void and Medeco disclaims liability of any kind in the event any key other than a genuine Medeco key has been used with the Product or that the key has been cut on any machine other than a Medeco or Medeco-approved key cutting machine.
- f. Medeco CLIQ Intelligent keys are covered for one (1) year against breakage (mechanical blade only).
- g. Medeco shall not be held responsible for product complaints or product damage arising from, in its sole judgment, and absence of user training, improper installation, failure to provide normal maintenance, extreme environmental conditions, use rates in excess of the industry standards defined for the type of product, use of incompatible parts or products not made or authorized by Medeco, or application of force not resulting from normal use.
- h. Unless otherwise specified by separate warranty, finishes are warranted for a period of two years following purchase for use. This finish Warranty shall be considered void after installation if, in the sole judgment of Medeco, the damage to the finish is the direct result of extreme climatic conditions, chemical or abrasive actions.

Medeco 4 (M4) Suggested Architectural Specifications

All lock cylinders are to be of a high security, pick resistant design with angled key cuts, rotating tumblers, a key mounted movable element, and a side biting with sidepin locking mechanism, all interacting with sidebar locking. Cylinders shall be Underwriters Laboratories Listed Standard--UL437--for key locks. Cylinders shall be certified under American National Standards Institute (ANSI)/Builder's Hardware Manufacturer's Association (BHMA) certification A156.30 2020 (High Security Cylinders Products), "Levels M1AAAM," and ANSI/BHMA A156.5 2020 (Certified Auxiliary Locks & Associated Products) "Grade 1."

All cylinders shall incorporate three locking elements, consisting of a sidepin mechanism with sidebar locking, tumbler rotation with sidebar locking, and split pin tumbler elevation. The critical parts of the locking mechanism such as pins, shear line, sidebar, and sidepin mechanism shall be afforded extra protection from drilling and other forceful attack by the strategic placement of hardened steel inserts in at least 8 possible locations within the cylinder. The lock tumblers shall combine a dual-axis action, with one axis utilized for pin tumbler rotation and the other axis utilized for positioning key cuts. Randomly selected tumbler pins shall incorporate a hardened steel insert or material hardening for additional drill protection.

The locking system is to be furnished in a restricted key section for which keys are not made available from the manufacturer's factory or any other source by normal distribution methods and without proper authorizations. The key and cylinder must have utility patent protection to protect against unlawful key duplication. The keys must have a movable element to further resist key duplication or replication. The key system, keys, and cylinders must be capable of being furnished to allow an upgrade to either of a dual mechanical and electronic cylinder and credential or a dual technology key by the single exchange of a field removable key bow. The key thickness should be no less than .125" (one hundred, twenty-five thousandths).

The manufacturer shall have the capability of establishing a key system with a minimum of six angle cuts in six possible pin positions with the capability of two distinct positions of cut per pin chamber, if required by the parameters of the key system. The system shall be capable of incorporating a key that is capable of more than one bitting per position to expand master keying and key changes. The key shall also incorporate the capacity to include up to four possible side bittings along the key blade. The system shall also have the capability to provide a single master key with over 1,000,000 (1 million) usable, non-interchanging, change keys on a single keyway profile.

The cylinders shall be immediately rekeyable to new combinations or a new key system as necessary and shall be serviceable in the field. Installation of cylinders shall be available for a majority of U.S. and international commercial grade lock brands and types, and require no modification to operate properly. Cylinder brand shall be supported by a nationwide US professional dealer network and worldwide distribution network. The locking system established for this project shall be proprietary and the owner shall furnish the manufacturer a list of those persons and their signatures that will be authorized and required to order additional pinned materials or duplicate keys. Orders not bearing authorized signatures shall not be filled.

All master keys and bitting lists for this project shall be sent using appropriate shipping carriers from the factory directly to the owner. Prior to shipment of keys, the owner shall verify in writing preference for shipping carrier.

Cylinders for new construction projects shall be available with construction keying or temporary interchangeable cores as appropriate and necessary.

Medeco³ Suggested Architectural Specifications

Furnished cylinders must provide the capability of a high security, patented, pick- and attack-resistant design with angled key cuts, rotating tumblers, a keyway side bitting, and a slider mechanism. Cylinders shall provide the option of certified listing to Underwriters Laboratories Listed Standard--UL437--for key locks. Cylinders shall provide the option of certification under American National Standards Institute (ANSI)/Builder's Hardware Manufacturer's Association (BHMA) certification A156.30 2007 (High Security Cylinders) "Levels M1AAAM," and ANSI/BHMA A156.5 2010 "Grade 1."

The furnished key system must allow the capability to combine within the same key system, and using the same patent-protected keys, high security rated cylinders as described above, with non-high security rated cylinders providing greater economy within a single master key system. Furthermore, the furnished key system shall allow the incorporation of software-controlled, electro-mechanical cylinders ("eCylinders") with the capability of utilizing the same credential and a single key system controlling both mechanical cylinders and eCylinders.

All cylinders with the high security option shall incorporate three locking elements, consisting of a slider mechanism, a sidebar mechanism with tumbler rotation, and pin tumbler elevation. The critical parts of the locking mechanism such as pins, shear line, sidebar, and slider mechanism shall be afforded extra protection from drilling and other forceful attack by the strategic placement of hardened steel inserts in a minimum of 7 possible locations within the cylinder. The lock tumblers shall combine a dual-axis action, with one axis utilized for pin tumbler rotation and the other axis utilized for positioning key cuts. Randomly selected tumbler pins shall incorporate a hardened steel insert for additional drill resistance.

All cylinders with the non-high security option shall incorporate two locking elements, consisting of a slider and sidebar combination, and conical tip, pin tumbler elevation.

The locking system is to be furnished in a restricted key section for which key blanks are not made available from the manufacturer's factory or any other source by uncontrolled distribution methods. The key and cylinder must have utility patent protection so as to hinder unlawful or unauthorized key duplication. Such patent protection shall be afforded in the United States of America, Canada, Mexico, and a plurality of other countries. The keys and key blanks must be capable of being furnished to allow an upgrade to a dual mechanical and electronic credential by the single exchange of a field removable key bow. The key blank thickness should be no less than .125" (one hundred twenty-five thousandths).

The manufacturer shall have the capability of establishing a key system with a minimum of six angled cuts in six possible pin positions with the capability of two distinct positions of cut per pin chamber, if required by the parameters of the system. The manufacturer shall have the capability of producing a patent-protected keying system in either of two distinct and different keying specifications and pinning specifications. The system shall be capable of incorporating a key which is capable of more than one bitting per position to expand master keying and key changes. The key shall also incorporate the capacity to include twelve possible side bittings along the key blade located on two different planes or surfaces of the key. The system shall also have the capability to provide a single master key with over 1,000,000 (1 million) usable, non-interchangeable change keys in a single profile.

The cylinders shall be immediately rekeyable to new combinations or a new system at any time desired and shall be serviceable on location in the field. Installation of cylinders shall require no modification to U.S. manufactured commercial-grade locksets.

The locking system established for this project shall be proprietary, and the owner will furnish the manufacturer a list of those persons and their signatures that will be authorized and required to order additional pinned materials or duplicate keys. Orders not bearing authorized signatures shall not be filled.

All master keys and bitting lists for this project shall be sent using appropriate shipping carriers from the factory directly to the owner. Prior to shipment of keys, the owner shall verify, in writing, preference for shipping carrier and destination.

Medeco X4 Architectural Product Specifications

Cylinders shall be of the knob, rim, mortise, or interchangeable core type. All cylinder components (excluding tumbler pins) shall be constructed of machined extruded brass. All cylinders, cores and housings shall be available in all standard architectural finishes and shall match the cylinder housing and lock and door hardware. Further, cylinders and housings shall be plated, not scalped with the appropriate finish.

Cylinders to be of the 6- or 7-pin tumbler type, providing the maximum unique, non-interchangeable key combinations respectively. All cylinders shall incorporate two locking elements consisting of pin tumbler elevation and a slider mechanism. Further expansion of a master key system shall be available by use of additional multiplex keyways. Cylinders shall not lose any combinations due to MACs (maximum adjacent cut) loss.

All cylinders shall use a .150" space dimension between tumbler pin chambers and shall be capable of using industry-standard tumbler pins. Cylinder shall contain standard pins, a portion of which (both bottom and top pins) shall be spooled to resist pick attacks.

All non-I/C rim and mortise cylinders shall be so constructed to use threaded set screws, not staked covers or caps, to cover each individual tumbler pin chamber.

All cut keys, key blanks and cylinders (knob, rim, mortise, and interchangeable core-type) shall be so constructed to be capable of being keyed in the same system, allowing the convenience of one master key to operate all types of listed cylinders. Further, the key or key blank's tip shall be so constructed to correctly locate the bits of the key beneath the proper chamber of an interchangeable core cylinder by locating against a key stop on the rear core. Additionally, the key or key blank's shoulder shall serve as a stop to correctly locate the bits of the key beneath the proper plug chamber of rim, mortise and knob-type cylinders by locating against the front face of the cylinder. The key blank thickness should be no less than .093" (ninety-three thousandths).

All cut keys and key blanks shall be utility patented and controlled by a contract between the end user and the manufacturer. Key blanks for this project shall be delivered directly from the factory to the end user unless otherwise requested in writing by the end user.

All keys must be capable of being configured to allow an upgrade to a dual mechanical/electronic credential by the simple exchange of a field-removable key bow.

The key shall incorporate the capacity to include eight possible side bittings along the key blade, located on two different planes or surfaces of the key.

All key blanks shall be custom coined with the end user's name or other unique identification mark. All cut keys and key blanks are to be constructed from nickel silver.

All keys shall be capable of being cut by a punch machine that originates the exact cut in the key from the code sheet, instead of using patterns.

Cylinders shall be immediately rekeyable to new combinations or a new system at any time desired and shall be serviceable on location in the field. Installation of the cylinders shall require no modifications to U.S. manufactured commercial-grade locksets.

The locking system established for this project shall be proprietary, and the owner will furnish the manufacturer a list of those persons and their signatures that will be authorized and required to order additional pinned materials or duplicate keys. Orders not bearing authorized signatures will not be filled.

All cylinders, cores, housings, keys and key blanks shall be made in the USA.

Medeco®

Professional Services for Intelligent Key Systems

To achieve optimum performance of your new intelligent Key System, Medeco recommends professional design and implementation services. Services include system planning, system deployment, team training and on-going support.

Medeco Professional Services: Making the most out of your investment



Over our 50 year history, Medeco has established a reputation for developing high-quality products that provide unparalleled security. Yet, high-quality products alone do not guarantee a successful deployment. To achieve optimum performance of your new intelligent Key System, Medeco recommends professional design and implementation services.

Medeco Professional Services includes a variety of offerings that will help you gain additional value from your technology investment. Professional Services include:

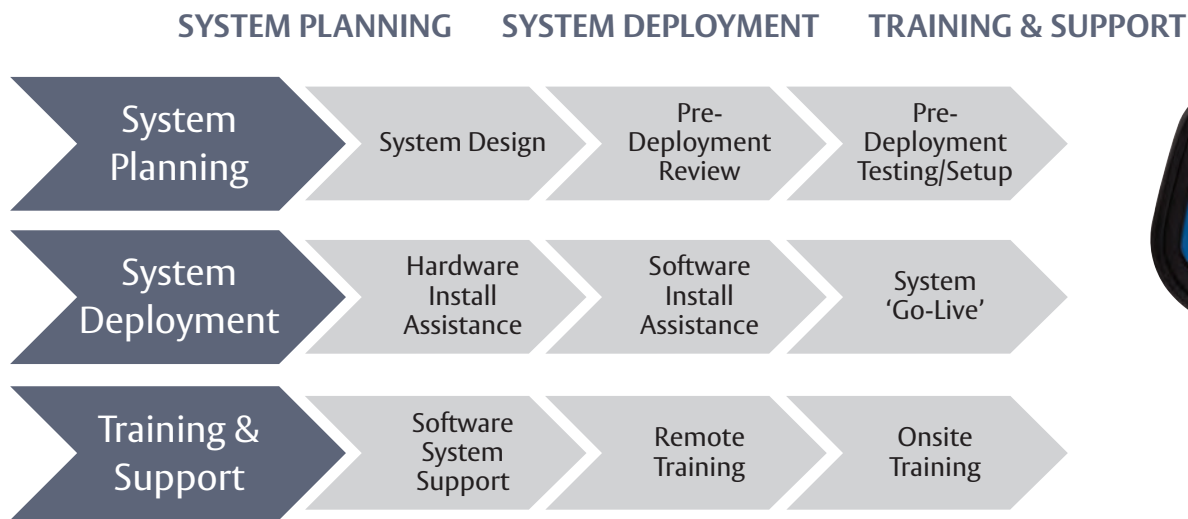

Professional Services – Intelligent Key Systems

System Planning Services



Medeco Professional Services offers consulting services that leverage industry best-practice to plan, scope and help design Medeco solutions that meet your organization compliance, security and risk management needs. Our consulting services packages have been designed to be delivered under the leadership of a dedicated project manager.

All prices shown are U.S. LIST and subject to dealer software buying program discount.

Remote Planning Support	SW-501Remote	\$665.00/hr 1 hour minimum
<ul style="list-style-type: none"> • System Design Assistance • Hardware Requirements 	<ul style="list-style-type: none"> – Ensure that your system is designed with your current and future interests in mind. – Determine the required hardware to meet your implementation goals. 	
Onsite Planning Support	SW-501Site	\$5,047.00/day plus T&E
<ul style="list-style-type: none"> • Pre-Deployment Meetings • Bench-Top Deployment and Validation 	<ul style="list-style-type: none"> – Live in person coordination of events and timeline planning. – Full functionality testing of hardware in a test environment to ensure complete satisfaction before deployment. 	

System Deployment Services



The Medeco Professional Services team includes dedicated technical consultants and software engineers who will work closely with your in-house team to assist in the deployment and integration of Medeco solutions and third-party systems.

This highly skilled group of systems engineers, integrators and project management experts will oversee the implementation of your new Intelligent Key System from start to finish. All technical complexities and any risks will be identified up front so that your system is designed to grow according to your needs – *now and into the future.*

Remote Deployment Services	SW-502Remote	\$665.00/hr 1 hour minimum
<ul style="list-style-type: none"> • Remote Software Installation • Remote Software Upgrades 	<ul style="list-style-type: none"> – Live online assistance with software installation to ensure complete functionality. – Using our remote access software we will ensure that your software upgrades go without issue, including data conversions. 	
Onsite Deployment Services	SW-502Site	\$5,047.00/day plus T&E
<ul style="list-style-type: none"> • Equipment Configuration • Software Installation / Upgrades 	<ul style="list-style-type: none"> – The assistance you need to get all of your equipment programmed and installed in a timely manner. – No need to worry about software installation, we will be there to perform this task for you. 	

Training & Support Services



Prior to deployment of your new system, we highly recommend Medeco technical training for your business security team. We offer a variety of customized hands-on training courses to teach your team how to properly operate, customize and support your new Intelligent Key System.

Our experts will work side-by-side with your team to give them a running start, enabling your new system to operate at peak performance on Day One. If there's ever an issue, we'll provide fast, professional and cost-effective assistance by phone, email or online.

The Medeco Professional Services team can also help ensure your system's optimum performance by providing on-site support for long-term engagements on a day-to-day basis.

By providing ongoing expert consultancy, Medeco consultants can expedite troubleshooting and help you define risk mitigation strategies during upgrades of Medeco solutions, allowing you to reduce training costs for your staff.

Enterprise System Support – Silver	SW-504Silver	\$3,320.00 Annually
<ul style="list-style-type: none"> • Enterprise System Support – Silver 	<ul style="list-style-type: none"> – Software System Support; Extended phone support: 6AM-8PM EST Monday - Friday; 2 hour response time to email requests; Real-time phone support - up to 35 tickets annually. 	
Enterprise System Support – Gold	SW-504Gold	\$4,648.00 Annually
<ul style="list-style-type: none"> • Enterprise System Support – Gold 	<ul style="list-style-type: none"> – Software System Support; Extended phone support: 6AM-10PM EST Monday – Friday; 1 hour response time to email requests; Real-time phone support – Up to 50 tickets annually. 	
Enterprise System Support - Platinum	SW-504Platinum	Call for Quote
<ul style="list-style-type: none"> • Enterprise System Support – Platinum 	<ul style="list-style-type: none"> – Software System Phone Support for Emergency/Severity 1 issue resolution; – Extended phone support: available 24 hours a day, 7 days a week (in English); Up to 75 tickets annually. 	
Remote Training	SW-503Remote	\$665.00/hr 1 hour minimum
<ul style="list-style-type: none"> • Web Based Training • Additional Training Based on New Staff/Turnover 	<ul style="list-style-type: none"> – Online training setup to meet your planning schedule. – Online training to help you keep up with new staff requirements. 	
Onsite Training	SW-503Site	\$5,047.00/day plus T&E
<ul style="list-style-type: none"> • Hands-on Training • Detailed Product Installation Classes 	<ul style="list-style-type: none"> – In depth face to face training for our hardware and software applications. – On site classes to train your employees on site specific hardware installation. 	

All prices are U.S. LIST, and subject to dealer software discounting. T&E charges will be quoted upon request.

The Medeco Professional Services team will work closely with your company's in-house team to assist with your new system's planning and design, deployment & integration, and on-going support and training. Together, we will ensure that your new Medeco Intelligent Key System is up and running on Day One and operating at peak efficiency.

Professional Services – Mechanical Security

Training Certification Classes	SW-505Site	\$5,047.00/day plus T&E
---------------------------------------	-------------------	------------------------------------

Personalized on-site factory technical certification class(es).

Medeco will conduct field training, demonstrate sample equipment, and certify students on service, maintenance, and support. These are the same certification classes given at factory and trade shows. Various classes available including Medeco³, Medeco x4, Medeco XT, CLIQ and Medeco Master Keying — see training catalog for further details.

Master Key Consultation	SW-506Site	\$5,047.00/day plus T&E
--------------------------------	-------------------	------------------------------------

Master key system design consultation with a Medeco key system design expert.

In person key system design consultation with a system design expert. We will assist you in the development of a master key system to meet your design specifications. The system will be uniquely tailored to your facility, resulting in custom Key System Schematics, biting lists and pinning charts.

Key Management Consultation	SW-507Site	\$5,047.00/day plus T&E
------------------------------------	-------------------	------------------------------------

Assistance in the design, implementation, customization, and best practices for sound key control.

Assistance in the design, implementation, customization, and best practices for sound key control products and key management policies and procedures that will minimize liabilities and extend key system lifespan. A key system investment will be maximized by deploying these sound key management practices.

Installation Inspection	SW-508Site	\$5,047.00/day plus T&E
--------------------------------	-------------------	------------------------------------

Project product installation and operation inspection and certification.

Professional Services Warranty

Professional Services Warranty. Deliverables Warranty. Medeco represents and warrants that: (a) the Professional Services will be performed in a professional and workmanlike manner with a degree of care, skill and competence that is consistent with generally accepted industry standards reasonably expected of similar types of engagements; and (b) free from defects in workmanship if applicable; and (c) the Deliverables will substantially conform to the description and specifications set forth in the Medeco published catalog, price book, or written quotation, for **a period of thirty (30) days** after the date of delivery (“Warranty Period”), provided Medeco receives written notification of the non-conformity during the applicable Warranty Period. To the extent any Professional Services or Deliverables do not, in Medeco’s sole determination, substantially conform to the foregoing warranties Medeco shall promptly re-perform the Professional Services and/or re-submit the Deliverables. If, after receiving notice of non-conformity, Medeco determines that the Professional Services cannot be performed or the Deliverables cannot reasonably be delivered, pursuant to an accepted purchase order or written quotation, 100% due to Medeco’s sole fault, Medeco may elect to promptly refund the fees paid (less accrued expenses) or waive the fees owed, with respect to such Professional Services or Deliverable, as Customer’s sole and exclusive remedy. This warranty will apply only if: (a) the Deliverable(s) have been properly incorporated, installed, or utilized by or on behalf of Customer at all times and in accordance with all instructions or documentation; and (b) no modification, alteration or addition has been made to the Deliverable(s) other than with Medeco’s written consent; and (c) Medeco receives written notification of and approves of the warranty claim during the applicable Warranty Period.

THE EXPRESS WARRANTIES FOR PROFESSIONAL SERVICES SPECIFIED HEREIN ARE EXCLUSIVE AND TAKE THE PLACE OF AND SUPERSEDE ALL OTHER WARRANTIES, WHETHER EXPRESS OR IMPLIED, INCLUDING WARRANTIES OF MERCHANTABILITY OR FITNESS FOR A PARTICULAR PURPOSE.

Medeco® XT

Medeco® XT Intelligent Key System

Building on Medeco's 50-year history of creating high security key control products, the Medeco XT Intelligent Key Eco-system takes key systems to a completely new level.

Medeco XT adds security, regulatory compliance and accountability to practically every opening in a fast, efficient way. A Medeco XT Eco-system enhances businesses by providing the valuable data and tools needed to be more profitable or meet compliance requirements.

Overview: The Medeco XT Eco-System consists of a robust electronic locking and access control system that is managed by state-of-the-art web based system software.

Medeco XT overcomes current keying issues by keeping security high even if someone loses a key.

Medeco XT also adds access control capability in hard to reach areas such as safes, cabinets, gates (padlocks), etc. In addition, with the new AIM (Access Interface Module) Device, imagination is your only limitation regarding what to control next with your XT key.



Audit Accountability

Audit information recorded in both the lock and key shows a time- and date-stamped record of every event, including authorized accesses and unauthorized attempts.



Uses Existing Hardware

Medeco XT key provides all power to the cylinder, eliminating the need for any hardwiring or power supply. Simply remove the existing mechanical cylinder and install the Medeco XT cylinder.



Reduces Risk of Lost Keys

Respond quickly to security threats, lost or stolen keys, or personnel changes without the added cost of changing your locks and keys.



Electronic Scheduling

Keys are electronically programmed to open only specific locks during a designated schedule. Schedules may also contain an expiration point to completely disable the key until it is audited and reprogrammed.



Medeco Data Dashboard

System audit data is displayed in a new graphical way on the Medeco dashboard. The 'Glances' display consists of several mini-dashboards that provide insight into your system configuration and audit events.



Data Analytics

The Visual Audit feature of Medeco XT Web manager software converts audit data into a simple graphic dashboard. Security Administrators can see access trends and irregularities at a glance!

Key Features:

- Small, robust electronic key with stainless steel housing
- Intelligent key holds all access and schedule data
- Rechargeable battery, up to 1,800 openings per charge
- Heavy-duty stainless steel construction
- Stand-alone, network, Web and mobile programming options

Warranty:

Medeco Security Locks warrants Medeco XT products to be free of defects in material and/or workmanship for a period of two (2) years from date of original purchase (except where noted). Extended warranty available at time of purchase, see page 15 (Warranty Information) for additional information.

Product Specifications:

Lock / Cylinder Features

- No wiring required—all power provided by the key
- Indoor / outdoor use—stainless steel shell construction
- 2,000 audit events
- Unauthorized key list
- Variety of retrofit cylinder formats

XT Software and Options:

XT Software and Options: The Medeco XT Web Manager software is an integral part of the Medeco XT Eco-System. The software not only helps manage the XT Intelligent Key System in flexible and cost-effective manner, but also provides business-enhancing tools.

The XT Web Manager SaaS (Software as a Service) software is available as either a Medeco-hosted or End-user hosted option. The Medeco-hosted option takes advantage of the power, convenience and security of Amazon Web Services (AWS) and is offered in several pricing levels. This option offers high-availability, secure web access, no start-up fees, and a multitude of AWS optional services to meet any customer's needs.

All Admin functions are handled by trained and certified IT personnel. Medeco holds ISO 27001 Certification for internal information and asset security.

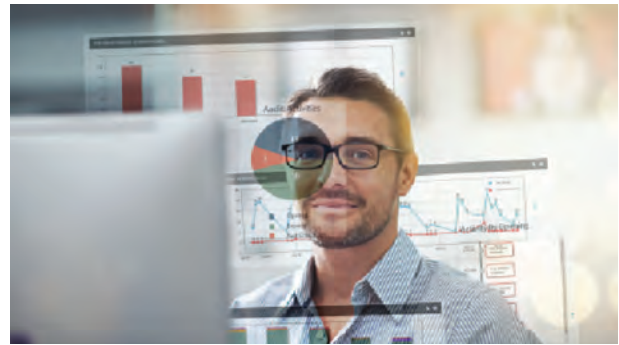

Description	Part Number	Annual License Fee
Enterprise Plus: Designed for systems larger than (+1500 keys).	Note: Depends on options and # of keys	Call for pricing
Enterprise: Designed for large systems. Limit 1500 keyholders.	SW-500301-4	\$5,025.00
Advanced: Designed for mid-size systems. Adds Remote & Mobile programming & extended schedules to the Basic version. Limit 750 keyholders.	SW-500301-3	\$3,071.00
Basic: Designed for smaller systems: Effectively manage your XT Intelligent Key system with all the basic functionality which includes Schedules, Audit, Groups, Data Dashboard & Visual Audit. Limit 250 keyholders.	SW-500301-2	\$977.00
<p>Web Hosting custom options available at additional cost include: Dedicated Server for very large) systems, regulatory compliance configurations, database archiving, Country/Region customization and more. Please contact your local Medeco sales rep for more information.</p> <p>Multi-year hosting available. Contact your sales representative.</p>		
<i>These offerings are billed annually.</i>		

Medeco XT Self-Hosted Software

These systems are set up and hosted by the End-User: End-User is responsible for supplying all necessary hardware & expertise for server set up, maintenance, backups, etc...

See Professional Services section for assistance with configuration and set up of your XT system.

Description	Part Number	One-Time Fee	Annual Fee
*XT Enterprise Self-Hosted Software. All the features of the Advanced version along with support for very large systems plus more advanced and/or future functionality.	SW-600901-1	\$46,635.00	
Enterprise Self-Hosted Annual Recurring Maintenance Fee – receive all software updates and bug fix releases, installation support, and an additional software license for a test server.	SW-600901-1R		\$6,995.00
*XT Advanced Self-Hosted Software: for mid to large systems. Includes features such as Remote and Mobile programming, Visual Audit, Who has Access reporting, etc.	SW-600901	\$21,318.00	
Advanced Self-Hosted Annual Recurring Maintenance Fee – receive an additional software license, software updates and bug fixes and installation support.	SW-600901-R		\$3,199.00
*XT SOLO – Same interface as our XT Web based software but designed for standalone applications. Does not support Remote or Mobile programming.	SW-500301-1	\$1,298.00	
XT SOLO Software Maintenance Fee – receive software updates and installation support for same	SW-500301-1R		\$259.00
<i>Maintenance fees are billed annually.</i>			
<p>Self-hosted software purchases entitle the user to a single user license with no annual license fees. Recurring maintenance is recommended and provides an additional license for test server, regular software program updates, maintenance releases, patches, and basic level technical telephone assistance. Customers who are not paying the recurring maintenance fee but that wish to upgrade their XT Web Manager software must contact their dealer or Medeco Representative for a quote. Note: Medeco Tech support cannot support software versions that are over two years old without the addition of Professional Services</p>			

* Also requires the purchase of a system setup dongle. Part number EA-250059.

Note: API Interface for 3rd party integrations available. Contact your local sales representative for more details.

Medeco® XT Intelligent Keys

Medeco® XT Electronic Locking Systems

The Medeco XT keys are small, robust, convenient and portable. They are built to withstand even the toughest environments.

The Medeco XT keys have dynamic memory which can adjust the number of audit transactions and cylinder access the key can store. Medeco XT keys also utilize a rechargeable battery and can be purchased with a portable charger to ensure you are never locked out due to a dead battery. The key provides feedback to indicate when a charge is required.

There are two key models in the XT line. The 'Slim Line' key is designed for just about every application except those extreme and abusive environments, where the 'Rugged' key is recommended.



G3R Rugged* Key Features:

- Hardened stainless steel housing that will stand up in the toughest environments
- Portable and rechargeable
- Top-mounted LED for convenient access feedback

G3R Rugged* Key Applications:

The XT Rugged key was designed for users that want a small, robust credential that will stand up to the most extreme environments. Tested for drop, shock and temperature extremes.

Slim Line Key Features:

- Polished, hardened stainless steel frame for strength and durability
- Soft-touch coating
- Dual-LED indicators for greater visibility
- Raised orientation dimples (allow for feeling the orientation of the key) for easier use
- High-capacity memory

Slim Line Key Applications:

The XT Slim Line key was designed for users that want a small, light credential that will not sacrifice on durability. Created to stand up to all but the most extreme environments but designed to be one of the most portable and desirable keys on the market!

Bluetooth Key Features:

- Utilizes Bluetooth Smart Technology
- Program keys from any location (within cellular coverage area)
- No need to 'dock' key to program
- LED programming feedback indicates when key is connected to the mobile device
- Works with the latest XT Web Manager software



NEW: Slim Rugged*



- Intelligent to access up to 16k locks and store 10k audit events
- Extremely durable
- Stainless steel and aluminum construction
- Support for remote and mobile programming
- Rechargeable

*Rugged key available April 2022

Slim Line S



- Higher intelligence to support more advanced features
- Enhanced user experience with faster processing and programming speeds

Slim Line B Bluetooth Key



- All the Slim Line S features and...
- Program anywhere
- Bluetooth communication built-in
- Smartphone app support
- Immediate upload/download of data (if desired)
- New version with 3 week battery life now available.

See page 41 for additional details and technical information.

Intelligent Key Cabinet (IKC)

The Intelligent Key Cabinet is a complete, electronically-controlled, key management solution that can secure, distribute and audit the use of XT Keys, mechanical keys, or other assets. Only authorized users can gain access to the cabinet via the included biometric fingerprint reader or PIN code pad, or a combination of both. An optional access card reader is also available. IKC is available in configurations to store mechanical keys, XT electronic keys or a combination of both. As an essential addition to any Medeco XT Intelligent Key system, it locks XT keys in place and keeps them charged and ready for use. The IKC can improve employee efficiency and increase accountability which translates into a more secure facility with lower operating costs.



Benefits:

- **Accountability:** No more wondering who has checked out keys or for how long. Complete audit trail and reporting by user and key activity. User accountability reduces lost keys. Fewer lost keys leads to lower expenses and improved security.
- **Analytics:** Identify potential problems in removal and return patterns before they escalate. Complete reporting suite provides multiple reporting options to provide real-time data. Reports can be automatically generated and sent to multiple users by email. Custom reports can be configured and exported to Excel for added convenience.
- **Security:** Loose keys are vulnerable to being misplaced or stolen. Only authorized users are able to access the electronic key management system. Biometric Fingerprint, PIN, and/or Prox Card authentication (optional) allow access to the IKC for added security and control. The IKC supports dual authentication if desired. For added security, a digital photo capture of each login can be added.
- **Convenience:** Allow employees to retrieve keys quickly without waiting for a manager. Quick, easy-to-use web-based or locally hosted software shows what keys are in, what keys are out, and to whom they are issued. The IKC allows the return of any key to any location in the cabinet, and then learns the key's new location.
- **Productivity:** Eliminate time spent searching for, or replacing lost keys – always know who took which key, and when.
- **Efficiency:** Pair with a full XT solution to identify patterns and workflows to gain even greater efficiency and security. XT version cabinets charge and program keys while they are secured and stored, ensuring keys are always ready to go.

Features:

- New and improved Graphical User Interface
- Available in 2 cabinet sizes in 32 and 64 port options
- Scalable solution with add-on cabinets and panels
- Integration with XT Web Manager (XT & Hybrid versions only) for complete control of XT key distribution and programming
- XT and iFob versions
- 32 port cabinets must be either all XT or all iFob ports
- 64 port cabinets can be all XT, all iFob or a combination of 32 XT plus 32 iFob
- Built-in XT IPD programmer
- Securely stores and charges XT keys (XT version)
- Identifies XT key serial number (XT version)
- Fingerprint reader
- Built-in LCD screen for ID
- Supports 2 factor authentication
- Audible and visual alarms
- SMS messages
- Email messages
- Camera for security photo capture
- Comprehensive reporting & analytics
- Emergency Fob Release System
- Multi-System Networking
- Medeco high security mechanical lock for manual override
- Optional: Smart card reader, stand

Intelligent Key Cabinet (IKC)

Standard Cabinet

LCD touchscreen used for PIN code authentication, warning messages as well as PC troubleshooting

High security mortise cylinder for manual override

Event Camera

XT Programming Port

Biometric Fingerprint Reader

Mini Cabinet

Add-On Cabinet

High security mortise cylinder for manual override

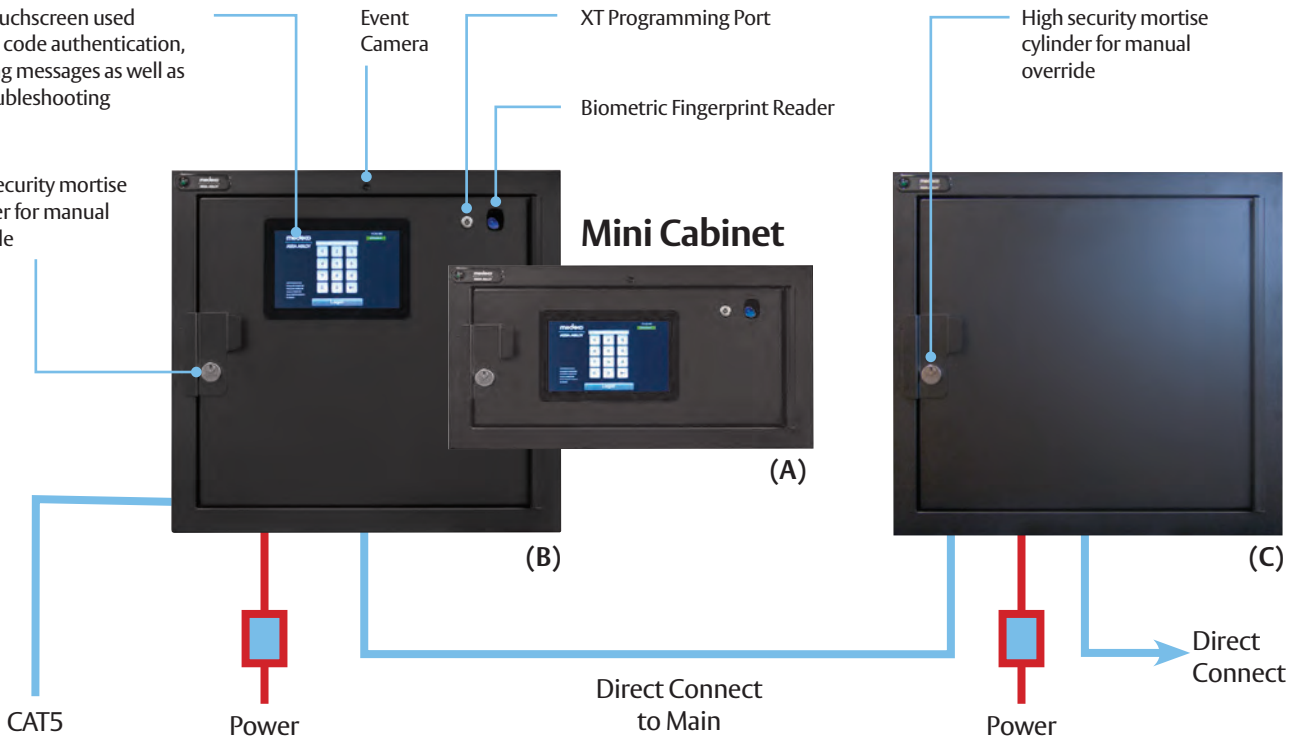

Scalability:

The IKC system can grow as business needs grow by adding on additional secondary cabinets in either 32 or 64 port sizes and in a combination of technologies (iFob or XT).

- Each system requires one 'Main' touchscreen cabinet
- Add additional cabinets as needs require
- System can be any combination of 32 or 64 port cabinets
- 32 port cabinets support either XT or iFob ports
- 64 port cabinets support either all XT, all iFob, or a combination of 32 XT plus 32 iFob.
- Main and Secondary boxes can be configured with same technology or different
- Up to 7 Add-on units maximum (512 keys) for every Main unit

Mini Cabinet (Image A):

- Main Cabinet (Image A) 27" W x 14.72" H x 12" D
- Can be stand alone or connected to Add-on cabinet
- Technology – Select All XT or All iFob
- Main and Add-on cabinets can be configured with same technology or different

Standard Cabinet (Image B):

- Main Cabinet (Image B), 32 or 64 ports, 27" W x 25.25" H x 12" D
- Can be stand alone or connected to secondary cabinet
- Technology – Select All XT, All iFob, or 32 XT plus 32 iFob
- Main and Add-on cabinets can be configured with same technology or different

Add-on Cabinet (Image C):

- Add-on Cabinet (Image C), 27" W x 25.25" H x 12" D
- Available with 32 or 64 ports
- 32 port option expandable to 64 with additional 32 port panel (sold separately)
- Must be connected to a Main cabinet

Intelligent Key Cabinet (IKC)

How to Order:

<p>1</p> <p>EA-100199 Base Part #</p> <p>Refer to page 30 for descriptions and technical specifications to find the corresponding base part number.</p>	<p>2</p> <p>M Main Cabinet</p> <p>M = Main Cabinet A = Add On</p>	<p>3</p> <p>D Input Device</p> <p>D = Multi-Class Card Reader U = Customer Supplied Input 0 = No Input Device*</p> <p>*Note: Input options available on Main cabinet units only.</p>	<p>4</p> <p>1 With Stand</p> <p>0 = No Stand 1 = With Stand</p>
---------------------------------------------------------------------------------------------------------------------------------------------------------------------------	-----------------------------------------------------------------------------------------	----------------------------------------------------------------------------------------------------------------------------------------------------------------------------------------------------------------	---------------------------------------------------------------------------------------

EXAMPLE: 32 PORT XT MAIN CABINET, INPUT DEVICE, WITH STAND

EA-100199 - M D 1

Base Number for Intelligent Key Cabinet (IKC)

Base Numbers:

- EA-100199-XXX – 32 port XT standard
- EA-100236-XXX – 32 port iFob mini
- EA-100237-XXX – 32 port XT mini
- EA-100247-XXX – 64 port XT standard
- EA-100248-XXX – 32 port iFob standard
- EA-100249-XXX – 64 port iFob standard
- EA-100250-XXX – 32 XT/32 iFob Combo

Stand Options

0 = No Stand
1 = With Stand

External Input Options

D = Multi-class Card Reader
U = Customer Supplied Input
0 = No Input Device*

Cabinet Type (Main or Add-on)

M = Main Cabinet
A = Add On (Note: Add-on cabinets not available in mini size)

Intelligent Key Cabinet



Mini Cabinet



Standard Cabinet



Add-On Cabinet

Part Number	Ports	Type Standard or Mini	Description	Price
EA-100237-M00	32	XT - mini	Mini-cabinet, 32 port XT main, no input, without stand	\$26,827.00
EA-100237-MD0	32	XT - mini	Mini-cabinet, 32 port XT main, Multi-class reader input, without stand	\$27,927.00
EA-100237-MU0	32	XT - mini	Mini-cabinet, 32 port XT main, customer-supplied input, without stand	\$27,267.00
EA-100237-M01	32	XT - mini	Mini-cabinet, 32 port XT main, no input, with stand	\$28,202.00
EA-100237-MD1	32	XT - mini	Mini-cabinet, 32 port XT main, Multi-class reader input, with stand	\$29,302.00
EA-100237-MU1	32	XT - mini	Mini-cabinet, 32 port XT main, customer-supplied input, with stand	\$28,642.00
EA-100236-M00	32	iFob - mini	Mini-cabinet, 32 port iFob main, no input, without stand	\$19,659.00
EA-100236-MD0	32	iFob - mini	Mini-cabinet, 32 port iFob main, Multi-class reader input, without stand	\$20,759.00
EA-100236-MU0	32	iFob - mini	Mini-cabinet, 32 port iFob main, customer-supplied input, without stand	\$20,099.00
EA-100236-M01	32	iFob - mini	Mini-cabinet, 32 port iFob main, no input, with stand	\$21,034.00
EA-100236-MD1	32	iFob - mini	Mini-cabinet, 32 port iFob main, Multi-class reader input, with stand	\$22,134.00
EA-100236-MU1	32	iFob - mini	Mini-cabinet, 32 port iFob main, customer-supplied input, with stand	\$21,474.00
EA-100199-M00	32*	XT	32 port XT main cabinet, no input, no stand	\$26,827.00
EA-100199-MD0	32*	XT	32 port XT main cabinet, Multi-class card reader input, no stand	\$27,927.00
EA-100199-MU0	32*	XT	32 port XT main cabinet, customer-supplied input, no stand	\$27,267.00
EA-100199-M01	32*	XT	32 port XT main cabinet, no input, with stand	\$28,202.00
EA-100199-MD1	32*	XT	32 port XT main cabinet, Multi-class card reader input, with stand	\$29,302.00
EA-100199-MU1	32*	XT	32 port XT main cabinet, customer-supplied input, with stand	\$28,642.00
EA-100199-A00	32*	XT	32 port XT add-on cabinet without stand	\$16,265.00
EA-100199-A01	32*	XT	32 port XT add-on cabinet with stand	\$17,640.00
EA-100247-M00	64	XT	64 port XT main cabinet, no input, without stand	\$32,381.00
EA-100247-MD0	64	XT	64 port XT main cabinet, Multi-class card reader input, without stand	\$33,481.00
EA-100247-MU0	64	XT	64 port XT main cabinet, customer-supplied input, without stand	\$32,821.00
EA-100247-M01	64	XT	64 port XT main cabinet, no input, with stand	\$33,756.00
EA-100247-MD1	64	XT	64 port XT main cabinet, Multi-class card reader input, with stand	\$34,856.00
EA-100247-MU1	64	XT	64 port XT main cabinet, customer-supplied input, with stand	\$34,196.00
EA-100247-A00	64	XT	64 port XT add-on cabinet without stand	\$24,763.00
EA-100247-A01	64	XT	64 port XT add-on cabinet with stand	\$26,138.00
EA-100248-M00	32*	iFob	32 port iFob main cabinet, no input, without stand	\$19,659.00
EA-100248-MD0	32*	iFob	32 port iFob main cabinet, Multi-class card reader input, without stand	\$20,759.00
EA-100248-MU0	32*	iFob	32 port iFob main cabinet, customer-supplied input, without stand	\$20,099.00
EA-100248-M01	32*	iFob	32 port iFob main cabinet, no input, with stand	\$21,034.00
EA-100248-MD1	32*	iFob	32 port iFob main cabinet, Multi-class card reader input, with stand	\$22,134.00
EA-100248-MU1	32*	iFob	32 port iFob main cabinet, customer-supplied input, with stand	\$21,474.00
EA-100248-A00	32*	iFob	32 port iFob add-on cabinet, without stand	\$13,970.00
EA-100248-A01	32*	iFob	32 port iFob add-on cabinet, with stand	\$15,345.00
EA-100249-M00	64	iFob	64 port iFob main cabinet, no input, without stand	\$27,378.00
EA-100249-MD0	64	iFob	64 port iFob main cabinet, Multi-class card reader input, without stand	\$28,478.00
EA-100249-MU0	64	iFob	64 port iFob main cabinet, customer-supplied input, without stand	\$27,818.00
EA-100249-M01	64	iFob	64 port iFob main cabinet, no input, with stand	\$28,753.00
EA-100249-MD1	64	iFob	64 port iFob main cabinet, Multi-class card reader input, with stand	\$29,853.00
EA-100249-MU1	64	iFob	64 port iFob main cabinet, customer-supplied input, with stand	\$29,193.00
EA-100249-A00	64	iFob	64 port iFob add-on cabinet, without stand	\$17,520.00
EA-100249-A01	64	iFob	64 port iFob add-on cabinet, with stand	\$18,895.00
EA-100250-M00	32/32 COMBO	XT/iFob	64 port combo main cabinet, no input, without stand	\$31,077.00
EA-100250-MD0	32/32 COMBO	XT/iFob	64 port combo main cabinet, Multi-class card reader input, without stand	\$32,177.00
EA-100250-MU0	32/32 COMBO	XT/iFob	64 port combo main cabinet, customer-supplied input, without stand	\$31,517.00
EA-100250-M01	32/32 COMBO	XT/iFob	64 port combo main cabinet, no input, with stand	\$32,452.00
EA-100250-MD1	32/32 COMBO	XT/iFob	64 port combo main cabinet, Multi-class card reader input, with stand	\$33,552.00
EA-100250-MU1	32/32 COMBO	XT/iFob	64 port combo main cabinet, customer-supplied input, with stand	\$32,892.00
EA-100250-A00	32/32 COMBO	XT/iFob	64 port combo add-on cabinet, without stand	\$23,459.00
EA-100250-A01	32/32 COMBO	XT/iFob	64 port combo add-on cabinet, with stand	\$24,834.00

* Expandable to 64 total ports with addition of 32 port panel (Sold separately). See page 31 for more details.

IKC Software Options

Part Number	Description	Price
SW-500141	Medeco-hosted software for IKC, up to 5 cabinets, billed annually	\$880.00
SW-500141-1	Self-hosted software for IKC, one-time purchase	\$880.00
SW-500141-1R	Annual maintenance fee for IKC self-hosted software, billed annually	\$165.00

Intelligent Key Cabinet Accessories



Cabinet Stand



Medeco iFob



Multi-Class Reader

Description	Part Number	Price
Key Cabinet Stand	EA-300239	\$1,506.00
Medeco iFob	EA-300242	\$79.00
6" Cable Seals (price is per cable seal)	EA-300245	\$7.23
Multi-Class reader, includes install and configuration	EA-250066	\$1,204.00
Spare XT Panel	EA-300244	\$8,141.00
Spare iFob Panel	EA-300243	\$6,493.00

Medeco® XT Access Interface Module (AIM)

The Medeco® XT Access Interface Module – known as “AIM” – allows the user to insert their Medeco XT key to trigger actions in other systems. Using both authorized and unauthorized event conditions, users can unlock doors with electric strikes or maglocks, initiate video cameras and bring attention to unauthorized events by triggering access control or alarm panels.



AIM Features:

- Greatly enhances the capability of the Medeco XT Intelligent Key System
- Key audit tracks events just like an XT cylinder
- Two-person authentication option
- Uses NO – Normally Open and NC – Normally Closed relays to trigger different outputs for Access Granted or Access Denied events
- Can be powered by an XT key or 12-24V Power Supply depending on AIM connection

Warranty:

Medeco Security Locks warrants Medeco® XT products to be free of defects in material and/or workmanship for a period of two (2) years from date of original purchase.

Applications:

Medeco XT AIM module can be used with other Access Control or Alarm Panels to trigger authorized and unauthorized event conditions.

Medeco XT Access Interface Module (AIM):

Description	Part Number	Price
Medeco XT Access Interface Module	EA-100192	\$752.00



Medeco® XT

Medeco XT Traffic Cabinet Lock

The Medeco XT Traffic Cabinet Lock helps to secure our critical infrastructure. The Intelligent Traffic System (ITS) cabinets located at every street corner contain hardware that control our cities streets. Cyber attack is a constant threat. A simple retrofit lock solution like the Medeco XT Traffic Cabinet Lock is the quickest, most cost-effective way to add the accountability necessary to help eliminate tampering with the advanced equipment contained within these cabinets.

Available through authorized resellers only.



Medeco XT Traffic Cabinet Lock:

Description	Part Number	Price
XT Traffic Cabinet Lock – Deadbolt*	EA-100221	\$411.00
XT Traffic Cabinet Lock – Slam bolt*	EA-100220	\$431.00
High Security Mechanical Traffic Cabinet Lock - Deadbolt*	490435	\$213.00
High Security Mechanical Traffic Cabinet Lock - Slambolt*	490436	\$213.00

* Can be installed in left-hand or right-hand doors.

XT Safe Lock

The Medeco XT Safe Lock is a direct replacement for physical security devices that utilize standard mechanical dial combination locks or digital keypad locks. XT Safe Lock includes a reader with key port mounted on the outside of the safe door, and is available three XT lock configurations deadbolt, spring bolt and swing bolt.

To access the safe, an XT Key is programmed via the Medeco XT Web Management Software system to only open a specific XT Safe Lock and the key is issued to a specific user. The user inserts the XT Key into the key port on the exterior reader. Power is supplied by the key to the lock PCB and authentication is initiated with a secure process over the interface communications cable.

An LED provides visual feedback to the user on the current state of the lock. If the lock PCB and XT Key are in agreement that access is granted, the lock PCB will provide power to the internal motor/bolt blocker and the user is allowed to rotate the key to unlock the lock. If the XT Key is not authorized, the user will be prevented from unlocking the safe lock.



XT Safe Lock:

Description	Part Number	Price
XT Safe Lock – Deadbolt Lock Bundle	EA-100206	\$820.00
XT Safe Lock – Spring Bolt Lock Bundle	EA-100207	\$820.00
XT Safe Lock – Swingbolt Lock Bundle	EA-100208	\$820.00

Medeco® XT

XT Guard Tour Reader

The Medeco XT Guard Tour Reader is a simple, yet powerful, user tracking solution that can be added to any XT Intelligent Key system. The reader mounts easily to any interior or exterior flat surface and programs just like a standard XT cylinder. As the designated 'Tour' individual makes their rounds, they simply touch the reader with their XT key which creates an audit event that proves they completed this task. A record of activity is available for audit or reporting at any time.



XT Guard Tour Reader

Description	Part Number	Price
XT Guard Tour Reader	EA-100240	\$391.00

XT Cylinders

For availability of cylinder formats not shown, contact Technical Support.

XT Rim and Mortise electronic cylinders are a simple and direct replacement for mechanical cylinders. Ideal for loss & liability management with flexible authorization and auditing capabilities.

Respond quickly to security threats, lost or stolen keys, or personnel changes without the added cost of changing your locks and keys. Medeco XT is a complete electronic locking system providing controlled access, accountability, physical security, and system management with no wiring requirements.

Cylinders are available in many popular lengths and finishes to fit nearly any application in your office, business and retail applications.



Mortise Cylinder



Rim Cylinder

XT Rim and Mortise Cylinders

Description	Part Number	Price
Rim Cylinder, horizontal tailpiece	100400H G*	\$336.37
Rim Cylinder, vertical tailpiece	100400V G*	\$336.37
1 1/4" Mortise Cylinder	100500 G*	\$338.88
1 3/8" Mortise Cylinder	105100 G*	\$336.54

*Must specify cam (mortise) or tailpiece (rim) when ordering. See pages 76-77 for cam and tailpiece part numbers and descriptions. If not specified, Z01 cam will be supplied for mortise, Y02 tailpiece will be supplied with rim cylinders.

Medeco® XT Dual-Tech Cylinder

For Rapid-Entry Applications

The patent-pending Medeco XT Dual-Tech retrofit cylinder is designed for both accountability and rapid-entry applications. It combines two cylinder technologies – the Medeco XT electronic cylinder and the Medeco X4 mechanical cylinder – in one mortise cylinder housing. Both cylinders operate independently of one another so access is provided using either the XT Key or the X4 key.



Allows fire department emergency facility access using a familiar mechanical key while the XT Intelligent key is used for daily accountability. In multi-family applications, tenants use the mechanical key and maintenance uses XT key for accountability. Ideal for any application requiring a mechanical key override.

Medeco Dual Tech Cylinder

Description	Part Number	Price
XT Dual Tech 1-1/4" Mortise Cylinder, with Medeco X4	490423 G	\$529.00
XT Dual Tech 1-1/4" Mortise Cylinder for Arrow/Best	490426 G	\$529.00
XT Dual Tech 1-3/4" Mortise Cylinder	490437 G	\$535.00
XT Dual Tech Rim Cylinder	490432 G	\$797.00

XT Dual-Tech Cams

Dual Tech mortise cylinders come complete with a set of 2 specially designed cams, a direct-drive cam operated by the Medeco XT key and an Override cam operated by the Mechanical key. Cam type must be indicated when ordering (Z00, Z01, etc.)

Important Note: The standard cams listed on pages 76-77 cannot be used in Dual-tech cylinders.

Replacement cams must be ordered using the chart below. One each direct drive and override cam required per cylinder.

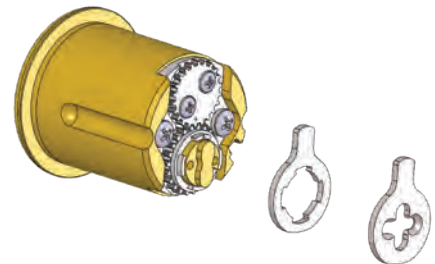

Dual Tech Cams

Description	Part Number	Price
Direct Drive Cam – Russwin	CP-100771-Z00	\$10.40
Override Cam – Russwin Type	CP-100781-Z00	\$10.40
Direct Drive Cam – Yale Type	CP-100771-Z01	\$10.40
Override Cam – Yale Type	CP-100781-Z01	\$10.40
Direct Drive Cam – Adams Rite	CP-100771-Z02	\$10.40
Override Cam – Adams Rite Type	CP-100781-Z02	\$10.40
Direct Drive Cam – Sargent	CP-100771-Z20	\$10.40
Override Cam – Sargent Type	CP-100781-Z20	\$10.40
Direct Drive Cam – Schlage	CP-100771-Z34	\$10.40
Override Cam – Schlage Type	CP-100781-Z34	\$10.40

Interchangeable Core Cylinders

XT Small Format Interchangeable Core (SFIC) is ideal for access management as a direct replacement for mechanical SFIC without any hardware modifications. An easy-to-upgrade solution, ready to install and use without wiring or power supply, XT SFIC is easily installed or removed to existing hardware with the simple use of a programmed control key. Users can audit keys, program a schedule and track who opens a lock and when – all while eliminating the cost of rekeying mechanical locks. Well suited for facilities with high turnover of employees, such as fast food restaurants, convenience stores, and similar businesses, but is also suitable for apartments, office buildings, schools, and hospitals. Available in custom finishes.



Available Finishes:
 06 - Satin Brass,
 12 - Satin Bronze,
 13 - Dark Bronze/Oil rubbed,
 BB - Matte Black,
 26 - Satin Chrome*
 *See finishes on page 223.

XT Small & Large Format Interchangeable Core

Description	Part Number	Price
Small Format Interchangeable Core (SFIC) Cylinder	EA-100108	\$360.00
Schlage Large Format Interchangeable Core (LFIC) Cylinder*	322201 G	\$343.21
Yale Large Format Interchangeable Core (LFIC) Cylinder* 6 pin	310100 G	\$345.72
Yale Large Format Interchangeable Core (LFIC) Cylinder* 7 pin	310100A G	\$345.72
Sargent Large Format Interchangeable Core (LFIC) Cylinder 6 pin	322401 G	\$347.82
Corbin Large Format Interchangeable Core (LFIC) Cylinder 6 and 7 pin (includes spacer)	322301 G	\$347.82

* Fits LFIC format housing, but is a one-time installation and not removable.

See page 108 for LFIC housings.

See page 118 for SFIC housings.

Key-In-Knob/Lever Cylinders

XT Key-in-Knob/Lever electronic cylinder is a direct replacement for mechanical KIK/KIL cylinders and is ideal for access control management. The cylinder requires no wiring to the door and is powered by the XT rechargeable key. Audit trail, user access schedules and the ability to quickly add or remove a key electronically from a system allow for fast response to security threats, lost or stolen keys, or personnel changes without the added cost of changing locks and keys. Designed for quick retrofit of nearly all popular brands of knob and lever-type cylindrical locksets, making them an ideal application for office doors, storage and file rooms, or residential doors: virtually any door where cylindrical hardware is used.



XT Arrow Cylinders

Description	Part Number	Price
Medeco XT cylinder for all Arrow RK & MK series knobs and GL series levers. For RK & MK series, replace original spacer with Medeco CP-160321 (included)	20200A1 G	\$341.04

XT Cylinders for Cal-Royal

Description	Part Number	Price
Cylinder for Cal-Royal Apollo series SL00 knob lock and LX01 lever lock	2020049 G	\$339.06
Cylinder for Cal-Royal CLS03 classroom function Gr. 2 lever lock	20200V1 G	\$339.06

XT Cylinders for Corbin Russwin

Description	Part Number	Price
Cylinder for Corbin 800 lever lockset CL3300, CL3400, CL3500 & CL3600	2020073 G	\$339.06
Cylinder for Corbin Russwin CL3900 series leversets	20200V9 G	\$339.06

XT Cylinders for Falcon

Description	Part Number	Price
Cylinder for Falcon B, LY, X, S & T series. Includes: CT-V03, CT-Y49, CT-Y54, CT-Y58, CTY68, CT-Y71, CT-Y72, CP-160311	20200F1 G	\$341.04
Cylinder for Falcon F521, F561, F581, and N series knobs	2020051 G	\$339.06
Cylinder for Falcon T-381 (inside)	2020073 G	\$339.06
Cylinder for Falcon T & RU series, T381 (exterior)	20200V3 G	\$339.06

XT Cylinders for KABA-Mas-Hamilton

Description	Part Number	Price
Cylinder for Kaba E-plex 5000	2020000 G	\$339.06
Cylinder for Mas-Hamilton Power Lever	20200V1 G	\$339.06

XT Cylinders for LSDA

Description	Part Number	Price
LSDA cylinder package fits 100, L100, LH1000, LX1000, Includes: CT-Y49, CT-Y70, CT-Y73, CTY78	20200L1 G	\$341.04

XT Cylinder for Marks

Description	Part Number	Price
Cylinder for Marks 110, 170, 180, 190, 195, 295 series Vestibule, Communicating, Classroom, & Classroom Security functions (DA, DC, SB, S).	20200V0 G	\$339.06
Cylinder for Marks Lever 110, 170, 180, 190, 195, 295 series in Entrance, Institution, Storeroom, and Corridor functions (AB, DW, F, T)	20200V1 G	\$339.06

XT Cylinders for Olympus

Description	Part Number	Price
Cylinder for Olympus 700 LCM & 800 LCM Key Retaining	20200S1 G	\$341.04

XT Cylinders for PDQ

Description	Part Number	Price
Cylinder for PDQ Lever SP & ST Series, GT, XGT, & GP Series	20200V2 G	\$339.06

XT Cylinders for Sargent

Description	Part Number	Price
Cylinder for Sargent 10 line locksets, order with '30' option prefix (note: cylinder will extend from lever more than standard cylinder)	20200S1 G	\$341.04

XT Cylinders for Schlage

Description	Part Number	Price
Cylinder Package for Schlage A, AL, C, D, ND & Olympiad lever designs, includes: CT-Y49 (A, AL, & D Olympiad Lever & C & D Plymouth), CT-Y52 (C & D heavy duty knobs Ball, Globe & Sphere designs only), CT-Y53 (A series Orbit), CT-Y73 (ND series Gr. 1 lever & AL thick doors), and CTY74 (45-101 padlock)	20200S1 G	\$341.04
Cylinder for Schlage S Series Lever	2020097 G	\$341.04

XT Cylinders for TACO

Description	Part Number	Price
Cylinder for Olympus 700 LCM & 800 LCM Key Retaining	20200S1 G	\$341.04

XT Cylinders for Yale

Description	Part Number	Price
Cylinder for Yale 6 pin 5300LN, 5400LN and 4300 Knobs	200503 G	\$339.06

Padlocks

XT padlocks are ideal for access management at off site or hard to reach locations. The robust cylinder with stainless steel components is designed for interior and exterior use. Keys are electronically programmed to open only specific locks during a designated schedule and audit information is recorded in both the lock and key. With no wiring or power supply required, XT padlocks are an ideal application for perimeter fences and gates, or access to equipment storage areas where traditional EAC is practically impossible to install.



The All Weather Padlock (AWP) is recommended for all outdoor applications to provide maximum protection and reliability.

XT Padlocks

Description	Part No.	Price
All Weather Padlock, 5/16" SS shackle, 1 7/8" Clearance	5005511 G	\$522.34
All Weather Padlock, 5/16" SS shackle, 2 3/8" Clearance	5005521 G	\$522.34
All Weather Padlock, 5/16" Boron shackle, 1 7/8" Clearance	5005531 G	\$522.34
All Weather Padlock, 5/16" Boron shackle, 2 3/8" Clearance	5005541 G	\$527.34
All Weather Padlock, 7/16" SS shackle, 2" Clearance	5005711 G	\$522.34
All Weather Padlock, 7/16" SS shackle, 2 1/2" Clearance	5005721 G	\$527.34
All Weather Padlock, 7/16" Boron shackle, 2" Clearance	5005731 G	\$522.34
All Weather Padlock, 7/16" Boron shackle, 2 1/2" Clearance	5005741 G	\$527.34
Hockey Puck Padlock	5293000 G	\$472.82
Indoor/Outdoor Padlock, Non-Key Retaining, 1 1/8" Shackle Clearance, 5/16" Shackle Diameter, w/Cylinder	5451500 G	\$464.50
Indoor/Outdoor Padlock, Key Retaining, 1 1/8" Shackle Clearance, 5/16" Shackle Diameter, w/Cylinder	54515R0 G	\$464.50
Indoor/Outdoor Padlock, Non-Key Retaining, 2 3/8" Shackle Clearance, 5/16" Shackle Diameter, w/Cylinder	5451F00 G	\$467.50
Indoor/Outdoor Padlock, Key Retaining, 2 3/8" Shackle Clearance, 5/16" Shackle Diameter, w/Cylinder	5451FR0 G	\$467.50
Shrouded Padlock, Non-Key Retaining, 3/4" Shackle Clearance, 5/16" Shackle Diameter, w/Cylinder	5452500 G	\$489.50
Shrouded Padlock, Key Retaining, 3/4" Shackle Clearance, 5/16" Shackle Diameter, w/Cylinder	54525R0 G	\$489.50
Indoor/Outdoor Padlock, Non-Key Retaining, 1 3/8" Shackle Clearance, 7/16" Shackle Diameter, w/Cylinder	5471500 G	\$494.50
Indoor/Outdoor Padlock, Key Retaining, 1 3/8" Shackle Clearance, 7/16" Shackle Diameter, w/Cylinder	54715R0 G	\$494.50
Indoor/Outdoor Padlock, Non-Key Retaining, 1 7/8" Shackle Clearance, 7/16" Shackle Diameter, w/Cylinder	5471F00 G	\$499.50
Indoor/Outdoor Padlock, Key Retaining, 1 7/8" Shackle Clearance, 7/16" Shackle Diameter, w/Cylinder	5471FR0 G	\$499.50
Shrouded Padlock, Non-Key Retaining, 3/4" Shackle Clearance, 7/16" Shackle Diameter, w/Cylinder	5472500 G	\$536.50
Shrouded Padlock, Key Retaining, 3/4" Shackle Clearance, 7/16" Shackle Diameter, w/Cylinder	54725R0 G	\$536.50
Protector II Large Body Padlock 7/16" shackle	5004732 G	\$567.24
Protector II Medium Body Padlock 5/16" shackle	5004734 G	\$539.02

Medeco XT Padlock Cylinders

Description	Part No.	Price
XT All Weather Padlock Cylinder	510800 G	\$295.42
XT System Series Padlock, Cylinder Only	510600 G	\$376.30
XT Pop-Out Cylinder for G8R Padlock – Round Deadbolt	EV-8501D	\$346.00
XT Pop-Out Cylinder for G8R Padlock – Round Springbolt	EV-8501S	\$346.00

Cam and Utility Locks

Medeco® XT cam locks are built for strong physical security and offer all the benefits of the XT Electronic Locking System. XT cam locks are available in lengths of 7/8" and 1-1/8" with a wide variety of cams and security collars. The cylinder is designed for interior and exterior use and requires no wiring or modification to the door. Audit information recorded in both the lock and key shows a time-and-date stamped record of every event, including authorized accesses and unauthorized attempts. A quick retrofit to existing hardware, XT cam locks are ideal for utility cabinets, retail fixtures, narcotics storage, safes and more.



XT Cam Locks

Description	Part Number	Price
7/8" Cam lock assembly, Key Retaining	EN-150002-XXX (Op Code)	\$346.00
1 1/8" Cam lock assembly, Key Retaining	EN-150003-XXX (Op Code)	\$346.00

Cam Lock Operation Codes

Description	Op Code
2 flat, 1 keypull, clockwise 90 degree	219
2 flat, 1 keypull, counter-clockwise 90 degree	239
2 flat, 1 keypull, clockwise 180 degrees	259

XT T-bolt Cylinders

Description	Part Number	Price
XT T-bolt – Key Retaining, unlocked at 180 degree	6280550 G -XX	\$339.94
XT T-bolt – Non-Key Retaining, unlocked at 360 degree	6282550 G -XX	\$339.94

XT Cam Lock

Description	Part Number	Price
1 1/8" Cam lock assembly, Non-Key Retaining	600650269 G -XX	\$342.96



XT Switch Locks

Description	Part Number	Price
2 Position, Key Retaining	6522560 G -121-XX	\$326.58
2 Position, Non-Key Retaining	6522560 G -122-XX	\$326.58

Retail/Showcase Locks

Medeco® XT has an electronic cylinder for many types of retail applications. Ideal for loss & liability management with flexible authorization and auditing capabilities. Respond quickly to security threats, lost or stolen keys, or personnel changes without the added cost of changing your locks and keys. The cylinder is powered by the rechargeable key so no wiring or power supply is needed. Medeco XT Plunger Locks are specifically designed for use in wooden or metal sliding doors. Cabinet style locks are also available and along with the plunger locks are ideal applications for security merchandise showcases, metal cabinets, and laboratory and office furniture.



XT Retail/Showcase Locks

Description	Part Number	Price
Cabinet Lock, Latchbolt	490359 G	\$432.00
Cabinet Lock, Deadbolt	490366 G	\$432.00
XT Deadbolt Cabinet Lock, KR	6210555 G XX	\$363.94
XT Deadbolt Cabinet Lock, NKR	6212555 G XX	\$363.94
XT Spring Latch Cabinet Lock	6211555 G XX	\$379.94
XT T Bolt Cam Lock, KR	6280550 G	\$339.94
XT T Bolt Cam Lock, NKR	6282550 G	\$339.94

International Cylinders

The Medeco® XT Modular Half Profile, Euro Double & Thumb Turn electronic cylinders are a direct replacement for like mechanical cylinders and are ideal for loss and liability management. In addition to international uses, many of these cylinders fit imported hardware used in North America. The cylinder requires no wiring or modification to the door or frame and is designed for interior and exterior use. Attack-resistant design and tamper-proof features provide strong protection against forced entry. Flexible key programming and auditing capabilities allow for quick response to security threats, lost or stolen keys, or personnel changes. Cylinders are widely used at government installations, airports, hotels, universities and schools. Medeco XT is a complete electronic locking system providing controlled access, accountability, physical security, and system management.



XT International Cylinders

Description	Part Number	Price
Lockwood Oval	230301S G	\$295.00
Cylinder Module EURO 1/2 Module - 30mm	232201S 300 G	\$269.76
Cylinder Module EURO 1/2 Module - 35mm	232201S 301 G	\$273.76
Cylinder Module EURO 1/2 Module - 40mm	232201S 302 G	\$277.76
Single/Double cylinder Module EURO 1/2 Module - 30mm	232202S 300 G	\$273.76
Single/Double cylinder Module EURO 1/2 Module - 35mm	232202S 301 G	\$273.76
Single/Double cylinder Module EURO 1/2 Module - 40mm	232202S 302 G	\$277.76
Euro T/T Profile - 30mm/30mm Assembled	23230XS X00 G	\$351.06
Euro T/T Profile - 35mm/35mm Assembled	23230XS X11 G	\$359.06
Modular Profile Cylinder - 30mm Half Profile - Assembled	232301S 800 G	\$314.85
Modular Profile Cylinder - 35mm Half Profile - Assembled	232301S 801 G	\$318.85
Euro 1/2 Profile 30mm Assembled (True 30mm)	232301ST 800 G	\$314.85
Euro Double Profile - 30mm/30mm Assembled	23230E5 X00 G	\$414.11
Euro Double Profile - 35mm/35mm Assembled	23230E5 X11 G	\$422.11

Specialty Cylinder Formats

The Medeco® XT Electronic T-handle Cylinders are an ideal for loss and liability management and are available for many specialty applications and formats. Pop-Out Cylinders are available in spring-latch and deadbolt configurations. Stainless steel shell and bolt for lasting strength, durability and strong protection against physical attack. Fits all NAMA Standard T-Handles. Ideal for vending & bottling, bill changers, ATM equipment or other custom OEM applications.



Specialty Cylinder Formats

Description	Part Number	Price
Ruko (inside)	230501S G	\$317.00
Ruko (outside)	230601S G	\$317.00
Snowman (padlock)	230801S G	\$317.00
Safe Deposit Box Lock – Left Hand	490428 G	\$339.94
Safe Deposit Box Lock – Right Hand	490429 G	\$339.94
Mul-T-Lock padlock (G47 Series)	490431 G	\$310.00
XT Insert For Enclosure Lock	EA-100219	\$405.00

Pop-Out Cylinders

Description	Part Number	Price
Pop-Out Cylinder Deadbolt assembly, round bolt	EV-8501D	\$346.00
Pop-Out Cylinder, springbolt assembly, round bolt	EV-8501S	\$346.00

Keys and Accessories

The Medeco® XT Key is a convenient, robust electronic key with a heavy duty stainless steel housing that fits right on your key ring. A portable key charger and rechargeable battery assures keys are always fully charged for up to 1,800 openings, eliminating the need for battery maintenance. Convenient key programming and flexible system management eliminates the need for removal of cylinder in order to make changes. This key holds operating and expiration schedule and flexible memory allocation lets the user decide how the memory is used; Access: up to 16,000 cylinders. Audit: up to 14,000 events. With Medeco XT, flexible authorization, auditing of use and quick retrofit to existing hardware are all available in one convenient package.



XT Keys

Description	Part Number	Price
XT Industrial Key (G2)	EA-100107	\$176.00
XT Slim Line Key Basic (G2)	EA-100156	\$133.00
XT Slim Line Key Plus (G3S)	EA-100178	\$161.00
XT Slim Line Key Bluetooth (G3B)	EA-100177	\$203.00
XT Rugged Slim Key (G3R)*	EA-100254	\$214.00
Slim Line Demo/Install Key (G2)	EA-100173	\$258.00
Slim Line Demo/Install Control Key (G2)	EA-100174	\$258.00

Medeco® XT Key Bundles

Description	Part Number	Price
XT Industrial Key (G2) & Charger Bundle. Includes XT Industrial Key, portable charger & USB cable	94-0239	\$229.00
XT Slim Line Key (G2) & Charger Bundle. Includes XT Slim Line Key, Charger and USB Cable	94-0271	\$202.00
XT Slim Line Key (G3S) Charger Bundle. Includes XT Slim Line Key, Charger and USB Cable	94-0307	\$221.00
XT Slim Line Key (G3B) & Charger Bundle. Includes XT Slim Line Key, Charger and USB Cable	94-0306	\$246.00
XT Rugged Key bundle (G3R)*	94-0325	\$260.00

	Slim Line (Gen 2)	Slim Line S (Gen 3)	Slim Line B (Gen 3)	Rugged (Gen 3R)*
Description	Redesigned to be smaller, lighter, increased LED visibility	Faster processor, faster communication, support for future functionality	Bluetooth version. Faster processor, faster communication, support for future functionality	Same functionality as G3S key with a rugged housing for increased durability.
Part Number	EA-100156	EA-100178	EA-100177	EA-100254
Size	2.65" x 1.25" x .55"	2.65" x 1.25" x .55"	2.65" x 1.25" x .55"	2.65" x 1.25" x .59"
Weight	1.25 oz.	1.25 oz.	1.25 oz.	1.25 oz.
Openings per charge	1500-1800	1500-1800	1500-1800	1500-1800
Durability	High	High	High	Very High
Memory	16,000 cylinders	14,000 cylinders	14,000 cylinders	14,000 cylinders
Audit	10,000 events	14,000 events	14,000 events	14,000 events
Battery Level Indicator	High/Low	Percentage	Percentage	Percentage
Warranty	2 years	2 years	2 years	2 years

* Rugged key available April 2022



IPD – Identification and Programming Device

Medeco XT Programmers

XT IPD	Part Number	Price
XT IPD - Identify, program and update Medeco XT Keys remotely via internet connection to Web Manager software		
XT IPD Base unit with power supply	EA-100242-000	\$1,807.00
XT IPD Base unit, desktop mount and power supply bundle	EA-100242-010	\$1,927.00
XT IPD Base unit, wall mount and power supply bundle	EA-100242-100	\$1,927.00
XT IPD Standoff Retrofit Kit - spacer kit for replacing existing Remote Programmer when mounted in a custom enclosure	EA-300241	\$84.30
XT IPD Replacement Touchscreen assembly	EA-100245	\$843.00
7/8" Cam Lock – Can be added to IPD for users to test keys. (Optional)	EN-150002-XXX	\$346.00

Genetec IPD®	Part Number	Price
Genetec IPD w/power supply	EA-100242-00G	\$1,807.00
Genetec IPD w/power supply and desk mount bundle	EA-100242-01G	\$1,927.00
Genetec IPD w/power supply and wall mount bundle	EA-100242-10G	\$1,927.00



Desktop Programmer

Desktop	Part Number	Price
XT Desktop USB Programming Station (order cable separately)	EA-100109	\$329.00



Mobile Programmer

Mobile	Part Number	Price
XT Mobile Programmer	EA-100125	\$983.00



Multi-Key Programmer/Charger

Multi-key	Part Number	Price
XT Multi-key Programmer/Charger	EA-100232	\$4,562.00

Medeco® XT Kits & Accessories

Description	Part Number	Price
XT Multi-Key Charger - Charge up to 10 Medeco XT Keys simultaneously (does not program keys)	EA-100138	\$753.00
XT Portable Key Charging Adapter only (order cable separately)	EA-100088	\$68.70
XT Key Wall Charger Kit	94-0291	\$122.00
XT Key Vehicle Charger Kit	94-0292	\$121.00
XT Key PC Kit (USB Cable and Charging Adapter)	94-0290	\$92.60
Smart SFIC Solutions Demo Kit (Includes Arrow, Medeco X4, and Medeco XT SFIC cylinders, keys, charger and cable)	940261	\$1,521.00
XT Try Me Demo Industrial Keys & SFIC with charger and USB cable - NOT PROGRAMMABLE	940264	\$983.00

Medeco® XT Maintenance and Protective Products

Description	Part Number	Price
Fluid Film, 2.25 oz	PK-KYLUBE-02	\$20.60
Fluid Film, 11.75 oz	PK-KYLUBE-11	\$32.80
Small Bristle Brush (non-metallic bristles) for cleaning cylinder & key contacts	CP-286180	\$31.00
Deoxit Contact Cleaning Pen (gold contact cleaner)	CP-301290	\$73.90
Metal cylinder protector cover	CP-287260	\$93.50
Plastic cylinder protector cover	CP-170930	\$69.30

Self-Hosted Software - End User Startup Checklist:

Description	Quantity	Part Number	Price
XT Programming Device	1	EA-100109	\$329.00
USB Cable	1	EA-200058	\$31.90
Enhanced USB System Dongle	1	EA-250059	\$96.80

Web Hosted Service - End User Startup Checklist:

Description	Quantity	Part Number	Price
XT Programming Device	1	EA-100109	\$329.00
USB Cable	1	EA-200058	\$31.90

Professional Services

Planning, design and support are crucial to the successful deployment of an Intelligent Key System. Medeco offers professional services to ensure every installation is planned and executed seamlessly, and the system works effectively to meet current and future needs to protect the investment. See page 21 for details and pricing.

Medeco M³ & X4 CLIQ[®]

Medeco M³ and X4 CLIQ merge the features of electronics with reliable mechanical technology – all in a retrofit cylinder. M³ and X4 CLIQ offer end users audit trail, user access schedules and the ability to quickly and remotely change intelligent key authorizations with the CLIQ Web Remote or CLIQ Connect App.

M³ and X4 CLIQ installs with no wiring in a matter of minutes. Intelligent keys and digital cylinders reprogram wirelessly for electronic master keying. CLIQ can be combined with systems featuring Medeco³, X4 or BiLevel mechanical products to offer a blended security solution.

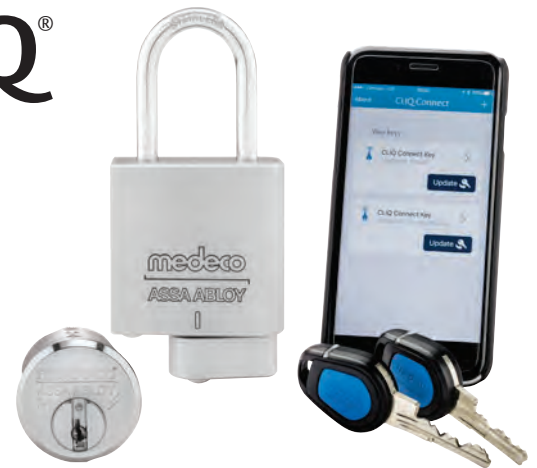

Audit Accountability

Audit information recorded in both the lock and key shows a time-and-date stamped record of every event, including authorized accesses and unauthorized attempts.



Uses Existing Hardware

The CLIQ intelligent key provides all power to the cylinder, eliminating the need for any hard wiring or power supply. Simply remove the existing mechanical cylinder and install the M³ or X4 CLIQ cylinder. CLIQ can be keyed in with Medeco mechanical systems featuring Medeco³ or BiLevel, Original or X4 (not available in SFIC).



Reduces Risk of Lost Keys

Respond quickly to security threats, lost or stolen keys, or personnel changes utilizing expiring intelligent key validation intervals and remote programming.



Electronic Scheduling

Intelligent keys are programmed for specific openings with fully flexible scheduling. Access profiles can be created where programming updates are generated automatically when an opening is added or removed.

Technical Information:

- **Audits:** Key capacity – 1,000 events
Cylinder capacity – 750 events
- **Management:** CLIQ Web Manager with Medeco Hosted or Self-Hosted License
- **Power:** Power supplied by the key, no hard wiring required
- **Weather Resistant:** Can be used in indoor or outdoor applications.
– Rated for -20°F to 122°F (cylinder)
- **Security:** Encrypted identification in cylinder and Intelligent key
- **Formats:** Available in all common cylinder formats including KIK/KIL, LFIC, padlocks and deadbolts

Key Features:

- Mechanical and electronic technology are combined for superior security with Medeco patented key control
- Audit key that stores up to 1,000 audit records provides information unavailable in a mechanical system
- Powered by an easily replaceable coin cell battery with 20,000 cycle battery life
- Available with RFID/PROX coil insert for dual use with HID compatible systems
- Visible and audible status feedback
- Compact size in water resistant housing
- Bluetooth enabled option with iOS and Android App support.

Warranty:

Medeco[®] warrants the M³ & X4 CLIQ products to be free of defects in material and/or workmanship for a period of two (2) years from date of original purchase

Finishes:

- Available in several finish options

CLIQ Web Manager Features:

- Role based system administration
- Access Profiles
- Remote Programming
- Web Services Integration
- Key Revalidation
- Automated Change Notification

Cylinder Technologies:

- X4 CLIQ Technology code = “M”
- M³ CLIQ Technology code = “S”
- Biaxial CLIQ Technology code = “V”
- Original CLIQ Technology code = “Z”

Example of a CLIQ configured part number

Base Part #	Cylinder Variation	Cylinder Technology	Finish	Keyway	Pinning	Cam or Tailpiece*
10 0200	<i>If none required, leave blank</i>	S	26	LT	P	Z01

Q = ATEX R = Delay S = Sequence U = Online

M = X4 S = M³ V = Biaxial Z = Original

- **ATEX** (intrinsically safe certification) ATEX certified hardware reduces the risk of ignition and explosion in areas with possible exposure to flammable gases or vapors, or combustible dusts. Ideal for use in areas where ignition or explosion is a concern.
- **Sequence** (Dual Custody) – When enabled, requires two keys to open. Keys must have different IDs and be inserted in within one minute of each other.
- **Delay lock** – When enabled, a specified time is communicated to the key before opening. The time will be added to the keys activation and expiration time when checking the validity of the key and its LOAL entries, creating a time-delay sequence for opening within a specific schedule.
- **Online Open** – When enabled, the access decision for a CLIQ Connect key is done during opening, providing real-time access management and audit trail. The key is automatically updated when inserted into the cylinder, and will only open the cylinder if allowed once the update has finished. The sequence takes 5-10 seconds.

Upcharge applies to special features: ATEX + \$50 List cylinders, + \$20 List for keys. Online Open, Sequence Lock, Delay Lock: + \$50 List Price for cylinders. Only one feature is available per cylinder at a time. Must be indicated at the time of order.

Rim and Mortise Cylinders

A simple replacement of rim or mortise cylinders with M³ or X4 CLIQ provides audit and scheduling along with expiration of credentials for any existing opening utilizing mortise hardware. Cylinders are available in all popular lengths and in any existing mechanical keyway. They are an ideal upgrade for offices requiring loss and liability control or as override for traditional EAC equipment.



Medeco M³ & X4 CLIQ Mortise Cylinders

Priced as Pinned. Master Key Up-charge of \$47.50 applies.

Description	Part Number	Price	M ³	X4
1 1/8" Mortise Cylinder	100200	\$761.52	•	•
1 1/4" Mortise Cylinder	100500	\$762.85	•	•
1 3/8" Mortise Cylinder	105100	\$761.67	•	
1 1/2" Mortise Cylinder	105200	\$796.98	•	
1 3/4" Mortise Cylinder	105400	\$870.71	•	•
2" Mortise Cylinder	105500	\$775.00	•	

Medeco M³ & X4 CLIQ Rim Cylinders

Description	Part Number	Price	M ³	X4
Rim Cylinder, Horizontal Tailpiece	100400H	\$761.50	•	•
Rim Cylinder, Vertical Tailpiece	100400V	\$761.50	•	•
Rim Cylinder, Lazy Motion	100700	\$761.50	•	
Rim Cylinder, Sargent Mounting Style, Horizontal Tailpiece	100403H	\$729.30	•	
Rim Cylinder, Sargent Mounting Style, Vertical Tailpiece	100403V	\$729.30	•	

* Must specify cam (mortise) or tailpiece (rim) when ordering. See pages 76-77 for cam and tailpiece part numbers and descriptions. If not specified, Z01 cam will be supplied for mortise, Y02 tailpiece will be supplied with rim cylinders.

Key-In-Knob/Lever Cylinders

M³ & X4 CLIQ merges the flexibility of electronics with reliable mechanical technology – all in a key in knob or key in lever retrofit cylinder. Offers user audit trail, user access schedules and the ability to quickly add or remove a key electronically from a system, allowing quick response to security threats or lost/stolen keys. These cylinders fit nearly all popular brands and styles of hardware and are therefore an ideal application for offices, storage and file rooms, as well as any door where cylindrical hardware is used.



Medeco M³ & X4 CLIQ Cylinders for Arrow

Description	Part Number	Price	M ³	X4
Cylinder Package for Arrow RK & MK Series Knobs & GL Series levers. Includes CT-Y70, CTY73, & CP-160321. Original cylinder spacer must be replaced with Medeco cylinder spacer CP-160321	20200A1	\$788.37	•	•
6 Pin cylinder for Arrow D & E single cylinder deadbolts; and Revolution V2 Deadbolts. *Order CT-Y27 tailpiece separately.	200901	\$787.39	•	
6 Pin cylinder for Arrow D & E double cylinder deadbolts	200902	\$787.39	•	

Medeco M³ & X4 CLIQ Cylinders for Alarm Lock*Priced as Pinned. Master Key Up-charge of \$47.50 applies.*

Description	Part Number	Price	M ³	X4
Cylinder for Alarm Lock Trilogy T1, T2, T3	20200V1	\$786.39	•	•

Medeco M³ & X4 CLIQ Cylinders for Cal-Royal

Description	Part Number	Price	M ³	X4
Cylinder for Cal-Royal SL00 knob lock and LX01 lever lock	2020049	\$786.39	•	•
Cylinder for Cal-Royal CLS03 Classroom function Grade 2 lever lock	20200V1	\$786.39	•	•

Medeco M³ & X4 CLIQ Cylinders for Corbin Russwin

Description	Part Number	Price	M ³	X4
Cylinder for Corbin Russwin CL3900	20200V9	\$786.39	•	
Cylinder for Corbin Russwin CL3300, CL3400, CL3500, & CL3600	2021173	\$786.39	•	•
Jumbo Mortise Cylinder for Corbin Russwin	10M1350	\$768.49		•

Medeco M³ & X4 CLIQ Cylinders for Dorma

Description	Part Number	Price	M ³	X4
Cylinder for Dorma CL853, CL860 (exterior), CL880, CL882, CL80EL, CL80EU Grade 1 lever, CK853, CK860 (exterior), CK880, CK882, CK80EL, & CK80EU Grade 1 knobs	20200V1	\$786.39	•	•
Cylinder for Dorma CL860 (interior), CL870, CL872, CL873, CL877 Grade 1 Lever, CK860 (interior), CK870, CK872, CK873 & CK 877 Grade 1 Knobs	20200V0	\$786.39	•	•
Cylinder for Dorma CL700 Series	2020049	\$786.39	•	•

Medeco M³ & X4 CLIQ Cylinders for Embassy

Description	Part Number	Price	M ³	X4
Cylinder for Embassy in Entrance, Institution, Storeroom, Corridor Functions. For Embassy Levers sold thru 9/06 and ALL Knobs	20200V1	\$786.39	•	•
Cylinder for Embassy Vestibule, Communicating, Classroom & Classroom Security Functions. For Embassy Levers sold thru 9/06 & ALL Knobs	20200V0	\$786.39	•	•

Medeco M³ & X4 CLIQ Cylinders for Falcon

Description	Part Number	Price	M ³	X4
Cylinder for Falcon B Series	2020049	\$786.39	•	•
Cylinder for Falcon B (CT-Y49), LY (CT-Y72), X (CT-Y68, except H knob or CT-Y71 - H knob), S (CT-Y54 - except H knob, or CT-Y58 - H knob) & F521, F561, F581, and N Series Knobs (CT-Y49 horizontal)	20200F1	\$788.37	•	•
Cylinder for Falcon Inside Cylinder T-381	2020073	\$786.39	•	•
Cylinder for Falcon T & RU Series, T381 Outside Cylinder	20200V3	\$786.39		•

Medeco M³ & X4 CLIQ Cylinders for KABA Mas Hamilton

Description	Part Number	Price	M ³	X4
Cylinder for Kaba E-plex 5000	2020000	\$786.39	•	•
Cylinder for Mas-Hamilton Power Lever	20200V1	\$786.39	•	•

Medeco M³ & X4 CLIQ Cylinders for LSDA

Description	Part Number	Price	M ³	X4
LSDA Cylinder package fits 100, , L100, LH1000, LX1000 Series. Includes: CT-Y49, CT-Y70, CTY73, CT-Y78	20200L1	\$788.37	•	

Cylinder Technologies are represented by the following letters:
 S = M³ CLIQ, M = X4 CLIQ, V = Medeco Biaxial CLIQ, Z = Medeco Original CLIQ

Medeco M³ & X4 CLIQ Cylinders for Marks

Priced as Pinned. Master Key Up-charge of \$47.50 applies.

Description	Part Number	Price	M ³	X4
Cylinder for Marks 110, 170, 180, 190, 195, 295 Series DA-Vestibule, DC & SB Communicating, S-Classroom & Classroom Security functions	20200V0	\$786.39	•	•
Cylinder for Marks Lever 110, 170, 180, 190, 195 & 295 Series in AB-Entrance, DWInstitution, F-Storeroom, & T-Corridor Functions	20200V1	\$786.39	•	•

Medeco M³ & X4 CLIQ Cylinder for Olympus

Description	Part Number	Price	M ³	X4
Cylinder for Olympus 700LCM & 800 LCM Key Retaining	20200S1	\$788.37	•	•
6 Pin Cylinder for Olympus 700LCM & 800LCM Non-Key retaining	20009S4	\$791.59	•	•

Medeco M³ & X4 CLIQ Cylinders for PDQ

Description	Part Number	Price	M ³	X4
Cylinder for PDQ Lever SP & ST Series, GT, XGT, & GP Series	20200V2	\$786.39	•	

Medeco M³ & X4 CLIQ Cylinder for Sargent

Description	Part Number	Price	M ³	X4
Cylinder for Sargent 6, 7 and 10 Line KIK Series	2080147	\$787.39	•	•
Cylinder for Sargent 11 Line KIK Series	2080148	\$787.39	•	
Cylinder for Sargent 10X Series and Sargent 6 Line (B knob only)	2020173	\$773.39		•

Medeco M³ & X4 CLIQ Cylinders for Schlage

Description	Part Number	Price	M ³	X4
Cylinder Package for Schlage A, AL, C, D, ND & Olympiad lever designs, includes: CT-Y49 (A, AL, & D Olympiad Lever & C & D Plymouth), CT-Y52 (C & D heavy duty knobs Ball, Globe & Sphere designs only), CT-Y53 (A series Orbit), CT-Y73 (ND series Gr. 1 lever & AL thick doors), and CTY74 (45-101 padlock)	20200S1	\$788.37	•	•
Cylinder for Schlage S Series Lever	2020097	\$788.37	•	•
Cylinder for Schlage B, E & F160 Series	20009S4	\$791.59	•	•

Medeco M³ & X4 CLIQ Cylinders for Yale

Description	Part Number	Price	M ³	X4
6 pin cylinder for Yale 5300LN, 5400LN and 4300 Series	200503	\$786.39	•	•

Medeco M³ & X4 CLIQ Cylinders for TACO

Description	Part Number	Price	M ³	X4
Cylinder for TACO LXV Lever Lockset	2020078	\$788.37	•	

Interchangeable Core Cylinders

Medeco Large Format Interchangeable Core (LFIC) cylinders are designed so that cores can quickly and easily be changed by non-technical personnel using a special control key. Locks can, in effect, be “rekeyed” without having a working knowledge of the lock or having to take the lock apart. Medeco M³ & X4 CLIQ format additionally provides the benefits of audit and scheduling features. LFIC cylinders fit many of the industry standard formats making them appropriate for almost any door/hardware application.



Medeco M³ & X4 CLIQ LFIC Cylinders

Description	Part Number	Price	M ³	X4
Cylinder for Medeco 6 pin LFIC	320201	\$791.88	•	
Cylinder for Yale 6 pin LFIC	310100	\$791.88	•	•
Cylinder for Yale 7 pin LFIC	310100A	\$791.88	•	•
Cylinder for Schlage LFIC	322201	\$785.88		•

Cylinder Technologies are represented by the following letters:
 S = M³ CLIQ, M = X4 CLIQ, V = Medeco Biaxial CLIQ, Z = Medeco Original CLIQ

Deadbolts

In addition to the physical security of the Maxum deadbolt, the M³ and X4 CLIQ cylinder provides an audit trail, the ability to schedule user access rights and the freedom to quickly add or remove a key from the system. The M³ and X4 CLIQ deadbolt installs with no wiring in a matter of minutes and is available in existing mechanical keyways. Attack-resistant design and tamper-proof features provide strong protection against forced entry and allow for flawless integration into any home or business application.



*All Medeco M³ and X4 CLIQ Double Cylinder Deadbolts use Mechanical Cylinders on the inside of the deadbolt.

Medeco M³ & X4 CLIQ Deadbolt Cylinders

Priced as Pinned. Master Key Up-charge of \$47.50 applies.

Description	Part Number	Price	M ³	X4
Cylinder for Arrow D, E & DB Series Single Cylinder Deadbolts	200901	\$867.98	•	
Cylinder for Sargent 470 & 480 single cylinder deadbolt	200901	\$867.98	•	
Cylinder for Sargent 470 & 480 double cylinder deadbolt	200902	\$867.98	•	
Lazy Motion Cylinder for Schlage B series (old style) deadbolt	200904	\$867.98	•	

Medeco M³ & X4 CLIQ Maxum Deadbolts - Commercial Trim

Description	Part Number	Price	M ³	X4
• Single Cylinder Maxum Deadbolt, 1 1/8" Faceplate, 2 3/8" Backset	11C601	\$914.42	•	
• Single Cylinder Maxum Deadbolt, 1 1/8" Faceplate, 2 3/4" Backset	11C602	\$914.42	•	
• Single Cylinder Maxum Deadbolt, 1" Faceplate, 2 3/8" Backset	11C603	\$914.42	•	
• Single Cylinder Maxum Deadbolt, 1" Faceplate, 2 3/4" Backset	11C604	\$914.42	•	
• Single Cylinder Maxum Deadbolt, Drive In Front, 2 3/8" Backset	11C605	\$914.42	•	
• Single Cylinder Maxum, Drive In Front, 2 3/4" Backset	11C606	\$914.42	•	
• Single Cylinder Maxum Deadbolt, Less Bolt	11C60L	\$837.34	•	
Double Cylinder Maxum Deadbolt, 1 1/8" Faceplate, 2 3/8" Backset	11C621	\$1,012.42	•	
Double Cylinder Maxum Deadbolt, 1 1/8" Faceplate, 2 3/4" Backset	11C622	\$1,012.42	•	
Double Cylinder Maxum Deadbolt, 1" Faceplate, 2 3/8" Backset	11C623	\$1,012.42	•	
Double Cylinder Maxum Deadbolt, 1" Faceplate, 2 3/4" Backset	11C624	\$1,012.42	•	
Double Cylinder Maxum Deadbolt, Drive In Front, 2 3/8" Backset	11C625	\$1,012.42	•	
Double Cylinder Maxum, Drive In Front, 2 3/4" Backset	11C626	\$1,012.42	•	
Double Cylinder Maxum Deadbolt, Less Bolt	11C62L	\$935.34	•	

•Also Available in Classroom Function, 11C61X

Medeco M³ & X4 CLIQ Maxum Deadbolts - Residential Trim

Description	Part Number	Price	M ³	X4
Single Cylinder Maxum Deadbolt, 1 1/8" Faceplate, 2 3/8" Backset	11R601	\$914.42	•	
Single Cylinder Maxum Deadbolt, 1 1/8" Faceplate, 2 3/4" Backset	11R602	\$914.42	•	
Single Cylinder Maxum Deadbolt, 1" Faceplate, 2 3/8" Backset	11R603	\$914.42	•	
Single Cylinder Maxum Deadbolt, 1" Faceplate, 2 3/4" Backset	11R604	\$914.42	•	
Single Cylinder Maxum Deadbolt, Drive In Front, 2 3/8" Backset	11R605	\$914.42	•	
Single Cylinder Maxum Deadbolt, Drive In Front, 2 3/4" Backset	11R606	\$914.42	•	
Single Cylinder Maxum Deadbolt, Less Bolt	11R60L	\$837.34	•	
Double Cylinder Maxum Deadbolt, 1 1/8" Faceplate, 2 3/8" Backset	11R621	\$1,012.42	•	
Double Cylinder Maxum Deadbolt, 1 1/8" Faceplate, 2 3/4" Backset	11R622	\$1,012.42	•	
Double Cylinder Maxum Deadbolt, 1" Faceplate, 2 3/8" Backset	11R623	\$1,012.42	•	
Double Cylinder Maxum Deadbolt, 1" Faceplate, 2 3/4" Backset	11R624	\$1,012.42	•	
Double Cylinder Maxum Deadbolt, Drive In Front, 2 3/8" Backset	11R625	\$1,012.42	•	
Double Cylinder Maxum Deadbolt, Drive In Front, 2 3/4" Backset	11R626	\$1,012.42	•	
Double Cylinder Maxum Deadbolt, Less Bolt	11R62L	\$935.34	•	

Cylinder Technologies are represented by the following letters:
S = M³ CLIQ, M = X4 CLIQ, V = Medeco Biaxial CLIQ, Z = Medeco Original CLIQ

Padlocks

Medeco M³ & X4 CLIQ padlocks are available to provide accountability in a weather resistant padlock that can be used in indoor or outdoor applications. Padlocks have robust reprogramming abilities, as well as audit and scheduling capabilities. Outstanding performance for your perimeter fences and gates, or access to equipment storage areas where traditional EAC is practically impossible to install.



Medeco M³ & X4 CLIQ Padlock Cylinders

Priced as Pinned. Master Key Up-charge of \$47.50 applies.

Description	Part Number	Price	M ³	X4
Cylinder for AWP Series Padlock	510800	\$778.62	•	•
Cylinder for Medeco Protector II (50) Series Padlock	500020	\$792.00	•	
Cylinder for Medeco System (54) Series Padlock	510600	\$967.30	•	•
Cylinder for Abus Padlock Series 83KNK/45, 83KNK/50 & 83KNK/55. (Use Abus driver M)	2020000	\$786.39	•	•
Cylinder for American 3600/3700 Padlock (Use American driver DR-MED6)	2020000	\$786.39	•	•
Cylinder for New Standard Padlock	2020052	\$786.39	•	
Cylinder for Master 20 and 6600, 6700 Pro Series (Use Master driver 0298-627)	2020000	\$786.39	•	•
Cylinder for Schlage 45-101 padlock	2020074	\$788.37	•	•

Medeco M³ & X4 CLIQ AWP Series Padlocks (Includes Cylinder)

Description	Part Number	Price	M ³	X4
AWP - 5/16" dia Stainless Steel shackle, 1 7/8" clearance	5005511	\$947.12	•	•
AWP - 5/16" dia Stainless Steel shackle, 2 3/8" clearance	5005521	\$952.12	•	•
AWP - 5/16" dia Boron shackle, 1 7/8" clearance	5005531	\$947.12	•	•
AWP - 5/16" dia Boron shackle, 2 3/8" clearance	5005541	\$952.12	•	•
AWP - 7/16" dia Stainless Steel shackle, 2" clearance	5005711	\$947.12	•	•
AWP - 7/16" dia Stainless Steel shackle, 2 1/2" clearance	5005721	\$952.12	•	•
AWP - 7/16" dia Boron shackle, 2" clearance	5005731	\$947.12	•	•
AWP - 7/16" dia Boron shackle, 2 1/2" clearance	5005741	\$952.12	•	•

Medeco M³ & X4 CLIQ Protector II Padlocks (Includes Cylinder)

Description	Part Number	Price	M ³	X4
Large Body - 7/16" dia shackle, 1 3/8" clearance	5004732	\$1,144.21	•	
Large Body - 7/16" dia shackle, 1 3/8" clearance, Dust cover	50047321	\$1,162.00	•	
Large Body - 7/16" dia shackle, 1 7/8" clearance	5004832	\$1,148.21	•	
Large Body - 7/16" dia shackle, 1 7/8" clearance, Dust cover	50048321	\$1,166.00	•	
Med Body - 5/16" dia shackle, 1 3/8" clearance	5004734	\$1,115.99	•	
Med Body - 5/16" dia shackle, 1 3/8" clearance, Dust cover	50047341	\$1,133.78	•	
Med Body - 5/16" dia shackle, 1 7/8" clearance	5004834	\$1,119.99	•	
Med Body - 5/16" dia shackle, 1 7/8" clearance, Dust cover	50048341	\$1,137.78	•	

Cylinder Technologies are represented by the following letters:
 S = M³ CLIQ, M = X4 CLIQ, V = Medeco Biaxial CLIQ, Z = Medeco Original CLIQ

Medeco M³ & X4 CLIQ System Series Padlocks (Includes Cylinder)

Description	Part Number	Price	M ³	X4
Padlock 5/16" Shackle - KIK				
Indoor/Outdoor Padlock, 1 1/8" Shackle Clearance	54515X0	\$1,048.48	•	•
Indoor/Outdoor Padlock, 2 3/8" Shackle Clearance	5451FX0	\$1,051.48	•	•
Shrouded Padlock, 3/4" Shackle Clearance	54525X0	\$1,073.48	•	•
Padlock 5/16" Shackle - 6 Pin LFIC				
Indoor/Outdoor Padlock, 1 1/8" Shackle Clearance	54615X0	\$1,055.78	•	
Indoor/Outdoor Padlock, 2 3/8" Shackle Clearance	5461FX0	\$1,063.78	•	
Shrouded Padlock, 3/4" Shackle Clearance	54625X0	\$1,086.78	•	
Padlock 7/16" Shackle - KIK				
Indoor/Outdoor Padlock, 1 3/8" Shackle Clearance	54715X0	\$1,078.48	•	•
Indoor/Outdoor Padlock, 1 7/8" Shackle Clearance	5471FX0	\$1,083.48	•	•
Shrouded Padlock, 3/4" Shackle Clearance	54725X0	\$1,120.48	•	•
Padlock 7/16" Shackle - 6 Pin LFIC				
Indoor/Outdoor Padlock, 1 3/8" Shackle Clearance	54815X0	\$1,092.78	•	
Indoor/Outdoor Padlock, 1 7/8" Shackle Clearance	5481FX0	\$1,100.78	•	
Shrouded Padlock, 3/4" Shackle Clearance	54825X0	\$1,135.28	•	

* 0 = Non-key retaining and R = key retaining

Medeco M³ CLIQ 50 Series Brass Body Padlock

Priced as Pinned. Master Key Up-charge of \$47.50 applies.

Description	Part Number	Price	M ³	X4
Brass Body CLIQ® Padlock, key retaining, hardened steel shackle, dust cover, less cylinder	50762011	\$194.30		
Brass Body CLIQ® Padlock, key retaining, stainless steel shackle, dust cover, less cylinder	50762111	\$194.30		
Brass Body CLIQ® Padlock, non-key retaining, hardened steel shackle, dust cover, less cylinder	50772011	\$194.30		
Brass Body CLIQ® Padlock, non-key retaining, stainless steel shackle, dust cover, less cylinder	50772111	\$194.30		
Brass Body CLIQ® Padlock, key retaining, hardened steel shackle, dust cover, case cover (rubber), less cylinder	50762014	\$218.10		
Brass Body CLIQ® Padlock, key retaining, stainless steel shackle, dust cover, case cover (rubber), less cylinder	50762114	\$218.10		
Brass Body CLIQ® Padlock, non-key retaining, hardened steel shackle, dust cover, case cover (rubber), less cylinder	50772014	\$218.10		
Brass Body CLIQ® Padlock, non-key retaining, stainless steel shackle, dust cover, case cover (rubber), less cylinder	50772114	\$218.10		
Chain assembly for CLIQ® 50 Series Brass Body Padlock	CP-280271	\$35.00		
Cylinder for CLIQ® 50 Series Padlock: Medeco 6 pin LFIC (M ³ technology)	320201	\$791.88	•	

Cylinder Technologies are represented by the following letters:
S = M³ CLIQ, M = X4 CLIQ, V = Medeco Biaxial CLIQ, Z = Medeco Original CLIQ

International Cylinders

Medeco’s international cylinders are designed to fit in locksets of major world manufacturers. In addition to international uses, many of these cylinders fit imported hardware used in North America. These M³ CLIQ cylinders can be installed into standard hardware with no wiring or other modifications, as power is supplied by the key. Reprogramming, audit and key scheduling capabilities are available with easy to use software. Cylinders are widely used at high security government installations, industrial and institutional organizations, airports, hotels, power plants, palaces, museums, universities and schools, and office buildings.



Medeco M³ CLIQ International Cylinders

Description	Part Number	Price	M ³	X4
Cylinder Module Single/Double 36 mm	2322016 300 S	\$666.86	•	
Cylinder Module Single/Double 41mm	2322016 301 S	\$670.86	•	
Euro Single Assembled 36mm/36mm*	23230X6 X00 S	\$746.99	•	
Euro Double Assembled 36mm/36mm**	23230E6 X00 S	\$796.05	•	
Euro Half 0mm	2323016 800 S	\$746.99	•	
Euro Half 5mm Extended	2323016 801 S	\$750.99	•	

* Standard sizes available from the factory.

** Only one side is electronic, the other is mechanical.

Medeco CLIQ[®] CONNECT Key

Bluetooth Low Energy Enabled Keys

Medeco M³ and X4 CLIQ intelligent keys are now available with BLE connectivity. The CLIQ CONNECT Key offers CLIQ remote updates when paired with supported iOS and Android smartphones. The CLIQ CONNECT APP is available as a free download from either App Store and manages the CONNECT Key(s) pairing to the smartphone while reporting key battery level, marking, and system number. Keys are user friendly with visible and audible status feedback, compact in size with water resistant housing, and are powered by an easily replaceable CR2330 battery. Utility patented key control provides protection against unauthorized key duplication.

Connect Key Features:

- Available with RFID/PROX coil
- Visible and audible status feedback
- Compact size in water resistant housing
- New key design, easy battery access
- Powered by an easily replaceable CR2330 coin cell battery, with up to one year battery life
- Available in M³, X4 and Original/Biaxial Keyways

CONNECT App Features:

- Bluetooth (BLE) enabled with iOS & Android Apps
- Free App download from Apple or Play Stores
- Obtain remote updates via supported Apple and Android Smartphones
- Key audit report via CONNECT App
- Pair and manage multiple CONNECT keys



Medeco M³ & X4 CLIQ CONNECT Keys

Description	Part Number	Price
X4 CLIQ_Dynamic/E3 User Key	KEC 49XB03	\$173.00
M ³ CLIQ_Dynamic/E3 User Key	KEC 48XB03	\$173.00
Original/Biaxial CLIQ_Dynamic/E3 User Key	KEC 47XB03	\$173.00

Visit www.cliqkey.tips for additional information

Cylinder Technologies are represented by the following letters:
S = M³ CLIQ, M = X4 CLIQ, V = Medeco Biaxial CLIQ, Z = Medeco Original CLIQ

Medeco CLIQ® Go

CLIQ Go keeps small businesses secure on the go

Medeco “CLIQ Go” is the newest addition to the CLIQ family of intelligent keys, cylinders and cloud-based software. A great way to introduce Intelligent Keying systems to small and mid-sized businesses, CLIQ Go was designed for the business which may need access control on only a handful of doors. It allows owners to manage their security on the go using the CLIQ Go mobile app on a cellphone or other mobile device.

CLIQ Go product is sold and managed by local locksmiths as a stocked item. Cylinders easily retrofit a business’ mechanical door hardware, so installation is quick and simple.



The locksmith programs the keys and provides the business owner with basic system training on CLIQ’s cloud-based software. Owners can then use the CLIQ Go app on a mobile phone or pad to quickly change an opening’s access rights, modify key schedules or disable a key on any opening.

Participating locksmiths are Medeco-trained to provide outstanding customer service and support with every CLIQ Go system they sell.

For information on becoming a CLIQ Go Dealer, call Medeco Customer Care at 877-633-3261.

CLIQ Go Start-up Equipment

Description	Part Number	Price
CLIQ Go Reseller key (R-Key)	EA-100224	\$183.00
X4 CLIQ Desktop Reseller cylinder programmer	94-0312	\$402.00
CLIQ Go programming device for end user	EA-100222	\$556.00
CLIQ Connect Mobile Programming Device	EA-100230	\$1,037.00
CLIQ Express software license and CLIQ Go training (web based – up to 4 hours covering CLIQ Go hardware concepts and overview, CLIQ express software and CLIQ Go app)	SW-500121-0	\$1,525.00
CLIQ Go First Year Software Subscription for each end user Signed by Reseller. Billed to the Reseller Net.	SW-500121-1	\$254.00
CLIQ Go Annual Software Subscription Renewal for each end user signed by Reseller. Billed to the Reseller Net.	SW-500121-1R	\$254.00

Medeco M³ & X4 CLIQ[®]

Keys and Accessories

Medeco M³ and X4 CLIQ intelligent keys operate both CLIQ cylinders as well as compatible mechanical cylinders for unmatched system flexibility and security. Maintaining and ensuring system integrity by means of key audit to obtain historic user access information, as well as the ability to schedule access to doors, is an invaluable tool. M³ and X4 CLIQ keys are also mechanically compatible with Medeco³ and Medeco³ Bilevel and Medeco X4 products with the potential to integrate into an already existing key system. Keys are user friendly with visible and audible status feedback, are compact in size with water resistant housing and are powered by an easily replaceable CR2330 battery. Utility patented key control provides protection against unauthorized key duplication.



Visit www.cliqkey.tips for additional information

Medeco M³ & X4 CLIQ Cut Keys

Description	Part Number	Price
X4 CLIQ E2 Normal User Key	KEC 49X002	\$134.00
X4 CLIQ E3 Dynamic User Key	KEC 49X003	\$134.00
X4 CLIQ E2 Prox Normal User Key	KEC 49XP02	\$146.00
X4 CLIQ E3 Prox Dynamic User Key	KEC 49XP03	\$146.00
X4 CLIQ Yale LFIC Control Key*	KEC 49X013	\$134.00
X4 CLIQ Schlage LFIC Control key**	KEC 497043	\$134.00

*Yale Control Key required if ordering 31 Series IC. Indicate "6" or "7" pin at first "X". Example: KEC496013

Note: For ATEX certified keys, contact customer service. **Schlage Control key is required if ordering 322201 IC.

M ³ CLIQ E2 Normal User Key	KEC 48X002	\$134.00
M ³ CLIQ E3 Dynamic User Key	KEC 48X003	\$134.00
M ³ CLIQ E2 Normal Prox User Key	KEC 48XP02	\$146.00
M ³ CLIQ E3 Dynamic Prox User Key	KEC 48XP03	\$146.00
M ³ CLIQ LFIC Control	KEC 48X023	\$134.00
M ³ CLIQ Yale LFIC Control Key*	KEC 48X013	\$134.00

*Yale Control Key required if ordering 31 Series IC. Indicate "6" or "7" pin at first "X". Example: KEC486013

Note: For ATEX certified keys, contact customer service.

Original/Biaxial CLIQ E2 Normal User Key	KEC 47X002	\$134.00
Original/Biaxial CLIQ E3 Dynamic User Key	KEC 47X003	\$134.00
Original/Biaxial CLIQ E2 Prox Normal User Key	KEC 47XP02	\$146.00
Original/Biaxial CLIQ E3 Prox Dynamic User Key	KEC 47XP03	\$146.00
Original/Biaxial CLIQ LFIC Control Key	KEC 47X023	\$134.00
Original/Biaxial CLIQ Yale LFIC Control Key*	KEC 47X013	\$134.00

*Yale Control Key required if ordering 31 Series IC. Indicate "6" or "7" pin at first "X". Example: KEC476013

Note: For ATEX certified keys, contact customer service.

- Normal Key systems require Loading Authorizations On Lock via the system C-Key.
- Dynamic Key systems require Loading Authorizations On Key via a desktop or remote programming device.

Please consult with your Medeco representative to determine which strategy is best for the desired application/installation.

C-Key for M ³ CLIQ	KEB 48600C	\$172.70
C-Key for Original or Biaxial CLIQ	KEB 47600C	\$172.70
C-Key X4 CLIQ	KEB 49600C	\$172.70
V -Prox Battery Cap Programmed - Black (25)	94-0304-M0P	\$587.00
V -Prox Battery Cap Programmed - Blue (25)	94-0304-MBP	\$587.00
V -Prox Battery Cap, No Programming - Black (25)	94-0305-M0P	\$490.00
V -Prox Battery Cap, No Programming - Blue (25)	94-0305-MBP	\$490.00
Prox Battery Cap, Programmed - Black	E A-500054-M0P	\$35.60
Prox Battery Cap, Programmed - Blue	EA-500054-MBP	\$35.60
CR2330 Replacement Battery (for use in M ³ and X4 CLIQ keys)	EA-350084	\$5.31

Note: For ATEX certified keys, contact customer service.

Medeco M³ & X4 CLIQ[®]

Programming and Management

CLIQ[®] Web Manager is a robust and versatile software used by administrators to efficiently manage their CLIQ[®] System. The CLIQ[®] Web Manager Hosting Service is cloud-based, giving administrators the ability to manage their system from anywhere with internet access and have the benefit of the latest software enhancements. In addition, it offers secure 24/7 web access and no start-up fees, making it a cost-effective solution to meet a wide variety of needs. Choose the offering that best fits your CLIQ[®] system size and requirements.



CLIQ[®] Web Hosting Service

Description	Part Number	Annual License Fee
Basic: Designed for smaller systems and includes desktop/local key and cylinder programming only, Domain Administration. Limit 750 keys.	SW-500101-1	\$977.00
Remote Plus: Designed for mid-sized systems and includes Basic features plus remote, mobile and BLE programming, key revalidation, cylinder groups, access profiles, temporary access groups. Limit 750 keys.	SW-500101-3	\$3,071.00
Enterprise: Designed for large systems and includes all Remote Plus features plus web services for 3rd party applications. Limit 1500 keys.	SW-500101-5	\$5,025.00
Enterprise Plus: Designed for systems larger than 1500 keys. Options available for purchase include custom server configuration, AWS GovCloud web hosting.		Call for pricing
AWS GovCloud infrastructure setup and recurring service. This requires Enterprise plus.	SW-500111-R	Call for pricing
AD/LDAP Interface add-on designed for integration of AD/LDAP with CWM.	SW-500150-R	\$2,000.00
Analytics and reporting add-on designed for analytics of CLIQ data and reporting.	SW-500160-R	\$2,000.00

CLIQ[®] Self-Hosted Software

Description	Part Number	One-time License Fee	Annual Maintenance Fee
Enterprise Self-Hosted One-Time Fee. Includes all Remote Plus features plus web services for 3rd party applications.	SW-600801	\$46,635.00	
Enterprise Self-Hosted Annual Recurring Maintenance Fee.	SW-600801-6R		\$6,995.00

Self-hosted software purchase entitle the user to a single user license with annual license fees. Software maintenance fee provides regular software program updates, maintenance releases, patches, and technical telephone assistance.

An additional license is required for both Medeco- and Self-hosted customer test server environments.

Multi-year hosting available. Contact your sales representative.

The CLIQ service offerings are billed annually. Annual subscription includes maintenance releases, patches, and normal business hours of basic technical telephone support (M-F). Maintenance fees are billed annually. Annual maintenance subscription includes basic technical telephone support (M-F). For extended technical support, please refer to page 21 for advanced support programs including extended hours and guaranteed response times.

For extended technical support, please refer to page 21 for advanced support programs including extended hours and guaranteed response times.

CLIQ Web Manager Client PC minimum requirements: Windows Vista, Windows 7, Windows 8 (64 bit), Pro/Enterprise/Ultimate (32 or 64 bit), Windows 10, Internet Explorer 10.0 or higher or Firefox 16.0.2 or higher. CLIQ Web Manager is a licensed product for both Medeco Hosted Services and End-User Self Hosted Software.

CLIQ® Local Manager

The locally installed CLIQ Local Manager software is used for the day-to-day management of CLIQ system. With it, system managers can perform a variety of tasks based on the specific needs of their environment, managing access rights of user keys locally via desktop programming devices.

Description	Part Number	One-time License Fee	Annual Maintenance Fee
CLIQ Local Manager Stand-alone Software version with perpetual license option: Single system application license – One system can be imported into the software with C-key and ELS files. Two years of tech support is included.	SW-500170	\$2,000.00	
CLIQ Local Manager Stand-alone Software version with recurring license option: Single system application license with Annual maintenance fee.	SW-500170-R		\$600.00

Self-hosted software purchase entitle the user to a single user license with annual license fees. Software maintenance fee provides regular software program updates, maintenance releases, patches, and technical telephone assistance.

Medeco M³ & X4 CLIQ Programming Devices

Description	Part Number	Price
M ³ CLIQ Local Programming Device (Includes USB Cable)	EA-100168	\$644.00
M ³ CLIQ Remote Wall PD	EA-100126	\$1,058.00
M ³ CLIQ Mobile Programmer	EA-100142	\$1,007.00
M ³ CLIQ Outdoor, Vandal Resistant, Wall Programmer	EA-100160	\$1,907.00
X4 CLIQ Local Programming Device (Includes USB Cable)	EA-100179	\$644.00
X4 CLIQ Remote Wall PD	EA-100180	\$1,058.00
X4 CLIQ Mobile Programmer	EA-100181	\$1,007.00
X4 CLIQ Outdoor, Vandal Resistant, Wall Programmer	EA-100182	\$1,907.00
X4 CLIQ local programming device with one plug (for end users - no plug for C key)	EA-100222	\$556.00
X4 CLIQ Connect mobile programming device	EA-100230	\$1,037.00
M3 CLIQ Local Programming Device with one plug (for end users - no plug for C key)	EA-100210	\$556.00
M3 CLIQ Connect mobile programming device	EA-100229	\$1,037.00

Medeco M³ & X4 CLIQ Kits & Accessories

Description	Part Number	Price
Biaxial and M ³ Bottom Pin Kit for use with M ³ CLIQ (Original Product uses standard pin kit)	.KW5401	\$799.00
Metal Cylinder Protector Cover	CP-287260	\$93.50
Plastic cylinder protector cover	CP-170930	\$69.30

End-User Startup Checklist:

- CLIQ Web Manager
- CLIQ Local Programmer
- CLIQ C Key
- Remote Wall and/or Mobile Programmers
- User Keys

Professional Services

Planning, design and support are crucial to the successful deployment of an Intelligent Key System. Medeco offers professional services to ensure every installation is planned and executed seamlessly, and the system works effectively to meet current and future needs to protect the investment. See page 21 for details and pricing.

Medeco Classic CLIQ®

Medeco Classic CLIQ merges the features of electronics with reliable mechanical technology – all in a retrofit cylinder. Medeco CLIQ offers end users audit trail, user access schedules and the ability to quickly and remotely change intelligent key authorizations with the CLIQ Web Manager and Remote.

Medeco Classic CLIQ installs with no wiring in a matter of minutes and intelligent keys and digital cylinder reprogram for electronic master keying.



Audit Accountability

Audit information recorded in both the lock and key shows a time-and-date stamped record of every event, including authorized accesses and unauthorized attempts.



Uses Existing Hardware

The Medeco CLIQ intelligent key provides all power to the cylinder, eliminating the need for any hard wiring or power supply. Simply remove the existing mechanical cylinder and install the Medeco Classic CLIQ cylinder.



Reduces Risk of Lost Keys

Respond quickly to security threats, lost or stolen keys or personnel changes utilizing expiring intelligent key validation intervals and remote programming.



Electronic Scheduling

Intelligent Keys are programmed for specific openings with fully flexible scheduling. Access profiles can be created where programming updates are generated automatically when an opening is added or removed.

Technical Features:

- **Audits:** Key capacity – 1,000 events
Cylinder capacity – 750 events
- **Management:** CLIQ Web Manager with Medeco Hosted or Self-Hosted License
- **Power:** Power supplied by the key, no hard wiring required
- **Lockcase:** Fits standard Rim & Mortise Housing as well as other various platforms
- **Weather Resistant:** Can be used in indoor or outdoor applications
– Rated for -20° F to 122° F (cylinder)
- **Security:** Encrypted identification in cylinder & intelligent key
- **Formats:** Available in all common cylinder formats including KIK/KIL, LFIC, padlocks and deadbolts

Key Information:

- Audit key holds up to 1,000 audit records and provides information unavailable in a mechanical system
- Self-cleaning electronic contact point for a long lasting key and reliable connection
- Powered by an easily replaceable CR2025 Battery with 20,000 cycle battery life
- Available with HID Prox coil insert for dual use with HID compatible EAC systems
- Visible status feedback
- Compact size in water resistant housing

Warranty:

Medeco® warrants the Medeco Classic CLIQ products to be free of defects in material and/or workmanship for a period of two (2) years from date of original purchase

Finishes:

- Available in several finish options

CLIQ Web Manager Features:

- Role based system administration
- Access Profiles
- Remote Programming Web
- Services Integration
- Key Revalidation
- Automated Change Notification

Cylinder Technologies:

- Classic CLIQ Technology code = “C”

Medeco Classic CLIQ®

Rim and Mortise Cylinders

A simple replacement of rim or mortise cylinders with classic CLIQ cylinders provides audit and scheduling along with expiration of credentials for any existing opening utilizing mortise hardware. Cylinders are available in all popular lengths and are an ideal upgrade for offices or as override for traditional EAC equipment.



Medeco Classic CLIQ Mortise Cylinders

Description	Part Number	Price
1 1/4" Mortise Cylinder	100500 C	\$865.63
1 3/8" Mortise Cylinder	105100 C	\$863.29
1 1/2" Mortise Cylinder	105200 C	\$932.46
1 3/4" Mortise Cylinder	105400 C	\$1,016.71
2" Mortise Cylinder	105500 C	\$1,017.86
2 1/2" Mortise Cylinder	105700 C	\$1,017.66

Medeco Classic CLIQ mortise cylinders are not available longer than 2 1/2"

Medeco Classic CLIQ Rim Cylinders

Description	Part Number	Price
Rim Cylinder - Horizontal Tailpiece	100400H C	\$864.29
Rim Cylinder - Vertical Tailpiece	100400V C	\$826.10
Rim Cylinder - Sargent Mounting Style, Horizontal Tailpiece	100403H C	\$864.29
Rim Cylinder - Sargent Mounting Style, Vertical Tailpiece	100403V C	\$864.29
Rim Cylinder - 180 Degree Lazy Motion	100700 C	\$864.29

Key-In-Knob/Lever Cylinders

Medeco's Key-in-Knob cylinders are designed to retrofit knob type cylindrical locksets, lever type cylindrical locksets, padlocks and bored type auxiliary deadlatches and deadlocks. Medeco Classic CLIQ KIK/KIL cylinders additionally offer user audit trail, user access schedules and the ability to quickly add or remove a key electronically from a system, allowing fast response to security threats or lost/stolen keys. These cylinders fit nearly all popular brands and styles of hardware and are therefore an ideal application for office doors, storage and file rooms, or residential doors; virtually any door where cylindrical hardware is used.



Medeco Classic CLIQ Cylinders for Alarm Lock

Description	Part Number	Price
Cylinder for Alarm Lock Trilogy T1, T2, T3	20200V1 C	\$866.98

**Due to possible variances in hardware tolerance and door preparation, Classic CLIQ KIK cylinders should be field tested in lever or knob applications where the key retracts the latch directly to ensure proper hardware operation.*

Medeco Classic CLIQ Cylinders for Arrow

Description	Part Number	Price
Cylinder Package for Arrow MK Series include CT-Y70, CT-Y73, CP-160321	20200A1 C	\$868.96
Cylinder for Arrow RK Series & MK Series (Except Ball), original cylinder spacer must be replaced with Medeco spacer CP-160321	2020070 C	\$866.98
Cylinder for Arrow MK Series (Ball knob only) and GL series	2020073 C	\$866.98
Cylinder for Arrow H & S Knob Series, L, ML, Q, & W Series Lever	2020249 C	\$866.98
Cylinder for Arrow JL Series Interconnected lock, deadbolt cylinder also necessary	2020249 C	\$866.98

Medeco Classic CLIQ Cylinder for Cal-Royal

Description	Part Number	Price
Cylinder for Cal-Royal SL00 Knob Lock and LX01 Lever Lock	2020049 C	\$866.98
Cylinder for Cal-Royal CLS03 Classroom Function Grade 2 Lever Lock	20200V1 C	\$866.98

Medeco Classic CLIQ Cylinder for Corbin Russwin

Description	Part Number	Price
Cylinder for Corbin Russwin CL3900	20200V9 C	\$866.98
Cylinder for Corbin Russwin 800, CL3300, CL3400, CL3500, CL3600	2021173 C	\$866.98
Cylinder for Corbin Russwin CK4200 (new style)	205005 C	\$866.98

Medeco Classic CLIQ Cylinder for Dorma

Description	Part Number	Price
Cylinder for Dorma® CL700 series	2020049 C	\$866.98
Cylinder for Dorma® CL860 (Interior), CL870, CL872, CL873, CL877 Grade 1 Lever, CK860 (Interior), CK870, CK872, CK873, & CK877 Grade 1 Knobs	20200V0 C	\$866.98
Cylinder for Dorma® CL853, CL860 (exterior), CL880, CL882, CL80EL, CL80EU Grade 1 Lever, CK853, CK860 (exterior), CK880, CK882, CK80EL, & CK80EU Grade 1 Knobs	20200V1 C	\$866.98

Medeco Classic CLIQ Cylinder for Embassy

Description	Part Number	Price
Cylinder for Embassy lockset in Entrance, Institution, Storeroom, Corridor functions.	20200V1 C	\$866.98

Medeco Classic CLIQ Cylinder for Hager

Description	Part Number	Price
Cylinder for Hager Lever Locksets, Model 3553,3570,3579,3580	2020249 C	\$866.98

Medeco Classic CLIQ Cylinder for KABA - Mas-Hamilton

Description	Part Number	Price
Kaba E-plex 5000	2020000 C	\$866.98
MAS-Hamilton Power Lever	20200V1 C	\$866.98

Medeco Classic CLIQ Cylinder for LSDA

Description	Part Number	Price
LSDA Cylinder Package Fits 100, L100, LH1000, LX1000 Series. Includes: CT-Y49, CT-Y70 (for 100 Series Knob, except B and L100 Series Lever), CT-Y73 (for 100 Series B knob), CT-Y78 (for LX1000 Lever)	20200L1 C	\$868.96

**Due to possible variances in hardware tolerance and door preparation, Classic CLIQ KIK cylinders should be field tested in lever or knob applications where the key retracts the latch directly to ensure proper hardware operation.*

Medeco Classic CLIQ Cylinder for Marks

Description	Part Number	Price
Cylinder for Marks 110, 170, 180, 190, 195, 295 series Vestibule, Communicating, Classroom, & Classroom Security functions (DA, DC, SB, S).	20200V0 C	\$866.98
Cylinder for Marks Lever 110, 170, 180, 190, 195, 295 series in Entrance, Institution, Storeroom, and Corridor functions (AB, DW, F, T)	20200V1 C	\$866.98

Medeco Classic CLIQ Cylinder for Olympus

Description	Part Number	Price
Cylinder for Olympus 700 LCM and 800 LCM Key Retaining cabinet lock, includes: CTY49, CT-Y52, CT-Y53, CT-Y54	20200S1 C	\$868.96

Medeco Classic CLIQ Cylinder for PDQ

Description	Part Number	Price
Cylinder for PDQ Lever SP & ST series, GT, XGT & GP Series	20200V2 C	\$866.98

Medeco Classic CLIQ Cylinder for Sargent

Description	Part Number	Price
Cylinder for Sargent 10 line locksets order with '30' option prefix (note: cylinder will extend from lever more than standard cylinder)	20200S1 C	\$868.96

Medeco Classic CLIQ Cylinders for Schlage

Description	Part Number	Price
Cylinder Package for Schlage A, AL, C, D, ND & Olympiad lever designs, includes: CT-Y49 (A, AL, & D Olympiad Lever & C & D Plymouth), CT-Y52 (C & D heavy duty knobs Ball, Globe & Sphere designs only), CT-Y53 (A series Orbit), CT-Y73 (ND series Gr. 1 lever & AL thick doors), and CTY74 (45-101 padlock)	20200S1 C	\$868.96
Cylinder for Schlage D Series Lever, Athen, Rhodes, & Sparta designs	2020249 C	\$866.98

Medeco Classic CLIQ Cylinder for TACO

Description	Part Number	Price
Cylinder for TACO LXV lever lockset	2020078 C	\$866.98

Medeco Classic CLIQ Cylinder for Yale

Description	Part Number	Price
Cylinder for Yale 6 pin 5300LN, 5400LN and 4300 Knobs	200503 C	\$866.98

**Due to possible variances in hardware tolerance and door preparation, Classic CLIQ KIK cylinders should be field tested in lever or knob applications where the key retracts the latch directly to ensure proper hardware operation.*

Medeco Classic CLIQ®

Interchangeable Core Cylinders

Medeco Classic CLIQ LFIC cores offer end users the ability to obtain an audit trail, schedule user access rights and quickly and easily remove a key electronically from a system. This cylinder installs into standard Schlage-style LFIC housing hardware with no wiring or other modifications. It is drill and tamper resistant, and ideal for indoor or outdoor installations. Common applications include business entrances such as banks and shopping centers, as well as many school and university applications.



Medeco Classic CLIQ Cylinders for Schlage

Description	Part Number	Price
Classic CLIQ cylinder for Schlage style LFIC	322201 C	\$869.96

Padlocks

Medeco Classic CLIQ retrofit cylinders are available for the Medeco System Series and G8R padlocks, as well as several other popular brands such as American, Schlage or Master. These locks are weather resistant and can be used in indoor or outdoor applications. Padlocks have simple reprogramming abilities, as well as audit and scheduling capabilities for perimeter fences and gates, or for equipment storage areas where traditional EAC is practically impossible to install.



Medeco Classic CLIQ Padlock Cylinders

Description	Part Number	Price
Medeco System Series padlock cylinder (padlock body sold separately)	510600 C	\$1,035.04
G8R Padlock popout cylinder, deadbolt function (padlock body sold separately)	641201 C	\$878.00
G8R Padlock popout cylinder, springbolt function (padlock body sold separately)	641200 C	\$878.00
Cylinder for American 3600/3700 padlock (Use American driver DR-MED6)	2020000 C	\$866.98
Cylinder for New Standard padlocks	2020052 C	\$866.98
Cylinder for Master 20 and 6600, 6700 Pro Series (Use Master driver 0298-627 for Pro Series)	2020000 C	\$866.98
Cylinder for Schlage 45-101 padlock	2020074 C	\$866.98
Cylinder for Abus Padlock Series 83KNK/45, 83KNK/50 & 83KNK/55. (Use Abus driver M)	2020000 C	\$866.98

Medeco Classic CLIQ Padlock Options

Refer to the Padlock Section for System Series and G8R Padlock part numbers and options.

Medeco Classic CLIQ®

Deadbolts

The Medeco Classic CLIQ Maxum deadbolt provides a loss and liability solution in Medeco's Maxum deadbolt platform. In addition to the physical security of the Maxum deadbolt, the Medeco Classic CLIQ cylinder provides an audit trail, the ability to schedule user access rights and the freedom to quickly add or remove a key from the system. The Medeco Classic CLIQ deadbolt installs in a matter of minutes without cumbersome wiring. Attack-resistant design and tamper-proof features provide strong protection against forced entry and allow for flawless integration into any home or business application.



Medeco Classic CLIQ Deadbolt Cylinders

Description	Part Number	Price
Cylinder for Arrow D, E & DB Series Single Cylinder Deadbolts	200901 C	\$867.98
Cylinder for Arrow Revolution deadbolt	200901 C	\$867.98
Cylinder for Sargent 470 & 480 single cylinder deadbolt	200901 C	\$867.98
Cylinder for Sargent 470 & 480 double cylinder deadbolt	200902 C	\$867.98
Lazy Motion Cylinder for Schlage B series (old style) deadbolt	200904 C	\$867.98

Medeco Classic CLIQ Maxum Deadbolts - Commercial Trim

Description	Part Number	Price
• Single Cylinder Maxum Deadbolt, 1 1/8" Faceplate, 2 3/8" Backset	11C601 C	\$1,005.52
• Single Cylinder Maxum Deadbolt, 1 1/8" Faceplate, 2 3/4" Backset	11C602 C	\$1,005.52
• Single Cylinder Maxum Deadbolt, 1" Faceplate, 2 3/8" Backset	11C603 C	\$1,005.52
• Single Cylinder Maxum Deadbolt, 1" Faceplate, 2 3/4" Backset	11C604 C	\$1,005.52
• Single Cylinder Maxum Deadbolt, Drive In Front, 2 3/8" Backset	11C605 C	\$1,005.52
• Single Cylinder Maxum, Drive In Front, 2 3/4" Backset	11C606 C	\$1,005.52
• Single Cylinder Maxum Deadbolt, Less Bolt	11C60L C	\$928.44

• Available Classroom Function, 11C61X C.

Medeco Classic CLIQ Maxum Deadbolts - Residential Trim

Description	Part Number	Price
Single Cylinder Maxum Deadbolt, 1 1/8" Faceplate, 2 3/8" Backset	11R601 C	\$1,005.52
Single Cylinder Maxum Deadbolt, 1 1/8" Faceplate, 2 3/4" Backset	11R602 C	\$1,005.52
Single Cylinder Maxum Deadbolt, 1" Faceplate, 2 3/8" Backset	11R603 C	\$1,005.52
Single Cylinder Maxum Deadbolt, 1" Faceplate, 2 3/4" Backset	11R604 C	\$1,005.52
Single Cylinder Maxum Deadbolt, Drive In Front, 2 3/8" Backset	11R605 C	\$1,005.52
Single Cylinder Maxum Deadbolt, Drive In Front, 2 3/4" Backset	11R606 C	\$1,005.52
Single Cylinder Maxum Deadbolt, Less Bolt	11R60L C	\$928.44

Medeco Classic CLIQ®

Cam and Utility Locks

Medeco® Classic CLIQ cam locks are recognized throughout the world as the standard for protection. Medeco offers a complete line of various cam lock sizes and functions to meet your specific needs. In addition to providing the ultimate defense against drilling, pulling, and other forms of vandal attacks, locks have both electronic auditing and scheduling capabilities that offer further security in many applications. Storage cabinets, vending machines, lockers and tool boxes can all be accommodated without any wiring and be utilized in either indoor or outdoor use.



Medeco Classic CLIQ Cam Locks

Description	Part Number	Price
7/8" Cam lock	60810 XXX C	\$882.00
7/8" Cam lock with hardened plug face	60810D XXX C	\$955.46
1 1/8" Cam lock	60820 XXX C	\$882.00
1 1/8" Cam lock with hardened steel plug face	60820D XXX C	\$955.46

Medeco Classic CLIQ Cam Lock Codes

Description	Op Code
1 Flat, 1 Key Pull, Clockwise 90 degree	119
2 Flat, 1 Key Pull, Clockwise 90 degree	219
2 Flat, 2 Key Pull, Clockwise 90 degree	229
2 Flat, 1 Key Pull, Counterclockwise 90 degree	239
2 Flat, 2 Key Pull, Counterclockwise 90 degree	249
2 Flat, 1 Key Pull, Clockwise 180 degree	259
2 Flat, 2 Key Pull, Clockwise 180 degree	269

Retail/Showcase Cylinders

Medeco Classic CLIQ showcase and cabinet locks offer end users audit trail, user access schedules and the ability to quickly add or remove a key electronically from a system. Installs with no wiring in a matter of minutes, and electronic keys and cylinders reprogram for instant changes. With ease of tracking capabilities, in a retail environment these locks are ideal to protect against both customer and employee theft, and to allow efficient access for sales associates with full audit accountability. Available to fit many types of display cases, as well as cash drawers and inventory cabinets.



Medeco Classic CLIQ Cabinet Locks

Description	Part Number	Price
Plunger Lock, Round Bolt	490358 C	\$1,008.00
Plunger Lock, T- Bolt	490368 C	\$1,008.00
Cabinet Lock, Latchbolt	490359 C	\$986.80
Cabinet Lock, Deadbolt	490366 C	\$986.80
Showcase Ratchet Lock	490361 C	\$953.64

Medeco Classic CLIQ®

International Cylinders

Medeco's international cylinders are designed to fit in locksets of major world manufacturers. In addition to international uses, many of these cylinders fit imported hardware used in North America. These Medeco Classic CLIQ cylinders can be installed into standard hardware with no wiring or other modifications, as power is supplied by the key. Reprogramming, audit and key scheduling capabilities are available with easy to use software. These cylinders are widely used at high security government installations, industrial and institutional organizations, airports, hotels, power plants, palaces, museums, universities and schools, and office buildings.



Medeco Classic CLIQ International Cylinders

Description	Part Number	Price
Thumbturn Profile - Assembled 30/30mm	2325005 C	\$1,052.00
Double Cylinder Profile - Assembled 30/30mm	2325025 C	\$1,504.00

- Other lengths available, please inquire.

Vending Cylinder Formats

Medeco Classic CLIQ specialty cylinders offer industrial or route management vendors electronic control over their assets. Medeco Classic CLIQ offers end users audit trail, user access schedules and the ability to quickly add or remove a key electronically from a system. Installs with no wiring in a matter of minutes and electronic keys and cylinders reprogram for instant changes. Audit information recorded in both the lock and key shows a time-and-date stamped record of every event, including authorized accesses and unauthorized attempts. Medeco Classic CLIQ products add a wide variety of intelligent features without compromising on physical security. Attack-resistant design and tamper-proof features provide strong protection against forced entry.



Medeco Classic CLIQ Pop-Out Cylinders

Description	Part Number	Price
CLIQ Pop-out Cylinder, Springbolt	641200 C	\$878.00
CLIQ Pop-out, Springbolt, Hardened Plug	641200D C	\$951.46
CLIQ Pop-out Cylinder, Deadbolt	641201 C	\$878.00
CLIQ Pop-Out Cylinder, Deadbolt, Hardened Plug	641201D C	\$951.46

Medeco Classic CLIQ®

Keys and Accessories

Medeco Classic CLIQ intelligent keys operate Classic CLIQ cylinders for system flexibility and security they maintain and ensures system integrity by means of key audit to obtain historic user access information, as well as the ability to schedule access to doors. Keys are user friendly with visible LCD status feedback, compact in size with water resistant housing and are powered by an easily replaceable CR2025 battery.



Medeco Classic CLIQ Keys

Description	Part Number	Price
E2/Normal User Key - Key Only	KEC 42602B	\$149.60
E3/Dynamic User Key - Key Only	KEC 42603B	\$149.60
C-Key	KEC 4260CR	\$191.30
E2/Normal User Key with 125kHz PROX Cover	KEC 426P2B	\$161.60
E3/Dynamic User Key with 125kHz PROX Cover	KEC 426P3B	\$161.60
CLIQ Battery Cover w/Proximity-upgrade standard Medeco Classic CLIQ keys to RFID Proximity Keys (sold in pack of 25) - Black only	94-0249	\$428.00

- Normal Key systems require Loading Authorizations On Lock via the system C-Key.
 - Dynamic Key systems require Loading Authorizations On Key via a desktop or remote programming device.
- Please consult with your Medeco eCylinder representative to determine which strategy is best for the desired application/installation.*

Medeco Classic CLIQ Programming Devices

Description	Part Number	Price
Medeco Classic CLIQ Local Programming Device (Includes USB Cable)	EA-100167	\$644.00
Remote Wall PD for Medeco Classic CLIQ	EA-100121	\$1,103.00
Medeco Classic CLIQ Mobile Programmer	EA-100145	\$1,007.00
Outdoor, Vandal Resistant, Wall Programmer for Medeco Classic CLIQ keys	EA-100159	\$1,907.00

Medeco Classic CLIQ Kits & Accessories

Description	Part Number	Price
Plastic Cylinder Protection Cover	CP-170930	\$69.30
Metal Cylinder Protection Cover	CP-287260	\$93.50

End-User Startup Checklist:

- CLIQ Web Manager
- CLIQ Local Programmer
- CLIQ C Key
- Remote Wall and/or Mobile Programmers
- User Keys

Professional Services

Planning, design and support are crucial to the successful deployment of an Intelligent Key System. Medeco offers professional services to ensure every installation is planned and executed seamlessly, and the system works effectively to meet current and future needs to protect the investment. See page 21 for details and pricing.

Medeco Classic CLIQ®

Programming and Management

CLIQ® Web Manager is a robust and versatile software used by administrators to efficiently manage their CLIQ® System. The CLIQ® Web Manager Hosting Service is cloud-based, giving administrators the ability to manage their system from anywhere with internet access and have the benefit of the latest software enhancements. In addition, it offers secure 24/7 web access and no start-up fees, making it a cost-effective solution to meet a wide variety of needs. Choose the offering that best fits your CLIQ® system size and requirements.



CLIQ® Web Hosting Service

Description	Part Number	Annual License Fee
Basic: Designed for smaller systems and includes desktop/local key and cylinder programming only, Domain Administration. Limit 750 keys.	SW-500101-1	\$977.00
Remote Plus: Designed for mid-sized systems and includes Basic features plus remote, mobile and BLE programming, key revalidation, cylinder groups, access profiles, temporary access groups. Limit 750 keys.	SW-500101-3	\$3,071.00
Enterprise: Designed for large systems and includes all Remote Plus features plus web services for 3rd party applications. Limit 1500 keys.	SW-500101-5	\$5,025.00
Enterprise Plus: Designed for systems larger than 1500 keys. Options include custom server configuration, FedRAMP compliance.		Call for pricing
<i>These offerings are billed annually.</i>		

CLIQ® Self-Hosted Software

Description	Part Number	One-time License Fee	Annual Maintenance Fee
Enterprise Self-Hosted One-Time Fee. Includes all Remote Plus features plus web services for 3rd party applications.	SW-600801	\$46,635.00	
Enterprise Self-Hosted Annual Recurring Maintenance Fee.	SW-600801-6R		\$6,995.00
<i>Maintenance fees are billed annually.</i>			
Self-hosted software purchases entitle the user to a single user license with no annual license fees. However, the software maintenance fee is recommended and provides regular software program updates, maintenance releases, patches, and technical telephone assistance.			

CLIQ Web Manager Client PC minimum requirements: Windows Vista, Windows 7, Windows 8 (64 bit), Pro/Enterprise/Ultimate (32 or 64 bit), Windows 10, Internet Explorer 10.0 or higher or Firefox 16.0.2 or higher. CLIQ Web Manager is a licensed product for both Medeco Hosted Services and End-User Self Hosted Software.

Medeco 4

High Security Locking System

Medeco builds on more than 50 years of lock engineering innovation and takes security to the next level, offering the highest level of protection against physical attack and unauthorized key duplication with Medeco 4 (M4).

M4 cylinders are UL 437 listed for physical strength and high security components, using solid brass construction with strategically placed hardened-steel inserts to thwart drilling attacks. In addition to tumbler pins that lift and rotate, M4's design includes up to 4 side pins: 3 finger pins and 1 lift pin, which must all interact with the sidebar to open, providing a high level of pick resistance. The patent-pending M4 key design, with its shuttle pin movable element, also protects against the emerging threat of 3D printing for added credential security.



Key Control

Patent-pending key control protects against unauthorized duplication of keys.



Protection Against 3D Printing

A patent-pending movable element in the key deters against unauthorized 3D printed copies of keys or blanks.



Picking and Bumping Protection

M4 cylinders use cylinder side pins, a shuttle lift pin and a movable key element to engage a sidebar that prevents the key from turning until the elements are rotated and aligned in the correct position, protecting against bumping, picking and other attacks.



Uses Existing Hardware

M4 cylinders are available in a wide variety of formats, retrofitting most hardware on the market.



Protection From Physical Attack

M4 cylinders are UL 437 listed and UL test lab proven to stand up to drilling, picking and other forms of physical attack.



Special Angled Cut Keys

A special key cutting machine and access to Medeco-specific blanks are required to duplicate M4 keys, which are available in multiple levels of restriction to support every need.



Master Keying Capabilities

M4 cylinders can be master keyed into a system that includes M4, M4 BiLevel, and M4 CLIQ keys and cylinders. Extremely large systems are possible.

Technical Information

Cylinders:

- **UL 437:** – Underwriters Laboratory Standard for a locking cylinder's ability to resist physical attack.
- **ANSI/BHMA A156.30 & 156.5 rated** – meets or exceeds criteria for strength and durability, key control, and surreptitious entry resistance.
- Solid brass machined construction
- Biaxial-style split pin tumblers
- 100,000 cycle endurance tested

Keys:

- Angled, offset cuts on key blade
- Movable element on blade provides 3D key and key blank copy protection
- Patent-pending protection against duplicate keys
- Unique keyway pre-cuts using side cuts
- Secondary biting/side pins in four positions
- Expanded master keying capability

Applications:

- M4 cylinders are available in a wide variety of formats and are ideal for any application requiring key control and a high level of physical security. They are upgradeable to electronics with M4 CLIQ.

Warranty:

M4 cylinders are warranted for two years against manufacturer's defects. M4 keys have a lifetime warranty against breakage. See the Medeco limited warranty for details.

Medeco BiLevel

M4 BiLevel* cylinders offer affordable key control through patent -pending protected keys. Standard locking systems without utility patent protected keys allow anyone who gains possession of a key to easily and inexpensively make a copy. With an unauthorized duplicate key, a thief has complete access to a building, its physical and intellectual property, and the people inside. BiLevel locking systems ensure that the keys to a facility can only be duplicated by certified Medeco dealers and only with the proper authorization.

Medeco BiLevel cylinders can tie in with other Medeco mechanical and Intelligent Key products for master keying purposes.



Patented -pending Key Control

Protects against unauthorized duplication of keys.



Special Angle Cut Keys

Requires a special key cutting machine and access to Medeco specific blanks, available in a variety of restrictions to support every need.



Uses Existing Hardware

Medeco offers the largest selection of retrofit cylinders that reduce cost by eliminating the need to replace your existing hardware.



Can Be Master Keyed

Can be master keyed into a system containing M4 BiLevel and Medeco 4 mechanical as well as M4 CLIQ** eCylinders.

Technical Information:

- Can be keyed with Medeco 4 and M4 CLIQ products

Applications:

BiLevel retrofit cylinders are ideal for any application requiring patented key control where physical high security is not necessary.

Warranty:

Medeco BiLevel cylinders are warranted for two years against manufacturer's defects. See the Medeco limited warranty for full details.

Cylinder Formats:

- Rim & Mortise
- Key in Knob/Lever Cylinders
- Large Format Interchangeable Cores
- Padlocks
- Deadbolts

Medeco X4

All facilities need patented key control to effectively secure exterior and interior openings. This strength of integrity allows security managers to have peace of mind when it comes to managing the system. Unfortunately, instituting a new key system is not always easy... or economical.

Medeco X4 is an economic and efficient solution to rekeying needs. Medeco X4 has one of the largest master key capabilities on the market, allowing facility managers to tie everything together under one key for ease, convenience and efficiency. Additionally, Medeco X4 easily retrofits into existing systems, significantly reducing installation time.

Medeco X4 is the perfect security upgrade for small format interchangeable core (SFIC) installations. In addition to SFIC cylinders, Medeco X4 is also available in many other styles of retrofit cylinders that can all be keyed into a single system.



Patented Key Control

Protects against unauthorized duplication of your keys.



Uses Existing Hardware

Medeco X4 is available in a large selection of retrofit cylinder formats that can all be keyed into a single system.



Quickly Change Cores

Medeco X4 SFIC cylinder provides quick and easy cylinder changes in the event keys are lost or stolen.



Can be Master Keyed

Available in Small Format Interchangeable Cores (SFIC) and other retrofit cylinder formats which can be master keyed together, eliminating the need to replace your existing hardware.

Technical Information:

- Superior master key capabilities, up to four (4) times that of similar style cylinders
- One key flexibility for different cylinder styles compatible
- Patented system lasting until the year 2030
- Custom key coining for added security

Applications:

The Medeco X4 retrofit cylinders are ideal for any application requiring key control and physical security of your cylinders

Warranty:

Medeco X4 cylinders are warranted for two years against manufacturer's defects. See the Medeco® limited warranty for full details

Cylinder Formats:

- Rim & Mortise
- Key in Knob/Lever Cylinders
- Small Format Interchangeable Cores
- Large Format Interchangeable Cores
- Padlocks
- Deadbolts

Rim & Mortise Cylinders

FEATURES	Medeco 4	BiLevel	Medeco X4	CLIQ	Medeco XT
Utility patented key control provides protection from unauthorized duplication of keys	● (pending)	●	●	●	●
UL 437 Listing and BHMA Certification provide validation of high security from recognized, independent testing laboratories	●				
Pick resistance and large numbers of combinations for master keying flexibility to accommodate systems of virtually any size	●				
Hardened steel inserts in the cylinder face provide proven drill resistance	●				
Nickel plated pins provide exceptional wear resistance and additional hardened stainless steel pins provide drill resistance	●				
Solid nickel silver bottom pins provide exceptional wear resistance			●		
Retrofits into virtually any manufacturers' locksets for cost effective improved security	●	●	●	●	●
High security and key control may be incorporated in a single system for cost effective system flexibility	●	●		●	
Keys may be integrated with Hybrid proximity head for greater system retrofit	●	●	●	●	

Medeco 4 Premium High Security

For effective mechanical protection against most forms of attack as well as protection against unauthorized duplicate keys, Medeco 4 cylinders are recommended. Security features including hardened steel components, pins that must be elevated, rotated, and interact with a sidebar which is engaged by the movable element in the key make Medeco 4 the cylinder of choice to protect people, property and information.

Medeco 4 BiLevel Key Control

Medeco 4 BiLevel cylinders may be incorporated into a master key system with Medeco 4 high security, offering protection against all types of attack where needed, and patented key control cylinders for areas requiring less protection. BiLevel cylinders offer patented control against unauthorized duplication of keys without the additional security features protecting against force or surreptitious attack.

Medeco X4 Patented Key Control

Medeco X4 cylinders offer patented control against unauthorized duplication of keys without the additional security features protecting against force or surreptitious attack.

Intelligent Key Solutions

Many of the cylinders in this section are also available with an Intelligent Key solution. See the Intelligent Key section for more details.

Rim & Mortise Cylinders

Medeco mortise cylinders are precision-machined solid brass and retrofit into virtually any industry standard hardware. Rim cylinders can be used with auxiliary locking devices such as: surface mounted deadbolts, night latches, panic devices and jimmy proof locks (also known as vertical dropbolts or interlocking deadbolts). Medeco high security rim and mortise cylinders are UL 437 listed for drill and pick resistance, and the those that incorporate the Medeco 4, M4 BiLevel, or Medeco X4 technologies, offer utility patented key control.



Patented Key Control

Protects against unauthorized duplication of keys.



Picking and Bumping Protection

M4 cylinders use cylinder side pins, a shuttle lift pin and a movable key element to engage a sidebar that prevents the key from turning until the elements are rotated and aligned in the correct position, protecting against bumping, picking and other attacks.



Protection From Physical Attack

Medeco 4 rim & mortise cylinders are UL 437 listed and stand up to drilling, picking and other forms of physical attack.



Special Angle Cut Keys

Requires a special key cutting machine and access to Medeco specific blanks, available in multiple levels of restriction to support every need.



Uses Existing Hardware

Medeco offers the largest selection of retrofit Rim & Mortise cylinders that reduce cost by eliminating the need to replace existing hardware.



Master Keying Capabilities

Medeco 4 can be master keyed into a system containing Medeco 4 BiLevel M4 CLIQ eCylinders. Extremely large systems are possible.

Applications

Flexible options designed to retrofit various manufacturers mortise and rim locks

Warranty:

Warranted for two (2) years against manufacturers' defects. See the Medeco® limited warranty for full details

Technical Features:

- BHMA A156.30 Certification assures patent protected key control and physical strength (Medeco 4, M3)
- BHMA A156.5 Grade 1 Certification assures consistent quality for heavy use applications (Medeco 4, M3)
- Solid brass construction provides high quality and long cylinder life
- Set screw pin chamber caps allow quick and easy pinning and re-keying without the need to take the cylinder apart
- Large variety of cylinder lengths and cam/tailpiece configurations provide excellent retrofit capability and reduce the need to replace the entire locking device

Finishes:

- Available in all standard finishes to match existing hardware

Available Key Technologies:

Mechanical:	eCylinder:
– Medeco 4	– M4 CLIQ
– Medeco 4 BiLevel	– M ³ CLIQ
– Medeco ³	– Classic CLIQ
– Medeco ³ BiLevel	– X4 CLIQ
– Medeco X4	– XT

How To Order Rim & Mortise Cylinders

Complete part numbers are required for all orders. To determine the correct part number, fill in the "X's" in sequential order.

1

100200 base part

Refer to pages 63-75 for descriptions and technical specifications to find the corresponding base part number.

2

H technology

H = Medeco 4
T = Medeco³
W = Biaxial
- = Original
J = Medeco³
BiLevel
N = X4
K = KM
P = M4 BiLevel
Q = M4 CLIQ
S = M3 CLIQ
M = X4 CLIQ
C = Classic CLIQ

3

05 finish

Refer to the inside back cover of this catalog for finish options.

4

M4 keyway

Insert keyway if known or contact Customer Service for help.

5

P pinning

S = Sub-Assembled (Uncombined)
N = Sub-assembled,
- No side pins (M4 only)
- No slider (M3 only)
P = Pinned (Combined)
M = Master Keyed
R = Master Keyed
- blade and side pins (Medeco 4 only)

6

Z01 cam or tailpiece

Refer to pages 76-77 for cam and tailpiece options.
If not specified, Z01 for mortise and Y02 for rim will be supplied.

7

624 side pin code

(Medeco 4 only)
Insert side pin code if known or contact Customer Service for help.

BUILD A RIM & MORTISE PART #:

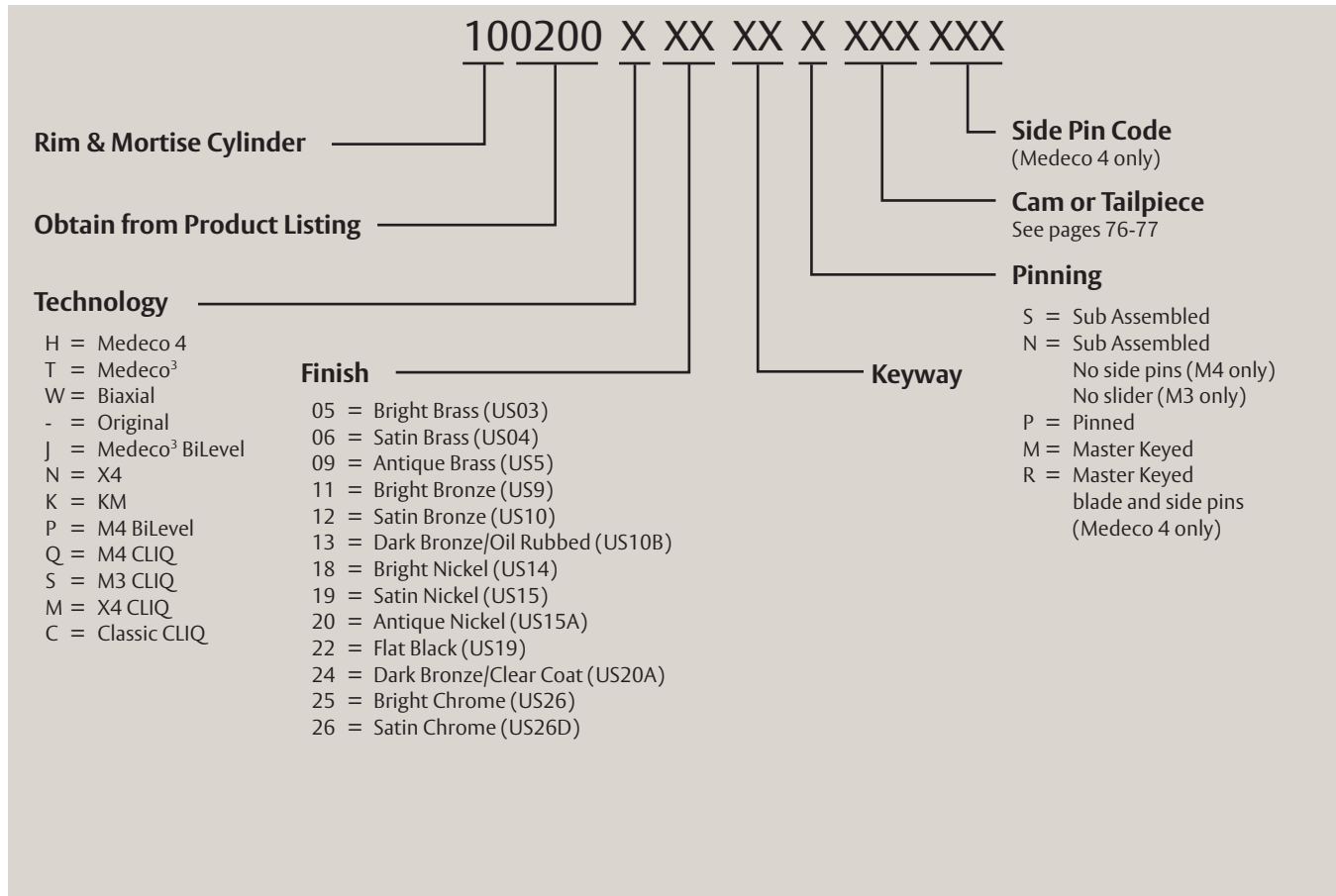

Standard Mortise Cylinders

Description	Part Number	M4/M ³	BiLevel	X4	Biax/Orig	KeyMark
1" 5 Pin Mortise Cylinder – (6 pin for Medeco X4)	100100 (P)	\$160.00	\$87.07	\$109.05	\$168.03	\$115.77
	100100 (S)	\$146.00	\$79.57	\$95.05	\$154.03	\$101.77
1" 5 Pin Mortise Cylinder with 120° notch along top of shell for alternate retaining location	100101 (P)	\$160.00	\$87.07		\$168.03	
	100101 (S)	\$146.00	\$79.57		\$154.03	
1-1/8" 6 Pin Mortise Cylinder	100200 (P)	\$160.00	\$87.07	\$109.05	\$168.03	\$115.77
	100200 (S)	\$146.00	\$79.57	\$95.05	\$154.03	\$101.77
1-1/4" 6 Pin Mortise Cylinder	100500 (P)	\$166.00	\$90.34	\$110.55	\$174.36	\$117.26
	100500 (S)	\$152.00	\$82.84	\$96.55	\$160.36	\$103.26
1-3/8" 6 Pin Mortise Cylinder	105100 (P)	\$173.00	\$94.16	\$122.60	\$181.75	\$130.03
	105100 (S)	\$159.00	\$86.66	\$108.60	\$167.75	\$116.03
1-1/2" 6 Pin Mortise Cylinder	105200 (P)	\$234.00	\$127.40	\$165.59	\$246.10	
	105200 (S)	\$220.00	\$119.90	\$151.59	\$232.10	
1-5/8" 6 Pin Mortise Cylinder	105300 (P)	\$240.00	\$130.67	\$171.59	\$252.43	\$182.27
	105300 (S)	\$226.00	\$123.17	\$157.59	\$238.43	\$168.27
1-3/4" 6 Pin Mortise Cylinder	105400 (P)	\$247.00	\$134.49	\$178.59	\$259.81	\$189.66
	105400 (S)	\$233.00	\$126.98	\$164.59	\$245.81	\$175.66
2" 6 Pin Mortise Cylinder	105500 (P)	\$261.00	\$142.12	\$192.59	\$274.58	\$204.43
	105500 (S)	\$247.00	\$134.62	\$178.59	\$260.58	\$190.43
2-1/4" 6 Pin Mortise Cylinder	105600 (P)	\$275.00	\$150.20		\$289.30	
	105600 (S)	\$261.00	\$142.70		\$275.30	
2-1/2" 6 Pin Mortise Cylinder	105700 (P)	\$290.00	\$157.92	\$221.59	\$305.18	\$235.02
	105700 (S)	\$276.00	\$150.42	\$207.59	\$291.18	\$221.02
2-3/8" 6 Pin Mortise Cylinder	105904 (P)	\$282.00			\$296.74	
	105904 (S)	\$268.00			\$282.74	
2-3/4" 6 Pin Mortise Cylinder	105104 (P)	\$306.00			\$322.06	
	105104 (S)	\$292.00			\$308.06	
3-1/4" 6 Pin Mortise Cylinder	105900 (P)	\$331.00		\$331.00	\$348.44	
	105900 (S)	\$317.00		\$317.00	\$334.44	
4-1/8" 6 Pin Mortise Cylinder	105800 (P)	\$379.00			\$399.07	
	105800 (S)	\$365.00			\$385.07	
5" 6 Pin Mortise Cylinder	105901 (P)	\$425.00			\$447.61	
	105901 (S)	\$411.00			\$433.61	

(P) = Pinned (combined)

(S) = Sub-assembled (uncombined)

Surcharges for Master Keying, Custom Coining and Custom Stamping apply, see page 202.
Refer to the XT and CLIQ Intelligent Key sections for format availability and pricing.

Residential Mortise Cylinders

Description	Part Number	M4/M ³	BiLevel	X4	Biax/Orig	KeyMark
1" 5 pin, Thin head mortise cylinder	1014506 (P)	\$160.00			\$168.03	
	1014506 (S)	\$146.00			\$154.03	
1-1/8" 5 pin, Thin head mortise cylinder	1014500 (P)	\$160.00			\$168.03	
	1014500 (S)	\$146.00			\$154.03	
1-1/4" 5 pin, Thin head mortise cylinder	1014501 (P)	\$166.00			\$174.36	
	1014501 (S)	\$152.00			\$160.36	
1-3/8" 5 pin, Thin head mortise cylinder	1014502 (P)	\$173.00			\$181.75	
	1014502 (S)	\$159.00			\$167.75	
1-1/2" 5 pin, Thin head mortise cylinder	1014503 (P)	\$234.00			\$246.10	
	1014503 (S)	\$220.00			\$232.10	
1-5/8" 5 pin, Thin head mortise cylinder	1014504 (P)	\$238.00			\$250.32	
	1014504 (S)	\$224.00			\$236.32	
1-3/4" 5 pin, Thin head mortise cylinder	1014505 (P)	\$245.00			\$257.70	
	1014505 (S)	\$231.00			\$243.71	
2" 5 pin, Thin head mortise cylinder	1014507 (P)	\$253.00			\$266.14	
	1014507 (S)	\$239.00			\$252.15	
2-1/4" 5 pin, Thin head mortise cylinder	1014508 (P)	\$263.00			\$276.69	
	1014508 (S)	\$249.00			\$262.69	
1-1/8" 6 pin, Thin head mortise cylinder	1014600 (P)	\$160.00			\$168.03	
	1014600 (S)	\$146.00			\$154.03	
1-1/4" 6 pin, Thin head mortise cylinder	1014601 (P)	\$166.00			\$174.36	
	1014601 (S)	\$152.00			\$160.36	
1-3/8" 6 pin, Thin head mortise cylinder	1014602 (P)	\$173.00			\$181.75	
	1014602 (S)	\$159.00			\$167.75	
1-1/2" 6 pin, Thin head mortise cylinder	1014603 (P)	\$234.00			\$246.10	
	1014603 (S)	\$220.00			\$232.10	
1-5/8" 6 pin, Thin head mortise cylinder	1014604 (P)	\$238.00			\$250.32	
	1014604 (S)	\$224.00			\$236.32	
1-3/4" 6 pin, Thin head mortise cylinder	1014605 (P)	\$245.00			\$257.70	
	1014605 (S)	\$231.00			\$243.71	
2" 6 pin, Thin head mortise cylinder	1014607 (P)	\$253.00			\$266.14	
	1014607 (S)	\$239.00			\$252.15	
2-1/4" 6 pin, Thin head mortise cylinder	1014608 (P)	\$263.00			\$276.69	
	1014608 (S)	\$249.00			\$262.69	

Jumbo/Mogul Mortise Cylinders

Description	Part Number	M4/M ³	BiLevel	X4	Biax/Orig	KeyMark
6 Pin Jumbo Mortise Cylinder (1-19/64" Long, 1-3/8" Shell Dia.) Corbin Russwin® Master Ring Cylinder Replacement	101350 (P)	\$209.00	\$113.78	\$165.19	\$219.72	\$174.71
	101350 (S)	\$195.00	\$106.28	\$151.19	\$205.72	\$160.71
6 Pin 1-1/4" Mogul Cylinder for Prison Locks (1-1/4" Long, 2" Shell Dia.)	104001 (P)	\$219.00			\$230.28	
	104001 (S)	\$205.00			\$216.28	

(P) = Pinned (combined)

(S) = Sub-assembled (uncombined)

Surcharges for Master Keying, Custom Coining and Custom Stamping apply, see page 202.
Refer to the XT and CLIQ Intelligent Key sections for format availability and pricing.

Limited Rotation Mortise Cylinders

Description	Part Number	M4/M ³	BiLevel	X4	Biax/Orig	KeyMark
6 Pin 1-1/4" Mortise Cylinder with Raised Plug, Limited Rotation: CK 145° CW and 145° CCW	100500H (P)	\$208.60			\$216.96	
	100500H (S)	\$194.60			\$202.96	
6 Pin 1-1/4" Mortise Cylinder Hotel Function, Uses Spring Loaded Stop Pins with Notched and Un-Notched Keys to Provide Directional and Limited Rotation	100501 (P)	\$198.00			\$208.12	
	100501 (S)	\$184.00			\$194.12	
6 Pin 1-3/16" Length Mortise Cylinder Limited Rotation: CK 145° CCW, MK 360° CCW and CW	490078 (P)	\$182.00			\$191.24	
	490078 (S)	\$168.00			\$177.24	
6 Pin 1-3/16" Length Mortise Cylinder, Limited Rotation: CK 145° CW, MK 360° CCW and CW	490079 (P)	\$182.00			\$191.24	
	490079 (S)	\$168.00			\$177.24	

Specialty Mortise Cylinders

Description	Part Number	M4/M ³	BiLevel	X4	Biax/Orig	KeyMark
5 Pin Otis® Elevator Mortise Cylinder, 1 Key Pull Position	100903 (P)	\$177.00			\$185.97	
	100903 (S)	\$163.00			\$171.97	
5 Pin Otis® Elevator Mortise Cylinder, 2 Key Pull Positions (not used in MK systems)	100909 (P)	\$203.00			\$213.40	
	100909 (S)	\$189.00			\$199.40	
1-7/32" 6 Pin Mortise Cylinder with Mini Micro Switch, 7 Amp, SPDT, 1 Key Pull (requires quick connect leads: CP-270511)	100200A (P)	\$256.62	\$183.69	\$180.64	\$264.65	\$187.36
	100200A (S)	\$242.62	\$176.19	\$166.64	\$250.65	\$173.36
1-1/8" 6 Pin Concealed Face Mortise Cylinder for Schlage® "K" Locks, Trim Style 712, 714, 202	100202 (P)	\$182.00	\$99.06	\$129.84	\$191.24	\$137.55
	100202 (S)	\$168.00	\$91.56	\$115.84	\$177.24	\$123.55
1-1/8" 6 Pin Mortise Cylinder with Extended Plug & Second Cam Washer Reversed to Close Bottom of Keyway	104207 (P)	\$191.00	\$94.16		\$181.75	
	104207 (S)	\$159.00	\$86.66		\$167.75	
1-1/8" 6 Pin Mortise Cylinder with Extended Plug	104207A (P)	\$173.00	\$94.16		\$181.75	
	104207A (S)	\$159.00	\$86.66		\$167.75	
6 Pin LFIC Mortise Cylinder with 15 Amp Micro Switch	320200B (P)	\$400.37			\$414.62	
	320200B (S)	\$386.37			\$400.62	
1 1/4" 6 Pin Mortise Cylinder for VingCard® Persona®	490214 (P)	\$166.00	\$90.34		\$174.36	
	490214 (S)	\$152.00	\$82.84		\$160.36	

Mortise Cylinder Plugs

Description	Part Number	Price
Plug for 10-0200 (Medeco Original®)	12005002 -	\$62.30
Plug for 10W0200 (Medeco Biaxial®)	12005006 W	\$62.30
Plug for 10T0200 (Medeco ³ ®)	1200500 T	\$62.30
Plug for 10-0500 (Medeco Original®)	12020002 -	\$65.73
Plug for 10W0500 (Medeco Biaxial®)	12020006 W	\$65.73
Plug for 10T0500 (Medeco ³ ®)	1202000 T	\$62.30
Plug for 10-0100 (Medeco Original®)	12021002 -	\$65.73
Plug for 10W0100 (Medeco Biaxial®)	12021006 W	\$65.73
Plug for 10T0100 (Medeco ³ ®)	1202100 T	\$62.30
Plug for 10J0500 (Medeco ³ BiLevel®)	1239000 J	\$62.30
Plug for 10J0100 (Medeco ³ BiLevel®)	1239100 J	\$62.30
Plug for 10J0200 (Medeco ³ BiLevel®)	1251300 J	\$62.30

















Include finish and keyway with all part #'s. Medeco³ or Medeco BiLevel Slider package sold separately.

(P) = Pinned (combined)

(S) = Sub-assembled (uncombined)

Surcharges for Master Keying, Custom Coining and Custom Stamping apply, see page 202. Refer to the XT and CLIQ Intelligent Key sections for format availability and pricing.

Mortise Cams















	Description	Part Number	Price
	Corbin Russwin® Type	CT-Z00	\$4.71
	Standard Yale® Type	CT-Z01	\$4.71
	Adams Rite® Type	CT-Z02	\$4.71
	Keil® Norwalk Type	CT-Z04	\$4.71
	Schlage® Type	CT-Z05	\$4.71
	Medium Yale® Type	CT-Z06	\$4.71
	Segal® Type	CT-Z07	\$4.71
	Lockwood® Type	CT-Z08	\$4.71
	Corbin Russwin® Type	CT-Z09	\$4.71
	Segal® Deadbolt Type	CT-Z16	\$4.71
	Corbin Russwin® Oversized Jumbo	CT-Z17	\$4.71
	For Night Deposit Lock	CT-Z18	\$4.71
	General® Lock	CT-Z19	\$4.71
	Sargent® Type	CT-Z20	\$4.71
	Ruko® Type	CT-Z21	\$4.71
	Falcon® Type	CT-Z22	\$4.71

(P) = Pinned (combined)

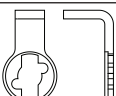
(S) = Sub-assembled (uncombined)

Surcharges for Master Keying, Custom Coining and Custom Stamping apply, see page 202.
Refer to the XT and CLIQ Intelligent Key sections for format availability and pricing.

Mortise Cams

	Description	Part Number	Price
	Schlage® Type	CT-Z34	\$4.71
	Mogul Lock	CT-Z45	\$4.71
	Yale® Mortise After 1982	CT-Z47	\$4.71
	Dominion®	CT-Z48	\$4.71
	Corbin Russwin® Jumbo	CT-Z55	\$4.71
	Yale® Medium After 1982	CT-Z56	\$4.71
	Medeco Residential	CT-Z57	\$4.71
	Falcon® Type	CT-Z58	\$4.71
	Corbin Russwin® Master Ring clover leaf for deadbolt function locks made since 6/93	CT-Z59	\$4.71
	Hook Type for Detention Locks	CT-Z61	\$5.53
	Mogul clover leaf	CT-Z69	\$13.10
	Best® Hotel Function Reversible Lock	CT-Z70	\$4.71
	Marks® J Type	CT-Z84	\$4.71
	VingCard® Persona®	CT-Z87	\$4.71
	Falcon® Type	CT-Z99	\$4.71
	Sargent Mogul	CT-ZA6	\$4.71

(P) = Pinned (combined)

(S) = Sub-assembled (uncombined)

Surcharges for Master Keying, Custom Coining and Custom Stamping apply, see page 202.
Refer to the XT and CLIQ Intelligent Key sections for format availability and pricing.

Mortise Components

Description	Part Number	Price
1-1/2" Dia. Threaded Adapter Ring for Corbin® Jumbo Mortise Cylinder (converts conventional size Mortise Cylinder to Jumbo thread size) Contains: CP-050131 Adapter Ring and CP-011013-030		
# 8-32 x 3/16" Set Screws	940010	\$56.00
Medeco ³ Slider Package, Includes Slider & Spring	94-0174-XX	\$14.10
Medeco ³ BiLevel slider package	94-0227-XX	\$14.10
# 2-56 UNC x 5/16" Length Phillips® Head Screws- Stainless Steel (used to attach cams to Mortise Cylinders)	CP-010203-050	\$0.25
Set Screws (for Medeco X4 pin chamber) # 6-32 x 1/8"	CP-011011-020	\$0.26
Set Screws (for High Security pin chambers) #8-32 x 1/8"	CP-011013-020	\$0.31
Cam Washer for Mortise Cylinders	CP-021011	\$0.83
Sidebar Spring-Stainless Steel	CP-030018	\$0.10
Mounting Nut for Mortise Cylinder 1.150"-32 UNS Inside Dia.	CP-050120	\$12.40
5 Pin Sidebar Assembly, .123" high for Door Hardware Cylinders	CP-084571	\$8.49
6 Pin Sidebar Assembly, .123" high for Door Hardware Cylinders	CP-084671	\$8.49

Rim Cylinders

Description	Part Number	M4/M ³	BiLevel	X4	Biax/Orig	KeyMark
5 Pin 1-1/16" Rim Cylinder - Horizontal Tailpiece	100300H (P)	\$164.00	\$89.25	\$118.10	\$172.25	\$125.15
	100300H (S)	\$150.00	\$81.75	\$104.10	\$158.25	\$111.15
5 Pin 1-1/16" Rim Cylinder - Vertical Tailpiece	100300V (P)	\$164.00	\$89.25	\$118.10	\$172.25	\$125.15
	100300V (S)	\$150.00	\$81.75	\$104.10	\$158.25	\$111.15
5 Pin 1-1/16" Rim Cylinder, Sargent® Mounting Style, Horizontal Tailpiece	100305H (P)	\$164.00	\$89.25	\$118.10	\$172.25	\$125.15
	100305H (S)	\$150.00	\$81.75	\$104.10	\$158.25	\$111.15
5 Pin 1-1/16" Rim Cylinder, Sargent® Mounting Style, Vertical Tailpiece	100305V (P)	\$164.00	\$89.25	\$118.10		
	100305V (S)	\$150.00	\$81.75	\$104.10		
5 Pin 1-1/16" Rim Cylinder, 180 Degree Lazy Motion	100600 (P)	\$174.00	\$94.70		\$182.80	
	100600 (S)	\$160.00	\$87.20		\$168.80	
6 Pin, 1-1/8" Rim Cylinder Horizontal Tailpiece	100400H (P)	\$174.00	\$94.70	\$117.12	\$182.80	\$124.61
	100400H (S)	\$160.00	\$87.20	\$103.12	\$168.80	\$110.61
6 Pin, 1-1/8" Rim Cylinder Vertical Tailpiece	100400V (P)	\$174.00	\$94.70	\$117.12	\$182.80	\$124.61
	100400V (S)	\$160.00	\$87.20	\$103.12	\$168.80	\$110.61
6 Pin 1-1/8" Rim Cylinder- Sargent® Mounting Style, Horizontal Tailpiece	100403H (P)	\$174.00	\$94.70	\$117.12	\$182.80	\$124.61
	100403H (S)	\$160.00	\$87.20	\$103.12	\$168.80	\$110.61
6 Pin 1-1/8" Rim Cylinder- Sargent® Mounting Style, Vertical Tailpiece	100403V (P)	\$174.00	\$94.70	\$117.12	\$182.80	\$124.61
	100403V (S)	\$160.00	\$87.20	\$103.12	\$168.80	\$110.61
6 Pin 1-1/8" Rim Cylinder, 180 Degree Lazy Motion	100700 (P)	\$174.00	\$94.70	\$117.12	\$182.80	\$124.61
	100700 (S)	\$160.00	\$87.20	\$103.12	\$168.80	\$110.61
6 Pin Jumbo Rim Cylinder Corbin Russwin® Master Ring Cylinder Replacement	101355 (P)	\$222.00			\$233.44	
	101355 (S)	\$208.00			\$219.44	
6 Pin 1-15/32" Rim Cylinder with Extended Plug and Horizontal Tailpiece	104407HA (P)	\$173.00			\$181.16	
	104407HA (S)	\$159.00			\$167.16	

6 Pin high security cylinders are available in 7 Pin in Medeco X4.

(P) = Pinned (combined)

(S) = Sub-assembled (uncombined)

Surcharges for Master Keying, Custom Coining and Custom Stamping apply, see page 202.
Refer to the XT and CLIQ Intelligent Key sections for format availability and pricing.

Rim Cylinder Plugs

Description	Part Number	Price
Plug for 10-0300H or 10-0300V (Medeco Original®)	12001002 -	\$65.73
Plug for 10W0300H & 10W0300V (Medeco Biaxial®)	12001006 W	\$62.30
Plug for 10T0300 (Medeco ³ ®)	1200100 T	\$62.30
Plug for 10-0400H or 10-0400V (Medeco Original®)	12030002 -	\$65.73
Plug for 10W0400H & 10W0400V (Medeco Biaxial®)	12030006 W	\$65.73
Plug for 10T0400 (Medeco ³ ®)	1203000 T	\$62.30
Plug for 10J0300 (Medeco BiLevel®)	1238900 J	\$62.30
Plug for 10J0400 (Medeco BiLevel®)	1251200 J	\$62.30

Add finish and keyway to all part #'s .

Medeco³ or Medeco BiLevel Slider package sold separately .

Rim Components







Description	Part Number	Price
Medeco ³ Slider Package, Includes Slider & Spring	94-0174-XX	\$14.10
Medeco BiLevel slider package	94-0227-XX	\$14.10
Set Screws (for Medeco X4 pin chamber) #6-32 x 1/8"	CP-011011-020	\$0.26
Set Screws (for HS pin chambers) #8-32 x 1/8"	CP-011013-020	\$0.31
Rim Cylinder Mounting Screws (#12-24 UNF x 1-7/8" Length)	CP-012917-000	\$0.59
Rim Cylinder Plug Retainer	CP-020010	\$0.69
Screw-on Cap Rim Tailpiece Retainer	CP-021121	\$15.20
Sidebar Spring-Stainless Steel	CP-030018	\$0.10
Back of Plug Roll Pin 3/32" Dia. x .437" Length	CP-060203	\$0.46
5 Pin Sidebar Assembly, .123" high for Door Hardware Cylinders	CP-084571	\$8.49
6 Pin Sidebar Assembly, .123" high for Door Hardware Cylinders	CP-084671	\$8.49
Rim Cylinder Mounting Plate	CP-180031	\$1.88

(P) = Pinned (combined)



(S) = Sub-assembled (uncombined)

Surcharges for Master Keying, Custom Coining and Custom Stamping apply, see page 202.
Refer to the XT and CLIQ Intelligent Key sections for format availability and pricing.

Collars & Cylinder Rings

	Description	Part Number	Price
	Tapered Cylinder Collar	94-0188-XX	\$17.60
	1/4" Thick Spacer Ring 1.165" Inside Diameter x 1.375 Outside Diameter	CP-070011	\$29.60
	1/8" Thick Spacer Ring 1.165" Inside Diameter x 1.375 Outside Diameter	CP-070451	\$23.60
	Raised Cylinder Ring	CP-180021	\$10.60
	Flush Cylinder Ring	CP-180041	\$10.40
	Adjustable Cylinder Collar	CP-160180	\$29.60

Rim Tailpieces

	Description	Part Number	Price
	Tailpiece for Rim Cylinder (155/64") Before 1980, After 1983	CT-Y02	\$4.71
	Lazy Motion Tailpiece (2 29/64")	CT-Y08	\$4.71
	Tailpiece for Rim Cylinder (2 9/16")	CT-Y32	\$4.71

(P) = Pinned (combined)

(S) = Sub-assembled (uncombined)

Surcharges for Master Keying, Custom Coining and Custom Stamping apply, see page 202.
Refer to the XT and CLIQ Intelligent Key sections for format availability and pricing.

Key-in-Knob/Lever Cylinders

FEATURES	Medeco 4	BiLevel	Medeco X4	CLIQ	Medeco XT
Utility patented key control provides protection from unauthorized duplication of keys	● (pending)	●	●	●	●
UL437 Listing and BHMA Certification provide validation of high security from recognized, independent testing laboratories	●				
Triple locking principle provides pick resistance and large numbers of combinations for master keying flexibility to accommodate systems of virtually any size	●				
Hardened steel inserts in the cylinder face provide proven drill resistance	●				
Nickel plated pins provide exceptional wear resistance and additional hardened stainless steel pins provide drill resistance	●				
Solid nickel silver bottom pins provide exceptional wear resistance			●		
Retrofits into virtually any manufacturers' locksets for cost effective improved security	●	●	●	●	●
High security and key control may be incorporated in a single system for cost effective system flexibility	●	●		●	
Keys may be integrated with Hybrid proximity head for greater system retrofit	●	●	●	●	

Medeco 4 Premium High Security

For effective mechanical protection against most forms of attack as well as protection against unauthorized duplicate keys, Medeco 4 cylinders are recommended. Security features including hardened steel components, pins that must be elevated, rotated, and interact with a sidebar which is engaged by the movable element in the key make Medeco 4 the cylinder of choice to protect people, property and information.

Medeco 4 BiLevel Key Control

Medeco 4 BiLevel cylinders may be incorporated into a master key system with Medeco 4 high security, offering protection against all types of attack where needed, and patented key control cylinders for areas requiring less protection. BiLevel cylinders offer patented control against unauthorized duplication of keys without the additional security features protecting against force or surreptitious attack.

Medeco X4 Patented Key Control

Medeco X4 cylinders offer patented control against unauthorized duplication of keys without the additional security features protecting against force or surreptitious attack.

Intelligent Key Solutions

Many of the cylinders in this section are also available with an Intelligent Key solution. See the Intelligent Key section for more details.

Key-in-Knob/Lever Cylinders

Medeco Key-in-Knob cylinders are designed to retrofit knob type cylindrical locksets, lever type cylindrical locksets, padlocks and bored type auxiliary deadlatches and deadlocks. Medeco 4 Key-in-Knob cylinders are UL437 listed for drill and pick resistance, and utility patented pending key control. Medeco offers one of the largest ranges of retrofit cylinders in the industry, supporting the most popular security hardware.



Key Control

Patent-pending key control Protects against unauthorized duplication of keys.



Protection Against 3D Printing

A patent-pending movable element in the key deters against unauthorized 3D printed copies of keys or blanks.



Picking and Bumping Protection

M4 cylinders use cylinder side pins, a shuttle lift pin and a movable key element to engage a sidebar that prevents the key from turning until the elements are rotated and aligned in the correct position, protecting against bumping, picking and other attacks.



Uses Existing Hardware

M4 cylinders are available in a wide variety of formats, retrofitting most hardware on the market.



Protection From Physical Attack

M4 cylinders are UL 437 listed and UL test lab proven to stand up to drilling, picking and other forms of physical attack.



Special Angled Cut Keys

A special key cutting machine and access to Medeco-specific blanks are required to duplicate M4 keys, which are available in multiple levels of restriction to support every need.



Master Keying Capabilities

M4 cylinders can be master keyed into a system that includes M4, M4 BiLevel, and M4 CLIQ keys and cylinders. Extremely large systems are possible.

Applications:

Over 100 different cylinder designs and tailpiece configurations enable Medeco to offer the largest retrofit capability in the industry.

Warranty:

Warranted for two (2) years against manufacturer's defects. See the Medeco® limited warranty for full details.

Technical Information:

- ANSI A156.30 Level A certification assures patent protected key control and physical strength (Medeco 4, M3)
- ANSI A156.5 Grade 1 certification assures consistent quality for heavy use applications (Medeco 4, M3)
- Medeco cylinders are constructed of durable machined brass components

Finishes:

- Available in all standard finishes to match existing hardware

Available Key Technologies:

Mechanical:

- Medeco 4
- Medeco 4 BiLevel
- Medeco³
- Medeco³ BiLevel
- X4

e Cylinder:

- M4 CLIQ
- M³ CLIQ
- Classic CLIQ
- XT
- X4 CLIQ

How To Order Key-in-Knob/Lever Cylinders

Complete part numbers are required for all orders. To determine the correct part number, fill in the "X's" in sequential order.

<p>1</p> <p>200200S1 base part #</p> <p>Refer to pages 84-98 for descriptions and technical specifications to find the corresponding base part number.</p>	<p>2</p> <p>H technology</p> <p>H = Medeco 4 T = Medeco³ W = Biaxial - = Original J = Medeco³ BiLevel N = X4 K = KM P = M4 BiLevel Q = M4 CLIQ S = M3 CLIQ M = X4 CLIQ C = Classic CLIQ</p>	<p>3</p> <p>05 finish</p> <p>Refer to the inside back cover of this catalog for finish options. Include the corresponding two digit finish number.</p>	<p>4</p> <p>M4 keyway</p> <p>Insert keyway if known or contact Customer Service for help.</p>	<p>5</p> <p>P pinning</p> <p>S = Sub-Assembled (Uncombined) N = Sub-assembled, - No Side Pins (M4 only) - No slider (M3 only) P = Pinned (Combinated) M = Master Keyed R = Master Keyed - blade and side pins (Medeco 4 only)</p>	<p>6</p> <p>624 side pin code (Medeco 4 only)</p> <p>Insert side pin code if known or contact Customer Service for help.</p>
------------------------------------------------------------------------------------------------------------------------------------------------------------------------------	---------------------------------------------------------------------------------------------------------------------------------------------------------------------------------------------------------------------------------------------------------------------------------	--------------------------------------------------------------------------------------------------------------------------------------------------------------------------	-----------------------------------------------------------------------------------------------------------------	-----------------------------------------------------------------------------------------------------------------------------------------------------------------------------------------------------------------------------------------------------------------------------	----------------------------------------------------------------------------------------------------------------------------------------------------

BUILD A KEY-IN-KNOB/LEVER PART #:

200200S1 X XX XX X XXX

<p>Key-in-Knob/Lever Cylinder</p> <p>Obtain from Product Listing</p> <p>Technology</p> <p>H = Medeco 4 T = Medeco³ W = Biaxial - = Original J = Medeco³ BiLevel N = X4 K = KM P = M4 BiLevel Q = M4 CLIQ S = M3 CLIQ M = X4 CLIQ C = Classic CLIQ</p>	<p>Finish</p> <p>05 = Bright Brass (US03) 06 = Satin Brass (US04) 09 = Antique Brass (US5) 11 = Bright Bronze (US9) 12 = Satin Bronze (US10) 13 = Dark Bronze/Oil Rubbed (US10B) 18 = Bright Nickel (US14) 19 = Satin Nickel (US15) 20 = Antique Nickel (US15A) 22 = Flat Black (US19) 24 = Dark Bronze/Clear Coat (US20A) 25 = Bright Chrome (US26) 26 = Satin Chrome (US26D)</p>	<p>Keyway</p>	<p>Pinning</p> <p>S = Sub Assembled N = Sub Assembled - No side pins (M4 only) - No slider (M3 only) P = Pinned M = Master Keyed R = Master Keyed blade and side pins (Medeco 4 only)</p>	<p>Side Pin Code (Medeco 4 only)</p>
----------------------------------------------------------------------------------------------------------------------------------------------------------------------------------------------------------------------------------------------------------------------------------------------------------------------------------------------	-------------------------------------------------------------------------------------------------------------------------------------------------------------------------------------------------------------------------------------------------------------------------------------------------------------------------------------------------------------------------------------------------------------------------------------------	----------------------	--------------------------------------------------------------------------------------------------------------------------------------------------------------------------------------------------------------------------	-------------------------------------------------







Alarm Lock Cylinder

Description	Part Number	M4/M ³	BiLevel	X4	Biax/Orig	KeyMark
 6 Pin Cylinder for Alarm Lock Trilogy® T1, T2, T3	20200V1 (P)	\$151.00	\$82.17	\$95.55	\$158.53	\$101.44
	20200V1 (S)	\$137.00	\$74.67	\$81.55	\$144.53	\$87.44

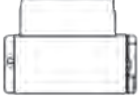
Anderson® Cylinder

Description	Part Number	M4/M ³	BiLevel	X4	Biax/Orig	KeyMark
 5 Pin Cylinder for Anderson® Doors Frenchwood Hinged and Out Swinging Doors Estate and Metro Design	20110039 (P)	\$151.00	\$82.17		\$158.53	
	20110039 (S)	\$137.00	\$74.67		\$144.53	

Arrow Cylinder

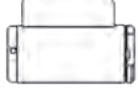
Description	Part Number	M4/M ³	BiLevel	X4	Biax/Orig	KeyMark
 6 Pin Cylinder Package for Arrow® "MK" Series includes CT-Y70, CT-Y73, CP-160321	20200A1 (P)	\$152.98	\$84.14	\$97.53	\$160.51	\$103.42
	20200A1 (S)	\$138.98	\$76.64	\$83.53	\$146.51	\$89.42
 Arrow® and Schlage® Packages Combined	20200H1 (P)	\$160.62	\$91.78	\$105.17	\$168.16	\$111.06
	20200H1 (S)	\$146.62	\$84.28	\$91.17	\$154.16	\$97.06
 6 Pin Cylinder for Arrow® "MK" Series (Except Ball) Original Cylinder Spacer must be replaced with Medeco Cylinder Spacer CP-160321	2020070 (P)	\$151.00	\$82.17	\$95.55	\$158.53	\$101.44
	2020070 (S)	\$137.00	\$74.67	\$81.55	\$144.53	\$87.44
 6 Pin Cylinder for Arrow RK Series	2020071 (P)	\$151.00	\$82.17	\$95.55	\$158.53	\$101.44
	2020071 (S)	\$137.00	\$74.67	\$81.55	\$144.53	\$87.44
 6 Pin Cylinder for Arrow® "MK" Series (B Knob Only) & GL Series Levers	2020073 (P)	\$151.00	\$82.17	\$95.55	\$158.53	\$101.44
	2020073 (S)	\$137.00	\$74.67	\$81.55	\$144.53	\$87.44
 6 Pin Cylinder for Arrow® "H", "S", & "HK" Knob Series, "Q", "L" Series Lever	2020249 (P)	\$151.00	\$82.17	\$95.55	\$158.53	\$101.44
	2020249 (S)	\$137.00	\$74.67	\$81.55	\$144.53	\$87.44
 6 pin cylinder for Arrow "QL" and "MLX" Series Levers	2020049 (P)	\$151.00	\$82.17	\$95.55	\$158.53	\$101.44
	2020049 (S)	\$137.00	\$74.67	\$81.55	\$144.53	\$87.44
 6 Pin Cylinder for Arrow® "M" Series (Tulip or Tudor) Knobs	208008 (P)	\$151.00	\$82.17	\$95.55	\$158.53	\$101.44
	208008 (S)	\$137.00	\$74.67	\$81.55	\$144.53	\$87.44
 6 Pin Cylinder for Arrow® "RL" Series Levers	2080700 (P)	\$151.00	\$82.17	\$95.55	\$158.53	\$101.44
	2080700 (S)	\$137.00	\$74.67	\$81.55	\$144.53	\$87.44

(P) = Pinned (combined)



(S) = Sub-assembled (uncombined)

Surcharges for Master Keying, Custom Coining and Custom Stamping apply, see page 202.
Refer to the XT and CLIQ Intelligent Key sections for format availability and pricing.

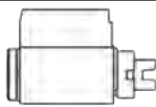
Baldwin® Cylinders

Description	Part Number	M4/M³	BiLevel	X4	Biax/Orig	KeyMark
 5 Pin Cylinder for Baldwin® for 5245, 5250, 5255 Levers & 5215, 5225 Knobs	2001300 (P)	\$151.00	\$82.17		\$158.53	
	2001300 (S)	\$137.00	\$74.67		\$144.53	
 5 Pin Cylinder for Baldwin® for 5205, 5210 Knobs & 5270, 5280 Levers, (Not available in Original Technology)	2001200 (P)	\$151.00	\$82.17		\$158.53	
	2001200 (S)	\$137.00	\$74.67		\$144.53	

Cal-Royal Cylinders









Description	Part Number	M4/M³	BiLevel	X4	Biax/Orig	KeyMark
 6 Pin Cylinder for Cal-Royal SL00 Knob Lock and LX01 Lever Lock	2020049 (P)	\$151.00	\$82.17	\$95.55	\$158.53	\$101.44
	2020049 (S)	\$137.00	\$74.67	\$81.55	\$144.53	\$87.44
 6 Pin Cylinder for Cal-Royal CLS03 Classroom Function Grade 2 Lever Lock	20200V1 (P)	\$151.00	\$82.17	\$95.55	\$158.53	\$101.44
	20200V1 (S)	\$137.00	\$74.67	\$81.55	\$144.53	\$87.44
 6 Pin Cylinder for K200, L100, LX100, L200, LX200, Levers	20200S1(P)	\$152.98	\$84.14	\$97.53	\$160.51	\$103.42
	20200S1(S)	\$138.98	\$76.64	\$83.53	\$146.51	\$89.42

(P) = Pinned (combined)

(S) = Sub-assembled (uncombined)

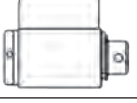
Surcharges for Master Keying, Custom Coining and Custom Stamping apply, see page 202.
Refer to the XT and CLIQ Intelligent Key sections for format availability and pricing.

Corbin Russwin® Cylinders

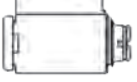

Description	Part Number	M4/M³	BiLevel	X4	Biax/Orig	KeyMark
 6 Pin Cylinder for Corbin Russwin® CL3900	20200V9 (P)	\$151.00	\$82.17	\$95.55	\$158.53	\$101.44
	20200V9 (S)	\$137.00	\$74.67	\$81.55	\$144.53	\$87.44
 6 Pin Cylinder for Corbin Russwin® old style 3300 & 3400 Series	2020575 (P)	\$151.00	\$82.17	\$95.55	\$158.53	\$101.44
	2020575 (S)	\$137.00	\$74.67	\$81.55	\$144.53	\$87.44
 6 Pin Cylinder for Corbin Russwin® 6600 Old Series, CK3400, CK4400 Knob	2020777 (P)	\$151.00	\$82.17	\$95.55	\$158.53	\$101.44
	2020777 (S)	\$137.00	\$74.67	\$81.55	\$144.53	\$87.44
 6 Pin Cylinder for Corbin Russwin® 800, CL3300, CL3400, CL3500, CL3600	20211730 (P)	\$151.00	\$82.17	\$95.55	\$158.53	\$101.44
	20211730 (S)	\$137.00	\$74.67	\$81.55	\$144.53	\$87.44
 5 Pin Cylinder for Corbin Russwin® Knob (Old Style)	205003 (P)	\$152.00	\$82.71	\$96.55	\$159.59	\$102.49
	205003 (S)	\$138.00	\$75.21	\$82.55	\$145.59	\$88.49
 6 Pin Cylinder for Corbin Russwin® 5460A, 5460E (Old Style), 46 F97, 46 F29, 83 F05	205004 (P)	\$151.00	\$82.17	\$95.55	\$158.53	\$101.44
	205004 (S)	\$137.00	\$74.67	\$81.55	\$144.53	\$87.44
 6 Pin Cylinder for Corbin Russwin® CK 4200 (New Style) UT5251	205005 (P)	\$151.00	\$82.17	\$95.55	\$158.53	\$101.44
	205005 (S)	\$137.00	\$74.67	\$81.55	\$144.53	\$87.44
 6 Pin Cylinder for Corbin Russwin® 5460 B, C, D, G, M (Old Style)	205006 (P)	\$151.00	\$82.17	\$95.55	\$158.53	\$101.44
	205006 (S)	\$137.00	\$74.67	\$81.55	\$144.53	\$87.44
 5 Pin Cylinder for Corbin Russwin® 5600 Series Signet® & Ensign®	205008 (P)	\$151.00		\$95.55	\$158.53	\$101.44
	205008(S)	\$137.00		\$81.55	\$144.53	\$87.44

(P) = Pinned (combined)

(S) = Sub-assembled (uncombined)

Surcharges for Master Keying, Custom Coining and Custom Stamping apply, see page 202.
Refer to the XT and CLIQ Intelligent Key sections for format availability and pricing.

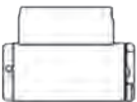
Dorma® Cylinders

Description	Part Number	M4/M³	BiLevel	X4	Biax/Orig	KeyMark
 6 Pin Cylinder for Dorma® CL700 Series Grade 2 Levers	2020049 (P)	\$151.00	\$82.17	\$95.55	\$158.53	\$101.44
	2020049 (S)	\$137.00	\$74.67	\$81.55	\$144.53	\$87.44
 6 Pin Cylinder for Dorma® CL860 (Interior), CL870, CL872, CL873, CL877 Grade 1 Lever, CK860 (Interior), CK870, CK872, CK873, & CK877 Grade 1 Knobs	20200V0 (P)	\$151.00	\$82.17	\$95.55	\$158.53	\$101.44
	20200V0 (S)	\$137.00	\$74.67	\$81.55	\$144.53	\$87.44
 6 Pin Cylinder for Dorma® CL853, CL860 (exterior), CL880, CL882, CL80EL, CL80EU Grade 1 Lever, CK853, CK860 (exterior), CK880, CK882, CK80EL, & CK80EU Grade 1 Knobs	20200V1 (P)	\$151.00	\$82.17	\$95.55	\$158.53	\$101.44
	20200V1 (S)	\$137.00	\$74.67	\$81.55	\$144.53	\$87.44

Emtek® Cylinders

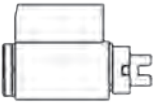
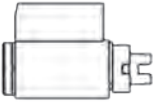
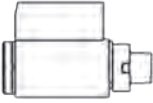







Description	Part Number	M4/M³	BiLevel	X4	Biax/Orig	KeyMark
 5 Pin Cylinder for Emtek® Knobs	2051100 (P)	\$151.00	\$82.17		\$158.53	
	2051100 (S)	\$137.00	\$74.67		\$144.53	
 5 Pin Cylinder for Emtek® Levers, Except Hanover and Helios	2051200 (P)	\$151.00	\$82.17		\$158.53	
	2051200 (S)	\$137.00	\$74.67		\$144.53	
 5 Pin Cylinder for Emtek Hanover and Helios Levers	2052000 (P)	\$151.00			\$158.54	
	2052000 (S)	\$137.00			\$144.54	

(P) = Pinned (combined)

(S) = Sub-assembled (uncombined)

Surcharges for Master Keying, Custom Coining and Custom Stamping apply, see page 202.
Refer to the XT and CLIQ Intelligent Key sections for format availability and pricing.

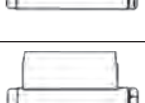
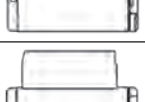
Falcon® Cylinders

Description	Part Number	M4/M³	BiLevel	X4	Biax/Orig	KeyMark
 6 Pin Cylinder for Falcon® Single Cylinder Deadbolt Lock (New Style)	200903 (P)	\$152.00	\$82.71	\$96.55	\$159.59	\$102.49
	200903 (S)	\$138.00	\$75.21	\$82.55	\$145.59	\$88.49
 6 Pin Cylinder for Falcon® "B" Series	2020049 (P)	\$151.00	\$82.17	\$95.55	\$158.53	\$101.44
	2020049 (S)	\$137.00	\$74.67	\$81.55	\$144.53	\$87.44
 6 Pin Cylinder for Falcon® F521, F561, F581 and "N" Series Knobs	2020051 (P)	\$151.00	\$82.17	\$95.55	\$158.53	\$101.44
	2020051 (S)	\$137.00	\$74.67	\$81.55	\$144.53	\$87.44
 6 Pin Cylinder for Falcon® "S" Series (Except "H" Knob)	2020054 (P)			\$95.55		\$101.44
	2020054 (S)			\$81.55		\$87.44
 6 Pin Cylinder for Falcon® "S" Series ("H" Knob Only)	2020058 (P)			\$95.55		\$101.44
	2020058 (S)			\$81.55		\$87.44
 6 Pin Cylinder for Falcon® "X" Series (Except "H" Knob)	2020068(P)	\$151.00	\$82.17	\$95.55	\$158.53	\$101.44
	2020068(S)	\$137.00	\$74.67	\$81.55	\$144.53	\$87.44
 6 Pin Cylinder for Falcon® "X" Series ("H" Knobs Only) Original Cylinder Spacer must be replaced with Medeco Cylinder Spacer CP-160321	2020071 (P)	\$151.00	\$82.17	\$95.55	\$158.53	\$101.44
	2020071 (S)	\$137.00	\$74.67	\$81.55	\$144.53	\$87.44
 6 Pin Cylinder for Falcon® "LY" Lever	2020072 (P)	\$151.00	\$82.17	\$95.55	\$158.53	\$101.44
	2020072 (S)	\$137.00	\$74.67	\$81.55	\$144.53	\$87.44
 6 Pin Cylinder for Falcon® Inside Cylinder T-381	2020073 (P)	\$151.00	\$82.17	\$95.55	\$158.53	\$101.44
	2020073 (S)	\$137.00	\$74.67	\$81.55	\$144.53	\$87.44
 6 Pin Cylinder for Falcon® "B", "LY", "X", "S", & "T" series includes: CT-Y49, CT-Y54, CT-Y58, CT-Y68, CT-Y71, CT-Y72, CT-V03, CP-160311	20200F1 (P)	\$152.98	\$84.14	\$97.53	\$160.51	\$103.42
	20200F1 (S)	\$138.98	\$76.64	\$83.53	\$146.51	\$89.42
 6 Pin Cylinder for Falcon® "RU" Series and T381 Outside Cylinder	20200V3 (P)	\$151.00	\$82.17	\$95.55	\$158.53	\$101.44
	20200V3 (S)	\$137.00	\$74.67	\$81.55	\$144.53	\$87.44

(P) = Pinned (combined)



(S) = Sub-assembled (uncombined)

Surcharges for Master Keying, Custom Coining and Custom Stamping apply, see page 202.
Refer to the XT and CLIQ Intelligent Key sections for format availability and pricing.

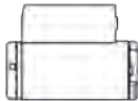

Hager® Cylinders

Description	Part Number	M4/M ³	BiLevel	X4	Biax/Orig	KeyMark
 6 Pin Cylinder for Hager® Lever Locksets, 3500 Series	2020249 (P)	\$151.00	\$82.17	\$95.55	\$158.53	\$101.44
	2020249 (S)	\$137.00	\$74.67	\$81.55	\$144.53	\$87.44





KABA® Mas-Hamilton Cylinders

Description	Part Number	M4/M ³	BiLevel	X4	Biax/Orig	KeyMark
 MAS-Hamilton® Power Lever	20200V1 (P)	\$151.00	\$82.17	\$95.55	\$158.53	\$101.44
	20200V1 (S)	\$137.00	\$74.67	\$81.55	\$144.53	\$87.44
 6 pin cylinder for Kaba E-plex 2000 (18 bow key req. for Orig/Biax)	2051500 (P)	\$151.00	\$82.17	\$95.55	\$158.53	\$101.44
	2051500 (S)	\$137.00	\$74.67	\$81.55	\$144.53	\$87.44

Lockwood® Cylinders

Description	Part Number	M4/M ³	BiLevel	X4	Biax/Orig	KeyMark
 5 Pin Cylinder for Lockwood® 530	201006 (P)	\$151.00				
	201006 (S)	\$137.00				
 6 Pin Cylinder for Lockwood®	2020169 (P)	\$151.00	\$82.17	\$95.55	\$158.53	\$101.44
	2020169 (S)	\$137.00	\$74.67	\$81.55	\$144.53	\$87.44

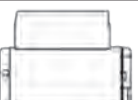
LSDA® Cylinders



Description	Part Number	M4/M ³	BiLevel	X4	Biax/Orig	KeyMark
 6 Pin cylinder for LSDA® 100 Series Knob (Except "B" Knob), L100 Series Lever	2020070 (P)	\$151.00	\$82.17	\$95.55	\$158.53	\$101.44
	2020070 (S)	\$137.00	\$74.67	\$81.55	\$144.53	\$87.44
 6 Pin Cylinder for LSDA® 100 (B Knob Only)	2020073 (P)	\$151.00	\$82.17	\$95.55	\$158.53	\$101.44
	2020073 (S)	\$137.00	\$74.67	\$81.55	\$144.53	\$87.44
 6 Pin Cylinder for LSDA® LX1000 Lever	2020078 (P)	\$151.00	\$82.17	\$95.55	\$158.53	\$101.44
	2020078 (S)	\$137.00	\$74.67	\$81.55	\$144.53	\$87.44
 6 Pin cylinder package for LSDA® 100, L100, LH1000, LX1000 Series. Includes: CT-Y49, CTY70, CT-Y73, CT-Y78	20200L1 (P)	\$152.98	\$84.14	\$97.53	\$160.51	\$103.42
	20200L1 (S)	\$138.98	\$76.64	\$83.53	\$146.51	\$89.42

(P) = Pinned (combined)

(S) = Sub-assembled (uncombined)

Surcharges for Master Keying, Custom Coining and Custom Stamping apply, see page 202.
Refer to the XT and CLIQ Intelligent Key sections for format availability and pricing.



Marks® Cylinders

Description	Part Number	M4/M³	BiLevel	X4	Biax/Orig	KeyMark
 6 Pin Cylinder for Marks® 110, 170, 180, 190, 195, 295 Series DA-Vestibule, DC & SB Communicating, S-Classroom & Classroom Security Functions	20200V0 (P)	\$151.00	\$82.17	\$95.55	\$158.53	\$101.44
	20200V0 (S)	\$137.00	\$74.67	\$81.55	\$144.53	\$87.44
 6 pin Cylinder for Marks 110, 170, 180, 190, 195, 295 Series in AB-Entrance, DW Institution, F-Storeroom, & T Corridor Functions	20200V1 (P)	\$151.00	\$82.17	\$95.55	\$158.53	\$101.44
	20200V1 (S)	\$137.00	\$74.67	\$81.55	\$144.53	\$87.44



Marvin® Cylinders

Description	Part Number	M4/M³	BiLevel	X4	Biax/Orig	KeyMark
 5 Pin Cylinder for Marvin® Auxiliary Locks	2000827 (P)	\$151.00	\$82.17		\$158.53	
	2000827 (S)	\$137.00	\$74.67		\$144.53	

Medeco Embassy® Cylinders

Description	Part Number	M4/M³	BiLevel	X4	Biax/Orig	KeyMark
 6 Pin Cylinder for Embassy® Vestibule, Communicating, Classroom & Classroom Security Functions. For Embassy Levers sold thru 9/06 & ALL Knobs	20200V0 (P)	\$151.00	\$82.17	\$95.55	\$158.53	\$101.44
	20200V0 (S)	\$137.00	\$74.67	\$81.55	\$144.53	\$87.44
 6 Pin Cylinder for Embassy® in Entrance, Institution, Storeroom, Corridor Functions. For Embassy Levers sold thru 9/06 & ALL Knobs	20200V1 (P)	\$151.00	\$82.17	\$95.55	\$158.53	\$101.44
	20200V1 (S)	\$137.00	\$74.67	\$81.55	\$144.53	\$87.44
 6 Pin Cylinder for Embassy Levers All Functions after 9/2006	2020249 (P)	\$151.00	\$82.17	\$95.55	\$158.53	\$101.44
	2020249 (S)	\$137.00	\$74.67	\$81.55	\$144.53	\$87.44

Olympus® Cylinders



Description	Part Number	M4/M³	BiLevel	X4	Biax/Orig	KeyMark
 6 Pin Cylinder for Olympus® 700LCM, 800LCM Non-key Retaining Cabinet Lock Includes: CT-F34-CT-F38	20009S4 (P)	\$156.20	\$87.36	\$100.75	\$163.74	\$106.64
	20009S4 (S)	\$142.20	\$79.86	\$86.75	\$149.74	\$92.64
 6 Pin Cylinder for Olympus® 700LCM, 800LCM Key Retaining Cabinet lock, Includes: CT-Y49, CT-Y52, CT-Y53, CT-Y54	20200S1 (P)	\$152.98	\$84.14	\$97.53	\$160.51	\$103.42
	20200S1 (S)	\$138.98	\$76.64	\$83.53	\$146.51	\$89.42

(P) = Pinned (combined)

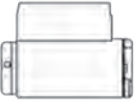

(S) = Sub-assembled (uncombined)

Surcharges for Master Keying, Custom Coining and Custom Stamping apply, see page 202.
Refer to the XT and CLIQ Intelligent Key sections for format availability and pricing.









PDQ® Cylinders

Description	Part Number	M4/M³	BiLevel	X4	Biax/Orig	KeyMark
 6 Pin Cylinder for PDQ® "SX" Series	2020149 (P)	\$151.00	\$82.17		\$158.53	
	2020149 (S)	\$137.00	\$74.67		\$144.53	
 6 Pin Cylinder for PDQ® "SV" Knob/Lever	203000 (P)	\$151.00	\$82.17	\$95.55	\$158.53	\$101.44
	203000 (S)	\$137.00	\$74.67	\$81.55	\$144.53	\$87.44
 6 Pin cylinder for PDQ® Lever SP & ST Series, GT, XGT & GP Series	20200V2 (P)	\$151.00	\$82.17	\$95.55	\$158.53	\$101.44
	20200V2 (S)	\$137.00	\$74.67	\$81.55	\$144.53	\$87.44

Pella® Cylinders

Description	Part Number	M4/M³	BiLevel	X4	Biax/Orig	KeyMark
 5 Pin Knob cylinder to fit popular Pella storm and patio doors	2000827 (P)	\$151.00	\$82.17		\$158.53	
	2000827 (S)	\$137.00	\$74.67		\$144.53	
 5 Pin profile type cylinder to fit popular Pella and Anderson storm and patio doors	490258 (P)	\$192.00			\$201.79	
	490258 (S)	\$178.00			\$187.79	

Sargent® Cylinders







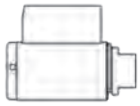

Description	Part Number	M4/M³	BiLevel	X4	Biax/Orig	KeyMark
 6 Pin Cylinder for Sargent® 6 Line (Except for B Knob) & 6500 Lever - For Original Design, otherwise use 20*80147	2020170 (P)	\$151.00	\$82.17	\$95.55	\$158.53	\$101.44
	2020170 (S)	\$137.00	\$74.67	\$81.55	\$144.53	\$87.44
 6 Pin cylinder for Sargent® 6 Line (B Knob Only) Original Cylinder Spacer must be replaced with Medeco Cylinder Spacer CP-160321 (Included) - For Original Design, otherwise use 20*80147	2020173 (P)	\$151.00	\$82.17	\$95.55	\$158.53	\$101.44
	2020173 (S)	\$137.00	\$74.67	\$81.55	\$144.53	\$87.44
 6 Pin Cylinder for Sargent® 10 Line, Levers 7L & 8L - For Original Design, otherwise use 20*80147	2020349 (P)	\$151.00	\$82.17	\$95.55	\$158.53	\$101.44
	2020349 (S)	\$137.00	\$74.67	\$81.55	\$144.53	\$87.44
 6 Pin Cylinder for Sargent® 7600 Integra®	208005 (P)	\$151.00	\$82.17	\$95.55	\$158.53	\$101.44
	208005 (S)	\$137.00	\$74.67	\$81.55	\$144.53	\$87.44
 6 Pin Cylinder for Sargent® 8 & 9 Line knobs	208006 (P)	\$151.00	\$82.17	\$95.55	\$158.53	\$101.44
	208006 (S)	\$137.00	\$74.67	\$81.55	\$144.53	\$87.44
 5 Pin Cylinder for Sargent® 6 Line Includes: CT-Y35, CT-Y37, CT-Y47, CT-Y55	208007 (P)	\$151.00	\$82.17	\$95.55	\$158.53	\$101.44
	208007 (S)	\$137.00	\$74.67	\$81.55	\$144.53	\$87.44
 6 Pin Cylinder for Sargent® 6, 7, & 10 line, 6500 Series (Not Available in Original Technology) Includes: CT-Y35- CT-Y37- CTY47 & CT-Y55	2080147 (P)	\$152.00	\$82.71	\$96.55	\$159.59	\$102.49
	2080147 (S)	\$138.00	\$75.21	\$82.55	\$145.59	\$88.49
 6 Pin Cylinder for Sargent® 11 Line (Not Available in Original Technology)	2080148 (P)	\$152.00	\$82.71		\$159.59	
	2080148 (S)	\$138.00	\$75.21		\$145.59	

(P) = Pinned (combined)

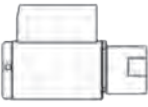
(S) = Sub-assembled (uncombined)

Surcharges for Master Keying, Custom Coining and Custom Stamping apply, see page 202.
Refer to the XT and CLIQ Intelligent Key sections for format availability and pricing.

Schlage® Cylinders



Description	Part Number	M4/M³	BiLevel	X4	Biax/Orig	KeyMark
 5 Pin Knob Cylinder for Schlage® "F" Series Plymouth & Ball Knob (Mfg prior to 2004)	2000400 (P)	\$151.00	\$82.17		\$158.53	
	2000400 (S)	\$137.00	\$74.67		\$144.53	
 6 Pin Cylinder for Schlage® "F" Series Orbit Design Only (Manufactured Prior to 2004)	2000700 (P)	\$151.00	\$82.17	\$95.55	\$158.53	\$101.44
	2000700 (S)	\$137.00	\$74.67	\$81.55	\$144.53	\$87.44
 5 Pin Cylinder for Schlage® "F" Series Lever (Manufactured Prior to 2004)	2001400 (P)	\$151.00	\$82.17		\$158.53	
	2001400 (S)	\$137.00	\$74.67		\$144.53	
 5 Pin Cylinder for Schlage® "F" Series Lever (Manufactured 2004 through 2007)	2001700 (P)	\$151.00	\$82.17		\$158.53	
	2001700 (S)	\$137.00	\$74.67		\$144.53	
 5 Pin Knob Cylinder for Schlage® "A" Series (Ply Only)	200700 (P)	\$151.00	\$82.17		\$158.53	
	200700 (S)	\$137.00	\$74.67		\$144.53	
 5 Pin Knob Cylinder for Schlage® "A" Series (Except Ply)	200701 (P)	\$151.00	\$82.17		\$158.53	
	200701 (S)	\$137.00	\$74.67		\$144.53	
 6 Pin Cylinder for Schlage® "A", "AL", & "D", Series Olympiad® Lever (Use CT-Y73, for "AL" thick doors)	2020049 (P)	\$151.00	\$82.17	\$95.55	\$158.53	\$101.44
	2020049 (S)	\$137.00	\$74.67	\$81.55	\$144.53	\$87.44
 6 Pin Cylinder for Schlage® "C, D" Series (Ply Only)	2020051 (P)	\$151.00	\$82.17	\$95.55	\$158.53	\$101.44
	2020051 (S)	\$137.00	\$74.67	\$81.55	\$144.53	\$87.44
 6 Pin Cylinder for Schlage® "C", & "D" Series Heavy Duty Knobs Ball, Globe & Sphere Designs Only	2020052 (P)	\$151.00	\$82.17	\$95.55	\$158.53	\$101.44
	2020052 (S)	\$137.00	\$74.67	\$81.55	\$144.53	\$87.44
 6 Pin Cylinder for Schlage® "A" Series (Orbit® Only)	2020053 (P)	\$151.00	\$82.17	\$95.55	\$158.53	\$101.44
	2020053 (S)	\$137.00	\$74.67	\$81.55	\$144.53	\$87.44
 6 Pin Knob Cylinder for Schlage® "ND" & "AL" Series Grade 1 Lever. **See note	2020073 (P)	\$151.00	\$82.17	\$95.55	\$158.53	\$101.44
	2020073 (S)	\$137.00	\$74.67	\$81.55	\$144.53	\$87.44
 6 Pin Knob Cylinder for Schlage® "S" Series	2020097 (P)	\$152.98	\$84.14	\$97.53	\$160.51	\$103.42
	2020097 (S)	\$138.98	\$76.64	\$83.53	\$146.51	\$89.42
 6 Pin Knob Cylinder Assembly for Schlage® & Arrow® (Except Arrow "H" & "S" Series) Includes: CT-Y49, CT-Y52, CTY53, CT-Y70, CT-Y73, CT-Y74, CP-160321 **See note	20200H1 (P)	\$160.62	\$91.78	\$105.17	\$168.16	\$111.06
	20200H1 (S)	\$146.62	\$84.28	\$91.17	\$154.16	\$97.06

(P) = Pinned (combined)

(S) = Sub-assembled (uncombined)

Surcharges for Master Keying, Custom Coining and Custom Stamping apply, see page 202.
Refer to the XT and CLIQ Intelligent Key sections for format availability and pricing.

Schlage® Cylinders





Description	Part Number	M4/M ³	BiLevel	X4	Biax/Orig	KeyMark
 6 Pin Cylinder Package for Schlage A, AL, C, D, ND & Olympiad lever designs, includes: CT-Y49 (A, AL, & D Olympiad Lever & C & D Plymouth), CT-Y52 (C & D heavy duty knobs Ball, Globe & Sphere designs only), CT-Y53 (A series Orbit), CT-Y73 (ND series Gr. 1 lever & AL thick doors), and CT-Y74 (45-101 padlock) (Use CT-Y73 for thick doors) ** See note	20200S1 (P)	\$152.98	\$84.14	\$97.53	\$160.51	\$103.42
	20200S1 (S)	\$138.98	\$76.64	\$83.53	\$146.51	\$89.42
 6 Pin Cylinder for Schlage D Series Lever, Athens, Rhodes & Sparta Designs	2020249 (P)	\$151.00	\$82.17	\$95.55	\$158.53	\$101.44
	2020249 (S)	\$137.00	\$74.67	\$81.55	\$144.53	\$87.44

** The ND series with Sparta trim is not compatible with 17 bow (Biaxial large bow) keys. 12 bow (small bow) or 18 bow (large bow/extended throat) keys must be used instead.

Taco® Cylinders

Description	Part Number	M4/M ³	BiLevel	X4	Biax/Orig	KeyMark
 6 Pin Cylinder TACO® LXV Lever Lockset	200500 (P)	\$151.00	\$82.17	\$95.55	\$158.53	\$101.44
	200500 (S)	\$137.00	\$74.67	\$81.55	\$144.53	\$87.44

Yale® Cylinders







Description	Part Number	M4/M ³	BiLevel	X4	Biax/Orig	KeyMark
 6 Pin Cylinder for Yale® Knobs 5300, 5400, 6100, 6200	200500 (P)	\$151.00	\$82.17	\$95.55	\$158.53	\$101.44
	200500 (S)	\$137.00	\$74.67	\$81.55	\$144.53	\$87.44
 6 Pin Cylinder for Yale® 5300LN, 5400LN, 4300 series knobs	200503 (P)	\$151.00	\$82.17	\$95.55	\$158.53	\$101.44
	200503 (S)	\$137.00	\$74.67	\$81.55	\$144.53	\$87.44
 6 Pin cylinder for Yale® YMCL100, YMCL200	2020073 (P)	\$151.00	\$82.17	\$95.55	\$158.53	\$101.44
	2020073 (S)	\$137.00	\$74.67	\$81.55	\$144.53	\$87.44
 6 Pin cylinder for Yale® 4600LN	2080700 (P)	\$151.00	\$82.17	\$95.55	\$158.53	\$101.44
	2080700 (S)	\$137.00	\$74.67	\$81.55	\$144.53	\$87.44

(P) = Pinned (combined)



(S) = Sub-assembled (uncombined)

Surcharges for Master Keying, Custom Coining and Custom Stamping apply, see page 202.
Refer to the XT and CLIQ Intelligent Key sections for format availability and pricing.

Arrow® Deadbolt Cylinders

Description	Part Number	M4/M³	BiLevel	X4	Biax/Orig	KeyMark
 5 Pin Cylinder for Arrow JL Interconnected lock. Separate cylinder required for lever.	1065140 (P)	\$156.00	\$84.89	\$99.12	\$163.81	\$105.62
	1065140 (S)	\$142.00	\$77.39	\$85.12	\$149.81	\$91.62
 5 Pin Cylinder (6 Pin KeyMark) for Arrow D & E Series Single Cylinder Deadbolt	200801 (P)	\$152.00	\$82.71		\$159.59	
	200801 (S)	\$138.00	\$75.21		\$145.59	
 5 Pin Cylinder for Arrow D & E Series Double Cylinder Deadbolt	200802 (P)	\$148.00	\$80.53		\$155.37	
	200802 (S)	\$134.00	\$73.03		\$141.37	
 6 Pin Cylinder for Arrow D & E Series Single Cylinder Deadbolt	200901 (P)	\$152.00	\$82.71	\$96.55	\$159.59	\$102.49
	200901 (S)	\$138.00	\$75.21	\$82.55	\$145.59	\$88.49
 6 Pin Cylinder for Arrow D & E Series Double Cylinder Deadbolt	200902 (P)	\$152.00	\$82.71	\$96.55	\$159.59	\$102.49
	200902 (S)	\$138.00	\$75.21	\$82.55	\$145.59	\$88.49
 6 Pin Cylinder for Arrow Revolution Deadbolt*Order CT-Y27 tailpiece separately	200903 (P)	\$152.00	\$82.71	\$96.55	\$159.59	\$102.49
	200903 (S)	\$138.00	\$75.21	\$82.55	\$145.59	\$88.49

Baldwin® Deadbolt Cylinders

Description	Part Number	M4/M³	BiLevel	X4	Biax/Orig	KeyMark
 5 Pin Rim Type Lazy Motion Single Cylinder handlesets and deadbolts	1075127 (P)	\$182.12	\$107.37	\$103.28	\$190.37	\$109.99
	1075127 (S)	\$168.12	\$99.87	\$89.28	\$176.37	\$95.99
 5 Pin Lazy Motion cylinder for Baldwin 2 point lock handleset (lower cylinder)	2001851 (P)	\$151.00	\$82.17		\$158.53	
	2001851 (S)	\$137.00	\$74.67		\$144.53	

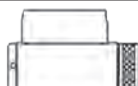

Cal-Royal® Deadbolt Cylinder

Description	Part Number	M4/M³	BiLevel	X4	Biax/Orig	KeyMark
 6 Pin Cylinder for Cal-Royal T-300 Series Grade 2 Deadbolt, Includes: CT-F34, DT-F35, CTF36, CT-F37 & CT-F38	2000954 (P)	\$156.20	\$87.36	\$100.75	\$163.74	\$106.64
	2000954 (S)	\$142.20	\$79.86	\$86.75	\$149.74	\$92.64

Corbin Russwin® Deadbolt Cylinder

Description	Part Number	M4/M³	BiLevel	X4	Biax/Orig	KeyMark
 6 Pin Cylinder for Corbin Russwin DL2100, DL3100 Deadbolt	2051027 (P)	\$151.00	\$82.17	\$95.55	\$158.53	\$101.44
	2051027 (S)	\$137.00	\$74.67	\$81.55	\$144.53	\$87.44

Emtek® Deadbolt Cylinders



Description	Part Number	M4/M³	BiLevel	X4	Biax/Orig	KeyMark
 5 Pin Rim Lazy Motion Rim Type Cylinder to fit Emtek® Handleset & Deadbolt Outside Cylinder	1065140 (P)	\$156.00	\$84.89	\$99.12	\$163.81	\$105.62
	1065140 (S)	\$142.00	\$77.39	\$85.12	\$149.81	\$91.62
 5 Pin Rim Lazy Motion Rim Type Cylinder To Inside Cylinder w/Emtek Tailpiece	1065244 (P)	\$164.00	\$89.25		\$172.25	
	1065244 (S)	\$150.00	\$81.75		\$158.25	

(P) = Pinned (combined)

(S) = Sub-assembled (uncombined)

Surcharges for Master Keying, Custom Coining and Custom Stamping apply, see page 202.
Refer to the XT and CLIQ Intelligent Key sections for format availability and pricing.

Falcon® Deadbolt Cylinders

Description	Part Number	M4/M³	BiLevel	X4	Biax/Orig	KeyMark
 6 Pin Cylinder for Falcon Single Cylinder Deadbolt Lock (New Style)	200903 (P)	\$152.00	\$82.71	\$96.55	\$159.59	\$102.49
	200903 (S)	\$138.00	\$75.21	\$82.55	\$145.59	\$88.49
 5 Pin Cylinder for Falcon Single Cylinder Deadbolt Lock (Old Style)	206005 (P)	\$152.00	\$82.71		\$159.59	
	206005 (S)	\$138.00	\$75.21		\$145.59	
 5 Pin Cylinder for Falcon Double Cylinder Deadbolt Lock (Old Style)	206100 (P)	\$151.00	\$82.17		\$158.53	
	206100 (S)	\$137.00	\$74.67		\$144.53	







Kwikset® Deadbolt Cylinders

Description	Part Number	M4/M³	BiLevel	X4	Biax/Orig	KeyMark
 6 Pin Lazy Motion Rim Type for Kwikset® Single Cylinder deadbolts, except Powerbolt	1012040 (P)	\$160.00	\$87.07		\$168.03	
	1012040 (S)	\$146.00	\$79.57		\$154.03	

PDQ® Deadbolt Cylinder

Description	Part Number	M4/M³	BiLevel	X4	Biax/Orig	KeyMark
 6 Pin Cylinder for PDQ KV Series Deadbolt	200903 (P)	\$152.00	\$82.71	\$96.55	\$159.59	\$102.49
	200903 (S)	\$138.00	\$75.21	\$82.55	\$145.59	\$88.49

Sargent® Deadbolt Cylinder









Description	Part Number	M4/M³	BiLevel	X4	Biax/Orig	KeyMark
 6 Pin Cylinder for 470 & 480 Single Cylinder Deadbolt Lock	200901 (P)	\$152.00	\$82.71	\$96.55	\$159.59	\$102.49
	200901 (S)	\$138.00	\$75.21	\$82.55	\$145.59	\$88.49
 6 Pin Cylinder for Sargent 470 & 480 Double Cylinder Deadbolt Lock	200902 (P)	\$152.00	\$82.71	\$96.55	\$159.59	\$102.49
	200902 (S)	\$138.00	\$75.21	\$82.55	\$145.59	\$88.49
 5 Pin Cylinder for Sargent 470 & 480 Single Cylinder Deadbolt	200801 (P)	\$152.00	\$82.71		\$159.59	
	200801 (S)	\$138.00	\$75.21		\$145.59	
 5 Pin Cylinder for Sargent 470 & 480 Double Cylinder Deadbolt	200802 (P)	\$148.00	\$80.53		\$155.37	
	200802 (S)	\$134.00	\$73.03		\$141.37	
 5 Pin cylinder for Sargent 460 Single Cylinder deadbolt	200807 (P)	\$152.00			\$159.59	
	200807 (S)	\$138.00			\$145.59	
 6 Pin cylinder for Sargent 460 Single Cylinder deadbolt	200907 (P)	\$152.00	\$82.71	\$96.55	\$159.59	\$102.49
	200907 (S)	\$138.00	\$75.21	\$82.55	\$145.59	\$88.49
 5 Pin cylinder for Sargent 460 Double Cylinder deadbolt	200808 (P)	\$152.00			\$159.59	
	200808 (S)	\$138.00			\$145.59	

(P) = Pinned (combined)

(S) = Sub-assembled (uncombined)

Surcharges for Master Keying, Custom Coining and Custom Stamping apply, see page 202.
Refer to the XT and CLIQ Intelligent Key sections for format availability and pricing.

Schlage® Deadbolt Cylinder







Description	Part Number	M4/M³	BiLevel	X4	Biax/Orig	KeyMark
 5 Pin Lazy Motion Schlage® Outside Cylinder for "E", "H", B200, B400 Series Deadbolt (Rim Type Cylinder) includes CT-F34-CT-F38	10651S4 (P)	\$178.62	\$107.51	\$121.74	\$186.43	\$128.24
	10651S4 (S)	\$164.62	\$100.01	\$107.74	\$172.43	\$114.24
 5 Pin Lazy Motion Schlage® Inside Cylinder for B200/B400 Series Deadbolt Lock (Rim Type Cylinder) includes CT-F34-CTF38	10652S4 (P)	\$176.99	\$84.04	\$114.73	\$187.44	\$125.18
	10652S4 (S)	\$162.99	\$76.54	\$100.73	\$173.44	\$111.18
 6 Pin Lazy Motion Schlage® Outside Cylinder for "E", "H", B200, B400 Series Deadbolt Lock (Rim Type Cylinder) includes: CT-F34-CT-F38	10661S4 (P)	\$178.93	\$104.18	\$122.05	\$187.18	\$128.99
	10661S4 (S)	\$164.93	\$96.68	\$108.05	\$173.18	\$114.99
 6 Pin Lazy Motion Schlage® Inside Cylinder for B200 and B400 Series Deadbolt Lock (Rim Type Cylinder) includes: CT-F34-CT-F38	10662S4 (P)	\$176.99	\$84.04	\$114.73	\$187.44	\$125.18
	10662S4 (S)	\$162.99	\$76.54	\$100.73	\$173.44	\$111.18
 5 Pin Laz Motion Cylinder for Schlage B Series Deadbolt Lock (less tailpiece)	2000800 (P)	\$151.00	\$82.17		\$158.53	
	2000800 (S)	\$137.00	\$74.67		\$144.53	
 5 Pin Knob Cylinder for Schlage B, E, and F160 Series Deadbolt lock, includes CT-F34, CT-F38	20008S4 (P)	\$156.20	\$87.36		\$163.74	
	20008S4 (S)	\$142.20	\$79.86		\$149.74	
 6 Pin Lazy Motion Cylinder Schlage B Series (Old Style) deadbolt	200904 (P)	\$152.00	\$82.71	\$96.55	\$159.59	\$102.49
	200904 (S)	\$138.00	\$75.21	\$82.55	\$145.59	\$88.49
 6 Pin Lazy Motion Cylinder for Schlage B Series Deadbolt (less tailpiece) except B662 after 2001	2000900 (P)	\$151.00	\$82.17	\$95.55	\$158.53	\$101.44
	2000900 (S)	\$137.00	\$74.67	\$81.55	\$144.53	\$87.44
 6 Pin Lazy Motion Knob Cylinder for Schlage® "B", "E", and F160 includes: CT-F34, CTF35, CT-F36, CT-F37, CT-F38	20009S4 (P)	\$156.20	\$87.36	\$100.75	\$163.74	\$106.64
	20009S4 (S)	\$142.20	\$79.86	\$86.75	\$149.74	\$92.64

(P) = Pinned (combined)

(S) = Sub-assembled (uncombined)

Surcharges for Master Keying, Custom Coining and Custom Stamping apply, see page 202.
Refer to the XT and CLIQ Intelligent Key sections for format availability and pricing.

Weiser® Deadbolt Cylinders

Description	Part Number	M4/M³	BiLevel	X4	Biax/Orig	KeyMark
 5 Pin Lazy Motion Outside Cylinder for Weiser® Prestige Series Deadbolt and Entryset/ Handleset	100602 (P)	\$149.00	\$81.08	\$100.79	\$156.43	\$108.22
	100602 (S)	\$135.00	\$73.58	\$86.79	\$142.43	\$94.22
 6 Pin Lazy Motion Outside Cylinder for Weiser Prestige Entryset/Handleset	100702 (P)	\$156.00	\$84.89	\$103.74	\$163.81	\$111.55
	100702 (S)	\$142.00	\$77.39	\$89.74	\$149.81	\$97.55
 6 Pin Cylinder for Weiser® Single Cylinder Deadbolt, including powerbolt	200903 (P)	\$152.00	\$82.71	\$96.55	\$159.59	\$102.49
	200903 (S)	\$138.00	\$75.21	\$82.55	\$145.59	\$88.49
 5 Pin Cylinder for Weiser® Single Cylinder Deadbolt	206005 (P)	\$152.00	\$82.71		\$159.59	
	206005 (S)	\$138.00	\$75.21		\$145.59	
 5 Pin Cylinder for Weiser® Double Cylinder Deadbolt	206100 (P)	\$151.00	\$82.17		\$158.53	
	206100 (S)	\$137.00	\$74.67		\$144.53	
 5 Pin Cylinder for Weiser® 4000, 4200 Single Cylinder Deadbolt	207001 (P)	\$152.00	\$82.71		\$159.59	
	207001 (S)	\$138.00	\$75.21		\$145.59	

Yale® Deadbolt Cylinders

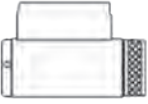
Description	Part Number	M4/M³	BiLevel	X4	Biax/Orig	KeyMark
 6 Pin Cylinder for Yale 3300, 3500, & 3600 Series Deadbolt Locks	2051027 (P)	\$151.00	\$82.17	\$95.55	\$158.53	\$101.44
	2051027 (S)	\$137.00	\$74.67	\$81.55	\$144.53	\$87.44

Abus® Padlock Cylinders

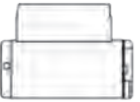
Description	Part Number	M4/M³	BiLevel	X4	Biax/Orig	KeyMark
 6 Pin Cylinder for Abus® Padlock Series 83KNK/45, 83KNK/50 & 83KNK/55	2020000 (P)	\$151.00	\$82.17	\$95.55	\$158.53	\$101.44
	2020000 (S)	\$137.00	\$74.67	\$81.55	\$144.53	\$87.44

American® Padlock Cylinders

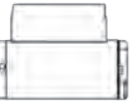
Description	Part Number	M4/M³	BiLevel	X4	Biax/Orig	KeyMark
 6 Pin Cylinder for American® 3600/3700 Padlock (Note: Use American® Driver DR-MED6)	2020000 (P)	\$151.00	\$82.17	\$95.55	\$158.53	\$101.44
	2020000 (S)	\$137.00	\$74.67	\$81.55	\$144.53	\$87.44

Master® Padlock Cylinders

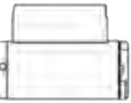
Description	Part Number	M4/M³	BiLevel	X4	Biax/Orig	KeyMark
 6 Pin Cylinder for Master® “29” and 6600, 6700 Pro Series (Note: Use Master® Driver 0298-627 for Pro Series)	2020000 (P)	\$151.00	\$82.17	\$95.55	\$158.53	\$101.44
	2020000 (S)	\$137.00	\$74.67	\$81.55	\$144.53	\$87.44

(P) = Pinned (combined)

(S) = Sub-assembled (uncombined)

Surcharges for Master Keying, Custom Coining and Custom Stamping apply, see page 202.
Refer to the XT and CLIQ Intelligent Key sections for format availability and pricing.

Medeco System Series Padlock Cylinders

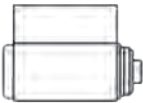
Description	Part Number	M4/M ³	BiLevel	X4	Biax/Orig	KeyMark
 6 Pin cylinder for System Series KIK style padlocks	510600 (P)	\$124.00	\$67.68	\$107.75	\$130.05	\$113.36
	510600 (S)	\$110.00	\$60.18	\$93.75	\$116.05	\$99.36

New Standard Mfg. Co.[®] Padlock Cylinders

Description	Part Number	M4/M ³	BiLevel	X4	Biax/Orig	KeyMark
 6 Pin Cylinder for New Standard [®] Padlocks	2020052 (P)	\$151.00	\$82.17	\$95.55	\$158.53	\$101.44
	2020052 (S)	\$137.00	\$74.67	\$81.55	\$144.53	\$87.44

Schlage[®] Padlock Cylinders

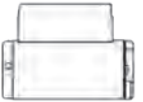
Description	Part Number	M4/M ³	BiLevel	X4	Biax/Orig	KeyMark
 6 Pin Cylinder for Schlage [®] 45-101 Padlock	2020074 (P)	\$151.00	\$82.17	\$95.55	\$158.53	\$101.44
	2020074 (S)	\$137.00	\$74.67	\$81.55	\$144.53	\$87.44

KIK/KIL Cylinder Components

Description	Part Number	Price
Medeco ³ slider package. (Includes slider & spring)	94-0174	\$14.10
Medeco BiLevel slider package	94-0227	\$14.10
Flat Head Machine Screw, 5/16" -#2-56 UNC, Phillips with Nylok Patch for 20-200XX Cylinders. Sold in Bags of 100	CP-010203-050	\$0.25 each
Pan Head Machine Screw, 1/4" -#2-56 UNC, Phillips with Nylok Patch for most Lazy Motion Cylinders. Sold in Bags of 100	CP-010503-040	\$0.38 each
Retaining Ring, Knob Cylinder "E" Clip	CP-020020	\$1.77
Retaining Ring, Knob Cylinder, Full Clip	CP-020040	\$3.41
Retaining Ring, Knob Cylinder Plug Retainer, "C" Clip	CP-020100	\$1.10
Lazy Motion Tailpiece Retainer for 20*090X cylinders	CP-021031	\$2.24
Tailpiece Retainer ring for Arrow and Sargent clip on tailpieces	CP-021130	\$3.18
Plug Retainer, Standard Knob	CP-021370	\$8.61
Castle Nut Retainer for Schlage type lazy motion cylinders	CP-021651	\$13.20
Compression Spring for Schlage type lazy motion cylinders	CP-030670	\$1.77
Drive Disk for Schlage -type Lazy Motion Cylinders	CP-041200	\$4.47
Detent Pin for Schlage type lazy motion cylinders	CP-064490	\$2.12

KIK/KIL Cylinder Plugs

Description	Part Number	Price
Plug for 20-200XX- (Medeco Original)	12126002 -	\$65.73
Plug for 20W200XX (Medeco Biaxial)	12126156 W	\$65.73
Plug for 20T200XX (Medeco ³)	1212633 T	\$62.30

Mailbox Lock Cylinders















Description	Part Number	(S) Pricing	(P) Pricing
6 Pin Medeco ³ Key in Knob Style Mailbox cylinder, less slider	490375 T	\$160.60	N/A
6 Pin Mailbox cylinder. Medeco KM only	200155 K	\$123.17	\$137.17

(P) = Pinned (combined)

(S) = Sub-assembled (uncombined)

Surcharges for Master Keying, Custom Coining and Custom Stamping apply, see page 202.
Refer to the XT and CLIQ Intelligent Key sections for format availability and pricing.

KIK/KIL Cylinder Tailpieces













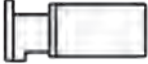

Description	Part Number	Price
 Tailpiece for Schlage® B200, B400, B500, Series (Double Cylinder)	CT-F34	\$4.71
 Tailpiece for Schlage® F160, B100, B200, B400, B500 Series (Double Cylinder)	CT-F35	\$4.71
 Tailpiece for Schlage® B200, B400 Series (Double Cylinder)	CT-F36	\$4.71
 Tailpiece for Schlage® F160, B100, B200, B400, B500 Series (Double Cylinder)	CT-F37	\$4.71
 Tailpiece for Schlage® "E", F160, "H", B100, B200, B400, B500 Series (Single Cylinder)	CT-F38	\$4.71
 Tailpiece for Baldwin® Images Series	CT-F40	\$14.50
 Tailpiece for Marks® 190S Lever Lockset	CT-V00	\$4.71
 Tailpiece for Marks® 190AB Lever Lockset	CT-V01	\$4.71
 Tailpiece for PDQ® SP	CT-V02	\$4.71
 Tailpiece for Falcon® "T" Series	CT-V03	\$4.71
 Tailpiece for Corbin® Russwin® 3900 Series Lever Lock	CT-V19	\$4.71
 Tailpiece for Sargent® 11 Line TZone	CT-V35	\$9.96
 Tailpiece for Anderson® Door Locks	CT-V39	\$4.71
 Tailpiece for Kwikset®	CT-V40	\$19.80
 Tailpiece for Schlage® Lazy Motion	CT-Y08	\$4.71

(P) = Pinned (combined)

(S) = Sub-assembled (uncombined)

Surcharges for Master Keying, Custom Coining and Custom Stamping apply, see page 202.
Refer to the XT and CLIQ Intelligent Key sections for format availability and pricing.

KIK/KIL Cylinder Tailpieces









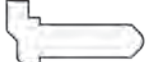

Description	Part Number	Price
 Tailpiece for Schlage® Deadbolt Lock (.542")	CT-Y24	\$4.71
 Tailpiece for Baldwin®, Falcon®, Marvin®, Weiser® & Yale® (Lazy Motion)	CT-Y27	\$4.71
 Tailpiece for Schlage® "G" Series Knob Lock	CT-Y28	\$22.50
 Tailpiece for Weiser® 4370 Deadbolt Lock	CT-Y29	\$4.71
 Tailpiece for Dexter® Double Cylinder Deadbolt Lock 4209	CT-Y31	\$4.71
 Tailpiece for Sargent® 6 Line (.685" Length)	CT-Y35	\$4.71
 Tailpiece for Sargent® 6 Line	CT-Y37	\$4.71
 Tailpiece for Russwin® Forum (20-5008) Line	CT-Y46	\$4.71
 Tailpiece for Arrow® 151 Knob and Sargent® 10 Line	CT-Y47	\$4.71
 Tailpiece for Schlage® "C", "D", & Olympiad® Lever & Falcon® "B", "F" Series	CT-Y49	\$4.71
 Tailpiece for Schlage® "A" Series & "C", "D" Series (Ball, Globe, Sphere Design)	CT-Y52	\$4.71
 Tailpiece for Schlage® "A" Series (Orbit Design Only)	CT-Y53	\$4.71
 Tailpiece for Falcon® "S" Series Knob (Except "H" Knob)	CT-Y54	\$4.71
 Tailpiece for Sargent® 10 Line	CT-Y55	\$4.71
 Tailpiece for Yale® AU5400 Lever Handle (Old Style)	CT-Y57	\$4.71

(P) = Pinned (combined)

(S) = Sub-assembled (uncombined)

Surcharges for Master Keying, Custom Coining and Custom Stamping apply, see page 202.
Refer to the XT and CLIQ Intelligent Key sections for format availability and pricing.

KIK/KIL Cylinder Tailpieces

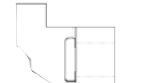
Description	Part Number	Price
 Tailpiece for Falcon® "S" Series "H" Knob	CT-Y58	\$4.71
 Tailpiece for Yale® 5400LN Series Lever Lockset	CT-Y67	\$4.71
 Tailpiece for Falcon® "X" Series Knob (Except "H" Knob)	CT-Y68	\$4.71
 Tailpiece for Lockwood® Knob Lock	CT-Y69	\$4.71
 Tailpiece for Arrow® "M" Series, LSDA® 100 Series & Sargent® 6 Line	CT-Y70	\$4.71
 Tailpiece for Falcon® "X" Series "H" Knob	CT-Y71	\$4.71
 Tailpiece for Falcon® "X" Series Lever Lock	CT-Y72	\$4.71
 Tailpiece for Arrow® "M" Series, LSDA® 100 Series & Sargent® 6 Line (B Knob Only), Schlage ND lever	CT-Y73	\$4.71
 Tailpiece for Schlage® 45-101 Padlock	CT-Y74	\$4.71
 Tailpiece for Russwin® 3300 & 4300 Series	CT-Y75	\$4.71
 Tailpiece for Russwin® 3400 Series & Corbin® 6600 Series	CT-Y77	\$4.71
 Tailpiece for LSDA® LX1000 Lever Lockset	CT-Y78	\$4.71
 Tailpiece for Schlage® "S" Series	CT-Y97	\$32.30

(P) = Pinned (combined)

(S) = Sub-assembled (uncombined)

Surcharges for Master Keying, Custom Coining and Custom Stamping apply, see page 202.
Refer to the XT and CLIQ Intelligent Key sections for format availability and pricing.

KIK/KIL Tailpiece Packages

Description	Part Number	Price
Tailpiece Package for Arrow®: Listed as A1 in cylinder part number. Includes CT-Y70, CT-Y73 & CP-160321 (Spacer)	94-0034	\$13.70
Tailpiece Package for Schlage®: Listed as S1 in cylinder part number. Includes CT-Y49, CT-Y52, CT-Y53, CT-Y73, CT-Y74	94-0036	\$13.70
Tailpiece Package for Falcon®: Listed as F1 in cylinder part number. Includes CT-Y49, CT-Y54, CT-Y58, CT-Y68, CT-Y71, CT-Y72 & CP-160311	94-0035	\$13.70
Tailpiece Package for LSDA®: Listed as L1 in cylinder part number. Includes CT-Y49, CT-Y70, CT-Y73, CT-78	94-0272	\$13.70
Tailpiece Package for Schlage® "S" Series: Includes CT-Y97 & CP-021370	94-0051	\$34.60
Tailpiece package for Arrow®, Schlage® & Sargent®: Listed as H1 in cylinder part number. Includes CT-Y49, CT-Y52, CT-Y53, CT-Y54, CTY70, CT-Y73, & CP-160321	94-0061	\$24.20
Tailpiece Package for Sargent® & Arrow®: Includes CT-Y35, CT-Y37, CT-Y47, CT-Y55	94-0067	\$3.96
Tailpiece Package for Schlage® Deadbolt Cylinders: Listed as S4 in cylinder part number. Includes CT-F34, CT-F35, CT-F36, CT-F37, CT-F38	94-0098	\$13.70

(P) = Pinned (combined)

(S) = Sub-assembled (uncombined)

Surcharges for Master Keying, Custom Coining and Custom Stamping apply, see page 202.
Refer to the XT and CLIQ Intelligent Key sections for format availability and pricing.

Large Format Interchangeable Cores

FEATURES	Medeco 4	BiLevel	Medeco X4	CLIQ	Medeco XT
Utility patented key control provides protection from unauthorized duplication of keys	● (pending)	●	●	●	●
UL437 Listing and BHMA Certification provide validation of high security from recognized, independent testing laboratories	●				
Triple locking principle provides pick resistance and large numbers of combinations for master keying flexibility to accommodate systems of virtually any size	●				
Hardened steel inserts in the cylinder face and hardened steel driver pins provide proven drill resistance	●				
Solid brass construction provides high quality and long cylinder life	●	●	●		
Nickel plated pins designed to provide exceptional wear resistance	●	●	●		
Retrofits into virtually any manufacturers' locksets with a wide selection of interchangeable cams to fit various mortise series hardware for cost effective improved security	●	●	●	●	●
Ability to key with non-interchangeable core cylinders, including rim and mortise, knob style for Medeco BiLevel cost effective system flexibility	●	●	●		
High security and key control may be incorporated in a single system for cost effective system flexibility	●	●		●	

Medeco 4 Premium High Security
 For effective mechanical protection against most forms of attack as well as protection against unauthorized duplicate keys, Medeco 4 cylinders are recommended. Security features including hardened steel components, pins that must be elevated, rotated, and interact with a sidebar which is engaged by the movable element in the key make Medeco 4 the cylinder of choice to protect people, property and information.

Medeco 4 BiLevel Key Control
 Medeco 4 BiLevel cylinders may be incorporated into a master key system with Medeco 4 high security, offering protection against all types of attack where needed, and patent pending key control cylinders for areas requiring less protection. BiLevel cylinders offer patented control against unauthorized duplication of keys without the additional security features protecting against force or surreptitious attack.

Medeco X4 Patented Key Control
 Medeco X4 cylinders offer patented control against unauthorized duplication of keys without the additional security features protecting against force or surreptitious attack.

Intelligent Key Solutions
 Many of the cylinders in this section are also available with an Intelligent Key solution. See the Intelligent Key section for more details.

Large Format Interchangeable Core



Offering increased security without costly and time-consuming rekeying, interchangeable core cylinders enable quick and easy cylinder changes by non-technical personnel by using a special control key to remove the cylinder (core) from the lock housing. A core with a new combination can then be inserted, which in effect rekeys the lock. LFIC cylinders are often used on doors of high-turnover businesses, like fast-food or manufacturing environments, where rapid rekeying is often desirable. Medeco 4's patent-pending high security technology provides protection against unauthorized duplication of keys, along with hardened inserts to resist drilling, and features that protect against other types of attack.



Key Control

Patent-pending key control protects against unauthorized duplication of keys.



Protection Against 3D Printing

A patent-pending movable element in the key deters unauthorized 3D printed copies of keys or blanks.



Picking and Bumping Protection

M4 cylinders use cylinder side pins, a shuttle lift pin and a movable key element to engage a sidebar that prevents the key from turning until the elements are rotated and aligned in the correct position, protecting against bumping, picking and other attacks.



Protection From Physical Attack

M4 LFIC cylinders are UL 437 listed to stand up to drilling, picking and other forms of physical attack.



Special Angled Cut Keys

A special key cutting machine and access to Medeco-specific blanks are required to duplicate M4 keys, which are available in multiple levels of restriction to support every need.



Quickly Change Cores

Provides quick and easy cylinder changes in the event keys are lost or stolen.



Uses Existing Hardware

Medeco offers a large selection of retrofit LFIC that reduce cost by eliminating the need to replace existing hardware.



Master Keying Capabilities

M4 cylinders can be master keyed into a system that includes M4, M4 BiLevel*, and M4 CLIQ** keys and cylinders. Very large systems are possible.

Technical Information:

- Meets ANSI A156.30 assuring patent protected key control and physical strength (Medeco 4, M3)
- ANSI A156.5 Grade 1 certification assures consistent quality for heavy use applications (Medeco 4, M3)
- Solid brass construction provides high quality and long cylinder life
- Nickel plated pins provide exceptional wear resistance and additional hardened stainless steel pins provide drill resistance
- Ability to key with non-interchangeable core cylinders for cost effective system flexibility

Applications:

Office buildings, universities, apartments, perimeter doors, schools and hospitals.

Warranty:

Warranted for two (2) years against manufacturer's defects. See Medeco's limited warranty for full details.

Finishes:

Available in all standard finishes to match with existing hardware.

Available Technologies:







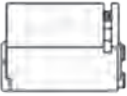

Mechanical:

- Medeco 4
- Medeco 4 BiLevel*
- Medeco³
- Medeco³ BiLevel
- X4

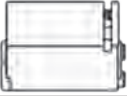
eCylinder:

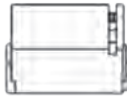
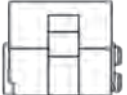

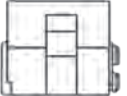
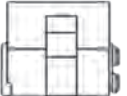
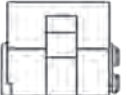

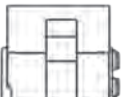

- M4 CLIQ
- M³ CLIQ
- Classic CLIQ

Large Format Interchangeable Core

Description	Part Number	M4/M ³	BiLevel	X4	Biax/Orig	KeyMark
 Yale® Large Format Interchangeable Core, 6 Pin (Masterkey upcharges apply)	310100 (P)	\$167.00	\$91.44	\$109.90	\$175.42	\$115.69
	310100 (S)	\$153.00	\$83.94	\$95.90	\$161.42	\$101.69
 Control Keyblank for 31-0100 cylinders	KYB XX6X11	\$10.40			\$10.40	
 6 Pin Core for 7 Pin Yale® Large Format Interchangeable Core Housing (Masterkey upcharges apply)	310100A (P)	\$167.00	\$91.44	\$109.90	\$175.42	\$115.69
	310100A (S)	\$153.00	\$83.94	\$95.90	\$161.42	\$101.69
 Control key blank for 31-0100A cylinders	KYB XX7X11	\$10.40			\$10.40	
 6 Pin Interchangeable Core Construction Core (Yale® Style) Cut keys provided separately – 12 keys Maximum	310100CC BIR1				\$175.42	
 5 Pin Large Format Interchangeable Core (Masterkey upcharges apply)	320101 (P)	\$166.00	\$90.34		\$174.36	
	320101 (S)	\$152.00	\$82.84		\$160.36	
 5 Pin Large Format Interchangeable Core for Simplex® Unican® 1000-2m Manufactured Before 2/10/92 (Masterkey upcharges apply)	320101H (P)	\$166.00			\$174.36	
	320101H (S)	\$152.00			\$160.36	
 6 Pin Large Format Interchangeable Core (Masterkey upcharges apply)	320201 (P)	\$167.00	\$90.89	\$116.05	\$175.42	
	320201 (S)	\$153.00	\$83.39	\$102.05	\$161.42	
 6 Pin Large Format Interchangeable Core for Simplex® Unican® 1000-2m Manufactured Before 2/10/92 (Masterkey upcharges apply)	320201H (P)	\$167.00	\$90.89		\$175.42	
	320201H (S)	\$153.00	\$83.39		\$161.42	
 6 Pin Large Format Removable Core Construction Core Cut keys sold separately – 12 keys maximum	320201CC BIR1				\$175.42	
 6 Pin Large Format Hotel Function Interchangeable Core (Masterkey upcharges apply)	321201 (P)	\$170.00			\$178.58	
	321201 (S)	\$156.00			\$164.58	
 6 Pin Large Format Interchangeable Core with Extended Plug Face (Masterkey upcharges apply)	324201 (P)	\$167.00	\$90.89		\$175.41	
	324201 (S)	\$153.00	\$83.39		\$161.41	

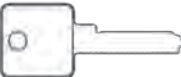
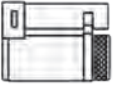
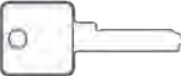
(P) = Pinned (combined)
 (S) = Sub-assembled (uncombined)
 Surcharges for Master Keying, Custom Coining and Custom Stamping apply, see page 202.
 Refer to the XT and CLIQ Intelligent Key sections for format availability and pricing.

Large Format Interchangeable Core







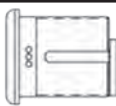
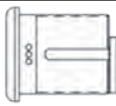
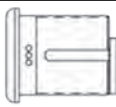
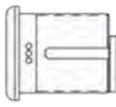

Description	Part Number	M4/M ³	BiLevel	X4	Biax/Orig	KeyMark
 6 Pin Emergency Keyblank for 321201	KYB XX6620XX05	\$10.40				
 6 Pin Large Format Interchangeable Core (Schlage®) – X4 (Masterkey upcharges apply)	322201 (P)			\$114.20		\$121.52
	322201 (S)			\$100.20		\$107.52
 X4 Control Keyblank for 322201	KYB XX7X31			\$10.40		
 5 Pin Large Format Interchangeable Core (Schlage®) – M ³ (Masterkey upcharges apply)	322201 (P)	\$175.00			\$114.20	
	322201 (S)	\$161.00			\$100.20	
 M ³ Control Keyblank for 322201	KYB XX6X31	\$10.40				
 6 Pin Large Format Interchangeable Core (Corbin Russwin®) (Masterkey upcharges apply) Not available in Original Technology*	322301 (P)	\$167.00		\$116.50	\$175.42	\$123.16
	322301 (S)	\$153.00		\$102.05	\$161.42	\$109.16
 6 Pin Large Format Interchangeable Core (Sargent®), (Masterkey upcharges apply)	322401 (P)	\$167.00		\$116.50	\$175.42	\$123.16
	322401 (S)	\$153.00		\$102.05	\$161.42	\$109.16
 7 Pin Large Format Interchangeable Core (Corbin Russwin®), (Masterkey upcharges apply)	322801 (P)			\$126.05		\$133.70
	322801 (S)			\$112.05		\$119.70

(P) = Pinned (combined)

(S) = Sub-assembled (uncombined)













Surcharges for Master Keying, Custom Coining and Custom Stamping apply, see page 202.
Refer to the XT and CLIQ Intelligent Key sections for format availability and pricing.

LFIC Mortise Cylinders

Description	Part Number	M4/M ³	BiLevel	X4	Biax/Orig	KeyMark
 6 Pin Mortise Cylinder for Yale® (Masterkey upcharges apply)	310101 (P)	\$273.00	\$197.44		\$287.25	
	310101 (S)	\$259.00	\$189.94		\$273.25	
 7 Pin Mortise Cylinder Assembly for Yale® (Masterkey upcharges apply)	310101A (P)	\$273.00	\$197.44		\$287.25	
	310101A (S)	\$259.00	\$189.94		\$273.25	
 5 Pin 1 1/8" Mortise Cylinder Assembly (Masterkey upcharges apply)	320100 (P)	\$272.00	\$193.26		\$286.19	
	320100 (S)	\$258.00	\$185.76		\$272.19	
 6 Pin 1 1/4" Mortise Cylinder Assembly (Masterkey upcharges apply)	320200 (P)	\$273.00	\$193.98		\$287.25	
	320200 (S)	\$259.00	\$186.48		\$273.25	
 6 Pin LFIC Mortise Cylinder Assembly Hotel Function (Masterkey upcharges apply)	321200 (P)	\$276.00			\$290.41	
	321200 (S)	\$262.00			\$276.41	
 6 Pin Mortise Cylinder Master Corbin Russwin® Ring Size Assembly (Masterkey upcharges apply)	321350 (P)	\$314.00			\$330.50	
	321350 (S)	\$300.00			\$316.50	
 6 Pin 1 1/2" LFIC Mortise Cylinder Assembly (Masterkey upcharges apply)	325200 (P)	\$453.00			\$477.14	
	325200 (S)	\$439.00			\$463.14	
 6 Pin 1 3/4" LFIC Mortise Cylinder Assembly (Masterkey upcharges apply)	325400 (P)	\$470.00			\$495.08	
	325400 (S)	\$456.00			\$481.08	
 6 Pin 2" LFIC Mortise Cylinder Assembly (Masterkey upcharges apply)	325500 (P)	\$484.00			\$509.85	
	325500 (S)	\$470.00			\$495.85	
 6 Pin 2 5/8" LFIC Mortise Assembly (Masterkey upcharges apply)	325600 (P)	\$520.00			\$547.83	
	325600 (S)	\$506.00			\$533.83	
 6 Pin 3" LFIC Mortise Assembly (Masterkey upcharges apply)	325700 (P)	\$542.00			\$571.04	
	325700 (S)	\$528.00			\$557.04	

(P) = Pinned (combined)
 (S) = Sub-assembled (uncombined)
 Surcharges for Master Keying, Custom Coining and Custom Stamping apply, see page 202.
 Refer to the XT and CLIQ Intelligent Key sections for format availability and pricing.

LFIC Mortise Housings









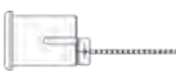

Description	Part Number	M4/M ³	BiLevel	Medeco X4
 5 Pin Mortise Cylinder Housing	32-0175	\$107.00		
 6 Pin Mortise Cylinder Housing	32-0275	\$107.00		
 6 Pin Jumbo Mortise Cylinder Housing for Corbin® Russwin® Master Ring Cylinders	32-1375	\$147.00		
 1 1/2" Mortise Cylinder Housing for 32-5200	32-5275	\$289.00		
 1 3/4" Mortise Cylinder Housing for 32-5400	32-5475	\$304.00		
 2" Mortise Cylinder Housing for 32-5500	32-5575	\$318.00		
 2 1/4" Mortise Cylinder Housing for 32-5300	32-5375	\$334.00		
 2 5/8" Mortise Cylinder Housing for 32-5600	32-5675	\$354.00		
 3" Mortise Cylinder Housing for 32-5700	32-5775	\$377.00		
 6 Pin 1 3/8" Mortise Cylinder Housing (Yale®)	31-0175	\$107.00		
 7 Pin Mortise Cylinder Housing (Yale®)	31-0175A	\$107.00		
 2 1/4" Mortise Cylinder Housing (Yale®)	31-5375	\$323.00		

(P) = Pinned (combined)

(S) = Sub-assembled (uncombined)





Surcharges for Master Keying, Custom Coining and Custom Stamping apply, see page 202.
Refer to the XT and CLIQ Intelligent Key sections for format availability and pricing.

LFIC Rim Cylinders

Description	Part Number	M4/M ³	BiLevel	X4	Biax/Orig	KeyMark
 6 Pin Rim Cylinder Assembly for Yale®, Horizontal Tailpiece (Masterkey upcharges apply)	310102H (P)	\$282.00	\$206.44		\$296.74	
	310102H (S)	\$268.00	\$198.94		\$282.74	
 6 Pin Rim Cylinder Assembly for Yale®, Vertical Tailpiece (Masterkey upcharges apply)	310102V (P)	\$282.00	\$200.46		\$296.74	
	310102V (S)	\$268.00	\$192.96		\$282.74	
 7 Pin Rim Cylinder Assembly for Yale®, Horizontal Tailpiece (Masterkey upcharges apply)	310104H (P)	\$282.00			\$296.74	
	310104H (S)	\$268.00			\$282.74	
 7 Pin Rim Cylinder Assembly for Yale®, Vertical Tailpiece (Masterkey upcharges apply)	310104V (P)	\$282.00			\$296.74	
	310104V (S)	\$268.00			\$282.74	
 5 Pin Rim Cylinder Assembly with Horizontal Tailpiece and Staked Tailpiece Retainer for Thin Door Applications (Masterkey upcharges apply)	320300H (P)	\$264.00	\$187.50		\$277.75	
	320300H (S)	\$250.00	\$180.00		\$263.75	
 5 Pin Rim Cylinder Assembly, Vertical Tailpiece (Masterkey upcharges apply)	320300V (P)	\$264.00	\$187.50		\$277.75	
	320300V (S)	\$250.00	\$180.00		\$263.75	
 6 Pin Rim Cylinder Assembly, Horizontal Tailpiece (Masterkey upcharges apply)	320400H (P)	\$282.00	\$200.46		\$296.74	
	320400H (S)	\$268.00	\$192.96		\$282.74	
 6 Pin Rim Cylinder Assembly, Vertical Tailpiece (Masterkey upcharges apply)	320400V (P)	\$282.00	\$200.46		\$296.74	
	320400V (S)	\$268.00	\$192.96		\$282.74	
 5 Pin Rim Cylinder Assembly with Lazy Motion Tailpiece (Masterkey upcharges apply)	320600 (P)	\$254.00			\$267.20	
	320600 (S)	\$240.00			\$253.20	
 6 Pin Lazy Motion Rim Cylinder Assembly (Masterkey upcharges apply)	320700 (P)	\$283.00			\$297.80	
	320700 (S)	\$269.00			\$283.80	
 6 pin Rim Cylinder with Sargent mounting holes (Masterkey upcharges apply)	320405H (P)	\$299.00			\$314.68	
	320405H (S)	\$285.00			\$300.68	

(P) = Pinned (combined)
 (S) = Sub-assembled (uncombined)
 Surcharges for Master Keying, Custom Coining and Custom Stamping apply, see page 202.
 Refer to the XT and CLIQ Intelligent Key sections for format availability and pricing.

LFIC Rim Cylinder Housings

Description	Part Number	Price
 7 Pin Rim Cylinder Housing (Yale®), Horizontal Tailpiece	31-0153H	\$115.00
 7 Pin Rim Cylinder Housing (Yale®), Vertical Tailpiece	31-0153V	\$115.00
 6 Pin 1 1/2" Rim Cylinder Housing (31 series for Yale®), Horizontal Tailpiece	31-0375H	\$115.00
 6 Pin 1 1/2" Rim Cylinder Housing (31 series for Yale), Vertical Tailpiece	31-0375V	\$115.00
 6 Pin Rim Cylinder Housing - 31 Series with Sargent® mounting hole spacing	31-0375S	\$115.00
 5 Pin Rim Cylinder Housing, Horizontal Tailpiece	32-0375H	\$101.00
 5 Pin Rim Cylinder Housing, Vertical Tailpiece	32-0375V	\$101.00
 6 Pin Rim Cylinder Housing, Horizontal Tailpiece	32-0475H	\$115.00
 6 Pin Rim Housing, Vertical Tailpiece	32-0475V	\$115.00
 6 Pin Rim Cylinder Housing - 32 Series with Sargent® mounting hole spacing	32-0477H	\$115.00
 5 Pin Rim Cylinder Housing with Lazy Motion Tailpiece	32-0675	\$99.60
 6 Pin Rim Lazy Motion Cylinder Housing	32-0775	\$116.00

(P) = Pinned (combined)

(S) = Sub-assembled (uncombined)

Surcharges for Master Keying, Custom Coining and Custom Stamping apply, see page 202.
Refer to the XT and CLIQ Intelligent Key sections for format availability and pricing.

Small Format Interchangeable Core

FEATURES	Medeco B	Medeco X4	Medeco XT
Utility patented key control provides protection from unauthorized duplication of keys		●	●
Available in a large selection of competitive keyways	●		
Solid brass construction provides high quality and long cylinder life	●	●	
Nickel plated pins designed to provide exceptional wear resistance	●	●	
Retrofits into virtually any manufacturers' locksets with a wide selection of interchangeable cams to fit various mortise series hardware for cost effective improved security	●	●	●
Ability to key with non-interchangeable core cylinders, including rim and mortise, knob style for Medeco BiLevel cost effective system flexibility		●	

Medeco B SFIC

Medeco B is an economical solution, available in a large selection of competitive keyways including: AB, BB, CB, DB, EB, FB, GB, HB, JB, KB, LB, MB, QB, RB, TA, TB, TC, TD, TE, WA, WB, WC, WG, WH & WY.

Medeco XT Intelligent Key Solution

Many of the cylinders in this section are also available with a Medeco XT Intelligent Key solution. See the Medeco XT section for more details.

Medeco X4 Patented Key Control

Medeco X4 cylinders offer patented control against unauthorized duplication of keys without the additional security features protecting against force or surreptitious attack.

Medeco X4 Small Format Interchangeable Core

Medeco X4 leads the market in patent protected small format interchangeable core (SFIC) cylinders, Conventional rim, mortise and key-in-knob cylinders are also available, offering one key convenience – both SFIC and conventional Medeco X4 cylinders will operate using the same key. With patents extending through 2030 and the ability to expand key systems to four times that of standard SFIC, Medeco X4 is guaranteed to be an important product to suit your needs.



Patented Key Control

Protects against unauthorized duplication of your keys.



Uses Existing Hardware

Industry standard Small Format Interchangeable Cores (SFIC) size, reduces cost by eliminating the need to replace your existing hardware.



Quickly Change Cores

Provides quick and easy cylinder changes in the event keys are lost or stolen.



Available in eCylinder

SFIC cores are also available in the Medeco XT eCylinder format for Loss & Liability control.

Technical Information:

- Utilizes the standard A2 pinning system in conjunction with a bitted slider locking arrangement which allows for more master keying capabilities for large master key systems. Up to 65,536 unique change keys in a 7 pin master key system on a single keyway
- ANSI A156.5 Grade 1 certification assures consistent quality for heavy use applications
- Expandable, simple master keying available in SFIC and LFIC, as well as standard key-in-knob, mortise, and rim cylinders
- SFIC's are available in six or seven pin cylinders, and can replace Best style cores
- Standard Medeco cams and tailpieces can be used on Medeco X4 cylinders
- Keys can be cut using many standard code type key machines such as the Pro-Lok Blue Punch, A1 Green Machine, the ITL 9000/9700, HPC 1200 and HPC Code Max

- Solid brass construction for excellent durability
- Spool shaped top and bottom pins add a measure of pick resistance
- Solid nickel silver bottom pins increase wear resistance
- Individual pin chamber caps provide for ease of servicing
- Locks can be keyed alike, keyed different, or master keyed depending on your specific needs.

Applications:

Provides a key control retrofit for other manufacturers SFIC products in use in a variety of facilities.

Warranty:

Warranted for two (2) years against manufacturer's defects. See the Medeco® limited warranty for full details.

Finishes:

Available in all standard finishes to match with existing hardware.

Medeco B

Medeco B Small Format Interchangeable Cores (SFIC) provide quick and easy cylinder changes in the event keys are lost or stolen. Medeco B is an economic and efficient solution to rekeying needs. Medeco B easily retrofits into existing systems, significantly reducing installation time.

Medeco B offers flexibility and is available in standard 6 and 7 pin format in established competitive keyways. The reinforced sleeve design provides added strength and durability.



Competitive Keyways

Medeco B is an affordable alternative for end users currently using industry standard unpatented keyways. Available keyways: 1C, 1D, AB, BB, CB, DB, EB, FB, GB, HB, JB, KB, LB, MB, QB, RB, TA, TB, TC, TD, TE, WA, WB, WC, WG, WH & WY.



Quickly Change Cores

Medeco B SFIC cylinder provides quick and easy cylinder changes in the event keys are lost or stolen.



Fits Existing & New Master Key Systems

Medeco B is priced to save clients' money vs. other unpatented competitors and can be substituted directly into existing SFIC master key systems.

Applications:

The Medeco B retrofit cylinders are ideal for any application requiring unpatented key control that can be substituted directly into existing small format interchangeable core systems.

Warranty:

Medeco B cylinders are warranted for two years against manufacturer's defects. See the Medeco® limited warranty for full details.

Finishes:

- Available in all standard finishes to match existing hardware.

Technical Information:

- Solid brass construction
- Reinforced sleeve design
- Uses A2 SFIC Specifications
- Available with Medeco-branded or plain face
- 6 & 7 pin unpatented SFIC
- Sleeve, shell, plug & face plate made of brass
- Individually capped pin chambers
- Available in the following industry standard SFIC keyways: 1C, 1D, AB, BB, CB, DB, EB, FB, GB, HB, JB, KB, LB, MB, QB, RB, TA, TB, TC, TD, TE, WA, WB, WC, WG, WH & WY
- Dealers do not need a contract to purchase Medeco B SFIC Cores. Cores are available through Medeco and authorized distributors.

How To Order Small Format Interchangeable Core

Medeco X4		LEVEL 1 – Patented Key Control
Cores Only	Part Number	Notes
6 Pin Small Format Interchangeable Core with Clip Retainer, Removable Front Plate	33600006 (P)	Pinned pricing includes master key system design and pinning, as well as two cut keys. Note: Conventional cylinders are available (KIK, Rim, Mortise, etc.) and can be easily integrated into an SFIC Master Key System
	33600006 (S)	
7 Pin Small Format Interchangeable Core with Clip Retainer, Removable Front Plate	33700006 (P)	
	33700006 (S)	

How to Order Medeco X4:

(P) = Pinned (S) = Sub-Assembled

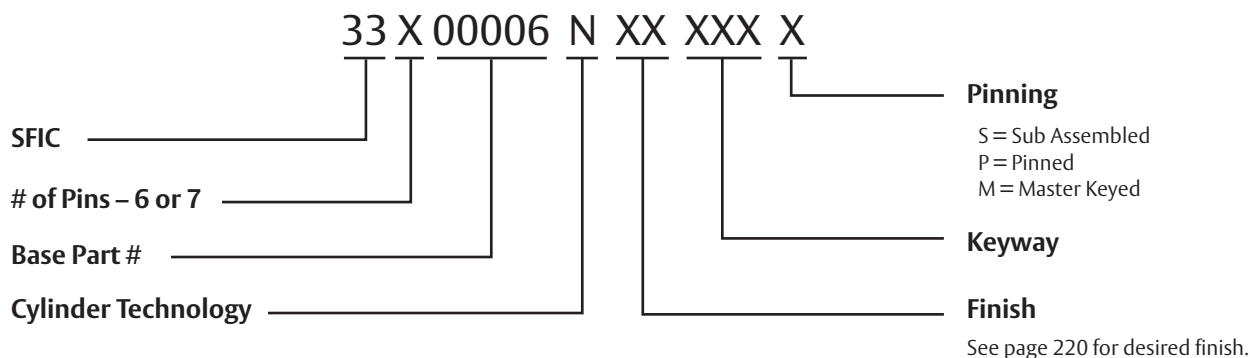







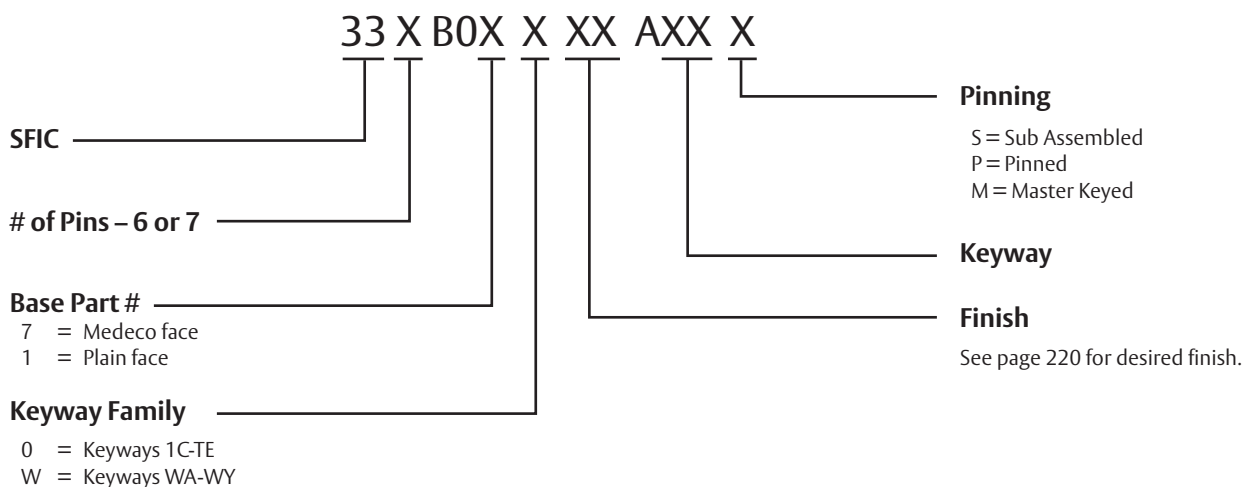







Medeco B		LEVEL 0 – Convenience
Cores Only	Part Number	Notes
6 Pin Small Format Interchangeable Core, Medeco face plate	33-6B07X (P)	Pinned pricing includes master key system design and pinning, as well as two cut keys
	33-6B07X (S)	
6 Pin Small Format Interchangeable Core with plain face	33-6B01X (P)	
	33-6B01X (S)	
7 Pin Small Format Interchangeable Core, Medeco face plate	33-7B07X (P)	
	33-7B07X (S)	
7 Pin Small Format Interchangeable Core with plain face	33-7B01X (P)	
	33-7B01X (S)	

How to Order Medeco B:

(P) = Pinned (S) = Sub-Assembled









Small Format Interchangeable Core

Description	Part Number	Medeco B	X4	KeyMark
 Medeco X4 and KM 6 Pin SFIC	33600006 (P)		\$81.90	\$85.63
	33600006 (S)		\$67.90	\$71.63
 Medeco B 6 Pin SFIC, Medeco face plate, Alphabet and T series keyways	336B070 (P)	\$33.80		
	336B070 (S)	\$16.30		
 Medeco B 6 Pin SFIC, Medeco face plate, W series keyways	336B07W (P)	\$33.80		
	336B07W (S)	\$16.30		
 Medeco B 6 Pin SFIC, plain face plate, Alphabet and T Series Keyways	336B010 (P)	\$33.80		
	336B010 (S)	\$16.30		
 Medeco B 6 Pin SFIC, plain face plate, W Series Keyways	336B01W (P)	\$33.80		
	336B01W (S)	\$16.30		
 Medeco X4 and KM 7 Pin SFIC	33700006 (P)		\$81.90	\$85.63
	33700006 (S)		\$67.90	\$71.63
 Medeco B 7 Pin SFIC, Medeco face plate, Alphabet and T series keyways	337B070 (P)	\$33.80		
	337B070 (S)	\$16.30		
 Medeco B 7 Pin SFIC, Medeco face plate, W series keyways	337B07W (P)	\$33.80		
	337B07W (S)	\$16.30		
 Medeco B 7 Pin SFIC, plain face place, Alphabet and T Series Keyways	337B010 (P)	\$33.80		
	337B010 (S)	\$16.30		
 Medeco B 7 Pin SFIC, plain face plate, W Series Keyways	337B01W(P)	\$33.80		
	337B01W (S)	\$16.30		
 Medeco X4 and KM 6 Pin Construction Core (cut keys ordered separately – 12 keys maximum)	33600006 BI CC K		\$81.90	\$85.63
 Medeco X4 and KM 6 Pin SFIC, Extended Plug Head	33600007 (P)		\$81.90	\$85.63
	33600007 (S)		\$67.90	\$71.63
 Small Format Interchangeable Core, Extended Plug Head	33700007 (P)		\$81.90	\$85.63
	33700007 (S)		\$67.90	\$71.63
 Specialty Sliding Door 7 Pin SFIC, Medeco X4 and KM	3370000S (P)		\$88.24	\$91.97
	3370000S (S)		\$74.24	\$77.97
 Medeco B 7 Pin SFIC for Showcase Lock, Medeco face plate	337B070S (P)	\$40.14		
	337B070S (S)	\$22.64		
 Medeco B 7 Pin SFIC for Showcase Lock, Medeco face plate, W series keyways	337B07WS (P)	\$40.14		
	337B07WS (S)	\$22.64		

(P) = Pinned (combined)
 (S) = Sub-assembled (uncombined)
 Surcharges for Master Keying, Custom Coining and Custom Stamping apply, see page 202.
 Refer to the XT and CLIQ Intelligent Key sections for format availability and pricing.

SFIC Rim Cylinders







Description	Part Number	Medeco B	X4	KeyMark
 6 Pin SFIC with 1 1/4" Rim Assembly	33602032 (P)		\$129.73	\$135.89
	33602032 (S)		\$115.73	\$121.89
 6 Pin SFIC with 1 1/2" Rim Assembly	33602042 (P)		\$129.73	\$135.89
	33602042 (S)		\$115.73	\$121.89
 7 Pin SFIC with 1 1/2" Rim Assembly	33702042 (P)		\$129.73	\$135.89
	33702042 (S)		\$115.73	\$121.89
 7 Pin SFIC with Corbin Russwin® Master Ring Assembly	337020B2 (P)		\$129.73	\$135.89
	337020B2 (S)		\$115.73	\$121.89
 6 Pin SFIC with 1 1/2" Ext.Face Rim Assembly. Medeco KM only.	33602033 K(P)		\$129.73	\$135.89
	33602033 K(S)		\$115.73	\$121.89
 6 Pin SFIC with 1 1/2" Ext.Face Rim Assembly. Medeco KM only.	33602043 K(P)		\$129.73	\$135.89
	33602043 K(S)		\$115.73	\$121.89
 7 Pin SFIC with 1 1/2" Ext.Face Rim Assembly. Medeco KM only.	33702043 K(P)		\$129.73	\$135.89
	33702043 K(S)		\$115.73	\$121.89

(P) = Pinned (combined)

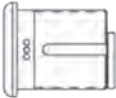
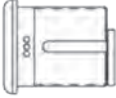
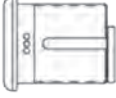
(S) = Sub-assembled (uncombined)

Surcharges for Master Keying, Custom Coining and Custom Stamping apply, see page 202.
Refer to the XT and CLIQ Intelligent Key sections for format availability and pricing.

SFIC Mortise Cylinders

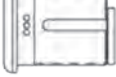
Description	Part Number	Medeco B	X4	KeyMark
 6 Pin SFIC 1 1/4" Mortise Assembly	33602012 (P)		\$126.00	\$132.16
	33602012 (S)		\$112.00	\$118.16
 7 Pin SFIC 1 3/8" Mortise Assembly	33702022 (P)		\$126.00	\$132.16
	33702022 (S)		\$112.00	\$118.16
 7 Pin SFIC 1 3/8" Corbin® Jumbo Assembly	337020C2 (P)		\$126.00	\$132.16
	337020C2 (S)		\$112.00	\$118.16
 7 Pin SFIC 1 1/2" Mortise Cylinder Assembly	337020E2 (P)		\$126.00	\$132.16
	337020E2 (S)		\$112.00	\$118.16
 6 Pin SFIC 1 1/4" Ext. Face Mortise Assembly Medeco KM only	33602013 K(P)			\$132.16
	33602013 K(S)			\$118.16
 7 Pin SFIC 1 3/8" Ext. Face Mortise Assembly Medeco KM only	33702023 K(P)			\$132.16
	33702023 K(S)			\$118.16
 6 Pin SFIC 7/8" body length (1 3/8" overall) Tapered Head Mortise Assembly	33602052 (P)		\$126.00	\$132.16
	33602052 (S)		\$112.00	\$118.16
 6 Pin SFIC 1" body length (1 1/2" overall) Tapered Head Mortise Assembly (can accept 7 pin core)	33602062 (P)		\$126.00	\$132.16
	33602062 (S)		\$112.00	\$118.16
 6 Pin SFIC 7/8" body length (1 3/8" overall) Ext. Face Tapered Head Mortise Assembly	33602053 K(P)		\$126.00	\$132.16
	33602053 K(S)		\$112.00	\$118.16
 6 Pin SFIC 1" body length (1 1/2" overall) Ext. Face Tapered Head Mortise Assembly (can accept 7 pin core)	33602063 K(P)		\$126.00	\$118.16
	33602063 K(S)		\$112.00	\$118.16

(P) = Pinned (combined)

(S) = Sub-assembled (uncombined)

Surcharges for Master Keying, Custom Coining and Custom Stamping apply, see page 202.
Refer to the XT and CLIQ Intelligent Key sections for format availability and pricing.

SFIC Housings

Description	Part Number	Price
 6 Pin 1 1/4" Mortise Housing Only	33-076011	\$21.64
 6 or 7 Pin 1 3/8" Mortise Housing Only	33-076021	\$21.64
 7 Pin 1 1/2" SFIC Mortise Housing Only, (If using 6 Pin core spacer CP-160420 required)	33-076025	\$43.60
 7 Pin 1 3/8" Housing Only for Corbin® Russwin® Master Ring Cylinders*	33-076028	\$64.46
 6 Pin 7/8" Tapered Head Mortise Housing Only	33-076051	\$21.64
 6 or 7 Pin 1" Tapered Head Mortise Housing Only	33-076061	\$21.64
 6 Pin 1 1/2" Rim Cylinder Housing Only	33-07603H	\$21.64
 7 Pin 1 1/2" Rim Cylinder Housing Only	33-07604H	\$21.64
 7 Pin Corbin® Jumbo Rim Housing Only	33-076048	\$64.46

Showcase Lock Housing

Description	Part Number	Price
Showcase lock for SFIC cylinder. Works with Medeco X4, Medeco XT, or Medeco B SFIC. SFIC sold separately.	33-07340	\$89.20

(P) = Pinned (combined)

(S) = Sub-assembled (uncombined)

Surcharges for Master Keying, Custom Coining and Custom Stamping apply, see page 202.
Refer to the XT and CLIQ Intelligent Key sections for format availability and pricing.

Intelligent Key Cabinet (IKC)

The Intelligent Key Cabinet is a complete, electronically-controlled, key management solution that can secure, distribute and audit the use of XT Keys, mechanical keys, or other assets. Only authorized users can gain access to the cabinet via the included biometric fingerprint reader or PIN code pad, or a combination of both. An optional access card reader is also available. As an essential addition to any Medeco XT Intelligent Key system, it locks XT keys in place and keeps them charged and ready for use. The IKC can improve employee efficiency and increase accountability which translates into a more secure facility with lower operating costs. Can be combined with the XT IPD (Identification and Programming Device) for a full XT managed Solution.



Benefits:

- **Accountability:** No more wondering who has checked out keys or for how long. Complete audit trail and reporting by user and key activity. User accountability reduces lost keys. Fewer lost keys leads to lower expenses and improved security.
- **Analytics:** Identify potential problems in removal and return patterns before they escalate. Complete reporting suite provides multiple reporting options to provide real-time data. Reports can be automatically generated and sent to multiple users by email or SMS text. Custom reports can be configured and exported to Excel for added convenience.
- **Security:** Loose keys are vulnerable to being misplaced or stolen. Only authorized users are able to access the electronic key management system. Biometric Fingerprint, PIN, and/or Prox Card authentication (optional) allow access to the IKC for added security and control. The IKC supports dual authentication if desired. For added security, a digital photo capture of each login can be added.
- **Convenience:** Allow employees to retrieve keys quickly without waiting for a manager. Quick, easy-to-use web-based or locally hosted software shows what keys are in, what keys are out, and to whom they are issued. The IKC allows the return of any key to any location in the cabinet, and then learns the key's new location.
- **Productivity:** Eliminate time spent searching for, or replacing lost keys – always know who took which key, and when.
- **Efficiency:** Pair with a full XT solution to identify patterns and workflows to gain even greater efficiency and security. XT version cabinets charge keys while they are secured and stored, ensuring keys are always ready to go.

Features:

- Available in 32 and 64 port sizes
- XT and iFob versions
- 32 port cabinets must be either all XT or all iFob ports
- 64 port cabinets can be all XT, all iFob or a combination of 32 XT plus 32 iFob
- Securely stores and charges XT keys (XT version)
- Identifies XT key serial number (XT version)
- Fingerprint reader
- Built-in LCD screen for ID
- Supports 2 factor authentication
- Audible and visual alarms
- SMS messages
- Email messages
- Camera for security photo capture
- Comprehensive reporting & analytics
- Emergency Fob Release System
- Multi-System Networking
- Medeco high security mechanical lock for manual override
- Requires a separate XT IPD programmer to program XT Keys (requires XT Web Manager software)
- Optional: Smart card reader, stand

Intelligent Key Cabinet (IKC)

Standard Cabinet

LCD touchscreen used for PIN code authentication, warning messages as well as PC troubleshooting

High security mortise cylinder for manual override

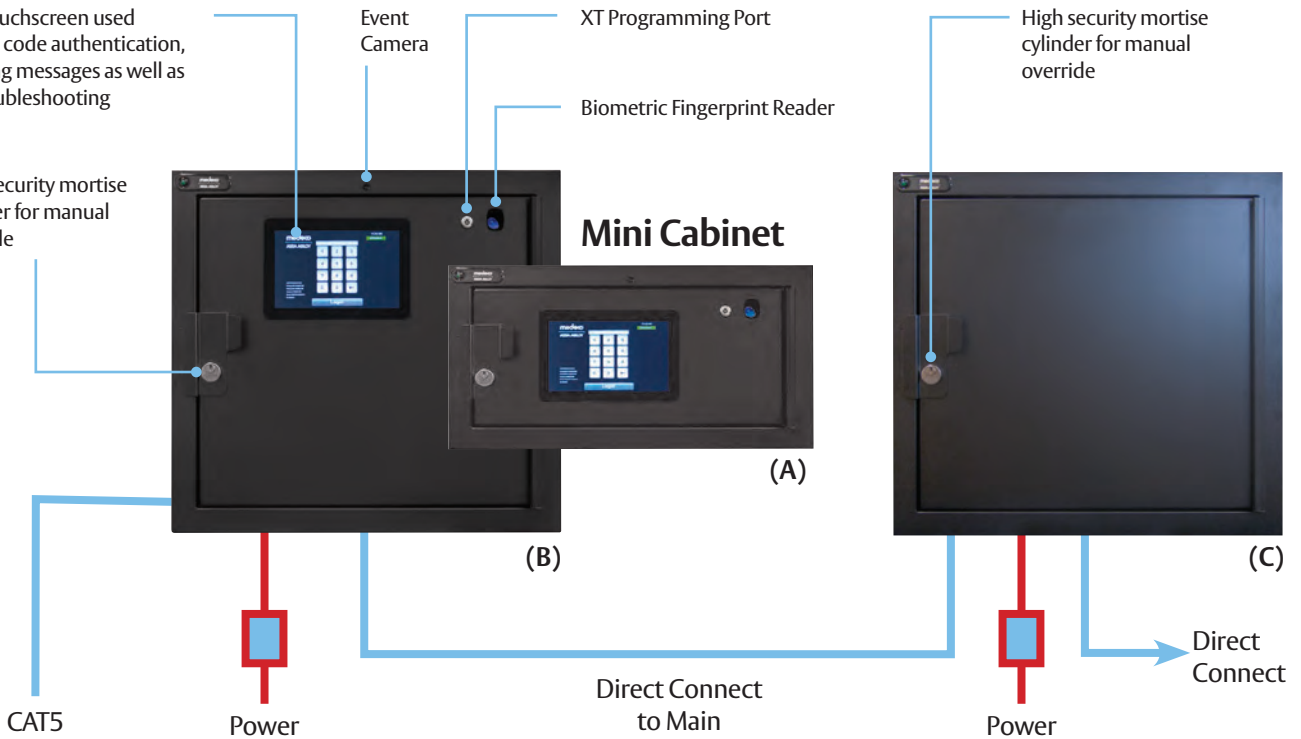

Add-On Cabinet

High security mortise cylinder for manual override

Scalability:

The IKC system can grow as business needs grow by adding on additional secondary cabinets in either 32 or 64 port sizes and in a combination of technologies (iFob or XT).

- Each system requires one 'Main' touchscreen cabinet
- Add additional cabinets as needs require
- System can be any combination of 32 or 64 port cabinets
- 32 port cabinets support either XT or iFob ports
- 64 port cabinets support either all XT, all iFob, or a combination of 32 XT plus 32 iFob.
- Main and Secondary boxes can be configured with same technology or different
- Up to 7 Add-on units maximum (512 keys) for every Main unit

Mini Cabinet (Image A):

- Main Cabinet (Image A) 27" W x 14.72" H x 12" D
- Can be stand alone or connected to Add-on cabinet
- Technology – Select All XT or All iFob
- Main and Add-on cabinets can be configured with same technology or different

Standard Cabinet (Image B):

- Main Cabinet (Image B), 32 or 64 ports, 27" W x 25.25" H x 12" D
- Can be stand alone or connected to secondary cabinet
- Technology – Select All XT, All iFob, or 32 XT plus 32 iFob
- Main and Add-on cabinets can be configured with same technology or different

Add-on Cabinet (Image C):

- Add-on Cabinet (Image C), 27"W x 25.25" H x 12"D
- Available with 32 or 64 ports
- 32 port option expandable to 64 with additional 32 port panel (sold separately)
- Must be connected to a Main cabinet

See pages 29-31 for ordering information.

Medeco T21 Key Management System

The Medeco T21 is a sophisticated stand-alone key management system which combines innovative RFID technology and robust design to provide small to medium-sized businesses with the advanced management of 21 keys or keysets in a plug and play solution.



Operation:

- Stand-alone plug & play solution with advanced RFID technology
- Touchscreen interface
- PIN access to designated keys or keysets which are individually locked in place
- Keys are securely attached using special security seals
- Simple to configure through the setup wizard
- No requirement for network connection or PC
- Concealed robust fixing points allow secure wall fixing
- Mains operated with optional battery backup
- 1,000 users per system
- System can save 250,000 audit events

Technical Information:

- User, key and access rights administration
- Multilingual functionality
- Screen-based audit trail and reporting capability or export via USB port
- 21 robust, long-live iFobs with security seals
- 21 locking receptors with LEDs
- Robust and compact steel housing eliminates exposed hinges and obvious access points
- Manual override and door release functions in case of emergency
- Audible alarms

Warranty:

Medeco warrants the T21 to be free of defects in material and/or workmanship for a period of one (1) year from date of original purchase.

iFob

Once attached to an iFob with a robust security seal, individual keys or keysets are assigned to a specific user.

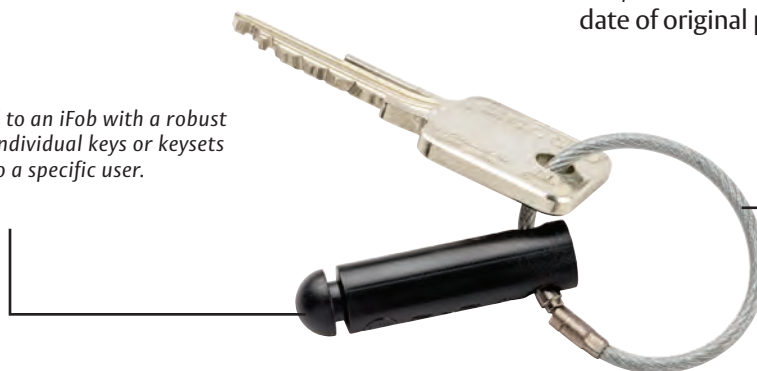

Security Seal

The secure one-time security seal is cost-effective and simple to apply without the need for specific tools.

T21 Key Management System

Description	Part Number	Price
Medeco T21 Key Management System, comes with 21 ifobs and security seals.	EA-100117	\$3,755.00
Security Seal	EA-100148	\$8.99 ea
iFob	EA-100149	\$44.90 ea
Battery	EA-100154	\$105.00
T21 Key override replacement lock	960590 W 26-S6	\$85.03

International Cylinders

Medeco's international cylinders are designed to fit in locksets of major world manufacturers. In addition to international uses, many of these cylinders fit imported hardware used in North America. Medeco offers a variety of international cylinders including European profile and modular cylinders in both mechanical and Intelligent Key technologies. The Medeco European Profile cylinder has a teardrop shape that fits into storm doors, upscale hardware and specialty applications and is available in single, half and double cylinder versions. Cylinders are also available in: oval, round, and "snowman" formats.



Patented Key Control

Patent-pending key control protects against unauthorized duplication of keys (Medeco 4*).



Protection Against 3D Printing

A patent-pending movable element in the M4* key deters unauthorized 3D printed copies of keys or blanks.



Picking and Bumping Protection

M4* cylinders use cylinder side pins, a shuttle lift pin and a movable key element to engage a sidebar that prevents the key from turning until the elements are rotated and aligned in the correct position, protecting against bumping, picking and other attacks.



Protection From Physical Attack

Medeco 4* cylinders are UL 437 Listed and use hardened steel inserts positioned in critical areas of the cylinder, providing a high degree of drill and picking resistance.



Special Angle Cut Keys

Requires a special key cutting machine and access to Medeco specific blanks, available in a variety of restrictions to support every need.



Intelligent Key Cylinders

Medeco's international cylinders are also available in electronic Intelligent Key format for loss & liability control.



Master Keying Capabilities

Medeco 4* international-style cylinders can be master keyed into a system containing M4, M4 BiLevel and M4 CLIQ** Intelligent Key cylinders.

Technical Information:

- Utility patented key control provides protection from unauthorized duplication of keys in most countries (Medeco 4*, M3)
- Superior master keying capability to accommodate systems of virtually any size
- Solid brass construction provides high quality and long cylinder life
- Nickel plated pins provide exceptional wear resistance and additional hardened stainless steel pins provide drill resistance
- European profile cylinders retrofit into virtually any manufacturers' locksets requiring DIN Standard cylinders
- Pin chamber set screws provide ease of rekeying and resist comb attacks
- 5 and 6 pin cylinders available

Certification (M4 Pending):

- SKG *** Netherlands
- EN1303 -2005
- Swedish Standards SS3522
- DIN18254

Warranty:

Warranted for two (2) years against manufacturer's defects. See the Medeco® limited warranty for full details

Available Key Technologies:

Mechanical:	eCylinder:
– Medeco 4	– M4 CLIQ
– Medeco 4 BiLevel	– M ³ CLIQ
– Medeco ³	– Classic CLIQ
– Medeco ³ BiLevel	– XT
– X4	– X4 CLIQ

Note: M3 and M4 BiLevel not available in Euro Dbl.

EPIC–Euro Profile Interchangeable Core

Medeco EPIC-Euro Profile cylinders are designed to accept a special, slab-sided, small format interchangeable core (SFIC) cylinder to retrofit into most standard European Profile applications.

Medeco Euro profiles can be furnished with Medeco's patented X4 technology, offering unmatched key control, the widest array of retrofit cylinders and four times the master keying capability.



Patented Key Control

Protects against unauthorized duplication of your keys.



Uses Existing Hardware

European profile cylinders retrofit into virtually any manufacturers' locksets requiring DIN Standard cylinders.



Superior Master Keying Capability

Furnished with Medeco X4 SFIC, EPIC offers superior master keying to accommodate very large systems.

Medeco X4 Technical Information

- 6 and 7 Pin cylinders available
- Solid nickel silver pins
- Many cylinder formats available
- Profile cylinders available in multiple sizes, finishes and functions
- Where interchangeable core is not required, Euro profile cylinders are also available in modular components and assembled standard lengths.
- Solid brass construction provides high quality and long cylinder life
- Solid nickel silver pins and keys
- European Profile Cylinders retrofit into virtually any manufacturers' locksets equivalent to DIN Standards

Warranty

Warranted for (2) years against manufacturing defects. See Medeco Limited Warranty for full details.

EPIC–Euro Profile Interchangeable Core

Description	Part Number	Price
6 Pin Part Numbers		
EPIC Euro Double 37.9 mm/37.9mm	2326D21	\$112.00
EPIC Euro Half 37.9mm	2326H01	\$73.30
EPIC Euro with Thumbturn 40mm int/39.2 mm ext	2326S12X*	\$106.00
Small Format Interchangeable Core (SFIC)	3360000R (P)	\$81.90
Small Format Interchangeable Core (SFIC)	3360000R (S)	\$67.90
7 Pin Part Numbers		
EPIC Euro Double 41.73mm/41.73mm	2324D21	\$112.00
EPIC Euro Double 41.73mm/55mm	2324D25	\$112.00
EPIC Euro Half 41.73mm	2324H01	\$73.30
EPIC Euro Half 55mm	2324H05	\$73.30
EPIC with Thumbturn 40mm int/43mm ext	2324S12X	\$106.00
EPIC with Thumbturn 40mm int/55mm ext	2324S15X	\$106.00
EPIC with Thumbturn 55mm int/43mm ext	2324S52X	\$106.00
Small Format Interchangeable Core (SFIC)	3370000R (P)	\$81.90
Small Format Interchangeable Core (SFIC)	3370000R (S)	\$67.90

* X denotes thumb turn. Please see following page for thumb turn. EPIC sold less cylinder.

(P) = Pinned (combined)

(S) = Sub-assembled (uncombined)

Surcharges for Master Keying, Custom Coining and Custom Stamping apply, see page 202.
Refer to the XT and CLIQ Intelligent Key sections for format availability and pricing.

How To Order International Cylinders - Euro-Profile

<p>1</p> <p>23130 05500 base part #</p> <p>Refer to pages 134-136 for descriptions and technical specifications to find the corresponding base part number.</p>	<p>2</p> <p>H technology</p> <p>H = Medeco 4 T = Medeco³ W = Biaxial - = Original J = Medeco³ BiLevel N = X4 K = KM P = M4 BiLevel Q = M4 CLIQ S = M3 CLIQ M = X4 CLIQ C = Classic CLIQ</p>	<p>3</p> <p>05 finish</p> <p>Refer to the inside back cover of this catalog for finish options.</p>	<p>4</p> <p>M4 keyway</p> <p>Insert keyway if known or contact Customer Service for help.</p>	<p>5</p> <p>P pinning</p> <p>S = Sub-Assembled (Uncombined) N = Sub-assembled, - No side pins (M4 only) - No slider (M3 only) P = Pinned (Combinated) M = Master Keyed R = Master Keyed - blade and side pins (Medeco 4 only)</p>	<p>6</p> <p>624 side pin code (Medeco 4 only)</p> <p>Insert side pin code if known or contact Customer Service for help.</p>
-----------------------------------------------------------------------------------------------------------------------------------------------------------------------------------	---------------------------------------------------------------------------------------------------------------------------------------------------------------------------------------------------------------------------------------------------------------------------------	-----------------------------------------------------------------------------------------------------------------------	-----------------------------------------------------------------------------------------------------------------	---------------------------------------------------------------------------------------------------------------------------------------------------------------------------------------------------------------------------------------------------------------------------------	----------------------------------------------------------------------------------------------------------------------------------------------------

BUILD A BASE PART #:

23130 X X X X X X

International Cylinder ———

Profile Design ———

Function ———

- *0 = Thumbturn Cylinder with "SR" Round Knob
- 1 = Half Cylinder
- 2 = Double Cylinder*
- *3 = Thumbturn Cylinder with Low Profile "LP" Knob
- *4 = Thumbturn Cylinder with Decorative "RD" Knob
- *5 = Thumbturn Cylinder with Lever "RL" Knob
- *6 = Thumbturn Cylinder with "CR" Crescent Knob
- *7 = Thumbturn Cylinder with "SP" Spade Knob
- *L = Thumbturn Cylinder with "L" Less Knob

Number of Pins ———

- 5 = 5 Pins
- 6 = 6 Pins
- 7 = 7 Pins

*Not available in M3 & M4 BiLevel

Interior/Exterior Length Extensions

0 = No Extension	5 = 25 mm (.984")
1 = 5 mm (.197")	6 = 30 mm (1.18")
2 = 10 mm (.394")	7 = 35 mm (1.38")
3 = 15 mm (.591")	8 = 40 mm (1.57")
4 = 20 mm (.787")	9 = 45 mm (1.77")

Cam Position
(from outside with bible down)

- 1 = 1 o'clock
- 2 = 10 point multi-gear
- 3 = EuroLine Module
- 5 = 5 o'clock
- 7 = 7 o'clock
- 8 = Multiposition (half cylinder only)
- 0 = 11 o'clock

*Thumbturn/Cam position available at 5 and 11 o'clock only

Assembly Variation for the BiLevel with Original Technology

- H = High Security
- B = Standard Security
- J = Standard Security all except Double Euro Profile

How To Order Other International Cylinders

Complete part numbers are required for all orders. To determine the correct part number, fill in the "X's" in sequential order.

1 2305016 base part # Refer to pages 137-140 for descriptions and technical specifications to find the corresponding base part number.	2 H technology H = Medeco 4 T = Medeco ³ W = Biaxial - = Original J = Medeco ³ BiLevel N = X4 K = KM P = M4 BiLevel Q = M4 CLIQ S = M3 CLIQ M = X4 CLIQ C = Classic CLIQ	3 05 finish Refer to the inside back cover of this catalog for finish options.	4 M4 keyway Insert keyway if known or contact Customer Service for help.	5 P pinning S = Sub-Assembled (Uncombined) N = Sub-assembled, - No side pins (M4 only) - No slider (M3 only) P = Pinned (Combinated) M = Master Keyed R = Master Keyed - blade and side pins (Medeco 4 only)	6 624 side pin code (Medeco 4 only) Insert side pin code if known or contact Customer Service for help.
------------------------------------------------------------------------------------------------------------------------------------------------------------------------------	--------------------------------------------------------------------------------------------------------------------------------------------------------------------------------------------------------------------------------------------------------------------------	----------------------------------------------------------------------------------------------------------------------	----------------------------------------------------------------------------------------------------------------	-------------------------------------------------------------------------------------------------------------------------------------------------------------------------------------------------------------------------------------------------------------------------	---------------------------------------------------------------------------------------------------------------------------------------------------------

BUILD A BASE PART #:

23 XXX XXX X

International Cylinder

Design

- 010 = Danish Round (Ruko Round)
- 030 = Australian Oval
- 040 = British Oval (Union Oval)† No extension.*
- 050 = Scandinavian Oval Ext. (ASSA Oval)
- 060 = Scandinavian Oval Int. (ASSA Oval)
- 070 = Norwegian Oval (TrioVing Oval)
- 080 = Scandinavian Snowman
- 090 = Scandinavian Round Ext. (ASSA Round)
- 100 = Scandinavian Round Int. (ASSA Round)
- 140 = Italian Outer Gate Lock, 3 Pin
- 150 = Italian Outer Gate Lock, 5 Pin
- 160 = Italian Roller Shutter, 4 Pin

Function*

- 0 = Thumbturn Cylinder with "RL" Knob Union Oval only
- 1 = Half Cylinder
- 2 = Double Cylinder

† Union Oval Thumbturn Position at 5 and 11 o'clock only.

*British Oval is the only design that requires a function number and cam position to be selected. It is non-extending.

Cam Position (British Oval)*

- 0 = 11 o'clock
- 1 = 1 o'clock
- 5 = 5 o'clock
- 7 = 7 o'clock

BiLevel w/ Original Technology

- H = High Security
- B = Standard Security

Number of Pins

- 3 = 3 Pins
- 4 = 4 Pins
- 5 = 5 Pins
- 6 = 6 Pins

Medeco Premium High Security Euro Thumbturn Profile Cylinder

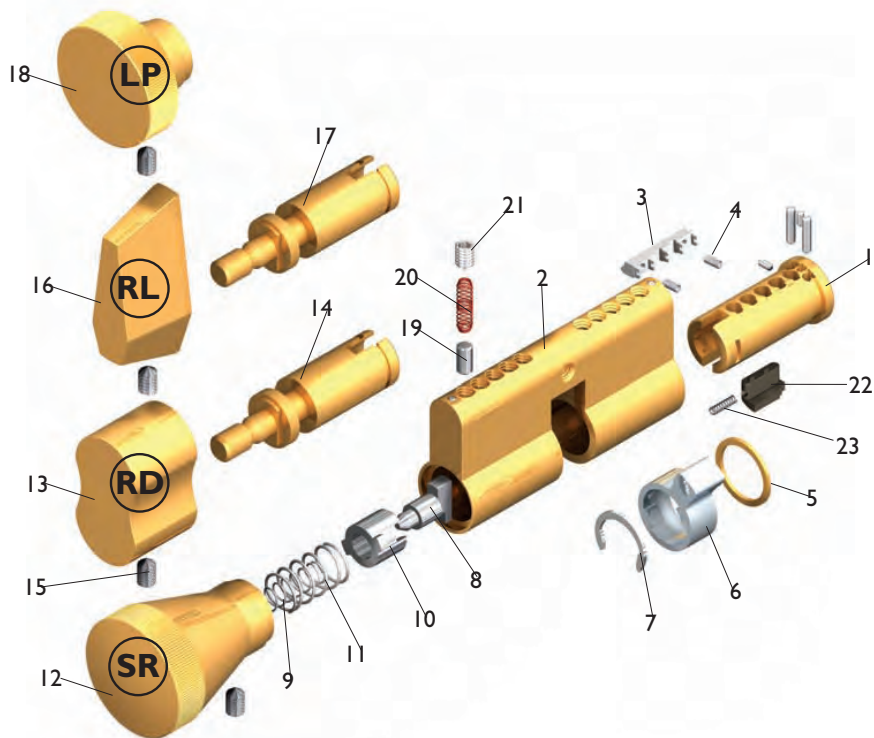

Item	Description	Part Number
1	Plug	Cylinder Specific
2	Shell	Cylinder Specific
3	Sidebar	CP-084X71
4	Sidebar Springs	CP-030018
5	Plug Retainer Ring	CP-021490
6	Cam	CT-Z51
7	Thumbturn Retaining Clip	CP-020031
8	Actuator	CP-100111
9	Actuator Spring	CP-030025
10	Actuator Pilot	CP-280261
11	Pilot Spring	CP-030024
12	Standard Round "SR" Thumbturn	CP-285961
13	Decorative "RD" Thumbturn	CP-285901
14	Thumbturn Shaft - 6 Pin	CP-240761-600
15	Thumbturn Allen Set Screw #6-32 x 3/16" Knurled Cup Point	CP-012411-040
16	Lever "RL" Thumbturn	CP-285931
17	Thumbturn Shaft - 5 Pin	CP-240761-500
18	Low Profile "LP" Thumbturn	CP-285991
19	Thumbturn Retaining Pin	TP-F10-1T
20	Thumbturn Retaining Pin Spring	CP-030001
21	Thumbturn Retaining Pin Allen Set Screw #8-32 x 1/4"	CP-011013-040
22	Slider (varies related to keyway)	CP-084591
23	Slider Spring	CP-030910
24	Spade Thumbturn (Pictured on page 137 "Special Order") "SP"	CP-286051
25	Crescent Thumbturn (Pictured on page 137 "Special Order") "CR"	CP-286021

Medeco Premium High Security Euro Half Profile Cylinder

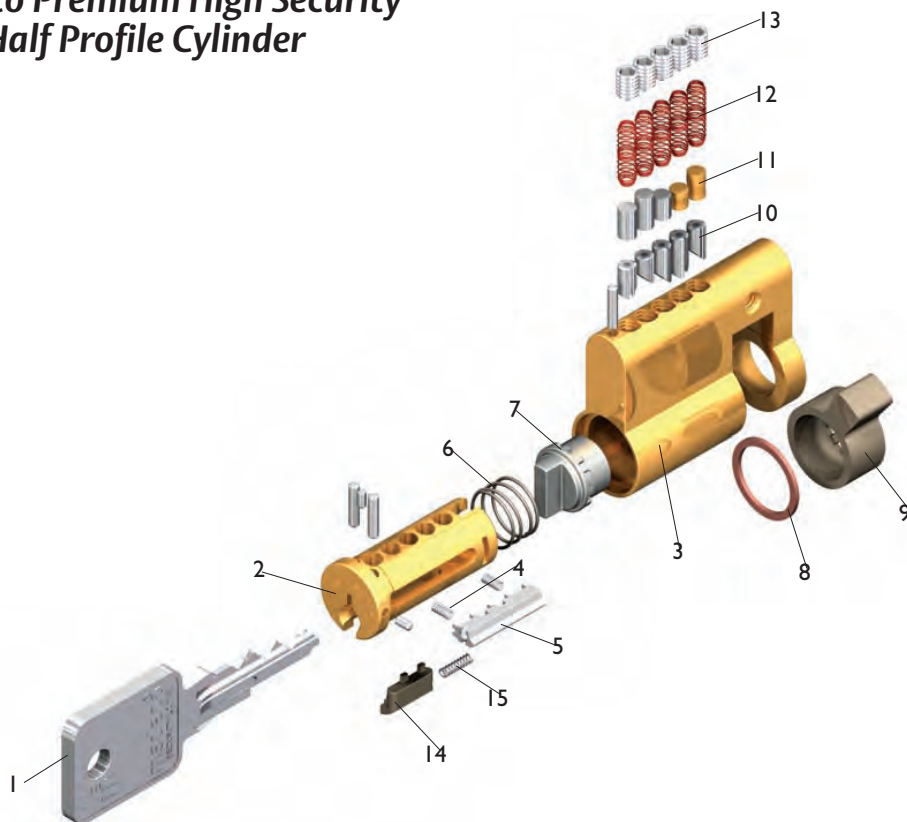

Item	Description	Part Number
1	Key	As Required
2	Plug	Cylinder Specific
3	Shell	Cylinder Specific
4	Sidebar Springs	CP-030018
5	Sidebar	CP-084X71
6	Cam Spring	CP-030860
7	Actuator	CP-220090
8	Plug Retainer	CP-021490
9	Cam	CT-Z88
10	Bottom Pins	As Required
11	Top Pins	As Required
12	Springs (Phosphor Bronze)	CP-030001
13	Pin Chamber Allen Set Screws #8-32 x 1/4"	CP-011013-040
14	Slider – (varies related to keyway)	CP-084591
15	Slider Spring	CP-030910

Medeco Premium High Security Exterior Scandinavian Oval Cylinder

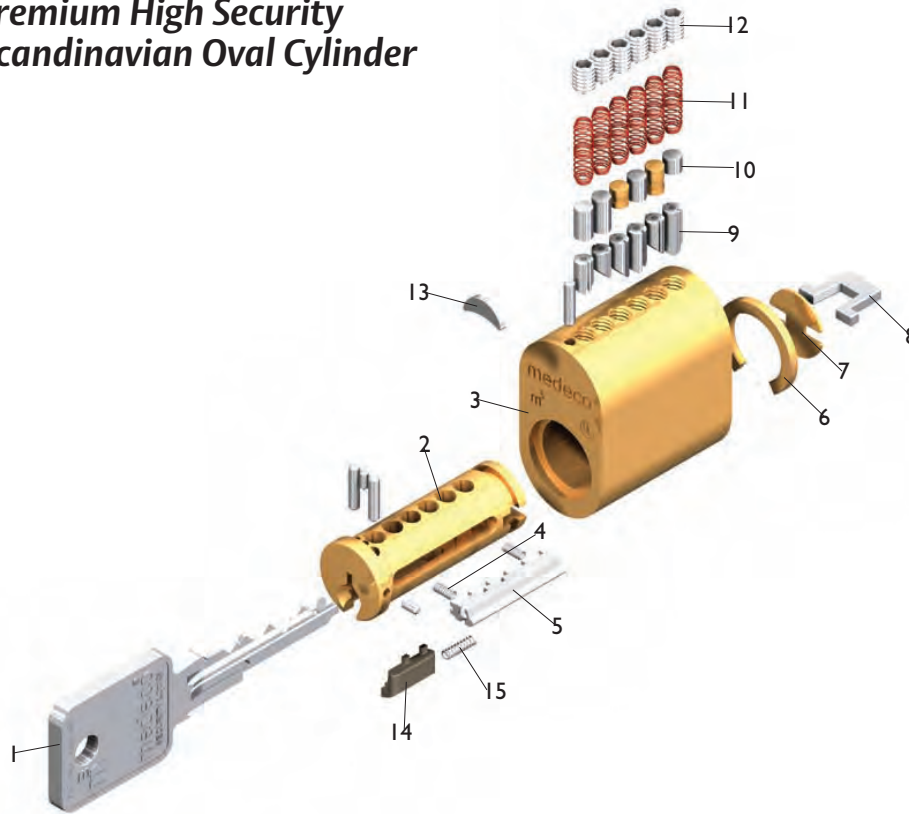

Item	Description	Part Number
1	Key	As Required
2	Plug	Cylinder Specific
3	Shell	Cylinder Specific
4	Sidebar Springs	CP-030018
5	Sidebar, 6 Pin	CP-084671
6	Plug Retainer	CP-021040
7	Plate	CP-180830
8	Tailpiece	CT-Y76
9	Bottom Pins	As Required
10	Top Pins	As Required
11	Springs (Phosphor Bronze)	CP-030001
12	Pin Chamber Allen Set Screws #8-32 x 1/4"	CP-011013-040
13	Crescent Steel Insert	CP-180011
14	Slider - (varies related to keyway)	CP-084591
15	Slider Spring	CP-030910

Medeco Premium High Security Interior Scandinavian Oval Cylinder

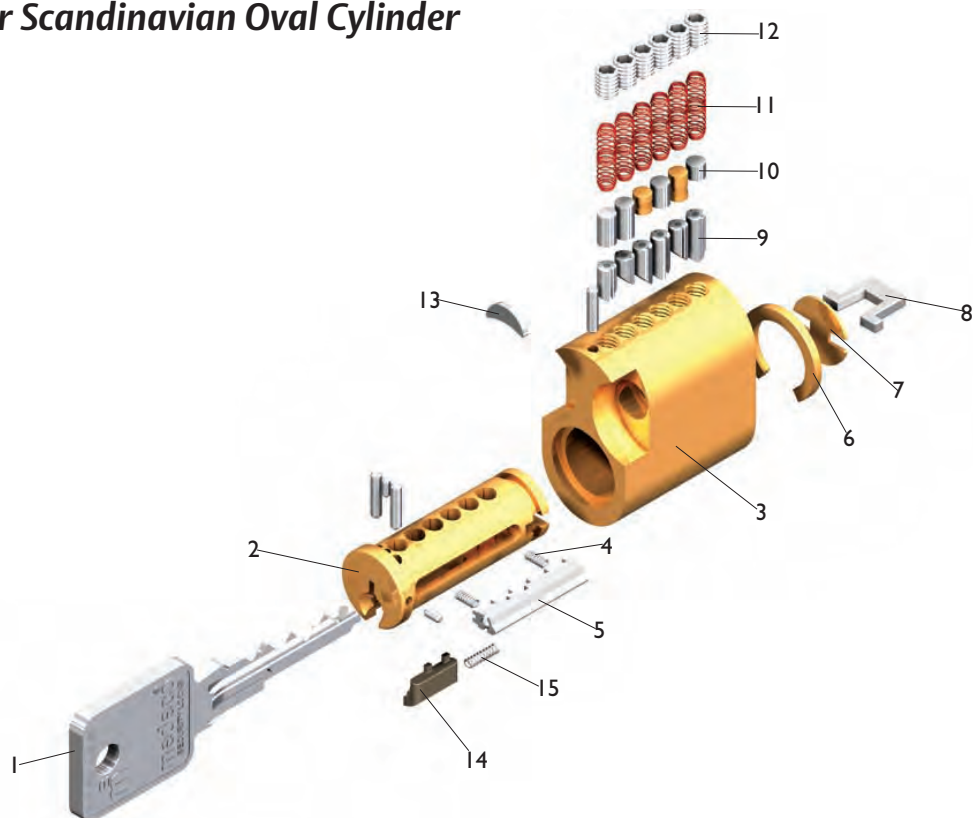

Item	Description	Part Number
1	Key	As Required
2	Plug	Cylinder Specific
3	Shell	Cylinder Specific
4	Sidebar Springs	CP-030018
5	Sidebar, 6 Pin	CP-084671
6	Plug Retainer	CP-021040
7	Plate	CP-180830
8	Tailpiece	CT-Y76
9	Bottom Pins	As Required
10	Top Pins	As Required
11	Springs (Phosphor Bronze)	CP-030001
12	Pin Chamber Allen Set Screws #8-32 x 1/4"	CP-011013-040
13	Crescent Steel Inserts	CP-180011
14	Slider – (varies related to keyway)	CP-084591
15	Slider Spring	CP-030910

Medeco Premium High Security Euro Double Profile

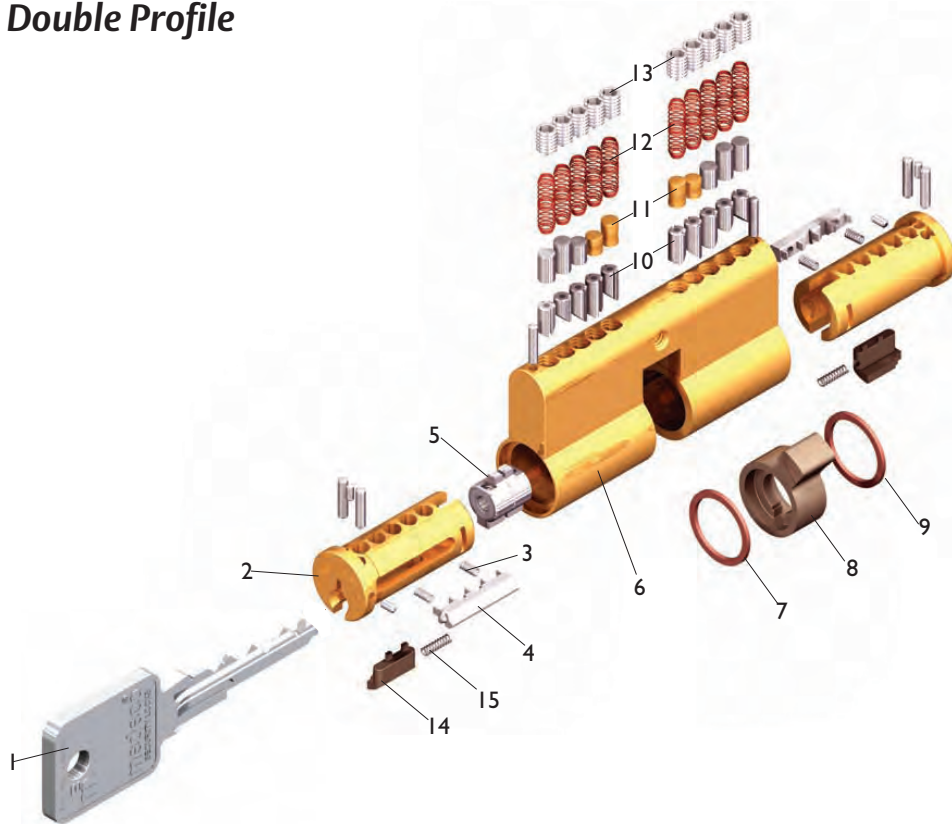

Item	Description	Part Number
1	Key	As Required
2	Plug	Cylinder Specific
3	Sidebar Springs	CP-030018
4	Sidebar, 5 Pin	CP-084571
5	Clutch	CP-220071
6	Shell	Cylinder Specific
7	Plug Retainer	CP-021490
8	Cam	CT-Z50
9	Plug Retainer	CP-021490
10	Bottom Pins	As Required
11	Top Pins	As Required
12	Springs (Phosphor Bronze)	CP-030001
13	Pin Chamber Allen Set Screws #8-32 x 1/4"	CP-0110113-040
14	Slider – (varies related to keyway)	CP-084591
15	Slider Spring	CP-030910

Medeco Premium High Security EuroLine Modular Profile Cylinder System

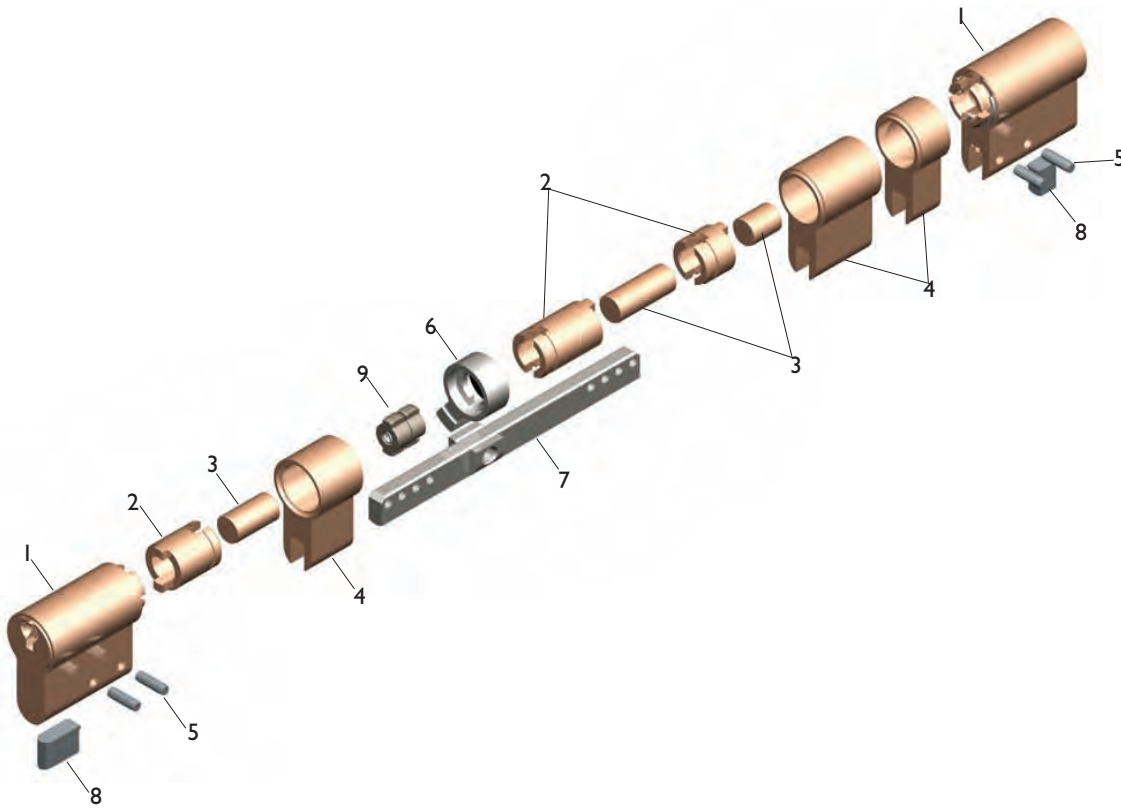

Modular Profile Double Cylinder

Item	Description	Part Number
1	Cylinder Module (5 or 6 Pin)	232201X 30X
2	Outer Plug Extension - 10mm – 25mm extensions available	CP-200751
3	Inner Plug Extension - 5mm – 25mm extensions available	CP-200761
4	Brass Shell Extension - finish required	CP-200771
5	Groove Pins	CP-063220
6	Cam	CT-Z50
7	Connecting Bar - requires length designation	CP-200801
8	Bar Filler	CP-160661
9	Clutch Assembly	CP-220071

Medeco Premium High Security EuroLine Modular Profile Cylinder System

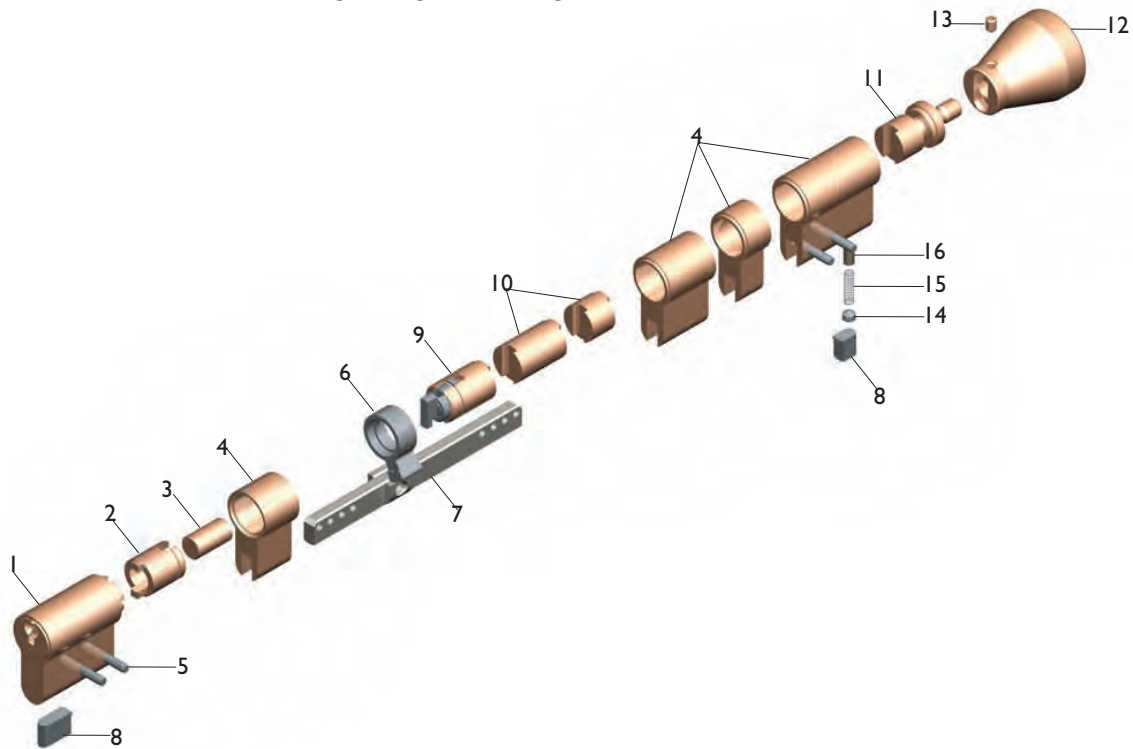

Modular Profile Single Cylinder with Thumbturn

Item	Description	Part Number
1	Thumbturn Cylinder Module (5 or 6 pin), requires knob selection	23X220XX-300
2	Outer Plug Extension, 10-25 mm extension	CP-200751
3	Inner Plug Extension, 5-25 mm extension	CP-200761
4	Brass Shell Extension, Finish required	CP-200771
5	Groove Pins	CP-063220
6	Cam	CP-Z51
7	Connecting Bar	CP-200801
8	Bar Filler	CP-160661
9	Thumbturn Actuator Cartridge	CP-220131
10	Thumbturn Cartridge Extension, 5-25 mm extension	CP-200781
11	Thumbturn Shaft – Modular Only	CP-240771-XP
12	Thumbturn Knob	See Page 137
13	Thumbturn Set Screw	CP-011013-020
14	Thumbturn Retaining Set Screw 8- 32 x 1/4"	CP-011013-040
15	Thumbturn Retaining Pin Spring	CP-030001
16	Thumbturn Retaining Pin	TP-F10-IT

Euro Profile Technical Information

A = Total Length
B = Interior Length

C = Exterior Length
KP = Knob to Face

EURO PROFILE SINGLE CYLINDER WITH THUMBTURN

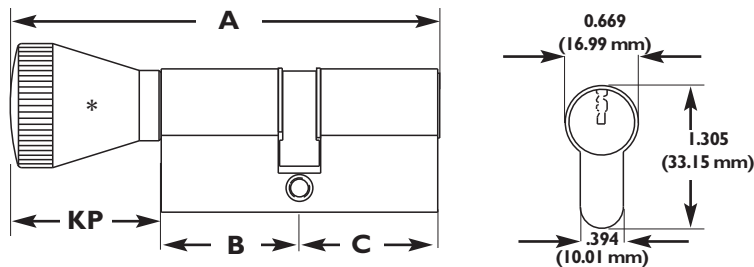

Euro Profile Single Cylinder with Thumbturn

Part#	A	B	C	KP
2313005 X00 *	99.04	31.98	31.98	35.08
2313035 X00	81.44	31.98	31.98	17.48
2313045 X00	83.09	31.98	31.98	19.13
2313055 X00	84.1	31.98	31.98	20.14
2313006 X00 *	107.68	36.3	36.3	35.08
2313036 X00	90.08	36.3	36.3	17.48
2313046 X00	91.73	36.3	36.3	19.13
2313056 X00	92.74	36.3	36.3	20.14
2313065 X00 (490264)	84.3	31.98	31.98	20.35
2313066 X00 (490291)	92.94	36.3	36.3	20.35

Euro Profile Technical Information

A = Total Length
B = Interior Length

C = Exterior Length

EURO PROFILE DOUBLE CYLINDER

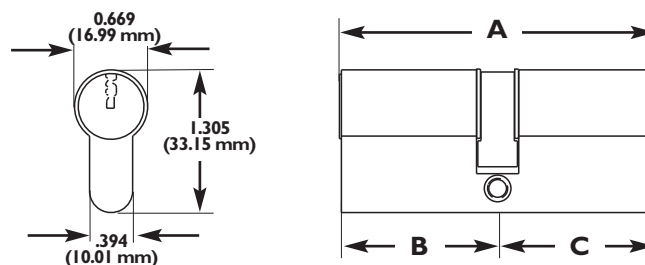

Euro Profile Double Cylinder with Thumbturn

Part#	A	B	C
2313025 X00	63.96	31.98	31.98
2313026 X00	72.59	36.3	36.3
2313025 X01	68.96	31.98	36.98
2313025 X02	73.96	31.98	41.99
2313025 X11	73.96	36.98	36.98
2313025 X12	78.97	36.98	41.99
2313026 X01	77.6	36.3	41.3
2313026 X02	82.6	36.3	46.3
2313026 X12	87.6	41.3	46.3

All table measurements in millimeters.

Euro Profile Technical Information

A = Total Length
 B = Interior Length
 C = Exterior Length

EURO PROFILE DOUBLE CYLINDER

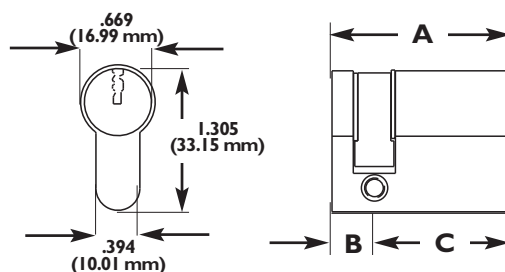

Euro Profile Single Cylinder with Thumbturn

Part#	A	B	C
2313015 800	41.99	10.01	31.98
2313016 800	46.4	10.01	36.3
2313015 801	46.99	10.01	36.98
2313016 801	51.31	10.01	41.3

All table measurements in millimeters.

Euro Profile Technical Information

Single Cylinder with Thumbturn (Standard Length)

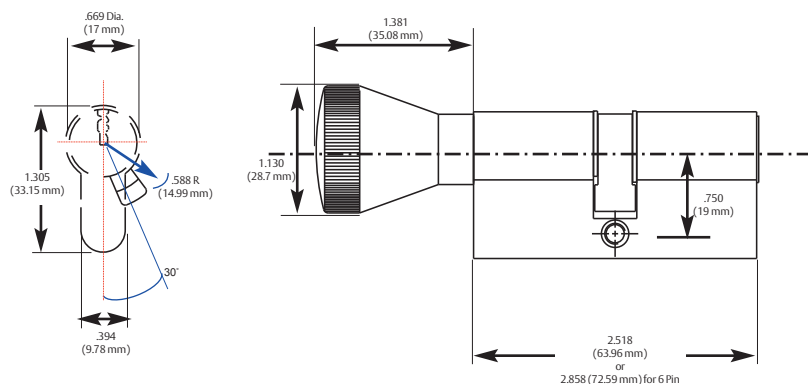

Cam position code as shown from outside.

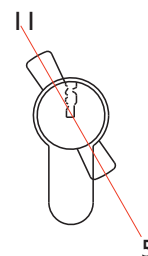

Part #: 2313005 XXX 5 Pin
 2313006 XXX 6 Pin

Half Cylinder (Standard Length)

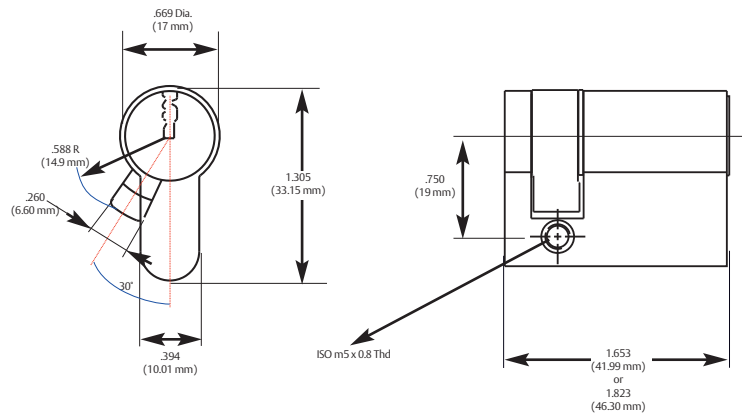

Cam position code as shown from outside.

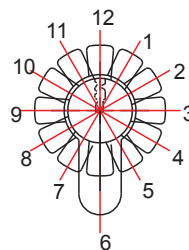

Multi-indexing cam with 12 positions. Cam is set at 5 o'clock from the factory

Part #: 2313015 8XX 5 Pin
2313016 8XX 6 Pin

Double Cylinder 5 Pin (Standard and Extended)

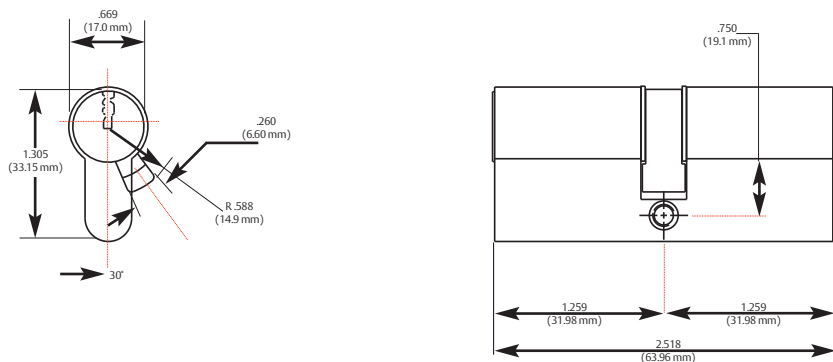

Cam position code as shown from outside.

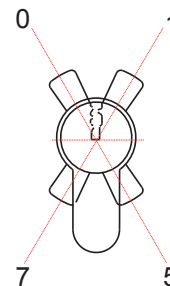

Part #: 2313025 X00 5 Pin
In 5mm steps up to 45mm

Double Cylinder 6 Pin (Standard and Extended)

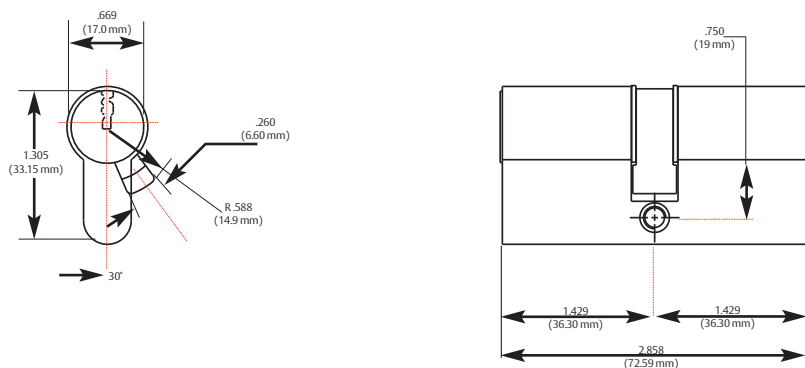

Cam position code as shown from outside.

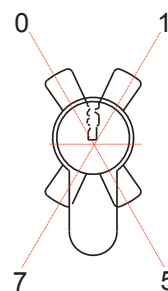

Part #: 2313026 X00 6 Pin
In 5mm steps up to 45mm

Union Single with Thumbturn

Cam position code as shown from outside.

Part #: **2304005 X00 5 Pin**
2304006 X00 6 Pin

Union Half Cylinder

Cam position code as shown from outside.

Part #: **2304015 X00 5 Pin**
2304016 X00 6 Pin

Union Double Cylinder

Cam position code as shown from outside.

Part #: **2304025 X00 5 Pin**
2304026 X00 6 Pin

Scandinavian Oval – Exterior for ASSA/Ruko®

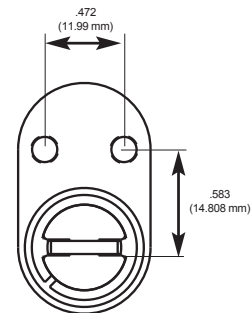
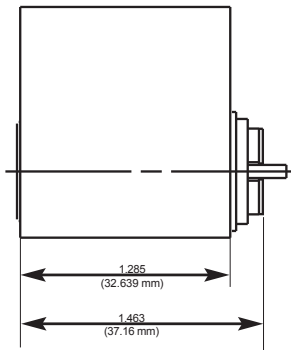
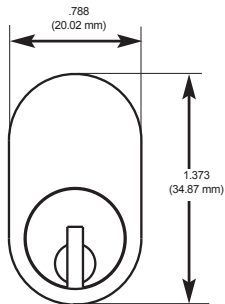

Tailpiece CT-Y76

Part #: 2305016 6 Pin

Scandinavian Oval – Interior for ASSA/Ruko®

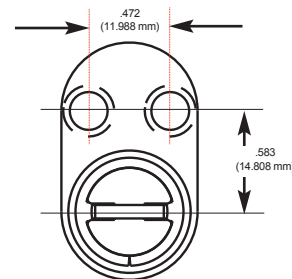
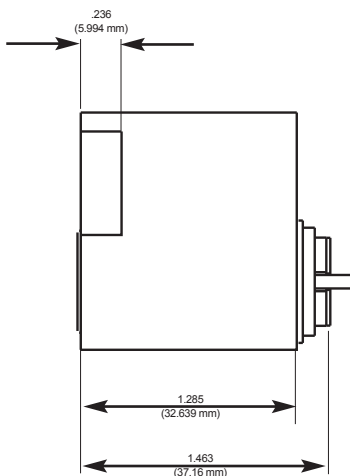
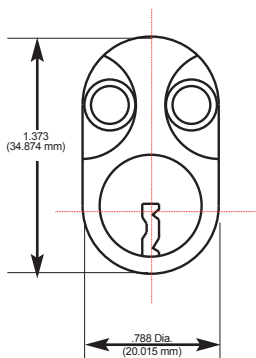

Tailpiece CT-Y76

Part #: 2306016 6 Pin

Scandinavian Padlock – for ASSA/Ruko®

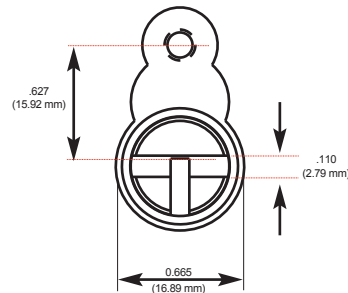
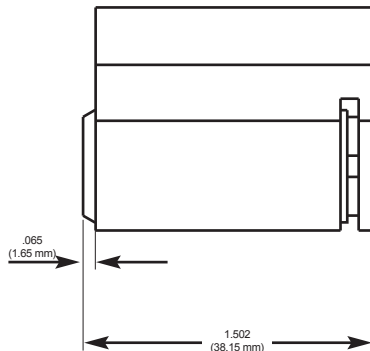
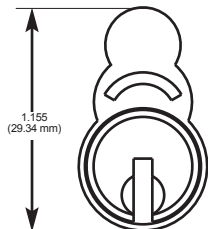

Part #: 2308016X 6 Pin

Scandinavian Round Exterior – for ASSA/Ruko®

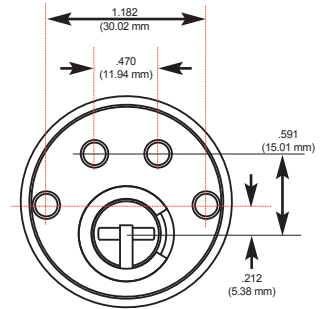
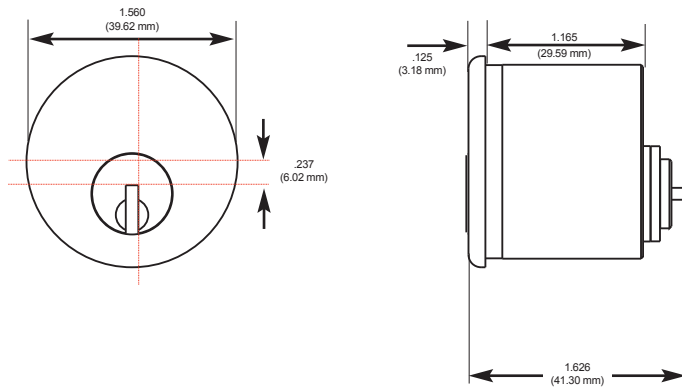

Part #: 2309016 6 Pin

Scandinavian Round Interior – for ASSA/Ruko®

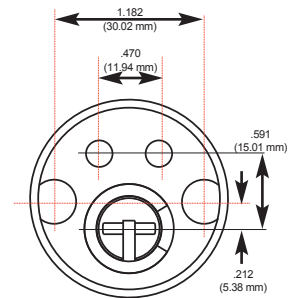
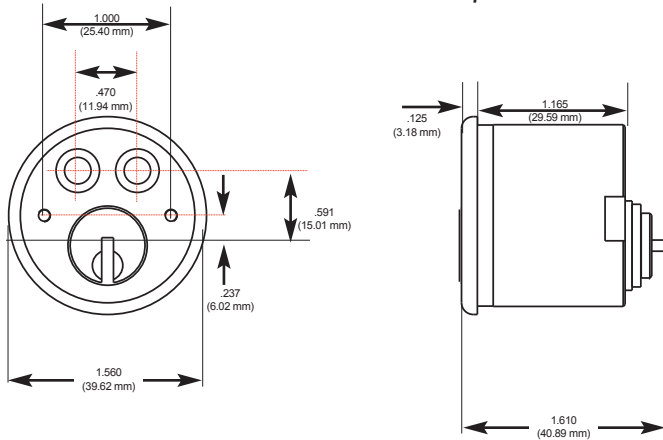

Part #: 2310016 6 Pin

Danish Round – Exterior for Ruko®

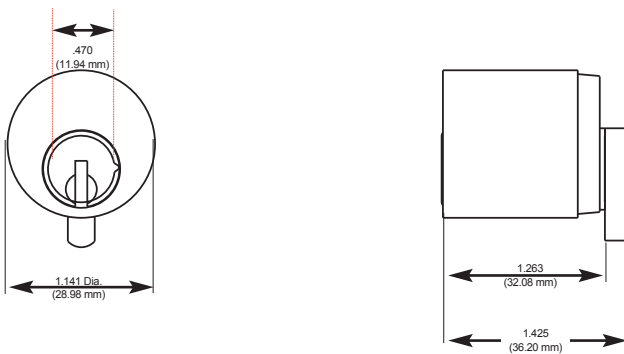

Special pinning required due to chamber height

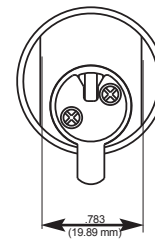

Part #: 2301016 6 Pin

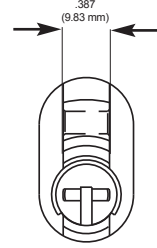
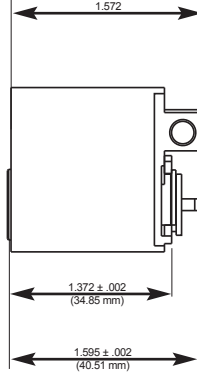
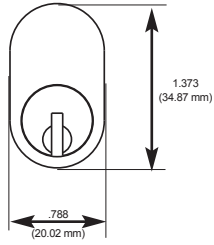
Norwegian Single Cylinder for Trio Ving®

Part #: 23070165 6 Pin

Euroline Modular Profile Kit

Description	Part Number	Price
Euroline Modular Profile Kit - Danish	940243	\$5,576.00
Medeco XT Half Profile Modular Kit	940279	\$3,644.00
Euro Single/Double Thumbturn Kit Mechanical/Electric Available in Medeco XT or M ³ CLIQ	940219	\$5,884.00
Export XT Demo Kit (Programmed to STOCK)	94-0287	\$866.00 NET
Upgrade Key Assembly Solo	94-0288	\$219.00 NET
Upgrade Key Assembly Web	94-0289	\$219.00 NET
Medeco XT Cam for Doubles – Not included in kit	CT-Z98	\$4.71

**Euroline Modular Cylinder Assembled**

Description	Part Number	M ³	X4	Biax/Orig
5 Pin Double Cylinder	2323025 X00	\$185.16		\$193.75
6 Pin Double Cylinder	2323026 X00	\$197.07		\$205.76
5 Pin Double Thumbturn/Cylinder	23230X5 X00	\$170.00		\$178.58
6 Pin Double Thumbturn/Cylinder	23230X6 X00	\$178.72		\$187.39
7 Pin X4 Euro Assembly ext. 0mm Thumbturn	23230X7 500		\$170.00	
7 Pin X4 Euro Assembly ext. 5mm Thumbturn	23230X7 511		\$178.00	

Euroline Modular eCylinder Assembled

Description	Part Number	Price
M ³ CLIQ, Thumbturn/Cylinder, 36/36mm	23230X6 X00 S	\$746.99
M ³ CLIQ Double, 36/36mm	23230E6 X00 S	\$796.05
Medeco XT Single Cylinder Half Euro	232301S 800 G	\$314.85
Medeco XT Single Cylinder Half Euro – ext. 5mm	232301S 801 G	\$318.85
Medeco XT Single Cylinder Half Euro Assembled (True 30mm)	232301ST 800 G	\$314.85
Medeco XT Single Cylinder Euro Thumbturn 30/30mm Assembled	23230XS X00 G	\$351.06
Medeco XT Single Cylinder Euro Thumbturn 35/35mm Assembled	23230XS X11 G	\$359.06
Medeco XT Double Euro Mechanical/eCyl 30/30mm Assembled	23230E5 X00 G	\$414.11
Medeco XT Double Euro Mechanical/eCyl 35/35mm Assembled	23230E5 X11 G	\$422.11
Special Pin Kit for Biaxial/Medeco ³ CLIQ Pinning	.KW5401	\$799.00

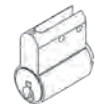
**EuroLine Profile Cylinder Modules**

Description	Part Number	M ³	X4	Biax/Orig
5 Pin Cylinder	2322015 300	\$59.50		\$62.00
5 Pin Cylinder + 5mm	2322015 301	\$63.50		\$66.00
6 Pin Cylinder	2322016 300	\$65.04		\$67.60
6 Pin Cylinder + 5mm	2322016 301	\$69.04		\$71.60
Medeco x4 Standard 7 Pin Cylinder (35.59mm)	2322017 300 N		\$36.10	
Medeco x4 7 Pin + 5mm Cylinder (40.59mm)	2322017 301 N		\$40.10	

Note: Pinned Modules include one cut key in the price.

(P) = Pinned (combined)

(S) = Sub-assembled (uncombined)

Surcharges for Master Keying, Custom Coining and Custom Stamping apply, see page 202.
Refer to the XT and CLIQ Intelligent Key sections for format availability and pricing.

Euroline eCylinder Profile Medeco XT Modules

Description	Part Number	Price
Medeco XT 30mm Single Cylinder Half Euro	232201S 300 G	\$269.76
Medeco XT 35mm Single Cylinder Half Euro	232201S 301 G	\$273.76
Medeco XT 40mm-85mm Single Cylinder Half Euro	232201S 302 G	\$269.76
Medeco XT 30mm Single Cylinder Thumbturn	232202S 300 G	\$269.76
Medeco XT 35mm Single Cylinder Thumbturn	232202S 301 G	\$273.76
Medeco XT 40mm-85mm Single Cylinder Thumbturn	232202S 302 G	\$269.76
Medeco XT 30mm Double Cylinder	232212SX 300 G	\$269.76
Medeco XT 35 mm Double Cylinder	232212SX 301 G	\$273.76
Medeco XT 40mm-85mm Double Cylinder	232222SX 302 G	\$277.76

**Euroline eCylinder Profile Medeco³ CLIQ Modules**

Description	Part Number	Price
M ³ CLIQ, 6 pin Module	2322016 300 S	\$666.86
M ³ CLIQ 6 pin + 5mm	2322016 301 S	\$670.86

EuroLine Profile Thumbturn Modules

Description	Part Number	Price
5 Pin Thumbturn	23220X5 300	\$60.43
6 Pin Thumbturn	23220X6 300	\$65.26
5 Pin X4 Thumbturn Module	23220X5 302	\$68.43

Euroline Profile Medeco XT Thumbturn Modules

Description	Part Number	Price
Euro Thumbturn Module - 30mm	23220XS 300	\$61.20

To order the Euro Thumbturn Module 35mm, you must add the shell ext. CP20071-05 and cart ext. CP-200781-05 to the 30mm Module

Special Cylinders

Description	Part Number	Price
Lockwood Oval retrofit AUS 570 Style	230301S G	\$295.00
KIK AUS 530 Style	201006 G	\$339.06
3-Tailpieces – For Australia Package	94-0283	\$28.10
Medeco XT Ruko Oval	230501S G	\$317.00
Medeco XT AUS 8221 PD Style	20112B1 G	\$339.06

(P) = Pinned (combined)

(S) = Sub-assembled (uncombined)

Surcharges for Master Keying, Custom Coining and Custom Stamping apply, see page 203.
Refer to the XT and CLIQ Intelligent Key sections for format availability and pricing.

Plug Extensions – Outer

*Quantities shown in parentheses below are included in the 94-0219 Euroline modular profile kit listed above. Additional items may be ordered individually.



Description	Part Number	Price
10mm Kit Qty (20)	CP-200751-10	\$5.64
15mm Kit Qty (10)	CP-200751-15	\$6.23
20mm Kit Qty (5)	CP-200751-20	\$6.57
25mm Kit Qty (5)	CP-200751-25	\$8.04
30mm	CP-200751-30	\$8.49
40mm	CP-200751-40	\$9.28
45mm	CP-200751-45	\$9.62
50mm	CP-200751-50	\$11.00
55mm	CP-200751-55	\$11.40
60mm	CP-200751-60	\$11.90
65mm	CP-200751-65	\$12.30
70mm	CP-200751-70	\$13.10
75mm	CP-200751-75	\$13.20
80mm	CP-200751-80	\$13.80
85mm	CP-200751-85	\$14.50
90mm	CP-200751-90	\$15.20

Plug Extensions – Inner

Description	Part Number	Price
5mm Kit Qty (20)	CP-200761-05	\$3.65
10mm Kit Qty (20)	CP-200761-10	\$4.01
15mm Kit Qty (10)	CP-200761-15	\$4.60
20mm Kit Qty (5)	CP-200761-20	\$5.06
25mm Kit Qty (5)	CP-200761-25	\$6.23
30mm	CP-200761-30	\$6.57
40mm	CP-200761-40	\$7.59
45mm	CP-200761-45	\$8.94
50mm	CP-200761-50	\$9.28
55mm	CP-200761-55	\$9.62
60mm	CP-200761-60	\$10.60
65mm	CP-200761-65	\$11.00
70mm	CP-200761-70	\$15.20
75mm	CP-200761-75	\$15.20
80mm	CP-200761-80	\$15.80
85mm	CP-200761-85	\$16.60
90mm	CP-200761-90	\$16.60

(P) = Pinned (combined)

(S) = Sub-assembled (uncombined)

Surcharges for Master Keying, Custom Coining and Custom Stamping apply, see page 202.
Refer to the XT and CLIQ Intelligent Key sections for format availability and pricing.

Plug Extensions - Double EAC/EAC

Description	Part Number	Price
10mm	CP-200851-10	\$13.70
15mm	CP-200851-15	\$14.10
20mm	CP-200851-20	\$14.50
25mm	CP-200851-25	\$15.70
30mm	CP-200851-30	\$16.00
40mm	CP-200851-40	\$16.90
45mm	CP-200851-45	\$17.20
50mm	CP-200851-50	\$17.60
55mm	CP-200851-55	\$17.90
60mm	CP-200851-60	\$18.60
65mm	CP-200851-65	\$18.90
70mm	CP-200851-70	\$19.30
75mm	CP-200851-75	\$19.70
80mm	CP-200851-80	\$20.00
85mm	CP-200851-85	\$20.40
90mm	CP-200851-90	\$20.80

**Brass Shell Extensions**

Description	Part Number	Price
5mm Kit Qty (20)	CP-200771-05	\$7.81
10mm Kit Qty (20)	CP-200771-10	\$8.94
15mm Kit Qty (10)	CP-200771-15	\$10.40
20mm Kit Qty (5)	CP-200771-20	\$11.70
25mm Kit Qty (5)	CP-200771-25	\$13.00

**Connecting Bar**

Description	Part Number	Price
5mm Kit Qty (15)	CP-200801-00	\$31.00
10mm Kit Qty (5)	CP-200801-02	\$33.50
20mm Kit Qty (5)	CP-200801-04	\$35.70
30mm Kit Qty (5)	CP-200801-06	\$37.40
40mm Kit Qty (1)	CP-200801-08	\$39.50
50mm Kit Qty (1)	CP-200801-0A	\$42.20
10/10mm Kit Qty (5)	CP-200801-22	\$35.70
10/20mm Kit Qty (5)	CP-200801-24	\$37.40
10/30mm Kit Qty (3)	CP-200801-26	\$39.50
10/40mm Kit Qty (1)	CP-200801-28	\$42.20
10/50mm Kit Qty (1)	CP-200801-2A	\$44.80
20/20mm Kit Qty (3)	CP-200801-44	\$39.50
20/30mm Kit Qty (1)	CP-200801-46	\$42.20
20/40mm Kit Qty (1)	CP-200801-48	\$44.80
20/50mm Kit Qty (1)	CP-200801-4A	\$47.40
30/30mm Kit Qty (1)	CP-200801-66	\$44.80
30/40mm Kit Qty (1)	CP-200801-68	\$47.40
30/50mm Kit Qty (1)	CP-200801-6A	\$49.50
40/40mm Kit Qty (1)	CP-200801-88	\$49.50
40/50mm Kit Qty (1)	CP-200801-8A	\$51.40
50/50mm Kit Qty (1)	CP-200801-AA	\$54.80

(P) = Pinned (combined)

(S) = Sub-assembled (uncombined)

Surcharges for Master Keying, Custom Coining and Custom Stamping apply, see page 203.
Refer to the XT and CLIQ Intelligent Key sections for format availability and pricing.



Modular Thumbturn Shaft

Description	Part Number	Price
5 Pin Kit Qty (2)	CP-240771-5P	\$11.10
6 Pin Kit Qty (2)	CP-240771-6P	\$11.40



Modular Service Tools

Description	Part Number	Price
Modular Assembly Block Kit Qty (1)	94-0208	\$1,102.00
Pinning Block Kit Qty (2)	94-0203	\$11.20
Pinning Block Medeco X4	94-0285	\$11.20
Capping Tool Kit Qty (2)	94-0207	\$2.10
Small flat blade screwdriver Kit Qty (1)	94-0221	\$50.90
Removing Punch, 2.3 mm Kit Qty (1)	94-0222	\$153.00
Installing punch, 6.35 mm Kit Qty (1)	94-0223	\$153.00
Allen Wrench, 1.588 mm Kit Qty (1)	CP-280330	\$3.54

Miscellaneous Components

Description	Part Number	Price
Groove Pin Kit Qty (200)	CP-063220	\$0.66
Clutch Piece Assembly Kit Qty (20)	CP-220071	\$8.72
5 Pin Cover Kit Qty (100)	CP-170730-5	\$0.67
6 Pin Cover Kit Qty (100)	CP-170730-6	\$0.67
Double Cam Kit Qty (20)	CT-Z50	\$4.71
Thumbturn Cam Kit Qty (20)	CT-Z51	\$4.71

(P) = Pinned (combined)







(S) = Sub-assembled (uncombined)

Surcharges for Master Keying, Custom Coining and Custom Stamping apply, see page 202.
Refer to the XT and CLIQ Intelligent Key sections for format availability and pricing.

Top Pins

Description	Part Number
1 top pin Kit Qty (200)	TP-F10-4T (.180")
2 top pin Kit Qty (200)	TP-F10-5T (.150")
3 top pin Kit Qty (200)	TP-H10-9W (.135")
4 top pin Kit Qty (200)	TP-F10-4W-6T (.120")
5 top pin Kit Qty (200)	TP-F10-3W (.090")
6 top pin Kit qty (200)	TP-F10-2W (.060")

Thumbturn Knobs

Description	Part Number	Price
 Decorative "RD" 4 CP-285901 \$20.40		
 Lever "RL" 5 CP-285931 \$30.30		
 Round "SR" 0 CP-285961 \$30.30		
 Low Profile "LP" 3 CP-285991 \$20.40		
 Crescent "CR" 6 CP-286021 \$15.80		
 Spade "SP" 7 CP-286051 \$15.80		

Finish required.

Thumbturn Assembly - Shaft, Knob, Set Screw - 5 pin

Description	Part Number	Price
Decorative	CP-285921-500	\$61.40
Lever	CP-285951-500	\$91.70
Standard Round	CP-285981-500	\$91.70
Low Profile	CP-286011-500	\$61.40
Crescent	CP-286041-500	\$28.40
Spade	CP-286071-500	\$61.40
Less TT Knob	CP-240761-500	\$27.00

(P) = Pinned (combined)

(S) = Sub-assembled (uncombined)

Surcharges for Master Keying, Custom Coining and Custom Stamping apply, see page 202.
Refer to the XT and CLIQ Intelligent Key sections for format availability and pricing.

Medeco XT Half Cylinder Connecting Bar

*Quantities shown in parentheses below are included in the 94-0279 Euroline half cylinder kit listed above. Additional items may be ordered individually.



Description	Part Number	Price
40, 45mm Kit Qty (6)	CP-200801-12	\$26.40
50, 55mm Kit Qty (5)	CP-200801-14	\$29.00
60, 65mm Kit Qty (3)	CP-200801-16	\$31.00
70, 75mm Kit Qty (3)	CP-200801-18	\$33.50
80, 85 mm Kit Qty (3)	CP-200801-1A	\$35.70

**Plug Extensions Outer for 94-0279**

Description	Part Number	Price
10mm Kit Qty (20)	CP-200751-10	\$5.64
15mm Kit Qty (15)	CP-200751-15	\$6.23
20mm Kit Qty (5)	CP-200751-20	\$6.57
25mm Kit Qty (5)	CP-200751-25	\$8.04

Brass Shell Extensions for 94-0279

Description	Part Number	Price
5mm Kit Qty (20)	CP-200771-05	\$7.81
10mm Kit Qty (20)	CP-200771-10	\$8.94
15mm Kit Qty (10)	CP-200771-15	\$10.40
20mm Kit Qty (5)	CP-200771-20	\$11.70
25mm Kit Qty (5)	CP-200771-25	\$13.00

Bar Filler (2 per Cylinder) for 94-0279

Description	Part Number	Price
5 Pin, 0mm Kit Qty (20)	CP-160661-50	\$1.30
5 Pin, 5mm Kit Qty (20)	CP-160661-55	\$1.30

Miscellaneous Components for 94-0279









Description	Part Number	Price
Half Shell Backend Kit Qty (20)	CP-200830	\$19.20
Actuator Spring Kit Qty (25)	CP-030860	\$1.17
Indexable Actuator Kit Qty (20)	CP-220090	\$5.30
Security Pin Kit Qty (25)	CP-060106	\$1.30
Groove Pin Kit Qty (65)	CP-063220	\$0.66
Indexable Cam	CT-Z88	\$4.71

(P) = Pinned (combined)

(S) = Sub-assembled (uncombined)

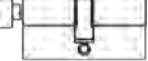
Surcharges for Master Keying, Custom Coining and Custom Stamping apply, see page 202.
Refer to the XT and CLIQ Intelligent Key sections for format availability and pricing.

Euro Profile Single Cylinder with Thumbturn

Description	Part Number	M4/M ³	BiLevel	X4	Biax/Orig	KeyMark
 5 Pin, Standard Round "SR" Thumbturn	2313005 X00 (P)	\$170.00			\$178.58	
	2313005 X00 (S)	\$156.00			\$164.58	
 6 Pin, Standard Round "SR" Thumbturn	2313006 X00 (P)	\$178.72			\$187.39	
	2313006 X00 (S)	\$164.72			\$173.39	
 5 Pin, Low Profile "LP" Thumbturn	2313035 X00 (P)	\$170.00			\$178.58	
	2313035 X00 (S)	\$156.00			\$164.58	
 6 Pin, Low Profile "LP" Thumbturn	2313036 X00 (P)	\$178.72			\$187.39	
	2313036 X00 (S)	\$164.72			\$173.39	
 5 Pin, Removable Decorative "RD" Thumbturn	2313045 X00 (P)	\$170.00			\$178.58	
	2313045 X00 (S)	\$156.00			\$164.58	
 6 Pin, Removable Decorative "RD" Thumbturn	2313046 X00 (P)	\$178.72			\$187.39	
	2313046 X00 (S)	\$164.72			\$173.39	
 5 Pin, Removable Lever "RL" Thumbturn	2313055 X00 (P)	\$170.00			\$178.58	
	2313055 X00 (S)	\$156.00			\$164.58	
 6 Pin, Removable Lever "RL" Thumbturn	2313056 X00 (P)	\$178.72			\$187.39	
	2313056 X00 (S)	\$164.72			\$173.39	
 5 Pin, Euro Crescent "CR" Thumbturn	2313065 X00 (P)	\$170.00			\$178.58	
	2313065 X00 (S)	\$156.00			\$164.58	
 6 Pin, Euro Crescent "CR" Thumbturn	2313066 X00 (P)	\$178.72			\$187.39	
	2313066 X00 (S)	\$164.72			\$173.39	

(P) = Pinned (combined)



(S) = Sub-assembled (uncombined)

Surcharges for Master Keying, Custom Coining and Custom Stamping apply, see page 202.
Refer to the XT and CLIQ Intelligent Key sections for format availability and pricing.

Euro Profile Double Cylinder

Description	Part Number	M4/M³	BiLevel	X4	Biax/Orig	KeyMark
 5 Pin, No Extension	2313025 X00 (P)	\$173.47			\$181.95	
	2313025 X00 (S)	\$145.47			\$153.95	
 5 Pin Extended, 5 mm Ext. Side (0mm/5mm)	2313025 X01 (P)	\$177.47			\$185.95	
	2313025 X01 (S)	\$149.47			\$157.95	
 5 Pin Extended, 10 mm Ext. Side (0mm/10mm)	2313025 X02 (P)	\$181.47			\$189.95	
	2313025 X02 (S)	\$153.47			\$161.95	
 5 Pin Extended, (5mm/5mm)	2313025 X11 (P)	\$181.47			\$189.95	
	2313025 X11 (S)	\$153.47			\$161.95	
 5 Pin Extended, (5mm/10mm)	2313025 X12 (P)	\$185.47			\$193.95	
	2313025 X12 (S)	\$157.47			\$165.95	
 6 Pin, No Extension	2313026 X00 (P)	\$185.16			\$193.75	
	2313026 X00 (S)	\$157.16			\$165.75	
 6 Pin Extended, 5mm Ext. Side (0 mm/5 mm)	2313026 X01 (P)	\$189.16			\$197.75	
	2313026 X01 (S)	\$161.16			\$169.75	
 6 Pin Extended, 10mm Ext. Side (0 mm/10 mm)	2313026 X02 (P)	\$193.16			\$201.75	
	2313026 X02 (S)	\$165.16			\$173.75	
 6 Pin Extended, (5mm/10mm)	2313026 X12 (P)	\$197.16			\$205.75	
	2313026 X12 (S)	\$169.16			\$177.75	

Euro Profile Half Cylinder

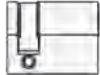
Description	Part Number	M4/M³	BiLevel	X4	Biax/Orig	KeyMark
 5 Pin with 12 Position Indexable Cam	2313015 800 (P)	\$146.39			\$154.64	
	2313015 800 (S)	\$132.39			\$140.64	
 5 Pin, Extended 5 mm with 12 Position Indexable Cam	2313015 801 (P)	\$150.39			\$158.64	
	2313015 801 (S)	\$136.39			\$144.64	
 6 Pin with 12 Position Indexable Cam	2313016 800 (P)	\$148.15			\$156.51	
	2313016 800 (S)	\$134.15			\$142.51	
 6 Pin, Extended 5 mm with 12 Position Indexable Cam	2313016 801 (P)	\$152.15			\$160.51	
	2313016 801 (S)	\$138.15			\$146.51	

(P) = Pinned (combined)
 (S) = Sub-assembled (uncombined)
 Surcharges for Master Keying, Custom Coining and Custom Stamping apply, see page 202.
 Refer to the XT and CLIQ Intelligent Key sections for format availability and pricing.

Other International Cylinders

Description	Part Number	M4/M ³	BiLevel	X4	Biax/Orig	KeyMark
Danish Round Mortise Cylinder	2301016 (P)	\$136.00			\$142.71	
	2301016 (S)	\$122.00			\$128.71	
Danish Special Cam Lock (Ruko®)	23010168 (P)				\$107.90	
	23010168 (S)				\$93.90	
Australian Oval - Less Cams and Pins	2303016A (S)	\$156.00			\$164.58	
5 Pin British Oval Single Cylinder with Thumbturn	2304005 (P)	\$191.00			\$200.74	
	2304005 (S)	\$177.00			\$186.74	
6 Pin British Oval Single Cylinder with Thumbturn	2304006 (P)	\$191.00			\$200.74	
	2304006 (S)	\$177.00			\$186.74	
5 Pin British Oval Half Cylinder	2304015 (P)	\$144.33			\$153.63	
	2304015 (S)	\$130.33			\$139.63	
6 Pin British Oval Half Cylinder	2304016 (P)	\$144.33			\$153.63	
	2304016 (S)	\$130.33			\$139.63	
5 Pin British Oval Double Cylinder	2304025 (P)	\$195.72			\$205.35	
	2304025 (S)	\$167.72			\$177.35	
6 Pin British Oval Double Cylinder	2304026 (P)	\$195.72			\$205.35	
	2304026 (S)	\$167.72			\$177.35	
Scandinavian Oval Exterior Cylinder	2305016 (P)	\$142.00			\$149.04	
	2305016 (S)	\$128.00			\$135.04	
Scandinavian Oval Interior Cylinder	2306016 (P)	\$142.00			\$149.04	
	2306016 (S)	\$128.00			\$135.04	
Norwegian Oval Shape Cylinder	23070165 (P)	\$159.00			\$166.97	
	23070165 (S)	\$145.00			\$152.97	
Scandinavian Snowman Cylinder	23080166 (P)	\$162.00			\$170.14	
	23080166 (S)	\$148.00			\$156.14	
Scandinavian Round Exterior Cylinder	2309016 (P)	\$209.00			\$219.72	
	2309016 (S)	\$195.00			\$205.72	
Scandinavian Round Interior Cylinder	2310016 (P)	\$209.00			\$219.72	
	2310016 (S)	\$195.00			\$205.72	
Italian Cylinder Inner Gate Lock, 3 Pin	2314003 (P)	\$100.40			\$105.15	
	2314003 (S)	\$86.40			\$91.15	
Italian Cylinder Exterior Gate Lock, 5 Pin	2315005 (P)	\$113.50			\$118.97	
	2315005 (S)	\$99.50			\$104.97	
Italian Roller Shutter 4 Pin	2316004 (P)	\$113.50			\$118.97	
	2316004 (S)	\$99.50			\$104.97	
Danish Cam Lock (for Ruko®) w/ 90° Stop	2320016 (P)	\$136.00			\$142.71	
	2320016 (S)	\$122.00			\$128.71	

(P) = Pinned (combined)

(S) = Sub-assembled (uncombined)

Surcharges for Master Keying, Custom Coining and Custom Stamping apply, see page 202.
Refer to the XT and CLIQ Intelligent Key sections for format availability and pricing.

Profile Components

Description	Part Number	Price
5 Pin Plug For Half Cylinder	12286	\$62.30
5 Pin Double Cylinder Profile Plug	12286	\$62.30
6 Pin Plug For Half Cylinder	12288	\$62.30
6 Pin Double Cylinder Profile Plug	12288	\$62.30
5 Pin Double Cylinder Profile Shell	13327	\$87.70
6 Pin Double Cylinder Profile Shell	13346	\$87.70
5 Pin Shell For Half Cylinder	13365	\$87.70
6 Pin Shell For Half Cylinder	13375	\$87.70
Thumbturn Set Screw	CP-011013-020	\$0.31
Profile Cylinder Set Screw, #8-32 x 1/4"	CP-011013-040	\$0.43
Set Screw for "CR" Thumbturn	CP-012409-030	\$0.65
Thumbturn Set Screw	CP-012411-030	\$0.83
Set Screw For Removable Thumbturn	CP-012411-040	\$0.83
Thumbturn Retaining Clip	CP-020031	\$6.23
Cartridge Retainer	CP-020240	\$0.26
Plug Retaining Clip - Old Style, C Clip	CP-021400	\$5.87
Plug Retaining Clip - Continuous Ring	CP-021490	\$1.77
Tumbler Spring	CP-030001	\$0.10
Single Cylinder Profile Pilot Spring	CP-030024	\$0.69
Single Cylinder Profile Thumbturn Actuator Spring	CP-030025	\$0.25
Actuator Spring For Half Cylinder	CP-030860	\$1.17
Snap Ring	CP-031030	\$0.72
Single Cylinder Profile Actuator	CP-100111	\$11.70
Double Cylinder Profile EAC/EAC Push Rod	CP-100761	Consult Factory
Double Cylinder Profile Clutch	CP-220071	\$8.72
5 and 6 Pin Actuator For Half Cylinder	CP-220090	\$5.30
Clutch Assembly, Emergency	CP-220120	\$31.70
Double Cylinder Profile EAC/EAC Clutch	CP-220201	\$82.40
Double Cylinder Profile Gear Cam	CP-230081	\$10.40
Thumbturn Cylinder Profile Gear Cam	CP-230091	\$10.40
Single Cylinder Profile Thumbturn Actuator Pilot	CP-280261	\$15.80
Standard Round "SR" Thumbturn Assembly 5 Pin	CP-285981-500	\$91.70
Low Profile "LP" Thumbturn Assembly 5 Pin	CP-286011-500	\$61.40
Lever "RL" Thumbturn Assembly 5 Pin	CP-285951-500	\$91.70
Crescent "CR" Thumbturn Assembly 5 Pin	CP-286041-500	\$28.40
Decorative "RD" Thumbturn Assembly 5 Pin	CP-285921-500	\$61.40
Decorative "RD" Thumbturn Only	CP-285901	\$20.40
Lever "RL" Thumbturn Only	CP-285931	\$30.30
Low Profile "SR" Thumbturn Only	CP-285961	\$30.30
Low Profile "LP" Thumbturn Only	CP-285991	\$20.40
Oval Int./Ext. Cylinder tailpiece	CT-Y76	\$4.71
Cam, British Oval (Half/Double)	CT-Z26	\$4.71
Cam, British Oval (Thumbturn)	CT-Z29	\$4.71
Double Cylinder Profile Cam	CT-Z50	\$4.71
Thumbturn Cylinder Profile Cam, Non Indexing	CT-Z51	\$4.71
Indexing Cam For Half Cylinders	CT-Z88	\$4.71
Cam, Medeco XT Double Profile Cyl	CT-Z98	\$4.71
Double Cylinder Profile EAC/EAC Cam	CT-ZA2	\$4.71

(P) = Pinned (combined)

(S) = Sub-assembled (uncombined)

Surcharges for Master Keying, Custom Coining and Custom Stamping apply, see page 202.
Refer to the XT and CLIQ Intelligent Key sections for format availability and pricing.

Maxum Deadbolts

FEATURES	Medeco 4	BiLevel	Medeco X4	CLIQ
UL Listed for use on fire doors having a rating up to three hours	●	●	●	●
ANSI/BHMA 156.36 Grade 1 Certification for auxiliary locks and associated products	●			
ANSI/BHMA A156.30 Level A Certification on the cylinder assures patent protected key control and physical strength	●			
Can be incorporated into existing master key systems	●	●	●	
Security features to protect against drill, wrench, ice pick, kick-in, hammer, bumping and prying attacks	●	●		
Solid brass construction provides high quality and long cylinder life	●	●	●	
Deadbolt is designed to accommodate both mortise and drive-in face applications for greater flexibility and ease of installation	●	●	●	
Large thumbturn provides ease of use for physically challenged individuals	●	●	●	
Keys may be integrated with Hybrid proximity head for greater system retrofit	●	●	●	
Double cylinder captive thumbturn safety option available	●	●		

Medeco 4 Premium High Security

For effective mechanical protection against most forms of attack as well as protection against unauthorized duplicate keys, Medeco 4 cylinders are recommended. Security features including hardened steel components, pins that must be elevated, rotated, and interact with a sidebar which is engaged by the movable element in the key make Medeco 4 the cylinder of choice to protect people, property and information.

Medeco X4 Patented Key Control

Medeco X4 cylinders offer patented control against unauthorized duplication of keys without the additional security features protecting against force or surreptitious attack.

Medeco 4 BiLevel Key Control

Medeco 4 BiLevel cylinders may be incorporated into a master key system with Medeco 4 high security, offering protection against all types of attack where needed, and patented key control cylinders for areas requiring less protection. BiLevel cylinders offer patented control against unauthorized duplication of keys without the additional security features protecting against force or surreptitious attack.

Intelligent Key Solutions

Many of the cylinders in this section are also available with an Intelligent Key solution. See the Intelligent Key section for more details.

Maxum® Deadbolts

Deadbolts are about strength. Just hold an ANSI Grade 1 Maxum® deadbolt in your hand, and you know this is one tough hunk of protection. Maxum deadbolt is available as a single- or double-cylinder or with a “captive thumbturn.” The captive thumbturn converts the inside cylinder to a thumbturn for easy exit when the facility is occupied. A quick conversion when the facility is not occupied returns it to double cylinder mode to guard against unauthorized entry. Maxum® deadbolts are UL 437 listed, offering maximum protection with solid-brass construction, along with anti-drilling, picking and anti-prying features.



Key Control

Patent-pending key control protects against unauthorized duplication of keys (Medeco 4).



Protection Against 3D Printing

A patent-pending movable element in the key deters unauthorized 3D printed copies of keys or blanks.



Picking and Bumping Protection

M4 cylinders use cylinder side pins, a shuttle lift pin and a movable key element to engage a sidebar that prevents the key from turning until the elements are rotated and aligned in the correct position, protecting against bumping, picking and other attacks.



Certified Grade 1

BHMA certified Grade 1, passes to the highest standards in the industry.



Drill Protection

Offers maximum protection with solid-brass construction and strategically placed drill pins.



Protection From Physical Attack

Medeco 4 Maxum Deadbolts are UL 437 Listed and stand up to prying, picking and other forms of physical attack.



Special Angle Cut Keys

Requires a special key cutting machine and access to Medeco specific blanks, available in a variety of restrictions to support every need.



Master Keying Capabilities

M4 deadbolts can be master keyed into a system that includes M4, M4 BiLevel*, and M4 CLIQ** keys and cylinders. Extremely large systems are possible.

Technical Information:

- ANSI/BHMA A156.36 Grade 1 and UL 437 listed cylinders for high security
- Fits doors 1 3/8" to 2 1/2" thick
- Standard 2 1/8" crossbore and 1" edge bore (ANSI A115.13 prep)

Warranty:

Warranted for two (2) years against manufacturer's defects. See the Medeco® Limited Warranty for full details.

Finishes:

Available in all standard finishes to match existing hardware.

Applications:

Ideal for a wide variety of commercial and residential applications where consistent quality, ease of use and installation are required.

- Office buildings
- Restaurants
- Hospitals
- Apartments
- Schools
- Retail outlets

Available Technologies:

Mechanical:

- Medeco 4
- Medeco 4 BiLevel
- Medeco³
- Medeco³ BiLevel
- X4

eCylinder:

- M³ CLIQ
- M4 CLIQ
- Classic CLIQ
- X4 CLIQ

How to Order:

<p>1</p> <p>11C601 base part #</p> <p>Refer to pages 155-161, and 165 for descriptions and technical specifications to find the corresponding base part number.</p>	<p>2</p> <p>H technology</p> <p>H = Medeco 4 T = Medeco³ W = Biaxial - = Original J = Medeco³ BiLevel N = X4 K = KM P = M4 BiLevel Q = M4 CLIQ S = M3 CLIQ M = X4 CLIQ C = Classic CLIQ</p>	<p>3</p> <p>05 finish</p> <p>Refer to the inside back cover of this catalog for finish options.</p> <p>Upcharge for split finish.</p>	<p>4</p> <p>M4 keyway</p> <p>Insert keyway if known or contact Customer Service for help.</p>	<p>5</p> <p>P pinning</p> <p>S = Sub-Assembled (Uncombined) N = Sub-assembled, No Side Pins (M4 only) No Slider (M3 only) P = Pinned (Combined) M = Master Keyed R = Master Keyed – blade and side pins (Medeco 4 only)</p>	<p>6</p> <p>624 Side Pin Code (Medeco 4 only)</p> <p>Insert side pin code if known or contact Customer Service for help.</p>
---------------------------------------------------------------------------------------------------------------------------------------------------------------------------------------	---------------------------------------------------------------------------------------------------------------------------------------------------------------------------------------------------------------------------------------------------------------------------------	---------------------------------------------------------------------------------------------------------------------------------------------------------	-----------------------------------------------------------------------------------------------------------------	-------------------------------------------------------------------------------------------------------------------------------------------------------------------------------------------------------------------------------------------------------------------	----------------------------------------------------------------------------------------------------------------------------------------------------

BUILD A MAXUM DEADBOLT BASE PART#

11XXXXX

<p>Maxum Deadbolt</p> <hr/> <p>Cylinder Technology</p> <p>H = Medeco 4 T = Medeco³ W = Biaxial - = Original J = Medeco³ BiLevel N = X4 K = KM P = M4 BiLevel Q = M4 CLIQ S = M3 CLIQ M = X4 CLIQ C = Classic CLIQ</p> <p>Trim</p> <p>C = Commercial R = Residential</p> <p>Cylinder Type</p> <p>2 = Blank Plate 3 = LFIC (6 Pin) 4 = LFIC (Less Core) 5 = Medeco (5 Pin) 6 = Medeco (6 Pin) 7 = SFIC (Less Core) 8 = SFIC (6 Pin) 9 = SFIC (7 Pin)</p>		<p>Bolt Option</p> <p>1 = 2 3/8" Backset, 1 1/8" Front 2 = 2 3/4" Backset, 1 1/8" Front 3 = 2 3/8" Backset, 1" Front 4 = 2 3/4" Backset, 1" Front 5 = 2 3/8" Backset, Round Front 6 = 2 3/4" Backset, Round Front L = Less Bolt Assembly</p> <p>Function</p> <p>0 = Cylinder x Thumbturn 1 = Cylinder x Thumbturn (Classroom) 2 = Cylinder x Cylinder 3 = Cylinder x Cylinder (Captive) 4 = Cylinder x Plate (mounting screws on plate side) 5 = Dummy x Thumbturn 6 = Dummy x Cylinder 7 = Dummy x Plate (mounting screws on plate side) 8 = Plate x Thumbturn (mounting screws on thumbturn side) 9 = Plate x Cylinder (mounting screws on cylinder side) D = Dummy x Dummy P = Plate x Plate</p>
--------------------------------------------------------------------------------------------------------------------------------------------------------------------------------------------------------------------------------------------------------------------------------------------------------------------------------------------------------------------------------------------------------------------------------------------------------------------------------------------------------------------------------------------------------------------------------------	--	---------------------------------------------------------------------------------------------------------------------------------------------------------------------------------------------------------------------------------------------------------------------------------------------------------------------------------------------------------------------------------------------------------------------------------------------------------------------------------------------------------------------------------------------------------------------------------------------------------------------------------------------------------------------------------------------------------------------------------------------------------------------------------------

Single Cylinder Maxum Deadbolt – Commercial Trim

Description	Part Number	M4/M ³	BiLevel	X4	Biax/Orig	KeyMark
Maxum Deadbolt Lock, Blank Plate Outside with Inside Thumbturn, 1 1/8" Faceplate†, with bolt	11C28X	\$216.00				
Single Cylinder Maxum Deadbolt Lock, 1 1/8" Faceplate, with bolt	11C60X (P)	\$258.00	\$214.90		\$271.42	
	11C60X (S)	\$244.00	\$207.40		\$257.42	
Single Cylinder Maxum Deadbolt Lock, Less Bolt	11C60L (P)	\$180.92	\$137.82		\$194.34	
	11C60L (S)	\$166.92	\$130.32		\$180.34	
Single Cylinder Maxum Deadbolt Lock, Classroom Function, 1 1/8" Faceplate, with bolt	11C61X (P)	\$264.00			\$277.75	
	11C61X (S)	\$250.00			\$263.75	
Single Cylinder Maxum Deadbolt Lock, Classroom Function, Less Bolt	11C61L (P)	\$186.92			\$200.67	
	11C61L (S)	\$172.92			\$186.67	
Single Cylinder Maxum Deadbolt Lock, Classroom Function, 1 1/8" Faceplate, with bolt	11C61X (P)	\$264.00			\$277.75	
	11C61X (S)	\$250.00			\$263.75	
Single Cylinder Maxum Deadbolt Lock with Blank Plate Inside, 1 1/8" Faceplate, with bolt	11C64X (P)	\$253.00			\$266.14	
	11C64X (S)	\$239.00			\$252.15	
Single Cylinder Maxum Deadbolt Lock, with Blank Plate Outside, 1 1/8" Faceplate , with bolt	11C69X (P)	\$253.00			\$266.14	
	11C69X (S)	\$239.00			\$252.15	

LFIC Single Cylinder Maxum – Commercial Trim

Description	Part Number	M4/M ³	BiLevel	X4	Biax/Orig	KeyMark
LFIC Single Cylinder Maxum Deadbolt Lock, Less Bolt	11C30L (P)	\$271.92			\$290.35	
	11C30L (S)	\$257.92			\$276.35	
LFIC Single Cylinder Maxum Deadbolt Lock, 1 1/8" Faceplate, with bolt	11C30X (P)	\$349.00			\$367.43	
	11C30X (S)	\$335.00			\$353.43	
LFIC Single Cylinder Maxum Deadbolt Lock Classroom Function, 1 1/8" Faceplate, with bolt	11C31X (P)	\$355.00			\$373.75	
	11C31X (S)	\$341.00			\$359.75	
LFIC Single Cylinder Maxum Deadbolt Lock Classroom Function, Less Bolt	11C31L (P)	\$277.92			\$296.68	
	11C31L (S)	\$263.92			\$282.68	
LFIC Single Cylinder Maxum Deadbolt Lock, Blank Inside, 1 1/8" Faceplate, with bolt	11C34X (P)	\$344.00			\$362.15	
	11C34X (S)	\$330.00			\$348.15	
LFIC Single Cylinder Maxum Deadbolt Lock, Blank Outside, 1 1/8" Faceplate *, with bolt	11C39X (P)	\$344.00			\$362.15	
	11C39X (S)	\$330.00			\$348.15	
LFIC Single Cylinder Maxum Deadbolt Lock, 1 1/8" Faceplate, Less Core, with bolt	11C40X	\$200.00			\$200.00	

SFIC Single Cylinder Maxum – Commercial Trim

Description	Part Number	M4/M ³	BiLevel	X4	Biax/Orig	KeyMark
SFIC Single Cylinder Maxum Deadbolt Lock, 1 1/8" Faceplate, Less Core , with bolt	11C70X			\$199.00		\$199.00
SFIC Single Cylinder Maxum Deadbolt Lock, Classroom Function, 1 1/8" Faceplate, Less Core, with bolt	11C71X			\$197.00		\$197.00
SFIC Single Cylinder Maxum Deadbolt Lock, 1 1/8" Faceplate, 6 Pin SFIC Cylinder, with bolt	11C80X (P)			\$270.00		\$284.08
	11C80X (S)			\$256.00		\$270.08
SFIC Single Cylinder Maxum Deadbolt Lock, Classroom Funct., 1 1/8" Faceplate, 6 Pin SFIC Cyl. with bolt	11C81X (P)			\$276.00		\$290.41
	11C81X (S)			\$262.00		\$276.41

(P) = Pinned (combined)

(S) = Sub-assembled (uncombined)

Surcharges for Master Keying, Custom Coining and Custom Stamping apply, see page 202.
Refer to the XT and CLIQ Intelligent Key sections for format availability and pricing.

SFIC Single Cylinder Maxum – Commercial Trim

Description	Part Number	M4/M ³	BiLevel	X4	Biax/Orig	KeyMark
SFIC Single Cylinder Maxum Deadbolt Lock, Blank Inside, 1 1/8" Faceplate, 6 Pin SFIC Cylinder, with bolt	11C84X (P)			\$265.00		\$278.81
	11C84X (S)			\$251.00		\$264.81
SFIC Single Cylinder Maxum Deadbolt Lock, Blank Outside, 1 1/8" Faceplate, 6 Pin SFIC Cylinder *, with bolt	11C89X (P)			\$265.00		\$278.81
	11C89X (S)			\$251.00		\$264.81
SFIC Single Cylinder Maxum Deadbolt Lock, 1 1/8" Faceplate, 7 Pin SFIC Cylinder, with bolt	11C90X (P)			\$270.00		\$284.08
	11C90X (S)			\$256.00		\$270.08
SFIC Single Cylinder Maxum Deadbolt Lock, Classroom Function, 1 1/8" Faceplate, 7 Pin SFIC Cylinder, with bolt	11C91X (P)			\$276.00		\$290.41
	11C91X (S)			\$262.00		\$276.41
SFIC Single Cylinder Maxum Deadbolt Lock, Blank Inside, 1 1/8" Faceplate, 7 Pin SFIC Cylinder, with bolt	11C94X (P)			\$265.00		\$278.81
	11C94X (S)			\$251.00		\$264.81

Double Cylinder Maxum Deadbolt – Commercial Trim

Description	Part Number	M4/M ³	BiLevel	X4	Biax/Orig	KeyMark
Double Cylinder Maxum Deadbolt Lock, 1 1/8" Faceplate, with bolt	11C621X (P)	\$356.00	\$293.80		\$374.04	
	11C62X (S)	\$328.00	\$278.80		\$346.04	
Double Cylinder Maxum Deadbolt Lock, Less Bolt	11C62L (P)	\$278.92	\$216.72		\$296.96	
	11C62L (S)	\$250.92	\$201.72		\$268.96	

Double Cylinder Captive Thumbturn Maxum – Commercial Trim

Description	Part Number	M4/M ³	BiLevel	X4	Biax/Orig	KeyMark
Captive Double Cylinder Maxum Deadbolt Lock, Less Bolt, 1 3/4" - 2" door	11C63L (P)	\$324.92	\$255.85		\$345.49	
	11C63L (S)	\$296.92	\$240.82		\$317.49	
Captive Double Cylinder Maxum Deadbolt Lock, 1 1/8" Faceplate, 1 3/4" - 2" door, with bolt	11C63X (P)	\$402.00	\$332.90		\$422.57	
	11C63X (S)	\$374.00	\$317.90		\$394.57	
Captive Double Cylinder Maxum Deadbolt Lock, 1 1/8" Faceplate, 2 1/4" - 2 1/2" door, with bolt	11C63XT (P)	\$402.00	\$332.90		\$422.57	
	11C63XT (S)	\$374.00	\$317.90		\$394.57	
Captive Double Cylinder Maxum Deadbolt Lock, Less Bolt, 2 1/4" - 2 1/2" door	11C63LT (P)	\$324.92	\$255.85		\$345.49	
	11C63LT (S)	\$296.92	\$240.82		\$317.49	

LFIC Double Cylinder Maxum – Commercial Trim

Description	Part Number	M4/M ³	BiLevel	X4	Biax/Orig	KeyMark
LFIC Double Cylinder Maxum Deadbolt Lock, 1" Faceplate, with bolt	11C32X (P)	\$540.00			\$568.16	
	11C32X (S)	\$512.00			\$540.16	
LFIC Double Cylinder Maxum Deadbolt Lock, Less Bolt	11C32L (P)	\$462.92			\$491.08	
	11C32L (S)	\$434.92			\$463.08	
LFIC Double Cylinder Maxum Deadbolt Lock, 1 1/8" Faceplate, Less Core, with bolt	11C42X	\$243.00			\$243.00	

SFIC Double Cylinder Maxum – Commercial Trim

Description	Part Number	M4/M ³	BiLevel	X4	Biax/Orig	KeyMark
SFIC Double Cylinder Maxum Deadbolt Lock, 1 1/8" Faceplate, Less Core, with bolt	11C72X	\$231.00			\$231.00	
SFIC Double Cylinder Maxum Deadbolt Lock, 1 1/8" Faceplate, 6 Pin Cylinder, with bolt	11C82X (P)			\$391.00		\$410.96
	11C82X (S)			\$363.00		\$382.96
SFIC Double Cylinder Maxum Deadbolt Lock, 1 1/8" Faceplate, 7 Pin Cylinder, with bolt	11C92X (P)			\$391.00		\$410.96
	11C92X (S)			\$363.00		\$382.96

(P) = Pinned (combined)

(S) = Sub-assembled (uncombined)

Surcharges for Master Keying, Custom Coining and Custom Stamping apply, see page 202.
Refer to the XT and CLIQ Intelligent Key sections for format availability and pricing.

Interchangeable Core Cylinders for Maxum® Deadbolts

Description	Part Number	M4/M ³	BiLevel	X4	Biax/Orig	KeyMark
6 pin LFIC Cylinder	320201 (P)	\$167.00	\$90.89	\$116.05	\$175.42	
	320201 (S)	\$153.00	\$83.39	\$102.05	\$161.42	
6 Pin SFIC Cylinder	33600006 (P)			\$81.90		\$85.63
	33600006 (S)			\$67.90		\$71.63
7 Pin SFIC Cylinder	33700006 (P)			\$81.90		\$85.63
	33700006 (S)			\$67.90		\$71.63

Maxum Deadbolt Cylinder Assemblies

Description	Part Number	M4/M ³	BiLevel	X4	Biax/Orig	KeyMark
5 Pin Outside Cylinder Assembly	110A00 (P)	\$139.00				
	110A00 (S)	\$125.00				
5 Pin Inside Cylinder Assembly	110A01 (P)	\$139.00				
	110A01 (S)	\$125.00				
5 Pin Outside Captive Cylinder Assembly	110A02 (P)	\$147.00				
	110A02 (S)	\$133.00				
5 Pin Inside Captive Cylinder Assembly	110A03 (P)	\$147.00				
	110A03 (S)	\$133.00				
6 Pin Outside Cylinder Assembly	110A04 (P)	\$139.00	\$113.75		\$145.88	
	110A04 (S)	\$125.00	\$106.25		\$131.88	
6 Pin Inside Cylinder Assembly	110A05 (P)	\$139.00	\$113.75		\$145.88	
	110A05 (S)	\$125.00	\$106.25		\$131.88	
6 Pin Outside Captive Cylinder Assembly	110A06 (P)	\$147.00			\$154.31	
	110A06 (S)	\$133.00			\$140.31	
6 Pin Inside Captive Cylinder Assembly	110A07 (P)	\$147.00			\$154.31	
	110A07 (S)	\$133.00			\$140.31	

Cylinder Housing & Plugs for Maxum Deadbolt

Description	Part Number	M4/M ³	BiLevel	X4	Biax/Orig	KeyMark
LFIC Outside Cylinder Housing for Maxum Deadbolt Lock	110A08L	\$108.00				
LFIC Inside Cylinder Housing for Maxum Deadbolt Lock	110A09L	\$134.00				
6 Pin Plug for Maxum D.bolt (except Inside Captive Thumbturn)	1202800	\$56.90				
6 Pin Plug for Maxum Deadbolt Inside Captive Thumbturn	1202900	\$56.90				

Bolt Assemblies for Maxum® Deadbolt

Description	Part Number	M4/M ³	BiLevel	X4	Biax/Orig	KeyMark
2 3/8" Maxum Bolt 1" X 2 1/4" Faceplate	110A1911	\$77.50				
2 3/8" Maxum Bolt 1 1/8" X 2 1/4" Faceplate	110A1912	\$77.50				
2 3/8" Maxum Drive-in Bolt (Available in 26 finish only)	110A1913	\$77.50				
2 3/4" Maxum Bolt 1" X 2 1/4" Faceplate	110A1921	\$77.50				
2 3/4" Maxum Bolt 1 1/8" X 2 1/4" Faceplate	110A1922	\$77.50				
2 3/4" Maxum Drive-in Bolt (Available in 26 finish only)	110A1923	\$77.50				
5 Pack Round Front Assembly For Maxum Drive-In Bolt (Includes: CP-180961-26 and CP-011016-020)	94-0058-MED	\$171.00				
Round Front Assembly For Maxum Drive-In Bolt (Includes: CP-180961-26 and CP-011016-020)	94-0059	\$41.70				

(P) = Pinned (combined)

(S) = Sub-assembled (uncombined)

Surcharges for Master Keying, Custom Coining and Custom Stamping apply, see page 202.
Refer to the XT and CLIQ Intelligent Key sections for format availability and pricing.

Maxum Deadbolt Components

Description	Part Number	Price
6 Pin Length Deadbolt Lock Outside Dummy Cylinder	11-0A16	\$72.20
Residential Blank Inside Plate Assembly for Maxum® Deadbolt Lock	11-0A17	\$47.90
5 Pin Length Deadbolt Lock Outside Dummy Cylinder	11-0A18	\$72.20
Commercial Blank Inside Plate Assembly for Maxum® Deadbolt Lock	11-0A14	\$47.90
Residential Style Thumbturn To Fit On Captive Thumbturn Key (Original/Biaxial)	11-0A20	\$36.70
Residential Style Thumbturn To Fit On Captive Thumbturn Key (Medeco ³)	11-0A21	\$36.70
Commercial Thumbturn and Base Plate Assembly	11-0A12	\$92.30
Commercial Style Thumbturn To Fit On Captive Thumbturn Key (Medeco ³)	11-0018	\$34.40
Commercial Thumbturn & set screw	11-0A22	\$53.30
Residential Thumbturn & set screw	11-0A23	\$53.30
Residential Thumbturn and Base Plate Assembly	11-0A10	\$92.30
Commercial Style Thumbturn To Fit On Captive Thumbturn Key (Original/Biaxial)	11-0092	\$36.70
Thumbturn Trim Plate Package for Maxum Deadbolt Lock	940210	\$9.17
Inside Cylinder Trim Plate Package for Commercial Maxum® I/C Deadbolt Lock (includes CP-021090 & CP-180141)	94-0030	\$8.04
Spacer Rings for 1 3/8" Door for Maxum Deadbolt Lock (Package of 2)	94-0212	\$45.00
Inside Cylinder Trim Plate Package for Maxum Double Cylinder Deadbolt Lock (Includes CP-021090 & CP-180131)	94-0029	\$8.04
#8 x 2" FHWS Strike Box mounting screws	CP-010234-320	\$0.83
#8 x 3/4" comb. Wood/Machine S Bolt & Strike mounting screws	CP-010235-120-XX	\$0.83
Screw Package for 5 and 6 Pin Single Cylinder Maxum Deadbolt Lock	CP-011762	\$20.40
Screw Package for 5 Pin Double Cylinder Maxum Deadbolt Lock	CP-011763	\$20.40
Screw Package for 6 Pin Double Cylinder Maxum Deadbolt Lock	CP-011764	\$20.40
Screw Package for Blank x Thumbturn Maxum Deadbolt Lock	CP-011751	\$20.40
Screw Package for Blank x Cylinder Maxum Deadbolt Lock	CP-011767	\$20.40
Screw Package for Blank x Thumbturn Maxum Deadbolt Lock for 2 1/4" - 2 1/2" thick door	CP-011753	\$10.40
Screw Package for Blank x Cylinder Maxum Deadbolt Lock for 2 1/4" - 2 1/2" thick door	CP-011754	\$10.40
Screw Package for 6 Pin Classroom Function Maxum Deadbolt Lock	CP-011757	\$20.40
Collar for Maxum Residential Style Deadbolt Lock 5 Pin	CP-070691	\$73.10
Collar for Maxum Residential Style Deadbolt Lock 6 Pin	CP-070701	\$73.10

(P) = Pinned (combined)

(S) = Sub-assembled (uncombined)

Surcharges for Master Keying, Custom Coining and Custom Stamping apply, see page 202.
Refer to the XT and CLIQ Intelligent Key sections for format availability and pricing.

Maxum Deadbolt Components

Description	Part Number	Price
Collar for Maxum Commercial Style Deadbolt Lock (Inside & Outside)	CP-070711	\$73.10
Collar for Maxum Residential Style Deadbolt Lock Thick Door Captive Thumbturn 5 Pin	CP-070721	\$73.10
Collar for Maxum Residential Style Deadbolt Lock Thick Door Captive Thumbturn 6 Pin	CP-070731	\$73.10
Collar for Maxum Commercial Style Deadbolt Lock Thick Door Captive Thumbturn	CP-070741	\$73.10
Strike for Maxum Deadbolt Lock	CP-180061	\$18.60
Ball bearings (Allen head of mounting screws) .191" diameter silver	CP-250010	\$0.25
Ball bearings (tip of mounting screws) .202" diameter black	CP-250020	\$0.25
Strike Reinforcement Strike Box for Maxum Deadbolt Lock	CP-280620	\$6.23
Keyblank for Captive Thumbturn Key for Maxum Deadbolt 6 Pin, varies by Key Section (factory will supply correct part number)	KYB XX6605	\$13.11

Maxum® Deadbolt Tailpieces

Description	Part Number	Price
Thumbturn Tailpiece for Maxum Deadbolt lock for 1 3/4" - 2 1/2" thick door	CT-F42	\$8.15
Thumbturn Tailpiece for Classroom Function Maxum Deadbolt lock, 1 3/4" - 2" thick doors	CT-F43	\$8.15
Thumbturn Tailpiece for Classroom Function Maxum Deadbolt lock for doors 2 1/4" - 2 1/2" thick	CT-F44	\$8.15
Tailpiece for Maxum Deadbolt lock, outside cylinder, .532" length, for doors up to 1 3/4" thick	CT-Y60	\$3.05
Tailpiece for Maxum Deadbolt outside cylinder, 1.430" length for doors over 1 3/4" thick	CT-Y61	\$3.05

(P) = Pinned (combined)

(S) = Sub-assembled (uncombined)

Surcharges for Master Keying, Custom Coining and Custom Stamping apply, see page 202.
Refer to the XT and CLIQ Intelligent Key sections for format availability and pricing.

Medeco Maxum[®] Residential Deadbolt

Designed with a residential aesthetic, the ANSI Grade 1 Maxum deadbolt offers superior physical protection from breaking and attack. Maxum is available as a single-cylinder, double-cylinder or with a “captive thumbturn” cylinder. The captive thumbturn converts the inside cylinder to a thumbturn for safe exit when the facility is occupied. A quick conversion when the facility is not occupied returns it to double cylinder mode to guard against unauthorized entry. Medeco 4 Maxum[®] deadbolts are UL 437 listed, offering maximum protection with solid-brass construction, along with anti-drilling, picking and anti-prying features.



Patented Key Control

Patent-pending key control protects against unauthorized duplication of keys (Medeco 4).



Protection Against 3D Printing

A patent-pending movable element in the key deters unauthorized 3D printed copies of keys or blanks.



Picking and Bumping Protection

M4 cylinders use cylinder side pins, a shuttle lift pin and a movable key element to engage a sidebar that prevents the key from turning until the elements are rotated and aligned in the correct position, protecting against bumping, picking and other attacks.



Certified Grade 1

BHMA certified Grade 1, passes to the highest standards in the industry.



Drill Protection

Offers maximum protection with solid-brass construction and strategically placed drill pins.



Protection From Physical Attack

Medeco 4 Maxum Deadbolts are UL 437 Listed and stand up to prying, picking and other forms of physical attack.



Special Angle Cut Keys

Requires a special key cutting machine and access to Medeco specific blanks, available in a variety of restrictions to support every need.



Master Keying Capabilities

M4 cylinders can be master keyed into a system that includes M4, BiLevel*, and M4 CLIQ** keys and cylinders. Extremely large systems are possible.

Technical Information:

- ANSI/BHMA A156.30 and UL 437 listed cylinders for high security (Medeco 4)
- Fits doors 1 3/8” to 2 1/2” thick
- Standard 2 1/8” crossbore and 1” edge bore (ANSI A115.13 prep)

Warranty:

Warranted for two (2) years against manufacturer's defects. See the Medeco[®] Limited Warranty for full details.

Finishes:

Available in all standard finishes to match existing hardware.

Applications:

Ideal for a wide variety of commercial and heavy duty residential applications where consistent quality, ease of use and installation are required.

- Apartments
- Residences
- Retail outlets
- Multi-family Units

Available Key Technologies:

Mechanical:

- Medeco 4
- Medeco 4 BiLevel
- Medeco³
- Medeco³ BiLevel
- X4

eCylinder:

- M³ CLIQ
- M4 CLIQ
- Classic CLIQ

Single Cylinder Maxum Deadbolt – Residential Trim

Description	Part Number	M4/M ³	BiLevel	X4	Biax/Orig	KeyMark
5 Pin Single Cylinder Deadbolt, 1" Faceplate, 2-3/8" Backset	11R503 (P)	\$258.00	\$214.90		\$271.42	
	11R503 (S)	\$244.00	\$207.40		\$257.42	
5 Pin Single Cylinder Deadbolt, 1" Faceplate, 2-3/4" Backset	11R504 (P)	\$258.00	\$214.90		\$271.42	
	11R504 (S)	\$244.00	\$207.40		\$257.42	
6 Pin Single Cylinder Deadbolt, 1" Faceplate, 2-3/8" Backset	11R603 (P)	\$258.00	\$214.90		\$271.42	
	11R603 (S)	\$244.00	\$207.40		\$257.42	
6 Pin Single Cylinder Deadbolt, 1" Faceplate, 2-3/4" Backset	11R604 (P)	\$258.00	\$214.90		\$271.42	
	11R604 (S)	\$244.00	\$207.40		\$257.42	
Single Dummy Trim Deadbolt (5 Pin Length)	11R57L	\$194.92			\$194.92	
Single Dummy Trim Deadbolt (6 Pin Length)	11R67L	\$194.92			\$194.92	

Double Cylinder Maxum Deadbolt – Residential Trim

Description	Part Number	M4/M ³	BiLevel	X4	Biax/Orig	KeyMark
5 Pin Double Cylinder Deadbolt 1" Faceplate, 2 3/8" Backset	11R523 (P)	\$356.00	\$293.80		\$374.04	
	11R523 (S)	\$328.00	\$278.80		\$346.04	
5 Pin Double Cylinder Deadbolt 1" Faceplate, 2 3/4" Backset	11R524 (P)	\$356.00	\$293.80		\$374.04	
	11R524 (S)	\$328.00	\$278.80		\$346.04	
6 Pin Double Cylinder Deadbolt, 1" Faceplate, 2 3/8" Backset	11R623 (P)	\$356.00	\$293.80		\$374.04	
	11R623 (S)	\$328.00	\$278.80		\$346.04	
6 Pin Double Cylinder Deadbolt, 1" Faceplate, 2 3/4" Backset	11R624 (P)	\$356.00	\$293.80		\$374.04	
	11R624 (S)	\$328.00	\$278.80		\$346.04	
Double Dummy Trim Deadbolt (5 Pin Length)	11R5DL	\$260.92			\$260.92	
Double Dummy Trim Deadbolt (6 Pin Length)	11R6DL	\$260.92			\$260.92	

Double Cyl. Captive Thumbturn Maxum – Residential Trim

Description	Part Number	M4/M ³	BiLevel	X4	Biax/Orig	KeyMark
5 Pin Captive Thumbturn Double Cylinder Deadbolt, 2 3/8" Backset	11R533 (P)	\$402.00	\$332.90		\$422.57	
	11R533 (S)	\$374.00	\$317.90		\$394.57	
5 Pin Captive Thumbturn Double Cylinder Deadbolt, 2 3/4" Backset	11R534 (P)	\$402.00	\$332.90		\$422.57	
	11R534 (S)	\$374.00	\$317.90		\$394.57	
6 Pin Captive Thumbturn Double Cylinder Deadbolt, 1" Faceplate, 2 3/8" Backset	11R633 (P)	\$402.00	\$332.90		\$422.57	
	11R633 (S)	\$374.00	\$317.90		\$394.57	
6 Pin Captive Thumbturn Double Cylinder Deadbolt, 1" Faceplate, 2 3/4" Backset	11R634 (P)	\$402.00	\$332.90		\$422.57	
	11R634 (S)	\$374.00	\$317.90		\$394.57	

Cylinder Plugs for Maxum – Residential Deadbolts

Description	Part Number	M4/M ³	BiLevel	X4	Biax/Orig	KeyMark
6 pin plug for Maxum Residential Deadbolt (except inside captive thumbturn)	1202800	\$56.90				
6 pin plug for Maxum Residential Deadbolt inside captive thumbturn	1202900	\$56.90				
5 pin plug for Maxum Residential Deadbolt (except inside captive thumbturn)	1236200	\$60.03				
5 pin plug for Maxum Residential Deadbolt inside captive thumbturn	1243400	\$56.90				

(P) = Pinned (combined)

(S) = Sub-assembled (uncombined)

Surcharges for Master Keying, Custom Coining and Custom Stamping apply, see page 202.
Refer to the XT and CLIQ Intelligent Key sections for format availability and pricing.

Padlocks

FEATURES	Medeco ³	BiLevel	Medeco X4	CLIQ	Medeco XT	Nexgen
All Weather Padlock						
AWP accepts 6 pin knob style cylinders	●	●	●	●	●	
AWP is available as key retaining only	●	●	●	●	●	
Protector II						
Protector II body accepts 6 pin knob style cylinders	●		●	●	●	
Protector II is available as key retaining only	●		●	●	●	
System Series						
System Series body accepts knob style cylinders	●	●	●	●	●	
System Series body accepts large format interchangeable cylinders	●	●		●		
System Series body accepts 6 or 7 pin small format interchangeable cores			●		●	
Non-key retaining and key retaining models available	●	●	●	●	●	
Hockey Puck						
Hockey Puck body accepts knob style 5 pin cylinder	●	●				
Hockey Puck body accepts knob style 6 pin cylinder			●			
Hockey Puck is available as non- key retaining only	●	●	●		●	
G8R						
G8R body accepts a pop-out cylinder	●			●	●	●
Sold less cylinder	●			●	●	●
All Padlocks						
UL437 Listing & BHMA Certification for high security	●					
Easily integrated into master key systems for key security and convenience	●	●	●			
Patented key control to protect against unauthorized duplication	●	●	●			

Medeco³ Premium High Security

For effective mechanical protection against most forms of attack as well as protection against unauthorized duplicate keys, Medeco³ cylinders are recommended. Security features including hardened steel components, pins that must be elevated, rotated, and interact with both a sidebar and a slider, and additional pick resistant features make Medeco³ the cylinder of choice to protect people, property and information.

Medeco X4 Patented Key Control

Medeco X4 cylinders offer patented control against unauthorized duplication of keys without the additional security features protecting against force or surreptitious attack.

Medeco³ BiLevel Patented Key Control

Medeco³ BiLevel cylinders may be incorporated into a master key system with Medeco³ high security, offering protection against all types of attack where needed, and patented key control cylinders for areas requiring less protection. BiLevel cylinders offer patented control against unauthorized duplication of keys without the additional security features protecting against force or surreptitious attack.

Intelligent Key Solutions

Many of the cylinders in this section are also available with an Intelligent Key solution. See the Intelligent Key section for more details.

How to Order AWP Series Padlocks:

Complete part numbers are required for all orders. To determine the correct part number, fill in the "X's" in sequential order.

1 **5005511 base part #**

Refer to pages 165-166 for descriptions and technical specifications to find the corresponding base part number.

2

H
cylinder

H = Medeco 4
 T = Medeco³
 W = Biaxial
 J = Medeco³ BiLevel
 N = Medeco X4
 S = Medeco³ CLIQ
 M = X4 CLIQ
 P = M4 BiLevel
 Q = M4 CLIQ
 G = Medeco X

3

26
finish

26 Finish Only.

4

M4
keyway

Insert keyway if known or contact Customer Service for help.

5

P
pinning

S = Sub-Assembled (Uncombined)
 N = Sub-assembled,
 - No side pins (M4 only)
 - No slider (M3 only)
 P = Pinned (Combined)
 M = Master Keyed
 R = Master Keyed
 - blade and side pins (Medeco 4 only)

6

624
side pin code

(Medeco 4 only)

Insert side pin code if known or contact Customer Service for help.

BUILD A AWP SERIES PADLOCK BASE PART

50 X 05XXX

Prefix

Shackle (Diameter),
Material, Clearance

511 = 5/16", SS, 1 7/8"
 521 = 5/16", SS, 2 3/8"
 531 = 5/16", Boron, 1 7/8"
 541 = 5/16", Boron, 2 3/8"
 711 = 7/16", SS, 2"
 721 = 7/16", SS, 2 1/2"
 731 = 7/16", Boron, 2"
 741 = 7/16", Boron, 2 1/2"

*AWP with mechanical cylinder requires the use of extended shoulder key blanks.
 Medeco³ use KY3366XX or KY3466XX.
 Original/Biaxial use KY1866XX or KY2266XX.

All Weather Padlocks

The Medeco All Weather Padlock (AWP Series) offers the highest level of padlock weather and severe service protection available from Medeco. The body is solid 303 stainless steel and is available with either stainless steel or boron shackles. A weatherproof cylinder seal cap, attached by a stainless steel cable, seals both mechanical and eCylinders from harsh environments. Multiple mechanical and intelligent key technologies are available.

The AWP is not only weatherproof, it is also a high security padlock. Mechanical cylinders provide the benefit of patented key control and resistance to surreptitious attacks while both the Medeco CLIQ and Medeco XT cylinders add sophisticated audit and control features.



Patented Key Control

Protects against unauthorized duplication of keys.



Special Angled Key Cuts (HS Cylinder Models)

Requires a special key cutting machine and access to Medeco specific blanks, available in a variety of restrictions to support every need.



Can Be Master Keyed

Medeco can be master keyed into a system containing Medeco³ or Medeco X4 mechanical as well as M³ CLIQ or XT eCylinders.



Protection From Shackle Attack

Hardened boron alloy steel shackles (5/16" and 7/16" diameters) provide strong resistance against cutting, sawing and prying. Available in both 1 7/8" and 2 3/8" or 1" and 2 1/2" lengths.



Protection From Physical Attack

Medeco³ cylinders are UL 437 listed and resist drilling, forcing and other forms of physical attack.



Picking and Bumping Protection

Medeco³ cylinders use a sidebar that prevents the key from rotating until the tumbler pins are elevated, rotated and aligned in the correct position. This feature protects against bumping and picking attacks.

Benefits:

- 300 Series, solid, machined stainless steel body resists attack and corrosion
- 5/16" and 7/16" diameter, stainless steel and boron shackles
- 1 7/8", 2 3/8", 2", and 2 1/2" shackle lengths
- Padlocks are shipped with a weather proof cylinder seal cap attached by a stainless steel cable
- IP68 Environmental protection rating for harsh environments
- ASTM F883-13 rating for tensile pull, shock, plug pull, plug torque, cutting, and corrosion (salt fog)
- Vibration tested per MIL-STD-202G, method 201A
- Key retaining cylinder design
- O-ring sealed cap, cylinder, and shackles resist grime and water penetration at low temperatures

Applications:

The AWP series is designed for installations requiring service in harsh weather conditions. Applications include outdoor perimeter fencing, gates, tool cabinets, storage, and transportation cargo containers. Ideal for Intelligent Key cylinders in outdoor harsh environments.

Warranty:

Warranted for two (2) years against manufacturer's defects. See the Medeco limited warranty for full details.

Finishes:

The padlock comes in a standard industrial stainless steel finish and the cylinders are furnished in the satin brass finish.

Available Key Technologies:

Mechanical:

- Medeco 4
 - Medeco BiLevel
 - Medeco³
 - Medeco Biaxial*
 - Medeco X4
- * Medeco Biaxial requires extended throat key blank

eCylinder:

- Medeco XT
- Medeco M³ CLIQ
- Medeco X4 CLIQ

All Weather Padlock with 5/16" Shackle*

Description	Part Number	M4/M ³	BiLevel	X4	Biax/Orig
AWP 5/16" diameter SS shackle, 1-7/8" clearance	5005511 (P)	\$258.00		\$243.11	
	5005511 (S)	\$244.00		\$229.11	
AWP 5/16" diameter SS shackle, 2-3/8" clearance	5005521 (P)	\$263.00		\$248.11	
	5005521 (S)	\$249.00		\$234.11	
AWP 5/16" diameter Boron shackle, 1-7/8" clearance	5005531 (P)	\$258.00		\$243.11	
	5005531 (S)	\$244.00		\$229.11	
AWP 5/16" diameter Boron shackle, 2-3/8" clearance	5005541 (P)	\$263.00		\$248.11	
	5005541 (S)	\$249.00		\$234.11	

All Weather Padlock with 7/16" Shackle*

Description	Part Number	M4/M ³	BiLevel	X4	Biax/Orig
AWP 7/16" diameter SS shackle, 2" clearance	5005711 (P)	\$258.00		\$243.11	
	5005711 (S)	\$244.00		\$229.11	
AWP 7/16" diameter SS shackle, 2 1/2" clearance	5005721 (P)	\$263.00		\$248.11	
	5005721 (S)	\$249.00		\$234.11	
AWP 7/16" diameter Boron shackle, 2 " clearance	5005731 (P)	\$258.00		\$243.11	
	5005731 (S)	\$244.00		\$229.11	
AWP 7/16" diameter Boron shackle, 2 1/2" clearance	5005741 (P)	\$263.00		\$248.11	
	5005741 (S)	\$249.00		\$234.11	

*AWP with mechanical cylinder requires the use of extended shoulder key blanks.

Medeco³ use KY3366XX or KY3466XX.
Original/Biaxial use KY1866XX or KY2266XX.

All Weather Padlock - No Cylinder

Description	Part Number	Price
AWP 5/16" dia SS shackle, Less Cyl, 1 7/8" clearance	50-0551L	\$192.00
AWP 5/16" dia SS shackle, Less Cyl, 2 3/8" clearance	50-0552L	\$198.00
AWP 5/16" dia Boron shackle, Less Cyl, 1 7/8" clearance	50-0553L	\$192.00
AWP 5/16" dia Boron shackle, Less Cyl, 2 3/8" clearance	50-0554L	\$198.00
AWP 7/16" dia SS shackle, Less Cyl, 2" clearance	50-0571L	\$192.00
AWP 7/16" dia SS shackle, Less Cyl, 2 1/2" clearance	50-0572L	\$198.00
AWP 7/16" dia Boron shackle, Less Cyl, 2" clearance	50-0573L	\$192.00
AWP 7/16" dia Boron shackle, Less Cyl, 2 1/2" clearance	50-0574L	\$198.00

All Weather Padlock Cylinders

Description	Part Number	M4/M ³	BiLevel	X4	Biax/Orig
6 Pin Cylinder, KIK type for AWP Series Padlock (26 finish only)	510800 (P)	\$67.30			
	510800 (S)	\$53.30			

Components for All Weather Padlocks

Description	Part Number	Price
Thumbturn Cap Replacement Kit	94-0316	\$27.50
5/16" AWP O-ring Seal Kit	94-0317-516	\$5.49
7/16" AWP O-ring Seal Kit	94-0317-716	\$5.49
Wire Assembly Spacer	CP-160910	\$1.10
Wire Assembly	CP-287720	\$5.49
Seal Installation Tool	94-0318	\$110.00
Wire Assembly Screw	CP-014213-061	\$1.10
Set Screw	CP-014642-591	\$1.10
Shackle Locking Balls	CP-250180	\$2.20
Allen Wrench 2.5 mm	CP-287770	\$2.20

Shackles for All Weather Padlocks

Description	Boron Alloy Steel		Stainless Steel	
	Part Number	Price	Part Number	Price
Standard Shackle for AWP Padlock, 1-7/8" Shackle Clearance x 5/16" Diameter	CP-144270	\$11.40	CP-144230	\$17.10
Extra Length Shackle for AWP Padlock, 2-3/8" Shackle Clearance x 5/16" Diameter	CP-144280	\$13.80	CP-144240	\$19.20
Standard Shackle for AWP Padlock, 2" Shackle Clearance x 7/16" Diameter	CP-144290	\$13.80	CP-144250	\$19.20
Extra Length Shackle for AWP Padlock, 2-1/2" Shackle Clearance x 7/16" Diameter	CP-144300	\$15.20	CP-144260	\$21.00

How to Order The Protector II Padlock:

<p>1</p> <p>50047320 base part #</p> <p>Refer to page 169 for descriptions and technical specifications to find the corresponding base part number.</p>	<p>2</p> <p>T cylinder</p> <ul style="list-style-type: none"> - = Original T = Medeco³ W = Biaxial S = M³ CLIQ G = Medeco XT N = Medeco X4 	<p>3</p> <p>LT keyway</p> <p>Insert keyway if known or contact Customer Service for help.</p>	<p>4</p> <p>S pinning</p> <table border="1" style="width: 100%; border-collapse: collapse;"> <tr> <td style="width: 33%; vertical-align: top;"> <p>S = Sub-Assembled (Uncombined) No additional information needed</p> </td> <td style="width: 33%; vertical-align: top;"> <p>P = Pinned (Combined) Keyed alike (KA) Keyed different (KD) 2 keys per cylinder</p> </td> <td style="width: 33%; vertical-align: top;"> <p>M = Master Keyed Provide specific pinning or contact Customer Service for support Must specify quantity for keys.</p> </td> </tr> </table>	<p>S = Sub-Assembled (Uncombined) No additional information needed</p>	<p>P = Pinned (Combined) Keyed alike (KA) Keyed different (KD) 2 keys per cylinder</p>	<p>M = Master Keyed Provide specific pinning or contact Customer Service for support Must specify quantity for keys.</p>
<p>S = Sub-Assembled (Uncombined) No additional information needed</p>	<p>P = Pinned (Combined) Keyed alike (KA) Keyed different (KD) 2 keys per cylinder</p>	<p>M = Master Keyed Provide specific pinning or contact Customer Service for support Must specify quantity for keys.</p>				

BUILD A PROTECTOR II PADLOCK BASE PART

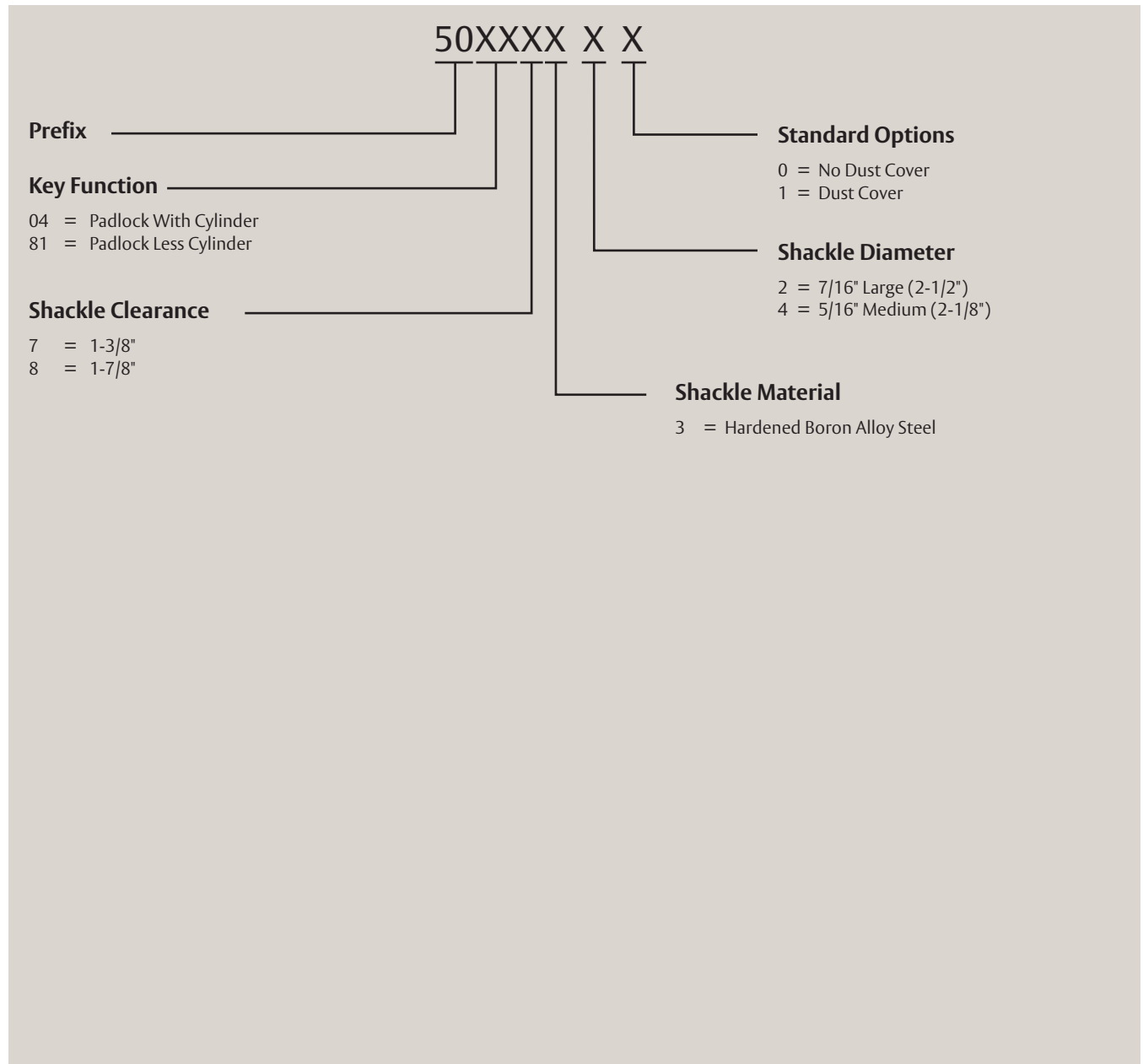

Protector II Series Padlocks

The Protector II Series padlock is made of durable, industrial grade stainless steel and offers excellent resistance to severe service conditions.

The hardened boron alloy steel shackles stand up to physical attack, providing strong resistance against cutting, sawing and prying. The patented Medeco³ mechanical cylinder resists picking, drilling and other sophisticated forms of physical attack. Also available in eCylinder formats for Loss and Liability Control.



Patented Key Control

Protects against unauthorized duplication of keys.



Special Angled Key Cuts

Requires a special key cutting machine and access to Medeco specific blanks, available in a variety of restrictions to support every need.



Can Be Master Keyed

Medeco Protector II Padlocks can be master keyed into a system containing Medeco³ mechanical as well as M³ CLIQ or XT eCylinders.



Protection From Shackle Attack

Hardened boron alloy steel shackles (5/16" and 7/16" diameters) provide strong resistance against cutting, sawing and prying. Available in both 1 3/8" and 1 7/8" lengths.



Proprietary Deadlocking Shackle

Unique deadlocking shackle locking mechanism for resistance to physical attack.



Protection From Physical Attack

Medeco³ cylinders are UL 437 listed and resists drilling, picking and other forms of physical attack.



Picking and Bumping Protection

Medeco³ cylinders use a sidebar that prevents the key from rotating until the tumbler pins are elevated, rotated and aligned in the correct position. This feature protects against bumping and picking attacks.

Benefits:

- Hardened stainless steel inserts inside the cylinder provide the ultimate defense against drilling and other forms of physical attack.
- Unique elevating and rotating tumbler pin system is virtually pick proof.
- All Medeco[®] cylinders are constructed of durable machined brass components, designed to last the life of your equipment.
- Patented Medeco³ keys may only be duplicated by Medeco or an authorized Medeco service outlet, and only at your request.
- Boron alloy steel shackle which protects against cutting and pulling attacks.
- Locks can be keyed alike, keyed different, or master keyed depending on your specific needs.

Applications:

The Medeco Protector II padlocks can be used in a variety of different indoor or outdoor applications where high security and key control are a primary concern.

Technical Features:

- Uses key retaining operation.
- Uses a dedicated 6 pin KIK/KIL cylinder that can be pinned to 5.

Warranty:

Warranted for two (2) years against manufacturer's defects. See the Medeco limited warranty for full details.

Finishes:

The padlock comes in a standard industrial stainless steel finish and the cylinders are furnished in the satin brass finish.

Available Key Technologies:

Mechanical:	eCylinder:
– Medeco ³	– M ³ CLIQ
– Medeco X4	– Medeco XT

Protector II Series Padlocks

Description	Part Number	M ³	BiLevel	X4	Biax/Orig	KeyMark
Large Body - 7/16" dia shackle, Less Cyl, 1 3/8" clearance	50-81732	\$175.22				
Large Body - 7/16" dia shackle, Less Cyl, 1 3/8" clearance, Dust cover	50-817321	\$193.01				
Large Body - 7/16" dia shackle, Less Cyl, 1 7/8" clearance	50-81832	\$181.22				
Large Body - 7/16" dia shackle, Less Cyl, 1 7/8" clearance, Dust cover	50-818321	\$199.01				
Med Body - 5/16" dia shackle, Less Cyl, 1 3/8" clearance	50-81734	\$147.00				
Med Body - 5/16" dia shackle, Less Cyl, 1 3/8" clearance, Dust cover	50-817341	\$164.79				
Med Body - 5/16" dia shackle, Less Cyl, 1 7/8" clearance	50-81834	\$153.00				
Med Body - 5/16" dia shackle, Less Cyl, 1 7/8" clearance, Dust cover	50-818341	\$170.79				
Large Body - 7/16" dia shackle, 1 3/8" clearance	5004732 (P)	\$275.22			\$288.04	
	5004732 (S)	\$261.22			\$274.04	
Large Body - 7/16" dia shackle, 1 3/8" clearance, Dust cover	50047321 (P)	\$293.01			\$305.82	
	50047321 (S)	\$279.01			\$291.82	
Large Body - 7/16" dia shackle, 1 7/8" clearance	5004832 (P)	\$279.22			\$292.25	
	5004832 (S)	\$265.22			\$278.25	
Large Body - 7/16" dia shackle, 1 7/8" clearance, Dust cover	50048321 (P)	\$297.01			\$310.05	
	50048321 (S)	\$283.01			\$296.05	
Med Body - 5/16" dia shackle, 1 3/8" clearance	5004734 (P)	\$247.00			\$259.81	
	5004734 (S)	\$233.00			\$245.81	
Med Body - 5/16" dia shackle, 1 3/8" clearance, Dust cover	50047341 (P)	\$264.79			\$277.61	
	50047341 (S)	\$250.79			\$263.61	
Med Body - 5/16" dia shackle, 1 7/8" clearance	5004834 (P)	\$251.00			\$264.04	
	5004834 (S)	\$237.00			\$250.03	
Med Body - 5/16" dia shackle, 1 7/8" clearance, Dust cover	50048341 (P)	\$268.79			\$281.82	
	50048341 (S)	\$254.79			\$267.82	

Protector II Series Padlock Cylinder

Description	Part Number	M ³	BiLevel	X4	Biax/Orig	KeyMark
KIK style cylinder for Protector II	500020 (P)	\$103.00			\$107.89	
	500020 (S)	\$89.00			\$93.89	

Protector II Series Padlock Parts

Description	Part Number	Price
Disk For Standard Key In Knob Cylinder	CP-171011	\$16.60
Disk For CLIQ Cylinder	CP-171021	\$16.60
Disk For Medeco XT Cylinder	CP-171031	\$16.60

How to Order System Series Padlocks:

Complete part numbers are required for all orders. To determine the correct part number, fill in the "X's" in sequential order.

1

5451500 base part

Refer to pages 172-177 for descriptions and technical specifications to find the corresponding base part number.

2

H cylinder

H = Medeco 4
 T = Medeco³
 W = Biaxial
 J = Medeco³ BiLevel
 N = Medeco X4
 S = Medeco³
 CLIQ
 M = X4 CLIQ
 P = M4 BiLevel
 Q = M4 CLIQ
 G = Medeco X

3

06 finish

Insert 06 for
 Satin Brass finish.

4

M4 keyway

Insert keyway if known
 or contact Customer
 Service for help.

5

P pinning

S = Sub-Assembled
 (Uncombined)
 N = Sub-assembled,
 – No side pins
 (M4 only)
 – No slider
 (M3 only)
 P = Pinned
 (Combined)
 M = Master Keyed
 R = Master Keyed
 – blade and side pins
 (Medeco 4 only)

6

624 side pin code

(Medeco 4 only)
 Insert side pin code
 if known or contact
 Customer Service
 for help.

BUILD A SYSTEM SERIES PADLOCK BASE PART

54XXXX X X

Prefix

Shackle (Diameter), Feature, Clearance

315 = 5/16" Diameter, Weather, 1 1/8" SFIC
 31F = 5/16" Diameter, Weather, 2 3/8" SFIC
 325 = 5/16" Diameter, Shrouded, 3/4" SFIC
 335 = 5/16" Diameter, Weather, 1 1/8" SFIC 7 Pin
 33F = 5/16" Diameter, Weather, 2 3/8" SFIC 7 Pin
 345 = 5/16" Diameter, Shrouded, 3/4" SFIC 7 Pin
 415 = 7/16" Diameter, Weather, 1 3/8" SFIC
 41F = 7/16" Diameter, Weather, 1 7/8" SFIC
 425 = 7/16" Diameter, Shrouded, 3/4" SFIC
 435 = 7/16" Diameter, Weather, 1 3/8" SFIC 7 Pin
 43F = 7/16" Diameter, Weather, 1 7/8" SFIC 7 Pin
 445 = 7/16" Diameter, Shrouded, 3/4" SFIC 7 Pin
 515 = 5/16" Diameter, Weather, 1 1/8" KIK
 51F = 5/16" Diameter, Weather, 2 3/8" KIK
 525 = 5/16" Diameter, Shrouded, 3/4" KIK
 615 = 5/16" Diameter, Weather, 1 1/8" LFIC
 61F = 5/16" Diameter, Weather, 2 3/8" LFIC
 625 = 5/16" Diameter, Shrouded, 3/4" LFIC
 715 = 7/16" Diameter, Weather, 1 3/8" KIK
 71F = 7/16" Diameter, Weather, 1 7/8" KIK
 725 = 7/16" Diameter, Shrouded, 3/4" KIK
 815 = 7/16" Diameter, Weather, 1 3/8" LFIC
 81F = 7/16" Diameter, Weather, 1 7/8" LFIC
 825 = 7/16" Diameter, Shrouded, 3/4" LFIC

Standard Options

Blank = None
 T = Thick Head (SFIC Only)

Shackle Material

0 = Boron Alloy Steel
 1 = Stainless Steel

Key Function

0 = Non-Key Retaining
 K = Less Cylinder (Key Retaining)
 L = Less Cylinder (Non-Key Retaining)
 R = Key Retaining

System Series Padlocks

The Medeco® System Series padlock offers a high security solution for a multitude of applications and is available in two distinctive body styles, an indoor/outdoor weather resistant design or with a shrouded shackle. Both models utilize a boron alloy steel shackle which provides protection against cutting and increased tensile strength to resist pulling attacks. The boron alloy steel also ensures that the shackle has an exceptional degree of ductility and is not brittle. The cylinder itself uses hardened, stainless steel inserts to provide the ultimate defense against drilling, pulling and other forms of vandal attack. The Medeco³ unique design provides triple locking action, making the locks virtually pick proof. All Medeco³ keys and locks are protected under patent, trademark, and copyright laws. Medeco³ keys may only be duplicated by Medeco® or by a Medeco® authorized sales outlet, and only at your request.



Patented Key Control

Protects against unauthorized duplication of your keys.



Protection From Physical Attack

Medeco³ padlock cylinders are UL 437 listed and stand up to drilling, picking and other forms of physical attack.



Proprietary Deadlocking Shackle

Boron alloy steel shackles protect against cutting and pulling attacks.



Can Be Master Keyed

Medeco System Series Padlocks can be master keyed into a system containing Medeco BiLevel and Medeco³ mechanical as well as Medeco³ CLIQ eCylinders.



Available in eCylinder

System Series Padlocks are also available with Medeco eCylinders for Loss & Liability control.



Special Angle Cut Keys

Requires a special key cutting machine and access to Medeco specific blanks, available in a variety of restrictions to support every need.



Picking and Bumping Protection

Medeco³ cylinders use a sidebar that prevent the key from rotating until it is elevated, rotated and aligned in the correct position. This feature protects against bumping and picking attacks.

Technical Features:

- Available with either a 5/16 inch or a 7/16 inch shackle diameter.
- Available in Indoor/Outdoor weather resistant design or with a shrouded shackle.
- Extended shackles available for Indoor/Outdoor padlocks only.
- The shrouded shackle design provides extra shackle protection against cutting attacks.
- All Medeco® cylinders are constructed of durable machined brass components, designed to last the life of your equipment.
- Boron alloy steel shackle which protects against cutting and pulling attacks.
- Available in a variety of different shackle lengths.

Applications:

Used in a variety of different indoor or outdoor applications where high security and key control are a primary concern.

Warranty:

Warranted for two (2) years against manufacturer's defects. See the Medeco® limited warranty for full details.

Finishes:

The padlock comes in a standard black body cover and the cylinders are furnished in satin brass finish.

Available Key Technologies:

Mechanical:

- Medeco 4
- Medeco³
- Medeco³ BiLevel
- Medeco X4

eCylinder:

- M³ CLIQ
- Classic CLIQ
- Medeco XT
- Medeco X4 CLIQ

Indoor/Outdoor Padlock, 5/16" Shackle -KIK

Description	Part Number	M4/M ³	BiLevel	X4	Biax/Orig	KeyMark
Indoor/Outdoor Padlock, Non-Key Retaining, 1 1/8" Shackle Clearance, With Cylinder	5451500 (P)	\$190.00	\$132.33	\$173.42	\$199.68	\$182.77
	5451500 (S)	\$176.00	\$124.83	\$159.42	\$185.68	\$168.77
Indoor/Outdoor Padlock, Key Retaining, 1 1/8" Shackle Clearance, With Cylinder	54515R0 (P)	\$190.00	\$132.33	\$173.42	\$199.68	\$182.77
	54515R0 (S)	\$176.00	\$124.83	\$159.42	\$185.68	\$168.77
Indoor/Outdoor Padlock, Non-Key Retaining, 2 3/8" Shackle Clearance, With Cylinder	5451F00 (P)	\$193.00	\$135.33	\$176.42	\$202.84	\$185.94
	5451F00 (S)	\$179.00	\$127.83	\$162.42	\$188.84	\$171.94
Indoor/Outdoor Padlock, Key Retaining, 2 3/8" Shackle Clearance, With Cylinder	5451FR0 (P)	\$193.00	\$135.33	\$176.42	\$202.84	\$185.94
	5451FR0 (S)	\$179.00	\$127.83	\$162.42	\$188.84	\$171.94
Indoor/Outdoor Padlock, Key Retaining, 1 1/8" Shackle Clearance, Less Cylinder	54515K0	\$64.00				
Indoor/Outdoor Padlock, Non-Key Retaining, 1 1/8" Shackle Clearance, Less Cylinder	54515L0	\$64.00				
Indoor/Outdoor Padlock, Key Retaining, 2 3/8" Shackle Clearance, Less Cylinder	5451FK0	\$67.00				
Indoor/Outdoor Padlock, Non-Key Retaining, 2 3/8" Shackle Clearance, Less Cylinder	5451FL0	\$67.00				

Indoor/Outdoor Padlock, 5/16" Shackle -6 Pin LFIC

Description	Part Number	M4/M ³	BiLevel	X4	Biax/Orig	KeyMark
Indoor/Outdoor Padlock, Non-Key Retaining, 1 1/8" Shackle Clearance, With Cylinder	5461500 (P)	\$259.00	\$176.03		\$272.48	
	5461500 (S)	\$245.00	\$168.53		\$258.48	
Indoor/Outdoor Padlock, Key Retaining, 1 1/8" Shackle Clearance, With Cylinder	54615R0 (P)	\$259.00	\$176.03		\$272.48	
	54615R0 (S)	\$245.00	\$168.53		\$258.48	
Indoor/Outdoor Padlock, Non-Key Retaining, 2 3/8" Shackle Clearance, With Cylinder	5461F00 (P)	\$267.00	\$184.03		\$280.92	
	5461F00 (S)	\$253.00	\$176.53		\$266.92	
Indoor/Outdoor Padlock, Key Retaining, 2 3/8" Shackle Clearance, With Cylinder	5461FR0 (P)	\$267.00	\$184.03		\$280.92	
	5461FR0 (S)	\$253.00	\$176.53		\$266.92	
Indoor/Outdoor Padlock, Key Retaining, 1 1/8" Shackle Clearance, Less Cylinder	54615K0	\$66.00				
Indoor/Outdoor Padlock, Non-Key Retaining, 1 1/8" Shackle Clearance, Less Cylinder	54615L0	\$66.00				
Indoor/Outdoor Padlock, Key Retaining, 2 3/8" Shackle Clearance, Less Cylinder	5461FK0	\$74.00				
Indoor/Outdoor Padlock, Non-Key Retaining, 2 3/8" Shackle Clearance, Less Cylinder	5461FL0	\$74.00				

(P) = Pinned (combined)

(S) = Sub-assembled (uncombined)

Surcharges for Master Keying, Custom Coining and Custom Stamping apply, see page 202.

Refer to the XT and CLIQ Intelligent Key sections for format availability and pricing.

Indoor/Outdoor Padlock, 5/16" Shackle -6 Pin SFIC

Description	Part Number	M4/M ³	BiLevel	X4	Biax/Orig	KeyMark
Indoor/Outdoor Padlock, Non-Key Retaining, 1 1/8" Shackle Clearance, With Cylinder	5431500 (P)			\$162.42		\$171.16
	5431500 (S)			\$148.42		\$157.16
Indoor/Outdoor Padlock, Key Retaining, 1 1/8" Shackle Clearance, With Cylinder	54315R0 (P)			\$162.42		\$171.16
	54315R0 (S)			\$148.42		\$157.16
Indoor/Outdoor Padlock, Non-Key Retaining, 2 3/8" Shackle Clearance, With Cylinder	5431F00 (P)			\$168.42		\$177.50
	5431F00 (S)			\$154.42		\$163.50
Indoor/Outdoor Padlock, Key Retaining, 2 3/8" Shackle Clearance, With Cylinder	5431FR0 (P)			\$168.42		\$177.50
	5431FR0 (S)			\$154.42		\$163.50

Indoor/Outdoor Padlock, 5/16" Shackle -7 Pin SFIC

Description	Part Number	M4/M ³	BiLevel	X4	Biax/Orig	KeyMark
Indoor/Outdoor Padlock, Non-Key Retaining, 1 1/8" Shackle Clearance, With Cylinder	5433500 (P)			\$162.42		\$171.16
	5433500 (S)			\$148.42		\$157.16
Indoor/Outdoor Padlock, Key Retaining, 1 1/8" Shackle Clearance, With Cylinder	54335R0 (P)			\$162.42		\$171.16
	54335R0 (S)			\$148.42		\$157.16
Indoor/Outdoor Padlock, Non-Key Retaining, 2 3/8" Shackle Clearance, With Cylinder	5433F00 (P)			\$168.42		\$177.50
	5433F00 (S)			\$154.42		\$163.50
Indoor/Outdoor Padlock, Key Retaining, 2 3/8" Shackle Clearance, With Cylinder	5433FR0 (P)			\$168.42		\$177.50
	5433FR0 (S)			\$154.42		\$163.50

Indoor/Outdoor Padlock, 5/16" Shackle -Less SFIC

Description	Part Number	Price
Indoor/Outdoor Padlock, Key Retaining, 1 1/8" Shackle Clearance, Less Cylinder	54315K0	\$64.90
Indoor/Outdoor Padlock, Non-Key Retaining, 1 1/8" Shackle Clearance, Less Cylinder	54315L0	\$64.90
Indoor/Outdoor Padlock, Key Retaining, 2 3/8" Shackle Clearance, Less Cylinder	5431FK0	\$70.90
Indoor/Outdoor Padlock, Non-Key Retaining, 2 3/8" Shackle Clearance, Less Cylinder	5431FL0	\$70.90

(P) = Pinned (combined)

(S) = Sub-assembled (uncombined)

Surcharges for Master Keying, Custom Coining and Custom Stamping apply, see page 202.

Refer to the XT and CLIQ Intelligent Key sections for format availability and pricing.

Indoor/Outdoor Padlock, 7/16" Shackle -KIK

Description	Part Number	M4/M ³	BiLevel	X4	Biax/Orig	KeyMark
Indoor/Outdoor Padlock, Non-Key Retaining, 1 3/8" Shackle Clearance, With Cylinder	5471500 (P)	\$220.00	\$162.33	\$203.42	\$231.33	\$214.42
	5471500 (S)	\$206.00	\$154.83	\$189.42	\$217.33	\$200.42
Indoor/Outdoor Padlock, Key Retaining, 1 3/8" Shackle Clearance, With Cylinder	54715R0 (P)	\$220.00	\$162.33	\$203.42	\$231.33	\$214.42
	54715R0 (S)	\$206.00	\$154.83	\$189.42	\$217.33	\$200.42
Indoor/Outdoor Padlock, Non-Key Retaining, 1 7/8" Shackle Clearance, With Cylinder	5471F00 (P)	\$225.00	\$167.33	\$208.42	\$236.60	\$219.69
	5471F00 (S)	\$211.00	\$159.83	\$194.42	\$222.60	\$205.69
Indoor/Outdoor Padlock, Key Retaining, 1 7/8" Shackle Clearance, With Cylinder	5471FR0 (P)	\$225.00	\$167.33	\$208.42	\$236.60	\$219.69
	5471FR0 (S)	\$211.00	\$159.83	\$194.42	\$222.60	\$205.69
Indoor/Outdoor Padlock, Key Retaining, 1 3/8" Shackle Clearance, Less Cylinder	54715K0	\$94.00				
Indoor/Outdoor Padlock, Non-Key Retaining, 1 3/8" Shackle Clearance, Less Cylinder	54715L0	\$94.00				
Indoor/Outdoor Padlock, Key Retaining, 1 7/8" Shackle Clearance, Less Cylinder	5471FK0	\$99.00				
Indoor/Outdoor Padlock, Non-Key Retaining, 1 7/8" Shackle Clearance, Less Cylinder	5471FL0	\$99.00				

Indoor/Outdoor Padlock, 7/16" Shackle -6 Pin LFIC

Description	Part Number	M4/M ³	BiLevel	X4	Biax/Orig	KeyMark
Indoor/Outdoor Padlock, Non-Key Retaining, 1 3/8" Shackle Clearance, With Cylinder	5481500 (P)	\$296.00			\$311.51	
	5481500 (S)	\$282.00			\$297.51	
Indoor/Outdoor Padlock, Key Retaining, 1 3/8" Shackle Clearance, With Cylinder	54815R0 (P)	\$296.00			\$311.51	
	54815R0 (S)	\$282.00			\$297.51	
Indoor/Outdoor Padlock, Non-Key Retaining, 1 7/8" Shackle Clearance, With Cylinder	5481F00 (P)	\$304.00			\$319.95	
	5481F00 (S)	\$290.00			\$305.95	
Indoor/Outdoor Padlock, Key Retaining, 1 7/8" Shackle Clearance, With Cylinder	5481FR0 (P)	\$304.00	\$221.03		\$319.95	
	5481FR0 (S)	\$290.00	\$213.53		\$305.95	
Indoor/Outdoor Padlock, Key Retaining, 1 3/8" Shackle Clearance, Less Cylinder	54815K0	\$103.00				
Indoor/Outdoor Padlock, Non-Key Retaining, 1 3/8" Shackle Clearance, Less Cylinder	54815L0	\$103.00				
Indoor/Outdoor Padlock, Key Retaining, 1 7/8" Shackle Clearance, Less Cylinder	5481FK0	\$111.00				
Indoor/Outdoor Padlock, Non-Key Retaining, 1 7/8" Shackle Clearance, Less Cylinder	5481FL0	\$111.00				

(P) = Pinned (combined)

(S) = Sub-assembled (uncombined)

Surcharges for Master Keying, Custom Coining and Custom Stamping apply, see page 202.
Refer to the XT and CLIQ Intelligent Key sections for format availability and pricing.

Shrouded Padlock, 5/16" Shackle - KIK

Description	Part Number	M4/M ³	BiLevel	X4	Biax/Orig	KeyMark
Shrouded Padlock, Non-Key Retaining, 3/4" Shackle Clearance, With Cylinder	5452500 (P)	\$215.00	\$157.33	\$198.42	\$226.06	\$209.15
	5452500 (S)	\$201.00	\$149.83	\$184.42	\$212.06	\$195.15
Shrouded Padlock, Key Retaining, 3/4" Shackle Clearance, With Cylinder	54525R0 (P)	\$215.00	\$157.33	\$198.42	\$226.06	\$209.15
	54525R0 (S)	\$201.00	\$149.83	\$184.42	\$212.06	\$195.15
Shrouded Padlock, Key Retaining, 3/4" Shackle Clearance, Less Cylinder	54525K0	\$89.00				
Shrouded Padlock, Non-Key Retaining, 3/4" Shackle Clearance, Less Cylinder	54525L0	\$89.00				

(P) = Pinned (combined)

(S) = Sub-assembled (uncombined)

Surcharges for Master Keying, Custom Coining and Custom Stamping apply, see page 202.
Refer to the XT and CLIQ Intelligent Key sections for format availability and pricing.

Shrouded Padlock, 5/16" Shackle - 6 Pin LFIC

Description	Part Number	M4/M ³	BiLevel	X4	Biax/Orig	KeyMark
Shrouded Padlock, Non-Key Retaining, 3/4" Shackle Clearance, With Cylinder	5462500 (P)	\$290.00			\$305.18	
	5462500 (S)	\$276.00			\$291.18	
Shrouded Padlock, Key Retaining, 3/4" Shackle Clearance, With Cylinder	54625R0 (P)	\$290.00			\$305.18	
	54625R0 (S)	\$276.00			\$291.18	
Shrouded Padlock, Key Retaining, 3/4" Shackle Clearance, Less Cylinder	54625K0	\$97.00				
Shrouded Padlock, Non-Key Retaining, 3/4" Shackle Clearance, Less Cylinder	54625L0	\$97.00				

Shrouded Padlock, 5/16" Shackle - 6 Pin SFIC

Description	Part Number	M4/M ³	BiLevel	X4	Biax/Orig	KeyMark
Shrouded Padlock, Non-Key Retaining, 3/4" Shackle Clearance, With Cylinder	5432500 (P)			\$190.42	\$200.71	
	5432500 (S)			\$176.42	\$186.71	
Shrouded Padlock, Key Retaining, 3/4" Shackle Clearance, With Cylinder	54325R0 (P)			\$190.42	\$200.71	
	54325R0 (S)			\$176.42	\$186.71	

Shrouded Padlock, 5/16" Shackle - 7 Pin SFIC

Description	Part Number	M4/M ³	BiLevel	X4	Biax/Orig	KeyMark
Shrouded Padlock, Non-Key Retaining, 3/4" Shackle Clearance, With Cylinder	5434500 (P)			\$190.42	\$200.71	
	5434500 (S)			\$176.42	\$186.71	
Shrouded Padlock, Key Retaining, 3/4" Shackle Clearance, With Cylinder	54345R0 (P)			\$190.42	\$200.71	
	54345R0 (S)			\$176.42	\$186.71	

Shrouded Padlock, 5/16" Shackle - Less SFIC

Description	Part Number	M4/M ³	BiLevel	X4	Biax/Orig	KeyMark
Shrouded Padlock, Key Retaining, 3/4" Shackle Clearance, Less Cylinder	54325K0			\$92.90		
Shrouded Padlock, Non-Key Retaining, 3/4" Shackle Clearance, Less Cylinder	54325L0			\$92.90		

(P) = Pinned (combined)

(S) = Sub-assembled (uncombined)

Surcharges for Master Keying, Custom Coining and Custom Stamping apply, see page 202.
Refer to the XT and CLIQ Intelligent Key sections for format availability and pricing.

Shrouded Padlock, 7/16" Shackle - KIK

Description	Part Number	M4/M ³	BiLevel	X4	Biax/Orig	KeyMark
Shrouded Padlock, Non-Key Retaining, 3/4" Shackle Clearance, With Cylinder	5472500 (P)	\$262.00	\$204.33	\$245.42	\$275.64	\$258.73
	5472500 (S)	\$248.00	\$196.83	\$231.42	\$261.64	\$244.73
Shrouded Padlock, Key Retaining, 3/4" Shackle Clearance, With Cylinder	54725R0 (P)	\$262.00	\$204.33	\$245.42	\$275.64	\$258.73
	54725R0 (S)	\$248.00	\$196.83	\$231.42	\$261.64	\$244.73
Shrouded Padlock, Key Retaining, 3/4" Shackle Clearance, Less Cylinder	54725K0	\$136.00				
Shrouded Padlock, Non-Key Retaining, 3/4" Shackle Clearance, Less Cylinder	54725L0	\$136.00				

Shrouded Padlock, 7/16" Shackle - 6 Pin LFIC

Description	Part Number	M4/M ³	BiLevel	X4	Biax/Orig	KeyMark
Shrouded Padlock, Non-Key Retaining, 3/4" Shackle Clearance, With Cylinder	5482500 (P)	\$336.00			\$353.71	
	5482500 (S)	\$322.00			\$339.71	
Shrouded Padlock, Key Retaining, 3/4" Shackle Clearance, With Cylinder	54825R0 (P)	\$336.00			\$353.71	
	54825R0 (S)	\$322.00			\$339.71	
Shrouded Padlock, Key Retaining, 3/4" Shackle Clearance, Less Cylinder	54825K0	\$143.00				
Shrouded Padlock, Non-Key Retaining, 3/4" Shackle Clearance, Less Cylinder	54825L0	\$143.00				

Shrouded Padlock, 7/16" Shackle - 6 Pin SFIC

Description	Part Number	M4/M ³	BiLevel	X4	Biax/Orig	KeyMark
Shrouded Padlock, Non-Key Retaining, 3/4" Shackle Clearance, With Cylinder	5442500 (P)			\$234.42		\$247.13
	5442500 (S)			\$220.42		\$233.13
Shrouded Padlock, Key Retaining, 3/4" Shackle Clearance, With Cylinder	54425R0 (P)			\$234.42		\$247.13
	54425R0 (S)			\$220.42		\$233.13

Shrouded Padlock, 7/16" Shackle - 6 Pin SFIC

Description	Part Number	M4/M ³	BiLevel	X4	Biax/Orig	KeyMark
Shrouded Padlock, Non-Key Retaining, 3/4" Shackle Clearance, With Cylinder	5444500 (P)			\$234.42		\$247.13
	5444500 (S)			\$220.42		\$233.13
Shrouded Padlock, Key Retaining, 3/4" Shackle Clearance, With Cylinder	54445R0 (P)			\$234.42		\$247.13
	54445R0 (S)			\$220.42		\$233.13

Shrouded Padlock, 7/16" Shackle - Less SFIC

Description	Part Number	M4/M ³	BiLevel	X4	Biax/Orig	KeyMark
Shrouded Padlock, Key Retaining, 3/4" Shackle Clearance, Less Cylinder	54425K0	\$136.90				
Shrouded Padlock, Non-Key Retaining, 3/4" Shackle Clearance, Less Cylinder	54425L0	\$136.90				

(P) = Pinned (combined)

(S) = Sub-assembled (uncombined)

Surcharges for Master Keying, Custom Coining and Custom Stamping apply, see page 202.
Refer to the XT and CLIQ Intelligent Key sections for format availability and pricing.

52 Series Padlock, 5/16" Shackle

Description	Part Number	M4/M ³	BiLevel	X4	Biax/Orig	KeyMark
1 1/8" Clearance, Boron Alloy Shackle	526201 (P)	\$184.00			\$193.35	
	526201 (S)	\$170.00			\$179.35	
2 3/8" Clearance, Boron Alloy Shackle	526301 (P)	\$184.00			\$193.35	
	526301 (S)	\$170.00			\$179.35	
1 1/8" Clearance, Boron Alloy Shackle, Less Cylinder	526200	\$111.00				
2 3/8" Clearance, Boron Alloy Shackle, Less Cylinder	526300	\$111.00				
1 1/8" Clearance, Stainless Steel Shackle	526211 (P)	\$184.00			\$193.35	
	526211 (S)	\$170.00			\$179.35	
2 3/8" Clearance, Stainless Steel Shackle	526311 (P)	\$184.00			\$193.35	
	526311 (S)	\$170.00			\$179.35	
1 1/8" Clearance, Stainless Steel Shackle, Less Cylinder	526210	\$111.00				
2 3/8" Clearance, Stainless Steel Shackle, Less Cylinder	526310	\$111.00				

*Padlock body is solid brass with 26 plated finish.

52 Series Padlock, 5/16" Shackle, Removable Core

Description	Part Number	M4/M ³	BiLevel	X4	Biax/Orig	KeyMark
1 1/8" Clearance, Boron Alloy Shackle, Removable Core, Less Cylinder	52-6202	\$135.70				
2 3/8" Clearance, Boron Alloy Shackle, Removable Core, Less Cylinder	52-6302	\$135.70				
1 1/8" Clearance, Stainless Steel Shackle, Removable Core, Less Cylinder	52-6212	\$135.70				
2 3/8" Clearance, Stainless Steel Shackle, Removable Core, Less Cylinder	52-6312	\$135.70				

*Padlock body is solid brass with 26 plated finish.

Note: 52-6 Series padlocks use a 5 pin/4 level 60 Series cylinder and can be keyed into a system utilizing cam and switch locks.

(P) = Pinned (combined)

(S) = Sub-assembled (uncombined)

Surcharges for Master Keying, Custom Coining and Custom Stamping apply, see page 202.
Refer to the XT and CLIQ Intelligent Key sections for format availability and pricing.

52 Series Padlock, 7/16" Shackle

Description	Part Number	M4/M ³	BiLevel	X4	Biax/Orig	KeyMark
1 3/8" Clearance, Boron Alloy Shackle	526001 (P)	\$184.00			\$193.35	
	526001 (S)	\$170.00			\$179.35	
1 7/8" Clearance, Boron Alloy Shackle	526101 (P)	\$184.00			\$193.35	
	526101 (S)	\$170.00			\$179.35	
1 3/8" Clearance, Boron Alloy Shackle, Less Cylinder	526000	\$111.00				
1 7/8" Clearance, Boron Alloy Shackle, Less Cylinder	526100	\$111.00				
1 3/8" Clearance, Stainless Steel Shackle	526011 (P)	\$184.00			\$193.35	
	526011 (S)	\$170.00			\$179.35	
1 7/8" Clearance, Stainless Steel Shackle	526111 (P)	\$184.00			\$193.35	
	526111 (S)	\$170.00			\$179.35	
1 3/8" Clearance, Stainless Steel Shackle, Less Cylinder	526010	\$111.00				
1 7/8" Clearance, Stainless Steel Shackle, Less Cylinder	526110	\$111.00				

*Padlock body is solid brass with 26 plated finish.

52 Series Padlock, 7/16" Shackle, Removable Core

Description	Part Number	M4/M ³	BiLevel	X4	Biax/Orig	KeyMark
1 3/8" Clearance, Boron Alloy Shackle, Removable Core, Less Cylinder	526002	\$135.70				
1 7/8" Clearance, Boron Alloy Shackle, Removable Core, Less Cylinder	526102	\$135.70				
1 3/8" Clearance, Stainless Steel Shackle, Removable Core, Less Cylinder	526012	\$135.70				
1 7/8" Clearance, Stainless Steel Shackle, Removable Core, Less Cylinder	526112	\$135.70				

*Padlock body is solid brass with 26 plated finish.

52 series Padlocks Cover Options: 00 = Standard, 01 = Case Cover, 10 = Dust Cover

Note: 52-6 Series padlocks use 5 pin/4 level 60 Series cylinders and can be keyed into a system utilizing cam and switch locks.

(P) = Pinned (combined)

(S) = Sub-assembled (uncombined)

Surcharges for Master Keying, Custom Coining and Custom Stamping apply, see page 202.
Refer to the XT and CLIQ Intelligent Key sections for format availability and pricing.

50 Series Brass Body Padlocks

Description	Part Number	M4/M ³	BiLevel	X4	Biax/Orig	KeyMark
I/C Core Brass Padlock, 2 1/4" Shackle Clearance, Hardened Steel, Key Retaining	5002201 (P)	\$374.00			\$393.80	
	5002201 (S)	\$360.00			\$379.80	
I/C Core Brass Padlock, 2 1/4" Shackle Clearance, Stainless Steel, Key Retaining	5002211 (P)	\$374.00			\$393.80	
	5002211 (S)	\$360.00			\$379.80	
I/C Core Brass Padlock, 2 1/4" Shackle Clearance, Hardened Steel, Non-key Retaining	5003201 (P)	\$374.00			\$393.80	
	5003201 (S)	\$360.00			\$379.80	
I/C Core Brass Padlock, 2 1/4" Shackle Clearance, Stainless Steel, Key Retaining	5003211 (P)	\$374.00			\$393.80	
	5003211 (S)	\$360.00			\$379.80	
Removeable Cylinder Brass Padlock, 2 1/4" Shackle Clearance, Hardened Steel, Key Retaining	5008201 (P)	\$351.00			\$369.54	
	5008201 (S)	\$337.00			\$355.54	
Removeable Cylinder Brass Padlock, 2 1/4" Shackle Clearance, Stainless Steel, Key Retaining	5008211 (P)	\$351.00			\$369.54	
	5008211 (S)	\$337.00			\$355.54	
Removeable Cylinder Brass Padlock, 2 1/4" Shackle Clearance, Hardened Steel, Non-key Retaining	5009201 (P)	\$351.00			\$369.54	
	5009201 (S)	\$337.00			\$355.54	
Removeable Cylinder Brass Padlock, 2 1/4" Shackle Clearance, Stainless Steel, Non-key Retaining	5009211 (P)	\$351.00			\$369.54	
	5009211 (S)	\$337.00			\$355.54	
Brass Padlock, 2 1/4" Shackle Clearance, Hardened Steel, Key Retaining, Less Cylinder	50-74201	\$178.00				
Brass Padlock, 2 1/4" Shackle Clearance, Stainless Steel, Key Retaining, Less Cylinder	50-74211	\$178.00				
Brass Padlock, 2 1/4" Shackle Clearance, Hardened Steel, Non-key Retaining, Less Cylinder	50-75201	\$178.00				
Brass Padlock, 2 1/4" Shackle Clearance, Stainless Steel, Non-key Retaining, Less Cylinder	50-75211	\$178.00				

Padlock Cylinders

Description	Part Number	M4/M ³	BiLevel	X4	Biax/Orig	KeyMark
5 Pin Cylinder (6 pin Medeco X4) for Hockey Puck Style Padlock sold after 9/2004 (KIK style cylinder)	2001600 (P)	\$110.10	\$59.87	\$54.65	\$115.39	\$58.29
	2001600 (S)	\$96.10	\$52.37	\$40.65	\$101.39	\$44.29
6 Pin Cylinder for LFIC Medeco Padlocks, 50 & 54 Series	320201 (P)	\$167.00	\$90.89		\$175.42	
	320201 (S)	\$153.00	\$83.39		\$161.42	
Removeable Cylinder to fit 50 Series Brass Padlocks (Note - only available in 06 finish)	320202 (P)	\$147.00			\$154.31	
	320202 (S)	\$133.00			\$140.31	
6 Pin Cylinder for KIK Medeco Padlock, for 54 Series Padlocks	510600 (P)	\$124.00	\$67.68	\$107.75	\$130.05	\$113.36
	510600 (S)	\$110.00	\$60.18	\$93.75	\$116.05	\$99.36
5 Pin Spring Bolt Cylinder (non-key retaining), for G8R Padlock	960357 (P)	\$125.60			\$130.91	
	960357 (S)	\$96.60			\$101.91	
5 Pin Deadbolt Cylinder (key retaining), for G8R Padlock	960358 (P)	\$125.60			\$130.91	
	960358 (S)	\$96.60			\$101.91	
Spacer for use with 5 Pin Cylinders, for G8R Padlock	CP-160691	\$2.12				
5 Pin cylinder (cam lock style) for 52-6 padlocks	66418 (P)	\$112.60			\$117.20	
	66418 (S)	\$83.60			\$88.20	
5 Pin Removable plug for 52-6 padlocks	66391 (P)	\$96.00			\$99.69	
	66391 (S)	\$67.00			\$70.69	

Electronic padlock cylinders are available for many of the padlocks. Refer to the XT and CLIQ sections for specific part numbers and pricing.

(P) = Pinned (combined)

(S) = Sub-assembled (uncombined)

Surcharges for Master Keying, Custom Coining and Custom Stamping apply, see page 202.
Refer to the XT and CLIQ Intelligent Key sections for format availability and pricing.

Components

Description	Part Number	Price
Component Package for 54 Series Padlocks, NonKey Retaining. Includes CP-130510 Cylinder Extension/Actuator, Spring & Washer, CP-022030 Cylinder Retainer, CP-011511-000 Retainer Screw, CP-250140 Steel Ball Bearing	94-0199	\$15.00
Cylinder Retainer Sleeve (Fits over Cylinder Bible Chamber & holds cylinder in padlock body)	CP-022030	\$7.81
Retainer Screw, #6-32 UNC-2A x .312" length	CP-011511-000	\$0.71
Cylinder Extension/Actuator, Non Key Retaining, Spring & Washer for 54 Series Padlocks	CP-130510	\$6.57
Stainless Steel Ball Bearing for 54 Series Padlocks, .360" Diameter	CP-250140	\$0.71
Cylinder Extension/Actuator, Key Retaining, for 54 Series Padlocks	CP-200720	\$6.57
Chain Assembly for 50 Series Brass Padlocks	CP-280271	\$35.00
Case Cover for 50 Series Brass Padlocks	CP-170250	\$21.00
Shackle Spring for 50 Series Brass Padlocks	CP-030430	\$0.46
Actuator Adaptor for 50 Series Brass Padlocks	CP-130101	\$8.94
Locking Balls for 50 Series Brass Padlocks	CP-250040	\$1.77
3/16" Cylinder Retaining Ball for 50 Series Brass Padlocks	CP-250030	\$0.43
1/16" Hex Allen Wrench - Long Arm to use with 50 Series Brass Padlocks	94-0020	\$5.67
Package for Sub-assembled 50 Series Brass Padlock, Includes: Set screws, retaining ball, Brass Pin Chamber Cover	94-0052	\$16.90

Shackles for Indoor/Outdoor Padlocks

Description	Boron Alloy Steel		Stainless Steel	
	Part Number	Price	Part Number	Price
Standard Shackle for 54-51 Indoor/Outdoor Padlock, 1-1/8" Shackle Clearance x 5/16" Diameter	CP-144120	\$11.40	CP-144180	\$17.10
Extra Length Shackle for 54-51 Indoor/Outdoor Padlock, 2-3/8" Shackle Clearance x 5/16" Diameter	CP-144130	\$13.80	CP-144190	\$19.20
Standard Shackle for 54-71 Indoor/Outdoor Padlock, 1-3/8" Shackle Clearance x 7/16" Diameter	CP-144150	\$13.80	CP-144210	\$19.20
Extra Length Shackle for 54-71 Indoor/Outdoor Padlock, 1-7/8" Shackle Clearance x 7/16" Diameter	CP-144160	\$15.20	CP-144220	\$21.00

Shackles for Shrouded Padlocks

Description	Boron Alloy Steel		Stainless Steel	
	Part Number	Price	Part Number	Price
Standard Shackle for 54-52 Shrouded Padlock, 3/4" Shackle Clearance x 5/16" Diameter	CP-144110	\$11.40	CP-144170	\$17.10
Standard Shackle for 54-72 Shrouded Padlock, 3/4" Shackle Clearance x 7/16" Diameter	CP-144140	\$13.80	CP-144200	\$19.20

Shackles for 50 Series Brass Padlocks

Description	Part Number	Price
2 1/4" Stainless Steel Shackle for 50 Series Brass Padlocks	CP-142543	\$60.70
2 1/4" Hardened Steel Shackle for 50 Series Brass Padlocks	CP-142043	\$56.70

Hockey Puck Padlocks

Medeco® offers a variety of high security padlocks that are designed to accept both mechanical and eCylinders. The Medeco Hockey Puck style padlocks come with hardened, solid steel bodies, a shackle-less design for the highest level of protection against bolt cutter attacks, and patent protected key control. Every padlock cylinder is UL 437 Listed and can be keyed into any existing 10 series product. The Medeco³ unique design provides triple locking action, making the locks virtually pick proof. All Medeco³ keys and locks are protected under patent, trademark, and copyright laws. Medeco³ keys may only be duplicated by Medeco or by a Medeco authorized sales outlet, and only at your request.



Patented Key Control

Protects against unauthorized duplication of your keys.



Protection From Physical Attack

Medeco³ padlock cylinders are UL 437 listed and stand up to drilling, picking and other forms of physical attack. The Hockey Pucks shackle-less design provides the highest protection from bolt cutter attacks.



Can Be Master Keyed

Medeco Hockey Puck Padlocks can be master keyed into existing Medeco 10 Series products.



Available in eCylinder

Medeco's Hockey Puck Padlocks are also available with Medeco eCylinders for Loss & Liability control.



Special Angle Cut Keys

Requires a special key cutting machine and access to Medeco specific blanks, available in a variety of restrictions to support every need.



Picking and Bumping Protection

Medeco³ cylinders use a sidebar that prevent the key from rotating until it is elevated, rotated and aligned in the correct position. This feature protects against bumping and picking attacks.

Technical Features:

- Hardened steel body.
- 5 pin, key-in-knob cylinder.
- Requires a key to relock.
- Hardened solid steel, black chrome plated body.
- All Medeco cylinders are constructed of durable machined brass components, designed to last the life of your equipment.

Applications:

Hockey Puck style padlocks can be used in a variety of different applications including vending, storage and transportation.

Warranty:

Warranted for two (2) years against manufacturer's defects. See the Medeco® limited warranty for full details.

Available Key Technologies:

Mechanical:

- Medeco³
- Medeco³ BiLevel*
- Medeco X4*

eCylinder:

- Medeco XT

52-9 Series Hockey Puck Padlock

Description	Part Number	Medeco ³	BiLevel	Medeco X4
Hockey Puck Padlock, With 5 Pin High Security or 6 Pin Medeco X4 Cylinder	5293000 (P)	\$203.00	\$146.21	\$186.75
	5293000 (S)	\$189.00	\$138.71	\$172.75
Hockey Puck Padlock, Non-Key Retaining, Less Cylinder	52930L0	\$86.90		

Hockey Puck uses unique cylinders and can be pinned to a door hardware key. Not available with LFIC or SFIC.

Experience a safer
and more open world

medeco
ASSA ABLOY

G8R Padlocks

Medeco® offers a variety of High Security Padlocks that are designed to accept both mechanical and eCylinders. With its tough, weather resistant construction, this is the padlock of choice for extreme environments such as trailers, cargo containers, and gates. The Medeco® G8R body is constructed of solid stainless steel. You can choose from either a stainless steel shackle for maximum corrosion resistance, or hardened steel to withstand severe physical attack. Each padlock includes a weather seal cap attached by a cable. The Medeco® G8R will accept either an eCylinder or mechanical t-handle cylinder. The mechanical cylinders provide the benefit of patented key control and pick resistance. The eCylinder adds sophisticated audit and control features transforming the G8R into a portable access control system for extreme environments.

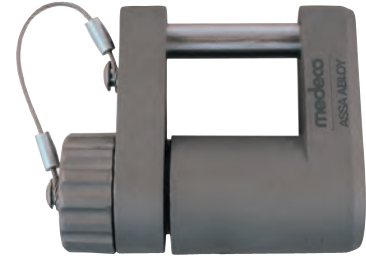

Patented Key Control

Protects against unauthorized duplication of your keys.



Protection From Physical Attack

Medeco³ padlock cylinders are UL 437 listed and stand up to drilling, picking and other forms of physical attack. Available in either a hardened steel shackle to withstand severe physical attack or a stainless steel shackle for maximum corrosion resistance.



Weather Resistant Construction

Uses a weather seal cap, attached by a cable, to provide protection from water and road grime.



Available in eCylinder

Medeco G8R Padlocks are also available with Medeco eCylinders for Loss & Liability control.



Special Angle Cut Keys

Requires a special key cutting machine and access to Medeco specific blanks, available in a variety of restrictions to support every need.



Picking and Bumping Protection

Medeco³ cylinders use a sidebar that prevent the key from rotating until it is elevated, rotated and aligned in the correct position. This feature protects against bumping and picking attacks.

Technical Information:

- 300 series, cast stainless steel body.
- Padlock is sold less cylinder. Compatible with Medeco® mechanical and NEXGEN electronic t-handle cylinders.
- Padlocks are shipped with a weather seal cap attached by a steel cable. A finish plate is included for applications that do not require the weather seal cap.
- Sealed construction protects cylinders from water and road grime.
- Stainless steel body resists attack and corrosion.
- Shackles can be specified in stainless or hardened steel to fit your application.

Applications:

- The G8R Series was designed for locking installations requiring weather resistance and strong physical security. Applications include: cargo containers, trailer doors, gates, vending machines.

Warranty:

Warranted for two (2) years against manufacturer's defects. See the Medeco® limited warranty for full details

Available Key Technologies:

Mechanical:

- Medeco³

eCylinder:

- Medeco XT
- Classic CLIQ
- Medeco Nexgen

G8R Series Padlock

Description	Part Number	Price
G8R Weather-tight Padlock, 5/16" Stainless Steel Shackle, less pop-out cylinder	52110040	\$173.00
G8R Weather-tight Padlock, 5/16" Hardened Steel Shackle, less pop-out cylinder	52111040	\$173.00
G8R Weather-tight Padlock, 7/16" Stainless Steel Shackle, less pop-out cylinder	52120040	\$173.00
G8R Weather-tight Padlock, 7/16" Hardened Steel Shackle, less pop-out cylinder	52121040	\$173.00
G8R cap and seal kit	94-0213	\$29.40

G8R padlocks are sold less cylinder and use a cam lock style key with pop-out plug.

Keys are charged separately for this style cylinder.

Experience a safer
and more open world

medeco
ASSA ABLOY

Cam, Cabinet & Switch Locks

FEATURES	Medeco ³	CLIQ	Medeco XT
Easily integrated into existing cam lock master key systems	●	●	●
Easy installation	●	●	●
Completely serviceable and may be rekeyed in the event of a lost or stolen key	●	●	●
UL437 Listing on cylinder for high security	●		
Cam locks available in all standard lengths, flats, and rotations	●	●	●
Switch locks available in single or double switch models and momentary and maintained positions with silver or gold contacts (for low amperage applications) designed to accept quick connect leads	●	●	●

Medeco³ Premium High Security

For effective mechanical protection against most forms of attack as well as protection against unauthorized duplicate keys, Medeco³ cylinders are recommended. Security features including hardened steel components, pins that must be elevated, rotated, and interact with both a sidebar and a slider, and additional pick resistant features make Medeco³ the cylinder of choice to protect people, property and information.

Intelligent Key Solutions

Many of the cylinders in this section are also available with an Intelligent Key solution. See the Intelligent Key section for more details.

Cam Locks

Medeco Cam Lock Part Number Configurations

Model Number	Operation Code	Cylinder	Finish	Keyway	"Cam Lock Operation Code" – Describes the function of the lock: direction of key turn, rotation, key retaining or two key-pull.
XXXXXXXX	XXX	X	26	XX	

Cam Lock Operation Codes – Fixed Core Cam Locks

Describes the function of the lock

Operation Code	Rotation Distance	Direction to Unlock	Key Retaining or 2 Key Pull
219	90°	Clockwise	Key Retaining
229	90°	Clockwise	2 Key Pull
239	90°	Counterclockwise	Key Retaining
249	90°	Counterclockwise	2 Key Pull
259	180°	Clockwise	Key Retaining
269	180°	Clockwise	2 Key Pull
279	180°	Counterclockwise	Key Retaining
289	180°	Counterclockwise	2 Key Pull

Note: Key Retaining – Key is removable in the locked position only.

2 Key Pull – Key is removable in both the locked and unlocked positions.

Cam Locks

Medeco® High Security Cam Locks are recognized throughout the world as the standard for protection in a 3/4 inch diameter lock. Medeco Cam Locks utilize hardened, stainless steel inserts throughout the cylinder to provide the ultimate defense against drilling, pulling, and other forms of vandal attacks. Patented key control programs prevent the unauthorized duplication of keys and maintain system integrity. Keyed alike, keyed different, or master keyed, Medeco offers a complete line of cam locks in a wide variety of sizes and functions to meet your specific needs.



Patented Key Control

Protects against unauthorized duplication of your keys.



Available in eCylinder

Medeco cam locks are also available with Medeco eCylinders for loss & liability control.



Can Be Master Keyed

Medeco cam locks can be keyed alike, keyed different or master keyed.



Protection From Physical Attack

Medeco3 cam locks are UL 437 Listed and stand up to drilling, picking and other forms of physical attack.

Benefits:

- All Medeco® cylinders are constructed of durable machined brass components.
- Hardened stainless steel inserts inside the cylinder provide the ultimate defense against drilling and other forms of physical attack.
- Unique elevating and rotating tumbler pin system is virtually pick proof.
- Patented Medeco³ keys may only be duplicated by Medeco or an authorized Medeco service outlet, and only at your request.
- Locks can be keyed alike, keyed different, or master keyed depending on your specific needs.
- Available in various lengths and rotations.

Technical Information:

- Four or five pin models available depending on size
- Available in three standard sizes, 1 1/16 inch, 7/8 inch and 1 1/8 inch
- Two flat models available, key retaining only
- Clockwise or counterclockwise rotation, 90 or 180 degrees
- Keyed alike, keyed different or master keyed

Warranty:

Warranted for two (2) years against manufacturer's defects. See the Medeco® limited warranty for full details

Finishes:

- 26 satin chrome finish standard
- Other finishes available, depending on volume

Certification:

- UL437 Listed

Applications:

Medeco® Cam Locks can be used in any standard 3/4 inch diameter application and a multitude of markets including:

- Safes
- Communication
- Alarm
- Access control
- Banking
- Utility
- Data Encryption
- Cabinet
- Transit
- Lockers

Available Key Technologies:

Mechanical:

- Medeco³
- Medeco X4

eCylinder:

- Classic CLIQ
- Medeco XT

Medeco³ All-In-One Cam Lock Kits

Description	Part Number	M ³	BiLevel	X4	Biax/Orig	KeyMark
7/8" Length 5 Pin Cam Lock Kit	600350T KIT (P)	\$127.93			\$132.85	
	600350T KIT (S)	\$98.93			\$103.85	
11/8" Length 5 Pin Cam Lock Kit	600650T KIT (P)	\$127.93			\$132.85	
	600650T KIT (S)	\$98.93			\$103.85	
5/8" Length 5 Pin Cam Lock Kit	601150T KIT (P)	\$127.93			\$132.85	
	601150T KIT (S)	\$98.93			\$103.85	
11/2" 5 Pin Cam Lock Kit	601450T KIT (P)	\$132.33			\$137.49	
	601450T KIT (S)	\$103.33			\$108.49	

Medeco X4 Cam Lock Kit

Description	Part Number	M ³	BiLevel	X4	Biax/Orig	KeyMark
1 1/8" length Medeco X4 7 pin cam lock kit with two cams, hex nut, lock washer, mounting washer and 1/4" spacer collar.	210503 (P)			\$83.10		\$101.67
	210503 (S)			\$83.10		\$87.67

There is a 6 piece minimum order quantity for high security cam locks.

All-in-One Cam Lock Kits include: CP-040500 pronged washer, CT-A05 flat cam, CT-D05 flat cam, CT-J01 offset cam, CT-H07 offset cam, CP-040451 90 degree stop washer, CP-040461 180 degree stop washer CP-050060 3/4" - 27 mounting nut and 2 keys.

Master keying is not available in a cam lock kit, but may be custom ordered with specific cam locks listed on the following pages.

(P) = Pinned (combined)

(S) = Sub-assembled (uncombined)

Surcharges for Master Keying, Custom Coining and Custom Stamping apply, see page 202.
Refer to the XT and CLIQ Intelligent Key sections for format availability and pricing.

High Security Cam Locks

Description	Part Number	M ³	BiLevel	X4	Biax/Orig	KeyMark
5 pin, 1 1/16" Cam lock	600250T (P)	\$118.50			\$123.42	
	600250T (S)	\$89.50			\$94.42	
5 pin, 7/8" Cam lock	600350T (P)	\$118.50			\$123.42	
	600350T (S)	\$89.50			\$94.42	
5 pin, 1" Cam lock	600450T (P)	\$118.50			\$123.42	
	600450T (S)	\$89.50			\$94.42	
4 pin, 7/8" Cam lock	600550T (P)	\$116.30			\$121.10	
	600550T (S)	\$87.30			\$92.10	
5 pin, 1 1/8" Cam lock	600650T (P)	\$118.50			\$123.42	
	600650T (S)	\$89.50			\$94.42	
4 pin, 1 1/16" Cam lock	600750T (P)	\$116.30			\$121.10	
	600750T (S)	\$87.30			\$92.10	
4 pin, 5/8" Cam lock	600850T (P)	\$116.30			\$121.10	
	600850T (S)	\$87.30			\$92.10	
5 pin, 3/4" Cam lock	600950T (P)	\$118.50			\$123.42	
	600950T (S)	\$89.50			\$94.42	
5 pin, 5/8" Cam lock	601150T (P)	\$118.50			\$123.42	
	601150T (S)	\$89.50			\$94.42	
3 pin, 7/16" Cam lock	601250T (P)	\$106.60			\$110.87	
	601250T (S)	\$77.60			\$81.87	
3 pin, 5/8" Cam lock	601251T (P)	\$106.60			\$110.87	
	601251T (S)	\$77.60			\$81.87	
5 pin, 1 1/2" Cam lock	601450T (P)	\$122.90			\$128.06	
	601450T (S)	\$93.90			\$99.06	
5 pin, 2" Cam lock	601452T (P)	\$126.60			\$131.97	
	601452T (S)	\$97.60			\$102.97	

You must specify the operation code to complete the part number. Pinned pricing includes two keys. Standard sizes described, contact Medeco customer service or medeco.com for variations not listed.

There is a 6 piece minimum order quantity for high security cam locks.

Cam Lock Operation Codes

Description	Part Number
2 flat, 1 Keypull, Clockwise 90 degree	219
2 Flat, 2 Keypull, Clockwise 90 degree	229
2 Flat, 1 Keypull, Counterclockwise 90 degree	239
2 Flat, 2 Keypull, Counterclockwise 90 degree	249
2 Flat, 1 Keypull, Clockwise 180 degree	259
2 Flat, 2 Keypull, Clockwise 180 degree	269
2 Flat, 1 Keypull, Counterclockwise 180 degree	279
2 Flat, 2 Keypull, Counterclockwise 180 degree	289

(P) = Pinned (combined)

(S) = Sub-assembled (uncombined)

Surcharges for Master Keying, Custom Coining and Custom Stamping apply, see page 202.
Refer to the XT and CLIQ Intelligent Key sections for format availability and pricing.

Removable Core Cam Locks

Medeco® cam locks are available with a removable core feature allowing cores to be changed out in seconds, to provide an entirely new keying combination. For applications that may require instantaneous re-keying due to lost or stolen keys, or where periodic re-keying is done as a matter of good business practice, Medeco removable core cam locks save valuable time and money. Removable core cam locks offer the same high security features of a Medeco cam lock with the convenience of a removable core.



Patented Key Control

Protects against unauthorized duplication of your keys.



Quickly Change Cores

Medeco removable provide quick and easy cylinder changes in the event keys are lost or stolen.



Protection From Physical Attack

Medeco³ cam locks are UL 437 Listed and stand up to drilling, picking and other forms of physical attack.

Benefits:

- Removable cores can be changed out in seconds to provide a new, secure keying combination.
- All Medeco cylinders are constructed of durable machined brass components.
- Hardened stainless steel inserts inside the cylinder provide the ultimate defense against drilling and other forms of physical attack.
- Unique elevating and rotating tumbler pin system is virtually pick proof.
- Patented Medeco³ keys may only be duplicated by Medeco or an authorized Medeco service outlet, and only at your request.
- Locks can be keyed alike, keyed different, or master keyed depending on your specific needs.
- Available in various lengths and rotations.

Technical Information:

- Four or five pin models available depending on size
- Available in three standard sizes, 11/16 inch, 7/8 inch and 1 1/8 inch
- Two flat models available, key retaining only
- Clockwise or counterclockwise rotation, 90 or 180 degrees
- Keyed alike, keyed different or master keyed

Warranty:

Warranted for two (2) years against manufacturer's defects. See the Medeco® limited warranty for full details

Finishes:

- 26 satin chrome finish standard
- Other finishes available, depending on volume

Applications:

- Medeco® Removable Core Cam Locks can be used in any standard 3/4 inch diameter application and a multitude of markets including:
 - Safes
 - Utility
 - Communications
 - Data Encryption
 - Alarms
 - Cabinets
 - Access control
 - Transit
 - Banking
 - Lockers

Available Key Technologies:

Mechanical:

– Medeco³

High Security Removable Core Cam Locks

Description	Part Number	M ³	BiLevel	X4	Biax/Orig	KeyMark
4 pin, 1 1/16" Removable core camlock	607155XT (P)	\$135.00			\$140.83	
	607155XT (S)	\$106.00			\$111.83	
4 pin, 7/8" Removable core camlock	607255XT (P)	\$135.00			\$140.83	
	607255XT (S)	\$106.00			\$111.83	
4 pin, 1 1/8" Removable core camlock	607355XT (P)	\$135.00			\$140.83	
	607355XT (S)	\$106.00			\$111.83	
5 pin, 1 1/8" Removable core camlock	607455XT (P)	\$137.00			\$142.94	
	607455XT (S)	\$108.00			\$113.94	
5 pin, 7/8" Removable core camlock	607555XT (P)	\$137.00			\$142.94	
	607555XT (S)	\$108.00			\$113.94	
Plug for Removable Core Cam Locks. Cam locks are provided with plug, but additional plugs may be ordered separately. Keys not included in price.	66391 (P)	\$96.00			\$99.69	
	66391 (S)	\$67.00			\$70.69	

Pinned price includes 2 keys.

X = Rotation for Removable Core Cam Lock

Description	Part Number
90 degree Clockwise	0
90 degree Counterclockwise	1
180 degree Clockwise	2
180 degree Counterclockwise	3



A Series Flat Cams

Description	Part Number	Price
5/8" Flat Cam	CT-A00	\$3.05
3/4" Flat Cam	CT-A01	\$3.05
7/8" Flat Cam	CT-A02	\$3.05
1" Flat Cam	CT-A03	\$3.05
1 1/8" Flat Cam	CT-A04	\$3.05
1 1/4" Flat Cam	CT-A05	\$3.05
1 3/8" Flat Cam	CT-A06	\$3.05
1 1/2" Flat Cam	CT-A07	\$3.05
1 5/8" Flat Cam	CT-A08	\$3.05
1 3/4" Flat Cam	CT-A09	\$3.05
2" Flat Cam	CT-A11	\$3.05
2 1/8" Flat Cam	CT-A12	\$3.05
2 1/4" Flat Cam	CT-A13	\$3.05
2 3/8" Flat Cam	CT-A14	\$3.05
2 1/2" Flat Cam	CT-A15	\$3.05
2 5/8" Flat Cam	CT-A16	\$3.05
3" Flat Cam	CT-A19	\$3.05

(P) = Pinned (combined)

(S) = Sub-assembled (uncombined)

Surcharges for Master Keying, Custom Coining and Custom Stamping apply, see page 202.
Refer to the XT and CLIQ Intelligent Key sections for format availability and pricing.



C Series Flat Cams, 45° Tenon

Description	Part Number	Price
7/8" Flat Cam	CT-C02	\$3.05
1 1/8" Flat Cam	CT-C04	\$3.05
1 1/4" Flat Cam	CT-C05	\$3.05
1 5/8" Flat Cam	CT-C08	\$3.05
1 3/4" Flat Cam	CT-C09	\$3.05
2" Flat Cam	CT-C11	\$3.05



D Series Flat Cams, Horizontal Tenon

Description	Part Number	Price
5/8" Flat Cam	CT-D00	\$3.05
3/4" Flat Cam	CT-D01	\$3.05
7/8" Flat Cam	CT-D02	\$3.05
1" Flat Cam	CT-D03	\$3.05
1 1/8" Flat Cam	CT-D04	\$3.05
1 1/4" Flat Cam	CT-D05	\$3.05
1 3/8" Flat Cam	CT-D06	\$3.05
1 1/2" Flat Cam	CT-D07	\$3.05
1 5/8" Flat Cam	CT-D08	\$3.05
1 3/4" Flat Cam	CT-D09	\$3.05
2" Flat Cam	CT-D11	\$3.05
2 1/8" Flat Cam	CT-D12	\$3.05
2 1/2" Flat Cam	CT-D15	\$3.05
3" Flat Cam	CT-D19	\$3.05



H Series Offset Cam, Vertical Tenon

Description	Part Number	Price
1 1/4" Cam with 1/8" offset	CT-H00	\$3.18
1 1/8" Cam with 7/32" offset	CT-H07	\$3.18
1 1/8" Cam with 1/8" offset	CT-H09	\$3.18
1 1/2" Cam with 7/32" offset	CT-H14	\$3.18
1 1/4" Cam with 7/32" offset	CT-H15	\$3.18
1 1/8" Cam with 5/16" offset	CT-H16	\$3.18
1 1/4" Cam with 5/16" offset	CT-H17	\$3.18
1 3/4" Cam with 5/16" offset	CT-H19	\$3.18
2" Cam with 5/16" offset	CT-H20	\$3.18
7/8" Cam with 5/32" offset	CT-H27	\$3.18
1 3/4" Cam with 7/32" offset	CT-H30	\$3.18
1 1/2" Cam with 5/16" offset	CT-H32	\$3.18

(P) = Pinned (combined)

(S) = Sub-assembled (uncombined)

Surcharges for Master Keying, Custom Coining and Custom Stamping apply, see page 202.
Refer to the XT and CLIQ Intelligent Key sections for format availability and pricing.



J Series Offset Cam, Horizontal

Description	Part Number	Price
1 1/8" Cam with 7/32" offset	CT-J01	\$3.18
1" Cam with 1/8" offset	CT-J05	\$3.18
1 1/4" Cam with 1/8" offset	CT-J07	\$3.18
1 5/8" Cam with 1/8" offset	CT-J08	\$3.18
2 1/8" Cam with 1/8" offset	CT-J11	\$3.18
1 1/4" Cam with 7/32" offset	CT-J12	\$3.18
1 1/8" Cam with 5/16" offset	CT-J13	\$3.18
1 1/4" Cam with 5/16" offset	CT-J14	\$3.18
1 5/8" Cam with 5/16" offset	CT-J15	\$3.18
2 1/8" Cam with 5/16" offset	CT-J18	\$3.18
1 1/8" Cam with 5/32" offset	CT-J22	\$3.18
1 1/2" Cam with 5/16" offset	CT-J27	\$3.18
2 1/8" Cam with 7/32" offset	CT-J28	\$3.18
7/8" Cam with 5/32" offset	CT-J29	\$3.18
3/4" Hex nut for cam locks	CP-050060	\$1.56

3/4" Removable Plug Lock

Description	Part Number	M ³	BiLevel	X4	Biax/Orig	KeyMark
1 keypull, 3/4" Removable plug lock	640250T (P)	\$123.10			\$128.28	
	640250T (S)	\$94.10			\$99.28	
2 keypull, 3/4" Removable plug lock	640251T (P)	\$123.10			\$128.28	
	640251T (S)	\$94.10			\$99.28	

1 1/8" Removable Plug Lock

Description	Part Number	M ³	BiLevel	X4	Biax/Orig	KeyMark
1 keypull, vertical flats, flush mount	640550T (P)	\$139.00			\$145.05	
	640550T (S)	\$110.00			\$116.05	
1 keypull, horizontal flats, flush mount	640550AT (P)	\$139.00			\$145.05	
	640550AT (S)	\$110.00			\$116.05	
2 keypull, vertical flats, surface mount with tapered bezel	640550FT (P)	\$139.00			\$145.05	
	640550FT (S)	\$110.00			\$116.05	

Pinned price includes 2 keys.

(P) = Pinned (combined)

(S) = Sub-assembled (uncombined)

Surcharges for Master Keying, Custom Coining and Custom Stamping apply, see page 202.
Refer to the XT and CLIQ Intelligent Key sections for format availability and pricing.

Security Collars

Description	Part Number	Price
Cam lock security collar	CP-070501	\$10.20
Cam lock security collar	CP-070131	\$10.20
Cam lock security collar	CP-070161	\$10.20
Cam lock security collar	CP-070171	\$10.20
Cam lock security collar	CP-070441	\$10.20
Cam lock security collar	CP-070201	\$10.20
Cam lock security collar	CP-070111	\$10.20
Cam lock security collar	CP-070141	\$10.20
Cam lock security collar	CP-070181	\$10.20
Cam lock security collar	CP-070481	\$10.20

Security Collars

Part Number	(H)	(I)	(J)	(K)	(L)
CP-070501	1.000"	.142"	.170"	.312"	1.290"
CP-070131	.885"	.142"	.170"	.312"	1.210"
CP-070161	.885"	.188"	.250"	.438"	1.356"
CP-070171	.885"	.200"	.238"	.438"	1.290"
CP-070441	.885"	.260"	.070"	.330"	1.210"
CP-070201	.885"	.262"	.050"	.312"	1.210"
CP-070111	.885"	.278"	.160"	.438"	1.290"
CP-070141	.885"	.325"	.050"	.375"	1.275"
CP-070181	1.000"	.450"	.050"	.500"	1.250"
CP-070481	1.000"	.638"	.050"	.688"	1.313"

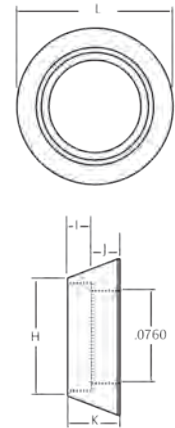

Spacers

Description	Part Number	Price
Cam lock spacer, obtain specific part number from following dimension chart.	CP-160XXX	\$8.72

Spacers

Part Number	(M)	(N)
CP-160051	.125"	.875"
CP-160101	.140"	.875"
CP-160071	.188"	.875"
CP-160111	.200"	.875"
CP-160081	.250"	.875"
CP-160091	.275"	.875"
CP-160301	.375"	.875"
CP-160121	.400"	.875"
CP-160061	.530"	.875"
CP-160271	.437"	.875"
CP-160541	.031"	.875"
CP-160551	.062"	.875"
CP-160571	.312"	.875"
CP-160591	.062"	.995"
CP-160601	.125"	.995"
CP-160611	.250"	.995"

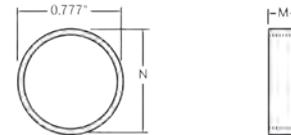

(P) = Pinned (combined)
 (S) = Sub-assembled (uncombined)
 Surcharges for Master Keying, Custom Coining and Custom Stamping apply, see page 202.
 Refer to the XT and CLIQ Intelligent Key sections for format availability and pricing.

Pop-Out, T-Handle Cylinder

Description	Part Number	M ³	BiLevel	X4	Biax/Orig	KeyMark
5 pin, zinc deadbolt	640155CT (P)	\$107.00			\$111.29	
	640155CT (S)	\$78.00			\$82.29	
5 pin, zinc springbolt	640155T (P)	\$107.00			\$111.29	
	640155T (S)	\$78.00			\$82.29	
4 pin, zinc springbolt	640750ET (P)	\$109.00			\$116.40	
	640750ET (S)	\$80.00			\$84.40	
4 pin, zinc deadbolt	640750GT (P)	\$109.00			\$113.40	
	640750GT (S)	\$80.00			\$84.40	
4 pin, steel springbolt	640950T (P)	\$117.30			\$122.16	
	640950T (S)	\$88.30			\$93.16	
4 pin, steel deadbolt	640952T (P)	\$117.30			\$122.16	
	640952T (S)	\$88.30			\$93.16	
4 pin, steel springbolt, steel shell	641050T (P)	\$150.00			\$156.66	
	641050T (S)	\$121.00			\$127.66	
4 pin, steel deadbolt, steel shell	641051T (P)	\$150.00			\$156.66	
	641051T (S)	\$121.00			\$127.66	

Pinned price includes two keys.

(P) = Pinned (combined)

(S) = Sub-assembled (uncombined)

Surcharges for Master Keying, Custom Coining and Custom Stamping apply, see page 202.
Refer to the XT and CLIQ Intelligent Key sections for format availability and pricing.

Cabinet Locks

Medeco® cabinet locks are specifically designed for drawer or cabinet door applications where a conventional utility cam lock may not be suitable. Cabinet locks utilize heavy-duty bolts and multi-point attachment to the mounting surface in order to withstand the heavy use and higher physical security some applications may require. All Medeco cabinet locks feature solid brass and steel construction, available in either fixed or removable core. Patented key programs prevent the unauthorized duplication of keys and maintain system integrity. Keyed alike, keyed different, or master keyed, the Medeco cabinet lock is the perfect solution for your showcase security needs.



Patented Key Control

Protects against unauthorized duplication of your keys.



Available in eCylinder

Medeco cabinet locks are also available with Medeco eCylinders for loss & liability control.



Protection From Physical Attack

Medeco³ cabinet locks are UL 437 Listed and stand up to drilling, picking and other forms of physical attack.

Benefits:

- Medeco high security cabinet locks are constructed of durable machined brass and solid steel components.
- Available in either fixed or removable core depending on your specific requirements.
- Available in either deadbolt or spring latch models.
- Unique elevating and rotating tumbler pin system is virtually pick proof.
- Patented Medeco³ keys may only be duplicated by Medeco or an authorized Medeco service outlet, and only at your request.
- Medeco Cabinet Locks can be keyed in with other 60 Series products.
- Locks can be keyed alike, keyed different, or master keyed depending on your specific needs.

Technical Information:

- Five pin models available in either deadbolt or spring latch versions.
- 7/8 inch diameter, surface mount, fixed or removable core available.
- Deadbolt fixed core available in non-key retaining.
- Keyed alike, keyed different, or master keyed.

Warranty:

Warranted for two (2) years against manufacturer's defects. See the Medeco® limited warranty for full details.

Finishes:

- 26 satin chrome finish standard.
- Other finishes available, depending on volume.

Applications:

- Medeco cabinet locks are specifically designed for use in metal or wooden drawer and cabinet door applications including:
 - Medical and narcotics
 - Chests and cabinets
 - Showcases
 - Cash carts
 - Drawers

Available Key Technologies:

Mechanical:

- Medeco³
- Medeco X4

eCylinder:

- Medeco XT

High Security Cabinet Locks

Description	Part Number	M ³	BiLevel	X4	Biax/Orig	KeyMark
Cabinet lock with deadbolt, single keypull	6210555T (P)	\$157.00				
	6210555T (S)	\$128.00				
Cabinet lock with deadbolt, double keypull	6212555T (P)	\$157.00				
	6212555T (S)	\$128.00				
Cabinet lock with spring bolt, single keypull	6211555T (P)	\$173.00				
	6211555T (S)	\$144.00				
Removable core cabinet lock with deadbolt, single keypull, less plug	6270515	\$85.60				
Removable core cabinet lock with spring bolt, single keypull, less plug	6271515	\$95.40				
Plug for removable plug cabinet lock	66391 (P)	\$96.00				
	66391 (S)	\$67.00				

Pinned price includes two keys.

SFIC Cabinet Locks

Description	Part Number	Price
Cabinet lock with deadbolt for SFIC cylinder. Works with Medeco X4, Medeco XT SFIC, or Best style SFIC. SFIC ordered separately.	3307311	\$71.60
Cabinet lock with spring latch for SFIC cylinder. Works with Medeco X4, Medeco XT SFIC, or Best style SFIC. SFIC ordered separately.	3307321	\$71.60
File Cabinet Lock for SFIC cylinder. Works with Medeco X4, Medeco XT SFIC or Best style SFIC Cylinders . SFIC ordered separately.	3307350	\$71.60
Door/Drawer Lock for SFIC cylinder. Works with Medeco X4, Medeco XT SFIC, or best style SFIC. SFIC ordered separately.	3307331	\$71.60

Traffic Cabinet Locks

Description	Part Number	Price
Traffic Cabinet Lock – Medeco ³ – Deadbolt	490435	\$213.00
Traffic Cabinet Lock – Medeco ³ – Slam Bolt	490436	\$213.00

Note: Available through authorized Medeco service centers only.

Traffic Cabinet Locks are available 26 finish only, MM keyway. Keys are sold separately – KYC 344400 MM 1M.

(P) = Pinned (combined)

(S) = Sub-assembled (uncombined)

Surcharges for Master Keying, Custom Coining and Custom Stamping apply, see page 202.
Refer to the XT and CLIQ Intelligent Key sections for format availability and pricing.

Plunger Locks

Medeco® plunger locks are specifically designed for use in wooden or metal sliding doors. Complete with a spring loaded pop out cylinder, the Medeco plunger lock is ideal for security merchandise showcases, metal cabinets, and laboratory and office furniture. Plunger locks require no key when locking the device; simply push in on the cylinder to relock. Patented key programs prevent the unauthorized duplication of keys and maintain system integrity. Keyed alike, keyed different, or master keyed, the Medeco plunger lock is the perfect solution for your security needs.



Patented Key Control

Protects against unauthorized duplication of your keys.



Can Be Master Keyed

Medeco plunger locks can be keyed alike, keyed different or master keyed.



Protection From Physical Attack

Medeco³ plunger locks are UL 437 Listed and stand up to drilling, picking and other forms of physical attack.

Benefits:

- Medeco plunger locks are constructed of durable machined brass and solid steel components
- Unique elevating and rotating tumbler pin system is virtually pick proof
- Patented Medeco³ keys may only be duplicated by Medeco or an authorized Medeco service outlet, and only at your request
- Medeco plunger locks are completely serviceable, and can be re-keyed in case of lost or stolen keys
- Locks can be keyed alike, keyed different, or master keyed depending on your specific needs

Technical Information:

- Four and five pin models available
- Non-key retaining cylinders
- 45 degree clockwise rotation to unlock
- Keyed alike, keyed different or master keyed

Warranty:

Warranted for two (2) years against manufacturer's defects. See the Medeco limited warranty for full details.

Finishes:

- 26 satin chrome finish standard.
- Other finishes available, depending on volume.

Applications:

- Medeco Plunger Locks are specifically designed for use in metal or wooden sliding door applications including:
 - Jewelry and other merchandise showcases
 - Metal cabinets
 - Laboratory furniture
 - Office furniture

Available Key Technologies:

- | | |
|-----------------------|-------------------|
| Mechanical: | eCylinder: |
| – Medeco ³ | – Classic CLIQ |

Plunger Locks

Description	Part Number	M ³	BiLevel	X4	Biax/Orig	KeyMark
Plunger lock, 5 pin round bolt	6221557T(P)	\$172.00			\$179.87	
	6221557T(S)	\$143.00			\$150.87	
Plunger lock, 5 pin glass mount	6261557T(P)	\$201.00			\$210.46	
	6261557T(S)	\$172.00			\$181.46	
Plunger lock, 4 pin round bolt	6221554T(P)	\$172.00			\$179.87	
	6221554T(S)	\$143.00			\$150.87	

Pinned price includes two keys.

Micro Switch Locks

Medeco's 3/4" diameter, high security switch locks offer a wide range of electrical functions with the physical security and patented key control of a Medeco cylinder. Available in either single or double switch models, Medeco switch locks are ideally suited for applications requiring controlled access to electrically activated systems, including alarms, ATMs, time delay safes, encryption devices, heavy power equipment, control panels and electrically accessed doors and gates. The Medeco³ unique design provides triple locking action, making the locks virtually pick proof. All Medeco³ keys and locks are protected under patent, trademark and copyright laws. Medeco keys may only be duplicated by Medeco or by an authorized Medeco dealer, and only at your request.



Patented Key Control

Protects against unauthorized duplication of your keys.



Can Be Master Keyed

Medeco switch locks can be keyed alike, keyed different or master keyed.



Protection From Physical Attack

Medeco³ switch locks are UL 437 Listed and stand up to drilling, picking and other forms of physical attack.

Benefits:

- All Medeco cylinders are constructed of durable machined brass components, designed to last the life of your equipment.
- Available in single or double switch models, momentary and maintained positions.
- Silver or gold contacts (for low amperage applications) designed to accept quick connect leads.
- Hardened stainless steel inserts inside the cylinder provide the ultimate defense against drilling and other forms of physical attack.
- Unique elevating and rotating tumbler pin system is virtually pick proof.
- Patented Medeco³ keys may only be duplicated by Medeco or an authorized Medeco service outlet, and only at your request.
- Medeco Switch Locks are completely serviceable, and can be re-keyed in case of lost or stolen keys.
- Locks can be keyed alike, keyed different, or master keyed depending on your specific needs.

Certification:

- UL 437 Listed
- Switch - UL Registered, CSA Certified

Applications:

- Medeco High Security Switch Locks can be used in any standard 3/4 inch diameter switch lock application and a multitude of markets including:
 - Heavy Power Machinery
 - Time Delay Safes
 - Material Handling Equipment
 - Construction Vehicles
 - Electrically Accessed Gates
 - Cash Control Systems
 - Encryption Devices
 - Alarms
 - Control Panels
 - ATMs

Warranty:

Warranted for two (2) years against manufacturer's defects. See the Medeco® limited warranty for full details.

Technical Information:

- Five pin, 3/4 inch double "D" mounting standard.
- Available in either single or double switch models with either silver or gold contacts.
- Rated at 7 amps resistive at 125/250 VAC.
- Contacts designed to accept quick connect leads (AMP connector number 60598-3)

Finishes:

- 26 satin chrome finish standard.
- Other finishes available, depending on volume.

Available Key Technologies:

Mechanical:

– Medeco³

Single Switch Locks

Description	Part Number	M ³	BiLevel	X4	Biax/Orig	KeyMark
1 switch, Maintained 1 Keypull	652150T 011 (P)	\$146.00			\$152.44	
	652150T 011 (S)	\$117.00			\$123.44	
1 switch, Maintained 2 Keypull	652150T 012 (P)	\$146.00			\$152.44	
	652150T 012 (S)	\$117.00			\$123.44	
1 switch, Momentary 1 Keypull	652150T 021 (P)	\$146.00			\$152.44	
	652150T 021 (S)	\$117.00			\$123.44	

Pinned price includes two keys.

Double Switch Locks

Description	Part Number	M ³	BiLevel	X4	Biax/Orig	KeyMark
2 position, maintained, 1 keypull	652650T 101 (P)	\$235.00			\$246.33	
	652650T 101 (S)	\$206.00			\$217.33	
2 position, maintained, 2 keypull	652650T 102 (P)	\$235.00			\$246.33	
	652650T 102 (S)	\$206.00			\$217.33	
2 position, momentary, 1 keypull	652650T 111 (P)	\$235.00			\$246.33	
	652650T 111 (S)	\$206.00			\$217.33	
3 position, maintained, 1 keypull	652650T 131 (P)	\$235.00			\$246.33	
	652650T 131 (S)	\$206.00			\$217.33	
3 position, maintained, 2 keypull	652650T 132 (P)	\$235.00			\$246.33	
	652650T 132 (S)	\$206.00			\$217.33	
3 position, maintained, 3 keypull	652650T 133 (P)	\$235.00			\$246.33	
	652650T 133 (S)	\$206.00			\$217.33	

Pinned price includes two keys.

Switch Lock Accessories for 652150 and 652650

Description	Part Number	Price
Silver Sub Miniature Snap Action Switch. Double Pole/Double Throw	CP-150082	\$64.00
Gold Sub Miniature Snap Action Switch. Double Pole/Double Throw	CP-150102	\$85.00
Sleeve Kit. Includes chrome plated zinc sleeve with rubber grommet, plain washer, 1 pronged washer locks for mounting cam locks in harsh environments.	650003	\$47.40
Silver Sub Miniature Snap Action Switch. Single Pole-Single or Double Throw	CP-150142	\$32.30
Gold Sub Miniature Snap Action Switch. Single Pole-Single or Double Throw	CP-150152	\$46.10
4" Leadwire	CP-270511	\$2.24
6" Leadwire	CP-270521	\$2.59
12" Leadwire	CP-270531	\$3.29
18" Leadwire	CP-270541	\$4.12
24" Leadwire	CP-270551	\$8.83
36" Leadwire	CP-270561	\$8.83
3/4" hex nut for switch locks	CP-050050	\$3.05

(P) = Pinned (combined)

(S) = Sub-assembled (uncombined)

Surcharges for Master Keying, Custom Coining and Custom Stamping apply, see page 202.
Refer to the XT and CLIQ Intelligent Key sections for format availability and pricing.

Rotary Switch Locks

The Medeco® rotary switch lock is designed for use with most brands of rotary switches, providing maximum versatility in systems requiring multiple switch functions. Switch locks are available with a variety of key withdrawals at 45° increments. Positive stops are available to eliminate over-torquing of switch stops. Switch locks use a five pin cylinder to maximize keyed different and master keying capabilities. Medeco design and engineering resources are available to assist customers with special functional requirements. The Medeco³ unique design provides triple locking action, making the locks virtually pick proof. All Medeco³ keys and locks are protected under patent, trademark and copyright laws. Medeco³ keys may only be duplicated by Medeco or by an authorized Medeco dealer, and only at your request.



Patented Key Control

Protects against unauthorized duplication of your keys.



Available in eCylinder

Medeco cabinet locks are also available with Medeco eCylinders for loss & liability control.



Can Be Master Keyed

Medeco switch locks can be keyed alike, keyed different or master keyed.



Protection From Physical Attack

Medeco³ switch locks stand up to drilling, picking and other forms of physical attack.

Benefits:

- All Medeco cylinders are constructed of durable machined brass components, designed to last the life of your equipment.
- Hardened stainless steel inserts inside the cylinder provide the ultimate defense against drilling and other forms of physical attack.
- Unique elevating and rotating tumbler pin system is virtually pick proof.
- Patented Medeco³ keys may only be duplicated by Medeco or an authorized Medeco service outlet, and only at your request.
- Medeco switch locks are completely serviceable, and can be re-keyed in case of lost or stolen keys.
- Locks can be keyed alike, keyed different, or master keyed depending on your specific needs.

Warranty:

Warranted for two (2) years against manufacturer's defects. See the Medeco limited warranty for full details.

Technical Information:

- Five pin, 3/4 inch double "D" mounting standard.

Finishes:

- 26 satin chrome finish standard.
- Other finishes available, depending on volume.

Certification:

- Switch - UL Registered, CSA Certified

Applications:

- Medeco Rotary Switch Locks can be used to retrofit many switch lock applications including:
 - Heavy Power Machinery
 - Time Delay Safes
 - Material Handline Equipment
 - Construction Vehicles
 - Electrically Accessed Gates
 - Cash Control Systems
 - Encryption Devices
 - Alarms
 - Control Panels
 - ATMs

Available Key Technologies:

Mechanical:

– Medeco³

eCylinder:

– Medeco XT

Double Switch Rotary

Description	Part Number	M ³	BiLevel	X4	Biax/Orig	KeyMark
2 position, 1 keypull A, maintained at B	6522560T 121 (P)	\$143.00			\$149.27	
	6522560T 121 (S)	\$114.00			\$120.27	
2 position, 2 keypull A&B, maintained	6522560T 122 (P)	\$143.00			\$149.27	
	6522560T 122 (S)	\$114.00			\$120.27	
3 position, 2 keypull A&B, maintained	6522560T 132 (P)	\$143.00			\$149.27	
	6522560T 132 (S)	\$114.00			\$120.27	
3 position, 3 keypull A, B&C, maintained	6522560T 133 (P)	\$143.00			\$149.27	
	6522560T 133 (S)	\$114.00			\$120.27	
3 position, 2 keypull A&C, maintained at B	6522560T 134 (P)	\$143.00			\$149.27	
	6522560T 134 (S)	\$114.00			\$120.27	
2 position, 1 keypull A, momentary at B	6522560T 221 (P)	\$143.00			\$149.27	
	6522560T 221 (S)	\$114.00			\$120.27	

Pinned price includes two keys.

(P) = Pinned (combined)

(S) = Sub-assembled (uncombined)

Surcharges for Master Keying, Custom Coining and Custom Stamping apply, see page 202.
Refer to the XT and CLIQ Intelligent Key sections for format availability and pricing.

Keying Charges

Description	Part Number	Price
Less Key Credit		\$1.00
MK surcharge to pinned door hardware cylinders and IC cylinders except SFIC cylinders.		\$20.00
No MK surcharge is applied to the pinned cylinder price for Medeco X4 SFIC cylinders.		
MK surcharge to pinned cam lock type product (less keys)		\$4.15
Key Stamping (Standard Key Code Stamping at No Charge)		\$3.25
Lock Stamping (No charge for SFIC)		\$7.70
Surcharge - Medeco X4 Custom Coined Cut keys require a minimum of 100 keys and must be specified on the order. Non-custom coined cut keys are standard from the factory. The surcharge is added to the cut key price.		\$2.50
Surcharge - High Security Custom Coined Cut keys require a minimum of 100 keys and must be specified on the order. Non-custom coined cut keys are standard from the factory. The surcharge is added to the cut key price.		\$2.50
Sub-assembled deduct applied for door products		\$14.00
Sub-assembled deduct applied for Medeco X4 SFIC		\$14.00
Sub-assembled deduct applied for 60 Series products		\$29.00
Non-Masterkeyed cylinders (less keys)	RE-KEY	\$58.10
Masterkeyed Cylinders (5 and 6 pin, less keys)	RE-KEY-MK	\$69.70
Decode Key Service	DE-CODE-KEY	\$36.10
Decode Lock Service (not available for padlocks)	DE-CODE-LOK	\$36.70
Sharpen Cutter for Medeco ³ and Medeco X4 (exchange program; old cutter must be returned upon receipt with RGA)	KM-SHARP-CUT	\$225.00

Cut Keys

Description	Part Number	Price
Medeco 4 Large Bow Cut Keys	KYC 4LX600 XX XX XXX	\$22.50
Medeco 4 Small Bow Cut Keys	KYC 4SX600 XX XX XXX	\$22.50
Medeco 4 Custom Coined Cut Keys - Large Bow*	KYC 4LX600 XX 99 XXX	\$25.75
Medeco 4 Custom Coined Cut Keys - Small Bow*	KYC 4SX600 XX 99 XXX	\$25.75
Original, Biaxial and M3 Custom Coined Cut Keys*	KYC XX5600 XX 99	\$24.75
Original, Biaxial and M3 Cut Keys	KYC XX6600 XX XX	\$21.50
Medeco X4 Custom Coined Cut Keys*	KYC XX6900 XXX 99	\$22.55
Medeco X4 Cut Keys	KYC XX6900 XXX XX	\$19.30
Medeco B Cut Keys, A5 Bow	KYC A50000 AXX 00	\$13.69
Medeco B Cut Keys, A6 Bow	KYC A60000 AXX 00	\$15.50

* Minimum order 100 Custom Coined Cut Keys.

Contact Customer Service for specific part number.

Coining Dies

Description	Part Number	Price
Standard Coining Die-All keyway technologies	CN-DIES	\$596.00 (NET)
Laser Die	ST-LASER	\$144.00 (NET)

Key Code Cards

Description	Part Number	Price
Authorization Card for 6 Pin Key (Patriot, Liberty, Freedom, Gotham)	CARD 1 X XX	\$13.90
Authorization Card for 5 Pin Key (Patriot, Liberty, Freedom, Gotham)	CARD 2 X XX	\$13.90
Authorization Card for 5 Pin (60Series) Key (Patriot, Liberty, Freedom, Gotham)	CARD 6 X XX	\$13.90
Authorization Card with (2) 6 Pin Keys (Medeco KM Silver)	CARD KS XX 8E	\$43.00
Authorization Card with (2) 5 Pin Keys (Patriot, Liberty, GLD, DND, Freedom, Gotham)	CARD XX 56 XX	\$43.00
Authorization Card with (2) 6 Pin Keys (Patriot, Liberty, GLD, DND, Freedom, Gotham)	CARD XX 66 XX	\$43.00
Printed Key Code Tag For Dealer Keyways	CP-286131	\$1.17

Code Books, Vouchers, & Paper

Description	Part Number	Price
Medeco ³ , Medeco 4, Medeco3 & Biaxial Code Book	CB-CODE-BIA	\$48.00 (NET)
Medeco Original Code Book	CB-CODE-BOK	\$48.00 (NET)
Patriot/Liberty/Freedom/Gotham USB card reader	94-0309	\$78.10 (NET)

Sales Tools

Description	Part Number	Price
Smart SFIC Solutions Demo Kit (Includes Arrow, Medeco X4, and Medeco XT SFIC Cylinders)	94-0261	\$1,521.00
Medeco ³ Display Kit Includes Captive T-Turn Deadbolt Cut-away Cylinder, Cam Lock	94-0204	\$237.00 (NET)
Medeco X4 Presentation Kit includes: Std. Rim & Mortise Cylinders, SFIC Mortise, Key-In-Knob Cylinder, all LFIC cylinders in plastic case	94-0269	\$325.00 (NET)
6 Pin Medeco ³ BiLevel Cut-Away Cylinder	10400 CUT J	\$112.70 (NET)
6 Pin Medeco ³ Cut-Away Cylinder	10400 CUT T	\$192.00 (NET)
Cut-Away 5 Pin Profile Cylinder	23130 CUT	\$193.00 (NET)
Cut-Away Cam Lock Assembly – Biaxial only	600300 CUT W 219	\$96.39 (NET)
Plastic Display Sleeve for Maxum (lock not included)	90-0028	\$21.00 (NET)
XT Install/Demo Key (works cylinders not yet programmed to a system) – Industrial Style	EA-100111	\$269.00
XT Install/Demo Control Key (works IC cylinders not yet programmed to a system) – Industrial Style	EA-100110	\$269.00
XT Install/Demo Key – Slim Line (works cylinders not yet programmed to a system)	EA-100173	\$258.00
XT Install/Demo Control Key – Slim Line (works IC Cylinders not yet programmed to a system)	EA-100174	\$258.00

Keyblanks for Cam Lock Style - Original, Biaxial, Medeco³

Description	Part Number	Price
5 Pin Commercial Original Keyblank for 60 Series, Thick Head (Non Custom Coined)	KYB 115400 XX 00	\$10.40
5 Pin Commercial Original Keyblank for 60 Series, Thin Head (Non Custom Coined)	KYB 105400 XX 00	\$10.40
5 Pin Commercial Medeco Biaxial Keyblank for 60 Series, Thick Head (Non Custom Coined)	KYB 115400 S6 43	\$10.40
5 Pin Keyblank for 60 Series (Custom Coined)	KYB XX5400 XX 99	\$10.40

Keyblanks for Door Hardware - Original, Biaxial, Medeco³, Medeco 4

Description	Part Number	Price
5 or 6 Pin Keyblank for Medeco 4 (Large Bow, Custom Coined)	KYB 4LX600 XX 99 XXX	\$11.10
5 or 6 Pin Keyblank for Medeco 4 (Small Bow, Custom Coined)	KYB 4SX600 XX 99 XXX	\$11.10
5 or 6 Pin Keyblank Round Bow (Non Custom Coined)	KYB 10X600 XX XX	\$10.40
5 or 6 Pin Keyblank for Medeco ³ (Small Bow, Custom Coined)	KYB 34X600 XX 99	\$10.10
5 or 6 Pin Keyblank for Medeco ³ (Large Bow, Custom Coined)	KYB 33X600 XX 99	\$10.10
5 or 6 Pin Keyblank for Medeco Biaxial Rectangular (Small Bow, Custom Coined)	KYB 12X600 XX 99	\$10.10
5 or 6 Pin Keyblank for Medeco Biaxial, Square (Large Bow, Custom Coined)	KYB 17X600 XX 99	\$10.10
5 or 6 Pin Keyblank for Thumbturn (blade only)	KYB 10X605 XX	\$13.11

Keyblanks for Door Hardware - Medeco KM, Medeco X4 & Medeco B

Description	Part Number	Price
6 or 7 Pin Keyblank for Medeco KM (Small Bow, Custom Coined)	KYB 32X600 XX 99	\$9.60
6 or 7 Pin Keyblank for Medeco KM (Large Bow, Custom Coined)	KYB 38X600 XX 99	\$9.60
6 or 7 Pin Keyblank for Medeco X4 (Small Bow, Custom Coined)	KYB 32X900 XX 99	\$9.60
6 or 7 Pin Keyblank for Medeco X4 (Large Bow, Custom Coined)	KYB 38X900 XX 99	\$9.60
6 or 7 Pin Keyblank for Medeco B, Alphabet & T Keyways	KYB A50000-AXX00	\$2.59
6 or 7 Pin Keyblank for Medeco B, W Family Keyways	KYB A60000-AXX00	\$4.40

Keys with Hybrid Heads – 125 kHz Proximity

Description	Part Number	Price
Original/Biaxial heads only	EA-300069-01-EL	\$22.00
Medeco ³ /Medeco X4, Medeco KM Heads only	EA-300070-01-EL	\$22.00
Medeco X4, Medeco KM/Medeco ³ dimpled blade	KYB 77663F NM XX	\$29.42
Original/Biaxial dimpled blade	KYB 74563F NM XX	\$29.42
5 pin Medeco ³ key blank	KYB 35563P XX 99	\$29.42
6 pin Medeco ³ key blank	KYB 35663P XX 99	\$29.42
5 pin Original/Biaxial key blank	KYB 74563P XX 99	\$29.42
6 pin Original/Biaxial key blank	KYB 74663P XX 99	\$29.42
6 pin Medeco KM key blank	KYB 77663P XX 99	\$28.92
7 pin Medeco KM key blank	KYB 77763P XX 99	\$28.92
6 pin Medeco X4 key blank	KYB 77693P XXX 99	\$28.92
7 pin Medeco X4 key blank	KYB 77793P XXX 99	\$28.92
5 pin Medeco ³ cut key	KYC 35563P XX 99	\$44.07
6 pin Medeco ³ cut key	KYC 35663P XX 99	\$44.07
5 pin Original/Biaxial cut key	KYC 74563P XX 99	\$44.07
6 pin Original/Biaxial cut key	KYC 74663P XX 99	\$44.07
6 pin Medeco KM cut key	KYC 77663P XX 99	\$41.87
7 pin Medeco KM cut key	KYC 77763P XX 99	\$41.87
6 pin Medeco X4 cut key	KYC 77693P XXX 99	\$41.87
7 pin Medeco X4 cut key	KYC 77793P XXX 99	\$41.87

Stamping is required on all restricted keyblanks .
Please see the eCylinder section for eCylinder key information.

Keys with Hybrid 2k Bit Heads – 13.56 MHz iCLASS

Description	Part Number	Price
Original/Biaxial heads only	EA-300086-01-EL	\$27.40
Medeco ³ /Medeco X4 Heads only	EA-300087-01-EL	\$27.40
Original/Biaxial dimpled blade	KYB 74563H NM XX	\$33.49
Medeco X4/Medeco ³ dimpled blade	KYB 77663H NM XX	\$33.49
5 pin Medeco ³ key blank	KYB 35563K XX 99	\$33.49
6 pin Medeco ³ key blank	KYB 35663K XX 99	\$33.49
5 pin Original/Biaxial key blank	KYB 74563K XX 99	\$33.49
6 pin Original/Biaxial key blank	KYB 74663K XX 99	\$33.49
5 pin Medeco ³ cut key	KYC 35563K XX 99	\$48.14
6 pin Medeco ³ cut key	KYC 35663K XX 99	\$48.14
5 pin Original/Biaxial cut key	KYC 74563K XX 99	\$48.14
6 pin Original/Biaxial cut key	KYC 74663K XX 99	\$48.14

Stamping is required on all restricted keyblanks.

Keys with Hybrid 16k Bit Heads – 13.56 MHz iCLASS

Description	Part Number	Price
Original/Biaxial heads only	EA-300088-01-EL	\$38.40
Medeco ³ /Medeco X4 heads only	EA-300089-01-EL	\$38.40
Original/Biaxial dimpled blade	KYB 74563N NM XX	\$43.26
Medeco X4/Medeco ³ dimpled blade	KYB 77663N NM XX	\$43.26
5 pin Medeco ³ key blank	KYB 35563J XX 99	\$43.26
6 pin Medeco ³ key blank	KYB 35663J XX 99	\$57.91
5 pin Original/Biaxial key blank	KYB 74563J XX 99	\$57.91
6 pin Original/Biaxial key blank	KYB 74663J XX 99	\$43.26
5 pin Medeco ³ cut key	KYC 35563J XX 99	\$57.91
6 pin Medeco ³ cut key	KYC 35663J XX 99	\$57.91
5 pin Original/Biaxial cut key	KYC 74563J XX 99	\$57.91
6 pin Original/Biaxial cut key	KYC 74663J XX 99	\$57.91

Stamping is required on all restricted keyblanks.

Hybrid Dummy heads only

Description	Part Number	Price
Original/Biaxial (25 pack)	CP-286531-25-EL	\$64.70
Medeco X4/Medeco ³ (25 pack)	CP-286541-25-EL	\$64.70

Hybrid Dummy heads with key blanks

Description	Part Number	Price
5 pin Medeco ³	KYB 355640 XX 99	\$11.51
6 pin Medeco ³	KYB 356640 XX 99	\$11.51
5 pin Original/Biaxial	KYB 745640 XX 99	\$11.51
6 pin Original/Biaxial	KYB 746640 XX 99	\$11.51
6 pin Medeco KM	KYB 776640 XX 99	\$11.01
7 pin Medeco KM	KYB 777640 XX 99	\$11.01
6 pin Medeco X4 key blank	KYB 776940 XXX 99	\$11.01
7 pin Medeco X4 key blank	KYB 777940 XXX 99	\$11.01

Stamping is required on all restricted key blanks.

Hybrid Dummy heads with cut keys

Description	Part Number	Price
5 pin Medeco ³	KYC 355640 XX 99	\$26.16
6 pin Medeco ³	KYC 356640 XX 99	\$24.75
5 pin Original/Biaxial	KYC 745640 XX 99	\$26.16
6 pin Original/Biaxial	KYC 746640 XX 99	\$26.16
6 pin Medeco KM	KYC 776640 XX 99	\$23.96
7 pin Medeco KM	KYC 777640 XX 99	\$23.96
6 pin Medeco X4 cut key	KYC 776940 XXX 99	\$23.96
7 pin Medeco X4 cut key	KYC 777940 XXX 99	\$23.96

Hybrid Blades only, no heads, key blanks

Description	Part Number	Price
5 pin Medeco ³	KYB 355600 XX 99	\$10.10
6 pin Medeco ³	KYB 356600 XX 99	\$10.10
5 pin Original/Biaxial	KYB 745600 XX 99	\$10.10
6 pin Original/Biaxial	KYB 746600 XX 99	\$10.10
6 pin Medeco KM	KYB 776600 XX 99	\$9.60
7 pin Medeco KM	KYB 777600 XX 99	\$9.60
6 pin Medeco X4 key blank	KYB 776900 XXX 99	\$9.60
7 pin Medeco X4 key blank	KYB 777900 XXX 99	\$11.01

Stamping is required on all restricted key blanks.

Hybrid Blades only, no heads, cut keys

Description	Part Number	Price
5 pin Medeco ³	KYC 355600 XX 99	\$24.75
6 pin Medeco ³	KYC 356600 XX 99	\$24.75
5 pin Original/Biaxial	KYC 745600 XX 99	\$24.75
6 pin Original/Biaxial	KYC 746600 XX 99	\$24.75
6 pin Medeco KM	KYC 776600 XX 99	\$22.55
7 pin Medeco KM	KYC 777600 XX 99	\$22.55
6 pin Medeco X4 cut key	KYC 776900 XXX 99	\$22.55
7 pin Medeco X4 cut key	KYC 777900 XXX 99	\$22.55

Medeco 4/Medeco³/Biaxial Door Hardware Pin Kits

Description	Part Number	Price
Medeco 4 Side Pin Kit. 30 each of Bottom and Master Pins and 100 Springs.	KH-5701	\$535.00
Medeco 4 Distributor Pin Kit. 100 each of 0-3 Combination Pins.	KH-5702	\$960.00
Medeco Biaxial 10 through 50 Series broached and milled pin combination (Door Hardware), Large Metal Box, 30 Each of Bottom, Master, Top Pins	.KW5005	\$1,060.00
Medeco Biaxial 10 Through 50 Series (Door Hardware), Large Metal Box, 100 Each of Bottom, Master, & Top Pins	.KW5006	\$2,315.00
Medeco Biaxial 10 Through 50 Series (Door Hardware), Small Metal Box, 10 Each of Bottom, Master & Top Pins	.KW5007	\$796.00
Medeco Biaxial Pin Kit with 30 ea. 53 Series (broached) Pins for Biaxial Cylinders with Sidebars Manufactured Prior to 2/2003	.KW5011	\$1,060.00
Medeco Biaxial Pin Kit with 100 ea. 53 Series (broached) Pins for Biaxial Cylinders with Sidebars Manufactured Prior to 2/2003	.KW5012	\$2,315.00
Medeco Biaxial Pin Kit for 32 Series LFIC Cylinders. 4, 5, and 6 Pins Only with 50 each 53 Series Pins	.KW5010	\$527.00
Medeco Biaxial/Medeco ³ Pin Kit for Medeco ³ CLIQ	.KW5401	\$799.00

Medeco³/Biaxial Cam and Switch Lock Pin Kits

Description	Part Number	Price
Medeco Biaxial 60 Series (Cam & Switch locks), 100 Each of Bottom Pins (Top Pins Not Used)	.K-9001	\$1,459.00
Medeco Biaxial 60 Series (Cam & Switch Locks), Small Metal Box, 10 Each of Bottom Pins (Top Pins Not Used)	.KW9003	\$467.00

Medeco³ BiLevel Pin Kits

Description	Part Number	Price
Medeco ³ BiLevel Pin Kit (100 ea. BiLevel Top & Bottom Pins)	.KJ1501	\$928.00

Medeco KM and X4 Pin Kits (Available in USA and Canada)

Description	Part Number	Price
Medeco KM and X4 Pin Kit for SFIC; Large Wood Kit, 100 Each Bottom and Master/Top Pins. Springs, Caps, Spring Covers, Set Screws, Pinning Fixture, Capping Punch, Pin Ejector and Key Gauge Included.	.K-4001	\$1,235.00
Medeco KM and X4 mini Pin Kit for SFIC; Small Metal Pin Kit, 30 Each Bottom Pins, 60 Each Master/Top Pins. Springs, Caps, and Spring Covers included.	.K-4002	\$301.00
Medeco X4 Pin Kit for Conventional Cylinders (.511 plug), not SFIC; 100 Each Bottom and Master/Top Pins. Springs, Spring Covers, Set Screws, and Key Gauge included.	.K-4006	\$897.00

Medeco KM and X4 Pin Kits (Available in Canada Only)

Description	Part Number	Price
Medeco KM Pin Kit; (Classic Only) Large Wooden Pin Kit, 100 Each Bottom, Master & Top Pins. Spring, Caps, Spring Covers, Set Screws, Pinning Fixture, Capping Punch, Pin Ejector & Key Gauge also included	K-4003	\$1,273.00
Medeco KM Mini Pin Kit; (Classic Only) Small Metal Pin Kit, 30 Bottom Pins, 60 Each of Master & Top Pins, Springs, Caps, Spring Covers, & Set Screws also included.	K-4004	\$309.00

Contact Factory for LFIC Pinning Requirements.

Medeco Original Door Hardware Pin Kits

Description	Part Number	Price
Medeco Original Door Hardware Pins, Full Step, Metal Box, 30 Ea. of Bottom & Top Pins	.K-1001	\$480.00
Medeco Original Door Hardware Pins, Full Step, Metal Box, 100 Ea. of Bottom & Top Pins	.K-1002	\$1,403.00
Medeco Original Door Hardware Pins, Full Step, Plastic Box, 100 Ea. of Master Pins #1 - #5 Only	.K-1003	\$103.00
Medeco Original Door Hardware Pins, Small Metal Box, 10 Ea. of Bottom, Master, & Top Pins	.K-1005	\$478.00
Medeco Original Door Hardware Pins, 1/2 Step, Large Metal Box, 100 Ea. of Bottom, Master & Top Pins	.K-1006	\$2,322.00

Medeco Original Cam & Switch Lock Pin Kits

Description	Part Number	Price
Medeco Original Cam & Switch Type Pins, Full Step, Plastic Box, 100 Ea. of Bottom Pins (Top Pins Not Used)	.K-6001	\$1,163.00
Medeco Original Cam & Switch Style Pins, Full Step, Plastic Box, 100 Ea. of Master Pins (Top Pins Not Used)	.K-6002	\$1,359.00

Pins (Sold in bags of 100)

Description	Part Number	Price
Medeco 4 Side Combination pin, 1-3, (qty of 10 per pack)	TP-F57-X	\$2.09
Medeco 4 Side Master Pin, 4-5, (qty of 10 per pack)	TP-F57-X	\$2.09
Medeco 4 Side Lift Pin, 0, (qty of 10 per pack)	TP-F57-0	\$2.09
Medeco Original Bottom Pins (.030" increment)	TP-F10-XX	\$1.28
Medeco Original Master Wafers (.030" increment)	TP-F10-XW	\$0.47
Mushroom driver	TP-F10-3M	\$0.82
Standard Driver	TP-F10-XT	\$0.49
Medeco ³ /Biaxial Bottom Pins (.025" increment)	TP-F50-XX	\$1.28
Medeco ³ /Biaxial Master Wafers (.025 increment)	TP-F50-XW	\$0.47
Original 60 Series Pins	TP-F60-XX	\$1.28
Medeco ³ /Biaxial 60 Series Pins (.025 increment)	TP-F90-XX	\$1.28
Medeco KM and X4 Bottom Pins, #0B-9B (qty of 100 pack) Note: Medeco X4 SFIC only	TP-K40-XX-BH	\$13.30
Medeco KM and X4 Top Pins #02-19T (qty of 100 in pack)	TP-K40-XX-TH	\$12.00
Medeco X4 Bottom Pins for Conventional Cylinders #00-09 (qty of 100 in pack)	TP-K43-XX-BH	\$19.40
Medeco BiLevel Top Pins	TP-F15-XT	\$0.48
Medeco BiLevel Bottom Pins (.025 increment)	TP-F15-XB	\$0.61
Medeco ³ /Medeco Biaxial Broached Bottom Pins (.025" increment)	TP-F53-XX	\$1.28
KM Offset Top Pin	TP-K42-Z9	\$1.28

Caps (Sold in bags of 100)

Description	Part Number	Price
Medeco X4 I/C Pin Spring Caps (Stamped) (for rekeying)	CP-170430	\$6.34
Medeco X4 I/C Pin Spring Caps (Machined) (for new cylinder)	CP-170440	\$6.34
Spring Covers for Medeco LFIC, Corbin (7 pin) LFIC, and Yale LFIC (6 and 7 pin), Brass, 1.010" Length	CP-170011	\$0.59
5 Pin Spring Covers for Medeco 32 Series I/C, Cam and Switch Lock Plugs, Brass, .840" Length	CP-170021	\$0.41
3 Pin Spring Covers for Cam and Switch Lock Plugs, Brass, .500" Length	CP-170031	\$0.59
4 Pin Spring Covers for Cam and Switch Lock Plugs, Brass, .670" Length	CP-170041	\$0.59
6 Pin Spring Covers for Medeco and Medeco X4 20 Series Key-in-Knob Cyls (Old Style), Schlage LFIC, Stainless Steel, .980" Length	CP-170051	\$0.59
5 Pin Spring Covers for Medeco 20 Series Key-in-Knob Cyls (Old Style), Stainless Steel, .810" Length	CP-170061	\$0.59
6 Pin Spring Covers for Medeco ³ 32*0202 Removable Cylinder for 50 Series Brass Body Padlocks, Brass, 1.010" Length (Notch in cover for steel ball bearing retainer)	CP-170271	\$0.59
6 Pin Spring Covers for Medeco & Medeco X4 20 Series Key-in-Knob Cylinders & Medeco X4 Schlage Style LFIC	CP-170730-6	\$0.67
5 Pin Spring Covers for Medeco 20 Series Key-in-Knob Cylinders	CP-170730-5	\$0.67
6 Pin Spring Cover for Corbin and Sargent LFIC	CP-170481	\$0.50

Springs (Sold in bags of 100)

Description	Part Number	Price
Tumbler Springs, 10 Series Door Hardware	CP-030001	\$0.10
Tumbler Springs, 60 Series Cam & Switch Locks	CP-030017	\$0.10
Sidebar Springs	CP-030018	\$0.10
Tumbler Springs, 32 Series (stainless steel)	CP-030042	\$0.11
Medeco ³ Slider Springs	CP-030910	\$0.11
Medeco X4 Springs (Bag of 300)	CP-030590	\$20.40
Medeco 4 Side Pin Springs	CP-031560	\$0.11

Screws (Sold in bags of 100)

Description	Part Number	Price
#2-56 x 3/16" Flat Head Cam Screw for 10-0100 Cylinder	CP-010203-030	\$0.25
#2-56 x 1/4" Flat Head Screw for 32 Series I/C Housing	CP-010103-040	\$0.69
#2-56 x 5/16" Flat Head Phillips, Nylon Patch Cam Screw for Mortise Cylinders	CP-010203-050	\$0.25
#2-56 x 1/4" Pan Head Screw for 20-0901 and Other Lazy Motion Retainers	CP-010503-040	\$0.38
#8-32 x 1/8" Allen Set Screw Cone for Pin Chambers (10 Series Rim & Mortise)	CP-011013-020	\$0.31
#8-32 x 1/4" Allen Set Screw Cone for Pin Chambers (23 Series Profile Cylinders)	CP-011013-040	\$0.43
Set Screw for non-I/C Medeco X4 Rim & Mortise Cylinders	CP-011011-020	\$0.26

Misc. Components

Description	Part Number	Price
Medeco 4 Sidebar - 5 pin	CP-0845A0	\$10.40
Medeco 4 Sidebar - 6 pin	CP-0846A0	\$10.40
5 Pin Sidebar Assembly .123" for Door Hardware Cylinders	CP-084571	\$8.49
6 Pin Sidebar Assembly .123" for Door Hardware Cylinders	CP-084671	\$8.49
Medeco ³ Slider and Spring Package	94-0174-XX	\$14.10
Medeco BiLevel Slider and Spring Package	94-0227-XX	\$14.10
Medeco X4 Conventional Slider and Spring Package	94-0255-XX	\$14.10
Medeco X4 SFIC Slider and Spring Package	94-0256-XX	\$14.10
Medeco X4 Conventional Locking Pin	CP-064231	\$4.82
Medeco X4 Conventional Locking Pin Spring (Pack of 100)	CP-031170	\$0.37
Medeco X4 SFIC Locking Pin	CP-064701	\$4.82
Medeco X4 SFIC Locking Pin Spring (Pack of 100)	CP-031480	\$0.37

Cam & Tailpiece Kit

Description	Part Number	Price
10 and 20 Series Tailpieces (Plastic Box, Assorted Cams and Tailpieces for 10 & 20 Series) Includes: CT-Y02, CT-Y08, CT-Y24, CTY32, CT-Y49, CT-Y52, CT-Y53, CT-Z00, CT-Z01, CT-Z02, CT-Z04, CT-Z06, CT-Z07, CT-Z08, CTZ09, CT-Z16	.K-1099	\$643.00







Empty Pin Boxes - Any Technology

Description	Part Number	Price
Large Latched Metal Pin Box (Empty) 60 Assorted Size Compartments. Overall Measurements 1.875" Deep, 13.56" wide, 9.75 front to back.	CP-282460	\$258.00
Small Latched Metal Pin Box (Empty) 67 Assorted Size Compartments, Overall .688" Deep, 8.876" Wide, 5.875" Front to Back	CP-282470	\$155.00

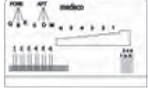
Pin Hole Covers for 60 Series (sold in bags of 100)

Description	Part Number	Price
5 Pin, Pin Hole Covers-Brass	CP-170021	\$0.41
4 Pin, Pin Hole Covers-Brass	CP-170041	\$0.59
3 Pin, Pin Hole Covers-Brass	CP-170031	\$0.59

Tools & Fixtures

Description	Part Number	Price
Spanner Wrench for Rim Cylinder Tailpiece Nut	90-0001	\$3.85
 Medeco 4/Universal Key Gauge/Decoder	94-0323	\$38.00
Installation Tool for Key-in-Knob capping	94-0207	\$2.10 (NET)
 5 Pin Staking Tool, 60 Series Cam/ Switch Locks and 32 Series LFIC	CP-282430	\$143.00
 Holding Block Assembly (use with 10, 20, 32, & 60 Series Cylinders)	CP-282451	\$1,033.00
 Switch Lock Tool (Facilitates spring insertion on momentary function)	T-7155	\$31.70
 Medeco X4 I/C Pinning Block (6 or 7 Pin)	CP-282500	\$215.00
 Medeco X4 I/C Pin Ejector	CP-282530	\$52.70
 Medeco X4 I/C Hand Capping Punch	CP-282540	\$34.10
Medeco X4 Key Decoder	CP-286350	\$39.00
Sargent LFIC (X4 and M3 cores primarily for pre 2008 housings) Shear tool	CP-286851	\$275.00 (NET)
Corbin (For M3 cores) LFIC Shear tool	CP-287371	\$275.00 (NET)

Lubricants

Description	Part Number	Price
Fluid Film (2.25oz.) Spray	PX-KYLUBE-02	\$20.60
Fluid Film (11.75oz.) Spray	PX-KYLUBE-11	\$32.80

Key Machines

Description	Part Number	Price
Key Machine, Original, 115V	95-M11000	\$14,706.00
Key Machine, Biaxial, 115V	95-M23000	\$14,706.00
Key Machine, Universal, 115V	95-M34000	\$15,651.00
Key Machine, KM, 115V	95-M45000	\$14,706.00
Key Machine, Medeco X4, 115V	95-M55000	\$14,706.00
Key Machine, Medeco X4 A2/A4, 115V	95-M56000	\$15,230.00
Medeco KM Key Punch Machine	95-000200	\$4,004.00
Medeco X4 Key Punch Machine	95-001100	\$4,004.00

Power Key Machines are also available in 220V versions. Ask your customer service representative for details.

Note: Key Machines do not include keyway specific clamps. Must order from clamps shown below.

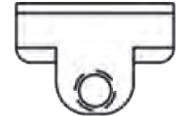

Key Machine Parts

Description	Part Number	Price
Clamp Kit (Clamp, Handle, Plunger, QC Pin) - Medeco 4	95-210100-MED4	\$1,504.00
Clamp Retrofit Kit (Clamp, Handle, Plunger) - Medeco 4	95-210130-MED4	\$1,478.00
Clamp Kit (Clamp, Handle, Plunger, QC Pin) - Medeco ³	95-210100-MED3	\$1,504.00
Clamp Retrofit Kit (Clamp, Handle, Plunger) - Medeco ³	95-210130-MED3	\$1,478.00
Clamp Kit (Clamp, Handle, Plunger, QC Pin) - Universal (Selected Biax)	95-210100-UNIV	\$839.00
Clamp Retrofit Kit (Clamp, Handle, Plunger) - Universal (Selected Biax)	95-210130-UNIV	\$754.00
Clamp Kit (Clamp, Handle, Plunger, QC Pin) - Orig. and Biax. keyways	95-210100-XX	\$839.00
Clamp Retrofit Kit (Clamp, Handle, Plunger) - Orig. and Biax. keyways	95-210130-XX	\$754.00

Key Machine Cutters

Description	Part Number	Price
Cutter for all High Security technologies	95-100400	\$595.00
Cutter for Medeco X4 key machine	95-100070	\$595.00
Re-Sharpener Cutter – Must provide cutter for re-sharpening exchange	KM-SHARP-CUT	\$225.00

Key Wizard® Key Management Software

Description	Part Number	Price
Key Wizard Key Management Software Yearly Support, Upgrade, and Maintenance Fee **PRICE SHOWN IS NET**	SW-500001	\$202.00 (NET)
Key Wizard Key Management Software Single-User Version*	SW-600001	\$1,561.00
Key Wizard Key Management Software Network Version*	SW-600201	\$1,835.00
Key Wizard Key Management Software Single User Upgrade To Network Version*	SW-600401	\$943.00

Note: Visit www.keywizard.net for more information.

Product No.	Page	Product No.	Page	Product No.	Page	Product No.	Page
12286	151	5004734	49	100500H (P)	75	105100 (S)	73
12288	151	5004832	49	100500H (S)	75	105100 C	58
13327	151	5004834	49	100501 (P)	75	105100 G	34
13346	151	5005511	49	100501 (S)	75	105104 (P)	73
13365	151	5005521	49	100600 (P)	78	105104 (S)	73
13375	151	5005531	49	100600 (S)	78	105200	45
200503	47	5005541	49	100602 (P)	97	105200 (P)	73
200901	45	5005711	49	100602 (S)	97	105200 (S)	73
200901	48	5005721	49	100700	45	105200 C	58
200902	45	5005731	49	100700 (P)	78	105300 (P)	73
200902	48	5005741	49	100700 (S)	78	105300 (S)	73
200904	48	6270515	196	100700 C	58	105400	45
310100	47	6271515	196	100702 (P)	97	105400 (P)	73
320201	47	50047321	49	100702 (S)	97	105400 (S)	73
320201	50	50047341	49	100903 (P)	75	105400 C	58
322201	47	50048321	49	100903 (S)	75	105500 (P)	73
490435	33	50048341	49	100909 (P)	75	105500 (S)	73
490435	196	50762011	50	100909 (S)	75	105500 C	58
490436	196	50762014	50	1012040 (P)	95	105600 (P)	73
500020	49	50762111	50	1012040 (S)	95	105600 (S)	73
510600	49	50762114	50	101350 (P)	74	105700 (P)	73
510800	49	50772011	50	101350 (S)	74	105700 (S)	73
526000	179	50772014	50	101355 (P)	78	105700 C	58
526002	179	50772111	50	101355 (S)	78	105800 (P)	73
526010	179	50772114	50	1014500 (P)	74	105800 (S)	73
526012	179	52110040	183	1014500 (S)	74	105900 (P)	73
526100	179	52111040	183	1014501 (P)	74	105900 (S)	73
526102	179	52120040	183	1014501 (S)	74	105901 (P)	73
526110	179	52121040	183	1014502 (P)	74	105901 (S)	73
526112	179	100100 (P)	73	1014502 (S)	74	105904 (P)	73
526200	178	100100 (S)	73	1014503 (P)	74	105904 (S)	73
526202	178	100101 (P)	73	1014503 (S)	74	1065140 (P)	94
526210	178	100101 (S)	73	1014504 (P)	74	1065140 (P)	94
526212	178	100200	45	1014504 (S)	74	1065140 (S)	94
526300	178	100200 (P)	73	1014505 (P)	74	1065140 (S)	94
526302	178	100200 (S)	73	1014505 (S)	74	1065154 (P)	96
526310	178	100200A (P)	75	1014506 (P)	74	1065154 (S)	96
526312	178	100200A (S)	75	1014506 (S)	74	1065244 (P)	94
650003	199	100202 (P)	75	1014507 (P)	74	1065244 (S)	94
940010	78	100202 (S)	75	1014507 (S)	74	1065254 (P)	96
940174	98	100300H (P)	78	1014508 (P)	74	1065254 (S)	96
940210	158	100300H (S)	78	1014508 (S)	74	1066154 (P)	96
940219	141	100300V (P)	78	1014600 (P)	74	1066154 (S)	96
940227	98	100300V (S)	78	1014600 (S)	74	1066254 (P)	96
940243	141	100305H (P)	78	1014601 (P)	74	1066254 (S)	96
940261	43	100305H (S)	78	1014601 (S)	74	1075127 (P)	94
940264	43	100305V (P)	78	1014602 (P)	74	1075127 (S)	94
940279	141	100305V (S)	78	1014602 (S)	74	10M1350	46
1202800	157	100400H	45	1014603 (P)	74	11-0018	158
1202800	161	100400H (P)	78	1014603 (S)	74	11-0092	158
1202900	157	100400H (S)	78	1014604 (P)	74	110A00 (P)	157
1202900	161	100400H C	58	1014604 (S)	74	110A00 (S)	157
1236200	161	100400H G	34	1014605 (P)	74	110A01 (P)	157
1243400	161	100400V	45	1014605 (S)	74	110A01 (S)	157
2020000	46	100400V (P)	78	1014607 (P)	74	110A02 (P)	157
2020000	49	100400V (S)	78	1014607 (S)	74	110A02 (S)	157
2020052	49	100400V C	58	1014608 (P)	74	110A03 (P)	157
2020073	46	100400V G	34	1014608 (S)	74	110A03 (S)	157
2020074	49	100403H	45	10400 CUT J	203	110A04 (P)	157
2020078	47	100403H (S)	78	10400 CUT T	203	110A04 (S)	157
2020097	47	100403H C	58	104001 (P)	74	110A05 (P)	157
2020173	47	100403V	45	104001 (S)	74	110A05 (S)	157
2021173	46	100403V (P)	78	104207 (P)	75	110A06 (P)	157
2080147	47	100403V (S)	78	104207 (S)	75	110A06 (S)	157
2080148	47	100403V C	58	104207A (P)	75	110A07 (P)	157
3307311	196	100500	45	104207A (S)	75	110A07 (S)	157
3307321	196	100500 (P)	73	104407HA (P)	78	110A08L	157
3307331	196	100500 (S)	73	104407HA (S)	78	110A09L	157
3307350	196	100500 C	58	105100	45	11-0A10	158
5004732	49	100500 G	34	105100 (P)	73	11-0A12	158

Product No.	Page	Product No.	Page	Product No.	Page	Product No.	Page
490358 C	63	5005741 (S)	165	5433500 (P)	173	5471500 (P)	174
490359 C	63	5005741 G	38	5433500 (S)	173	5471500 (S)	174
490359 G	39	50-0574L	166	54335R0 (P)	173	5471500 G	38
490361 C	63	5008201 (P)	180	54335R0 (S)	173	54715K0	174
490366 C	63	5008201 (S)	180	5433F00 (P)	173	54715L0	174
490366 G	39	5008211 (P)	180	5433F00 (S)	173	54715R0 (P)	174
490368 C	63	5008211 (S)	180	5433FR0 (P)	173	54715R0 (S)	174
490375 T	98	5009201 (P)	180	5433FR0 (S)	173	54715R0 G	38
490423 G	35	5009201 (S)	180	5434500 (P)	176	54715X0	50
490426 G	35	5009211 (P)	180	5434500 (S)	176	5471F00 (P)	174
490432 G	35	5009211 (S)	180	54345R0 (P)	176	5471F00 (S)	174
490437 G	35	50-74201	180	54345R0 (S)	176	5471F00 G	38
49G0431	40	50-74211	180	5442500 (P)	177	5471FK0	174
500020 (P)	169	50-75201	180	5442500 (S)	177	5471FLO	174
500020 (S)	169	50-75211	180	54425K0	177	5471FR0 (P)	174
5002201 (P)	180	50-81732	169	54425L0	177	5471FR0 (S)	174
5002201 (S)	180	50-817321	169	54425R0 (P)	177	5471FR0 G	38
5002211 (P)	180	50-81734	169	54425R0 (S)	177	5471FX0	50
5002211 (S)	180	50-817341	169	5444500 (P)	177	5472500 (P)	177
5003201 (P)	180	50-81832	169	5444500 (S)	177	5472500 (S)	177
5003201 (S)	180	50-818321	169	54445R0 (P)	177	5472500 G	38
5003211 (P)	180	50-81834	169	54445R0 (S)	177	54725K0	177
5003211 (S)	180	50-818341	169	5451500 (P)	172	54725L0	177
5004732 (P)	169	510600 (P)	98	5451500 (S)	172	54725R0 (P)	177
5004732 (S)	169	510600 (P)	180	5451500 G	38	54725R0 (S)	177
5004732 G	38	510600 (S)	98	54515K0	172	54725R0 G	38
50047321 (P)	169	510600 (S)	180	54515L0	172	54725X0	50
50047321 (S)	169	510600 C	61	54515R0 (P)	172	5481500 (P)	174
5004734 (P)	169	510600 G	38	54515R0 (S)	172	5481500 (S)	174
5004734 (S)	169	510800 (P)	166	54515R0 G	38	54815K0	174
5004734 G	38	510800 (S)	166	54515X0	50	54815L0	174
50047341 (P)	169	510800 G	38	5451F00 (P)	172	54815R0 (P)	174
50047341 (S)	169	526001 (P)	179	5451F00 (S)	172	54815R0 (S)	174
5004832 (P)	169	526001 (S)	179	5451F00 G	38	54815X0	50
5004832 (S)	169	526011 (P)	179	5451FK0	172	5481F00 (P)	174
50048321 (P)	169	526011 (S)	179	5451FLO	172	5481F00 (S)	174
50048321 (S)	169	526101 (P)	179	5451FR0 (P)	172	5481FK0	174
5004834 (P)	169	526101 (S)	179	5451FR0 (S)	172	5481FLO	174
5004834 (S)	169	526111 (P)	179	5451FR0 G	38	5481FR0 (P)	174
50048341 (P)	169	526111 (S)	179	5451FX0	50	5481FR0 (S)	174
50048341 (S)	169	526201 (P)	178	5452500 (P)	175	5481FX0	50
5005511 (P)	165	526201 (S)	178	5452500 (S)	175	5482500 (P)	177
5005511 (S)	165	526211 (P)	178	5452500 G	38	5482500 (S)	177
5005511 G	38	526211 (S)	178	54525K0	175	54825K0	177
50-0551L	166	526301 (P)	178	54525L0	175	54825L0	177
5005521 (P)	165	526301 (S)	178	54525R0 (P)	175	54825R0 (P)	177
5005521 (S)	165	526311 (P)	178	54525R0 (S)	175	54825R0 (S)	177
5005521 G	38	526311 (S)	178	54525R0 G	38	54825X0	50
50-0552L	166	5293000 (P)	182	54525X0	50	600250T (P)	188
5005531 (P)	165	5293000 (S)	182	5461500 (P)	172	600250T (S)	188
5005531 (S)	165	5293000 G	38	5461500 (S)	172	600350T (P)	188
5005531 G	38	52930L0	182	54615K0	172	600350T (S)	188
50-0553L	166	5431500 (P)	173	54615L0	172	600350T KIT (P)	187
5005541 (P)	165	5431500 (S)	173	54615R0 (P)	172	600350T KIT (S)	187
5005541 (S)	165	54315K0	173	54615R0 (S)	172	600450T (P)	188
5005541 G	38	54315L0	173	54615X0	50	600450T (S)	188
50-0554L	166	54315R0 (P)	173	5461F00 (P)	172	600550T (P)	188
5005711 (P)	165	54315R0 (S)	173	5461F00 (S)	172	600550T (S)	188
5005711 (S)	165	5431F00 (P)	173	5461FK0	172	600650269 G-XX	39
5005711 G	38	5431F00 (S)	173	5461FLO	172	600650T (P)	188
50-0571L	166	5431FK0	173	5461FR0 (P)	172	600650T (S)	188
5005721 (P)	165	5431FLO	173	5461FR0 (S)	172	600650T KIT (P)	187
5005721 (S)	165	5431FR0 (P)	173	5461FX0	50	600650T KIT (S)	187
5005721 G	38	5431FR0 (S)	173	5462500 (P)	176	600750T (P)	188
50-0572L	166	5432500 (P)	176	5462500 (S)	176	600750T (S)	188
5005731 (P)	165	5432500 (S)	176	54625K0	176	600850T (P)	188
5005731 (S)	165	54325K0	176	54625L0	176	600850T (S)	188
5005731 G	38	54325L0	176	54625R0 (P)	176	600950T (P)	188
50-0573L	166	54325R0 (P)	176	54625R0 (S)	176	600950T (S)	188
5005741 (P)	165	54325R0 (S)	176	54625X0	50	601150T (P)	188

Product No.	Page	Product No.	Page	Product No.	Page	Product No.	Page
601150T (S)	188	641050T (S)	194	94-0204	203	CARD XX 66 XX	203
601150T KIT (P)	187	641051T (P)	194	94-0207	145	CB-CODE-BIA	203
601150T KIT (S)	187	641051T (S)	194	94-0207	212	CB-CODE-BOK	203
601250T (P)	188	641200 C	61	94-0208	145	CN-DIES	202
601250T (S)	188	641200 C	64	94-0212	158	CP-010103-040	211
601251T (P)	188	641200D C	64	94-0213	183	CP-010203-030	211
601251T (S)	188	641201 C	61	94-0221	145	CP-010203-050	78
601450T (P)	188	641201 C	64	94-0222	145	CP-010203-050	98
601450T (S)	188	641201D C	64	94-0223	145	CP-010203-050	211
601450T KIT (P)	187	652150T 011 (P)	199	94-0227-XX	78	CP-010234-320	158
601450T KIT (S)	187	652150T 011 (S)	199	94-0227-XX	79	CP-010235-120-XX	158
601452T (P)	188	652150T 012 (P)	199	94-0227-XX	211	CP-010503-040	98
601452T (S)	188	652150T 012 (S)	199	94-0239	41	CP-010503-040	211
60300 CUT W 219	203	652150T 021 (P)	199	94-0249	65	CP-011011-020	78
607155XT (P)	190	652150T 021 (S)	199	94-0255-XX	211	CP-011011-020	79
607155XT (S)	190	6522560 G -121-XX	39	94-0256-XX	211	CP-011011-020	211
607255XT (P)	190	6522560 G -122-XX	39	94-0261	203	CP-011013-020	78
607255XT (S)	190	6522560T 121 (P)	201	94-0269	203	CP-011013-020	79
607355XT (P)	190	6522560T 121 (S)	201	94-0271	41	CP-011013-020	151
607355XT (S)	190	6522560T 122 (P)	201	94-0272	102	CP-011013-020	211
607455XT (P)	190	6522560T 122 (S)	201	94-0283	142	CP-011013-040	151
607455XT (S)	190	6522560T 132 (P)	201	94-0285	145	CP-011013-040	211
607555XT (P)	190	6522560T 132 (S)	201	94-0287	141	CP-011511-000	181
607555XT (S)	190	6522560T 133 (P)	201	94-0288	141	CP-011751	158
60810 XXX C	63	6522560T 133 (S)	201	94-0289	141	CP-011753	158
60810D XXX C	63	6522560T 134 (P)	201	94-0290	43	CP-011754	158
60820 XXX C	63	6522560T 134 (S)	201	94-0291	43	CP-011757	158
60820D XXX C	63	6522560T 221 (P)	201	94-0292	43	CP-011762	158
6210555 G XX	39	6522560T 221 (S)	201	94-0304-MOP	54	CP-011763	158
6210555T (P)	196	652650T 101 (P)	199	94-0304-MBP	54	CP-011764	158
6210555T (S)	196	652650T 101 (S)	199	94-0305-MOP	54	CP-011767	158
6211555 G XX	39	652650T 102 (P)	199	94-0305-MBP	54	CP-012409-030	151
6211555T (P)	196	652650T 102 (S)	199	94-0306	41	CP-012411-030	151
6211555T (S)	196	652650T 111 (P)	199	94-0307	41	CP-012411-040	151
6212555 G XX	39	652650T 111 (S)	199	94-0309	203	CP-012917-000	79
6212555T (P)	196	652650T 131 (P)	199	94-0312	53	CP-014213-061	166
6212555T (S)	196	652650T 131 (S)	199	94-0316	166	CP-014642-591	166
6221554T (P)	197	652650T 132 (P)	199	94-0317-516	166	CP-020010	79
6221554T (S)	197	652650T 132 (S)	199	94-0317-716	166	CP-020020	98
6221557T (P)	197	652650T 133 (P)	199	94-0318	166	CP-020031	151
6221557T (S)	197	652650T 133 (S)	199	94-0323	212	CP-020040	98
6261557T (P)	197	66391 (P)	180	94-0325	41	CP-020100	98
6261557T (S)	197	66391 (P)	190	95-000200	213	CP-020240	151
6280550 G	39	66391 (P)	196	95-001100	213	CP-021011	78
6280550 G -XX	39	66391 (S)	180	95-100070	213	CP-021031	98
6282550 G	39	66391 (S)	190	95-100400	213	CP-021121	79
6282550 G -XX	39	66391 (S)	196	95-210100-MED3	213	CP-021130	98
640155CT (P)	194	66418 (P)	180	95-210100-MED4	213	CP-021370	98
640155CT (S)	194	66418 (S)	180	95-210100-UNIV	213	CP-021400	151
640155T (P)	194	90-0001	212	95-210100-XX	213	CP-021490	151
640155T (S)	194	90-0028	203	95-210130-MED3	213	CP-021651	98
640250T (P)	192	94-0020	181	95-210130-MED4	213	CP-022030	181
640250T (S)	192	94-0029	158	95-210130-UNIV	213	CP-030001	151
640251T (P)	192	94-0030	158	95-210130-XX	213	CP-030001	210
640251T (S)	192	94-0034	102	95-M11000	213	CP-030017	210
640550AT (P)	192	94-0035	102	95-M23000	213	CP-030018	78
640550AT (S)	192	94-0036	102	95-M34000	213	CP-030018	79
640550FT (P)	192	94-0051	102	95-M45000	213	CP-030018	210
640550FT (S)	192	94-0052	181	95-M55000	213	CP-030024	151
640550T (P)	192	94-0058-MED	157	95-M56000	213	CP-030025	151
640550T (S)	192	94-0059	157	960357 (P)	180	CP-030042	210
640750ET (P)	194	94-0061	102	960357 (S)	180	CP-030430	181
640750ET (S)	194	94-0067	102	960358 (P)	180	CP-030590	210
640750GT (P)	194	94-0098	102	960358 (S)	180	CP-030670	98
640750GT (S)	194	94-0174-XX	78	960590 W 26-56	121	CP-030860	147
640950T (P)	194	94-0174-XX	79	CARD 1 X XX	203	CP-030860	151
640950T (S)	194	94-0174-XX	211	CARD 2 X XX	203	CP-030910	210
640952T (P)	194	94-0188-XX	80	CARD 6 X XX	203	CP-031030	151
640952T (S)	194	94-0199	181	CARD KS XX 8E	203	CP-031170	211
641050T (P)	194	94-0203	145	CARD XX 56 XX	203	CP-031480	211

Product No.	Page	Product No.	Page	Product No.	Page	Product No.	Page
CT-A01	190	CT-J29	192	CT-Z55	77	EA-100229	56
CT-A02	190	CT-V00	99	CT-Z56	77	EA-100230	53
CT-A03	190	CT-V01	99	CT-Z57	77	EA-100232	43
CT-A04	190	CT-V02	99	CT-Z58	77	EA-100236-M00	30
CT-A05	190	CT-V03	99	CT-Z59	77	EA-100236-M01	30
CT-A06	190	CT-V19	99	CT-Z61	77	EA-100236-MD0	30
CT-A07	190	CT-V35	99	CT-Z69	77	EA-100236-MD1	30
CT-A08	190	CT-V39	99	CT-Z70	77	EA-100236-MU0	30
CT-A09	190	CT-V40	99	CT-Z84	77	EA-100236-MU1	30
CT-A11	190	CT-Y02	80	CT-Z87	77	EA-100237-M00	30
CT-A12	190	CT-Y08	80	CT-Z88	147	EA-100237-M01	30
CT-A13	190	CT-Y08	99	CT-Z88	151	EA-100237-MD0	30
CT-A14	190	CT-Y24	100	CT-Z98	141	EA-100237-MD1	30
CT-A15	190	CT-Y27	100	CT-Z98	151	EA-100237-MU0	30
CT-A16	190	CT-Y28	100	CT-Z99	77	EA-100237-MU1	30
CT-A19	190	CT-Y29	100	CT-ZA2	151	EA-100240	34
CT-C02	191	CT-Y31	100	CT-ZA6	77	EA-100242-000	42
CT-C04	191	CT-Y32	80	DE-CODE-KEY	202	EA-100242-00G	42
CT-C05	191	CT-Y35	100	DE-CODE-LOK	202	EA-100242-010	42
CT-C08	191	CT-Y37	100	EA-100088	43	EA-100242-01G	42
CT-C09	191	CT-Y46	100	EA-100107	41	EA-100242-100	42
CT-C11	191	CT-Y47	100	EA-100108	36	EA-100242-10G	42
CT-D00	191	CT-Y49	100	EA-100109	42	EA-100245	42
CT-D01	191	CT-Y52	100	EA-100109	43	EA-100247-A00	30
CT-D02	191	CT-Y53	100	EA-100110	203	EA-100247-A01	30
CT-D03	191	CT-Y54	100	EA-100111	203	EA-100247-M00	30
CT-D04	191	CT-Y55	100	EA-100117	121	EA-100247-M01	30
CT-D05	191	CT-Y57	100	EA-100119-XX	40	EA-100247-MD0	30
CT-D06	191	CT-Y58	101	EA-100121	65	EA-100247-MD0	30
CT-D07	191	CT-Y60	159	EA-100125	42	EA-100247-MU0	30
CT-D08	191	CT-Y61	159	EA-100126	56	EA-100247-MU1	30
CT-D09	191	CT-Y67	101	EA-100138	43	EA-100248-A00	30
CT-D11	191	CT-Y68	101	EA-100142	56	EA-100248-A01	30
CT-D12	191	CT-Y69	101	EA-100145	65	EA-100248-M00	30
CT-D15	191	CT-Y70	101	EA-100148	121	EA-100248-M01	30
CT-D19	191	CT-Y71	101	EA-100149	121	EA-100248-MD0	30
CT-F34	99	CT-Y72	101	EA-100154	121	EA-100248-MD1	30
CT-F35	99	CT-Y73	101	EA-100156	41	EA-100248-MU0	30
CT-F36	99	CT-Y74	101	EA-100159	65	EA-100248-MU1	30
CT-F37	99	CT-Y75	101	EA-100160	56	EA-100249-A00	30
CT-F38	99	CT-Y76	151	EA-100167	65	EA-100249-A01	30
CT-F40	99	CT-Y77	101	EA-100168	56	EA-100249-M00	30
CT-F42	159	CT-Y78	101	EA-100173	41	EA-100249-M01	30
CT-F43	159	CT-Y97	101	EA-100173	203	EA-100249-MD0	30
CT-F44	159	CT-Z00	76	EA-100174	41	EA-100249-MD1	30
CT-H00	191	CT-Z01	76	EA-100174	203	EA-100249-MU0	30
CT-H07	191	CT-Z02	76	EA-100177	41	EA-100249-MU1	30
CT-H09	191	CT-Z04	76	EA-100178	41	EA-100250-A00	30
CT-H14	191	CT-Z05	76	EA-100179	56	EA-100250-A01	30
CT-H15	191	CT-Z06	76	EA-100180	56	EA-100250-M00	30
CT-H16	191	CT-Z07	76	EA-100181	56	EA-100250-M01	30
CT-H17	191	CT-Z08	76	EA-100182	56	EA-100250-MD0	30
CT-H19	191	CT-Z09	76	EA-100192	32	EA-100250-MD1	30
CT-H20	191	CT-Z16	76	EA-100199-A00	30	EA-100250-MU0	30
CT-H27	191	CT-Z17	76	EA-100199-A01	30	EA-100250-MU1	30
CT-H30	191	CT-Z18	76	EA-100199-M00	30	EA-100254	41
CT-H32	191	CT-Z19	76	EA-100199-M01	30	EA-200058	43
CT-J01	192	CT-Z20	76	EA-100199-MD0	30	EA-250059	43
CT-J05	192	CT-Z21	76	EA-100199-MD1	30	EA-250066	31
CT-J07	192	CT-Z22	77	EA-100199-MU0	30	EA-300069-01-EL	205
CT-J08	192	CT-Z26	151	EA-100199-MU1	30	EA-300070-01-EL	205
CT-J11	192	CT-Z29	151	EA-100206	33	EA-300086-01-EL	206
CT-J12	192	CT-Z34	77	EA-100207	33	EA-300087-01-EL	206
CT-J13	192	CT-Z45	77	EA-100208	33	EA-300088-01-EL	206
CT-J14	192	CT-Z47	77	EA-100210	56	EA-300089-01-EL	206
CT-J15	192	CT-Z48	77	EA-100219	40	EA-300239	31
CT-J18	192	CT-Z50	145	EA-100220	33	EA-300241	42
CT-J22	192	CT-Z50	151	EA-100221	33	EA-300242	31
CT-J27	192	CT-Z51	145	EA-100222	53	EA-300243	31
CT-J28	192	CT-Z51	151	EA-100224	53	EA-300244	31

Product No.	Page	Product No.	Page	Product No.	Page	Product No.	Page
EA-300245	31	KYB 10X605 XX	204	KYC 4S X600 XX 99 XXX	202	SW-600901-1	25
EA-350084	54	KYB 115400 56 43	204	KYC 4S X600 XX XX XXX	202	SW-600901-1R	25
EA-500054-M0P	54	KYB 115400 XX 00	204	KYC 745600 XX 99	207	SW-600901-R	25
EA-500054-MBP	54	KYB 12X600 XX 99	204	KYC 74563J XX 99	206	T-7155	212
EN-150002-XXX	42	KYB 17X600 XX 99	204	KYC 74563K XX 99	206	TP-F10-2W (.060i)	146
EN-150002-XXX (Op Code)	39	KYB 32X600 XX 99	204	KYC 74563P XX 99	205	TP-F10-3M	209
EN-150003-XXX (Op Code)	39	KYB 32X900 XX 99	204	KYC 745640 XX 99	207	TP-F10-3W (.090i)	146
EV-8501D	38	KYB 33X600 XX 99	204	KYC 746600 XX 99	207	TP-F10-4T (.180i)	146
EV-8501D	40	KYB 34X600 XX 99	204	KYC 74663J XX 99	206	TP-F10-4W-6T (.120i)	146
EV-8501S	38	KYB 355600 XX 99	207	KYC 74663K XX 99	206	TP-F10-5T (.150i)	146
EV-8501S	40	KYB 35563J XX 99	206	KYC 74663P XX 99	205	TP-F10-XT	209
.K-1001	209	KYB 35563K XX 99	206	KYC 746640 XX 99	207	TP-F10-XW	209
.K-1002	209	KYB 35563P XX 99	205	KYC 776600 XX 99	207	TP-F10-XX	209
.K-1003	209	KYB 355640 XX 99	207	KYC 77663P XX 99	205	TP-F15-XB	209
.K-1005	209	KYB 356600 XX 99	207	KYC 776640 XX 99	207	TP-F15-XT	209
.K-1006	209	KYB 35663J XX 99	206	KYC 776900 XXX 99	207	TP-F50-XW	209
.K-1099	211	KYB 35663K XX 99	206	KYC 77693P XXX 99	205	TP-F50-XX	209
.K-4001	208	KYB 35663P XX 99	205	KYC 776940 XXX 99	207	TP-F53-XX	209
.K-4002	208	KYB 356640 XX 99	207	KYC 777600 XX 99	207	TP-F57-0	209
.K-4003	208	KYB 38X600 XX 99	204	KYC 77763P XX 99	205	TP-F57-x	209
.K-4004	208	KYB 38X900 XX 99	204	KYC 777640 XX 99	207	TP-F60-XX	209
.K-4006	208	KYB 4L X600 XX 99 XXX	204	KYC 777900 XXX 99	207	TP-F90-XX	209
.K-6001	209	KYB 4S X600 XX 99 XXX	204	KYC 77793P XXX 99	205	TP-H10-9W (.135i)	146
.K-6002	209	KYB 745600 XX 99	207	KYC 777940 XXX 99	207	TP-K40-XX-BH	209
.K-9001	208	KYB 74563F NM XX	205	KYC A50000 AXX 00	202	TP-K40-XX-TH	209
.KJ1501	208	KYB 74563H NM XX	206	KYC A60000 AXX 00	202	TP-K42-Z9	209
.KW5005	208	KYB 74563J XX 99	206	KYC XX5600 XX 99	202	TP-K43-XX-BH	209
.KW5006	208	KYB 74563K XX 99	206	KYC XX6600 XX XX	202		
.KW5007	208	KYB 74563N NM XX	206	KYC XX6900 XXX 99	202		
.KW5010	208	KYB 74563P XX 99	205	KYC XX6900 XXX XX	202		
.KW5011	208	KYB 745640 XX 99	207	LH 49G0428	40		
.KW5012	208	KYB 746600 XX 99	207	PK-KYLUBE-02	43		
.KW5401	56	KYB 74663J XX 99	206	PK-KYLUBE-11	43		
.KW5401	141	KYB 74663K XX 99	206	PX-KYLUBE-02	212		
.KW5401	208	KYB 74663P XX 99	205	PX-KYLUBE-11	212		
.KW9003	208	KYB 746640 XX 99	207	RE-KEY	202		
KEB 47600C	54	KYB 776600 XX 99	207	RE-KEY-MK	202		
KEB 48600C	54	KYB 77663F NM XX	205	RH 49G0429	40		
KEB 49600C	54	KYB 77663H NM XX	206	ST-LASER	202		
KEC 42602B	65	KYB 77663N NM XX	206	SW-500001	213		
KEC 42603B	65	KYB 77663P XX 99	205	SW500101-1	66		
KEC 4260CR	65	KYB 776900 XXX 99	207	SW-500101-1	55		
KEC 426P2B	65	KYB 77693P XXX 99	205	SW500101-3	66		
KEC 426P3B	65	KYB 776940 XXX 99	207	SW-500101-3	55		
KEC 47X002	54	KYB 777600 XX 99	207	SW500101-5	66		
KEC 47X003	54	KYB 77763P XX 99	205	SW-500101-5	55		
KEC 47X013	54	KYB 777900 XXX 99	207	SW-500111-R	55		
KEC 47X023	54	KYB 77793P XXX 99	205	SW-500121-0	53		
KEC 47XB03	52	KYB 777940 XXX 99	207	SW-500121-1	53		
KEC 47XP02	54	KYB A50000-AXX00	204	SW-500121-1R	53		
KEC 47XP03	54	KYB A60000-AXX00	204	SW-500141	30		
KEC 48X002	54	KYB XX5400 XX 99	204	SW-500141-1	30		
KEC 48X003	54	KYB XX6605	159	SW-500141-1R	30		
KEC 48X013	54	KYB XX6611	105	SW-500150-R	55		
KEC 48X023	54	KYB XX6620 XX 05	106	SW-5001570	56		
KEC 48XB03	52	KYB XX6X31	106	SW-500160-5R	55		
KEC 48XP02	54	KYB XX7X11	105	SW-500170-R	56		
KEC 48XP03	54	KYB XX7X31	106	SW-500301-1	25		
KEC 49X002	54	KYC 355600 XX 99	207	SW-500301-1R	25		
KEC 49X003	54	KYC 35563J XX 99	206	SW-500301-2	24		
KEC 49X013	54	KYC 35563K XX 99	206	SW-500301-3	24		
KEC 49XB03	52	KYC 35563P XX 99	205	SW-500301-4	24		
KEC 49XP02	54	KYC 355640 XX 99	207	SW-600001	213		
KEC 49XP03	54	KYC 356600 XX 99	207	SW-600201	213		
KM KYB 776640 XX 99	207	KYC 35663J XX 99	206	SW-600401	213		
KM KYB 777640 XX 99	207	KYC 35663K XX 99	206	SW-600801	66		
KM-SHARP-CUT	202	KYC 35663P XX 99	205	SW-600801-6	55		
KM-SHARP-CUT	213	KYC 356640 XX 99	207	SW-600801-6R	55		
KYB 105400 XX 00	204	KYC 4L X600 XX 99 XXX	202	SW-600801-6R	66		
KYB 10X600 XX XX	204	KYC 4L X600 XX XX XXX	202	SW-600901	25		

Finishes Available – Commercial & Industrial Locks



05
(US03)
Bright Brass



06
(US04)
Satin Brass



09
(US5)
Antique Brass



10
Satin Brass
Blackened



11
(US9)
Bright Bronze



12
(US10)
Satin Bronze



13
(US10B)
Dark Bronze/
Oil Rubbed



18
(US14)
Bright Nickel



19
(US15)
Satin Nickel

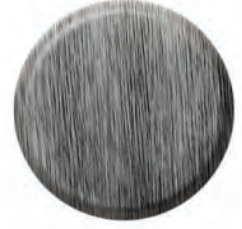

20
(US15A)
Antique Nickel



22
(US19)
Flat Black



24
(US20A)
Dark Bronze/
Clear Coat



25
(US26)
Bright Chrome



26
(US26D)
Satin Chrome



BB
Matte Black

Note: Product appearance may differ from this chart as a result of the differences in plated versus printed materials.

The ASSA ABLOY Group is the global leader in access solutions. Every day, we help billions of people experience a more open world.

ASSA ABLOY Opening Solutions leads the development within door openings and products for access solutions in homes, businesses and institutions. Our offering includes doors, frames, door and window hardware, locks, perimeter fencing, access control and service.



medeco

ASSA ABLOY

MEDECO USA

3625 Alleghany Drive | Salem, Virginia 24153-0330
Customer Service 1.877.633.3261

MEDECO CANADA

160 Four Valley Drive | Vaughan, ON L4K 4T9 CANADA
Customer Service 1.888.633.3264



facebook.com/medecolocks



youtube.com/medecolocks



newsletter sign up: medeco.com