

Electronic Lock Parts Price Book

PL73 | Effective April 2022



General information

Table of Contents

3	Terms and conditions
6	How to order
7	E-Plex 2000 Series
10	E-Plex 3000 Series
14	E-Plex 5000 Series
15	E-Plex 5000 Cylindrical
24	E-Plex 5000 Exit Trim
29	E-Plex 5000 Mortise
36	E-Plex 5x86 Double-sided Mortise
41	E-Plex 5x70 Stand alone controller
44	Feature charts

General information

Terms and conditions of sale

Acceptance. The following Terms and Conditions of sale are applicable to all Quotations, Contract, Purchase Orders, Order Acknowledgement Forms, and sales of Seller's services and products, and are the only applicable terms and conditions thereto, except for terms establishing prices, quantities, delivery schedules, terms of payment, invoicing, shipping instructions, and the identification of the products associated with each transaction. If any conflict exists between the Terms and Conditions and a Quotation, Purchase Order, Order Acknowledgment form, or sale, these Terms and Conditions shall prevail BY REQUESTING A QUOTATION OF ORDERING ANY PRODUCTS OR SERVICES FROM SELLER, BUYER AGREES TO ALL THE FOLLOWING TERMS AND CONDITIONS. If a written contract signed by both parties is in existence covering the sale of the goods and services, the terms and conditions of the contract shall control to the extent they are inconsistent with these Terms and Conditions.

1. Order Procedure. Buyer may or may not request the preparation of a Quotation prior to ordering any products or services from Seller. Buyer then shall place a Purchase Order with Seller. By placing a Purchase Order, Buyer makes an offer to purchase products or services from Seller pursuant to these Terms and Conditions. Seller, in its discretion, may accept or reject the Purchase Order. If Seller accepts the Purchase Order, Seller shall issue an Order Acknowledgement Form confirming Buyer's order. No Purchase Order is binding on Seller unless accepted by Seller as provided in these Terms and Conditions.

2. Quotations. All Quotations by Seller are subject to change or withdrawal without prior notice to Buyer unless otherwise specifically stated in the Quotation. Quotation prices are valid on Purchase Orders placed within 90 days of the quote being issued, unless otherwise specifically stated in the quotation. If no order is placed within the stated time frame, prices may be adjusted to reflect the then-current published prices, surcharges, escalators, or other pricing adjustment due to, among other things, costs of materials, labor, transportation, taxes, duties, and other cost increases to Seller. All resulting Purchase Orders become effective only if and when approved and accepted in writing by Seller by the issuance of its Order Acknowledgement Form. Seller reserves the right to discontinue manufacture of any products or change products materials, design, or specifications without notice.

Quotation prices are valid on Purchase Orders placed within 90 days of the quote being issued, unless otherwise specifically stated in this quotation. If no order is placed within the stated time frame, prices may be adjusted to reflect the then-current published prices, surcharges, escalators, or other pricing adjustment due to, among other things, costs of materials, labor, transportation, taxes, duties, and other cost increases to Seller. All resulting Purchase Orders become effective only if and when approved and accepted in writing by Seller by the issuance of its Order Acknowledgement Form. All Quotations and resulting orders are subject to Seller's Terms and Conditions set forth in the price book.

3. Site Requirements.

a. The Quotation is contingent upon all work being performed during normal business hours unless otherwise negotiated and a mutually agreeable schedule. The Quotation is calculated on one continuous installation engagement based on acceptable site conditions where other dependent scopes have completed preparation for proposed materials (i.e. electrical work, floor work, adjacent construction). When Buyer has given authorization for work to begin, no other scopes may impede Seller's ability to complete installation in agreed upon area. Seller reserves the right to invoice for costs

that are incurred due to unacceptable site conditions or delays by others resulting in additional installation visits.

b. Signed acceptance by Buyer of shop drawings and/or submittals shall be interpreted as acceptance that proposed scope is the correct interpretation of construction documents. Any field verification and/or work required by others as detailed in the submittal will be provided and coordinated by Buyer. Work shall not begin nor shall orders be placed for any projects until all shop drawings and submittals have been approved in writing by Buyer.

4. Warranty. For a period of twelve (12) months from the date of delivery, Seller warrants only that all products sold pursuant to a Quotation or Purchase Order will conform to the description in this Price Book and will be free from defects in workmanship and materials. Extended warranties are available for an additional cost. Seller is not responsible for defects or damages caused by wear and tear, consumable materials, vandalism, fires, storms, floods, acts of God, misuse, abuse or alteration by any company other than Seller. Seller further warrants that Buyer will receive good and valid title to the products. Any claim on account of nonconforming or defective products or for any other cause whatsoever shall conclusively be deemed waived by Buyer unless written notice thereof is given to Seller promptly after discovery but no later than sixty (60) days from date of shipment. Seller shall have the right either to replace or repair any nonconforming or defective products, to refund the purchase price upon return of the products, or to grant a reasonable allowance on account of such nonconformance or defect Seller's liability and Buyer's exclusive remedy for nonconforming or defective products shall be limited solely to replacement, repair, refund, or allowance as Seller may elect. Seller shall be given reasonable opportunity to investigate all claims and no materials shall be returned to Seller until after inspection and approval by Seller and receipt by Buyer of written shipping instructions from Seller. Buyer acknowledges and agrees that the remedies set forth in this paragraph are Buyer's exclusive remedies for the delivery of nonconforming or defective products.

Additional Warranties

- No credit will be provided for any work completed by others during warranty term.
- Warranty work will be performed during normal business hours with our standard response times. Any warranty work taking place beyond normal business hours or with expedited response time may be billable.
- Products repaired or replaced under the warranty are warranted only through the remainder of the original warranty period.

Disclaimer of Further Warranties. Except as set forth above, there is no warranty, representation, or condition of any kind, express or implied (including no warranty of merchantability or fitness of the products for any use contemplated by Buyer) concerning Seller's products or services and none shall be implied by law. **5. Limitation of Liability and Remedies.** Seller shall not be liable, and Buyer waives all claims against Seller for any incidental, consequential, or special damages, including without limitation, lost revenues and profits even if Seller has been advised of the possibility of such damages. Buyer's exclusive remedy for any cause of action under these Terms and Conditions is a claim for damages and in no event will damages or any other recovery of any kind against Seller exceed the purchase price of the specific products or services as to which the claim is made. Seller will not be liable to Buyer for any loss, damage, or injury to persons or property resulting from the handling, storage, transportation, resale, or use of the products in manufacturing processes, or in combination with other substances, or otherwise.

General information

Terms and conditions of sale

6. Intellectual Property Indemnification. (a) Seller agrees to defend, indemnify and hold Buyer harmless against any claims, costs, damages, liability and expenses resulting from actual or alleged patent, trademark, or copyright infringement, misappropriation of confidential information, or violation of any other intellectual property right, domestic or foreign, in the selling or use of any part or product that is owned by Seller and that pertains to the subject matter of a Quotation, Purchase Order, or sale of products or services (provided that the product is not modified in anyway by Buyer or any other party, and that the product is used in the manner intended by Seller). If a suit or claim results in any injunction or any other order that would prevent Seller from supplying any product falling under a Quotation, Purchase Order, or sale, or if the result of such a suit or claim would, in the reasonable opinion of Seller, otherwise cause Seller to be unable to supply such products, Seller shall have the right, at its option, if it so chooses, to do one or more of the following: (i) secure an appropriate license to permit Seller to continue supplying the products to Buyer; (ii) modify the relevant product so that it becomes non-infringing, provided that any modification does not cause any material change to the operation or performance of the product; or (iii) replace the relevant product with a non-infringing but practically equivalent product. (b) Buyer agrees to defend, indemnify, and hold Seller harmless against any claims, costs, damages, liability and expenses resulting from actual or alleged patent, trademark, or copyright infringement, misappropriation of confidential information, or violation of any other intellectual property right, domestic or foreign, in the making, using or selling of any product or using any process that is owned by Buyer or is designed or specified by Buyer and that pertains to the subject matter of a Quotation, Purchase Order, or sale.

7. Ownership of Inventions. All drawings, know-how, designs, confidential information, and the like disclosed to Buyer by Seller and all rights therein will remain the property of Seller. Buyer shall have no claim to, ownership interest in, no license to, or no rights to any information provided or communicated by Seller.

8. Lead Times. If applicable, lead times are based on standard requirements by factory to provide materials proposed. Ship dates will be provided as estimate only once order is placed with the factory. Adequate packaging will be provided for any normal shipping circumstance such that materials will be protected and labeled as required. Special packaging may be provided for an additional expense. Shipping will be cost effective unless expedited fees are accepted by Buyer. If materials are to be provided to job site or Buyer location, dormakaba will make an informed decision as to the best instruction to provide the shipping company. If materials are not required to have direct delivery, materials will be brought to branch for pickup by Buyer. All freight terms shall be FOB. Any claims for damage in transit or lost freight, receiving, and inspection of materials is the responsibility of Buyer. It is a requirement of Buyer to inspect and review all materials prior to accepting shipment.

9. Title/Risk of Loss. All products shall be shipped FOB Seller's manufacturing facility to Buyer's designated delivery location. Unless otherwise agreed by the parties, Seller shall select the method of and carrier for the products. Seller reserves the right to ship items in a single or in multiple shipments. Title and risk of loss to products ordered passes to Buyer upon delivery of the products to the freight carrier. Unless mutually agreed upon in writing, shipping dates are approximate and are based upon prompt receipt of all necessary information.

10. Prices. Quoted price is valid for 90 days. Seller reserve the right to revise quotations after the 90 days. All accepted Purchase Orders are subject to Seller's price in effect at time of shipment. Buyer shall be responsible for any increase in freight rates or transportation charges occurring after Seller prepared

the Order Acknowledgment Form. on the Order Acknowledgment Form. Buyer shall pay to Seller in addition to the purchase price the amount of all fees, duties, licenses, and all sales, use, privilege, occupation, excise, or other taxes, federal, state, local, or foreign which Seller is required to pay or collect in connection with products or services sold to Buyer.

11. Payments. Unless otherwise agreed in writing between the parties, all Seller's invoices are payable within thirty (30) days of their date. Time is of the essence. Interest on past due amounts will be assessed at the rate of 1.5% per month (18% per annum), or the maximum allowable by law.

Seller reserves the right to full payment upon completion of work unless credit is pre-established. For any work requiring materials purchase or scheduling, a 50% deposit is due at time of proposal acceptance. Twenty percent (20%) of the Quotation, Purchase Order value may be billed after job award. Joint check agreements may be requested at the discretion of Seller. If payment is outstanding for any one account, work may be stopped and outstanding orders cancelled until account is restored. Should Seller require the use of collection, attorney's fees, or fees for insufficient funds, Buyer agrees that these funds will be repaid to Seller. Seller retains the right to file a lien against all or part of the property being improved. Seller reserves the right to add a 2.5% charge if invoice becomes delinquent beyond terms.

12. Cancellation. In the event a Buyer's Purchase Order and the issuance of an Order Acceptance Form is cancelled, it will be subject to standard 20% restocking fees, cancellation fees, engineering fees, materials & freight costs incurred, and administrative fees. Standard cancellation is 20% of order as long as no materials have been ordered. Should Buyer release material orders, Buyer will be liable for that portion of the job and 20% of the remaining amount of work unperformed/unordered.

13. Storage. If applicable, Seller reserves the right to implement a storage fee if delivery is delayed after agreed upon date. Should project timeline require storage of materials, Seller reserves the right to bill for those materials at the time they have been received at a Seller location, Buyer location, or at job site. Certificate of insurance for stored materials can be provided to Buyer upon request. Signed acceptance by Buyer of shop drawings and/or submittals shall be interpreted as acceptance that proposed scope is the correct interpretation of construction documents. Any field verification and/or work required by others as detailed in the submittal will be provided and coordinated by Buyer.

14. Insolvency. Seller may, at any time or times, suspend performance of any order or require payment in cash, security, or other adequate assurance satisfactory to Seller when, in Seller's opinion, the financial condition of Buyer or other grounds for insecurity, including the filing of a petition for bankruptcy, warrant such action.

15. Force Majeure. Seller shall not be liable for any delay in fulfilling any order due to (a) fires, floods, strikes, or other labor disputes, accidents to machinery, acts of sabotage, riots, precedence or priorities granted at the request or for the benefit, directly or indirectly, of the federal or any state government or any subdivision or agency thereof, delays in transportation or lack of transportation facilities, restrictions imposed by federal or state legislation or rules of regulations thereunder; or (b) any cause beyond the control of Seller.

16. Ownership of Equipment. Unless otherwise agreed in a writing, all material, equipment, facilities, and special tooling, which term includes but is not limited to jigs, dies, fixtures, molds, patterns, special taps, special gauges, special test equipment, and manufacturing aids and replacements thereof, used in the manufacture of the products covered by any order shall remain

General information

Terms and conditions of sale

the property of Seller. Any material, tooling, and equipment furnished to Seller by Buyer shall be and remain the personal property of Buyer with the title to and right of possession remaining in Buyer.

17. Confidential Information. All information furnished or made available by Seller to Buyer in connection with a transaction shall be held in confidence by Buyer. Buyer agrees not to use such information or disclose such information to others without Seller's prior written consent. The obligations of this paragraph does not apply to any information which (a) at the time of disclosure was, or thereafter becomes, generally available to the public by publication or otherwise through no breach by Buyer of any obligation herein, (b) Buyer can show by written records was in Buyer's possession prior to disclosure by the disclosing party, (c) is legally made available to Buyer by or through a third party having no direct or indirect confidentiality obligation to Seller with respect to such information, (d) was independently developed by Buyer without use of any of Seller's confidential information, or (e) is required to be disclosed pursuant to applicable law.

18. Waiver. No waiver by Seller of any of these Terms and Conditions shall be effective unless explicitly set forth in writing and signed by Seller. No failure to exercise, or delay in exercising, any rights, remedy, power, or privilege arising from these Terms and Conditions shall operate or be construed as a waiver thereof, nor shall any single or partial exercise of any right, remedy, power, or privilege hereunder preclude any other or further exercise thereof or the exercise of any other right, remedy, power or privilege.

19. Assignment. No assignment of any right or interest or delegation of any obligation or performance of Buyer under this order may be made without the prior written consent of Seller. Any attempted assignment or delegation will be wholly void and totally ineffective for all purposes.

20. Choice of Law. All sales, agreements for sale, offers to sell, proposals, acknowledgments and contracts of sale, including, but not limited to, Purchase Orders accepted by Seller, shall be considered a contract under the laws of the State of Delaware, and the rights and duties of all persons, and the construction and effect of all provisions hereof, shall be governed by and construed according to the laws of the State of Delaware.

21. Integration Clause. These Terms and Conditions constitute the entirety of terms and conditions, except as set forth in paragraph one, governing the sale and purchase of products and services sold by Seller. No modification of these Terms and Conditions shall be of any force or effect unless in writing and signed Seller and Buyer. Buyer may desire to utilize its own form of acknowledgment or acceptance of these Terms and Conditions. However, the use of any such form shall be for convenience only. No modification of these Terms and Conditions shall be affected by the acknowledgment or acceptance of purchase orders, shipping instruction forms, bills of lading or any other document containing terms or conditions at variance with or in addition to those set forth herein, all such varying or additional terms being hereby objected to and rejected by Seller and deemed to be waived by Buyer.

March 2022

How to Order

Step A: Locate the part you are looking to replace in the appropriate exploded view drawing. Each part is given an item number.

Step B: Find the item number in the left column of the appropriate chart and determine part number.

Step C: If the description of your part also includes additional item numbers in parentheses, those items combine to make a kit. When ordering, please note that the part number listed for this item includes all items listed in the description. (Note: The additional item numbers in parentheses also reference parts in the exploded view drawing.)

Example

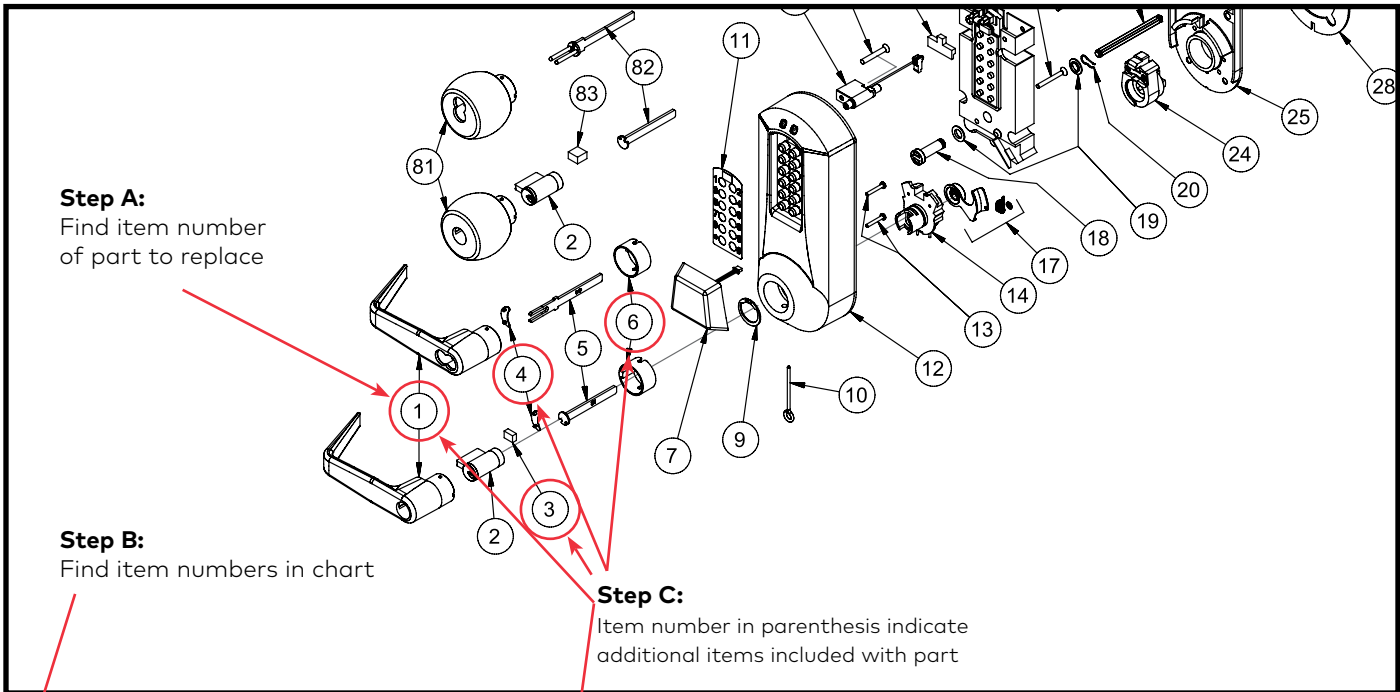

Item	Qty/Lock	Description	Finish	Part Number	List Price (USD)
1	1	Outside Lever, KIL (Includes 1 ea. #1, #3, #4, #6)	Satin Chrome	3422926D01	\$75.00
		Outside Lever, KIL (Includes 1 ea. #1, #3, #4, #6)	Bright Brass	342290301	\$75.00
		Outside Lever, KIL (Includes 1 ea. #1, #3, #4, #6)	Satin Brass	342290401	\$75.00
		Outside Lever, KIL (Includes 1 ea. #1, #3, #4, #6)	Dark Bronze	3422974401	\$75.00
		Outside Lever, KIL (Includes 1 ea. #1, #3, #4, #6)	Bright Chrome	3422902601	\$75.00

Where to Order

 Contact your local supplier or call
1.800.849.8324 or 1.336.725.1331

For More Information

www.dormakaba.us

The following are registered names and/or trademarks:
 Abloy®, Adams Rite®, Arrow®, ASSA®, Best®, Black & Decker®, Cal Royal®,
 Corbin Russwin®, Detex®, Dorma®, Precision®, Kaba®, Marks®, Medeco®, Monarch®,
 Precision®, Sargent®, Schlage®, Simplex®, Von Duprin®, Weiser®, Yale®

E-Plex 2000 Series





E-Plex®
203x

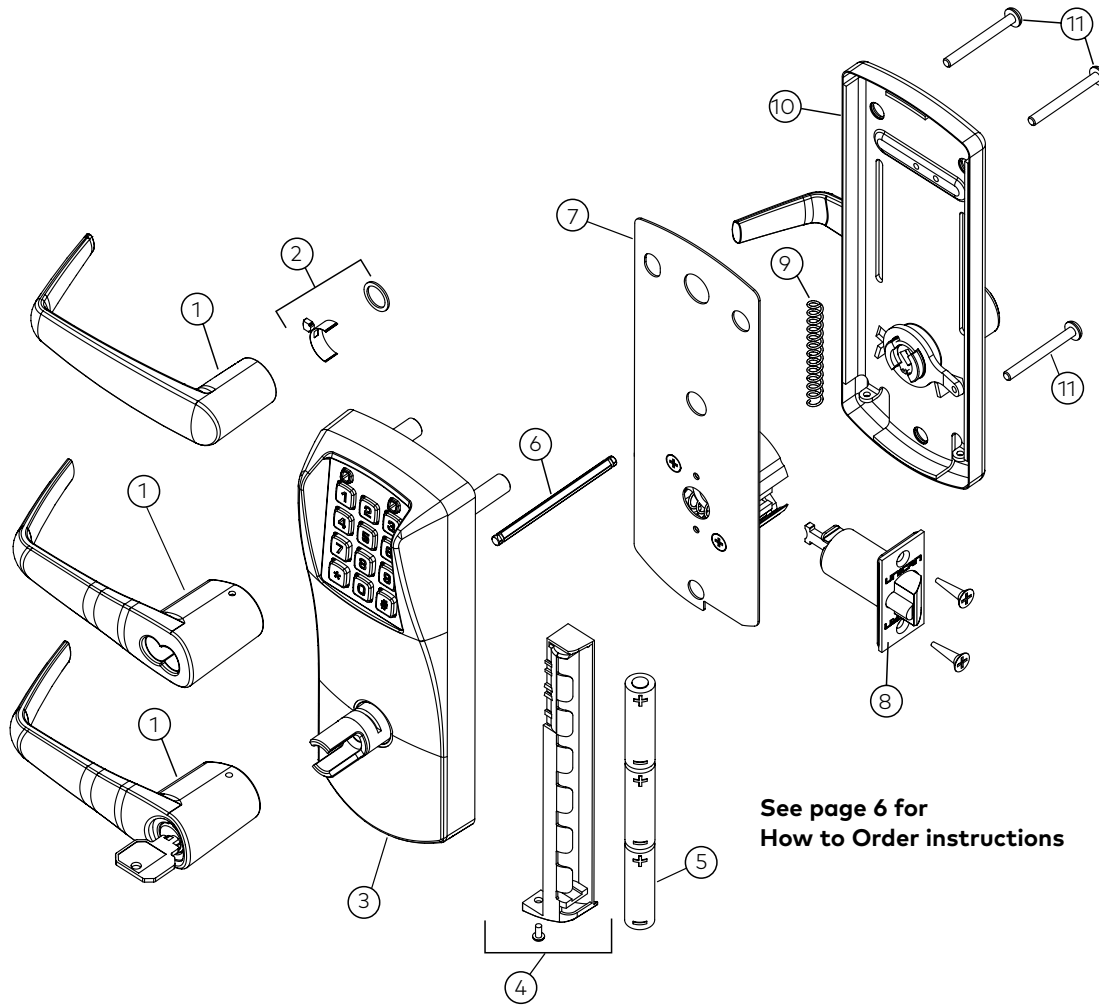

Item	Qty/Lock	Description	Finish	Part Number	List Price (USD)
1	1	Outside Lever, Non-Key Override	Satin Chrome	062-510983M-1626	\$107.00
		Outside Lever, Non-Key Override	Satin Brass	062-510983M-1606	\$107.00
		Outside Lever, Key Override	Satin Chrome	062-510783-1626	\$120.00
		Outside Lever, Key Override	Satin Brass	062-510783-1606	\$120.00
		Outside Lever, Key Override SFIC	Satin Chrome	069-512134-626	\$120.00
		Outside Lever, Key Override SFIC	Satin Brass	069-512134-606	\$120.00
2	1	Lever Catch / Bearing (Non-Key Override ONLY)		062-510510-K	\$27.00
3	1	Outside Housing, Non-Key Override	Satin Chrome	F66/20K010W-626	\$439.00
		Outside Housing, Non-Key Override	Satin Brass	F66/20K010W-606	\$453.00
		Outside Housing, Key Override KIL (Key-in-Lever)	Satin Chrome	F66/20E010W-626	\$466.00
		Outside Housing, Key Override KIL (Key-in-Lever)	Satin Brass	F66/20E010W-606	\$479.00
		Outside Housing, Key Override (Best) SFIC (Small Format Interchangeable Core)	Satin Chrome	F66/20B010W-626	\$466.00
		Outside Housing, Key Override (Best) SFIC (Small Format Interchangeable Core)	Satin Brass	F66/20B010W-606	\$479.00
4	1	Battery Holder and Screw		118-509978-K	\$32.00
5	3	Batteries, Alkaline AA		132-505601-K	\$27.00

E-Plex® 203x



Item	Qty/Lock	Description	Finish	Part Number	List Price (USD)
6	1	Spindle - Sold as part of Hardware Pack (Includes #6, #9, #11, Battery Screw)	Satin Chrome	062-510261-626	\$27.00
		Spindle - Sold as part of Hardware Pack (Includes #6, #9, #11, Battery Screw)	Satin Brass	062-510261-606	\$27.00
7	1	Back Plate w/ CDU		C76/001-000	\$107.00
8	1	1/2" (13 mm) Latch, Floating Front Face, 2 3/4" (70 mm) backset (Includes screws)	Satin Chrome	20416826D01	\$47.00
		1/2" (13 mm) Latch, Floating Front Face, 2 3/4" (70 mm) backset (Includes screws)	Satin Brass	2041680401	\$47.00
		1/2" (13 mm) Latch, Floating Front Face, 2 3/8" (60 mm) backset (Includes screws)	Satin Chrome	7518526D01	\$47.00
		1/2" (13 mm) Latch, Floating Front Face, 2 3/8" (60 mm) backset (Includes screws)	Satin Brass	751850401	\$47.00
9	1	Lever Return Spring - Sold as part of Hardware Pack (Includes #6, #9, #11, Battery Screw)	Satin Chrome	062-510261-626	\$27.00
		Lever Return Spring - Sold as part of Hardware Pack (Includes #6, #9, #11, Battery Screw)	Satin Brass	062-510261-606	\$27.00
10	1	Inside Housing (old # B76-C1EN10-626)	Satin Chrome	B76-N1EN10-626	\$87.00
		Inside Housing (old # B76-C1EN10-606)	Satin Brass	B76-N1EN10-606	\$100.00
11	1	Mounting Screws - Sold as part of Hardware Pack (Includes #6, #9, #11, Battery Screw)	Satin Chrome	062-510261A626	\$27.00
		Mounting Screws - Sold as part of Hardware Pack (Includes #6, #9, #11, Battery Screw)	Satin Brass	062-510261A606	\$27.00
12	1	Standard "T" Strike Kit (old # 20416726D01) not shown	Satin Chrome	20422726D01	\$14.00
		Standard "T" Strike Kit (old # 2041670301) not shown	Satin Brass	2042270401	\$14.00
Additional Kits & Accessories			Finish	Part Number	List Price (USD)
		ASA Strike for 4 7/8" (124 mm) Long Cutout (Includes screws)	Satin Chrome	20411926D01	\$15.00
		ASA Strike for 4 7/8" (124 mm) Long Cutout (Includes screws)	Satin Brass	2041190401	\$15.00
		Outdoor Kit		062-510180	\$20.00
		Thick Door Kit Upgrade (Includes #6, #9, #11, Battery Screw)	Satin Chrome	062-510189-626	\$14.00
		Thick Door Kit Upgrade (Includes #6, #9, #11, Battery Screw)	Satin Brass	062-510189-606	\$14.00
		Removal Tool (Lever Clip Removal)		138-510576	\$36.00
		Cylinder Caps, Kaba Logo		062-510804-2	\$16.00
		Cylinder Caps, No Logo		062-510804-1	\$16.00
		Key-in-Lever Cylinder (Lori 1539), Schlage "C" Keyway		118-509610-626	\$51.00
		Key-in-Lever Cylinder (Lori 1539), Schlage "C" Keyway		118-509610-606	\$51.00
		Mounting Screws - Sold as part of Hardware Pack (Includes #6, #9, #11, Battery Screw)	Satin Chrome	062-510261/626	\$27.00
		Mounting Screws - Sold as part of Hardware Pack (Includes #6, #9, #11, Battery Screw)	Satin Brass	062-510261/606	\$27.00
		Door Filler Plate, 14" (356mm) x 4 5/8" (117mm)	Stainless Steel	061-510201-630	\$75.00
		Door Filler Plate, 14" (356mm) x 4 5/8" (117mm)	Satin Brass	061-510201-906	\$75.00
		Door Filler Plate, 10 1/16" (256mm) x 3 3/4" (95mm)	Stainless Steel	061-510362-630	\$64.00
		Door Filler Plate, 10 1/16" (256mm) x 3 3/4" (95mm)	Satin Brass	061-510362-906	\$64.00
		E-Plex 2000 Acrylic Mount		EP2000ACLMT	\$353.00
		E-Plex 2000 Wood Mount		20305900041	\$191.00
		Security Screw Kit (Includes Bit)		062-511915	\$19.00
		Latch Extension Assembly (converts to 3 3/4" (95mm) Backset)		20402200001	\$43.00
		Latch Extension Assembly (converts to 5" (130mm) Backset)		20402300001	\$38.00
		Best Equivalent - Small Format Interchangeable Core		20148426D01	\$78.00
		Best Equivalent - Small Format Interchangeable Core		2014840301	\$78.00

E-Plex 3000 Series



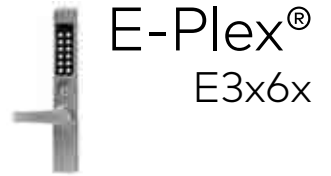

E-Plex®
E3x6x

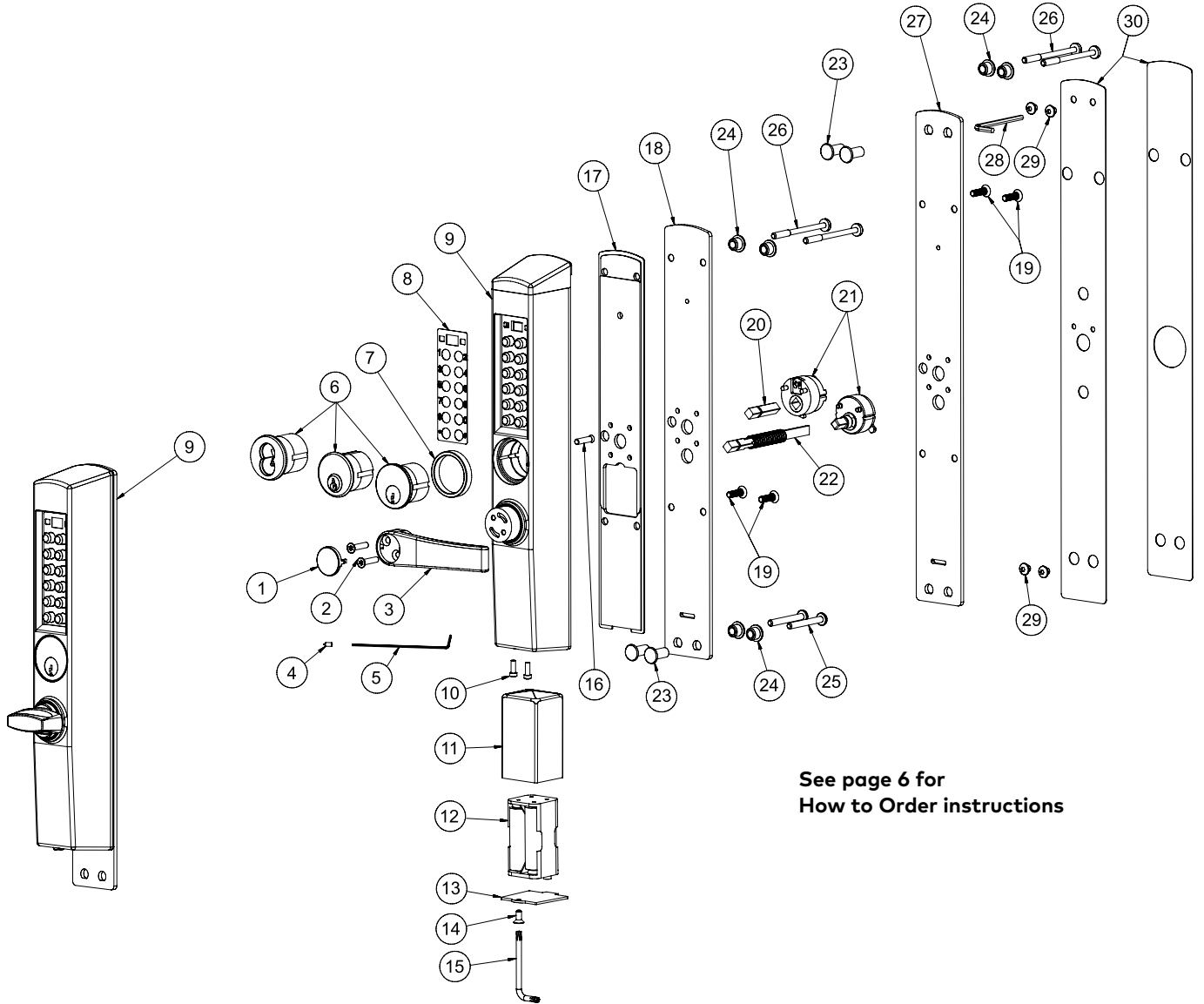

See page 6 for
How to Order instructions

Item	Qty/Lock	Description	Finish	Part Number	List Price (USD)
1	1	Lever Cap - Lever Cap Kit (Includes 1 ea. #1, #4, #5)	Satin Chrome	3429862601	\$19.00
		Lever Cap - Lever Cap Kit (Includes 1 ea. #1, #4, #5)	Dark Bronze	3429874401	\$19.00
2	2	Screw, 8-32 x 3/4", Pinned Torx (10 Pack)	Satin Chrome	5472500010	\$27.00
			Dark Bronze	5472500010	\$27.00
3	1	Lever Kit (Includes 1 ea. #1, #3, #4, #5, #15; 2 ea. #2)	Satin Chrome	7533162601	\$67.00
			Dark Bronze	7533174401	\$67.00
4	1	Set Screw, 4-40 NC x 1/4" Hex Hd (10 Pack)		20157200010	\$8.00
5	1	Hex Wrench, .050" x 2" - Lever Cap Kit (Includes 1 ea. #1, #4, #5)	Satin Chrome	3429862601	\$19.00
			Dark Bronze	3429874401	\$19.00

E-Plex® E3x6x



Item	Qty/Lock	Description	Finish	Part Number	List Price (USD)
6	1	Schlage Mortise Cylinder, "C" Keyway	Satin Chrome	5445026D01	\$48.00
		Schlage Mortise Cylinder, "C" Keyway	Dark Bronze	5445010B01	\$48.00
		Kaba Mortise Cylinder, Kaba 90 Keyway	Satin Chrome	5475926D01	\$48.00
		Kaba Mortise Cylinder, Kaba 90 Keyway	Dark Bronze	5475910B01	\$48.00
		SFIC Mortise Housing (Best 6-pin) (NO cylinder supplied)	Satin Chrome	5476026D01	\$48.00
		SFIC Mortise Housing (Best 6-pin) (NO cylinder supplied)	Dark Bronze	5476010B01	\$48.00
7	1	Cylinder Collar (Included with SFIC Mortise Housing Models Only)		n/a	
8	1	Fascia (E3xxx Only)		5468100001	\$14.00
9	1	E306x Housing Assembly, Complete for Lever Models (Includes 1 ea. #8, #9, #16, #17, #18)	Satin Chrome	7532562601	\$665.00
		E306x Housing Assembly, Complete for Lever Models (Includes 1 ea. #8, #9, #16, #17, #18)	Dark Bronze	7532574401	\$758.00
		E306x Housing Assembly with Remote Unlock, Complete for Lever Models (Includes 1 ea. #8, #9, #16, #17, #18)	Satin Chrome	7537062601	\$718.00
		E306x Housing Assembly with Remote Unlock, Complete for Lever Models (Includes 1 ea. #8, #9, #16, #17, #18)	Dark Bronze	7537074401	\$812.00
		E326x Housing Assembly, Complete for Lever Models (Includes 1 ea. #8, #9, #16, #17, #18)	Satin Chrome	7539662601	\$878.00
		E326x Housing Assembly, Complete for Lever Models (Includes 1 ea. #8, #9, #16, #17, #18)	Dark Bronze	7539674401	\$971.00
		E326x Housing Assembly with Remote Unlock, Complete for Lever Models (Includes 1 ea. #8, #9, #16, #17, #18)	Satin Chrome	7539762601	\$931.00
		E326x Housing Assembly with Remote Unlock, Complete for Lever Models (Includes 1 ea. #8, #9, #16, #17, #18)	Dark Bronze	7539774401	\$1,024.00
		E366x Housing Assembly, Complete for Lever Models (Includes 1 ea. #8, #9, #16, #17, #18)	Satin Chrome	7450362601	\$1,144.00
		E366x Housing Assembly, Complete for Lever Models (Includes 1 ea. #8, #9, #16, #17, #18)	Dark Bronze	7450374401	\$1,237.00
		E366x Housing Assembly with Remote Unlock, Complete for Lever Models - (Includes 1 ea. #8, #9, #16, #17, #18)	Satin Chrome	7450462601	\$1,197.00
		E366x Housing Assembly with Remote Unlock, Complete for Lever Models - (Includes 1 ea. #8, #9, #16, #17, #18)	Dark Bronze	7450474401	\$1,290.00
		E376x Housing Assembly, Complete for Lever Models (Includes 1 ea. #8, #9, #16, #17, #18)	Satin Chrome	7537262601	\$1,144.00
		E376x Housing Assembly, Complete for Lever Models (Includes 1 ea. #8, #9, #16, #17, #18)	Dark Bronze	7537274401	\$1,237.00
		E376x Housing Assembly with Remote Unlock, Complete for Lever Models (Includes 1 ea. #8, #9, #16, #17, #18)	Satin Chrome	7537362601	\$1,197.00
		E376x Housing Assembly with Remote Unlock, Complete for Lever Models (Includes 1 ea. #8, #9, #16, #17, #18)	Dark Bronze	7537374401	\$1,290.00
		E306x Housing Assembly, Complete for Thumbturn Models (Includes 1 ea. #8, #9, #16, #17, #18)	Satin Chrome	7532662601	\$665.00
		E306x Housing Assembly, Complete for Thumbturn Models (Includes 1 ea. #8, #9, #16, #17, #18)	Dark Bronze	7532674401	\$758.00
		E306x Housing Assembly with Remote Unlock, Complete for Thumbturn Models (Includes 1 ea. #8, #9, #16, #17, #18)	Satin Chrome	7537162601	\$718.00
		E306x Housing Assembly with Remote Unlock, Complete for Thumbturn Models (Includes 1 ea. #8, #9, #16, #17, #18)	Dark Bronze	7537174401	\$812.00
		E326x Housing Assembly, Complete for Thumbturn Models (Includes 1 ea. #8, #9, #16, #17, #18)	Satin Chrome	7539862601	\$878.00
		E326x Housing Assembly, Complete for Thumbturn Models (Includes 1 ea. #8, #9, #16, #17, #18)	Dark Bronze	7539874401	\$971.00



E-Plex®
E3x6x

Item	Qty/Lock	Description	Finish	Part Number	List Price (USD)
9	1	E326x Housing Assembly with Remote Unlock, Complete for Thumbturn Models (Includes 1 ea. #8, #9, #16, #17, #18)	Satin Chrome	7539962601	\$931.00
		E326x Housing Assembly with Remote Unlock, Complete for Thumbturn Models (Includes 1 ea. #8, #9, #16, #17, #18)	Dark Bronze	7539974401	\$1,024.00
		E366x Housing Assembly, Complete for Thumbturn Models (Includes 1 ea. #8, #9, #16, #17, #18)	Satin Chrome	7450562601	\$1,144.00
		E366x Housing Assembly, Complete for Thumbturn Models (Includes 1 ea. #8, #9, #16, #17, #18)	Dark Bronze	7450574401	\$1,237.00
		E366x Housing Assembly with Remote Unlock, Complete for Thumbturn Models (Includes 1 ea. #8, #9, #16, #17, #18)	Satin Chrome	7450662601	\$1,197.00
		E366x Housing Assembly with Remote Unlock, Complete for Thumbturn Models (Includes 1 ea. #8, #9, #16, #17, #18)	Dark Bronze	7450674401	\$1,290.00
		E376x Housing Assembly, Complete for Thumbturn Models (Includes 1 ea. #8, #9, #16, #17, #18)	Satin Chrome	7537462601	\$1,144.00
		E376x Housing Assembly, Complete for Thumbturn Models (Includes 1 ea. #8, #9, #16, #17, #18)	Dark Bronze	7537474401	\$1,237.00
		E376x Housing Assembly with Remote Unlock, Complete for Thumbturn Models (Includes 1 ea. #8, #9, #16, #17, #18)	Satin Chrome	7537562601	\$1,197.00
		E376x Housing Assembly with Remote Unlock, Complete for Thumbturn Models (Includes 1 ea. #8, #9, #16, #17, #18)	Dark Bronze	7537574401	\$1,290.00
10	2	Screw, Machine, Fil, 6-32 x 3/8" (10 Pack)		5473900010	\$11.00
11	1	Battery Boot - Battery Pack and Boot Kit (Includes 1 ea. #11, #12)		5468500001	\$22.00
12	1	Battery Pack - Battery Pack and Boot Kit (Includes 1 ea. #11, #12)		5468500001	\$22.00
13	1	Battery Cover - Battery Cover and Wrench Kit (Includes 1 ea. #13, #14, #15)	Black	245541901	\$16.00
14	1	Screw, 8-32 x 3/8", Pinned Torx (10 Pack)		5473700010	\$27.00
15	1	Anti-Tamper Torx Wrench - Battery Cover and Wrench Kit (Includes 1 ea. #13, #14, #15)	Black	245541901	\$16.00
16	1	Screw, 8-32 x 1/2", Flat C.S. Undersized (10 Pack)		5476900010	\$11.00
17	1	Moisture Barrier		5470200001	\$12.00
18	1	Mounting Plate (13-1/4" L)	Satin Chrome	2456562601	\$67.00
		Mounting Plate (13-1/4" L)	Dark Bronze	2456574401	\$67.00
19	4	Screw, #10-24 Fh Phillips, Base Screw (10 Pack)		5446100010	\$14.00
20	1	Mortise Gear Spindle		5470000001	\$19.00
21	1	Swing-Bolt Cam Assembly		7526200001	\$71.00
		Mortise Latch Cam Plug Assembly		7527100001	\$71.00
22	1	Exit Trim Spindle/Tailpiece (Includes spring)		7535700001	\$22.00
Additional Kits & Accessories			Finish	Part Number	List Price (USD)
23		Sex Nuts (10 Pack)	Satin Chrome	4422602210	\$30.00
		Sex Nuts (10 Pack)	Black	4422601210	\$30.00
24		Mounting Bushing (10 Pack)	Satin Chrome	4422902210	\$14.00
		Mounting Bushing (10 Pack)	Black	4422901910	\$14.00
25		Screw, #10-24 x 1-1/2", Phillips Hd (10 Pack)	Satin Chrome	5427502210	\$11.00
		Screw, #10-24 x 1-1/2", Phillips Hd (10 Pack)	Black	5427506810	\$11.00
26		Mounting Plate, Extended (15" L)	Satin Chrome	2454862601	\$73.00
		Mounting Plate, Extended (15" L)	Dark Bronze	2454874401	\$73.00
27		Screw, #10-24 x 2-3/8" Pan Hd (10 Pack)	Satin Chrome	5457926D10	\$14.00
		Screw, #10-24 x 2-3/8" Pan Hd (10 Pack)	Black	5457906810	\$14.00

E-Plex 5000 Series



E-Plex® 5x3x/5x5x Cylindrical



See page 6 for
How to Order instructions

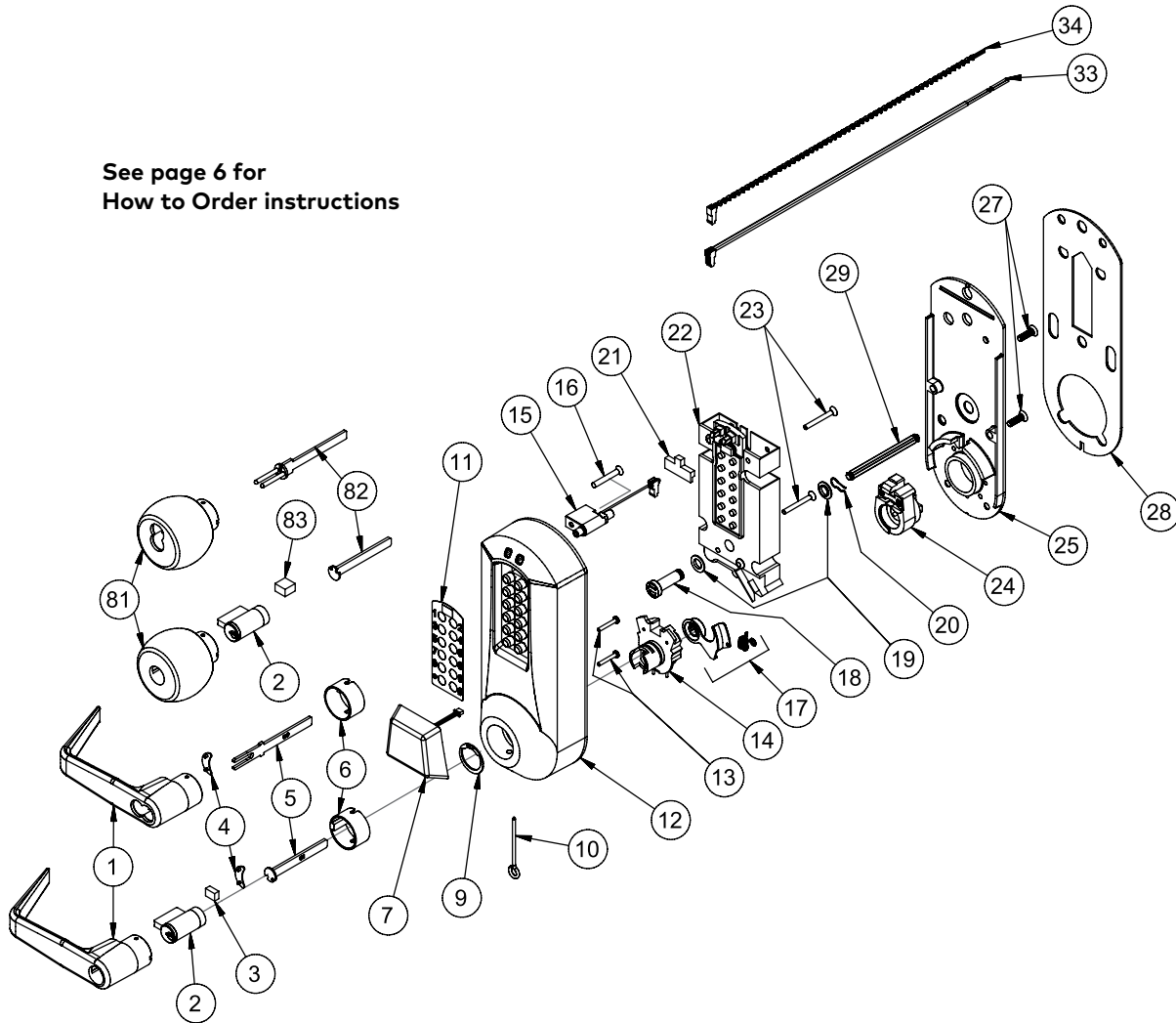

Item	Qty/Lock	Description	Finish	Part Number	List Price (USD)
1	1	Outside Lever, KIL (Includes 1 ea. #1, #3, #4, #6)	Satin Chrome	3422926D01	\$100.00
		Outside Lever, KIL (Includes 1 ea. #1, #3, #4, #6)	Bright Brass	342290301	\$100.00
		Outside Lever, KIL (Includes 1 ea. #1, #3, #4, #6)	Satin Brass	342290401	\$100.00
		Outside Lever, KIL (Includes 1 ea. #1, #3, #4, #6)	Dark Bronze	3422974401	\$100.00
		Outside Lever, KIL (Includes 1 ea. #1, #3, #4, #6)	Bright Chrome	3422902601	\$100.00
		Outside Lever, Schlage (Includes 1 ea. #1, #4, #6)	Satin Chrome	3423026D01	\$133.00
		Outside Lever, Schlage (Includes 1 ea. #1, #4, #6)	Bright Brass	342300301	\$133.00
		Outside Lever, Schlage (Includes 1 ea. #1, #4, #6)	Satin Brass	342300401	\$133.00
		Outside Lever, Schlage (Includes 1 ea. #1, #4, #6)	Dark Bronze	3423074401	\$133.00
		Outside Lever, Schlage (Includes 1 ea. #1, #4, #6)	Bright Chrome	3423002601	\$133.00
		Outside Lever, Corbin-Russwin (Includes 1 ea. #1, #4, #6)	Satin Chrome	3423126D01	\$133.00
		Outside Lever, Corbin-Russwin (Includes 1 ea. #1, #4, #6)	Bright Brass	342310301	\$133.00
		Outside Lever, Corbin-Russwin (Includes 1 ea. #1, #4, #6)	Satin Brass	342310401	\$133.00
		Outside Lever, Corbin-Russwin (Includes 1 ea. #1, #4, #6)	Dark Bronze	3423174401	\$133.00
		Outside Lever, Corbin-Russwin (Includes 1 ea. #1, #4, #6)	Bright Chrome	3423102601	\$133.00

E-Plex®

5x3x/5x5x Cylindrical

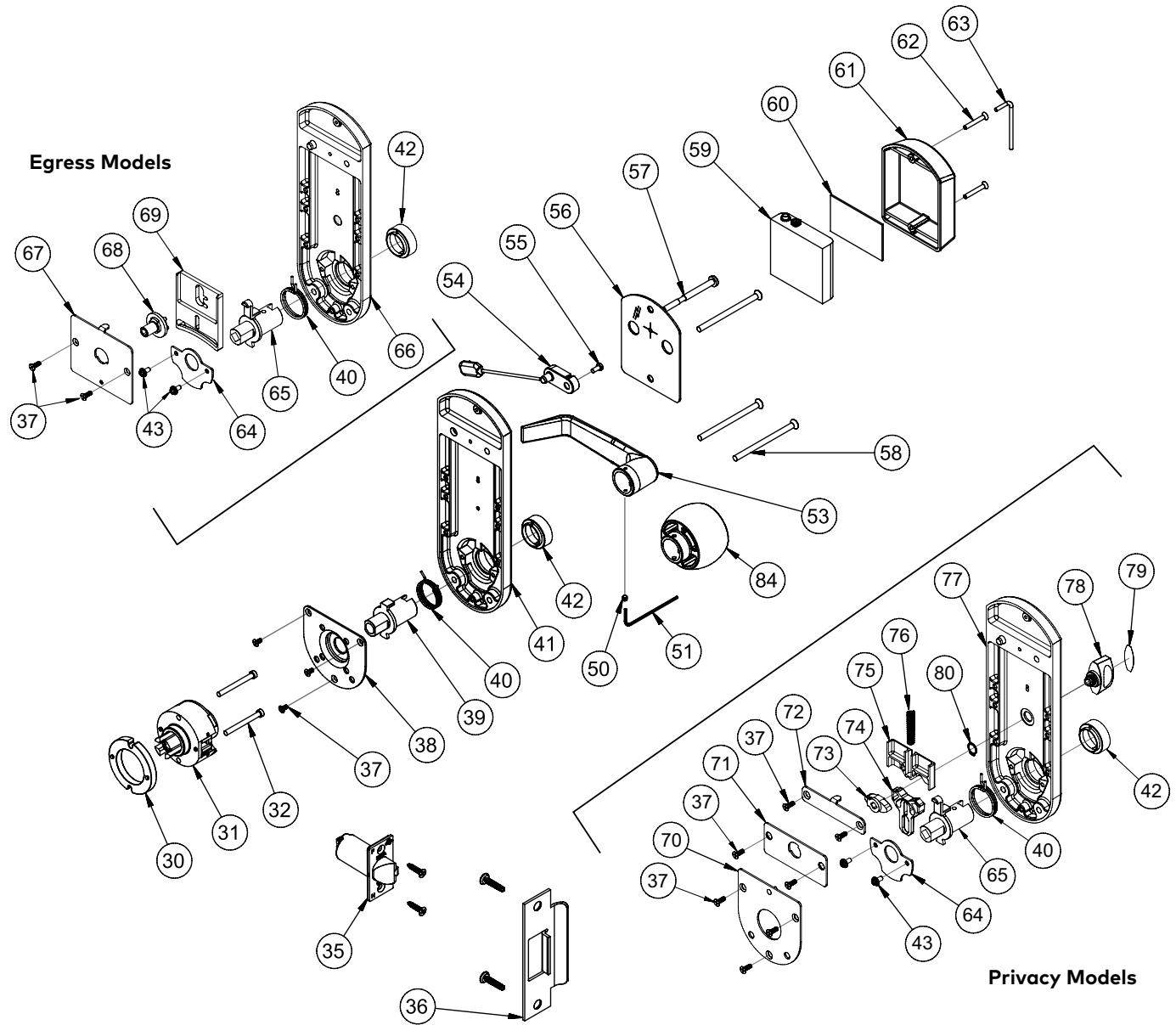

Item	Qty/Lock	Description	Finish	Part Number	List Price (USD)
1	1	Outside Lever, Sargent (Includes 1 ea. #1, #4, #6)	Satin Chrome	3423226D01	\$133.00
		Outside Lever, Sargent (Includes 1 ea. #1, #4, #6)	Bright Brass	342320301	\$133.00
		Outside Lever, Sargent (Includes 1 ea. #1, #4, #6)	Satin Brass	342320401	\$133.00
		Outside Lever, Sargent (Includes 1 ea. #1, #4, #6)	Dark Bronze	3423274401	\$133.00
		Outside Lever, Sargent (Includes 1 ea. #1, #4, #6)	Bright Chrome	3423202601	\$133.00
		Outside Lever, Best (Includes 1 ea. #1, #4, #6)	Satin Chrome	3423326D01	\$133.00
		Outside Lever, Best (Includes 1 ea. #1, #4, #6)	Bright Brass	342330301	\$133.00
		Outside Lever, Best (Includes 1 ea. #1, #4, #6)	Satin Brass	342330401	\$133.00
		Outside Lever, Best (Includes 1 ea. #1, #4, #6)	Dark Bronze	3423374401	\$133.00
		Outside Lever, Best (Includes 1 ea. #1, #4, #6)	Bright Chrome	3423302601	\$133.00



E-Plex®

5x3x/5x5x Cylindrical

Item	Qty/Lock	Description	Finish	Part Number	List Price (USD)
1	1	Outside Lever, ASSA/Medeco/Yale (Includes 1 ea. #1, #4, #6)	Satin Chrome	3423426D01	\$133.00
		Outside Lever, ASSA/Medeco/Yale (Includes 1 ea. #1, #4, #6)	Bright Brass	342340301	\$133.00
		Outside Lever, ASSA/Medeco/Yale (Includes 1 ea. #1, #4, #6)	Satin Brass	342340401	\$133.00
		Outside Lever, ASSA/Medeco/Yale (Includes 1 ea. #1, #4, #6)	Dark Bronze	3423474401	\$133.00
		Outside Lever, ASSA/Medeco/Yale (Includes 1 ea. #1, #4, #6)	Bright Chrome	3423402601	\$133.00
2	1	Kaba KIL Cylinder (w/keys), Keyed Different	Satin Chrome	5456226D01	\$51.00
		Kaba KIL Cylinder (w/keys), Keyed Different	Satin Brass	545620401	\$51.00
		Schlage KIL Cylinder (w/keys), Keyed Different	Satin Chrome	5456826D01	\$51.00
		Schlage KIL Cylinder (w/keys), Keyed Different	Satin Brass	545680401	\$51.00
		Kaba 90 Key Blank, 50/Box - Available from Ilco Division - Rocky Mount		KABA90	
3	1	Cylinder Keeper - Lever Sleeve Accessory Kit, KIL (Includes 1 ea. #3, #4, #6)		6470600001	\$19.00
4	1	Outside Lever Insert (10 Pack)		5452700010	\$14.00
5	1	Tailpiece Kit, KIL (Includes 5 various tailpieces) Cylindrical		7489200001	\$22.00
		Tailpiece Kit, Best (6 and 7-pin) Cylindrical		6472400001	\$16.00
		Tailpiece Kit, Corbin-Russwin/Sargent Cylindrical		2447100001	\$16.00
		Tailpiece Kit, Schlage Cylindrical		5461800001	\$16.00
		Tailpiece Kit, ASSA/Medeco/Yale Cylindrical		7483600001	\$16.00
6	1	Lever Sleeve - Lever Sleeve Accessory Kit, KIL (Includes 1 ea. #3, #4, #6, #83)		6470600001	\$19.00
		Lever Sleeve - Lever Sleeve Accessory Kit, IC (Includes 1 ea. #4, #6)		6470700001	\$19.00
7	1	Antenna - E56xx models - Antenna Assembly Kit (Includes 1 ea. #7; 2 ea. #13)		7540000001	\$64.00
		Antenna - E57xx models - Antenna Assembly Kit (Includes 1 ea #7; 2 ea. #13)		7511800001	\$64.00
		Antenna - E58xx and E59xx models - Antenna Assembly Kit (Includes 1 ea. #7; 2 ea. #13)		7527500001	\$64.00
9	1	External Retaining Ring (10 Pack)		5451700010	\$14.00
10	1	Accessory Tool Kit (Includes 1 ea. #10, #51, #63)		6471700001	\$14.00
11	1	Fascia - Keypad Label		055-51063801	\$14.00
12	1	Outside Housing Assembly - NO Reader Models 503x/505x/523x/525x (Includes 1 ea. #11, #12, and code buttons)	Satin Chrome	7494026D01	\$186.00
		Outside Housing Assembly - NO Reader Models 503x/505x/523x/525x (Includes 1 ea. #11, #12, and code buttons)	Bright Brass	749400301	\$186.00
		Outside Housing Assembly - NO Reader Models 503x/505x/523x/525x (Includes 1 ea. #11, #12, and code buttons)	Satin Brass	749400401	\$186.00
		Outside Housing Assembly - NO Reader Models 503x/505x/523x/525x (Includes 1 ea. #11, #12, and code buttons)	Dark Bronze	7494074401	\$186.00
		Outside Housing Assembly - NO Reader Models 503x/505x/523x/525x (Includes 1 ea. #11, #12, and code buttons)	Wrinkle Black	7494008301	\$186.00
		Outside Housing Assembly - NO Reader Models 503x/505x/523x/525x (Includes 1 ea. #11, #12, and code buttons)	Bright Chrome	7494002601	\$186.00
		Outside Housing Assembly - Reader Models 563x/565x/573x/575x/583x/585x/593x/595x (Includes 1 ea. #11, #12, and code buttons)	Satin Chrome	7514226D01	\$200.00
		Outside Housing Assembly - Reader Models 563x/565x/573x/575x/583x/585x/593x/595x (Includes 1 ea. #11, #12, and code buttons)	Bright Brass	751420301	\$200.00
		Outside Housing Assembly - Reader Models 563x/565x/573x/575x/583x/585x/593x/595x (Includes 1 ea. #11, #12, and code buttons)	Satin Brass	751420401	\$200.00
		Outside Housing Assembly - Reader Models 563x/565x/573x/575x/583x/585x/593x/595x (Includes 1 ea. #11, #12, and code buttons)	Dark Bronze	7514274401	\$200.00
		Outside Housing Assembly - Reader Models 563x/565x/573x/575x/583x/585x/593x/595x (Includes 1 ea. #11, #12, and code buttons)	Wrinkle Black	7514208301	\$200.00
		Outside Housing Assembly - Reader Models 563x/565x/573x/575x/583x/585x/593x/595x (Includes 1 ea. #11, #12, and code buttons)	Bright Chrome	7514202601	\$200.00

E-Plex®

5x3x/5x5x Cylindrical



Item	Qty/Lock	Description	Finish	Part Number	List Price (USD)
13	2	Screw, 4-40 x .750, Pan, Patch-lock - Antenna Screw (10 Pack)		5461600010	\$14.00
14	1	Outside Driver Assembly (Includes 1 ea. #9, #14)		7510000001	\$48.00
15	1	Outside Terminal Block Assembly (Includes 1 ea. #15, #16)		6470900001	\$32.00
16	1	Screw, 8-32 x 1 1/4" for Terminal Block (10 Pack)		5457400010	\$14.00
17	1	Key Override Detector Kit (Includes detector, spring and spring retainer)		6471000001	\$14.00
18	1	Magnetic Cam - Magnetic Cam Kit for Deadbolt or Door Egress Monitoring Models (Includes 1 ea. #18, #20; 2 ea. #19)		6475800001	\$54.00
19	2	Nylon Washer - Magnetic Cam Kit for Deadbolt or Door Egress Monitoring Models (Includes 1 ea. #18, #20; 2 ea. #19)		6475800001	\$54.00
20	1	Spring Clip - Magnetic Cam Kit for Deadbolt or Door Egress Monitoring Models (Includes 1 ea. #18, #20; 2 ea. #19)		6475800001	\$54.00
21	1	"T" Guard for Remote Release		3428200001	\$16.00
22	1	Electronic Module Kit for E50xx models (Includes 1 ea. #22, #28; 2 ea. #23)		6470000001	\$433.00
		Electronic Module Kit for E52xx models (Includes 1 ea. #22, #28; 2 ea. #23)		6475900001	\$532.00
		Electronic Module Kit for E56xx models (Includes 1 ea. #22, #28; 2 ea. #23)		6480900001	\$772.00
		Electronic Module Kit for E57xx models (Includes 1 ea. #22, #28; 2 ea. #23)		6476000001	\$665.00
		Electronic Module Kit for E58xx models (Includes 1 ea. #22, #28; 2 ea. #23)		6480400001	\$772.00
		Electronic Module Kit for E59xx models (Includes 1 ea. #22, #28; 2 ea. #23)		6480500001	\$772.00
23	2	Screw, 6-32 x 1 1/4" - Module Screw (10 Pack)		5458300010	\$14.00
24	1	Extension Sleeve Assembly		7491200001	\$38.00
25	1	Universal Outside Base		3432800001	\$54.00
27	2	Screw, #10-24 x .625" Phillips, Outside Base (10 Pack)		5446100010	\$14.00
28	1	Outside Base Moisture Barrier		5458800001	\$12.00
29	1	Privacy Spindle - Privacy Spindle Kit (E5x5x privacy models only) (Includes 1 ea. #29)		6480700001	\$19.00
30	1	Door Thickness Spacer - Spacer Kit (Includes 2 ea. #30, #32)		6471200001	\$14.00
31	1	Cylindrical Drive Unit (CDU)		7484100001	\$64.00
32	2	Screw, Phillips 8-32 x 1 3/8" (35 mm) Connecting Screw - Spacer Kit (Includes 2 ea. #30, #32)		6471200001	\$14.00
		Screw, Phillips 8-32 x 1 5/8" (41 mm) Connecting Screw - Spacer Kit (Includes 2 ea. #30, #32)		6471200001	\$14.00
33	1	Remote Unlock Cable Kit - Remote Unlock Cable Kit		7510500001	\$54.00
34	1	Door Monitoring Sensor Cable Kit (59xx Only)		9400700001	\$54.00
35	1	1/2" (13 mm) Latch, Floating Front Face, 2 3/4" (70 mm) backset (Includes screws)	Satin Chrome	20416826D01	\$47.00
		1/2" (13 mm) Latch, Floating Front Face, 2 3/4" (70 mm) backset (Includes screws)	Bright Brass	2041680301	\$47.00
		1/2" (13 mm) Latch, Floating Front Face, 2 3/4" (70 mm) backset (Includes screws)	Satin Brass	2041680401	\$47.00
		1/2" (13 mm) Latch, Floating Front Face, 2 3/4" (70 mm) backset (Includes screws)	Dark Bronze	20416874401	\$47.00
		3/4" (19 mm) Latch, Floating Front Face, 2 3/4" (70 mm) backset (Includes screws)	Satin Chrome	20114426D01	\$80.00
		3/4" (19 mm) Latch, Floating Front Face, 2 3/4" (70 mm) backset (Includes screws)	Bright Brass	2011440301	\$80.00
		3/4" (19 mm) Latch, Floating Front Face, 2 3/4" (70 mm) backset (Includes screws)	Dark Bronze	20114474401	\$80.00
		1/2" (13 mm) Latch, Floating Front Face, 2 3/8" (60 mm) backset (Includes screws)	Satin Chrome	7518526D01	\$47.00



E-Plex®

5x3x/5x5x Cylindrical

Item	Qty/Lock	Description	Finish	Part Number	List Price (USD)
35	1	1/2" (13 mm) Latch, Floating Front Face, 2 3/8" (60 mm) backset (Includes screws)	Bright Brass	751850301	\$47.00
		1/2" (13 mm) Latch, Floating Front Face, 2 3/8" (60 mm) backset (Includes screws)	Satin Brass	751850401	\$47.00
		1/2" (13 mm) Latch, Floating Front Face, 2 3/8" (60 mm) backset (Includes screws)	Dark Bronze	7518574401	\$47.00
36	1	ASA Strike for 4 7/8" (124 mm) Long Cutout (Includes screws)	Satin Chrome	20411926D01	\$15.00
		ASA Strike for 4 7/8" (124 mm) Long Cutout (Includes screws)	Bright Brass	2041190301	\$15.00
		ASA Strike for 4 7/8" (124 mm) Long Cutout (Includes screws)	Satin Brass	2041190401	\$15.00
		ASA Strike for 4 7/8" (124 mm) Long Cutout (Includes screws)	Dark Bronze	20411974401	\$24.00
		Standard "T" Strike Plate (Includes Screws)	Satin Chrome	20422726D01	\$14.00
		Standard "T" Strike Plate (Includes Screws)	Bright Brass	2042270301	\$14.00
		Standard "T" Strike Plate (Includes Screws)	Satin Brass	2042270401	\$14.00
		Standard "T" Strike Plate (Includes Screws)	Dark Bronze	20422774401	\$24.00
37	2	Screw, #6-32 x 3/8", Screw Pack (10 ea. 6-32 x 3/8", 5/16", 7/16")		6477600010	\$14.00
38	1	Inside Driver Cover Plate		2446100001	\$15.00
39	1	Inside Driver - Cylindrical Models (EXCLUDES Privacy and Door Egress Monitoring Models)		5445400001	\$48.00
40	2	Lever Return Spring (Fits Inside and Outside Drivers) (10 Pack)		5448200010	\$27.00
41	1	Inside Housing for Cylindrical Models (Housing Only)	Satin Chrome	3422026D01	\$100.00
		Inside Housing for Cylindrical Models (Housing Only)	Bright Brass	342200301	\$100.00
		Inside Housing for Cylindrical Models (Housing Only)	Satin Brass	342200401	\$100.00
		Inside Housing for Cylindrical Models (Housing Only)	Dark Bronze	3422074401	\$100.00
		Inside Housing for Cylindrical Models (Housing Only)	Wrinkle Black	3422008301	\$100.00
		Inside Housing for Cylindrical Models (Housing Only)	Bright Chrome	3422002601	\$100.00
		Inside Housing Kit, Complete (Includes 1 ea. #38, #39, #40, #41, #42; 2 ea. #37)	Satin Chrome	7493526D01	\$133.00
		Inside Housing Kit, Complete (Includes 1 ea. #38, #39, #40, #41, #42; 2 ea. #37)	Bright Brass	749350301	\$133.00
		Inside Housing Kit, Complete (Includes 1 ea. #38, #39, #40, #41, #42; 2 ea. #37)	Satin Brass	749350401	\$133.00
		Inside Housing Kit, Complete (Includes 1 ea. #38, #39, #40, #41, #42; 2 ea. #37)	Dark Bronze	7493574401	\$133.00
		Inside Housing Kit, Complete (Includes 1 ea. #38, #39, #40, #41, #42; 2 ea. #37)	Wrinkle Black	7493508301	\$133.00
		Inside Housing Kit, Complete (Includes 1 ea. #38, #39, #40, #41, #42; 2 ea. #37)	Bright Chrome	7493502601	\$133.00
42	1	Housing Bearing (10 Pack)		3419100010	\$14.00
43	1	Screw, #6-32 x 5/16", Pan hd, SEM - Screw Pack (10 ea. 6-32 x 3/8", 5/16", 7/16")		6477600001	\$14.00
50	2	Set Screw, Inside Lever (10 Pack)		5446300010	\$14.00
51	1	Tool Accessory Kit (Includes 1 ea. of #10, #51, #63)		6471700001	\$14.00
53	1	Inside Lever - Inside Lever Kit (Includes 1 ea. #50, #51, #53)	Satin Chrome	3418626D01	\$73.00
		Inside Lever - Inside Lever Kit (Includes 1 ea. #50, #51, #53)	Bright Brass	341860301	\$73.00
		Inside Lever - Inside Lever Kit (Includes 1 ea. #50, #51, #53)	Satin Brass	341860401	\$73.00
		Inside Lever - Inside Lever Kit (Includes 1 ea. #50, #51, #53)	Dark Bronze	3418674401	\$73.00
		Inside Lever - Inside Lever Kit (Includes 1 ea. #50, #51, #53)	Bright Chrome	3418602601	\$73.00
54	1	Inside Terminal Block - Inside Terminal Block Kit (Includes 1 ea. #54, #55, #56)		6471400001	\$32.00

E-Plex®

5x3x/5x5x Cylindrical



Item	Qty/Lock	Description	Finish	Part Number	List Price (USD)
55	1	Screw, Inside Pan hd Phil 6-32 x 5/16" MS (10 Pack)		5457800010	\$14.00
56	1	Inside Housing Moisture Barrier - Inside Terminal Block Kit (Includes 1 ea. #54, #55, #56)		6471400001	\$32.00
57	1	Lectro Bolt - Mounting Screw Kit (Includes 3 ea. #57, 9 ea. #58) (3 different lengths)	Satin Chrome	6471626D01	\$20.00
		Lectro Bolt - Mounting Screw Kit (Includes 3 ea. #57, 9 ea. #58) (3 different lengths)	Bright Brass	647160301	\$20.00
58	3	Mounting Screw - Mounting Screw Kit (Includes 3 ea. #57, 9 ea. #58)(3 different lengths)	Satin Chrome	6471626D01	\$20.00
		Mounting Screw - Mounting Screw Kit (Includes 3 ea. #57, 9 ea. #58)(3 different lengths)	Bright Brass	647160301	\$20.00
59	1	Battery Pack (Includes 4 Alkaline "Only" AA Batteries)		5456000001	\$19.00
60	1	Battery Pad - Battery Cover Kit (Includes 1 ea. #60, #61)		6471500001	\$14.00
61	1	Battery Cover - Battery Cover Kit (Includes 1 ea. #60, #61)		6471500001	\$14.00
		Battery Pack and Cover Kit (Includes 1 ea. #59, #60, #61, #63; 2 ea. #62)		6472300001	\$46.00
62	2	Battery Cover Screws (Tamper Proof) (10 Pack)		5455400010	\$16.00
63	1	Accessory Tool Kit (Includes 1 ea. #10, #51, #63)		6471700001	\$14.00
64	1	Inside Driver Cover Plate		2452300001	\$14.00
65	1	Inside Driver		5460900001	\$48.00
66	1	Inside Housing ONLY (E5966 Door Egress Monitoring Models Only)	Satin Chrome	3431526D01	\$113.00
		Inside Housing ONLY (E5966 Door Egress Monitoring Models Only)	Bright Brass	343150301	\$113.00
		Inside Housing ONLY (E5966 Door Egress Monitoring Models Only)	Satin Brass	343150401	\$113.00
		Inside Housing ONLY (E5966 Door Egress Monitoring Models Only)	Dark Bronze	3431574401	\$113.00
		Inside Housing ONLY (E5966 Door Egress Monitoring Models Only)	Wrinkle Black	3431508301	\$113.00
		Inside Housing ONLY (E5966 Door Egress Monitoring Models Only)	Bright Chrome	3431502601	\$113.00
		Inside Housing Assembly, Complete (Door Egress Monitoring Models Only) (Includes 1 ea. #40, #42, #54, #55, #56, #64, #65, #66, #67, #68, #69; 2 ea. #37, #43)	Satin Chrome	7529726D01	\$200.00
		Inside Housing Assembly, Complete (Door Egress Monitoring Models Only) (Includes 1 ea. #40, #42, #54, #55, #56, #64, #65, #66, #67, #68, #69; 2 ea. #37, #43)	Bright Brass	752970301	\$200.00
		Inside Housing Assembly, Complete (Door Egress Monitoring Models Only) (Includes 1 ea. #40, #42, #54, #55, #56, #64, #65, #66, #67, #68, #69; 2 ea. #37, #43)	Satin Brass	752970401	\$200.00
		Inside Housing Assembly, Complete (Door Egress Monitoring Models Only) (Includes 1 ea. #40, #42, #54, #55, #56, #64, #65, #66, #67, #68, #69; 2 ea. #37, #43)	Dark Bronze	7529774401	\$200.00
67	1	Inside Housing Cover Plate (Door Egress Monitoring Models Only)		5478200001	\$14.00
		Egress Indicator Cam (Door Egress Monitoring Models Only)		3431400001	\$27.00
68	1	Egress Indicator Slide (Door Egress Monitoring Models Only)		5473000001	\$24.00
69	1	Pivot Plate Assembly (E5x5x Privacy Models Only)		2457100001	\$14.00
70	1	Reversible Stop Plate (E5x5x Privacy Models Only)		2456800001	\$14.00
71	1	Upper Tab Plate (E5x5x Privacy Models Only)		2456700001	\$11.00
72	1	Privacy Cam (E5x5x Privacy Models Only)		3431000001	\$11.00
73	1	Privacy Pivot Actuator (E5x5x Privacy Models Only)		5462400001	\$14.00



E-Plex®

5x3x/5x5x Cylindrical

Item	Qty/Lock	Description	Finish	Part Number	List Price (USD)		
75	1	Privacy Kickoff Slide (E5x5x Privacy Models Only)		5462100001	\$14.00		
76	1	Privacy Spring (E5x5x Privacy Models Only)		5462200010	\$8.00		
77	1	Inside Housing ONLY (E5x5x Privacy Models Only)	Satin Chrome	3428126D01	\$101.00		
		Inside Housing ONLY (E5x5x Privacy Models Only)	Bright Brass	342810301	\$101.00		
		Inside Housing ONLY (E5x5x Privacy Models Only)	Satin Brass	342810401	\$101.00		
		Inside Housing ONLY (E5x5x Privacy Models Only)	Dark Bronze	3428174401	\$101.00		
		Inside Housing ONLY (E5x5x Privacy Models Only)	Wrinkle Black	3428108301	\$101.00		
		Inside Housing ONLY (E5x5x Privacy Models Only)	Bright Chrome	3428102601	\$101.00		
		Inside Housing, Complete (E5x5x Privacy Models Only) (Includes 1 ea. #40, #42, #64, #65, #70, #71, #72, #73, #74, #75, #76, #77, #78, #79, #80; 2 ea. #43; 7 ea. #37)	Satin Chrome	7515026D01	\$200.00		
		Inside Housing, Complete (E5x5x Privacy Models Only) (Includes 1 ea. #40, #42, #64, #65, #70, #71, #72, #73, #74, #75, #76, #77, #78, #79, #80; 2 ea. #43; 7 ea. #37)	Bright Brass	751500301	\$200.00		
		Inside Housing, Complete (E5x5x Privacy Models Only) (Includes 1 ea. #40, #42, #64, #65, #70, #71, #72, #73, #74, #75, #76, #77, #78, #79, #80; 2 ea. #43; 7 ea. #37)	Satin Brass	751500401	\$200.00		
		Inside Housing, Complete (E5x5x Privacy Models Only) (Includes 1 ea. #40, #42, #64, #65, #70, #71, #72, #73, #74, #75, #76, #77, #78, #79, #80; 2 ea. #43; 7 ea. #37)	Dark Bronze	7515074401	\$200.00		
78	1	Turn Knob (Includes 1 ea. #78, #79)	Satin Chrome	3427926D01	\$40.00		
		Turn Knob (Includes 1 ea. #78, #79)	Bright Brass	342790301	\$40.00		
		Turn Knob (Includes 1 ea. #78, #79)	Dark Bronze	3427974401	\$40.00		
		Privacy Label (E5x5x Privacy Models Only)		PKG3099	\$8.00		
		80	1	Retaining Ring (10 Pack)		20144000010	\$14.00
		81	1	Outside Knob Kit, KIK (Includes 1 ea. #6, #81, #83)	Satin Chrome	3424626D01	\$100.00
				Outside Knob Kit, KIK (Includes 1 ea. #6, #81, #83)	Bright Brass	342460301	\$100.00
				Outside Knob Kit, KIK (Includes 1 ea. #6, #81, #83)	Satin Brass	342460401	\$100.00
				Outside Knob Kit, KIK (Includes 1 ea. #6, #81, #83)	Dark Bronze	3424674401	\$100.00
				Outside Knob Kit, KIK (Includes 1 ea. #6, #81, #83)	Bright Chrome	3424602601	\$100.00
Outside Knob Kit, Best (Includes 1 ea. #6, #81)	Satin Chrome			3424826D01	\$133.00		
Outside Knob Kit, Best (Includes 1 ea. #6, #81)	Bright Brass			342480301	\$133.00		
Outside Knob Kit, Best (Includes 1 ea. #6, #81)	Satin Brass			342480401	\$133.00		
Outside Knob Kit, Best (Includes 1 ea. #6, #81)	Dark Bronze			3424874401	\$133.00		
Outside Knob Kit, Best (Includes 1 ea. #6, #81)	Bright Chrome			3424802601	\$133.00		
Outside Knob Kit, Schlage (Includes 1 ea. #6, #81)	Satin Chrome			3424926D01	\$133.00		
Outside Knob Kit, Schlage (Includes 1 ea. #6, #81)	Bright Brass			342490301	\$133.00		
Outside Knob Kit, Schlage (Includes 1 ea. #6, #81)	Satin Brass			342490401	\$133.00		
Outside Knob Kit, Schlage (Includes 1 ea. #6, #81)	Dark Bronze			3424974401	\$133.00		
Outside Knob Kit, Schlage (Includes 1 ea. #6, #81)	Bright Chrome			3424902601	\$133.00		
Outside Knob Kit, Sargent (Includes 1 ea. #6, #81)	Satin Chrome			3424526D01	\$133.00		
Outside Knob Kit, Sargent (Includes 1 ea. #6, #81)	Bright Brass			342450301	\$133.00		
Outside Knob Kit, Sargent (Includes 1 ea. #6, #81)	Satin Brass			342450401	\$133.00		

E-Plex® 5x3x/5x5x Cylindrical



Item	Qty/Lock	Description	Finish	Part Number	List Price (USD)
81	1	Outside Knob Kit, Sargent (Includes 1 ea. #6, #81)	Dark Bronze	3424574401	\$133.00
		Outside Knob Kit, Sargent (Includes 1 ea. #6, #81)	Bright Chrome	3424502601	\$133.00
		Outside Knob Kit, Corbin-Russwin (Includes 1 ea. #6, #81)	Satin Chrome	3424426D01	\$133.00
		Outside Knob Kit, Corbin-Russwin (Includes 1 ea. #6, #81)	Bright Brass	342440301	\$133.00
		Outside Knob Kit, Corbin-Russwin (Includes 1 ea. #6, #81)	Satin Brass	342440401	\$133.00
		Outside Knob Kit, Corbin-Russwin (Includes 1 ea. #6, #81)	Dark Bronze	3424474401	\$133.00
		Outside Knob Kit, Corbin-Russwin (Includes 1 ea. #6, #81)	Bright Chrome	3424402601	\$133.00
		Outside Knob Kit, ASSA/Medeco/Yale (Includes 1 ea. #6, #81)	Satin Chrome	3425026D01	\$133.00
		Outside Knob Kit, ASSA/Medeco/Yale (Includes 1 ea. #6, #81)	Bright Brass	342500301	\$133.00
		Outside Knob Kit, ASSA/Medeco/Yale (Includes 1 ea. #6, #81)	Satin Brass	342500401	\$133.00
		Outside Knob Kit, ASSA/Medeco/Yale (Includes 1 ea. #6, #81)	Dark Bronze	3425074401	\$133.00
		Outside Knob Kit, ASSA/Medeco/Yale (Includes 1 ea. #6, #81)	Bright Chrome	3425002601	\$133.00
		82	1	Tailpiece Kit, Best Knob (6 and 7-pin)	
Tailpiece Kit, Corbin-Russwin Knob				7498900001	\$16.00
Tailpiece Kit, Sargent Knob				7499000001	\$16.00
Tailpiece Kit, ASSA/Medeco/Yale Knob				7498700001	\$19.00
Tailpiece Kit, Schlage Knob				5461800001	\$14.00
83	1	Knob Cylinder Keeper (Includes 1 ea. #3, #4, #6, #83)		6470600001	\$19.00
84	1	Inside Knob - Inside Knob Kit (Includes 1 ea. #50, #51, #84)	Satin Chrome	3424726D01	\$73.00
		Inside Knob - Inside Knob Kit (Includes 1 ea. #50, #51, #84)	Bright Brass	342470301	\$73.00
		Inside Knob - Inside Knob Kit (Includes 1 ea. #50, #51, #84)	Satin Brass	342470401	\$73.00
		Inside Knob - Inside Knob Kit (Includes 1 ea. #50, #51, #84)	Dark Bronze	3424774401	\$73.00
		Inside Knob - Inside Knob Kit (Includes 1 ea. #50, #51, #84)	Bright Chrome	3424702601	\$73.00
Additional Kits & Accessories			Finish	Part Number	List Price (USD)
Installation Hardware Kit (Includes 1 ea. #3, #4, #6, #10, #30, #51, #83; 2 ea. #32, #50; 1 ea. #57 (3 lengths); 3 ea. #58 (3 lengths))			Satin Chrome	7494426D01	\$40.00
Installation Hardware Kit (Includes 1 ea. #3, #4, #6, #10, #30, #51, #83; 2 ea. #32, #50; 1 ea. #57 (3 lengths); 3 ea. #58 (3 lengths))			Bright Brass	749440301	\$40.00
Product Documentation Kit				PKG3033	\$20.00
Tamper Proof Screw Kit (2 ea. of 3 lengths) (Includes Wrench)			Satin Chrome	6469226D01	\$30.00
Tamper Proof Screw Kit (2 ea. of 3 lengths) (Includes Wrench)			Bright Brass	646920301	\$30.00
Lubriplate Aero Grease Tubes				6475400001	\$18.00
E-Plex 5000 Standard Software Kit (Includes PC M-unit kit and software discs) (Excel-Based Templates) (300 users per lock)				EP-0300-001	*
E-Plex 5200/5700 Enterprise Software Kit (Includes PC M-unit kit and software discs) (3,000 users per lock)				EP-EPRISE1-001	*
E-Plex 5200/5700 Enterprise Demo Software (90 day expiry)				EP-EPRISE-DEMO	*
E-Plex 5700 USB Prox Reader/Enroller				5456100041	\$638.00
E-Plex 5800 FIPS/DESFire Card Reader/Enroller				120-ENFIPS-000	\$339.00
E-Plex 5800 OCSP FIPS Software				EP-OCSP-FIPS-SW	*
E-Plex 5800 General FIPS Software				EP-GEN-FIPS-SW	*
HID Proxcard II Proximity Access Card #1326M - Not Printable, with Slot (minimum order 100 pcs)				065-101066	*
HID ISO Prox II Card (PVC-31 mils) #1336 - Printable, NO Slot (minimum 100 pcs)				065-507143	*
HID DuoProx (PVC-31 mils) High C/Proximity #1336 - Printable, NO Slot (minimum 100 pcs)				065-507144	\$12.00



E-Plex®

5x3x/5x5x Cylindrical

Additional Kits & Accessories	Finish	Part Number	List Price (USD)
HID Prox KEY II #1346 (FOB) (minimum order 100 pcs)		120-508051	*
MicroProx Tag Proximity #1391 (Adhesive Backed Disc) (minimum order 100 pieces)		065-511072	*
DESFire 2K Smart Card (for use with 3600/5600/5800)		352-DESFIR-02K	*
Wrap Plate, 10.5" (267mm) x 5" (127mm)	Satin Chrome	20423126D41	\$84.00
Wrap Plate, 10.5" (267mm) x 5" (127mm)	Bright Brass	2042310341	\$84.00
Wrap Plate, 15" (381mm) x 5" (127mm)	Satin Chrome	20423226D41	\$120.00
Wrap Plate, 15" (381mm) x 5" (127mm)	Bright Brass	2042320341	\$120.00
Latch Extension Assembly - Converts to 3 3/4" (95mm) backset		20402200001	\$43.00
Latch Extension Assembly - Converts to 5" (130mm) backset		20402300001	\$38.00
Best Equivalent Small Format Interchangeable Core	Satin Chrome	20148426D01	\$78.00
Best Equivalent Small Format Interchangeable Core	Bright Brass	2014840301	\$78.00
Installation Jig (for use with E5000/5000/1000/L1000)		6468426D01	\$490.00
Weather Cover (1000/L1000/5000/E5000)	Smoke	5464400041	\$71.00
E-Plex 5x3x Cylindrical Wood Demo Mount (lock not included)		20304400041	\$200.00
E-Plex 5x3x Cylindrical Acrylic Demo Mount (lock not included)		EP5000ACLMT	\$373.00

* For software and software related accessories, please visit www.dormakaba.us

E-Plex[®] 5x10 Exit Trim



See page 6 for
How to Order instructions

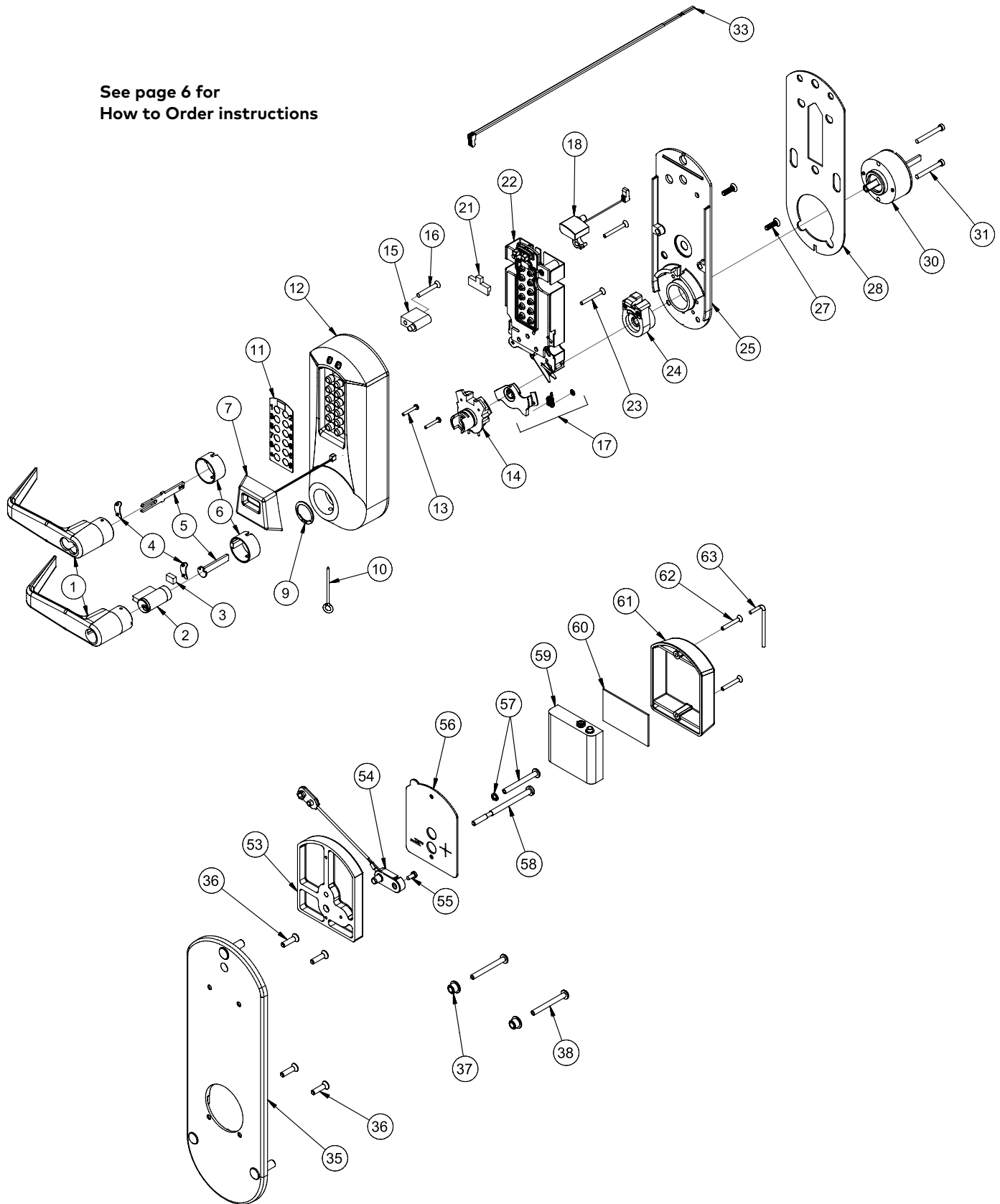



E-Plex® 5x10 Exit Trim

Item	Qty/Lock	Description	Finish	Part Number	List Price (USD)
1	1	Outside Lever, KIL (Includes 1 ea. #1, #3, #4, #6)	Satin Chrome	3422926D01	\$100.00
		Outside Lever, KIL (Includes 1 ea. #1, #3, #4, #6)	Bright Brass	342290301	\$100.00
		Outside Lever, KIL (Includes 1 ea. #1, #3, #4, #6)	Satin Brass	342290401	\$100.00
		Outside Lever, KIL (Includes 1 ea. #1, #3, #4, #6)	Dark Bronze	3422974401	\$100.00
		Outside Lever, KIL (Includes 1 ea. #1, #3, #4, #6)	Bright Chrome	3422902601	\$100.00
		Outside Lever, Schlage (Includes 1 ea. #1, #4, #6)	Satin Chrome	3423026D01	\$133.00
		Outside Lever, Schlage (Includes 1 ea. #1, #4, #6)	Bright Brass	342300301	\$133.00
		Outside Lever, Schlage (Includes 1 ea. #1, #4, #6)	Satin Brass	342300401	\$133.00
		Outside Lever, Schlage (Includes 1 ea. #1, #4, #6)	Dark Bronze	3423074401	\$133.00
		Outside Lever, Schlage (Includes 1 ea. #1, #4, #6)	Bright Chrome	3423002601	\$133.00
		Outside Lever, Corbin-Russwin (Includes 1 ea. #1, #4, #6)	Satin Chrome	3423126D01	\$133.00
		Outside Lever, Corbin-Russwin (Includes 1 ea. #1, #4, #6)	Bright Brass	342310301	\$133.00
		Outside Lever, Corbin-Russwin (Includes 1 ea. #1, #4, #6)	Satin Brass	342310401	\$133.00
		Outside Lever, Corbin-Russwin (Includes 1 ea. #1, #4, #6)	Dark Bronze	3423174401	\$133.00
		Outside Lever, Corbin-Russwin (Includes 1 ea. #1, #4, #6)	Bright Chrome	3423102601	\$133.00
		Outside Lever, Sargent (Includes 1 ea. #1, #4, #6)	Satin Chrome	3423226D01	\$133.00
		Outside Lever, Sargent (Includes 1 ea. #1, #4, #6)	Bright Brass	342320301	\$133.00
		Outside Lever, Sargent (Includes 1 ea. #1, #4, #6)	Satin Brass	342320401	\$133.00
		Outside Lever, Sargent (Includes 1 ea. #1, #4, #6)	Dark Bronze	3423274401	\$133.00
		Outside Lever, Sargent (Includes 1 ea. #1, #4, #6)	Bright Chrome	3423202601	\$133.00
		Outside Lever, Best (Includes 1 ea. #1, #4, #6)	Satin Chrome	3423326D01	\$133.00
		Outside Lever, Best (Includes 1 ea. #1, #4, #6)	Bright Brass	342330301	\$133.00
		Outside Lever, Best (Includes 1 ea. #1, #4, #6)	Satin Brass	342330401	\$133.00
		Outside Lever, Best (Includes 1 ea. #1, #4, #6)	Dark Bronze	3423374401	\$133.00
		Outside Lever, Best (Includes 1 ea. #1, #4, #6)	Bright Chrome	3423302601	\$133.00
		Outside Lever, ASSA/Medeco/Yale (Includes 1 ea. #1, #4, #6)	Satin Chrome	3423426D01	\$133.00
		Outside Lever, ASSA/Medeco/Yale (Includes 1 ea. #1, #4, #6)	Bright Brass	342340301	\$133.00
		Outside Lever, ASSA/Medeco/Yale (Includes 1 ea. #1, #4, #6)	Satin Brass	342340401	\$133.00
		Outside Lever, ASSA/Medeco/Yale (Includes 1 ea. #1, #4, #6)	Dark Bronze	3423474401	\$133.00
		Outside Lever, ASSA/Medeco/Yale (Includes 1 ea. #1, #4, #6)	Bright Chrome	3423402601	\$133.00
2	1	Kaba KIL Cylinder (w/keys), Keyed Different	Satin Chrome	5456226D01	\$51.00
		Kaba KIL Cylinder (w/keys), Keyed Different	Satin Brass	545620401	\$51.00
		Schlage KIL Cylinder (w/keys), Keyed Different	Satin Chrome	5456826D01	\$51.00
		Schlage KIL Cylinder (w/keys), Keyed Different	Satin Brass	545680401	\$51.00
		Kaba 90 Key Blank, 50/Box - Available from Ilco Division - Rocky Mount		KABA90	
3	1	Cylinder Keeper - Lever Sleeve Accessory Kit, KIL (Includes 1 ea. #3, #4, #6)		6470600001	\$19.00
4	1	Outside Lever Insert (10 Pack)		5452700010	\$14.00
5	1	Tailpiece Kit, KIL (Includes 5 various tailpieces) ET/Mortise		6474500001	\$22.00
		Tailpiece Kit, Best (6 and 7-pin) ET/Mortise		6474300001	\$16.00
		Tailpiece Kit, Corbin-Russwin/Sargent ET/Mortise		2452000001	\$16.00
		Tailpiece Kit, Schlage ET/Mortise		2452700001	\$16.00
		Tailpiece Kit, ASSA/Medeco/Yale ET/Mortise		7483600001	\$16.00
6	1	Lever Sleeve - Lever Sleeve Accessory Kit, KIL (Includes 1 ea. #3, #4, #6)		6470600001	\$19.00
		Lever Sleeve - Lever Sleeve Accessory Kit, IC (Includes 1 ea. #4, #6)		6470700001	\$19.00

E-Plex® 5x10 Exit Trim



Item	Qty/Lock	Description	Finish	Part Number	List Price (USD)
7	1	Antenna - E56xx models - Antenna Assembly Kit (Includes 1 ea. #7; 2 ea. #13)		7540000001	\$64.00
		Antenna - E57xx models - Antenna Assembly Kit (Includes 1 ea. #7; 2 ea. #13)		7511800001	\$64.00
		Antenna - E58xx and E59xx models - Antenna Assembly Kit (Includes 1 ea. #7; 2 ea. #13)		7527500001	\$64.00
9	1	External Retaining Ring (10 Pack)		5451700010	\$14.00
10	1	Accessory Tool Kit (Includes 1 ea. #10, #63)		6471700001	\$14.00
11	1	Fascia - Keypad Label		055-51063801	\$14.00
12	1	Outside Housing Assembly - No Reader Models 5010/5210 models (Includes 1 ea. #11, #12, and code buttons)	Satin Chrome	7497926D01	\$186.00
		Outside Housing Assembly - No Reader Models 5010/5210 models (Includes 1 ea. #11, #12, and code buttons)	Bright Brass	749790301	\$186.00
		Outside Housing Assembly - No Reader Models 5010/5210 models (Includes 1 ea. #11, #12, and code buttons)	Satin Brass	749790401	\$186.00
		Outside Housing Assembly - No Reader Models 5010/5210 models (Includes 1 ea. #11, #12, and code buttons)	Dark Bronze	7497974401	\$186.00
		Outside Housing Assembly - No Reader Models 5010/5210 models (Includes 1 ea. #11, #12, and code buttons)	Wrinkle Black	7497908301	\$186.00
		Outside Housing Assembly - No Reader Models 5010/5210 models (Includes 1 ea. #11, #12, and code buttons)	Bright Chrome	7497902601	\$186.00
		Outside Housing Assembly - Reader Models 5610/5710/5810/5910 models (Includes 1 ea. #11, #12, and code buttons)	Satin Chrome	751572601	\$200.00
		Outside Housing Assembly - Reader Models 5610/5710/5810/5910 models (Includes 1 ea. #11, #12, and code buttons)	Bright Brass	751570301	\$200.00
		Outside Housing Assembly - Reader Models 5610/5710/5810/5910 models (Includes 1 ea. #11, #12, and code buttons)	Satin Brass	751570401	\$200.00
		Outside Housing Assembly - Reader Models 5610/5710/5810/5910 models (Includes 1 ea. #11, #12, and code buttons)	Dark Bronze	7515774401	\$200.00
		Outside Housing Assembly - Reader Models 5610/5710/5810/5910 models (Includes 1 ea. #11, #12, and code buttons)	Wrinkle Black	7515708301	\$200.00
Outside Housing Assembly - Reader Models 5610/5710/5810/5910 models (Includes 1 ea. #11, #12, and code buttons)	Bright Chrome	7515702601	\$200.00		
13	2	Screw, 4-40 x .750, Pan, Patch-lock - Antenna Screw (10 Pack)		5461600010	\$14.00
14	1	Outside Driver Assembly (Includes 1 ea. #9, #14)		7520000001	\$48.00
15	1	Mounting Block Kit (Includes 1 ea. #15, #16)		3427400001	\$12.00
16	1	Screw, 8-32 x 1 1/4" for Mounting Block (10 Pack)		5457400010	\$14.00
17	1	Key Override Detector Kit (Includes detector, spring and spring retainer)		3430800001	\$14.00
18	1	Outside Terminal Block Assembly (Includes 1 ea. #15, #16)		7499800001	\$32.00
21	1	"T" Guard for Remote Release		3428200001	\$16.00
22	1	Electronic Module Kit for E50xx models (Includes 1 ea. #22, #28; 2 ea. #23)		6470000001	\$433.00
		Electronic Module Kit for E52xx models (Includes 1 ea. #22, #28; 2 ea. #23)		6475900001	\$532.00
		Electronic Module Kit for E56xx models (Includes 1 ea. #22, #28; 2 ea. #23)		6480900001	\$772.00
		Electronic Module Kit for E57xx models (Includes 1 ea. #22, #28; 2 ea. #23)		6476000001	\$665.00
		Electronic Module Kit for E58xx models (Includes 1 ea. #22, #28; 2 ea. #23)		6480400001	\$772.00
		Electronic Module Kit for E59xx models (Includes 1 ea. #22, #28; 2 ea. #23)		6480500001	\$772.00
23	2	Screw, 6-32 X 1 1/4" - Module Screw (10 Pack)		5458300010	\$14.00
24	1	Extension Sleeve Assembly		7512000001	\$38.00
25	1	Universal Outside Base		3432800001	\$54.00
27	2	Screw, #10-24 x .625" Phillips, Outside Base (10 Pack)		5446100010	\$14.00
28	1	Outside Base Moisture Barrier		5458800001	\$12.00



E-Plex[®] 5x10 Exit Trim

Item	Qty/Lock	Description	Finish	Part Number	List Price (USD)
30	1	Exit Trim Drive Unit		7496800001	\$60.00
31	2	Screw, Phillips 8-32 X 1 3/8" (35 mm) Connecting Screw, Spacer Kit (Includes 2 ea. #30, and a 1/4" spacer)		6471200001	\$14.00
		Screw, Phillips 8-32 X 1 5/8" (41 mm) Connecting Screw, Spacer Kit (Includes 2 ea. #30, and a 1/4" spacer)		6471200001	\$14.00
33	1	Remote Unlock Cable - Remote Unlock Cable Kit		7510500001	\$54.00
35	1	Universal Mounting Plate (Includes Fixed Sex Nuts)	Wrinkle Black	7524608301	\$61.00
36	4	Outside Base Screw Kit (10 Pack)		5459700010	\$14.00
37	2	Mounting Bushing (10 Pack)	Black	4422906810	\$14.00
38	2	Mounting Screw - Installation Hardware Kit (Includes 1 ea. #57, #58; 2 ea. #31, #37, #38; 4 ea. #36)	Satin Chrome	6473226D01	\$40.00
		Mounting Screw - Installation Hardware Kit (Includes 1 ea. #57, #58; 2 ea. #31, #37, #38; 4 ea. #36)	Bright Brass	647320301	\$40.00
53	1	Battery Mounting Plate	Wrinkle Black	3427108301	\$24.00
54	1	Inside Terminal Block - Inside Terminal Block Kit (Includes 1 ea. #54, #55, #56)		6480300001	\$32.00
55	1	Screw, Inside Pan hd Phil 6-32 x 5/16" MS (10 Pack)		5457800010	\$14.00
56	1	Mounting Plate Gasket - Inside Terminal Block Kit (Includes 1 ea. #54, #55, #56)		6480300001	\$32.00
57	1	Ground Screw with Washer - Installation Hardware Kit (Includes 1 ea. #57, #58; 2 ea. #31, #37, #38; 4 ea. #36)	Satin Chrome	6473226D01	\$40.00
		Ground Screw with Washer - Installation Hardware Kit (Includes 1 ea. #57, #58; 2 ea. #31, #37, #38; 4 ea. #36)	Bright Brass	647320301	\$40.00
58	1	Lectro Bolt - Installation Hardware Kit (Includes 1 ea. #57, #58; 2 ea. #31, #37, #38; 4 ea. #36)	Satin Chrome	6473226D01	\$40.00
		Lectro Bolt - Installation Hardware Kit (Includes 1 ea. #57, #58; 2 ea. #31, #37, #38; 4 ea. #36)	Bright Brass	647320301	\$40.00
59	1	Battery Pack (Includes 4 Alkaline "ONLY" AA Batteries)		5456000001	\$19.00
60	1	Battery Pad - Battery Cover Kit (Includes 1 ea. #60, #61)		6471500001	\$14.00
61	1	Battery Cover - Battery Cover Kit (Includes 1 ea. #60, #61)		6471500001	\$14.00
		Battery Pack and Cover Kit (Includes 1 ea. #59, #60, #61, #63; 2 ea. #62)		6472300001	\$46.00
62	2	Battery Cover Screws (Tamper Proof) (10 Pack)		5455400010	\$16.00
63	1	Accessory Tool Kit (Includes 1 ea. #10, #63)		6471700001	\$14.00
Additional Kits & Accessories			Finish	Part Number	List Price (USD)
		Installation Hardware Kit (Includes 1 ea. #57, #58; 2 ea. #31, #37, #38; 4 ea. #36)	Satin Chrome	6473226D01	\$40.00
		Installation Hardware Kit (Includes 1 ea. #57, #58; 2 ea. #31, #37, #38; 4 ea. #36)	Bright Brass	647320301	\$40.00
		Product Documentation Kit		PKG3112	\$20.00
		Lever Return Spring (Fits Outside and Inside Drivers) (10 Pack)		5448200010	\$27.00
		Lubriplate Aero Grease Tubes		6475400001	\$18.00
		E-Plex 5000 Standard Software Kit (Includes PC M-unit kit and software discs) (Excel-Based Templates) (300 users per lock)		EP-0300-001	*
		E-Plex 5200/5700 Enterprise Software Kit (Includes PC M-unit kit and software discs) (3,000 users per lock)		EP-EPRISE1-001	*
		E-Plex 5200/5700 Enterprise Demo Software (90 day expiry)		EP-EPRISE-DEMO	*
		E-Plex 5700 USB Prox Reader/Enroller		5456100041	\$638.00
		E-Plex 5800 FIPS/DESFire Card Reader/Enroller		120-ENFIPS-000	\$339.00
		E-Plex 5800 OCSP FIPS Software		EP-OCSP-FIPS-SW	*

E-Plex® 5x10 Exit Trim



Additional Kits & Accessories	Finish	Part Number	List Price (USD)
E-Plex 5800 General FIPS Software		EP-GEN-FIPS-SW	*
HID Proxcard II Proximity Access Card #1326M - Not Printable, with Slot (minimum order 100 pcs)		065-101066	*
HID ISO Prox II Card (PVC-31 mils) #1336 - Printable, NO Slot (minimum 100 pcs)		065-507143	*
HID DuoProx (PVC-31 mils) High C/Proximity #1336 - Printable, NO Slot (minimum 100 pcs)		065-507144	\$12.00
HID Prox KEY II #1346 (FOB) (minimum order 100 pcs)		120-508051	*
MicroProx Tag Proximity #1391 (Adhesive Backed Disc) (minimum order 100 pieces)		065-511072	*
DESFire 2K Smart Card (for use with 3600/5600/5800)		352-DESFIR-02K	*
Wrap Plate, 10.5" (267mm) x 5" (127mm)	Satin Chrome	20423126D41	\$84.00
Wrap Plate, 10.5" (267mm) x 5" (127mm)	Bright Brass	2042310341	\$84.00
Wrap Plate, 15" (381mm) x 5" (127mm)	Satin Chrome	20423226D41	\$120.00
Wrap Plate, 15" (381mm) x 5" (127mm)	Bright Brass	2042320341	\$120.00
Best Equivalent Small Format Interchangeable Core	Satin Chrome	20148426D01	\$78.00
Best Equivalent Small Format Interchangeable Core	Bright Brass	2014840301	\$78.00
Installation Jig (for use with E5000/5000/1000/L1000)		6468426D01	\$490.00
Weather Cover (1000/L1000/5000/E5000)		5464400041	\$71.00
E-Plex 5x10 Exit Trim Wood Demo Mount (lock not included)		20305600041	\$200.00

* For software and software related accessories, please visit www.dormakaba.us

E-Plex® 5x6x Mortise



See page 6
How to Order instructions

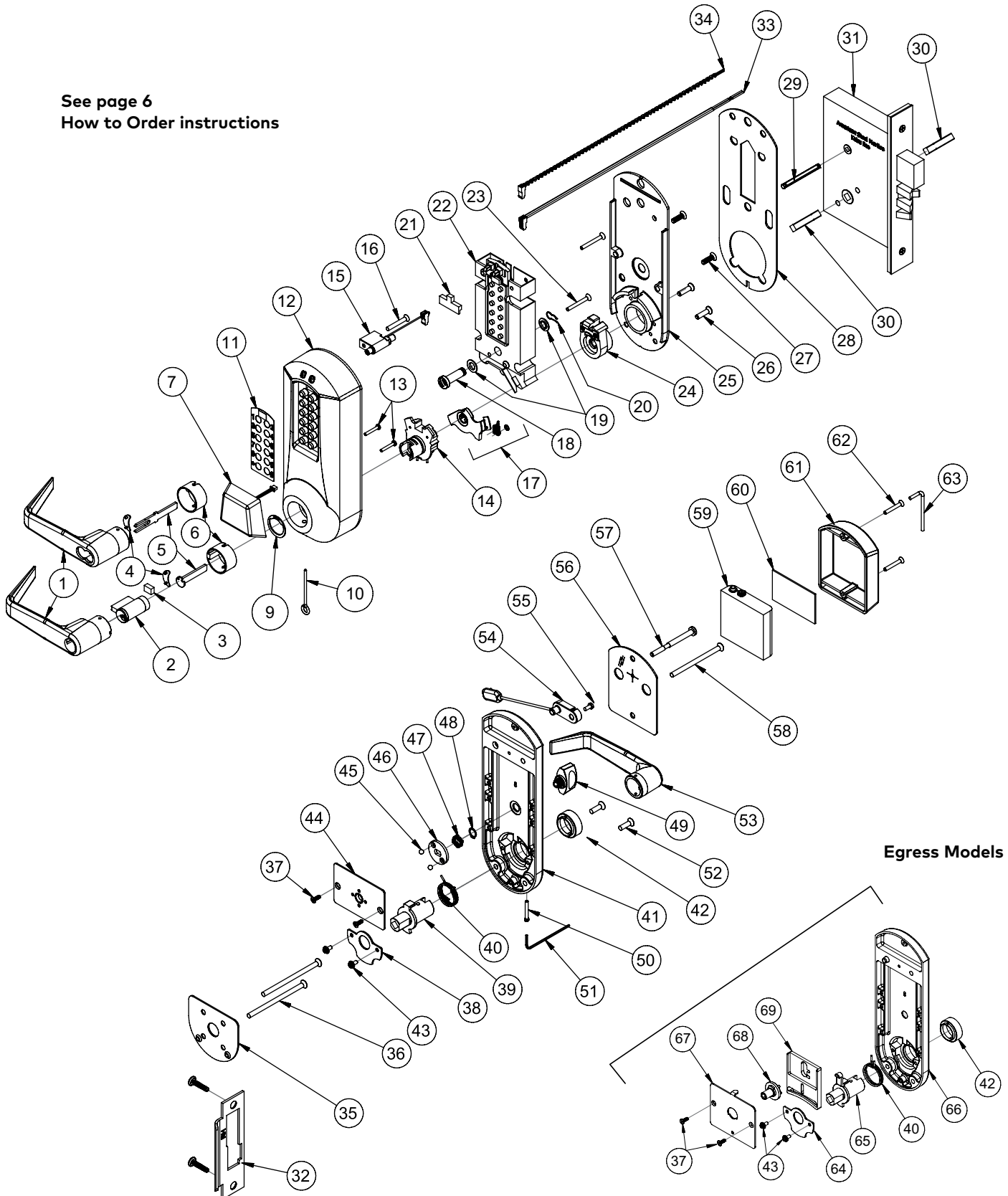

Egress Models

E-Plex[®] 5x6x Mortise



Item	Qty/Lock	Description	Finish	Part Number	List Price (USD)		
1	1	Outside Lever, KIL (Includes 1 ea. #1, #3, #4, #6)	Satin Chrome	3422926D01	\$100.00		
		Outside Lever, KIL (Includes 1 ea. #1, #3, #4, #6)	Bright Brass	342290301	\$100.00		
		Outside Lever, KIL (Includes 1 ea. #1, #3, #4, #6)	Satin Brass	342290401	\$100.00		
		Outside Lever, KIL (Includes 1 ea. #1, #3, #4, #6)	Dark Bronze	3422974401	\$100.00		
		Outside Lever, KIL (Includes 1 ea. #1, #3, #4, #6)	Bright Chrome	3422902601	\$100.00		
		Outside Lever, Schlage (Includes 1 ea. #1, #4, #6)	Satin Chrome	3423026D01	\$133.00		
		Outside Lever, Schlage (Includes 1 ea. #1, #4, #6)	Bright Brass	342300301	\$133.00		
		Outside Lever, Schlage (Includes 1 ea. #1, #4, #6)	Satin Brass	342300401	\$133.00		
		Outside Lever, Schlage (Includes 1 ea. #1, #4, #6)	Dark Bronze	3423074401	\$133.00		
		Outside Lever, Schlage (Includes 1 ea. #1, #4, #6)	Bright Chrome	3423002601	\$133.00		
		Outside Lever, Corbin-Russwin (Includes 1 ea. #1, #4, #6)	Satin Chrome	3423126D01	\$133.00		
		Outside Lever, Corbin-Russwin (Includes 1 ea. #1, #4, #6)	Bright Brass	342310301	\$133.00		
		Outside Lever, Corbin-Russwin (Includes 1 ea. #1, #4, #6)	Satin Brass	342310401	\$133.00		
		Outside Lever, Corbin-Russwin (Includes 1 ea. #1, #4, #6)	Dark Bronze	3423174401	\$133.00		
		Outside Lever, Corbin-Russwin (Includes 1 ea. #1, #4, #6)	Bright Chrome	3423102601	\$133.00		
		Outside Lever, Sargent (Includes 1 ea. #1, #4, #6)	Satin Chrome	3423226D01	\$133.00		
		Outside Lever, Sargent (Includes 1 ea. #1, #4, #6)	Bright Brass	342320301	\$133.00		
		Outside Lever, Sargent (Includes 1 ea. #1, #4, #6)	Satin Brass	342320401	\$133.00		
		Outside Lever, Sargent (Includes 1 ea. #1, #4, #6)	Dark Bronze	3423274401	\$133.00		
		Outside Lever, Sargent (Includes 1 ea. #1, #4, #6)	Bright Chrome	3423202601	\$133.00		
		Outside Lever, Best (Includes 1 ea. #1, #4, #6)	Satin Chrome	3423326D01	\$133.00		
		Outside Lever, Best (Includes 1 ea. #1, #4, #6)	Bright Brass	342330301	\$133.00		
		Outside Lever, Best (Includes 1 ea. #1, #4, #6)	Satin Brass	342330401	\$133.00		
		Outside Lever, Best (Includes 1 ea. #1, #4, #6)	Dark Bronze	3423374401	\$133.00		
		Outside Lever, Best (Includes 1 ea. #1, #4, #6)	Bright Chrome	3423302601	\$133.00		
		Outside Lever, ASSA/Medeco/Yale (Includes 1 ea. #1, #4, #6)	Satin Chrome	3423426D01	\$133.00		
		Outside Lever, ASSA/Medeco/Yale (Includes 1 ea. #1, #4, #6)	Bright Brass	342340301	\$133.00		
		Outside Lever, ASSA/Medeco/Yale (Includes 1 ea. #1, #4, #6)	Satin Brass	342340401	\$133.00		
		Outside Lever, ASSA/Medeco/Yale (Includes 1 ea. #1, #4, #6)	Dark Bronze	3423474401	\$133.00		
		Outside Lever, ASSA/Medeco/Yale (Includes 1 ea. #1, #4, #6)	Bright Chrome	3423402601	\$133.00		
		2	1	Kaba KIL Cylinder (w/keys), Keyed Different	Satin Chrome	5456226D01	\$51.00
				Kaba KIL Cylinder (w/keys), Keyed Different	Satin Brass	545620401	\$51.00
Schlage KIL Cylinder (w/keys), Keyed Different	Satin Chrome			5456826D01	\$51.00		
Schlage KIL Cylinder (w/keys), Keyed Different	Satin Brass			545680401	\$51.00		
Kaba 90 Key Blank, 50/Box - Available frm Ilco Division - Rocky Mount				KABA90			
3	1	Cylinder Keeper - Lever Sleeve Accessory Kit, KIL (Includes 1 ea. #3, #4, #6)		6470600001	\$19.00		
4	1	Outside Lever Insert (10 Pack)		5452700010	\$14.00		
5	1	Tailpiece Kit, KIL (Includes 5 Various KIL Tailpieces) ET/Mortise		6474500001	\$22.00		
		Tailpiece Kit, Best (6 and 7-pin) ET/Mortise		6474300001	\$16.00		
		Tailpiece Kit, Corbin-Russwin/Sargent ET/Mortise		2452000001	\$16.00		
		Tailpiece Kit, Schlage ET/Mortise		2452700001	\$16.00		
		Tailpiece Kit, ASSA/Medeco/Yale ET/Mortise		7483600001	\$16.00		
6	1	Lever Sleeve - Lever Sleeve Accessory Kit, KIL (Includes 1 ea. #3, #4, #6)		6470600001	\$19.00		
		Lever Sleeve - Lever Sleeve Accessory Kit, IC (Includes 1 ea. #4, #6)		6470700001	\$19.00		



E-Plex® 5x6x Mortise

Item	Qty/Lock	Description	Finish	Part Number	List Price (USD)
7	1	Antenna - E56xx models - Antenna Assembly Kit (Includes 1 ea. #7; 2 ea. #13)		7540000001	\$64.00
		Antenna - E57xx models - Antenna Assembly Kit (Includes 1 ea #7; 2 ea. #13)		7511800001	\$64.00
		Antenna - E58xx and E59xx models - Antenna Assembly Kit (Includes 1 ea #7; 2 ea. #13)		7527500001	\$64.00
9	1	External Retaining Ring (10 Pack)		5451700010	\$14.00
10	1	Accessory Tool Kit (Includes 1 ea. #10, #51, #63)		6471700001	\$14.00
11	1	Fascia - Keypad Label		055-51063801	\$14.00
12	1	Outside Housing Assembly - No Reader Models 506x/526x (Includes 1 ea. #11, #12, and code buttons)	Satin Chrome	7494026D01	\$186.00
		Outside Housing Assembly - No Reader Models 506x/526x (Includes 1 ea. #11, #12, and code buttons)	Bright Brass	749400301	\$186.00
		Outside Housing Assembly - No Reader Models 506x/526x (Includes 1 ea. #11, #12, and code buttons)	Satin Brass	749400401	\$186.00
		Outside Housing Assembly - No Reader Models 506x/526x (Includes 1 ea. #11, #12, and code buttons)	Dark Bronze	7494074401	\$186.00
		Outside Housing Assembly - No Reader Models 506x/526x (Includes 1 ea. #11, #12, and code buttons)	Wrinkle Black	7494008301	\$186.00
		Outside Housing Assembly - No Reader Models 506x/526x (Includes 1 ea. #11, #12, and code buttons)	Bright Chrome	7494002601	\$186.00
		Outside Housing Assembly - Reader Models 566x/576x/586x/596x (Includes 1 ea. #11, #12, and code buttons)		7514226D01	\$200.00
		Outside Housing Assembly - Reader Models 566x/576x/586x/596x (Includes 1 ea. #11, #12, and code buttons)		751420301	\$200.00
		Outside Housing Assembly - Reader Models 566x/576x/586x/596x (Includes 1 ea. #11, #12, and code buttons)		751420401	\$200.00
		Outside Housing Assembly - Reader Models 566x/576x/586x/596x (Includes 1 ea. #11, #12, and code buttons)		7514274401	\$200.00
13	2	Screw, 4-40 x .750, Pan, Patch-lock - Antenna Screw (10 Pack)		5461600010	\$14.00
		Outside Driver Assembly (Includes 1 ea. #9, #14)		7510000001	\$48.00
15	1	Outside Terminal Block Assembly (Includes 1 ea. #15, #16)		6470900001	\$32.00
16	1	Screw, 8-32 x 1 1/4" for Terminal Block (10 Pack)		5457400010	\$14.00
17	1	Key Override Detector Kit (Includes detector, spring and spring retainer)		3430800001	\$14.00
18	1	Magnetic Cam - Magnetic Cam Kit for Deadbolt or Door Egress Monitoring Models (Includes 1 ea. #18, #20; 2 ea. #19)		6475800001	\$54.00
19	2	Nylon Washer - Magnetic Cam Kit for Deadbolt or Door Egress Monitoring Models (Includes 1 ea. #18, #20; 2 ea. #19)		6475800001	\$54.00
20	1	Spring Clip - Magnetic Cam Kit for Deadbolt or Door Egress Monitoring Models (Includes 1 ea. #18, #20; 2 ea. #19)		6475800001	\$54.00
21	1	"T" Guard for Remote Release		3428200001	\$16.00
22	1	Electronic Module Kit for E50xx models (Includes 1 ea. #22, #28; 2 ea. #23)		6470000001	\$433.00
		Electronic Module Kit for E52xx models (Includes 1 ea. #22, #28; 2 ea. #23)		6475900001	\$532.00
		Electronic Module Kit for E56xx models (Includes 1 ea. #22, #28; 2 ea. #23)		6480900001	\$772.00
		Electronic Module Kit for E57xx models (Includes 1 ea. #22, #28; 2 ea. #23)		6476000001	\$665.00
		Electronic Module Kit for E58xx models (Includes 1 ea. #22, #28; 2 ea. #23)		6480400001	\$772.00
		Electronic Module Kit for E59xx models (Includes 1 ea. #22, #28; 2 ea. #23)		6480500001	\$772.00
23	2	Screw, 6-32 X 1 1/4" - Module Screw (10 Pack)		5458300010	\$14.00

E-Plex® 5x6x Mortise



Item	Qty/Lock	Description	Finish	Part Number	List Price (USD)
24	1	Extension Sleeve Assembly		7512000001	\$38.00
25	1	Universal Outside Base		3432800001	\$54.00
26	2	Screw, #10-24 FHMS x .75" - Base Screw (10 Pack)		5459700010	\$14.00
27	2	Screw, #10-24 x .625" Phillips, Outside Base (10 Pack)		5446100010	\$14.00
28	1	Outside Base Moisture Barrier		5458800001	\$12.00
29	1	Deadbolt Spindle - Mortise Spindle Kit (Includes 1 ea. #29; 4 ea. #30 - 2 ea. of 2 lengths)		6474400001	\$19.00
30	2	Deadbolt Spindle - Mortise Spindle Kit (Includes 1 ea. #29; 4 ea. #30 - 2 ea. of 2 lengths)		6474400001	\$19.00
31	1	American Standard Mortise with Deadbolt (includes screws)	Satin Chrome	M76/A1DL1W626	\$173.00
		American Standard Mortise with Deadbolt (includes screws)	Satin Brass	M76/A1DL1W606	\$173.00
		American Standard Mortise with Deadbolt (includes screws)	Dark Bronze	M76/A1DL1W744	\$173.00
		American Standard Mortise No-Deadbolt (includes screws)	Satin Chrome	M76/A1NL1W626	\$160.00
		American Standard Mortise No-Deadbolt (includes screws)	Satin Brass	M76/A1NL1W606	\$160.00
		American Standard Mortise No-Deadbolt (includes screws)	Dark Bronze	M76/A1NL1W744	\$160.00
32	1	Strike Plate (Includes LH and RH with Screws)	Satin Chrome	504131/2630WK	\$18.00
		Strike Plate (Includes LH and RH with Screws)	Satin Brass	504131/2606WK	\$18.00
		Strike Plate (Includes LH and RH with Screws)	Bright Brass	504131/2605WK	\$18.00
		Strike Plate (Includes LH and RH with Screws)	Dark Bronze	504131/2744WK	\$32.00
33	1	Remote Unlock Cable - Remote Unlock Cable Kit		7510500001	\$54.00
34	1	Door Monitoring Sensor Cable (59xx Only)		9400700001	\$54.00
35	1	Inside Mounting Plate (Heel Plate) (E5x6x Only)		2452400001	\$16.00
36	2	Inside Mounting Plate Screw Kit (Includes 2 ea. of 3 lengths)		6475700001	\$18.00
37	2	Screw, #6-32 x 3/8", Screw Pack (10 ea. 6-32 x 3/8", 5/16", 7/16")		6477600010	\$14.00
38	1	Inside Driver Cover Plate		2452300001	\$14.00
39	1	Inside Driver		5461000001	\$48.00
40	2	Lever Return Spring (Fits Inside and Outside Drivers)(10 Pack)		5448200010	\$27.00
41	1	Inside Housing for Deadbolt Models (Housing Only)	Satin Chrome	3427626D01	\$101.00
		Inside Housing for Deadbolt Models (Housing Only)	Bright Brass	342760301	\$101.00
		Inside Housing for Deadbolt Models (Housing Only)	Satin Brass	342760401	\$101.00
		Inside Housing for Deadbolt Models (Housing Only)	Dark Bronze	3427674401	\$101.00
		Inside Housing for Deadbolt Models (Housing Only)	Wrinkle Black	3427608301	\$101.00
		Inside Housing for Deadbolt Models (Housing Only)	Bright Chrome	3427602601	\$101.00
		Inside Housing Assembly, Complete (Deadbolt Model) (Includes 1 ea. #38, #39, #40, #41, #42, #44, #46, #47, #48, #49, #54, #55, #56; 2 ea. #37, #43, #45)	Satin Chrome	7512926D01	\$173.00
		Inside Housing Assembly, Complete (Deadbolt Model) (Includes 1 ea. #38, #39, #40, #41, #42, #44, #46, #47, #48, #49, #54, #55, #56; 2 ea. #37, #43, #45)	Bright Brass	751290301	\$173.00
		Inside Housing Assembly, Complete (Deadbolt Model) (Includes 1 ea. #38, #39, #40, #41, #42, #44, #46, #47, #48, #49, #54, #55, #56; 2 ea. #37, #43, #45)	Satin Brass	751290401	\$173.00
		Inside Housing Assembly, Complete (Deadbolt Model) (Includes 1 ea. #38, #39, #40, #41, #42, #44, #46, #47, #48, #49, #54, #55, #56; 2 ea. #37, #43, #45)	Dark Bronze	7512974401	\$173.00
		Inside Housing Assembly, Complete (Deadbolt Model) (Includes 1 ea. #38, #39, #40, #41, #42, #44, #46, #47, #48, #49, #54, #55, #56; 2 ea. #37, #43, #45)	Wrinkle Black	7512908301	\$173.00
		Inside Housing Assembly, Complete (Deadbolt Model) (Includes 1 ea. #38, #39, #40, #41, #42, #44, #46, #47, #48, #49, #54, #55, #56; 2 ea. #37, #43, #45)	Bright Chrome	7512902601	\$173.00



E-Plex® 5x6x Mortise

Item	Qty/Lock	Description	Finish	Part Number	List Price (USD)
41	1	Inside Housing for Non-Deadbolt Models (Housing Only)	Satin Chrome	3422026D01	\$101.00
		Inside Housing for Non-Deadbolt Models (Housing Only)	Bright Brass	342200301	\$101.00
		Inside Housing for Non-Deadbolt Models (Housing Only)	Satin Brass	342200401	\$100.00
		Inside Housing for Non-Deadbolt Models (Housing Only)	Dark Bronze	3422074401	\$101.00
		Inside Housing for Non-Deadbolt Models (Housing Only)	Wrinkle Black	3422008301	\$101.00
		Inside Housing for Non-Deadbolt Models (Housing Only)	Bright Chrome	3422002601	\$101.00
		Inside Housing Assembly, Complete (Non-Deadbolt Model) (Includes 1 ea. #38, #39, #40, #41, #42, #54, #55, #56; 2 ea. #37)	Satin Chrome	7514626D01	\$133.00
		Inside Housing Assembly, Complete (Non-Deadbolt Model) (Includes 1 ea. #38, #39, #40, #41, #42, #54, #55, #56; 2 ea. #37)	Bright Brass	751460301	\$133.00
		Inside Housing Assembly, Complete (Non-Deadbolt Model) (Includes 1 ea. #38, #39, #40, #41, #42, #54, #55, #56; 2 ea. #37)	Satin Brass	751460401	\$133.00
		Inside Housing Assembly, Complete (Non-Deadbolt Model) (Includes 1 ea. #38, #39, #40, #41, #42, #54, #55, #56; 2 ea. #37)	Dark Bronze	7514674401	\$133.00
		Inside Housing Assembly, Complete (Non-Deadbolt Model) (Includes 1 ea. #38, #39, #40, #41, #42, #54, #55, #56; 2 ea. #37)	Wrinkle Black	7514608301	\$133.00
		Inside Housing Assembly, Complete (Non-Deadbolt Model) (Includes 1 ea. #38, #39, #40, #41, #42, #54, #55, #56; 2 ea. #37)	Bright Chrome	7514602601	\$133.00
42	1	Housing Bearing (10 Pack)		3419100010	\$14.00
43	2	Screw, #6-32 x 3/8", Screw Pack (10 ea. 6-32 x 3/8", 5/16", 7/16")		6477600010	\$14.00
44	1	Mortise Detent Plate - Mortise Deadbolt Kit (Includes 1 ea. #44, #46, #47, #48; 2 ea. #43, #45)		6474600001	\$40.00
45	2	Ball Bearing - Mortise Deadbolt Kit (Includes 1 ea. #44, #46, #47, #48; 2 ea. #43, #45)		6474600001	\$40.00
46	1	Detent Washer - Mortise Deadbolt Kit (Includes 1 ea. #44, #46, #47, #48; 2 ea. #43, #45)		6474600001	\$40.00
47	1	Smalley Wave Spring - Mortise Deadbolt Kit (Includes 1 ea. #44, #46, #47, #48; 2 ea. #43, #45)		6474600001	\$40.00
48	1	Retaining Ring - Mortise Deadbolt Kit (Includes 1 ea. #44, #46, #47, #48; 2 ea. #43, #45)		6474600001	\$40.00
49	1	Turn Knob (Includes 1 ea. #48, #49)	Satin Chrome	3427926D01	\$40.00
		Turn Knob (Includes 1 ea. #48, #49)	Bright Brass	342790301	\$40.00
		Turn Knob (Includes 1 ea. #48, #49)	Dark Bronze	342790401	\$40.00
50	1	Inside Lever Screw (2 Pack)		4435900001	\$20.00
51	1	Accessory Tool Kit (Includes 1 ea. #10, #51, #63)		6471700001	\$14.00
52	2	Inside Housing Mounting Screws (10 Pack)	Satin Chrome	4435826D10	\$14.00
		Inside Housing Mounting Screws (10 Pack)	Bright Brass	443580310	\$14.00
53	1	Inside Lever Kit (Includes 1 ea. #50, #51, #53)	Satin Chrome	6471326D01	\$73.00
		Inside Lever Kit (Includes 1 ea. #50, #51, #53)	Bright Brass	647130301	\$73.00
		Inside Lever Kit (Includes 1 ea. #50, #51, #53)	Satin Brass	647130401	\$73.00
		Inside Lever Kit (Includes 1 ea. #50, #51, #53)	Dark Bronze	6471374401	\$73.00
		Inside Lever Kit (Includes 1 ea. #50, #51, #53)	Bright Chrome	6471302601	\$73.00
54	1	Inside Terminal Block - Inside Terminal Block Kit (Includes 1 ea. #54, #55, #56)		6471400001	\$32.00

E-Plex[®] 5x6x Mortise



Item	Qty/Lock	Description	Finish	Part Number	List Price (USD)
55	1	Screw, Inside Pan hd Phil 6-32 x 5/16" MS (10 Pack)		5457800010	\$14.00
56	1	Inside Housing Gasket - Inside Terminal Block Kit (Includes 1 ea. #54, #55, #56)		6471400001	\$32.00
57	1	Lectro Bolt - Mounting Screw Kit (Includes 3 ea. #57 (3 lengths), 9 ea. #58) (3 ea. of 3 lengths)	Satin Chrome	6471626D01	\$20.00
		Lectro Bolt - Mounting Screw Kit (Includes 3 ea. #57 (3 lengths), 9 ea. #58) (3 ea. of 3 lengths)	Bright Brass	647160301	\$20.00
58	3	Mounting Screw - Mounting Screw Kit (Includes 3 ea. #57 (3 lengths), 9 ea. #58) (3 ea. of 3 lengths)	Satin Chrome	6471626D01	\$20.00
		Mounting Screw - Mounting Screw Kit (Includes 3 ea. #57 (3 lengths), 9 ea. #58) (3 ea. of 3 lengths)	Bright Brass	647160301	\$20.00
59	1	Battery Pack (Includes 4 Alkaline "Only" AA Batteries)		5456000001	\$19.00
60	1	Battery Pad - Battery Cover Kit (Includes 1 ea. #60, #61)		6471500001	\$14.00
61	1	Battery Cover - Battery Cover Kit (Includes 1 ea. #60, #61)		6471500001	\$14.00
		Battery Pack and Cover Kit (Includes 1 ea. #59, #60, #61, #63; 2 ea. #62)		6472300001	\$46.00
62	2	Battery Cover Screws (Tamper Proof) (10 Pack)		5455400010	\$16.00
63	1	Accessory Tool Kit (Includes 1 ea. #10, #51, #63)		6471700001	\$14.00
64	1	Inside Housing Cover Plate (Door Egress Monitoring Models Only)		5478200001	\$14.00
65	1	Egress Indicator Cam (Door Egress Monitoring Models Only)		3431400001	\$27.00
66	1	Egress Indicator Slide (Door Egress Monitoring Models Only)		5473000001	\$24.00
67	1	Inside Driver (Door Egress Monitoring Models Only)		5460900001	\$48.00
68	1	Inside Housing (E5966 Door Egress Monitoring Models Only)	Satin Chrome	3431526D01	\$113.00
		Inside Housing (E5966 Door Egress Monitoring Models Only)	Bright Brass	343150301	\$113.00
		Inside Housing (E5966 Door Egress Monitoring Models Only)	Satin Brass	343150401	\$113.00
		Inside Housing (E5966 Door Egress Monitoring Models Only)	Dark Bronze	3431574401	\$113.00
		Inside Housing (E5966 Door Egress Monitoring Models Only)	Wrinkle Black	3431508301	\$113.00
		Inside Housing (E5966 Door Egress Monitoring Models Only)	Bright Chrome	3431502601	\$113.00
		Inside Housing Assembly, Complete (Door Egress Monitoring Models Only) (Includes 1 ea. #38, #40, #42, #54, #55, #56, #64, #65, #66, #67, #68; 2 ea. #37, #43)	Satin Chrome	7529726D01	\$200.00
		Inside Housing Assembly, Complete (Door Egress Monitoring Models Only) (Includes 1 ea. #38, #40, #42, #54, #55, #56, #64, #65, #66, #67, #68; 2 ea. #37, #43)	Bright Brass	752970301	\$200.00
		Inside Housing Assembly, Complete (Door Egress Monitoring Models Only) (Includes 1 ea. #38, #40, #42, #54, #55, #56, #64, #65, #66, #67, #68; 2 ea. #37, #43)	Satin Brass	752970401	\$200.00
		Inside Housing Assembly, Complete (Door Egress Monitoring Models Only) (Includes 1 ea. #38, #40, #42, #54, #55, #56, #64, #65, #66, #67, #68; 2 ea. #37, #43)	Dark Bronze	7529774401	\$200.00
Inside Housing Assembly, Complete (Door Egress Monitoring Models Only) (Includes 1 ea. #38, #40, #42, #54, #55, #56, #64, #65, #66, #67, #68; 2 ea. #37, #43)	Wrinkle Black	7529708301	\$200.00		
Inside Housing Assembly, Complete (Door Egress Monitoring Models Only) (Includes 1 ea. #38, #40, #42, #54, #55, #56, #64, #65, #66, #67, #68; 2 ea. #37, #43)	Bright Chrome	7529702601	\$200.00		



E-Plex® 5x6x Mortise

Additional Kits & Accessories	Finish	Part Number	List Price (USD)
Installation Hardware Kit (Includes 1 ea. #3, #4, #10, #50, #51; 2 ea. #29, #52; 3 ea. #57; 4 ea. #30; 6 ea. #36; 9 ea. #58)	Satin Chrome	6473926D01	\$40.00
Installation Hardware Kit (Includes 1 ea. #3, #4, #10, #50, #51; 2 ea. #29, #52; 3 ea. #57; 4 ea. #30; 6 ea. #36; 9 ea. #58)	Bright Brass	647390301	\$40.00
E5x6x Product Documentation Kit		PKG3111	\$20.00
Lubriplate Aero Grease Tubes		6475400001	\$18.00
Tamper Proof Screw Kit (2 ea. of 3 lengths) (Includes wrench)	Satin Chrome	6469226D01	\$30.00
Tamper Proof Screw Kit (2 ea. of 3 lengths) (Includes wrench)	Bright Brass	646920301	\$30.00
E-Plex 5000 Standard Software Kit (Includes PC M-unit kit and software discs) (Excel-Based Templates) (300 users per lock)		EP-0300-001	*
E-Plex 5200/5700 Enterprise Software Kit (Includes PC M-unit kit and software discs) (3,000 users per lock)		EP-EPRISE1-001	*
E-Plex 5200/5700 Enterprise Demo Software (90 day expiry)		EP-EPRISE-DEMO	*
E-Plex 5700 USB Prox Reader/Enroller		5456100041	\$638.00
E-Plex 5800 FIPS/DESFire Card Reader/Enroller		120-ENFIPS-000	\$339.00
E-Plex 5800 OCSP FIPS Software		EP-OCSP-FIPS-SW	*
E-Plex 5800 General FIPS Software		EP-GEN-FIPS-SW	*
HID Proxcard II Proximity Access Card #1326M - Not Printable, with Slot (minimum order 100 pcs)		065-101066	*
HID ISO Prox II Card (PVC-31 mils) #1336 - Printable, NO Slot (minimum 100 pcs)		065-507143	*
HID DuoProx (PVC-31 mils) High C/Proximity #1336 - Printable, NO Slot (minimum 100 pcs)		065-507144	\$12.00
HID Prox KEY II #1346 (FOB) (minimum order 100 pcs)		120-508051	*
MicroProx Tag Proximity #1391 (Adhesive Backed Disc) (minimum order 100 pieces)		065-511072	*
DESFire 2K Smart Card (for use with 3600/5600/5800)		352-DESFIR-02K	*
Mortise Stabilizer Bracket Kit for Hollow Metal Doors		5472000001	\$22.00
Mortise Stabilizer for Hollow Metal Doors		5056770100001	\$28.00
Best Equivalent Small Format Interchangeable Core	Satin Chrome	20148426D01	\$78.00
Best Equivalent Small Format Interchangeable Core	Bright Brass	2014840301	\$78.00
Installation Jig (for use with E5000/5000/1000/L1000)		6468426D01	\$490.00
Weather Cover (1000/L1000/5000/E5000)	Smoke	5464400041	\$71.00
E-Plex 5x6x Mortise Wood Demo Mount (lock not included)		20305800041	\$200.00

* For software and software related accessories, please visit www.dormakaba.us

E-Plex[®] 5x86 Mortise (Entry/Egress)



See page 6 for
How to Order instructions

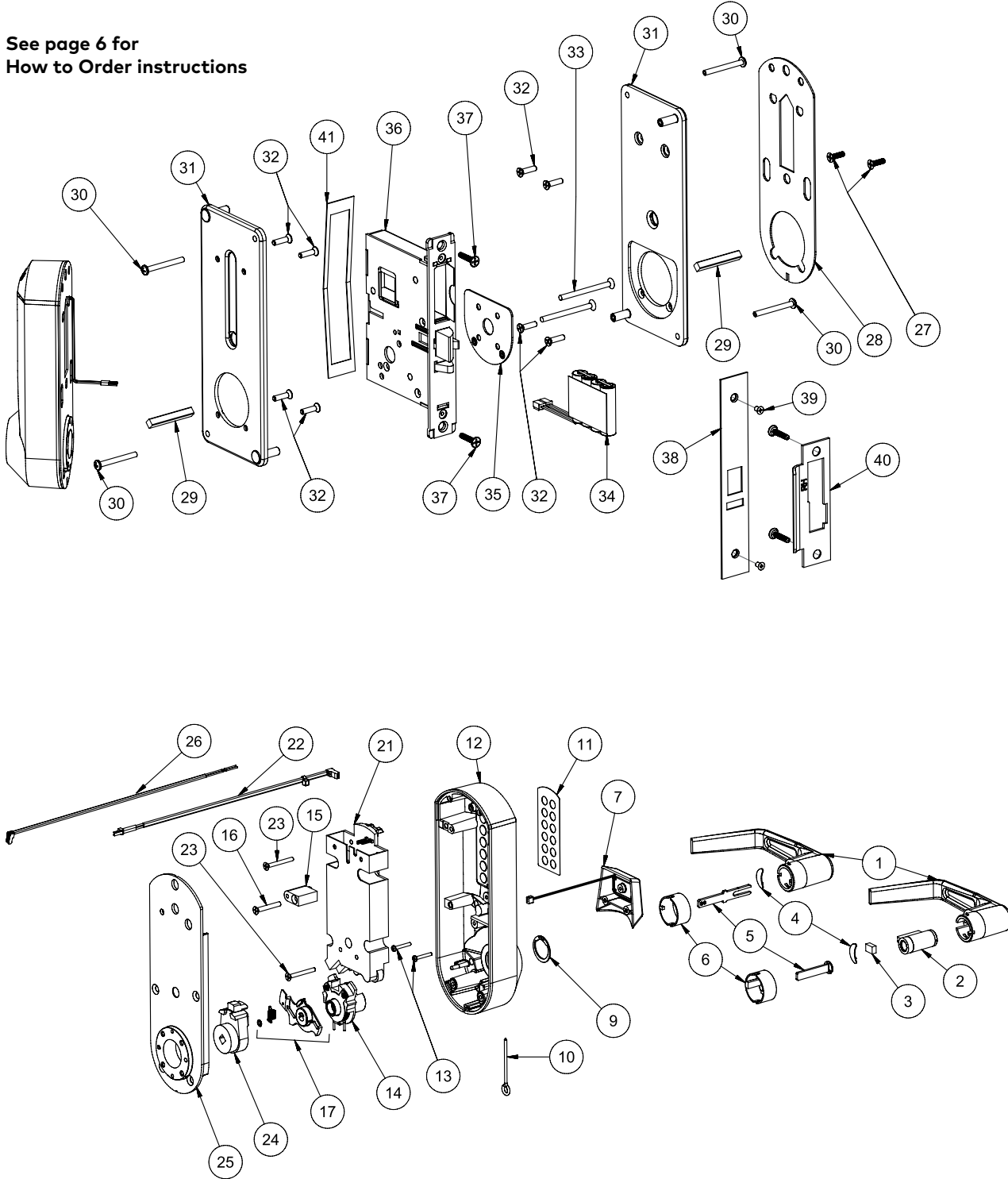



E-Plex®

5x86 Mortise (Entry/Egress)

Item	Qty/Lock	Description	Finish	Part Number	List Price (USD)
1	1	Outside Lever, KIL (Includes 1 ea. #1, #3, #4, #6)	Satin Chrome	3422926D01	\$100.00
		Outside Lever, KIL (Includes 1 ea. #1, #3, #4, #6)	Bright Brass	342290301	\$100.00
		Outside Lever, KIL (Includes 1 ea. #1, #3, #4, #6)	Satin Brass	342290401	\$100.00
		Outside Lever, KIL (Includes 1 ea. #1, #3, #4, #6)	Dark Bronze	3422974401	\$100.00
		Outside Lever, KIL (Includes 1 ea. #1, #3, #4, #6)	Bright Chrome	3422902601	\$100.00
		Outside Lever, Schlage (Includes 1 ea. #1, #4, #6)	Satin Chrome	3423026D01	\$133.00
		Outside Lever, Schlage (Includes 1 ea. #1, #4, #6)	Bright Brass	342300301	\$133.00
		Outside Lever, Schlage (Includes 1 ea. #1, #4, #6)	Satin Brass	342300401	\$133.00
		Outside Lever, Schlage (Includes 1 ea. #1, #4, #6)	Dark Bronze	3423074401	\$133.00
		Outside Lever, Schlage (Includes 1 ea. #1, #4, #6)	Bright Chrome	3423002601	\$133.00
		Outside Lever, Corbin-Russwin (Includes 1 ea. #1, #4, #6)	Satin Chrome	3423126D01	\$133.00
		Outside Lever, Corbin-Russwin (Includes 1 ea. #1, #4, #6)	Bright Brass	342310301	\$133.00
		Outside Lever, Corbin-Russwin (Includes 1 ea. #1, #4, #6)	Satin Brass	342310401	\$133.00
		Outside Lever, Corbin-Russwin (Includes 1 ea. #1, #4, #6)	Dark Bronze	3423174401	\$133.00
		Outside Lever, Corbin-Russwin (Includes 1 ea. #1, #4, #6)	Bright Chrome	3423102601	\$133.00
		Outside Lever, Sargent (Includes 1 ea. #1, #4, #6)	Satin Chrome	3423226D01	\$133.00
		Outside Lever, Sargent (Includes 1 ea. #1, #4, #6)	Bright Brass	342320301	\$133.00
		Outside Lever, Sargent (Includes 1 ea. #1, #4, #6)	Satin Brass	342320401	\$133.00
		Outside Lever, Sargent (Includes 1 ea. #1, #4, #6)	Dark Bronze	3423274401	\$133.00
		Outside Lever, Sargent (Includes 1 ea. #1, #4, #6)	Bright Chrome	3423202601	\$133.00
		Outside Lever, Best (Includes 1 ea. #1, #4, #6)	Satin Chrome	3423326D01	\$133.00
		Outside Lever, Best (Includes 1 ea. #1, #4, #6)	Bright Brass	342330301	\$133.00
		Outside Lever, Best (Includes 1 ea. #1, #4, #6)	Satin Brass	342330401	\$133.00
		Outside Lever, Best (Includes 1 ea. #1, #4, #6)	Dark Bronze	3423374401	\$133.00
		Outside Lever, Best (Includes 1 ea. #1, #4, #6)	Bright Chrome	3423302601	\$133.00
		Outside Lever, ASSA/Medeco/Yale (Includes 1 ea. #1, #4, #6)	Satin Chrome	3423426D01	\$133.00
		Outside Lever, ASSA/Medeco/Yale (Includes 1 ea. #1, #4, #6)	Bright Brass	342340301	\$133.00
		Outside Lever, ASSA/Medeco/Yale (Includes 1 ea. #1, #4, #6)	Satin Brass	342340401	\$133.00
		Outside Lever, ASSA/Medeco/Yale (Includes 1 ea. #1, #4, #6)	Dark Bronze	3423474401	\$133.00
		Outside Lever, ASSA/Medeco/Yale (Includes 1 ea. #1, #4, #6)	Bright Chrome	3423402601	\$133.00
2	1	Kaba KIL Cylinder (w/keys), Keyed Different	Satin Chrome	5456226D01	\$51.00
		Kaba KIL Cylinder (w/keys), Keyed Different	Satin Brass	545620401	\$51.00
		Schlage KIL Cylinder (w/keys), Keyed Different	Satin Chrome	5456826D01	\$51.00
		Schlage KIL Cylinder (w/keys), Keyed Different	Satin Brass	545680401	\$51.00
		Kaba 90 Key Blank, 50/Box - Available from Ilco Division - Rocky Mount		KABA90	
3	1	Cylinder Keeper - Lever Sleeve Accessory Kit, KIL (Includes 1 ea. #3, #4, #6)		6470600001	\$19.00
4	1	Outside Lever Insert (10 Pack)		5452700010	\$14.00
5	1	Tailpiece Kit, KIL (Includes 5 various tailpieces) ET/Mortise		6474500001	\$22.00
		Tailpiece Kit, Best (6 and 7-pin) ET/Mortise		6474300001	\$16.00
		Tailpiece Kit, Corbin-Russwin/Sargent ET/Mortise		2452000001	\$16.00
		Tailpiece Kit, Schlage ET/Mortise		2452700001	\$16.00
		Tailpiece Kit, ASSA/Medeco/Yale ET/Mortise		7483600001	\$16.00
6	1	Lever Sleeve - Lever Sleeve Accessory Kit, KIL (Includes 1 ea. #3, #4, #6)		6470600001	\$19.00
		Lever Sleeve - Lever Sleeve Accessory Kit, IC (Includes 1 ea. #4, #6)		6470700001	\$19.00

E-Plex[®] 5x86 Mortise (Entry/Egress)



Item	Qty/Lock	Description	Finish	Part Number	List Price (USD)
7	1	Antenna - E56xx models - Antenna Assembly Kit (Includes 1 ea. #7; 2 ea. #13)		7540000001	\$64.00
		Antenna - E57xx models - Antenna Assembly Kit (Includes 1 ea #7; 2 ea. #13)		7511800001	\$64.00
		Antenna - E58xx and E59xx models - Antenna Assembly Kit (Includes 1 ea #7; 2 ea. #13)		7527500001	\$64.00
9	1	External Retaining Ring (10 Pack)		5451700010	\$14.00
10	1	Accessory Tool Kit (Includes 1 ea. #10) (#51, #63 included - see cylindrical models for view)		6471700001	\$14.00
11	1	Fascia - Keypad Label		055-51063801	\$14.00
12	1	Outside Housing Assembly - No Reader Models (5086/5286 models only) (Includes 1 ea. #11, #12, and code buttons)	Satin Chrome	7494026D01	\$186.00
		Outside Housing Assembly - No Reader Models (5086/5286 models only) (Includes 1 ea. #11, #12, and code buttons)	Bright Brass	749400301	\$186.00
		Outside Housing Assembly - No Reader Models (5086/5286 models only) (Includes 1 ea. #11, #12, and code buttons)	Satin Brass	749400401	\$186.00
		Outside Housing Assembly - No Reader Models (5086/5286 models only) (Includes 1 ea. #11, #12, and code buttons)	Dark Bronze	7494074401	\$186.00
		Outside Housing Assembly - No Reader Models (5086/5286 models only) (Includes 1 ea. #11, #12, and code buttons)	Wrinkle Black	7494008301	\$186.00
		Outside Housing Assembly - No Reader Models (5086/5286 models only) (Includes 1 ea. #11, #12, and code buttons)	Bright Chrome	7494002601	\$186.00
		Outside Housing Assembly - Reader Models (5686/5786/5886/5986 models) (Includes 1 ea. #11, #12, and code buttons)	Satin Chrome	7514226D01	\$200.00
		Outside Housing Assembly - Reader Models (5686/5786/5886/5986 models) (Includes 1 ea. #11, #12, and code buttons)	Bright Brass	751420301	\$200.00
		Outside Housing Assembly - Reader Models (5686/5786/5886/5986 models) (Includes 1 ea. #11, #12, and code buttons)	Satin Brass	751420401	\$200.00
		Outside Housing Assembly - Reader Models (5686/5786/5886/5986 models) (Includes 1 ea. #11, #12, and code buttons)	Dark Bronze	7514274401	\$200.00
		Outside Housing Assembly - Reader Models (5686/5786/5886/5986 models) (Includes 1 ea. #11, #12, and code buttons)	Wrinkle Black	7514208301	\$200.00
		Outside Housing Assembly - Reader Models (5686/5786/5886/5986 models) (Includes 1 ea. #11, #12, and code buttons)	Bright Chrome	7514202601	\$200.00
13	2	Screw, 4-40 x .750, Pan, Patch-lock - Antenna Screw (10 Pack)		5461600010	\$14.00
14	1	Outside Driver Assembly (Includes 1 ea. #9, #14)		7510000001	\$48.00
15	1	Mounting Block		3427400001	\$12.00
16	1	Screw, 8-32 x 1 1/4" for Mounting Block (10 Pack)		5457400010	\$14.00
17	1	Key Override Detector Kit (Includes detector, spring and spring retainer)		3430800001	\$14.00
20	1	"T" Guard for Remote Release		3428200001	\$16.00
21	1	Electronic Module Kit for E50xx models (Includes 1 ea. #22, #28; 2 ea. #23)		6470000001	\$433.00
		Electronic Module Kit for E52xx models (Includes 1 ea. #22, #28; 2 ea. #23)		6475900001	\$532.00
		Electronic Module Kit for E56xx models (Includes 1 ea. #22, #28; 2 ea. #23)		6480900001	\$772.00
		Electronic Module Kit for E57xx models (Includes 1 ea. #22, #28; 2 ea. #23)		6476000001	\$665.00
		Electronic Module Kit for E58xx models (Includes 1 ea. #22, #28; 2 ea. #23)		6480400001	\$772.00
		Electronic Module Kit for E59xx models (Includes 1 ea. #22, #28; 2 ea. #23)		6480500001	\$772.00
22	1	Battery Pack Cable		5467100001	\$16.00
23	2	Screw, 6-32 X 1 1/4" - Module Screw (10 Pack)		5458300010	\$14.00
24	1	Extension Sleeve Assembly		7512000001	\$38.00
25	1	Universal Outside Base		3432800001	\$54.00



E-Plex®

5x86 Mortise (Entry/Egress)

Item	Qty/Lock	Description	Finish	Part Number	List Price (USD)
26	1	Remote Unlock Cable - Remote Unlock Cable Kit		7510500001	\$54.00
27	2	Screw, #10-24 x .625" Phillips, Outside Base (10 Pack)		5446100010	\$14.00
28	1	Outside Base Moisture Barrier		5458800001	\$12.00
29	2	Latch Spindle - Mortise Spindle Kit (Includes 4 ea. #29; 2 ea. different lengths)		6480600001	\$19.00
30	4	Screw, Pan Hd 10-24UNC x 1.75", Mounting Hardware Kit E5x86 Only (Includes 1 ea. #17, #35; 2 ea. #3, #4, #29 (2 lengths), #33; 4 ea. #30; 8 ea. #32		6476226D01	\$51.00
		Screw, Pan Hd 10-24UNC x 1.75", Mounting Hardware Kit E5x86 Only (Includes 1 ea. #17, #35; 2 ea. #3, #4, #29 (2 lengths), #33; 4 ea. #30; 8 ea. #32		647620301	\$51.00
31	2	Mounting Plate (E5x86 Only) Includes Fixed Sex Bolts		7526708301	\$61.00
32	2	Screw, #10-24 FHMS x .75" - Base Screw (10 Pack)		5459700010	\$14.00
33	2	Screw, PAN HD 10-24 x 2.25" - Mounting Hardware Kit E5x86 (Includes 1 ea. #17, #35; 2 ea. #3, #4, #29 (2 lengths), #33; 4 ea. #30; 8 ea. #32		6476226D01	\$51.00
		Screw, PAN HD 10-24 x 2.25" - Mounting Hardware Kit E5x86 (Includes 1 ea. #17, #35; 2 ea. #3, #4, #29 (2 lengths), #33; 4 ea. #30; 8 ea. #32		647620301	\$51.00
34	1	Battery Pack - 5x86 Models Only (Includes 4 Alkaline "Only" AA Batteries)		7524500001	\$40.00
35	1	Inside Mounting Plate (Heel Plate)(5x86 Models Only)		2453900001	\$16.00
36	1	American Standard Mortise, No Deadbolt (includes screws) E5x86 Models Only	Satin Chrome	7520926D01	\$173.00
		American Standard Mortise, No Deadbolt (includes screws) 5x86 Models Only	Bright Brass	752090301	\$173.00
		American Standard Mortise, No Deadbolt (includes screws) 5x86 Models Only	Satin Brass	752090401	\$173.00
		American Standard Mortise, No Deadbolt (includes screws) 5x86 Models Only	Dark Bronze	7520974401	\$173.00
37	2	Screw, #12 Combination Screw for Mortise (10 Pack)	Satin Chrome	20160826D01	\$14.00
		Screw, #12 Combination Screw for Mortise (10 Pack)	Bright Brass	2016080301	\$14.00
38	1	Mortise Front Plate, 1 1/4", No Deadbolt	Satin Chrome	7521126D01	\$32.00
		Mortise Front Plate, 1 1/4", No Deadbolt	Bright Brass	752110301	\$32.00
		Mortise Front Plate, 1 1/4", No Deadbolt	Satin Brass	752110401	\$32.00
		Mortise Front Plate, 1 1/4", No Deadbolt	Dark Bronze	7521174401	\$32.00
39	2	Screw, Mortise Front Plate Screws (2 Pack)	Satin Chrome	810-504157-626-01	\$11.00
		Screw, Mortise Front Plate Screws (2 Pack)	Satin Brass	810-504157-606-01	\$11.00
40	1	Strike Plate (Includes LH and RH with Screws)	Satin Chrome	504131/2630WK	\$18.00
		Strike Plate (Includes LH and RH with Screws)	Bright Brass	504131/2605WK	\$18.00
		Strike Plate (Includes LH and RH with Screws)	Satin Brass	504131/2606WK	\$18.00
		Strike Plate (Includes LH and RH with Screws)	Dark Bronze	504131/2744WK	\$32.00
41	1	Mortise Stabilizer		50567701045	\$27.00

E-Plex®

5x86 Mortise

(Entry/Egress)



Additional Kits & Accessories	Finish	Part Number	List Price (USD)
Mortise Mounting Bracket Kit E5x86		5472000001	\$22.00
Mounting Hardware Kit E5x86 (Includes 1 ea. #17, #35; 2 ea. #3, #4, #29 (2 lengths), #33; 4 ea. #30; 8 ea. #32)		6476226D01	\$51.00
Mounting Hardware Kit E5x86 (Includes 1 ea. #17, #35; 2 ea. #3, #4, #29 (2 lengths), #33; 4 ea. #30; 8 ea. #32)		647620301	\$51.00
E5000 Entry/Exit Literature Kit		PKG3145	\$27.00
E52/57 Entry/Exit Literature Kit		PKG3146	\$27.00
E-Plex 5000 Standard Software Kit (Includes PC M-unit kit and software discs) (Excel-Based Templates) (300 users per lock)		EP-0300-001	*
E-Plex 5200/5700 Enterprise Software Kit (Includes PC M-unit kit and software discs) (3,000 users per lock)		EP-EPRISE1-001	*
E-Plex 5200/5700 Enterprise Demo Software (90 day expiry)		EP-EPRISE-DEMO	*
E-Plex 5700 USB Prox Reader/Enroller		5456100041	\$638.00
E-Plex 5800 FIPS/DESFire Card Reader/Enroller		120-ENFIPS-000	\$339.00
E-Plex 5800 OCSP FIPS Software		EP-OCSP-FIPS-SW	*
E-Plex 5800 General FIPS Software		EP-GEN-FIPS-SW	*
HID Proxcard II Proximity Access Card #1326M - Not Printable, with Slot (minimum order 100 pcs)		065-101066	*
HID ISO Prox II Card (PVC-31 mils) #1336 - Printable, NO Slot (minimum 100 pcs)		065-507143	*
HID DuoProx (PVC-31 mils) High C/Proximity #1336 - Printable, NO Slot (minimum 100 pcs)		065-507144	\$12.00
HID Prox KEY II #1346 (FOB) (minimum order 100 pcs)		120-508051	*
MicroProx Tag Proximity #1391 (Adhesive Backed Disc) (minimum order 100 pieces)		065-511072	*
DESFire 2K Smart Card (for use with 3600/5600/5800)		352-DESFIR-02K	*
Mortise Stabilizer Bracket Kit for Hollow Metal Doors		5472000001	\$22.00
Mortise Stabilizer for Hollow Metal Doors		5056770100001	\$28.00
Best Equivalent Small Format Interchangeable Core	Satin Chrome	20148426D01	\$78.00
Best Equivalent Small Format Interchangeable Core	Bright Brass	2014840301	\$78.00
Installation Jig (for use with E5000/5000/1000/L1000)		6468426D01	\$490.00
Weather Cover (1000/L1000/5000/E5000)	Smoke	5464400041	\$71.00
E-Plex 5x6x Mortise Wood Demo Mount (lock not included)		20305800041	\$200.00

* For software and software related accessories, please visit www.dormakaba.us



E-Plex[®] 5x70 SAC

See page 6 for
How to Order instructions

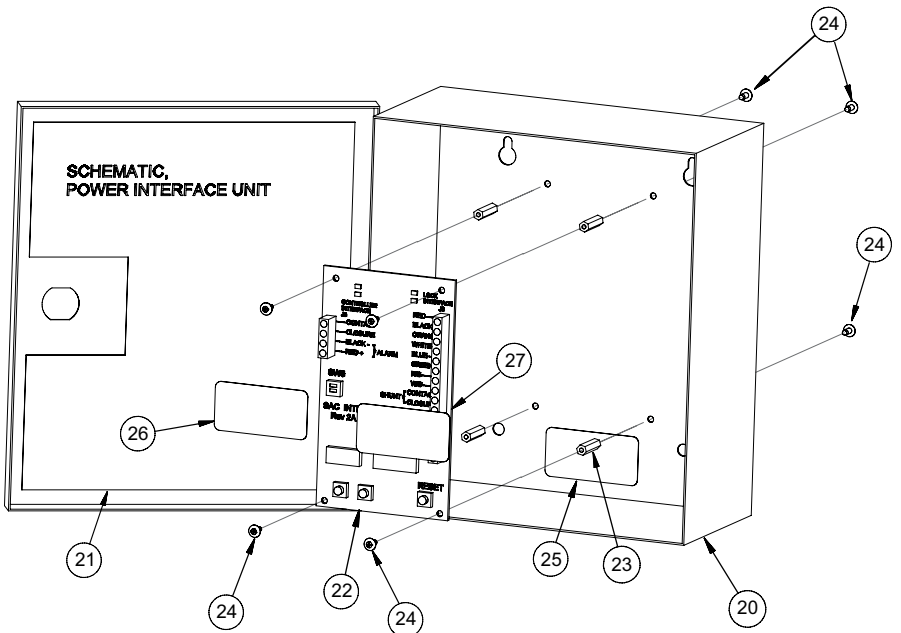
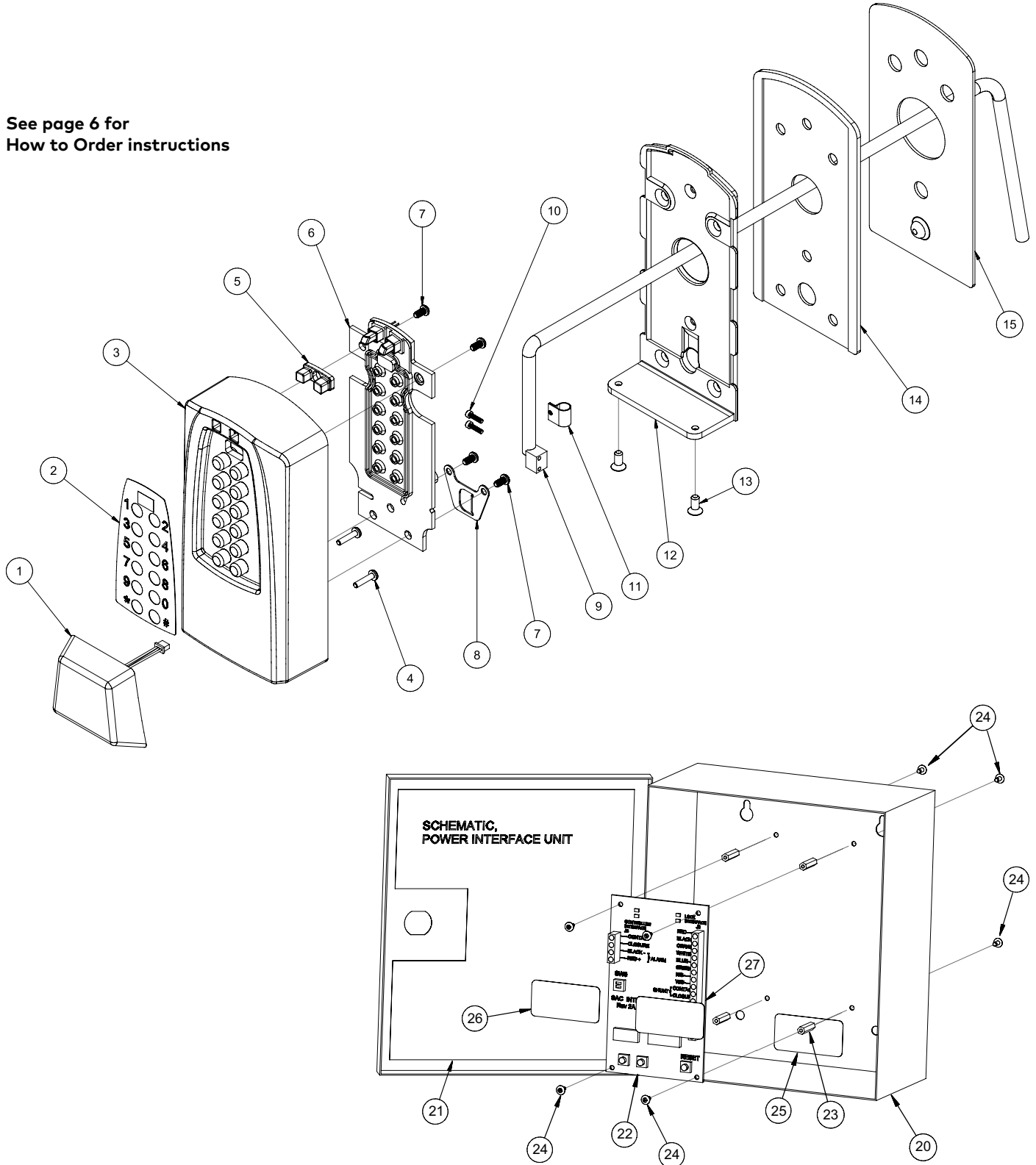

E-Plex[®] 5x70 SAC



Item	Qty/Lock	Description	Finish	Part Number	List Price (USD)
1	1	Antenna Cover Assembly, E5670 Only	Black	7540100001	\$64.00
		Antenna Cover Assembly, E5770 Only	Black	7538200001	\$64.00
		Antenna Cover Assembly, E5870/E5970 Only	Black	7538300001	\$64.00
2	1	Fascia (E5x70 Models Only)		5476400001	\$14.00
3	1	Outside Housing Assembly, (NO Reader Models - 5070/5270) (Includes 1 ea. #2, #3, and code buttons)	Satin Chrome	7534626D01	\$186.00
		Outside Housing Assembly, (NO Reader Models - 5070/5270) (Includes 1 ea. #2, #3, and code buttons)	Bright Brass	753460301	\$186.00
		Outside Housing Assembly, (NO Reader Models - 5070/5270) (Includes 1 ea. #2, #3, and code buttons)	Satin Brass	753460401	\$186.00
		Outside Housing Assembly, (NO Reader Models - 5070/5270) (Includes 1 ea. #2, #3, and code buttons)	Dark Bronze	7534674401	\$186.00
		Outside Housing Assembly, (NO Reader Models - 5070/5270) (Includes 1 ea. #2, #3, and code buttons)	Wrinkle Black	7534608301	\$186.00
		Outside Housing Assembly, (NO Reader Models - 5070/5270) (Includes 1 ea. #2, #3, and code buttons)	Bright Chrome	7534602601	\$186.00
		Outside Housing Assembly, (Reader Models 5670/5770/5870/5970) (Includes 1 ea. #2, #3 and code buttons)	Satin Chrome	7534226D01	\$200.00
		Outside Housing Assembly, (Reader Models 5670/5770/5870/5970) (Includes 1 ea. #2, #3 and code buttons)	Bright Brass	753420301	\$200.00
		Outside Housing Assembly, (Reader Models 5670/5770/5870/5970) (Includes 1 ea. #2, #3 and code buttons)	Satin Brass	753420401	\$200.00
		Outside Housing Assembly, (Reader Models 5670/5770/5870/5970) (Includes 1 ea. #2, #3 and code buttons)	Dark Bronze	7534274401	\$200.00
		Outside Housing Assembly, (Reader Models 5670/5770/5870/5970) (Includes 1 ea. #2, #3 and code buttons)	Wrinkle Black	7534208301	\$200.00
		Outside Housing Assembly, (Reader Models 5670/5770/5870/5970) (Includes 1 ea. #2, #3 and code buttons)	Bright Chrome	7534202601	\$200.00
4	2	Screw, 4-40 x .325", Pan Hd, Patch lock - Antenna Screw (10 Pack)		5461500010	\$14.00
5	1	Light Guide (Covers PCB Module LEDs)		5477300001	\$14.00
6	1	PCB Module (E5070 Only)		7534700001	\$333.00
		PCB Module (E5270 Only)		7535000001	\$426.00
		PCB Module (E5670 Only)		7540700001	\$638.00
		PCB Module (E5770 Only)		7534400001	\$545.00
		PCB Module (E5870 Only)		7535300001	\$638.00
		PCB Module (E5970 Only)		7535600001	\$638.00
7	4	Screw, #6 x 1/4", Phillips, Pan Hd (10 Pack)		5476600010	\$14.00
8	1	Switch Bracket		5476300001	\$10.00
9	1	Interface Cable with Micro Switch - Lock Interface Cable Kit (Includes 1 ea. #8, #9, #11; 2 ea. #10)		5474800001	\$85.00
10	2	Screw, M2 - 10MM, ISO Hex Socket Head (10 Pack)		5477600010	\$11.00
11	1	Cable Clamp, Nylon (5 Pack)		5477500005	\$14.00
12	1	Housing Base Plate		3431800001	\$54.00
13	2	Screw, 6-32 x 3/8", Pinned Torx (2 Pack)		5473700001	\$14.00
14	1	Housing Base Plate Moisture Barrier		5476800001	\$12.00
15	1	Housing Mounting Shim		5477700001	\$14.00
16	1	Pinned Torx Tool (not shown) - Included in Accessory Tool Kit		6471700001	\$14.00
20	1	Steel Enclosure for Power Interface Unit (Box Only), E5x70		9400300001	\$93.00
		PIU - Power Interface Unit Assembly, Complete E5x70 (Includes 1 ea. #20, #21, #22, #25, #26, #27; 4 ea. #23; 8 ea. #24)		7534300001	\$399.00























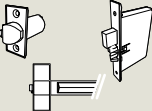
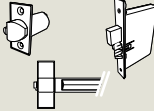
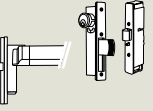
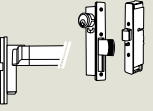
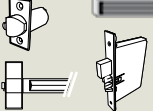
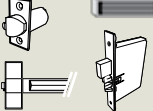
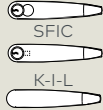
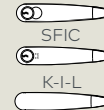











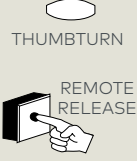
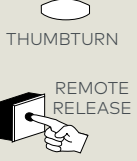
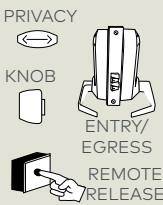
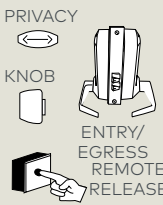





E-Plex®
5x70 SAC

Item	Qty/Lock	Description	Finish	Part Number	List Price (USD)
21	1	Label, PIU Schematic - Warning Label Kit (Includes 1 ea. #21, #25, #26, #27)		SAC-LABEL-001	\$11.00
22	1	Interface Board - Interface Board Kit (Includes 1 ea. #21, #22, #25, #26, #27; 4 ea. #23; 8 ea. #24)		9400200001	\$293.00
23	4	Standoffs, .750, #4-40 - Interface Board Mounting Kit (Includes 4 ea. #23; 8 ea. #24)		5477100001	\$14.00
24	8	Screw, 4-40 x 1/4" Phillips, Truss - Interface Board Mounting Screws (10 Pack)		5463100010	\$11.00
25	1	Label, Call - Do Not Return - Warning Label Kit (Includes 1 ea. #21, #25, #26, #27)		SAC-LABEL-001	\$11.00
26	1	Label, Voltage Warning - Warning Label Kit (Includes 1 ea. #21, #25, #26, #27)		SAC-LABEL-001	\$11.00
27	1	Label, Shunt Type Warning - Warning Label Kit (Includes 1 ea. #21, #25, #26, #27)		SAC-LABEL-001	\$11.00
28	1	Cam lock, Keyturn with Clip 5/8", 1/2" Offset (not shown)	Satin Chrome	L-33803F-01-018KA	\$16.00
		Cam lock, Thumbturn with Clip 5/8", 1/2" Offset (not shown)	Satin Chrome	A5831-Z-14-01	\$16.00
Additional Kits & Accessories			Finish	Part Number	List Price (USD)
		Literature Kit, E5070 SAC		PKG3246	\$20.00
		Literature Kit, E5270 SAC		PKG3247	\$20.00
		Literature Kit, E5770 SAC		PKG3276	\$20.00
		Literature Kit, E5870 SAC		PKG3286	\$20.00
		Literature Kit, E5970 SAC		PKG3239SAC	\$20.00
		E-Plex 5000 Standard Software Kit (Includes PC M-unit kit and software discs) (Excel-Based Templates) (300 users per lock)		EP-0300-001	*
		E-Plex 5200/5700 Enterprise Software Kit (Includes PC M-unit kit and software discs) (3,000 users per lock)		EP-EPRISE1-001	*
		E-Plex 5200/5700 Enterprise Demo Software (90 day expiry)		EP-EPRISE-DEMO	*
		E-plex 5700 USB Prox Reader/Enroller		5456100041	\$638.00
		E-Plex 5800 FIPS/DESFire Card Reader/Enroller		120-ENFIPS-000	\$339.00
		E-Plex 5800 OCSP FIPS Software		EP-OCSP-FIPS-SW	*
		E-Plex 5800 General FIPS Software		EP-GEN-FIPS-SW	*
		HID Proxcard II Proximity Access Card #1326M - Not Printable, with Slot (minimum order 100 pcs)		065-101066	*
		HID ISO Prox II Card (PVC-31 mils) #1336 - Printable, NO Slot (minimum 100 pcs)		065-507143	*
		HID DuoProx (PVC-31 mils) High C/Proximity #1336 - Printable, NO Slot (minimum 100 pcs)		065-507144	\$12.00
		HID Prox KEY II #1346 (FOB) (minimum order 100 pcs)		120-508051	*
		MicroProx Tag Proximity #1391 (Adhesive Backed Disc) (minimum order 100 pieces)		065-511072	*
		DESFire 2K Smart Card (for use with 3600/5600/5800)		352-DESFIR-02K	*













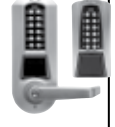





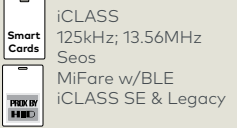





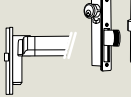
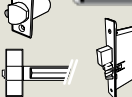
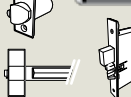
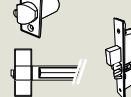









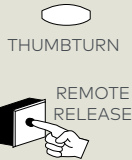
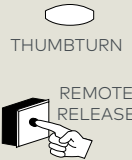
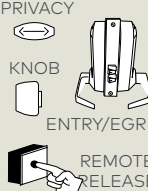
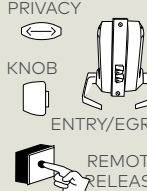
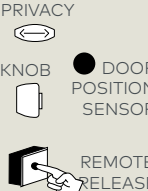



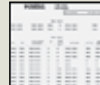

* For software and software related accessories, please visit www.dormakaba.us

A Solution for Every Access Point...and Every Budget.

E-Plex® PowerPlex	P2000	E2000	E3000	E3200	E5000 / E5070	E5200 / E5270
ACCESS CREDENTIALS						
NUMBER OF ACCESS CODES	 100 CODES	 100 CODES	 300 CODES	 3,000 CODES	 100/300* CODES	 3,000 CODES
LOCKING DEVICE OPTIONS						
KEY OVERRIDE	 NO KEY OVERRIDE	 NO KEY OVERRIDE	 REPLACEABLE MORTISE CYLINDER	 REPLACEABLE MORTISE CYLINDER	 SFIC, LFIC K-I-L	 SFIC, LFIC K-I-L
CERTIFICATIONS						
OPTIONS	 THUMBTURN	 THUMBTURN	 THUMBTURN REMOTE RELEASE	 THUMBTURN REMOTE RELEASE	 PRIVACY KNOB ENTRY/ EGRESS REMOTE RELEASE	 PRIVACY KNOB ENTRY/ EGRESS REMOTE RELEASE
SOFTWARE PROGRAMMING	 OPTIONAL	 OPTIONAL	 OPTIONAL	 REQUIRED	 OPTIONAL	 REQUIRED
AUDIT CAPABILITIES*	 1,000 EVENTS	 1,000 EVENTS	 9,000 EVENTS	 30,000 EVENTS	 9,000 EVENTS	 30,000 EVENTS
ACCESS SCHEDULES*				 SCHEDULES		 SCHEDULES

E-Plex® • PowerPlex

A Solution for Every Access Point...and Every Budget.

E-Plex®	E3600  Smart Cards	E3700  PROX BY	E5600 / 5670  Smart Cards	E5700 / E5770  PROX BY	E 7900  Smart Cards
ACCESS CREDENTIALS					
NUMBER OF ACCESS CODES	 3000 CODES/ 45000 CARDS (Aurora)	 3000 CODES/ 45000 CARDS (Aurora)	 3000 CODES/ 45000 CARDS (Aurora)	 3000 CODES/ 45000 CARDS (Aurora)	 No codes needed Supports 45,000 credentials
LOCKING DEVICE OPTIONS					
KEY OVERRIDE	 REPLACEABLE MORTISE CYLINDER	 REPLACEABLE MORTISE CYLINDER	 SFIC, LFIC K-I-L	 SFIC, LFIC K-I-L	 REPLACEABLE KIL; BEST (SFIC) & EQUIVALENT (NOT INCLUDED)
CERTIFICATIONS					
OPTIONS					
SOFTWARE PROGRAMMING	 OPTIONAL	 OPTIONAL	 OPTIONAL	 OPTIONAL	 KEYSCAN AURORA; KEYSKAN LUNA; E-PLEX ENTERPRISE
AUDIT CAPABILITIES	 30,000 EVENTS	 30,000 EVENTS	 30,000 EVENTS	 30,000 EVENTS	 30,000(Aurora)
ACCESS SCHEDULES	 SCHEDULES	 SCHEDULES	 SCHEDULES	 SCHEDULES	 512 SCHEDULES (Aurora)

E-Plex® • PowerPlex

E-Plex® • PowerPlex
Electronic Access Control
PIN-Based Products

		E2000	P2000	E3000	E3200	E5000 E5070	E5200 E5270
CREDENTIALS	PIN Access	<input checked="" type="checkbox"/>	<input checked="" type="checkbox"/>	<input checked="" type="checkbox"/>	<input checked="" type="checkbox"/>	<input checked="" type="checkbox"/>	<input checked="" type="checkbox"/>
	Dual Credential Access						
	125 kHz Prox Card						
	13.56 MHz Smart Card						
ACCESS USERS	100 Users per Door	<input checked="" type="checkbox"/>	<input checked="" type="checkbox"/>			<input checked="" type="checkbox"/>	
	300 Users per Door			<input checked="" type="checkbox"/>		*	
	3,000 Users per Door				<input checked="" type="checkbox"/>		<input checked="" type="checkbox"/>
LOCKING DEVICES	Cylindrical Latch	<input checked="" type="checkbox"/>	<input checked="" type="checkbox"/>			<input checked="" type="checkbox"/>	<input checked="" type="checkbox"/>
	Mortise (ASM)	<input checked="" type="checkbox"/>	<input checked="" type="checkbox"/>			<input checked="" type="checkbox"/>	<input checked="" type="checkbox"/>
	Exit Trim	<input checked="" type="checkbox"/>	<input checked="" type="checkbox"/>	<input checked="" type="checkbox"/>	<input checked="" type="checkbox"/>	<input checked="" type="checkbox"/>	<input checked="" type="checkbox"/>
	AR Latch/Deadbolt (not included)			<input checked="" type="checkbox"/>	<input checked="" type="checkbox"/>		
	Access Controller#					<input checked="" type="checkbox"/>	<input checked="" type="checkbox"/>
	Auxiliary Deadbolt						
POWER SRC.	PowerStar™ Available (no batteries)		<input checked="" type="checkbox"/>				
	Batteries or External Power Source	<input checked="" type="checkbox"/>		<input checked="" type="checkbox"/>	<input checked="" type="checkbox"/>	<input checked="" type="checkbox"/>	<input checked="" type="checkbox"/>
MECHANICAL FEATURES	No Wire Installation	<input checked="" type="checkbox"/>	<input checked="" type="checkbox"/>	<input checked="" type="checkbox"/>	<input checked="" type="checkbox"/>	<input checked="" type="checkbox"/>	<input checked="" type="checkbox"/>
	Mechanical Key Override	<input checked="" type="checkbox"/>	<input checked="" type="checkbox"/>	<input checked="" type="checkbox"/>	<input checked="" type="checkbox"/>	<input checked="" type="checkbox"/>	<input checked="" type="checkbox"/>
	Interchangeable Core (Best)	<input checked="" type="checkbox"/>	<input checked="" type="checkbox"/>	<input checked="" type="checkbox"/>	<input checked="" type="checkbox"/>	<input checked="" type="checkbox"/>	<input checked="" type="checkbox"/>
	Removable Core (Large Format)					<input checked="" type="checkbox"/>	<input checked="" type="checkbox"/>
	Removable Mortise Cylinder			<input checked="" type="checkbox"/>	<input checked="" type="checkbox"/>		
	Key-in-Lever Cylinder	<input checked="" type="checkbox"/>	<input checked="" type="checkbox"/>			<input checked="" type="checkbox"/>	<input checked="" type="checkbox"/>
	Non-handed	<input checked="" type="checkbox"/>	<input checked="" type="checkbox"/>	<input checked="" type="checkbox"/>	<input checked="" type="checkbox"/>	<input checked="" type="checkbox"/>	<input checked="" type="checkbox"/>
	Indoor/Outdoor (Approved)	<input checked="" type="checkbox"/>	<input checked="" type="checkbox"/>	<input checked="" type="checkbox"/>	<input checked="" type="checkbox"/>	<input checked="" type="checkbox"/>	<input checked="" type="checkbox"/>
	Various Finishes Available	<input checked="" type="checkbox"/>	<input checked="" type="checkbox"/>	<input checked="" type="checkbox"/>	<input checked="" type="checkbox"/>	<input checked="" type="checkbox"/>	<input checked="" type="checkbox"/>
LOCK SETUP	Via Lock Keypad	<input checked="" type="checkbox"/>	<input checked="" type="checkbox"/>	<input checked="" type="checkbox"/>		<input checked="" type="checkbox"/>	
	Via Software (Optional)	<input checked="" type="checkbox"/>	<input checked="" type="checkbox"/>	<input checked="" type="checkbox"/>		<input checked="" type="checkbox"/>	
	Via Software (Required)				<input checked="" type="checkbox"/>		<input checked="" type="checkbox"/>
	Upgradable to Wireless Network				<input checked="" type="checkbox"/>		<input checked="" type="checkbox"/>
PROGRAMMING FEATURES	LearnLok™ (Enroll Cards at Lock)						
	Access Schedules*				<input checked="" type="checkbox"/>		<input checked="" type="checkbox"/>
	Vacation/Holiday Blocks*				<input checked="" type="checkbox"/>		<input checked="" type="checkbox"/>
	Programmable User Levels	<input checked="" type="checkbox"/>	<input checked="" type="checkbox"/>	<input checked="" type="checkbox"/>	<input checked="" type="checkbox"/>	<input checked="" type="checkbox"/>	<input checked="" type="checkbox"/>
	Programmable Service Codes	<input checked="" type="checkbox"/>	<input checked="" type="checkbox"/>	<input checked="" type="checkbox"/>	<input checked="" type="checkbox"/>	<input checked="" type="checkbox"/>	<input checked="" type="checkbox"/>
	Programmable Passage Re-Lock	<input checked="" type="checkbox"/>		<input checked="" type="checkbox"/>	<input checked="" type="checkbox"/>	<input checked="" type="checkbox"/>	<input checked="" type="checkbox"/>
	First Manager—In Passage*				<input checked="" type="checkbox"/>		<input checked="" type="checkbox"/>
	Passage Mode	<input checked="" type="checkbox"/>	<input checked="" type="checkbox"/>	<input checked="" type="checkbox"/>	<input checked="" type="checkbox"/>	<input checked="" type="checkbox"/>	<input checked="" type="checkbox"/>
	Lockout Mode	<input checked="" type="checkbox"/>	<input checked="" type="checkbox"/>	<input checked="" type="checkbox"/>	<input checked="" type="checkbox"/>	<input checked="" type="checkbox"/>	<input checked="" type="checkbox"/>
AUDIT	1,000 Event Audit Trail*	<input checked="" type="checkbox"/>	<input checked="" type="checkbox"/>				
	9,000 Event Audit Trail*			<input checked="" type="checkbox"/>		<input checked="" type="checkbox"/>	
	30,000 Event Audit Trail*				<input checked="" type="checkbox"/>		<input checked="" type="checkbox"/>
WARRANTY CERTIFICATION	BHMA Grade 1 Certified	<input checked="" type="checkbox"/>	<input checked="" type="checkbox"/>	+	+	<input checked="" type="checkbox"/>	<input checked="" type="checkbox"/>
	Three-hour UL/ULC Fire Rating	<input checked="" type="checkbox"/>	<input checked="" type="checkbox"/>	N/A	N/A	<input checked="" type="checkbox"/>	<input checked="" type="checkbox"/>
	ADA Compliant	<input checked="" type="checkbox"/>	<input checked="" type="checkbox"/>	<input checked="" type="checkbox"/>	<input checked="" type="checkbox"/>	<input checked="" type="checkbox"/>	<input checked="" type="checkbox"/>
	3-Year Warranty	<input checked="" type="checkbox"/>	<input checked="" type="checkbox"/>	<input checked="" type="checkbox"/>	<input checked="" type="checkbox"/>	<input checked="" type="checkbox"/>	<input checked="" type="checkbox"/>
	Built-in Warranty Counter	<input checked="" type="checkbox"/>	<input checked="" type="checkbox"/>	<input checked="" type="checkbox"/>	<input checked="" type="checkbox"/>	<input checked="" type="checkbox"/>	<input checked="" type="checkbox"/>
SOFTWARE SUPPORT	Keyscan Aurora Software			<input checked="" type="checkbox"/>	<input checked="" type="checkbox"/>	<input checked="" type="checkbox"/>	<input checked="" type="checkbox"/>
	Keyscan LUNA Software						
	E-Plex Enterprise			<input checked="" type="checkbox"/>	<input checked="" type="checkbox"/>	<input checked="" type="checkbox"/>	<input checked="" type="checkbox"/>

