

Washroom  
Accessories





# FORGET EVERYTHING YOU KNOW ABOUT WASHROOM DESIGN

Welcome to the new standard for basis of design in washrooms. So what makes ASI so unique? For starters, we are the world's leading manufacturer of commercial washroom accessories. Welcome to choice, welcome to innovations, welcome to ASI.

## How to use this brochure:

This brochure offers three ways to navigate our comprehensive portfolio of washroom accessories:

**Navigate by collections**—a family of complementary-designed products, see pages 6 & 7.

**Navigate by specific product category**, see pages 8 & 9.

**Navigate the index by product category or model number**, see pages 126-129.



**WE ARE LASER FOCUSED ON DELIVERING EXACTLY WHAT YOU NEED—WHERE AND WHEN YOU NEED IT.**

ASI Group's Global Reach—see how on pages 124-125.





# WELCOME TO THE NEW STANDARD FOR BASIS OF DESIGN.



## 1 WASHROOM ACCESSORIES

The world's leading manufacturer of commercial washroom accessories. We offer the most comprehensive selection of washroom accessories available anywhere.



## 2 PARTITIONS

A wide range of partitions designed to enhance any interior.



Welcome to the ASI Group—the world’s leading manufacturer of partitions, washroom accessories, lockers, and visual display products.

What makes ASI Group so unique? Only ASI Group designs, engineers, and manufactures fully integrated solutions—all of our products work together seamlessly. We offer the greatest experience in the industry with the largest product breadth delivered when and where you need them.



### 3 LOCKERS + BENCHES

Available to be built in any configuration matrix with multiple base options, tiers, and styles to choose from.



### 4 VISUAL DISPLAY PRODUCTS

Through constant research, innovation, and development, we design and manufacture high quality visual display products that are easy to install and require little maintenance.

## OUR COLLECTIONS

# SEVEN DISTINCT COLLECTIONS CURATED TO WORK IN ANY WASHROOM DESIGN

While ASI offers hundreds of individual accessories, we have simplified the specifying process with our seven distinct collections to serve your project's individual needs. And each of our seven collections was designed as a suite of products that complement one another. Welcome to aesthetics and function in perfect harmony. Welcome to the new standard for basis of design in washrooms.



**Piatto™** Collection **P.10**

ASI's distinctive new collection of washroom accessories is designed to stand apart by not standing out—making it integral with your washroom design. Each washroom accessory is designed to be completely recessed with concealed hinges and hardware.

**NEW** Matte Black Collection **P.14**

ASI's Matte Black Collection provides a chic alternative for modern washrooms. Carefully curated to be versatile and powder coated for added durability, these accessories are ready to make a statement in any setting. The boldness of black creates an air of sophistication, while the subtlety of the matte finish exudes warmth.



**Velare™** Collection **P.18**

An elegant space-saving solution, designed to tuck away clutter, this wall mounted stainless steel cabinet conceals an automatic soap dispenser, and your choice of a paper towel dispenser or high-speed hand dryer.



### Roval™ Collection P22

This elegant, durable, exceptionally functional collection features subtle curves, one-piece seamless doors, and flush tumbler locks, along with fully removable waste cans, strong hinges, and integral locking system.

### Profile™ Collection P30

Manufactured with highly durable 16 gauge stainless steel doors and 20 gauge cabinets. Concealed heavy-duty piano hinges ensure smooth and long-lived operation, and rimless keyed-alike flush tumbler locks offer strong security with an elegant look.



### Simplicity™ Collection P36

This elegant collection combines seamless construction and crisp design lines to provide strength and comfort, beauty and durability, form and function. 18 gauge doors and 20 gauge cabinets conceal heavy-duty piano hinges.



### Traditional™ Collection P44

This high-value collection features 22 gauge double-pan doors incorporating a “no-flex” structural fiberboard core. 22 gauge cabinets, heavy-duty piano hinges, and keyed-alike tumbler locks complete this broad product line.







**BALLROOM?  
NO, IT'S YOUR  
LOCKER ROOM.**

ASI just gave the locker room a makeover—you can too. Visit [asi-storage.com/bod](http://asi-storage.com/bod) to explore the new standard for basis of design in locker rooms. **Featured above are ASI phenolic Z-lockers, ASI Alpaco™ phenolic partitions, Piatto™ completely recessed phenolic accessories, and our exclusive Velare™ concealing mirror cabinet.**



# THE LARGEST PRODUCT BREADTH WITH OVER 3,000 WASHROOM ACCESSORIES

Why mix and match disparate washroom accessory products from different manufacturers, when our company has designed, engineered, and manufactured everything you need from one source? Welcome to integrated solutions. Welcome to ASI.



P. 54

**Hand Dryers**



P. 60

**Soap Dispensers**



P. 68

**Sanitizing (NO) Touch Accessories**



P. 72

**Mirrors**



P. 77

**Feminine Hygiene Vendors and Disposals**

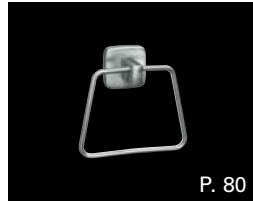

P. 80

**Specialty Accessories**

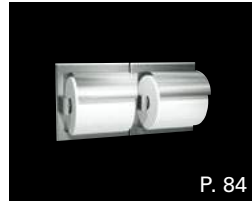

P. 84

**Toilet Paper Dispensers**

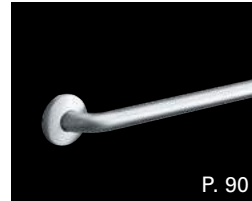

P. 90

**Grab Bars**



P. 92

**Shower/Tub Accessories**



P. 96

**Baby Changing Stations**

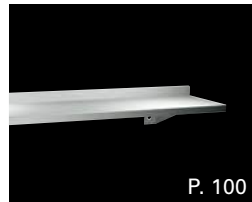

P. 100

**Shelves**

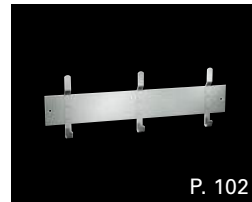

P. 102

**Custodial Accessories**



P. 104

**Healthcare Accessories**



P. 110

**Hospitality Accessories**



P. 116

**Security Accessories**



P. 120

**Waste Receptacles**



Our Paper Towel Dispensers and Combination Units can be found within our collections on pages 10–53.

SHOWN: 6462-41 PAPER TOWEL  
DISPENSER AND WASTE RECEPTACLE



# PIATTO™ COLLECTION

ASI's distinctive new collection of washroom accessories is designed to stand apart by not standing out—making it integral with your washroom design. Each washroom accessory is designed to be completely recessed, lying perfectly in the plane of the washroom wall

without any protrusion. The high-end door hinges, used to achieve this precise coplanar fit, are easily adjusted in the field. ½" (13 mm) Phenolic doors in matte black or white, close silently and effortlessly, and add an air of sophistication.

## WHAT MAKES THE PIATTO™ COLLECTION UNIQUE?

### COMPLETELY RECESSED

#### UNIQUE DESIGN

The Piatto™ collection is designed to be coplanar to the wall—an ASI exclusive.

### PHENOLIC DOORS

#### ELEVATED STYLE—A NEW CHOICE

Phenolic doors in matte black or white were created to accentuate your washroom design.

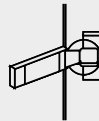

#### INNOVATIVE HINGES

3-way, adjustable hinges allow flexibility in the field and are concealed along with all other hardware.

### VIRTUALLY GAPLESS FIT

#### STANDS APART BY BLENDING IN

A combination of technology and design ensures a perfect fit adding to your design by not detracting from it.



#### THREE-WAY ADJUSTABLE HINGE

An innovative hinge technology allows cabinet and doors to be completely recessed, with no protrusions from the plane of the wall surface. Doors can be adjusted in the field.

- Phenolic Doors
- Completely Recessed Mounting
- Concealed Internal Spring-Loaded Latch
- No Visible Hardware





**6474**

**PIATTO™ WASTE RECEPTACLE**

This unit comes with a phenolic door and concealed hardware, and is designed to be *completely* recessed into the plane of the washroom wall. Stainless steel receptacle holds 12 gal. (46 L) of washroom waste materials. For matte black phenolic door use suffix -41, for white use -00.

**Unit Size:**  
17¼" x 40" x 6⅞"  
(438 x 1016 x 166 mm)

**Finished Wall Opening\*:**  
17⅝" x 40⅞" x 6⅞"  
(440 x 1018 x 170 mm)



**64672-1**

**PIATTO™ COMPLETELY RECESSED 3-IN-1 PAPER TOWEL DISPENSER, HIGH-SPEED HAND DRYER, AND WASTE RECEPTACLE**

This unit comes with a phenolic door and concealed hardware, and is designed to be *completely* recessed into the plane of the washroom wall. Features a <15 second automatic hand dryer, dispenses 400 standard C-fold or 500 standard multi-fold paper towels with a waste capacity of 6.8 gal. (26 L). Dryer has 5-year warranty. 110-120 V. Available in 208-240 V (-2). For matte black phenolic door use suffix -41, for white use -00.

**Unit Size:**  
15⅝" x 55⅝" x 7⅞"  
(391 x 1407 x 191 mm)

**Finished Wall Opening\*:**  
15⅞" x 55⅞" x 7⅞"  
(392 x 1408 x 194 mm)

**Decibel Level:** 68.9-74.3 dB-A @ 2M



**6457**

**PIATTO™ PAPER TOWEL DISPENSER**

This unit comes with a phenolic door and concealed hardware, and is designed to be *completely* recessed into the plane of the washroom wall. Well-suited for smaller washroom with less space and traffic. Dispenses 350 C-fold or 475 multi-fold paper towels. For matte black phenolic door use suffix -41, for white use -00.

**Unit Size:**  
12¾" x 17¼" x 4⅞"  
(324 x 438 x 116 mm)

**Finished Wall Opening\*:**  
12⅞" x 17⅝" x 4¾"  
(325 x 440 x 121 mm)



**64696A/AC**

**PIATTO™ AUTOMATIC ROLL PAPER TOWEL DISPENSER AND WASTE RECEPTACLE**

This unit comes with a phenolic door and concealed hardware, and is designed to be *completely* recessed into the plane of the washroom wall. No-touch unit dispenses a pre-set length per cycle from 8" (203 mm) wide, 800 ft. (244 m) long rolls. Includes 9.9 gal. (37.3 L) stainless steel waste receptacle. Battery powered. Available in AC Powered (AC). For matte black phenolic door use suffix -41, for white use -00.

**Unit Size:**  
16⅞" x 41¼" x 9⅞"  
(408 x 1048 x 246 mm)

**Finished Wall Opening\*:**  
16⅞" x 41⅝" x 10"  
(410 x 1049 x 254 mm)

ALL STAINLESS STEEL IS TYPE 304 WITH SATIN FINISH, UNLESS OTHERWISE NOTED.

\*All Piatto™ models require finished wall openings for installation. The edges of the finished wall opening are meant to be visible after installation, hence edges must be flat, square, straight, and plumb—no rough or unsightly edges.



**6462**  
**PIATTO™ PAPER TOWEL DISPENSER  
 AND WASTE RECEPTACLE**

This unit comes with a phenolic door and concealed hardware, and is designed to be *completely* recessed into the plane of the washroom wall. Dispenses 600 C-fold, 800 multi-fold, or 1,100 single-fold towels. 9 gal. (34 L) stainless steel waste receptacle. Towel dispensing slot has hemmed-in rolled edge for snag-free dispensing and user safety. For matte black phenolic door use suffix -41, for white use -00.

**Unit Size:** 17¼" x 54" x 6<sup>9</sup>/<sub>16</sub>"  
 (438 x 1372 x 166 mm)  
**Finished Wall Opening\*:** 17<sup>7</sup>/<sub>16</sub>" x 54<sup>1</sup>/<sub>16</sub>" x 6<sup>1</sup>/<sub>16</sub>"  
 (440 x 1373 x 170 mm)



**6467**  
**PIATTO™ PAPER TOWEL DISPENSER  
 AND WASTE RECEPTACLE**

This unit comes with a phenolic door and concealed hardware, and is designed to be *completely* recessed into the plane of the washroom wall. Dispenses 600 C-fold or 800 multi-fold paper towels. Towel dispensing slot has hemmed-in rolled edge for snag-free dispensing and user safety. Includes 4.24 gal. (16 L) stainless steel waste receptacle. For matte black phenolic door use suffix -41, for white use -00.

**Unit Size:** 13" x 55" x 4<sup>9</sup>/<sub>16</sub>"  
 (330 x 1397 x 116 mm)  
**Finished Wall Opening\*:** 13<sup>1</sup>/<sub>16</sub>" x 55<sup>1</sup>/<sub>16</sub>" x 4<sup>1</sup>/<sub>16</sub>"  
 (332 x 1399 x 119 mm)



**64623**  
**PIATTO™ PAPER TOWEL DISPENSER  
 AND WASTE RECEPTACLE**

This unit comes with a phenolic door and concealed hardware, and is designed to be *completely* recessed into the plane of the washroom wall. Well-suited for the smaller washroom with less space and traffic. Dispenses 350 C-fold or 475 multi-fold paper towels. Includes 2.2 gal. (8.4 L) stainless steel waste receptacle. For matte black phenolic door use suffix -41, for white use -00.

**Unit Size:** 14¼" x 28" x 4<sup>9</sup>/<sub>16</sub>"  
 (362 x 711 x 116 mm)  
**Finished Wall Opening\*:** 14<sup>5</sup>/<sub>16</sub>" x 28<sup>1</sup>/<sub>16</sub>" x 4<sup>1</sup>/<sub>16</sub>"  
 (364 x 713 x 119 mm)



**645210A/AC**  
**PIATTO™ AUTOMATIC ROLL PAPER TOWEL DISPENSER**

This unit comes with a phenolic door and concealed hardware, and is designed to be *completely* recessed into the plane of the washroom wall. Proximity sensing no-touch unit dispenses an owner-adjustable length per cycle from 8" (203 mm) wide, 800 ft. (244 m) long rolls. Battery powered. Available in AC Powered (AC). For matte black phenolic door use suffix -41, for white use -00.

**Unit Size:** 16<sup>1</sup>/<sub>16</sub>" x 28" x 9<sup>13</sup>/<sub>16</sub>"  
 (408 x 711 x 248 mm)  
**Finished Wall Opening\*:** 16<sup>1</sup>/<sub>16</sub>" x 28<sup>1</sup>/<sub>16</sub>" x 10"  
 (410 x 713 x 254 mm)

Note: ASI Piatto™ products are made to order and are not returnable.

SHOWN: 0042-41 JUMBO ROLL TOILET TISSUE DISPENSER,  
0210-41 SURFACE MOUNTED PAPER TOWEL DISPENSER, AND  
9343-41 LIQUID SOAP DISPENSER



**NEW**

## **MATTE BLACK** COLLECTION

ASI's Matte Black Collection provides a chic alternative for modern washrooms. Carefully curated to be versatile and powder coated for added durability, these accessories are ready to make a statement in any setting. The boldness of black creates an air of sophistication, while the subtlety of the matte finish exudes warmth.

Born out of the desire for something new and contemporary without sacrificing reliability that comes from the proven, this collection is easily paired with a wide variety of washroom accessories and toilet partitions, ranging from phenolic and plastic laminate to powder coated or stainless steel.





**64672-41PC**  
**SIMPLICITY™ IN MATTE BLACK**  
**RECESSED 3-IN-1 CABINET—PAPER**  
**TOWEL DISPENSER, WASTE**  
**RECEPTACLE, AND HIGH-SPEED**  
**HAND DRYER\***

Cabinet dispenses 500 standard multi-fold or 400 standard C-fold paper towels and has a waste capacity of 6.8 gal. (26 L). 18 gauge stainless steel door, with matte black powder coated finish.

\*Hand Dryer sold separately.

**Unit Size:**  
 15<sup>3</sup>/<sub>8</sub>" x 55<sup>3</sup>/<sub>8</sub>" x 7<sup>1</sup>/<sub>2</sub>"  
 (391 x 1407 x 191 mm)

**Wall Opening:**  
 14<sup>3</sup>/<sub>32</sub>" x 54<sup>3</sup>/<sub>8</sub>" x 7<sup>1</sup>/<sub>4</sub>"  
 (358 x 1381 x 184 mm)



**6467-41PC**  
**SIMPLICITY™ IN MATTE**  
**BLACK RECESSED PAPER**  
**TOWEL DISPENSER & WASTE**  
**RECEPTACLE**

This recessed matte black powder coated stainless steel unit dispenses 600 C-fold or 800 multi-fold paper towels and has a 4.2 gal. (16 L) waste receptacle. 18 gauge door held closed with two (2) tumbler locks. Waste receptacle has a rolled edge finger hole for easy servicing.

**Unit Size:** 13" x 55" x 4<sup>3</sup>/<sub>4</sub>"  
 (330 x 1397 x 121 mm)      **Wall Opening:** 11<sup>1</sup>/<sub>2</sub>" x 53<sup>1</sup>/<sub>2</sub>" x 4"  
 (292 x 1359 x 102 mm)

**MODEL OPTION:**  
**6467-9-41PC** Surface mounted with a matte black powder coated stainless steel collar.



**6474-41PC**  
**SIMPLICITY™ IN MATTE BLACK**  
**RECESSED WASTE RECEPTACLE**

Matte black powder coated stainless steel waste receptacle holds 12 gal. (45.4 L) of washroom waste materials. 18 gauge door is held closed with two (2) tumbler locks to prevent unauthorized access or removal.

**Unit Size:**  
 17<sup>1</sup>/<sub>4</sub>" x 40" x 6<sup>3</sup>/<sub>4</sub>"  
 (438 x 1016 x 171 mm)

**Wall Opening:**  
 15<sup>3</sup>/<sub>4</sub>" x 38<sup>1</sup>/<sub>2</sub>" x 6<sup>1</sup>/<sub>4</sub>"  
 (400 x 978 x 159 mm)

**MODEL OPTION:**  
**6474-2-41PC** Semi-recessed with a matte black powder coated stainless steel collar.



**64623-41PC**  
**SIMPLICITY™ IN MATTE BLACK**  
**RECESSED PAPER TOWEL**  
**DISPENSER AND WASTE**  
**RECEPTACLE**

Dispenses 350 C-fold or 475 multi-fold paper towels. Includes 2.2 gal. (8.4 L) stainless steel waste receptacle. 18 gauge door is held closed with tumbler lock.

**Unit Size:** 14<sup>1</sup>/<sub>4</sub>" x 28" x 4<sup>3</sup>/<sub>4</sub>"  
 (362 x 711 x 121 mm)      **Wall Opening:** 12<sup>3</sup>/<sub>4</sub>" x 26<sup>1</sup>/<sub>2</sub>" x 4<sup>1</sup>/<sub>4</sub>"  
 (324 x 673 x 108 mm)

**MODEL OPTION:**  
**64623-9-41PC** Surface mounted with a matte black powder coated stainless steel collar.



**0210-41**  
**MATTE BLACK SURFACE**  
**MOUNTED PAPER TOWEL**  
**DISPENSER**

Fabricated of 22 gauge stainless steel with matte black powder coated finish, this unit dispenses 400 C-fold or 525 multi-fold paper towels without adjustment or adapters and is fitted with a tumbler lock and heavy-duty stainless steel piano hinge.

**Overall Dimensions:**  
 11<sup>1</sup>/<sub>8</sub>" x 14<sup>5</sup>/<sub>8</sub>" x 4"  
 (282 x 371 x 101 mm)



**0477-SM-41**  
**MATTE BLACK SURFACE**  
**MOUNTED TOILET SEAT COVER**  
**DISPENSER**

This surface mounted unit dispenses 250 single or half-fold seat covers and is fabricated of 22 gauge stainless steel with a matte black powder coated finish.

**Unit Size:**  
 15<sup>3</sup>/<sub>4</sub>" x 11" x 1<sup>5</sup>/<sub>8</sub>"  
 (400 x 279 x 48 mm)



**0362-41**  
**AUTOMATIC LIQUID SOAP AND**  
**GEL HAND SANITIZER DISPENSER**

Stainless steel soap and gel hand sanitizer dispenser in matte black finish has a capacity of 27 oz. (.8 L) and includes a tamper-resistant sight gauge.

**Overall Dimensions:**  
 $4\frac{13}{16}'' \times 10\frac{5}{8}'' \times 4\frac{1}{8}''$   
 (122 x 270 x 105 mm)



**0347-41**  
**VERTICAL SOAP DISPENSER**  
**0345-41**  
**HORIZONTAL SOAP DISPENSER**

40 fl. oz. (1.2 L) capacity liquid soap dispenser in stainless steel with matte black powder coated finish comes with an all-purpose valve and a tamper-resistant sight gauge.

**0347 Unit Size:**  
 $4\frac{13}{16}'' \times 8\frac{3}{16}'' \times 3\frac{15}{16}''$   
 (122 x 208 x 100 mm)

**0345 Unit Size:**  
 $8\frac{3}{16}'' \times 4\frac{13}{16}'' \times 3\frac{15}{16}''$   
 (208 x 122 x 100 mm)

Spout projection:  $\frac{15}{16}''$  (24 mm)



**9343-41**  
**LIQUID SOAP DISPENSER**

Matte black powder coated stainless steel liquid soap dispenser has a capacity of 48 fl. oz. (1.4 L). Includes a tamper-resistant sight gauge with concealed fastening and vandal-resistant hinged filler-top.

**Overall Dimensions:**  
 $7\frac{1}{4}'' \times 6\frac{1}{2}'' \times 3\frac{1}{16}''$   
 (184 x 165 x 94 mm)

Spout Projection:  $\frac{15}{16}''$  (24 mm)



**0042-41**  
**JUMBO ROLL TOILET TISSUE**  
**DISPENSER**

Holds one roll up to 10" (254 mm) diameter of  $1\frac{5}{8}''$  or  $2\frac{1}{4}''$  (41 or 57 mm) diameter core. Constructed of stainless steel with a matte black powder coated finish. Unit has viewing slot and tumbler lock.

**Overall Dimensions:**  
 $10\frac{5}{8}'' \times 10\frac{5}{8}'' \times 4\frac{1}{2}''$   
 (270 x 270 x 114 mm)



**7305-41**  
**SINGLE TOILET TISSUE HOLDER**  
**7305-2-41**  
**DOUBLE TOILET TISSUE HOLDER**

Fabricated of stainless steel with matte black powder coated finish. Includes chrome plated rollers and holds one (or two for -2 model) 1800 sheet standard core roll. Heavy gauge concealed bracket mounts on wall.

**7304-41**  
**Dimensions:**  
 $7\frac{3}{4}'' \times 2'' \times 3\frac{3}{8}''$   
 (207 x 51 x 98 mm)

**7305-2-41**  
**Dimensions:**  
 $13\frac{1}{2}'' \times 2'' \times 3\frac{3}{8}''$   
 (343 x 51 x 98 mm)



**0600-41**  
**INTER-LOK ANGLE FRAME**  
**MIRROR**

$\frac{3}{4}'' \times \frac{5}{8}''$  (19 x 16 mm) roll formed 18 gauge stainless steel angle frame has corners heliarc welded, ground and polished smooth. Mirror is installed on a concealed hanging bracket that locks onto top and bottom of frame by tamper-proof set screws.

**MODEL OPTIONS:**  
**0600-1836-41** – 18" wide x 36" high  
 (457 x 914 mm)

**0600-2436-41** – 24" wide x 36" high  
 (610 x 914 mm)



**0196-41  
TURBO-PRO™ HIGH-SPEED ADA  
HAND DRYER**

Elegant ADA-compliant, high-speed, automatic hand dryer. A HEPA filter is used to purify the air before it dries hands. The dryer provides operating flexibility—the owner controls air temperature as well as air speed. Fast drying, <15 seconds. Available in 110-120 V (-1) and 208-240 V (-2).

**Overall Dimensions:**  
8<sup>3</sup>/<sub>8</sub>" x 13<sup>3</sup>/<sub>16</sub>" x 4"  
(219 x 345 x 102 mm)

**Decibel Level:** 68-73.8 dB-A @ 2M



**0397-1AC-41  
EZ FILL™ WATER FAUCET**

**0394-1AC-41  
EZ FILL™ FOAM SOAP DISPENSER**

EZ Fill™ Top Fill Multi-Feed Soap Dispensing System allows for refill of up to 6 liquid or foam soap dispensers with one pour. The 6L (203 oz.) tank is ideal for high-traffic environments.

Complete the look with the matching EZ Fill™ Water Faucet.

See all EZ Fill™ model options on page 61.



**3801-41  
STRAIGHT GRAB BAR**

Features include cover that snaps over mounting flange dimples to conceal screws and concealed mounting flange of 3<sup>1</sup>/<sub>8</sub>" (79 mm) O.D. diameter with 2 screw holes and 3 locking dimples; 1<sup>1</sup>/<sub>8</sub>" (3 mm) thick, type 304 stainless steel.

**MODEL OPTIONS:**

- 3801-18-41** – 18" (457 mm)
- 3801-24-41** – 24" (610 mm)
- 3801-36-41** – 36" (914 mm)
- 3801-42-41** – 42" (1067 mm)



**7385-41  
TOWEL RING**

For bath and hand towels. Support post is 1/2" x 1" (13 mm x 25 mm) rectangular tubing with formed mounting flange and bracket welded on end. Ring formed from 1/4" diameter (Ø6.4 mm) stainless steel rod with matte black powder coated finish.

**Unit Size:**  
4 1/2" x 5" x 2 1/2"  
(114 x 127 x 64 mm)



**7355-24-41  
TOWEL BAR – 24"**

3/4" (19 mm) diameter towel bar and mounting bracket are fabricated of stainless steel with a matte black powder coated finish. Extends 3/4" (83 mm) from wall.

**Unit Size:**  
24" x 2" x 3 1/4"  
(106 x 51 x 83 mm)



**7340-41  
SINGLE ROBE HOOK**

Hook extends 2" (51 mm) from wall and is suitable for a robe or clothing and small carry bags. Fabricated from stainless steel with a matte black powder coated finish.

**Unit Size:**  
2" x 2" x 2"  
(51 x 51 x 51 mm)



SHOWN: 0661-T VELARE™ BTM SYSTEM – STAINLESS STEEL  
CABINET WITH FRAMELESS MIRROR, LIQUID SOAP DISPENSER,  
AND PAPER TOWEL DISPENSER



# VELARE™ COLLECTION

An elegant space-saving solution, designed to tuck away clutter, this wall mounted stainless steel cabinet conceals an automatic soap dispenser, and your choice of a paper towel dispenser or high-speed hand dryer (Dryer Model 0196—equipped with a HEPA filter).

The sophisticated design is ideal for iconic buildings—the dispensing capacity makes it ideal for any high-traffic environment. Another reason to specify ASI!

## WHAT MAKES THE VELARE™ COLLECTION UNIQUE?

### ARTFULLY CONCEALED

#### ARTFULLY CONCEALED

Consumables are concealed behind the mirror to accentuate the overall style.

### SOAP



#### CONCEALED SOAP DISPENSER

High-capacity foam or liquid soap dispenser makes Velare™ ideal for high frequency use restrooms.

### TOWEL



#### PAPER TOWEL OPTION

Velare™ provides paper towels as an option for drying hands. 500 towel capacity.

### AIR



#### HAND DRYER OPTION

Optional high-speed, low-decibel hand dryer is equipped with a HEPA filter.

### ALL-IN-ONE CABINET HOUSES AN AUTOMATIC SOAP DISPENSER, AND YOUR CHOICE OF PAPER TOWEL DISPENSER OR HAND DRYER—NOW AVAILABLE WITH MIRROR FILLERS FOR FLEXIBILITY.

Backlit icons etched into the frameless mirror direct the user to their choice of soap and drying option. The self-contained design reduces hazards associated with wet floors. The ¼" thick tempered glass mirror, supported by twin, damped gas springs, opens up to 90° for easy maintenance.





**0661-1**  
**VELARE™ STAINLESS STEEL CABINET WITH**  
**FRAMELESS MIRROR, LIQUID SOAP DISPENSER,**  
**AND HIGH-SPEED HAND DRYER (110-120 V)**

Designed with elegance and safety in mind, this wall mounted stainless steel cabinet conceals a hands-free automatic liquid soap dispenser with a .4 gal. (1.5 L) capacity and a high-speed hand dryer (110-120 V) equipped with a HEPA filter.

**MODEL OPTION:**  
**0661-2** Velare™ Stainless Steel Cabinet with Liquid Soap and Hand Dryer (208-240 V).

**Overall Dimensions:**  
 23<sup>3</sup>/<sub>16</sub>" x 35<sup>7</sup>/<sub>16</sub>" x 7<sup>9</sup>/<sub>16</sub>"  
 (600 x 900 x 192)



**0661-T**  
**VELARE™ STAINLESS STEEL CABINET WITH**  
**FRAMELESS MIRROR, LIQUID SOAP DISPENSER,**  
**AND PAPER TOWEL DISPENSER**

This wall mounted stainless steel cabinet conceals a hands-free automatic liquid soap dispenser with a .4 gal. (1.5 L) capacity and paper towel dispenser with a 500 towel capacity.

**Overall Dimensions:**  
 23<sup>3</sup>/<sub>16</sub>" x 35<sup>7</sup>/<sub>16</sub>" x 7<sup>9</sup>/<sub>16</sub>"  
 (600 x 900 x 192)



**0661-FM-14**  
**VELARE™ STAINLESS STEEL FRAMELESS**  
**MIRROR FILLER MODULE**

Wall mounted stainless steel cabinet filler module provides spacing between other Velare™ BTM modules where needed. Mirror is made from 1/4" (6 mm) thick frameless tempered glass conforming to ASTM C-1048 with pencil edges and eased corners with SS sheet intermediate stiffener and SS back plate with integral welded support mounts.

**Overall Dimensions:**  
 14<sup>3</sup>/<sub>4</sub>" x 35<sup>7</sup>/<sub>16</sub>" x 7<sup>9</sup>/<sub>16</sub>"  
 (375 x 900 x 192)



**0661-FM-23**  
**VELARE™ STAINLESS STEEL FRAMELESS**  
**MIRROR FILLER MODULE**

Wall mounted stainless steel cabinet filler module provides spacing between other Velare™ BTM modules where needed. Mirror is made from 1/4" (6 mm) thick frameless tempered glass conforming to ASTM C-1048 with pencil edges and eased corners with SS sheet intermediate stiffener and SS back plate with integral welded support mounts.

**Overall Dimensions:**  
 23<sup>1</sup>/<sub>4</sub>" x 35<sup>7</sup>/<sub>16</sub>" x 7<sup>9</sup>/<sub>16</sub>"  
 (591 x 900 x 192)





**0663-1  
VELARE™ STAINLESS STEEL CABINET WITH  
FRAMELESS MIRROR, FOAM SOAP DISPENSER,  
AND HIGH-SPEED HAND DRYER (110-120 V)**

This wall mounted stainless steel cabinet conceals a hands-free automatic foam soap dispenser with a .4 gal. (1.5 L) capacity and a high-speed hand dryer (110-120 V) equipped with a HEPA filter.

**MODEL OPTION:**  
**0663-2** Velare™ Stainless Steel Cabinet with Foam Soap and Hand Dryer (208-240 V).

**Overall Dimensions:**  
23<sup>3</sup>/<sub>16</sub>" x 35<sup>7</sup>/<sub>16</sub>" x 7<sup>9</sup>/<sub>16</sub>"  
(600 x 900 x 192)



**0663-T  
VELARE™ STAINLESS STEEL CABINET WITH  
FRAMELESS MIRROR, FOAM SOAP DISPENSER,  
AND PAPER TOWEL DISPENSER**

This wall mounted stainless steel cabinet conceals a hands-free automatic foam soap dispenser with a .4 gal. (1.5 L) capacity and paper towel dispenser with a 500 towel capacity.

**Overall Dimensions:**  
23<sup>3</sup>/<sub>16</sub>" x 35<sup>7</sup>/<sub>16</sub>" x 7<sup>9</sup>/<sub>16</sub>"  
(600 x 900 x 192)

Aptly named **Velare™**, which means to veil, this elegant, space-saving mirror cabinet lives up to its name by concealing a soap dispenser (liquid or foam) and your choice of a high-speed hand dryer or paper towel dispenser.

Velare™ minimizes the hazards of water spilling on the floor by housing soap and drying components directly above the sink. The mirror, made of 1/4" thick tempered glass with pencil edges, is supported by twin damped gas springs, which allow the cabinet to be opened up to 90° for easy maintenance.

Backlit icons etched into the mirror intuitively indicate soap and drying options, making this cabinet both elegant and easy to use. This marriage of elegance, safety, and functionality makes Velare™ ideal for a wide range of building types, from sophisticated corporate headquarters to high-traffic washrooms in entertainment centers and airports.



SHOWN: 20469 RECESSED  
PAPER TOWEL DISPENSER  
AND WASTE RECEPTACLE



# ROVAL™ COLLECTION

Engineered for high-profile settings, this collection adds elegance, durability, and exceptional functionality to any washroom without becoming the focal point.

This collection is ideal for the most aesthetically demanding applications. All features are functionally superior, quickly installed, and easily maintained.

## WHAT MAKES THE ROVAL™ COLLECTION UNIQUE?

**18-22**  
GAUGE

### STAINLESS STEEL CONSTRUCTION

Our collection is constructed of stainless steel, which is tough, durable, stain-resistant, and easy to clean.



### INTEGRAL LOCKING SYSTEM

Our durable, integral locking system prevents tampering and theft.

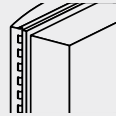

### STAKED PIANO HINGES

Our heavy-duty, staked piano hinges provide security and a neat appearance, and they stand up to heavy use.



### REMOVABLE WASTE RECEPTACLE

Fully removable waste cans allow contents to be easily discarded for efficient ongoing maintenance and cleanliness.



**MANUAL AND AUTOMATIC PAPER TOWEL/ TOILET TISSUE DISPENSERS**



**MIRRORS**



**AUTOMATIC HAND DRYERS**



**204623**  
**ROVAL™ RECESSED PAPER TOWEL DISPENSER AND  
 REMOVABLE WASTE RECEPTACLE**

Dispenses 350 C-fold, 475 multi-fold paper towels. 3.0 gal. (11.2 L) removable stainless steel waste receptacle with a tumbler lock. 22 gauge stainless steel door in a satin finish with a flush lock and a heavy-duty  $\frac{3}{16}$ " staked piano hinge on door.

**MODEL OPTION:**  
**204623-9** Surface mounted with a stainless steel collar.

**Unit Size:**  
 $12\frac{3}{4}$ " x 28" x  $6\frac{1}{2}$ "  
 (325 x 710 x 165 mm)

**Wall Opening:**  
 $11\frac{1}{4}$ " x  $26\frac{1}{16}$ " x  $3\frac{15}{16}$ "  
 (286 x 672 x 100 mm)



**20469**  
**ROVAL™ RECESSED PAPER TOWEL DISPENSER  
 AND WASTE RECEPTACLE**

Dispenses 600 C-fold or 800 multi-fold paper towels. 14.8 gal. (56 L) removable waste receptacle. Door made of 18 gauge stainless steel with a heavy-duty  $\frac{3}{16}$ " staked piano hinge.

**MODEL OPTION:**  
**20469-9** Surface mounted with a stainless steel collar.

**Unit Size:**  
 $17\frac{3}{8}$ " x  $56\frac{1}{16}$ " x 9"  
 (441 x 1424 x 228 mm)

**Wall Opening:**  
 $15\frac{5}{8}$ " x  $54\frac{3}{8}$ " x 4"  
 (397 x 1381 x 102 mm)





**204692A**

**ROVAL™ AUTOMATIC RECESSED ROLL PAPER TOWEL DISPENSER AND WASTE RECEPTACLE**

Fabricated of 18 gauge stainless steel. 17.8 gal. (67.2 L) removable waste receptacle. Towel length is determined by owner by setting length, delay, and paper saver switches.

**SUFFIX OPTIONS FOR POWER/MOUNTING:  
[A, A-6, A-9, AC, AC-6, AC-9]**

- A:** Powered by 4 D-size batteries (not included).
- AC:** Powered by AC plug-in adapter.
- 6:** Semi-recessed with a stainless steel collar.
- 9:** Surface mounted with a stainless steel collar.

**Unit Size:**  
17<sup>3</sup>/<sub>8</sub>" x 56<sup>1</sup>/<sub>16</sub>" x 11<sup>1</sup>/<sub>16</sub>"  
(441 x 1424 x 297 mm)

**Wall Opening:**  
15<sup>13</sup>/<sub>16</sub>" x 54<sup>11</sup>/<sub>16</sub>" x 10"  
(402 x 1389 x 254 mm)



**2046921A**

**ROVAL™ AUTOMATIC RECESSED ROLL PAPER TOWEL DISPENSER AND WASTE RECEPTACLE FOR ADA COMPLIANCE**

Smaller waste receptacle, 13.5 gal. (51.1 L), allows unit to be ADA compliant. Cabinet and frame fabricated of 22 gauge stainless steel. Internal shelf is ideal for paper towel storage. Towel length is determined by owner by setting length, delay, and paper saver switches.

**SUFFIX OPTIONS FOR POWER/MOUNTING:  
[A, A-6, A-9, AC, AC-6, AC-9]**

- A:** Powered by 4 D-size batteries (not included).
- AC:** Powered by AC plug-in adapter.
- 6:** Semi-recessed with a stainless steel collar.
- 9:** Surface mounted with a stainless steel collar.

**Unit Size:**  
17<sup>3</sup>/<sub>8</sub>" x 56<sup>1</sup>/<sub>16</sub>" x 11<sup>1</sup>/<sub>16</sub>"  
(441 x 1424 x 296 mm)

**Wall Opening:**  
15<sup>13</sup>/<sub>16</sub>" x 54<sup>11</sup>/<sub>16</sub>" x 10"  
(402 x 1389 x 254 mm)



**20826**  
**ROVAL™ SURFACE MOUNTED WASTE RECEPTACLE**

Receptacle front and sides fabricated of 20 gauge stainless steel with satin finish. 12.8 gal. (48.4 L) waste capacity.

**MODEL OPTION:**

**20826-T** Closed top, spring-loaded door.  
 Capacity 12.8 gal. (48.4 L).

**Overall Dimensions:**

15<sup>1</sup>/<sub>8</sub>" x 23" x 8<sup>1</sup>/<sub>2</sub>"  
 (384 x 584 x 216 mm)



**20458**  
**ROVAL™ SEMI-RECESSED REMOVABLE WASTE RECEPTACLE**

Easy maintenance—removable 20 gauge stainless steel waste receptacle locks into cabinet with a tumbler lock for security. Capacity 11.2 gal. (42.6 L). Frame and cabinet fabricated of 22 gauge stainless steel with satin finish.

**Unit Size:**

17<sup>3</sup>/<sub>8</sub>" x 27<sup>3</sup>/<sub>4</sub>" x 8<sup>15</sup>/<sub>16</sub>"  
 (441 x 705 x 227 mm)

**Wall Opening:**

15<sup>3</sup>/<sub>4</sub>" x 26" x 3<sup>15</sup>/<sub>16</sub>"  
 (400 x 660 x 100 mm)



**20852**  
**ROVAL™ SURFACE MOUNTED SANITARY WASTE RECEPTACLE**

Lid is drawn one-piece construction and is secured to the cabinet with a heavy-duty <sup>9</sup>/<sub>16</sub>" multi-staked concealed piano hinge. Cabinet top and body fabricated of 22 gauge stainless steel. 1 gal. (3.7 L) waste capacity.

**Overall Dimensions:**

7<sup>1</sup>/<sub>4</sub>" x 10" x 3<sup>1</sup>/<sub>2</sub>"  
 (185 x 253 x 89 mm)



**20470**  
**ROVAL™ RECESSED SANITARY NAPKIN DISPOSAL**

Heavy-duty <sup>9</sup>/<sub>16</sub>" staked piano hinge adds to the robust construction. Drawn one-piece seamless door of 22 gauge stainless steel with a satin finish. 1.0 gal. (3.7 L) waste capacity.

**Unit Size:**

12<sup>13</sup>/<sub>16</sub>" x 11" x 5<sup>7</sup>/<sub>16</sub>"  
 (325 x 280 x 138 mm)

**Wall Opening:**

15<sup>3</sup>/<sub>4</sub>" x 26" x 3<sup>15</sup>/<sub>16</sub>"  
 (400 x 660 x 100 mm)



**204684**  
**ROVAL™ RECESSED DUAL SANITARY NAPKIN AND TAMPON VENDOR**

Dispenses 31 napkins and 22 tampons. Door has 18 gauge satin finish stainless steel, with 2 flush tumbler locks. Universal coin mechanism allows for 25¢, 50¢, and free (no coin) operation. Choose appropriate suffix (-25, -50 or -F).

**MODEL OPTION:**

**204684-9** Surface mounted with a stainless steel collar.

**Unit Size:**

17<sup>5</sup>/<sub>16</sub>" x 27<sup>3</sup>/<sub>4</sub>" x 5<sup>5</sup>/<sub>8</sub>" (440 x 705 x 143 mm)

**Wall Opening:**

15<sup>3</sup>/<sub>4</sub>" x 26<sup>1</sup>/<sub>8</sub>" x 4" (397 x 664 x 102 mm)



**20452**  
**ROVAL™ RECESSED PAPER TOWEL DISPENSER**

Dispenses 600 C-fold or 800 multi-fold paper towels. Door fabricated of 18 gauge drawn one-piece stainless steel with satin finish. Door secured with  $\frac{3}{16}$ " staked piano hinge and flush tumbler lock.

**Overall Dimensions:**  
12 $\frac{3}{4}$ " x 28" x 5 $\frac{1}{16}$ "  
(324 x 711 x 137 mm)



**204523A**  
**ROVAL™ AUTOMATIC RECESSED ROLL PAPER TOWEL DISPENSER**

Fabricated of 22 gauge stainless steel with satin finish. Towel length is determined by owner by setting length, delay, and paper saver switches.

**SUFFIX OPTIONS FOR POWER/MOUNTING:**  
[A, A-6, A-9, AC, AC-6, AC-9]

**A:** Powered by 4 D-size batteries (not included).

**AC:** Powered by AC plug-in adapter.

**-6:** Semi-recessed with a stainless steel collar.

**-9:** Surface mounted with a stainless steel collar.

**Unit Size:**  
17 $\frac{7}{8}$ " x 27 $\frac{3}{4}$ " x 11 $\frac{11}{16}$ "  
(441 x 705 x 297 mm)

**Wall Opening:**  
15 $\frac{3}{4}$ " x 26" x 10"  
(400 x 660 x 254 mm)



**20210**  
**ROVAL™ SURFACE MOUNTED PAPER TOWEL DISPENSER**

Dispenses 400 C-fold or 525 multi-fold paper towels. Fabricated of 22 gauge stainless steel with satin finish. Fitted with tumbler lock and heavy-duty stainless steel staked piano hinge.

**Overall Dimensions:**  
11 $\frac{1}{16}$ " x 13 $\frac{9}{16}$ " x 4 $\frac{7}{16}$ "  
(281 x 345 x 124 mm)



**20030**  
**ROVAL™ SURFACE MOUNTED TWIN HIDE-A-ROLL TOILET TISSUE DISPENSER**

Holds 2 rolls up to 5.25" (133 mm) diameter (double roll capacity 3600 sheets); top roll automatically drops in place when bottom roll is used up. Fabricated of 22 gauge satin finish stainless steel. Theft-resistant spindles with integral plated steel endpins.

**MODEL OPTION:**  
**20031** With flange for semi-recessed mounting.

**Overall Dimensions:**  
6 $\frac{1}{16}$ " x 12 $\frac{1}{8}$ " x 6 $\frac{1}{2}$ "  
(154 x 308 x 165 mm)



**20477-SM**  
**ROVAL™ SURFACE MOUNTED SEAT COVER DISPENSER**

Dispenses 250 seat covers. Fabricated of 20 gauge stainless steel with a satin finish.

**Overall Dimensions:**  
15 $\frac{3}{4}$ " x 11" x 2 $\frac{3}{8}$ "  
(400 x 280 x 60 mm)



**9013**  
**RECESSED STAINLESS STEEL BABY CHANGING STATION**

ADA-compliant unit features welded stainless steel for long and reliable use. Exposed surfaces are satin finish. Easy one-handed operation is assisted by a pull handle and concealed spring. The changing surface is fungus-, bacteria-, and high-impact-resistant plastic for easy cleaning. Its two-part adjustable safety strap and 400 lb. (181 kg) load capacity assure child protection.

**MODEL OPTION:**

**9013-9** Surface mounted with a stainless steel collar.

**Overall Dimensions:**

Open:	Closed:
37" x 25½" x 17¾"	37" x 25½" x ¾"
(940 x 648 x 451 mm)	(940 x 648 x 10 mm)

**Wall Opening:**

34¼" x 22¾" x 3¾"  
 (870 x 578 x 95 mm)



**9343**  
**HORIZONTAL SURFACE MOUNTED SOAP DISPENSER**

All-purpose valve dispenses liquid soaps with a capacity of 48 fl. oz. (1.4 L). It has a tamper-resistant sight gauge with concealed fastening and vandal-resistant hinged filler-top.

**MODEL OPTION:**

**NEW 9343-41** Matte Black.

**Overall Dimensions:**

7¼" x 6½" x 3¼"  
 (184 x 165 x 94 mm)

Spout Projection: ⅞" (24 mm)



**20365**  
**ROVAL™ AUTOMATIC SURFACE MOUNTED FOAM SOAP AND HAND SANITIZER DISPENSER**

Hands-free foam soap and hand sanitizer dispenser powered by 6 AA-size batteries (not included). Seamless drawn stainless steel cover. Translucent removable internal tank for easy-to-view level. LED indicates adjustment and operation. Capacity: 34 oz. (1 L).

**Overall Dimensions:**

5½" x 10¾" x 4"  
 (140 x 273 x 102 mm)



**20364**  
**ROVAL™ AUTOMATIC SURFACE MOUNTED LIQUID SOAP AND GEL HAND SANITIZER DISPENSER**

Hands-free liquid soap and gel hand sanitizer dispenser powered by 6 AA-size batteries (not included). Seamless drawn stainless steel cover. Translucent removable internal tank for easy-to-view level. LED indicates adjustment and operation. Capacity: 34 oz. (1 L). d.

**Overall Dimensions:**

5½" x 10⅞" x 4"  
 (140 x 276 x 102 mm)



**20363**  
**ROVAL™ SURFACE MOUNTED LIQUID SOAP DISPENSER**

Push button operation, valve needs no more than 5 lbs. of pressure to actuate. Dispenses liquid soap Capacity: 57 oz. (1.7 L).

**Overall Dimensions:**

5½" x 10⅞" x 4"  
 (139 x 274 x 102 mm)

Spout Projection: ⅞" (24 mm)



**20199**  
**ROVAL™ SEMI-RECESSED HIGH-SPEED HAND DRYER**

This high-performing hand dryer, with a drying time of 10-15 seconds, has a cover made of 18 gauge stainless steel and uniquely complements the Roval™ Collection with its bowed face and gently radiused edges. 5-year warranty. Optional voltages available.

**Unit Size:** 11" x 15½" x 5<sup>23</sup>/<sub>32</sub>"  
 (279 x 394 x 145 mm)  
**Wall Opening:** 10½" x 14<sup>5</sup>/<sub>8</sub>" x 3¼"  
 (267 x 371 x 83 mm)

**Decibel Level:** 69 dB-A @ 2M



**20200**  
**TRI-UmpH™ HIGH-SPEED HAND DRYER**

Satin look cover: ABS plastic with silver ions. Ergonomic—no need to bend over or bend knees. Air blows down and back from vents above. No water splash-back. Ultra hygienic—over 99% of airborne bacteria is eliminated with the removable Triple HEPA Filter System. 5-year warranty. Optional voltages available.

**Overall Dimensions:**  
 12<sup>1</sup>/<sub>16</sub>" x 23<sup>1</sup>/<sub>8</sub>" x 7<sup>3</sup>/<sub>4</sub>"  
 (322 x 588 x 196 mm)

**Decibel Level:** 62.9-67.2 dB-A @ 2M

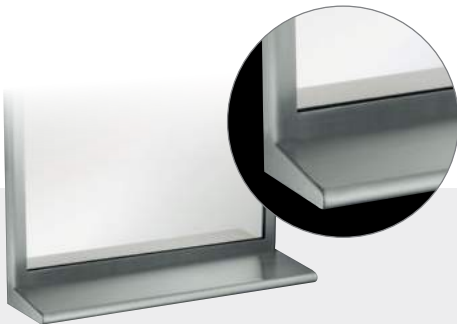

**20655**  
**ROVAL™ STAINLESS STEEL MIRROR WITH INTEGRAL SHELF**

The gently radiused edges provide added strength and complement the curves of the ASI Roval™ Collection. Mirror frame and 6" wide curved edge shelf are fabricated of 18 gauge stainless steel with satin finish. Mirror frame has polished seamless mitered corners and 0.25" (6.4 mm) thick plate glass mirror. Choice of sizes.

**MODEL OPTION:**  
**20650** Mirror without shelf.



**20692**  
**ROVAL™ SURFACE MOUNTED SHELF**

Fabricated of 18 gauge stainless steel, the 6" wide shelf has a ¾" (19 mm) gently radiused edge that uniquely complements the curves of the ASI Roval™ Collection. Choice of sizes.

**Overall Dimensions:**  
 6" x 12"-72"  
 (152 x 305-1829 mm)



SHOWN: 9469 PAPER TOWEL  
DISPENSER AND  
WASTE RECEPTACLE



# PROFILE™ COLLECTION

Manufactured with highly durable stainless steel doors and cabinets, this visually appealing collection with rounded edges stands the test of time.

Its concealed hinges ensure smooth and long-lived operation, and its locks offer strong security.

## WHAT MAKES THE PROFILE™ COLLECTION UNIQUE?

**16**  
GAUGE

### HEAVY-DUTY

Our 16 gauge stainless steel doors are attached to 20 gauge stainless steel cabinets with concealed  $\frac{3}{16}$ " (5 mm) diameter piano hinges to handle heavy use.

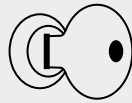

### RIMLESS TUMBLER LOCKS

Our rimless flush tumbler locks that are keyed alike provide convenience and security with an elegant look.



### ROUNDED CORNERS

All doors have vertical edges rounded to a  $\frac{3}{4}$ " (19 mm) radius with welded corners for strength and to ensure no sharp edges for safety.



### EASY LIFT OUT RECEPTACLE

Fully removable stainless steel waste cans allow contents to be easily discarded for efficient ongoing maintenance and cleanliness.



**MULTI-PURPOSE CABINETS**



**PAPER TOWEL DISPENSERS**



**WASTE RECEPTACLES**



**9469**

**PROFILE™ RECESSED PAPER TOWEL DISPENSER AND WASTE RECEPTACLE**

Dispenses 600 C-fold or 800 multi-fold paper towels. Door and 13 gal. (49 L) waste receptacle fabricated of 16 gauge stainless steel.

**Unit Size:**

17¼" x 56" x 5⅜"  
(438 x 1422 x 132 mm)

**Wall Opening:**

15¾" x 54½" x 4"  
(400 x 1384 x 102 mm)



**9462**

**PROFILE™ RECESSED PAPER TOWEL DISPENSER AND WASTE RECEPTACLE**

Dispenses 600 C-fold, 800 multi-fold, or 1100 single-fold paper towels. 16 gauge stainless steel door. 9 gal. (34 L) stainless steel waste receptacle.

**Unit Size:**

17¼" x 54" x 6⅝"  
(438 x 1372 x 176 mm)

**Wall Opening:**

15¾" x 52½" x 6"  
(400 x 1334 x 152 mm)



**9467**  
**PROFILE™ RECESSED PAPER TOWEL DISPENSER AND WASTE RECEPTACLE**

Dispenses 600 C-fold or 800 multi-fold paper towels. 4.5 gal. (17 L) stainless steel waste receptacle. 16 gauge stainless steel door.

**MODEL OPTIONS:**

**94676** dispenses 600 C-fold, 800 multi-fold, or 1100 single-fold towels and has push door. 8 gal. (30 L) waste capacity.

**9467**

**Unit Size:**  
 13" x 55" x 5<sup>3</sup>/<sub>16</sub>"  
 (330 x 1397 x 132 mm)

**Wall Opening:**  
 11<sup>1</sup>/<sub>2</sub>" x 53<sup>1</sup>/<sub>2</sub>" x 4<sup>1</sup>/<sub>4</sub>"  
 (292 x 1359 x 108 mm)

**94676**

**Unit Size:**  
 13" x 55" x 7<sup>3</sup>/<sub>16</sub>"  
 (330 x 1397 x 183 mm)

**Wall Opening:**  
 11<sup>1</sup>/<sub>2</sub>" x 53<sup>1</sup>/<sub>2</sub>" x 6<sup>1</sup>/<sub>4</sub>"  
 (292 x 1359 x 159 mm)



**94696A**  
**PROFILE™ AUTOMATIC RECESSED ROLL PAPER TOWEL DISPENSER AND WASTE RECEPTACLE**

Proximity sensing no-touch unit dispenses a pre-set length per cycle from 8" or 9" (205 or 230 mm) wide, 800 ft. (244 m) long rolls. 16 gauge stainless steel door. 10 gal. (37.8 L) stainless steel waste receptacle.

**SUFFIX OPTIONS FOR POWER/MOUNTING:**  
**[A]**

**A:** Powered by 4 D-size batteries (not included).  
**94696:** Mechanical lever dispenser.

**Unit Size:**  
 16<sup>1</sup>/<sub>16</sub>" x 41<sup>1</sup>/<sub>4</sub>" x 10<sup>11</sup>/<sub>16</sub>"  
 (408 x 1048 x 272 mm)

**Wall Opening:**  
 14<sup>5</sup>/<sub>8</sub>" x 39<sup>3</sup>/<sub>4</sub>" x 10"  
 (371 x 1010 x 254 mm)



**94623**  
**PROFILE™ RECESSED PAPER TOWEL DISPENSER AND WASTE RECEPTACLE**

Dispenses 350 C-fold or 475 multi-fold paper towels and has a built-in 2 gal. (7.6 L) stainless steel waste receptacle. 16 gauge stainless steel door.

**Unit Size:**  
14<sup>1</sup>/<sub>4</sub>" x 28" x 4<sup>15</sup>/<sub>16</sub>"  
(362 x 711 x 125 mm)

**Wall Opening:**  
12<sup>3</sup>/<sub>4</sub>" x 26<sup>1</sup>/<sub>2</sub>" x 4<sup>1</sup>/<sub>4</sub>"  
(324 x 673 x 108 mm)



**9452**  
**PROFILE™ RECESSED PAPER TOWEL DISPENSER**

Dispenses 600 C-fold or 800 multi-fold paper towels. 16 gauge stainless steel door.

**Unit Size:**  
14<sup>1</sup>/<sub>4</sub>" x 28" x 4<sup>15</sup>/<sub>16</sub>"  
(362 x 711 x 125 mm)

**Wall Opening:**  
12<sup>3</sup>/<sub>4</sub>" x 26<sup>1</sup>/<sub>2</sub>" x 4<sup>1</sup>/<sub>4</sub>"  
(324 x 673 x 108 mm)



**9457**  
**PROFILE™ RECESSED PAPER TOWEL DISPENSER**

Dispenses 350 C-fold or 475 multi-fold paper towels. 16 gauge stainless steel door.

**Unit Size:**  
12<sup>3</sup>/<sub>4</sub>" x 17<sup>1</sup>/<sub>4</sub>" x 4<sup>15</sup>/<sub>16</sub>"  
(324 x 438 x 125 mm)

**Wall Opening:**  
11<sup>1</sup>/<sub>4</sub>" x 15<sup>3</sup>/<sub>4</sub>" x 4<sup>1</sup>/<sub>4</sub>"  
(286 x 400 x 108 mm)



**9459**  
**PROFILE™ RECESSED WASTE RECEPTACLE**

Stainless steel waste receptacle holds 4 gal. (15 L) of waste and has a self-closing panel that covers its opening. 16 gauge stainless steel door.

**Unit Size:**  
14<sup>1</sup>/<sub>4</sub>" x 28" x 4<sup>15</sup>/<sub>16</sub>"  
(362 x 711 x 125 mm)

**Wall Opening:**  
12<sup>3</sup>/<sub>4</sub>" x 26<sup>1</sup>/<sub>2</sub>" x 4<sup>1</sup>/<sub>4</sub>"  
(324 x 673 x 108 mm)



**9474**  
**PROFILE™ RECESSED WASTE RECEPTACLE**

Stainless steel waste receptacle holds 12 gal. (45.4 L) of washroom waste materials. 16 gauge stainless steel door.

**Unit Size:**  
17<sup>1</sup>/<sub>4</sub>" x 40" x 7<sup>3</sup>/<sub>16</sub>"  
(438 x 1016 x 183 mm)

**Wall Opening:**  
15<sup>3</sup>/<sub>4</sub>" x 38<sup>1</sup>/<sub>2</sub>" x 6<sup>1</sup>/<sub>4</sub>"  
(400 x 978 x 159 mm)



**9468**  
**PROFILE™ RECESSED DUAL NAPKIN/TAMPON VENDOR**

Dispenses 30 feminine napkins and 27 tampons using 25¢, 50¢, or free operation. Its door has 2 tumbler locks. Its inside coin box has a separately keyed lock. 16 gauge stainless steel door.

**MODEL OPTION:**  
**94684** designed for 4" (102 mm) wall opening; dispenses 15 napkins and 23 tampons.

**Unit Size:**  
17<sup>1</sup>/<sub>4</sub>" x 27<sup>1</sup>/<sub>4</sub>" x 6<sup>15</sup>/<sub>16</sub>"  
(438 x 692 x 176 mm)

**Wall Opening:**  
16" x 26" x 6<sup>1</sup>/<sub>4</sub>"  
(406 x 660 x 159 mm)





**9471**  
**PROFILE™ RECESSED SANITARY NAPKIN DISPOSAL**

Stainless steel unit features a self-closing push door that covers the disposal opening along with a removable 1.8 gal. (7 L) waste receptacle and 16 gauge stainless steel door.

**Unit Size:**  
10<sup>5</sup>/<sub>16</sub>" x 19<sup>5</sup>/<sub>16</sub>" x 4<sup>15</sup>/<sub>16</sub>"  
(270 x 498 x 125 mm)

**Wall Opening:**  
9<sup>1</sup>/<sub>8</sub>" x 18<sup>1</sup>/<sub>8</sub>" x 4<sup>1</sup>/<sub>4</sub>"  
(232 x 460 x 108 mm)



**9326**  
**PROFILE™ RECESSED LIQUID SOAP DISPENSER**

Dispenser has a covered stainless steel soap tank attached to the door, which hinges out for easy filling and cleaning. Its all-purpose valve dispenses liquid soap, with a capacity of 52 fl. oz. (1.5 L).

**Unit Size:**  
10<sup>1</sup>/<sub>4</sub>" x 6" x 7<sup>3</sup>/<sub>16</sub>"  
(260 x 152 x 183 mm)

**Wall Opening:**  
9" x 4<sup>7</sup>/<sub>8</sub>" x 4<sup>1</sup>/<sub>4</sub>"  
(229 x 124 x 108 mm)

Spout Projection: 2<sup>1</sup>/<sub>4</sub>" (57 mm)



**9343**  
**PROFILE™ SURFACE MOUNTED SOAP DISPENSER**

All-purpose valve dispenses liquid soap, with a capacity of 48 fl. oz. (1.4 L). It has a tamper-resistant sight gauge with concealed fastening and vandal-resistant hinged filler-top.

**MODEL OPTION:**  
**NEW 9343-41** Matte Black.

**Overall Dimensions:**  
7<sup>1</sup>/<sub>4</sub>" x 6<sup>1</sup>/<sub>2</sub>" x 3<sup>1</sup>/<sub>16</sub>"  
(184 x 165 x 94 mm)

Spout Projection: 1<sup>5</sup>/<sub>16</sub>" (24 mm)



**9477**  
**PROFILE™ RECESSED TOILET SEAT COVER DISPENSER**

Dispenses 500 seat covers. Fabricated of 16 gauge stainless steel.

**MODEL OPTION:**  
**9477-SM** Surface mounted. Dispenses 250 seat covers.

**Overall Dimensions:**  
17<sup>1</sup>/<sub>4</sub>" x 12<sup>3</sup>/<sub>4</sub>" x 3<sup>5</sup>/<sub>16</sub>"  
(438 x 324 x 84 mm)

**Wall Opening:**  
15<sup>3</sup>/<sub>4</sub>" x 11<sup>1</sup>/<sub>2</sub>" x 2<sup>1</sup>/<sub>2</sub>"  
(400 x 292 x 64 mm)



**9030**  
**PROFILE™ SURFACE MOUNTED DUAL ROLL TOILET TISSUE DISPENSER**

Stainless steel cabinet with mechanism for theft-resistant spindles holds 2 rolls up to 5<sup>1</sup>/<sub>4</sub>" (135 mm) diameter (1800 sheets); the top roll automatically drops in place when the bottom roll is used up.

**Overall Dimensions:**  
6" x 12" x 6<sup>1</sup>/<sub>4</sub>"  
(152 x 305 x 159 mm)



**9031**  
**PROFILE™ RECESSED DUAL ROLL TOILET TISSUE DISPENSER**

Stainless steel cabinet with mechanism for theft-resistant spindles holds 2 rolls up to 5<sup>1</sup>/<sub>4</sub>" (135 mm) diameter (1800 sheets); the top roll automatically drops in place when the bottom roll is used up.

**Unit Size:**  
8" x 14" x 6<sup>1</sup>/<sub>4</sub>"  
(203 x 356 x 159 mm)  
with flange for recessing

**Wall Opening:**  
6<sup>1</sup>/<sub>4</sub>" x 12<sup>1</sup>/<sub>4</sub>" x 3<sup>5</sup>/<sub>16</sub>"  
(159 x 311 x 86 mm)

SHOWN: 6467 PAPER TOWEL  
DISPENSER AND  
WASTE RECEPTACLE



# SIMPLICITY™ COLLECTION

Combining seamless construction and crisp design lines, this elegant collection provides strength, comfort, beauty, and durability.

All units have keyed-alike tumbler locks for ease in maintenance. Automatic dispensers feature a proximity sensor activated dispensing mechanism.

## WHAT MAKES THE SIMPLICITY™ COLLECTION UNIQUE?

18

GAUGE

### STAINLESS STEEL CONSTRUCTION

Constructed with 18 gauge stainless steel doors and 20 gauge cabinets, which are attached with concealed  $\frac{3}{16}$ " (5 mm) diameter piano hinges for durability.

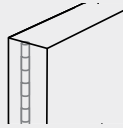

### SEAMLESS ONE-PIECE COVER-ALL DOOR

The door is designed for a sleek and streamlined appearance, making it easy to maintain even with heavy use.



### SAFE EASY DISPENSING

Towel dispensers have hemmed opening for safe, easy dispensing, minimizing waste and ensuring hygienic use.



### EASY LIFT OUT RECEPTACLE

Fully removable stainless steel waste cans allow contents to be easily discarded for efficient ongoing maintenance and cleanliness.



PAPER TOWEL DISPENSERS



FEMININE HYGIENE VENDORS



SOAP DISPENSERS



**6462**  
**SIMPLICITY™ RECESSED**  
**PAPER TOWEL DISPENSER AND**  
**WASTE RECEPTACLE**

Dispenses 800 multi-fold or 600 C-fold towels, standard. Provided adapter allows the flexibility to change the capacity to up to 1,100 single-fold paper towels. 9 gal. (34 L) stainless steel waste receptacle. 18 gauge stainless steel door.

**MODEL OPTIONS:**

- 6462-2** Semi-recessed with a stainless steel collar.
- 6462-9** Surface mounted with a stainless steel collar.

**Unit Size:**

17¼" x 54" x 6½"  
 (438 x 1372 x 165 mm)

**Wall Opening:**

15¾" x 52½" x 6"  
 (400 x 1335 x 152 mm)

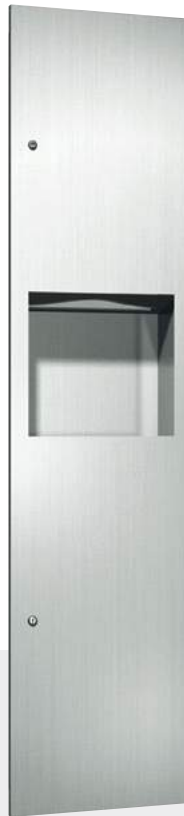

**6467**  
**SIMPLICITY™ RECESSED**  
**PAPER TOWEL DISPENSER AND**  
**WASTE RECEPTACLE**

Dispenses 600 C-fold or 800 multi-fold paper towels. 4.24 gal. (16 L) stainless steel waste receptacle. 18 gauge stainless steel door.

**MODEL OPTIONS:**

- NEW 6467-41PC** Matte Black
- 6467-9** Surface mounted with a stainless steel collar.
- NEW 6467-9-41PC** Surface mounted with a matte black stainless steel collar.

**Unit Size:**

13" x 55" x 4¾"  
 (330 x 1397 x 121 mm)

**Wall Opening:**

11½" x 53½" x 4"  
 (292 x 1359 x 102 mm)

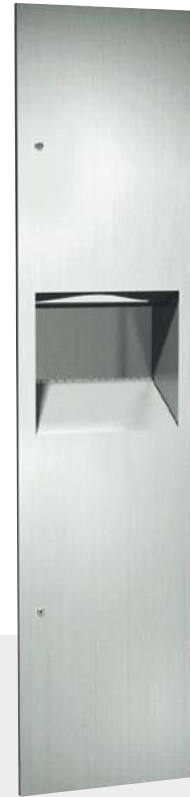

**64676**  
**SIMPLICITY™ RECESSED**  
**PAPER TOWEL DISPENSER AND**  
**WASTE RECEPTACLE**

Dispenses 600 C-Fold, 800 multi-fold, or 1100 single-fold towels. 7 gal. (26.5 L) stainless steel waste receptacle. 18 gauge stainless steel door.

**MODEL OPTIONS:**

- 64676-2** Semi-recessed with a stainless steel collar.
- 64676-9** Surface mounted with a stainless steel collar.

**Unit Size:**

13" x 55" x 6½"  
 (330 x 1397 x 165 mm)

**Wall Opening:**

11½" x 53½" x 6"  
 (292 x 1359 x 152 mm)



**NEW**



**646924A**  
**SIMPLICITY™ AUTOMATIC RECESSED ROLL PAPER TOWEL DISPENSER AND WASTE RECEPTACLE**

Proximity sensing no-touch recessed unit dispenses a pre-set length per cycle from 8" or 9" (205 or 230 mm) wide, 800 ft. (244 mm) long rolls. 12 gal. (45.4 L) waste receptacle. Fabricated of 22 gauge stainless steel, 18 gauge door.

**SUFFIX OPTIONS FOR POWER/MOUNTING:**  
**[A, A-9, AC, AC-9]**

**A:** Powered by 4 D-size batteries (not included).  
**AC:** Powered by AC plug-in adapter.  
**-9:** Surface mounted with a stainless steel collar.

<b>Unit Size:</b> 17¼" x 56" x 10¼" (438 x 1422 x 260 mm)	<b>Wall Opening:</b> 15¾" x 54½" x 4" (400 x 1384 x 102 mm)
---	---



**64672-1**  
**SIMPLICITY™ RECESSED 3-IN-1 PAPER TOWEL DISPENSER, HIGH-SPEED HAND DRYER AND WASTE RECEPTACLE**

Paper towel dispenser with waste receptacle and < 15 second automatic hand dryer. Dispenses 500 multi-fold or 400 C-fold paper towels, and has a waste capacity of 6.8 gal. (26 L). 18 gauge stainless steel door. Dryer has 5-year warranty. 110-120 V. Optional voltages available.

**MODEL OPTIONS:**  
**64672-2** Dryer Voltage is 208-240 V Dryer.  
**64672** Cabinet only—no hand dryer included.  
**NEW 64672-41PC** Cabinet Only—Matte Black.

<b>Unit Size:</b> 15⅝" x 55⅜" x 7½" (391 x 1407 x 191 mm)	<b>Wall Opening:</b> 14⅜" x 54⅜" x 7¼" (358 x 1381 x 184 mm)
---	--

**Decibel Level:** 68.9-74.3 dB-A @ 2M







**0198-MH**  
**SAFE-DRI™ MENTAL HEALTH**  
**APPROVED RECESSED**  
**HIGH-SPEED HAND DRYER**

Anti-ligature dryer designed for Behavioral Health environments—angled top, welded corners and single tube exhaust prevent looping, tying off, wedging, and prying. Tamper-resistant 18 gauge stainless steel cover and flush pin-hex security screws. Optional voltages available.

**Unit Size:**  
 12<sup>5</sup>/<sub>8</sub>" x 15<sup>3</sup>/<sub>4</sub>" x 5<sup>1</sup>/<sub>16</sub>"  
 (320 x 400 x 140 mm)

**Wall Opening:**  
 11<sup>7</sup>/<sub>8</sub>" x 14<sup>3</sup>/<sub>4</sub>" x 5<sup>1</sup>/<sub>8</sub>"  
 (303 x 376 x 130 mm)

**Decibel Level:**  
 66 dB-A @ 2M



**0135**  
**TURBO-TUFF RECESSED HIGH-**  
**SPEED HAND DRYER**

Fast drying, <15 seconds, operates automatically using infrared sensor with auto-resetting thermostat. Owner-adjustable air speed and temperature and on/off heating options. Dryer automatically shuts off after time-out when user removes hands from sensor zone. Optional voltages available.

**Unit Size:**  
 12<sup>19</sup>/<sub>32</sub>" x 15<sup>3</sup>/<sub>4</sub>" x 4<sup>1</sup>/<sub>16</sub>"  
 (320 x 400 x 103 mm)

**Wall Opening:**  
 12<sup>5</sup>/<sub>16</sub>" x 15<sup>3</sup>/<sub>16</sub>" x 3<sup>7</sup>/<sub>8</sub>"  
 (313 x 386 x 98 mm)

**Decibel Level:**  
 68.9-74.3 dB-A @ 2M



**64623**  
**SIMPLICITY™ RECESSED PAPER**  
**TOWEL DISPENSER AND WASTE**  
**RECEPTACLE**

Dispenses 350 C-fold or 475 multi-fold paper towels. 2.2 gal. (8.4 L) stainless steel waste receptacle. 18 gauge stainless steel door.

**MODEL OPTIONS:**  
**NEW 64623-41PC** Matte Black.  
**64623-9** Surface mounted with a stainless steel collar.  
**NEW 64623-9-41PC** Surface mounted with a matte black stainless steel collar.

**Unit Size:**  
 14<sup>1</sup>/<sub>4</sub>" x 28" x 4<sup>3</sup>/<sub>4</sub>"  
 (362 x 711 x 121 mm)

**Wall Opening:**  
 12<sup>3</sup>/<sub>4</sub>" x 26<sup>1</sup>/<sub>2</sub>" x 4<sup>1</sup>/<sub>4</sub>"  
 (324 x 673 x 108 mm)



**645210A**  
**SIMPLICITY™ AUTOMATIC RECESSED ROLL PAPER TOWEL DISPENSER**

Proximity sensing no-touch recessed unit dispenses an owner-adjustable length per cycle from 8" (205 mm) wide, 800 ft. (244 m) long rolls. Fabricated of 20 gauge stainless steel with satin finish.

**SUFFIX OPTIONS FOR POWER/MOUNTING:**  
**[A, A-6, A-9, AC, AC-6, AC-9]**

- A:** Powered by 4 D-size batteries (not included).
- AC:** Powered by AC plug-in adapter.
- 6:** Semi-recessed with a stainless steel collar.
- 9:** Surface mounted with a stainless steel collar.

**Unit Size:**  
 16<sup>5</sup>/<sub>16</sub>" x 28" x 9"  
 (408 x 711 x 229 mm)

**Wall Opening:**  
 15<sup>3</sup>/<sub>4</sub>" x 26<sup>1</sup>/<sub>2</sub>" x 10<sup>1</sup>/<sub>4</sub>"  
 (400 x 673 x 260 mm)



**64696**  
**SIMPLICITY™ RECESSED ROLL PAPER TOWEL DISPENSER AND WASTE RECEPTACLE**

Mechanically dispenses 8" or 9" (205 or 230 mm) wide, 800 ft. (244 m) long rolls in pre-set lengths per stroke. 9.2 gal. (34.8 L) stainless steel waste receptacle. 18 gauge stainless steel door.

**MODEL OPTIONS:**  
**64696-6** Semi-recessed with a stainless steel collar.  
**64696-9** Surface mounted with a stainless steel collar.

**Unit Size:**  
 16<sup>1</sup>/<sub>16</sub>" x 41<sup>1</sup>/<sub>4</sub>" x 9<sup>5</sup>/<sub>8</sub>"  
 (408 x 1048 x 245 mm)

**Wall Opening:**  
 14<sup>5</sup>/<sub>8</sub>" x 39<sup>3</sup>/<sub>4</sub>" x 9<sup>1</sup>/<sub>4</sub>"  
 (371 x 1010 x 235 mm)



**64696A**  
**SIMPLICITY™ AUTOMATIC RECESSED ROLL PAPER TOWEL DISPENSER AND WASTE RECEPTACLE**

Proximity sensing no-touch unit dispenses a pre-set length per cycle from 8" or 9" (205 or 230 mm) wide, 800 ft. (244 m) long rolls. 9.9 gal. (37.3 L) stainless steel waste receptacle. 18 gauge stainless steel door.

**SUFFIX OPTIONS FOR POWER/MOUNTING:**  
**[A, A-6, A-9, AC, AC-6, AC-9]**

- A:** Powered by 4 D-size batteries (not included).
- AC:** Powered by AC plug-in adapter.
- 6:** Semi-recessed with a stainless steel collar.
- 9:** Surface mounted with a stainless steel collar.

**Unit Size:**  
 16<sup>1</sup>/<sub>16</sub>" x 41<sup>1</sup>/<sub>4</sub>" x 10<sup>1</sup>/<sub>4</sub>"  
 (408 x 1048 x 261 mm)

**Wall Opening:**  
 14<sup>5</sup>/<sub>8</sub>" x 39<sup>3</sup>/<sub>4</sub>" x 10"  
 (371 x 1010 x 254 mm)



**6457**  
**SIMPLICITY™ RECESSED PAPER TOWEL DISPENSER**

Well-suited for the smaller washroom with less space and traffic, this unit dispenses 350 C-fold or 475 multi-fold paper towels. 18 gauge stainless steel door.

**Unit Size:**  
 12¾" x 17¼" x 4½"  
 (324 x 438 x 114 mm)

**Wall Opening:**  
 11¼" x 15¾" x 4¼"  
 (286 x 400 x 108 mm)



**6452**  
**SIMPLICITY™ RECESSED PAPER TOWEL DISPENSER**

Dispenses 600 C-fold or 800 multi-fold paper towels. 18 gauge stainless steel door.

**MODEL OPTION:**  
**6452-9** Surface mounted with a stainless steel collar.

**Unit Size:**  
 14¼" x 28" x 4½"  
 (362 x 711 x 114 mm)

**Wall Opening:**  
 12¾" x 26½" x 4¼"  
 (324 x 673 x 108 mm)



**645224AC**  
**SIMPLICITY™ AUTOMATIC RECESSED ROLL PAPER TOWEL DISPENSER**

Dispenses pre-set length from 8" or 9" wide rolls. Fabricated of 22 gauge stainless steel, 18 gauge door.

**SUFFIX OPTIONS FOR POWER/ MOUNTING:** [A, A-6, AC, AC-6, AC-9]

**AC:** Powered by AC plug-in adapter.

**-6:** Semi-recessed with a stainless steel collar.

**-9:** Surface mounted with a stainless steel collar.

**645224:** Mechanical lever dispenser.

<b>Unit Size:</b> 17¼" x 30½" x 10¼" (438 x 775 x 260 mm)	<b>Wall Opening:</b> 15¾" x 29" x 4" (400 x 737 x 102 mm)
---	---



**6459**  
**SIMPLICITY™ RECESSED WASTE RECEPTACLE**

Stainless steel waste receptacle holds 4 gal. (15 L) of waste and has a self-closing panel that covers its opening. 18 gauge stainless steel door.

**Unit Size:**  
 14¼" x 28" x 4½"  
 (362 x 711 x 114 mm)

**Wall Opening:**  
 12¾" x 26½" x 4¼"  
 (324 x 673 x 108 mm)



**6474**  
**SIMPLICITY™ RECESSED WASTE RECEPTACLE**

Stainless steel waste receptacle holds 12 gal. (46 L) of washroom waste materials. 18 gauge stainless steel door.

**MODEL OPTIONS:**

**NEW 6474-41PC** Matte Black.

**6474-2** Semi-recessed with a stainless steel collar.

**NEW 6474-2-41PC** Matte Black.

**Unit Size:**  
 17¼" x 40" x 6¾"  
 (438 x 1016 x 171 mm)

**Wall Opening:**  
 15¾" x 38½" x 6¼"  
 (400 x 978 x 159 mm)



**6468**  
**SIMPLICITY™ RECESSED DUAL NAPKIN/  
 TAMPON VENDOR**

Dispenses 30 feminine napkins and 27 tampons. Universal coin mechanism allows for 25¢, 50¢, and free (no coin) operation. Choose appropriate suffix (-25, -50, or -F). Door has 2 tumbler locks, inside coin box has a separately keyed lock.

**MODEL OPTION:**  
**64684** designed for 4" (102 mm) wall opening; dispenses 15 napkins and 23 tampons.

**Unit Size:**  
 17¼" x 27¼" x 6½"  
 (438 x 692 x 165 mm)

**Wall Opening:**  
 16" x 26" x 6¼"  
 (406 x 660 x 159 mm)



**68523A-4**  
**SIMPLICITY™ AUTOMATIC SEMI-RECESSED ROLL PAPER  
 TOWEL DISPENSER**

Proximity sensing no-touch unit dispenses a pre-set length per cycle from 8" standard towel roll up to 800 ft. (244 m) long and has stub roll capability for continuous dispensing.

**MODEL OPTION:**  
**68523A** battery operated, surface mounted.  
**68523AC** roll towel dispenser, 110-240 VAC, surface mounted.  
**68523AC-4** roll towel dispenser, 110-240 VAC, semi-recessed.

**Unit Size:**  
 17⅞" x 20⅜" x 9½"  
 (440 x 518 x 241 mm)

**Wall Opening:**  
 15⅝" x 19" x 4"  
 (391 x 483 x 102 mm)

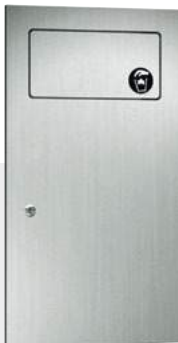

**6471**  
**SIMPLICITY™ RECESSED  
 SANITARY NAPKIN DISPOSAL**

Features a self-closing stainless steel push door that covers the disposal opening along with a removable 1.9 gal. (7.2 L) stainless steel waste receptacle. 18 gauge stainless steel door.

**Unit Size:**  
 10⅝" x 19⅝" x 4½"  
 (270 x 498 x 114 mm)

**Wall Opening:**  
 9⅞" x 18⅞" x 4"  
 (232 x 460 x 102 mm)

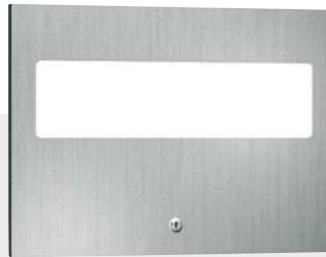

**6477**  
**SIMPLICITY™ RECESSED TOILET  
 SEAT COVER DISPENSER**

Dispenses 500 seat covers. 18 gauge stainless steel door.

**Unit Size:**  
 17¼" x 12¾" x 2⅞"  
 (438 x 324 x 73 mm)

**Wall Opening:**  
 15¾" x 11½" x 2⅞"  
 (400 x 292 x 60 mm)

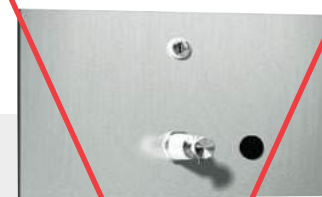

**6326**  
**SIMPLICITY™ RECESSED LIQUID  
 SOAP DISPENSER**

Dispenser has a covered stainless steel soap tank attached to the door, which hinges out for easy filling and cleaning. Its all purpose valve dispenses liquid soap, with a capacity of 47 fl. oz. (1.4 L).

**Unit Size:**  
 10¼" x 5" x 4⅞"  
 (260 x 152 x 105 mm)

**Wall Opening:**  
 9" x 4⅞" x 4"  
 (229 x 124 x 102 mm)

**Spout Projection:** 2½" (64 mm)

SHOWN: 0469 PAPER TOWEL  
DISPENSER AND  
WASTE RECEPTACLE





# TRADITIONAL™ COLLECTION

This time-honored collection provides exceptional value, offering a broad array of items for well-equipped washrooms. Double-pan doors incorporate a “no-flex” structural fiberboard core. Combining seamless construction and crisp design

lines, this elegant collection provides strength, comfort, beauty, and durability. All units have keyed-alike tumbler locks for ease in maintenance. Automatic dispensers feature a proximity sensor activated dispensing mechanism.

## WHAT MAKES THE TRADITIONAL™ COLLECTION UNIQUE?

22

GAUGE

### STAINLESS STEEL CONSTRUCTION

Fabricated with 22 gauge stainless steel with face trim, the recessed cabinet features one-piece construction with no miters or welding for durability.

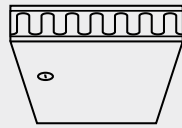

### DOUBLE-PAN DOORS

The double-pan doors incorporate a “no-flex” structural fiberboard core, adding strength and endurance for long-term use.



### SAFE EASY DISPENSING

Towel dispensers have hemmed opening for safe, easy dispensing, minimizing waste, and ensuring hygienic use.



### EASY LIFT OUT RECEPTACLE

Fully removable stainless steel waste cans allow contents to be easily discarded for efficient ongoing maintenance and cleanliness.



**MULTI-PURPOSE CABINETS**



**PAPER TOWEL DISPENSERS**



**WASTE RECEPTACLES**



**0462-AD**

**TRADITIONAL™ RECESSED PAPER TOWEL DISPENSER AND WASTE RECEPTACLE**

Dispenses 350 C-fold or 475 multi-fold paper towels. 2 gal. (7.6 L) waste receptacle. Door and cabinet fabricated of 22 gauge stainless steel.

**MODEL OPTION:**

**0462-AD-9** Surface mounted with a stainless steel collar.

**Unit Size:**

14<sup>1</sup>/<sub>4</sub>" x 28" x 4<sup>1</sup>/<sub>4</sub>"  
(362 x 711 x 108 mm)

**Wall Opening:**

12<sup>3</sup>/<sub>4</sub>" x 26<sup>1</sup>/<sub>2</sub>" x 4"  
(324 x 673 x 102 mm)



**0469**

**TRADITIONAL™ RECESSED PAPER TOWEL DISPENSER AND WASTE RECEPTACLE**

Dispenses 600 C-fold or 800 multi-fold paper towels. 12 gal. (46 L) stainless steel waste receptacle. Fabricated of 22 gauge stainless steel.

**MODEL OPTIONS:**

**0469-2** Semi-recessed with a stainless steel collar.

**0469-9** Surface mounted with a stainless steel collar.

**0469-BL** 18 gal. (68 L) waste receptacle. Projects 8" (205 mm) from wall.

**Unit Size:**

17<sup>1</sup>/<sub>4</sub>" x 56" x 4<sup>1</sup>/<sub>4</sub>"  
(438 x 1422 x 108 mm)

**Wall Opening:**

15<sup>3</sup>/<sub>4</sub>" x 54<sup>1</sup>/<sub>2</sub>" x 4"  
(400 x 1384 x 102 mm)



**04697**

**TRADITIONAL™ RECESSED PAPER TOWEL DISPENSER AND WASTE RECEPTACLE**

Dispenses 600 C-fold, 800 multi-fold, or 1100 single-fold paper towels. 12 gal. (46 L) stainless steel waste receptacle. Fabricated of 22 gauge stainless steel.

**MODEL OPTIONS:**

- 04697-4** Semi-recessed with a stainless steel collar.
- 04697-9** Surface mounted with a stainless steel collar.
- 04697-BL** 18 gal. (68 L) waste receptacle, projects 4" (102 mm) from wall.

**Unit Size:**

17¼" x 56" x 7¼"  
(438 x 1422 x 184 mm)

**Wall Opening:**

15¾" x 54½" x 7¼"  
(400 x 1384 x 184 mm)



**04692A**

**TRADITIONAL™ AUTOMATIC RECESSED ROLL PAPER TOWEL DISPENSER AND WASTE RECEPTACLE**

Proximity sensing no-touch unit dispenses a pre-set length per cycle from 8" or 9" (205 or 230 mm) wide, 800 ft. (244 m) long rolls. Fabricated of 22 gauge stainless steel, 18 gauge door.

**SUFFIX OPTIONS FOR POWER/MOUNTING:**

**[A, A-6, A-9, AC, AC-6, AC-9]**

**A:** Powered by 4 D-size batteries (not included).

**AC:** Powered by AC plug-in adapter.

**-6:** Semi-recessed with a stainless steel collar.

**-9:** Surface mounted with a stainless steel collar.

**04692:** Mechanical lever dispenser.

**Unit Size:**

17¼" x 56" x 10¼"  
(438 x 1422 x 260 mm)

**Wall Opening:**

15¾" x 54½" x 10"  
(400 x 1384 x 254 mm)

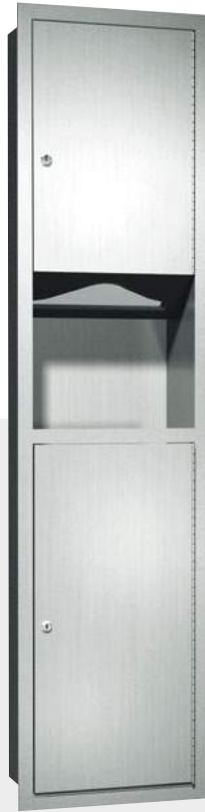

**0467**

**TRADITIONAL™ RECESSED PAPER TOWEL DISPENSER AND WASTE RECEPTACLE**

Dispenses 600 C-fold, 800 multi-fold, or 1100 single-fold paper towels. 7 gal. (26 L) stainless steel waste receptacle. Fabricated of 22 gauge stainless steel.

**MODEL OPTIONS:**

**0467-2** Semi-recessed with a stainless steel collar.  
**0467-9** Surface mounted with a stainless steel collar.

**Unit Size:**  
 13" x 55" x 6½"  
 (330 x 1397 x 165 mm)

**Wall Opening:**  
 11½" x 53½" x 6¼"  
 (292 x 1359 x 159 mm)



**046926**

**TRADITIONAL™ SEMI-RECESSED ROLL PAPER TOWEL DISPENSER AND WASTE RECEPTACLE**

Dispenses single full width cut towel 12" (305 mm) long from pull-towel autocut dispenser. With manual override feed wheel on the side of the cabinet. 13.5 gal. (52 L) waste receptacle. Door and back fabricated of 18 gauge stainless steel.

**Unit Size:**  
 17¼" x 56" x 9¼"  
 (438 x 1422 x 235 mm)

**Wall Opening:**  
 15¾" x 54½" x 4"  
 (400 x 1384 x 102 mm)



**046921A**

**TRADITIONAL™ AUTOMATIC RECESSED ROLL PAPER TOWEL DISPENSER AND WASTE RECEPTACLE**

Proximity sensing no-touch recessed unit dispenses a pre-set length per cycle from 8" or 9" (205 or 230 mm) wide, 800 ft. (244 m) long rolls. 12 gal. (45.4 L) waste receptacle. Fabricated of 22 gauge stainless steel, 18 gauge door.

**SUFFIX OPTIONS FOR POWER/MOUNTING:  
[A, A-6, A-9, AC, AC-6, AC-9]**

- A:** Powered by 4 D-size batteries (not included).
- AC:** Powered by AC plug-in adapter.
- 6:** Semi-recessed with a stainless steel collar.
- 9:** Surface mounted with a stainless steel collar.
- 046921:** Mechanical lever dispenser.

**Unit Size:**  
17¼" x 56" x 10¼"  
(438 x 1422 x 260 mm)

**Wall Opening:**  
15¾" x 54½" x 10¼"  
(400 x 1384 x 260 mm)



**046924**

**TRADITIONAL™ RECESSED ROLL PAPER TOWEL DISPENSER AND WASTE RECEPTACLE**

Unit mechanically dispenses 8" or 9" wide standard towel roll up to 800 ft. (244 m) long and has stub roll capability for continuous dispensing. 12 gal. (46 L) disposal capacity. A lever operated dispensing mechanism also supplied. Surface mounted with 9" stainless steel collar.

**MODEL OPTIONS:  
046924-9 Surface Mounted with a stainless steel collar.**

**Unit Size:**  
17¼" x 56" x 10¼"  
(438 x 1422 x 260 mm)

**Wall Opening:**  
15¾" x 54½" x 4"  
(400 x 1384 x 102 mm)



**0457**  
**TRADITIONAL™ RECESSED PAPER TOWEL DISPENSER**

Dispenses 350 C-fold or 500 multi-fold paper towels; well-suited for smaller washrooms with less space and traffic. Fabricated of 22 gauge stainless steel.

**MODEL OPTION:**  
**0457-9** Surface mounted with a stainless steel collar.

<b>Unit Size:</b> 12 <sup>3</sup> / <sub>4</sub> " x 17 <sup>1</sup> / <sub>4</sub> " x 4 <sup>1</sup> / <sub>4</sub> " (324 x 438 x 108 mm)	<b>Wall Opening:</b> 11 <sup>1</sup> / <sub>4</sub> " x 15 <sup>3</sup> / <sub>4</sub> " x 4" (286 x 400 x 102 mm)
---	---



**0452**  
**TRADITIONAL™ RECESSED PAPER TOWEL DISPENSER**

Dispenses 600 C-fold or 800 multi-fold paper towels. Fabricated of 22 gauge stainless steel.

**MODEL OPTION:**  
**0452-9** Surface mounted with a stainless steel collar.

<b>Unit Size:</b> 14 <sup>1</sup> / <sub>4</sub> " x 28" x 4 <sup>1</sup> / <sub>4</sub> " (326 x 711 x 108 mm)	<b>Wall Opening:</b> 12 <sup>3</sup> / <sub>4</sub> " x 26 <sup>1</sup> / <sub>2</sub> " x 4" (324 x 673 x 102 mm)
--	---



**045210A**  
**TRADITIONAL™ AUTOMATIC RECESSED ROLL PAPER TOWEL DISPENSER**

Dispenses pre-set length from 8" or 9" wide rolls. Fabricated of 22 gauge stainless steel, 18 gauge door.

**SUFFIX OPTIONS FOR POWER/MOUNTING:**  
**[A, A-6, A-9, AC, AC-6, AC-9]**

**A:** Powered by 4 D-size batteries (not included).

**AC:** Powered by AC plug-in adapter. -6: Semi-recessed with a stainless steel collar.

-9: Surface mounted with a stainless steel collar.

<b>Unit Size:</b> 17 <sup>1</sup> / <sub>4</sub> " x 28" x 10" (438 x 711 x 254 mm)	<b>Wall Opening:</b> 15 <sup>3</sup> / <sub>4</sub> " x 26 <sup>1</sup> / <sub>2</sub> " x 10 <sup>1</sup> / <sub>4</sub> " (400 x 673 x 260 mm)
--	---



**0458**  
**TRADITIONAL™ SEMI-RECESSED WASTE RECEPTACLE**

Stainless steel waste container locks into cabinet, removable for servicing. Fabricated of 22 gauge stainless steel.

**MODEL OPTION:**  
**0458-9** Surface mounted with a stainless steel collar.

<b>Unit Size:</b> 17 <sup>1</sup> / <sub>4</sub> " x 30 <sup>1</sup> / <sub>2</sub> " x 8 <sup>3</sup> / <sub>4</sub> " (438 x 775 x 210 mm)	<b>Wall Opening:</b> 15 <sup>3</sup> / <sub>4</sub> " x 29" x (variable*) (400 x 737 mm)
---	---

\*[0458 if 4" (102 mm) x 4" and 12 gals. (46 L); 0458-CX if 1/2" (13 mm) x 7<sup>1</sup>/<sub>2</sub>" (191 mm) and 12 gals. (46 L); 0458-DX if 8" (203 mm) x 4" (102 mm) and 18 gals. (68 L)]



**04733**  
**TRADITIONAL™ RECESSED WASTE RECEPTACLE**

Self-closing panel covers the receptacle opening, removable 3 gal. (11.4 L) stainless steel waste receptacle. Fabricated of 22 gauge stainless steel.

<b>Unit Size:</b> 14 <sup>1</sup> / <sub>4</sub> " x 28" x 4 <sup>1</sup> / <sub>2</sub> " (362 x 711 x 114 mm)	<b>Wall Opening:</b> 12 <sup>3</sup> / <sub>4</sub> " x 26 <sup>1</sup> / <sub>2</sub> " x 4" (324 x 673 x 102 mm)
--	---





**0210**  
**TRADITIONAL™ SURFACE MOUNTED PAPER TOWEL DISPENSER**

Fabricated of 22 gauge stainless steel, this unit dispenses 400 C-fold or 525 multi-fold paper towels without adjustment or adapters and is fitted with tumbler lock and heavy-duty stainless steel piano hinge.

**MODEL OPTION:**  
**NEW 0210-41** Matte Black.

**Overall Dimensions:**  
 11½" x 14⅝" x 4"  
 (282 x 371 x 101 mm)



**0215**  
**TRADITIONAL™ SURFACE MOUNTED PAPER TOWEL DISPENSER – PETITE**

Dispenses 200 C-fold or 275 multi-fold paper towels; well-suited for low-traffic areas. Fabricated of 22 gauge stainless steel.

**Overall Dimensions:**  
 11" x 8" x 4"  
 (279 x 203 x 102 mm)



**0439**  
**TRADITIONAL™ RECESSED PAPER TOWEL DISPENSER**

This cabinet has 2 push-up flaps for bottom-filling with towels and dispenses 600 C-fold or 800 multi-fold paper towels; designed to conceal the dispenser behind mirror or wall so only the towel tray opening is visible. Fabricated of 22 gauge stainless steel.

Note for Designers: Leave 6" min. (152 mm) clearance below towel tray opening for space to pull towels; units are installed before hanging mirror or applying finished wall.

**Overall Dimensions:**  
 11½" x 18" x 4½"  
 (292 x 457 x 108 mm)



**8522**  
**TRADITIONAL™ SURFACE MOUNTED ROLL PAPER TOWEL DISPENSER**

Mechanical unit dispenses a pre-set length per cycle from 8" or 9" (205 or 230 mm) wide, 800 ft. (244 m) long rolls. Fabricated of 22 gauge stainless steel, 18 gauge door. Product allows for modular retrofit into a variety of standard size cabinets.

**MODEL OPTIONS:**  
**8523A** Powered by 4 D-size batteries (not included).  
**8523AC** Powered by AC plug-in adapter.

**Overall Dimensions:**  
 14" x 16" x 9½"  
 (356 x 406 x 241 mm)



**8165**  
**TRADITIONAL™ SURFACE MOUNTED ROLL PAPER TOWEL DISPENSER**

Holds standard paper towel roll up to 6" (152 mm) diameter; heavy-duty aluminum casting with satin-matte, silver-grey finish. Designed for controlled delivery of towels, and its concealed locking device on molded plastic spindle prevents theft.

**Overall Dimensions:**  
 Unit measures 13" (330 mm) wide; projects 6" (152 mm) from wall.



**0245-SS**  
**TRADITIONAL™ SURFACE MOUNTED PAPER TOWEL DISPENSER**

Fabricated of 22 gauge stainless steel. This unit dispenses 400 single-fold paper towels.

**Overall Dimensions:**  
 11¼" x 6¼" x 5⅝"  
 (285 x 160 x 143 mm)



**0829**  
**TRADITIONAL™ CORNER WASTE RECEPTACLE**

Fabricated of 22 gauge stainless steel with hemmed top and bottom edges for safety; capacity of 16 gal. (60 L) of waste.

**Overall Dimensions:**  
15" x 23" x 14½"  
(381 x 584 x 368 mm)



**NEW**



**0834**  
**TRADITIONAL™ FREESTANDING WASTE RECEPTACLE**

Fabricated of 22 gauge stainless steel; holds 14 gallons (54 L) of waste. Top is removable for easy maintenance and bottom is equipped with four (4) non-skid rubber feet.

**MODEL OPTION:**  
**0839** has 19 gal. (72 L) capacity with 12¾" x 32" x 12½" (314 x 800 x 318 mm) dimensions.

**Overall Dimensions:**  
12¾" x 24" x 12½"  
(314 x 609 x 318 mm)



**NEW**



**0834-T**  
**TRADITIONAL™ FREESTANDING WASTE RECEPTACLE WITH DUAL SWING TOP**

Fabricated of 22 gauge stainless steel; holds 14 gallons (54 L) of waste. Top has dual swing door and is removable for easy maintenance. Bottom is equipped with four (4) non-skid rubber feet.

**MODEL OPTION:**  
**0839-T** has 19 gal. (72 L) capacity with 12¾" x 37¼" x 12½" (314 x 946 x 318 mm) dimensions.

**Overall Dimensions:**  
12¾" x 29¾" x 12½"  
(314 x 756 x 318 mm)



**0827**  
**TRADITIONAL™ SURFACE MOUNTED WASTE RECEPTACLE**

Fabricated of 22 gauge stainless steel with hemmed top and bottom edges for safety; capacity of 2 gal. (7.6 L) of waste.

**Overall Dimensions:**  
10½" x 9" x 4¾"  
(267 x 229 x 121 mm)



**0828**  
**TRADITIONAL™ SURFACE MOUNTED WASTE RECEPTACLE**

Fabricated of 22 gauge stainless steel with hemmed top and bottom edges for safety; holds 6.5 gal. (24.8 L) of waste.

**Overall Dimensions:**  
14" x 18" x 6"  
(356 x 457 x 152 mm)



**0825**  
**TRADITIONAL™ SURFACE MOUNTED WASTE RECEPTACLE**

Fabricated of 22 gauge stainless steel; holds 17 gal. (64 L) with top and bottom hemmed edges; interior hooks for liner.

**MODEL OPTION:**  
**0826** has 12 gal. (45.4 L) capacity with 15¼" x 23" x 8" (387 x 584 x 203 mm) dimensions.

**Overall Dimensions:**  
15¾" x 21⅞" x 11¼"  
(400 x 556 x 298 mm)



**4004**  
**TRADITIONAL™ UNDER VANITY TOWEL DISPENSER AND WASTE RECEPTACLE**

Dispenses 300 C-fold or 475 multi-fold paper towels and has a waste capacity of 10 gal. (38 L). Waste disposal door is spring loaded to remain shut. Fabricated of 20 gauge stainless steel.

<b>Unit Size:</b> 17 <sup>7</sup> / <sub>16</sub> " x 24" x 14 <sup>7</sup> / <sub>16</sub> " (443 x 610 x 367 mm)	<b>Under Mount Requirements:</b> 17 <sup>1</sup> / <sub>2</sub> " x 30" x 14 <sup>1</sup> / <sub>2</sub> " (445 x 762 x 368 mm)
--	---

**Exposed Cabinet Size:**  
13<sup>1</sup>/<sub>2</sub>" x 24" x 12<sup>1</sup>/<sub>2</sub>"  
(343 x 610 x 318 mm)



**1000**  
**TRADITIONAL™ CIRCULAR COUNTER TOP WASTE CHUTE**

Provides waste deposit access to receptacle (not furnished) placed directly below chute; made of heavy gauge stainless steel with rolled flange and exposed surfaces that have satin finish.

**MODEL OPTION:**  
**1000A** has a 9" (229 mm) outside diameter with a counter opening of 8<sup>5</sup>/<sub>8</sub>" (206 mm) diameter.

<b>Unit Size:</b> 6 <sup>3</sup> / <sub>4</sub> " (171 mm) outside diameter	<b>Counter Opening:</b> 5 <sup>3</sup> / <sub>4</sub> " (146 mm) diameter
--	--



**1001**  
**TRADITIONAL™ COUNTER TOP MOUNTED PAPER TOWEL DISPENSER/WASTE RECEPTACLE**

Capacity of 1 package of C-fold paper towels for loading by pushing through hinged dispensing flaps. Loose waste receptacle to be placed directly below waste door on the vanity floor is provided. Capacity is 7.5 gal. (28 L).

<b>Unit Size:</b> 14 <sup>1</sup> / <sub>4</sub> " x 15" x 3 <sup>1</sup> / <sub>2</sub> " (362 x 381 x 2 mm)	<b>Counter Opening:</b> 12 <sup>1</sup> / <sub>2</sub> " x 13 <sup>1</sup> / <sub>2</sub> " (318 x 343 mm)
---	--



**1002**  
**TRADITIONAL™ COUNTER TOP MOUNTED PAPER TOWEL DISPENSER**

Capacity of 1 package of C-fold paper towels for loading by pushing downward through hinged dispensing flaps.

<b>Unit Size:</b> 14 <sup>1</sup> / <sub>4</sub> " x 6" x 3 <sup>1</sup> / <sub>2</sub> " (362 x 152 x 2 mm)	<b>Counter Opening:</b> 12 <sup>1</sup> / <sub>2</sub> " x 4 <sup>1</sup> / <sub>4</sub> " (318 x 108 mm)
--	---



**1003**  
**TRADITIONAL™ COUNTER TOP MOUNTED WASTE RECEPTACLE**

Push door is self-closing. A 12" x 12" x 12" (305 x 305 x 305 mm) waste receptacle is furnished to be placed directly below waste door on the vanity floor.

<b>Unit Size:</b> 14 <sup>1</sup> / <sub>4</sub> " x 10" x 3 <sup>1</sup> / <sub>2</sub> " (362 x 254 x 2 mm)	<b>Counter Opening:</b> 8 <sup>3</sup> / <sub>4</sub> " x 12 <sup>1</sup> / <sub>2</sub> " (222 x 318 mm)
---	---

SHOWN FROM LEFT: 0196-00 TURBO-PRO™ - WHITE  
0196-41 TURBO-PRO™ - MATTE BLACK  
0196-93 TURBO-PRO™ - STAINLESS STEEL  
HIGH-SPEED ADA HAND DRYERS



# TURBO-PRO™ AUTOMATIC HAND DRYER

Introducing ASI's Elegant ADA-Compliant, High-Speed, Automatic Hand Dryer. A HEPA filter is used to purify the air before it dries hands. The replaceable filter is housed in a separate chamber, which allows it to be easily accessed for removal without the need to disconnect the dryer.

The dryer provides operating flexibility—the owner controls air temperature as well as air speed to suit their needs and a 5-year warranty provides peace of mind. Available in Matte Black, White, or Satin finish Stainless Steel in 110-120 V or 208-240 V.

## WHAT MAKES TURBO-PRO™ UNIQUE?



### HIGH-SPEED YET QUIETER

The TURBO-Pro™ high-speed hand dryers offer quieter operation and faster drying time.

**Low Decibel Level:**  
68 to 73.8 dB-A @ 2M



### ADA ACCESSIBILITY STANDARD COMPLIANT

Our TURBO-Pro™ hand dryers are engineered to comply with the standards set forth by the American Disabilities Act for accessibility and safety.

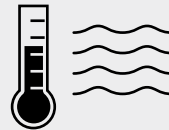

### ADJUSTABLE AND FAST

The dryer provides operating flexibility—the owner controls air temperature as well as air speed to suit their needs.

## HEPA Filter

### HEPA FILTER

A HEPA filter is used to purify the air before it dries hands.



## TURBO-PRO™ AUTOMATIC HAND DRYER

**0196-00 WHITE**

**0196-41 MATTE BLACK**

**0196-93 SATIN STAINLESS STEEL**

### FEATURES

- ADA compliant – ultra slim
- Ultra-hygienic – HEPA filter
- Energy efficient
- Quieter
- Fast drying
- Easy to maintain

### VARIABLE SETTINGS

- Air flow can be lowered
- Heat can be turned on or off
- Save energy
- Reduce noise
- Gain operating flexibility

### ELECTRIC

Different models for operating voltage

110-120 V (50/60 Hz),

220-240 V (50/60 Hz)

ON/OFF Heat Option

Nichrome Wire

325 – 500 W

### DECIBEL LEVEL

68 to 73.8 dB-A @ 2M

### DIMENSIONS

8 5/8" x 13 3/8" x 4"  
(219 x 345 x 102 mm)



**0661-1**  
**VELARE™ STAINLESS STEEL CABINET WITH FRAMELESS MIRROR, LIQUID SOAP DISPENSER, AND HIGH-SPEED HAND DRYER (110-120 V)**

This wall mounted stainless steel cabinet conceals a hands-free automatic liquid soap dispenser with a .4 gal. (1.5 L) capacity and a high-speed hand dryer (110-120 V) equipped with a HEPA filter. Available in 208-240 V (0661-2).

**Overall Dimensions:**  
 23<sup>5</sup>/<sub>16</sub>" x 35<sup>7</sup>/<sub>16</sub>" x 7<sup>7</sup>/<sub>16</sub>"  
 (600 x 900 x 192 mm)

**Decibel Level:** 68-73.8 dB-A @ 2M



**0663-1**  
**VELARE™ STAINLESS STEEL CABINET WITH FRAMELESS MIRROR, FOAM SOAP DISPENSER ,AND HIGH-SPEED HAND DRYER (110-120 V)**

This wall mounted stainless steel cabinet conceals a hands-free automatic foam soap dispenser with a .4 gal. (1.5 L) capacity and a high-speed hand dryer (110-120 V) equipped with a HEPA filter. Available in 208-240 V (0663-2).

**Overall Dimensions:**  
 23<sup>5</sup>/<sub>16</sub>" x 35<sup>7</sup>/<sub>16</sub>" x 7<sup>7</sup>/<sub>16</sub>"  
 (600 x 900 x 192 mm)

**Decibel Level:** 68-73.8 dB-A @ 2M



**64672-1**  
**SIMPLICITY™ 3-IN-1 PAPER TOWEL DISPENSER, HIGH-SPEED HAND DRYER, AND WASTE RECEPTACLE**

Paper towel dispenser with waste receptacle and <15 second automatic hand dryer, dispenses 500 standard multi-fold or 400 standard C-fold paper towels with a waste capacity of 6.8 gal. (26 L). Durable 20 gauge stainless steel cover has a satin finish. Dryer has 5-year warranty. 110-120 V. Available in 208-240 V (64672-2).

**Unit Size:** 15<sup>3</sup>/<sub>8</sub>" x 55<sup>3</sup>/<sub>8</sub>" x 7<sup>1</sup>/<sub>2</sub>"  
 (391 x 1407 x 191 mm)  
**Wall Opening:** 14<sup>3</sup>/<sub>32</sub>" x 54<sup>3</sup>/<sub>8</sub>" x 7<sup>1</sup>/<sub>4</sub>"  
 (358 x 1381 x 184 mm)

**Decibel Level:** 68.9-74.3 dB-A @ 2M



**64672-1**  
**PIATTO™ COMPLETELY RECESSED 3-IN-1 PAPER TOWEL DISPENSER, HIGH-SPEED HAND DRYER, AND WASTE RECEPTACLE**

This unit comes with a phenolic door and concealed hardware, and is designed to be *completely* recessed into the plane of the washroom wall. Features a <15 second automatic hand dryer, dispenses 400 standard C-fold or 500 standard multi-fold paper towels with a waste capacity of 6.8 gal. (26 L). Dryer has 5-year warranty. 110-120 V. Available in 208-240 V (-2). For matte black phenolic door use suffix -41, for white use -00.

**Unit Size:** 15<sup>3</sup>/<sub>8</sub>" x 55<sup>3</sup>/<sub>8</sub>" x 7<sup>1</sup>/<sub>32</sub>"  
 (391 x 1407 x 191 mm)  
**Finished Wall Opening\*:** 15<sup>7</sup>/<sub>16</sub>" x 55<sup>7</sup>/<sub>16</sub>" x 7<sup>5</sup>/<sub>8</sub>"  
 (392 x 1408 x 194 mm)

**Decibel Level:** 68.9-74.3 dB-A @ 2M



ALL STAINLESS STEEL IS TYPE 304 WITH SATIN FINISH, UNLESS OTHERWISE NOTED.

\*All Piatto™ models require finished wall openings for installation. The edges of the finished wall opening are meant to be visible after installation, hence edges must be flat, square, straight, and plumb—no rough or unsightly edges.





**NEW**

**0192 TURBO Swift™ ADA HIGH-SPEED HAND DRYER**

High-speed ADA-compliant automatic hand dryer has one-piece stainless steel cover with satin finish and delivers eco-friendly and cost-saving performance. Includes adjustable infrared sensor, and LED indicates power status and guides user toward air flow. Fast drying, <12 seconds. 110-120 V.

**Overall Dimensions:**  
6<sup>7</sup>/<sub>32</sub>" x 10<sup>1</sup>/<sub>16</sub>" x 4"  
(174 x 256 x 102 mm)

**Decibel Level:** 74 dB-A @ 2M

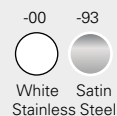

**0196-41 TURBO-PRO™ HIGH-SPEED ADA HAND DRYER**

Elegant ADA-compliant, high-speed, automatic hand dryer. A HEPA filter is used to purify the air before it dries hands. The dryer provides operating flexibility—the owner controls air temperature as well as air speed. Fast drying, <15 seconds. Available in 110-120 V (-1) and 208-240 V (-2).

**Overall Dimensions:**  
8<sup>5</sup>/<sub>8</sub>" x 13<sup>3</sup>/<sub>16</sub>" x 4"  
(219 x 345 x 102 mm)

**Decibel Level:** 68-73.8 dB-A @ 2M

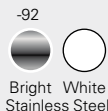

**0199-93 ASITURBO-ADA ACCESSIBILITY COMPLIANT HIGH-SPEED HAND DRYER**

Fast drying, <15 seconds, and automatic operation using infrared sensor with auto-resetting thermostat. Owner-adjustable air speed and temperature and on/off heating options with shut off when user removes hands from sensor zone. Standard white cover; optional bright or satin stainless steel finish. Available in 110-120 V (-1), 208-240 V (-2), and 277 V (-3).

**Overall Dimensions:**  
10<sup>5</sup>/<sub>8</sub>" x 8<sup>15</sup>/<sub>32</sub>" x 4"  
(270 x 215 x 102 mm)

**Decibel Level:** 68.9-74.3 dB-A @ 2M

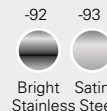

**0197 TURBO-DRI™ HIGH-SPEED HAND DRYER**

Fast drying, <15 seconds, and powerful, yet quiet, with 60-second auto shut off; automatic operation using infrared sensor with auto-resetting thermostat. Heavy-duty, one-piece-formed unit in bright or satin stainless steel finish, or white porcelain enamel coated steel. Available in 115-120 V (-1) and 208-240 V (-2).

**Overall Dimensions:**  
8<sup>1</sup>/<sub>16</sub>" x 11<sup>19</sup>/<sub>64</sub>" x 7<sup>7</sup>/<sub>64</sub>"  
(205 x 287 x 180 mm)

**Decibel Level:** 61.2-65.2 dB-A @ 2M

\*ADA Compliant using Semi-Recessed Kit #0119





**0135**  
**TURBO-TUFF RECESSED HIGH-SPEED**  
**HAND DRYER**

Fast drying, <15 seconds, and operates automatically using infrared sensor with auto-resetting thermostat. Owner-adjustable air speed and temperature and on/off heating options. Dryer automatically shuts off after time-out when user removes hands from sensor zone. Available in 110-120 V (-1), 208-240 V (-2), and 277 V (-3).

**Unit Size:** 12<sup>19</sup>/<sub>32</sub>" x 15<sup>3</sup>/<sub>4</sub>" x 4<sup>1</sup>/<sub>16</sub>"  
 (320 x 400 x 103 mm)

**Wall Opening:** 12<sup>9</sup>/<sub>16</sub>" x 15<sup>3</sup>/<sub>16</sub>" x 3<sup>7</sup>/<sub>8</sub>"  
 (313 x 386 x 98 mm)

**Decibel Level:**  
 68.9-74.3 dB-A @ 2M



**0198-MH**  
**SAFE-DRI™ RECESSED MENTAL HEALTH APPROVED**  
**HIGH-SPEED HAND DRYER**

Anti-ligature dryer operates automatically and is designed for Behavioral Health environments—angled top, welded corners, and single tube exhaust prevent looping, tying off, wedging, and prying. Tamper-resistant 18 gauge stainless steel cover and flush pin-hex security screws. Available in 115-120 V (-1) and 208-240 V (-2).

**Unit Size:** 12<sup>5</sup>/<sub>8</sub>" x 15<sup>3</sup>/<sub>4</sub>" x 5<sup>1</sup>/<sub>16</sub>"  
 (320 x 400 x 140 mm)

**Wall Opening:** 12<sup>1</sup>/<sub>4</sub>" x 15<sup>3</sup>/<sub>16</sub>" x 5<sup>1</sup>/<sub>4</sub>"  
 (311 x 386 x 133 mm)

**Decibel Level:**  
 66 dB-A @ 2M



**0165**  
**PROFILE™ COMPACT HAND DRYER**

Operates automatically from IR sensor that activates dryer when hands are placed in sensor zone. Motor and heating element have internal resetting automatic thermal protection. Fabricated of one-piece, heavy-duty cast aluminum with white enamel coating. Quick drying, <30 seconds. 115-240 V.

**Overall Dimensions:**  
 11<sup>3</sup>/<sub>8</sub>" x 11<sup>7</sup>/<sub>32</sub>" x 3<sup>1</sup>/<sub>8</sub>"  
 (289 x 285 x 99 mm)

**Decibel Level:** 66 dB-A @ 2M



**0198-93**  
**TURBO-DRI™ Jr. HIGH-SPEED HAND DRYER**

Powerful, fast drying, <15 seconds, yet quiet (69 dB-A); automatic operation and resetting thermostat with 2-second delayed turn off. Cover fabricated of heavy-duty, one-piece-formed steel with white enamel, or satin finish stainless steel. Available in 110-120 V and 220-240 V.

**Overall Dimensions:**  
 9<sup>25</sup>/<sub>32</sub>" x 6<sup>5</sup>/<sub>8</sub>" x 5<sup>13</sup>/<sub>32</sub>"  
 (248.3 x 168.2 x 137.5 mm)

**Decibel Level:** 66 dB-A @ 2M



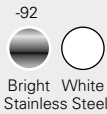

**0185**  
**PROFILE™ HAND DRYER**

Universal voltage; automatically adjusts to voltages of 100-240 V. Quick drying, <25 seconds, and no-touch, energy efficient operation. Modern design and durable. Cover available in one-piece steel with porcelain enamel coating, or stainless steel in bright or satin finish.

**MODEL OPTION:**  
**0184** Surface mounted no-touch hand dryer, 277 V.

**Overall Dimensions:**  
14<sup>1</sup>/<sub>16</sub>" x 10<sup>13</sup>/<sub>16</sub>" x 3<sup>15</sup>/<sub>16</sub>"  
(367 x 275 x 100 mm)

**Decibel Level:** 69.2 dB-A @ 2M



**20199**  
**ROVAL™ SEMI-RECESSED HIGH-SPEED HAND DRYER**

This high-performing hand dryer, with a drying time of 10-15 seconds, has a cover made of 18 gauge stainless steel. Available in 120 V (-1) and 240 V (-2).

<b>Unit Size:</b> 11" x 15 <sup>1</sup> / <sub>2</sub> " x 5 <sup>23</sup> / <sub>32</sub> " (279 x 394 x 145 mm)	<b>Wall Opening:</b> 10 <sup>1</sup> / <sub>2</sub> " x 14 <sup>5</sup> / <sub>8</sub> " x 3 <sup>1</sup> / <sub>4</sub> " (267 x 371 x 83 mm)
---	--

**Decibel Level:** 69 dB-A @ 2M



**20201**  
**TRI-Umph™ HIGH-SPEED HAND DRYER, WHITE**

ABS plastic with silver ions. Ergonomic—no need to bend over or bend knees. Air blows down and back from vents above. No water splash-back. Ultra hygienic—over 99% of airborne bacteria is eliminated with the removable Triple HEPA Filter System. 5-year warranty.

<b>Unit Size:</b> 12 <sup>11</sup> / <sub>16</sub> " x 23 <sup>1</sup> / <sub>8</sub> " x 7 <sup>3</sup> / <sub>4</sub> " (322 x 588 x 196 mm)	<b>Decibel Level:</b> 62.9 to 67.2 dB-A @ 2M
--	---

**MODEL OPTION:**  
**20200** Silver and Black.





## Top Fill Multi-Feed Soap Dispensing System

SHOWN FROM LEFT: 0394-1AC-41 EZ FILL™ FOAM SOAP DISPENSER – MATTE BLACK, 0397-1AC EZ FILL™ WATER FAUCET – CHROME, 0394-1AC EZ FILL™ FOAM SOAP DISPENSER – CHROME, AND 0389-1AC TOP FILL MULTI-FEED FOAM SOAP DISPENSER – SATIN FINISH

### WHAT MAKES OUR TOP FILL SOAP DISPENSING SYSTEMS UNIQUE?

UPTO  
**6 OR 12**  
DISPENSERS

#### MULTI-FEED SYSTEM

EZ Fill™ up to 6 dispensers.

0388 & 0389 up to 12 dispensers.

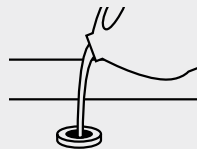

#### EASY REFILL

Using a single soap reservoir, this top fill system allows refill of soap dispensers with 1 pour—for easy ongoing maintenance.



#### FOAM OR LIQUID SOAP

Dispensers available for both foam and liquid soap.

UPTO  
**6**  
LITER CAPACITY

#### RANGE OF SIZES FOR ALL NEEDS

Holds 6 L of soap to supply up to 6 EZ Fill™ or 12 0388 & 0389 vanity mounted automatic soap dispenser units.

### 0388 & 0389 TOP FILL MULTI-FEED SYSTEM (UP TO 12\*)

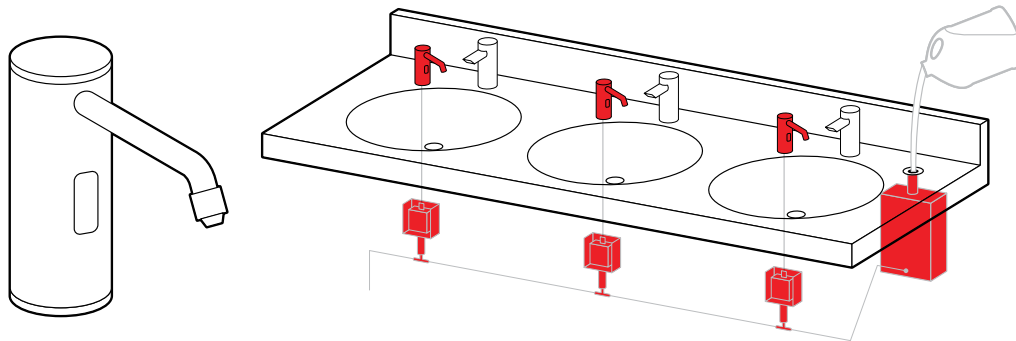

Soap Heads	Model		Soap Heads	Model	
LIQUID	0387	Top Fill, Multi-Feed – Vanity Mounted Fill Port w/ 6L Under Vanity Tank	FOAM	0387	Top Fill, Multi-Feed – Vanity Mounted Fill Port w/ 6L Under Vanity Tank
	0388-1A	Top Fill, Multi-Feed Liquid Soap Dispenser (Batt. not incl.) Satin Finish		0389-1A	Top Fill, Multi-Feed Foam Soap Dispenser (Batt. not incl.) Satin Finish
	0388-1AC	Top Fill, Multi-Feed Liquid Soap Dispenser (AC) Satin Finish		0389-1AC	Top Fill, Multi-Feed Foam Soap Dispenser (AC) Satin Finish

\*Max 6 dispensers on each side of tank. For proper installation refer to owner's manual.

### EZ FILL™ INDIVIDUAL

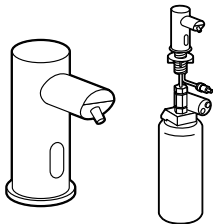

Individual vanity mounted automatic soap dispenser is refilled by removing 1 liter bottle from EZ FILL™ bracket under the counter.

### EZ FILL™ MULTI-FEED SYSTEM (UP TO 6)

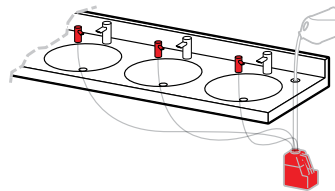

Refill up to six soap dispensers with one pour.

Soap Heads	Individual Chrome	6 Pack SKU <sup>1</sup>	Individual Matte Black	6 Pack SKU <sup>1</sup>	Soap Heads	Multi-Feed Chrome	6 Pack SKU <sup>1</sup>	Multi-Feed Matte Black	6 Pack SKU <sup>1</sup>
LIQUID	0391-1AC	0391-6-1AC	0391-1AC-41	0391-6-1AC-41	LIQUID	0390-1AC	0390-6-1AC	0390-1AC-41	0390-6-1AC-41
	0391-1A	0391-6-1A	0391-1A-41	0391-6-1A-41		0390-1A	0390-6-1A	0390-1A-41	0390-6-1A-41
FOAM	0394-1AC	0394-6-1AC	0394-1AC-41	0394-6-1AC-41	FOAM	0393-1AC	0393-6-1AC	0393-1AC-41	0393-6-1AC-41
	0394-1A	0394-6-1A	0394-1A-41	0394-6-1A-41		0393-1A	0393-6-1A	0393-1A-41	0393-6-1A-41
<b>Faucets</b>					<b>TOP FILL, MULTI-FEED SYSTEM REQUIRES (A) AND (B)</b>				
CHROME	0397-1AC	(A) 0390 - Multi-Feed Kit <sup>3</sup> – Kit <sup>3</sup> includes a 6 Liter Soap Container, Top Fill Tube and Counter Fill Port with Cover			(B) Multi-Feed – Soap Dispenser Head(s) <sup>4</sup>				
	0397-1A								
<b>EZ FILL™ ACCESSORIES</b>									
MATTE BLACK	0397-1AC-41	0390-BR- Optional Under Counter Mounting Bracket for 6 Liter Container			0390-ARK- Anti-Rotation Kit for all 0390 Series				
	0397-1A-41	0390-R- Remote Control <sup>1</sup> to adjust liquid dispensing settings			0393-R- Remote Control <sup>1</sup> to adjust foam dispensing settings				
<i>Stand Alone Dispensers come standard with 1 Liter soap container</i>									

<sup>1</sup> One Remote Control provided at no charge, with the 6 Pack SKU  
<sup>2</sup> Powered by 6 D-size batteries (not included)

<sup>3</sup> Kit does not include soap dispenser heads  
<sup>4</sup> Soap Dispenser Heads do not come with Multi-Feed Kit



**0362-41**  
**AUTOMATIC SURFACE MOUNTED LIQUID SOAP AND GEL HAND SANITIZER DISPENSER – MATTE BLACK**

Stainless steel liquid soap and gel hand sanitizer dispenser with matte black finish and proximity sensor. Powered by 6 AA-size batteries (not included) and has a tamper-resistant sight gauge. Capacity: 27 oz. (0.8 L).

**Overall Dimensions:**  
 4<sup>13</sup>/<sub>16</sub>" x 10<sup>5</sup>/<sub>8</sub>" x 4<sup>1</sup>/<sub>8</sub>"  
 (122 x 270 x 105 mm)



**0397**  
**EZ FILL™ WATER FAUCET – CHROME**

Matching water faucet for EZ Fill™ Top Fill Multi-Feed soap dispensing system. Battery or AC power operated, hands-free sensor housing with a highly polished chrome or matte black (-41) finish over all surfaces.

**MODEL OPTION:**  
**0397-1AC-41** Matte Black.



**0362**  
**AUTOMATIC SURFACE MOUNTED LIQUID SOAP AND GEL HAND SANITIZER DISPENSER – SATIN**

Stainless steel liquid soap and gel hand sanitizer dispenser with satin finish and proximity sensor. Powered by 6 AA-size batteries (not included) and has a tamper-resistant sight gauge. Capacity: 27 oz. (0.8 L).

**MODEL OPTION:**  
**0362-41** Matte Black.

**Overall Dimensions:**  
 4<sup>13</sup>/<sub>16</sub>" x 10<sup>5</sup>/<sub>8</sub>" x 4<sup>1</sup>/<sub>8</sub>"  
 (122 x 270 x 105 mm)



**0360**  
**AUTOMATIC SURFACE MOUNTED LIQUID SOAP AND GEL HAND SANITIZER DISPENSER**

Stainless steel liquid soap and gel hand sanitizer dispenser with satin finish and proximity sensor. Powered by 6 AA-size batteries (not included) and has a tamper-resistant sight gauge, removable lid with special lock and key. Capacity: 34 fl. oz. (1 L).

**Overall Dimensions:**  
 4<sup>1</sup>/<sub>32</sub>" x 9<sup>1</sup>/<sub>4</sub>" x 4<sup>7</sup>/<sub>8</sub>"  
 (115 x 235 x 124 mm)

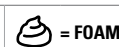
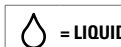





**0334-S**  
**AUTOMATIC VANITY MOUNTED LIQUID SOAP AND GEL HAND SANITIZER DISPENSER**

Hands-free dispenser powered by 4 AA-size batteries (not included) or optional AC adapter (72-ACA, not included). Stainless steel body, all exposed stainless steel surfaces have a satin finish. Capacity: 50.7 oz. (1500 ml).

**MODEL OPTION:**  
**0334-B** Stainless steel with bright finish.

**Unit Size:**  
1½" x 3¼" (38 x 97 mm)  
(dispenser body only)

Spout projection: 3⅞" (98 mm)



**0335-B**  
**AUTOMATIC VANITY MOUNTED FOAM SOAP AND HAND SANITIZER DISPENSER**

Hands-free dispenser powered by 4 AA-size batteries (not included) or optional AC adapter (72-ACA, not included). Stainless steel body, all exposed stainless steel surfaces have a bright finish. Capacity: 50.7 oz. (1500 ml).

**MODEL OPTION:**  
**0335-S** Stainless steel with satin finish.

**Unit Size:**  
1½" x 3¼" (38 x 97 mm)  
(dispenser body only)

Spout projection: 3⅞" (98 mm)



**0338**  
**TOP FILL AUTOMATIC VANITY MOUNTED LIQUID SOAP DISPENSER**

Anti-theft top opens with funnel that has built-in key for neat and easy maintenance. LED ring indicates low liquid soap levels and incorrect soap. Smart Sensor prevents messy overfilling by beeping and flashing LED ring. AC Powered, 51 oz. (1.5 L) capacity.

**Unit Size:**  
1½" x 5⅝" (38 x 137 mm)  
(dispenser body only)

Spout projection: 3⅞" (98 mm)



**0339**  
**TOP FILL AUTOMATIC VANITY MOUNTED FOAM SOAP DISPENSER**

Anti-theft top opens with funnel that has built-in key for neat and easy maintenance. LED ring indicates low foam soap levels and incorrect soap. Smart Sensor prevents messy overfilling by beeping and flashing LED ring. AC Powered, 51 oz. (1.5 L) capacity.

**Unit Size:**  
1½" x 5⅝" (38 x 137 mm)  
(dispenser body only)

Spout projection: 3⅞" (98 mm)



**20333**  
**AUTOMATIC VANITY MOUNTED LIQUID SOAP DISPENSER**

Unit has chrome plated brass on exposed surfaces. Powered by 4 D-size batteries (not included). LEDs indicate function, battery condition, and soap supply level on face front. Translucent tank. Capacity: 54 oz. (1.6 L) of liquid soap.

**Overall Dimensions:**

4" x 21½"  
 (102 x 546 mm)

Spout Projection: 3⅞" (99 mm)



**20334**  
**AUTOMATIC VANITY MOUNTED FOAM SOAP DISPENSER**

Unit has chrome plated brass on exposed surfaces. Powered by 4 D-size batteries (not included). LEDs indicate function, battery condition, and soap supply level on face front. Translucent tank. Capacity: 54 oz. (1.6 L) of foam soap.

**Overall Dimensions:**

6¾" x 16"  
 (172 x 407 mm)

Spout Projection: 3⅞" (99 mm)



**0332**  
**VANITY MOUNTED MANUAL LIQUID SOAP DISPENSER**

Corrosion-resistant valve with stainless steel spout and chrome plated brass escutcheon plate.

**MODEL OPTIONS:**

	Capacity	Spout
0332	34 oz. (1.0 L)	4" (102 mm)
0332-C	20 oz. (0.6 L)	4" (102 mm)
0332-CD	20 oz. (0.6 L)	6" (152 mm)
0332-D	34 oz. (1.0 L)	6" (152 mm)

**Unit Size:**

3⅞" x 10<sup>21</sup>/<sub>32</sub>"  
 (87 x 271 mm)



**0336**  
**VANITY MOUNTED MANUAL FOAM SOAP DISPENSER**

Plunger cap, stem and body, spout, escutcheon, and base sleeve fabricated of stainless steel. Soap container is translucent, shatter-resistant HDPE with 34 oz. (1 L) capacity.

**MODEL OPTION:**

**0336-D** 6" (152 mm) spout projection.

**Unit Size:**

3½" x 15¾"  
 (87 x 271 mm)

Spout projection: 4" (102 mm)



**20363**  
**ROVAL™ SURFACE MOUNTED LIQUID SOAP DISPENSER**

Push button operation, valve needs no more than 5 lbs. of pressure to actuate. Dispenses liquid soap Capacity: 57 oz. (1.7 L).

**Overall Dimensions:**

5½" x 10¼" x 4"  
 (139 x 274 x 102 mm)

Spout Projection: 15/16" (24 mm)



**20364**  
**ROVAL™ AUTOMATIC SURFACE MOUNTED LIQUID SOAP AND GEL HAND SANITIZER DISPENSER**

Hands-free liquid soap and gel hand sanitizer dispenser powered by 6 AA-size batteries (not included). Seamless drawn stainless steel cover. Translucent removable internal tank for easy-to-view level. LED indicates adjustment and operation. Capacity: 34 oz. (1 L).

**Overall Dimensions:**

5½" x 10¾" x 4"  
 (140 x 276 x 102 mm)



**20365**  
**ROVAL™ AUTOMATIC SURFACE MOUNTED FOAM SOAP AND HAND SANITIZER DISPENSER**

Hands-free foam soap and hand sanitizer dispenser powered by 6 AA-size batteries (not included). Seamless drawn stainless steel cover. Translucent removable internal tank for easy-to-view level. LED indicates adjustment and operation. Capacity: 34 oz. (1 L).

**Overall Dimensions:**

5½" x 10¾" x 4"  
 (140 x 276 x 102 mm)



**5001-SS**  
**DISPOSA-VALVE SURFACE MOUNTED LIQUID SOAP DISPENSER**

Soap is forced through disposable valve by pulling a lever forward. Disposable cartridges are available to dispense soap, hand lotion, heavy-duty cleaner, waterless cleaner, and antiseptic soap and are typically good for 1500 washings. Typical soap cartridges are super-concentrated cleansing formula approved for medical and food handling facilities. Fabricated of stainless steel.

**Overall Dimensions:**

4¼" x 11" x 4"  
 (108 x 279 x 102 mm)



**0361**  
**AUTOMATIC SURFACE MOUNTED LIQUID SOAP AND GEL HAND SANITIZER DISPENSER**

White, high-impact plastic, proximity sensor, and powered by one 9 V or 6 AA-size batteries (not included). Tamper-resistant sight gauge, swing open body with special lock and key. Capacity: 28 fl. oz. (0.8 L).

**Overall Dimensions:**

4⅝" x 10⅝" x 4⅞"  
 (118 x 262 x 113 mm)



**0326**  
**RECESSED HORIZONTAL LIQUID SOAP DISPENSER**

Stainless steel with satin finish, all-purpose soap valve, 57 fl. oz. (1.7 L) liquid soap capacity. Includes tamper-resistant sight gauge.

**Unit Size:**  
 10 1/4" x 6" x 4 1/2"  
 (260 x 152 x 115 mm)

**Wall Opening:**  
 9" x 4 7/8" x 4"  
 (229 x 124 x 102 mm)  
 Spout Projection: 2 1/2" (64 mm)



**9343**  
**PROFILE™ SURFACE MOUNTED LIQUID SOAP DISPENSER**

All-purpose valve dispenses liquid soap, with a capacity of 48 fl. oz. (1.4 L). It has a tamper-resistant sight gauge with concealed fastening and vandal-resistant hinged filler-top.

**MODEL OPTION:**  
**NEW 9343-41** Matte Black.

**Overall Dimensions:**  
 7 1/4" x 6 1/2" x 3 1/16"  
 (184 x 165 x 94 mm)  
 Spout Projection: 1 5/16" (24 mm)



**0347**  
**SURFACED MOUNTED VERTICAL LIQUID SOAP DISPENSER**

**0345**  
**SURFACED MOUNTED HORIZONTAL LIQUID SOAP DISPENSER**

40 fl. oz. (1.2 L) capacity liquid soap dispenser in stainless steel; satin finish comes with an all-purpose valve and a tamper-resistant sight gauge.

**MODEL OPTIONS:**  
**NEW 0347-41** Matte Black.  
**NEW 0345-41** Matte Black.

**0347 Unit Size:** 4 13/16" x 8 7/16" x 3 15/16"  
 (122 x 208 x 100 mm)  
 Spout projection: 1 1/2" (38 mm)

**0345 Unit Size:** 8 3/16" x 4 13/16" x 3 15/16"  
 (208 x 122 x 100 mm)



**NEW**



**0357**  
**SURFACED MOUNTED HORIZONTAL FOAM SOAP DISPENSER**

**0359**  
**SURFACED MOUNTED VERTICAL FOAM SOAP DISPENSER**

40 fl. oz. (1.2 L) capacity foam soap dispenser in stainless steel; satin finish comes with an all-purpose valve and a tamper-resistant sight gauge.

**0357 Unit Size:**  
 8 3/16" x 4 13/16" x 4 1/2"  
 (208 x 122 x 114 mm)

**0359 Unit Size:**  
 4 13/16" x 8 3/16" x 4 1/2"  
 (122 x 208 x 114 mm)

Spout projection: 1 1/2" (38 mm)

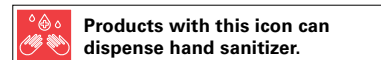



**0661-1**  
**VELARE™ STAINLESS STEEL CABINET WITH LIQUID SOAP DISPENSER AND HIGH-SPEED HAND DRYER**

This wall mounted stainless steel cabinet conceals a hands-free automatic liquid soap dispenser with a .4 gal. (1.5 L) capacity and a high-speed hand dryer (110-120 V) equipped with a HEPA filter.

**MODEL OPTION:**  
**0661-2** Velare™ Stainless Steel Cabinet with Liquid Soap and Hand Dryer (208-240 V).

**Overall Dimensions:**  
23<sup>5</sup>/<sub>16</sub>" x 35<sup>7</sup>/<sub>16</sub>" x 7<sup>9</sup>/<sub>16</sub>"  
(600 x 900 x 192 mm)



**0663-1**  
**VELARE™ STAINLESS STEEL CABINET WITH FOAM SOAP DISPENSER AND HIGH-SPEED HAND DRYER**

This wall mounted stainless steel cabinet conceals a hands-free automatic foam soap dispenser with a .4 gal. (1.5 L) capacity and a high-speed hand dryer (110-120 V) equipped with a HEPA filter.

**MODEL OPTION:**  
**0663-2** Velare™ Stainless Steel Cabinet with Foam Soap and Hand Dryer (208-240 V).

**Overall Dimensions:**  
23<sup>5</sup>/<sub>16</sub>" x 35<sup>7</sup>/<sub>16</sub>" x 7<sup>9</sup>/<sub>16</sub>"  
(600 x 900 x 192 mm)



**0661-T**  
**VELARE™ STAINLESS STEEL CABINET WITH LIQUID SOAP DISPENSER, AND PAPER TOWEL DISPENSER**

This wall mounted stainless steel cabinet conceals a hands-free automatic liquid soap dispenser with a .4 gal. (1.5 L) capacity and paper towel dispenser with a 500 towel capacity.

**Overall Dimensions:**  
23<sup>5</sup>/<sub>16</sub>" x 35<sup>7</sup>/<sub>16</sub>" x 7<sup>9</sup>/<sub>16</sub>"  
(600 x 900 x 192 mm)



**0663-T**  
**VELARE™ STAINLESS STEEL CABINET WITH FOAM SOAP DISPENSER, AND PAPER TOWEL DISPENSER**

This wall mounted stainless steel cabinet conceals a hands-free automatic liquid soap dispenser with a .4 gal. (1.5 L) capacity and paper towel dispenser with a 500 towel capacity.

**Overall Dimensions:**  
23<sup>5</sup>/<sub>16</sub>" x 35<sup>7</sup>/<sub>16</sub>" x 7<sup>9</sup>/<sub>16</sub>"  
(600 x 900 x 192 mm)



## Sanitizing (NO) Touch Accessories

ASI offers a variety of (NO) Touch soap and hand sanitizer dispensers that can be placed where and when needed.

**SHOWN: 20364 ROVAL™ AUTOMATIC SURFACE MOUNTED LIQUID SOAP AND GEL HAND SANITIZER DISPENSER**

*ASI (NO) Touch Automatic paper towel dispensers, combination units, and hand dryers can be found throughout this catalog.*



**0334-S**  
**AUTOMATIC VANITY MOUNTED LIQUID SOAP AND GEL HAND SANITIZER DISPENSER**

Hands-free dispenser powered by 4 AA-size batteries (not included) or optional AC adapter (72-ACA, not included). Stainless steel body, all exposed stainless steel surfaces have a satin finish. Capacity: 50.7 oz. (1500 ml).

**MODEL OPTION:**  
**0334-B** Stainless steel with bright finish.

**Unit Size:**  
 1½" x 3<sup>13</sup>/<sub>16</sub>" (38 x 97 mm)  
 (dispenser body only)

Spout projection: 3<sup>7</sup>/<sub>8</sub>" (98 mm)



**0335-B**  
**AUTOMATIC VANITY MOUNTED FOAM SOAP AND HAND SANITIZER DISPENSER**

Hands-free dispenser powered by 4 AA-size batteries (not included) or optional AC adapter (72-ACA, not included). Stainless steel body, all exposed stainless steel surfaces have a bright finish. Capacity: 50.7 oz. (1500 ml).

**MODEL OPTION:**  
**0335-S** Stainless steel with satin finish.

**Unit Size:**  
 1½" x 3<sup>13</sup>/<sub>16</sub>" (38 x 97 mm)  
 (dispenser body only)

Spout projection: 3<sup>7</sup>/<sub>8</sub>" (98 mm)

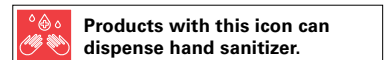



**0360**

**AUTOMATIC SURFACE MOUNTED LIQUID SOAP AND GEL HAND SANITIZER DISPENSER**

Stainless steel liquid soap and gel hand sanitizer dispenser with satin finish and proximity sensor. Powered by 6 AA-size batteries (not included) and has a tamper-resistant sight gauge, removable lid with special lock and key. Capacity: 34 fl. oz. (1 L).

**Overall Dimensions:**

4<sup>17</sup>/<sub>32</sub>" x 9<sup>1</sup>/<sub>4</sub>" x 4<sup>7</sup>/<sub>8</sub>"  
(115 x 235 x 124 mm)



**0361**

**AUTOMATIC SURFACE MOUNTED LIQUID SOAP AND GEL HAND SANITIZER DISPENSER**

White, high-impact plastic, proximity sensor, and powered by one 9 V or 6 AA-size batteries (not included). Tamper-resistant sight gauge, swing open body with special lock and key. Capacity: 28 fl. oz. (0.8 L).

**Overall Dimensions:**

4<sup>5</sup>/<sub>8</sub>" x 10<sup>5</sup>/<sub>16</sub>" x 4<sup>7</sup>/<sub>8</sub>"  
(118 x 262 x 113 mm)



**0362**

**AUTOMATIC SURFACE MOUNTED LIQUID SOAP AND GEL HAND SANITIZER DISPENSER – SATIN**

Stainless steel liquid soap and gel hand sanitizer dispenser with satin finish and proximity sensor. Powered by 6 AA-size batteries (not included) and has a tamper-resistant sight gauge. Capacity: 27 oz. (0.8 L).

**Overall Dimensions:**

4<sup>13</sup>/<sub>16</sub>" x 10<sup>5</sup>/<sub>16</sub>" x 4<sup>1</sup>/<sub>8</sub>"  
(122 x 270 x 105 mm)



**0362-41**

**AUTOMATIC SURFACE MOUNTED LIQUID SOAP AND GEL HAND SANITIZER DISPENSER – MATTE BLACK**

Stainless steel liquid soap and gel hand sanitizer dispenser with matte black finish and proximity sensor. Powered by 6 AA-size batteries (not included) and has a tamper-resistant sight gauge. Capacity: 27 oz. (0.8 L).

**Overall Dimensions:**

4<sup>13</sup>/<sub>16</sub>" x 10<sup>5</sup>/<sub>16</sub>" x 4<sup>1</sup>/<sub>8</sub>"  
(122 x 270 x 105 mm)





**NEW**

**FS-0500  
FREESTANDING SOLID PLASTIC (HDPE) SANITIZING STATION**

Constructed of red exterior with white core ½" Solid Plastic (HDPE) with antimicrobial properties. All edges and corners are radiused for safety, and bottom is equipped with rubber feet to prevent sliding. Door on back is held closed with a keyed lock and provides access to dispenser components. Hand sanitizer dispenser (0390-HSD, included) is mounted to podium on site. A single shot of gel or liquid hand sanitizer is automatically dispensed by a battery or AC powered mechanism. Unit has a polished chrome finish on all exposed surfaces and capacity of 1.6 gal. (6 L).

**Overall Dimensions:**  
13½" x 36¾" x 14"  
(343 x 930 x 356 mm)

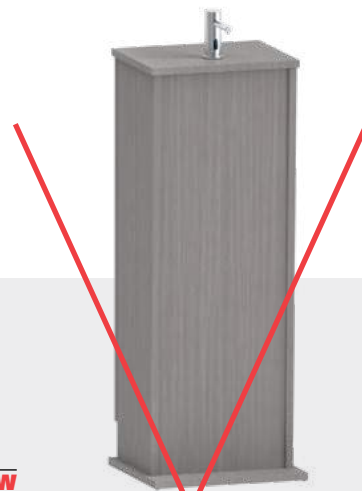

**NEW**

**FS-0700  
FREESTANDING PLASTIC LAMINATE SANITIZING STATION**

Constructed of 5/8" Plastic Laminate with antimicrobial properties in a Cosmic Strandz finish. All edges and corners are radiused for safety, and bottom is equipped with rubber feet to prevent sliding. Door on back is held closed with a keyed lock and provides access to dispenser components. Hand sanitizer dispenser (0390-HSD, included) is mounted to podium on site. A single shot of gel or liquid hand sanitizer is automatically dispensed by a battery or AC powered mechanism. Unit has a polished chrome finish on all exposed surfaces and capacity of 1.6 gal. (6 L).

**Overall Dimensions:**  
13½" x 36¾" x 14"  
(343 x 930 x 356 mm)



**20364  
ROVAL™ AUTOMATIC SURFACE MOUNTED LIQUID SOAP AND GEL HAND SANITIZER DISPENSER**

Hands-free liquid soap and gel hand sanitizer dispenser powered by 6 AA-size batteries (not included). Seamless drawn stainless steel cover. Translucent removable internal tank for easy-to-view level. LED indicates adjustment and operation. Capacity: 34 oz. (1 L).

**Overall Dimensions:**  
5½" x 107/8" x 4"  
(140 x 276 x 102 mm)



**20365  
ROVAL™ AUTOMATIC SURFACE MOUNTED FOAM SOAP AND HAND SANITIZER DISPENSER**

Hands-free foam soap and hand sanitizer dispenser powered by 6 AA-size batteries (not included). Seamless drawn stainless steel cover. Translucent removable internal tank for easy-to-view level. LED indicates adjustment and operation. Capacity: 34 oz. (1 L).

**Overall Dimensions:**  
5½" x 107/8" x 4"  
(140 x 276 x 102 mm)

## SANITIZING (NO) TOUCH ACCESSORIES

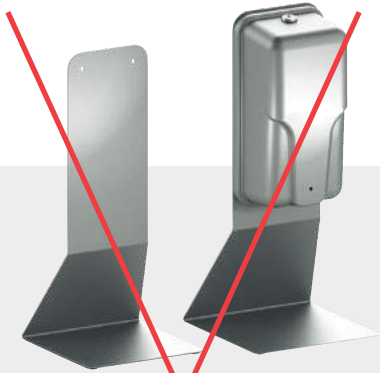

**NEW**

**DS-0400**

**STAINLESS STEEL HAND SANITIZER DISPENSER  
DESKTOP STAND**

Freestanding stainless steel desktop stand for dispensing attachments. 14 gauge stand is designed with rounded edges and has heavy-duty polyurethane feet to prevent sliding. Universal mounting plate has mounting holes/space for double-sided tape placement to accommodate mounting the following products:

**Hand Sanitizer Dispensers:**

20364, 20365, 0367, 0362, and 0362-41

**Stainless Steel Single Box Glove Dispenser:** 0501-1

**Stainless Steel Sanitizer Wipes Dispenser:** 0502

**Overall Dimensions:**

5½" x 18¼" x 3⅛"  
(140 x 463 x 204 mm)



**NEW**

**0834-TWH**

**FREESTANDING STAINLESS STEEL SANITIZER WIPES  
DISPENSER AND DISPOSAL STATION**

Sanitizer wipes dispenser station constructed of satin finish stainless steel, with 18 gauge top and 22 gauge bin. Holds one standard 9" DIA x 9" tall sanitizer wipes container (by others). Receptacle with top on holds 12 gallons (45 L) of waste and bottom is equipped with four (4) non-skid rubber feet.

**MODEL OPTION:**

**0839-TWH** has 17 gal. (64 L) capacity with 12¾" x 31⅛" x 12½" (314 x 805 x 318 mm) dimensions.

**Overall Dimensions:**

12¾" x 24⅞" x 12½"  
(314 x 614 x 318 mm)

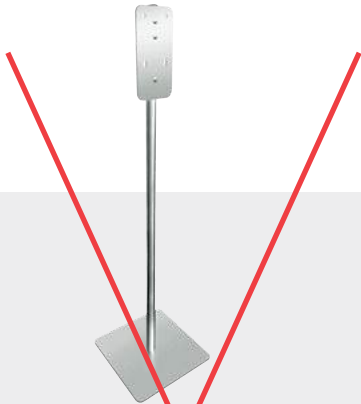

**NEW**

**FS-0300**

**FREESTANDING STAINLESS STEEL HAND SANITIZER  
DISPENSER FLOOR STAND**

Freestanding stainless steel floor stand for dispensing attachments. 11 gauge stand with rounded edges and 18 gauge mounting plate and tube. Stand sold individually with no dispensers/attachments. Universal mounting plate has mounting holes/space for double-sided tape placement to accommodate mounting the following products:

**Soap Dispensers/Hand Sanitizer Dispensers:**

20364, 20365, 0360, 0361, 0362, and 0362-41

**Stainless Steel Single Box Glove Dispenser:** 0501-1

**Stainless Steel Sanitizer Wipes Dispenser:** 0502

**Overall Dimensions:**

56⅝" (1446 mm) H  
Tube: 1½" (38 mm) DIA  
Base: 16" x 16" (406 x 406 mm)



**NEW**

**0502**

**WIPES DISPENSER HOLDER – ATTACHMENT  
FOR STANDS**

Wipes dispenser holder mounts to stainless steel stands (sold separately) with self-threading pan head screws (by others) through holes provided or with double-sided tape with top of holder no higher than 46" above finished floor for ADA compliance. Constructed of 16 gauge stainless steel with satin finish. Holds one standard sized wipes tub (by others).

**Overall Dimensions:**

5⅞" x 8" x 5"  
(139 x 203 x 127 mm)



## Mirrors

ASI provides mirrors for every location, application, and budget—in virtually any size available. Choose from a variety of reflective surfaces and wall mountings, as well as styles ranging from frameless mirrors to mirrors with shelves and tilting features. Mirror silver guaranteed for 15 years.

SHOWN: 20650 ROVAL™ STAINLESS STEEL MIRROR

### OPTIONAL REFLECTIVE SURFACES

#### SUFFIX DESCRIPTION:

- B Tempered Glass** ¼" (6 mm) polished tempered glass
- C Stainless Steel Mirrors** Type 304 Stainless Steel polished to a #8 mirror finish
- D Lexan Dura-Mir™** Fabricated of ¼" (6 mm) polycarbonate sheet
- E Plexiglas®** ¼" (6 mm) acrylic plastic, lightweight and shatter-resistant
- L Laminated Glass** ¼" (6 mm) thick

Note for Designers: All of the above glazing options are particularly suited to applications where frequent breakage and/or security problems exist. These surfaces are best specified for use in prisons, schools, police stations, psychiatric wards, etc., where shards of broken glass might possibly be used as weapons. The reflective quality of these types of mirrors is not as true as plate glass.



**0620**  
**CHANNEL FRAME MIRROR**

½" x ½" (13 x 13 x 13 mm)  
20 gauge type 304 satin finish stainless steel channel is a one-piece roll formed member that encases mirror and backing revealing a tight mitered corner. Mirror is installed on two wall brackets and held secure by theft-resistant screws.



**0605**  
**ANGLE FRAME MIRROR WITH SHELF**

**0625**  
**CHANNEL FRAME MIRROR WITH SHELF**

18 gauge stainless steel shelf with satin finish and all edges returned and hemmed for maximum rigidity and safety. Shelf is welded to face frame and is 5" (127 mm) deep.



**0535**  
**FIXED TILT MIRROR**

Offers visibility for wheelchair patients. Frame fabricated of 20 gauge stainless steel with a satin finish. Mirror is tapered from 4" (102 mm) at top to 1" (25 mm) at bottom.

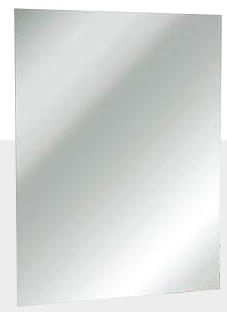

**8026**  
**FRAMELESS STAINLESS STEEL MIRROR**

Fabricated of 20 gauge type 304 stainless steel polished to a #8 mirror finish with a ⅝" (8 mm) return. Provided with ¼" (6 mm) thick concealed tempered masonite backing and 4 mounting holes.



**NEW**



**0640  
FRAMELESS MIRROR WITH  
LED BACKLIGHT**

Frameless polished edge mirror with integral mounting frame and border LED halo lighting is made of 5/32" (4 mm) thick plate glass. Hard wired, concealed LED lighting system operates on 100/240 VAC 50/60 Hz and is turned on-off by an external wall switch (by others). Unit can be mounted horizontally or vertically without additional brackets or adaptations to mounting provisions.



**NEW**



**0641  
FRAMELESS MIRROR WITH FROSTED  
BORDER AND LED BACKLIGHT**

Frameless polished edge mirror with integral mounting frame and frosted glass border LED halo lighting is made of 5/32" (4 mm) thick plate glass. Hard wired, concealed LED lighting system operates on 100/240 VAC 50/60 Hz and is turned on-off by an external wall switch (by others). Unit can be mounted horizontally or vertically without additional brackets or adaptations to mounting provisions.



**0600  
ANGLE FRAME MIRROR**

3/4" x 5/8" (19 x 16 mm) roll formed 18 gauge type 304 stainless steel angle has corners heliarc welded, ground and polished smooth to a uniform satin finish. Mirror is installed on a concealed hanging bracket that locks onto top and bottom of frame by tamper-proof set screws. Back plate is one-piece, attached to frame with theft-resistant locking device.

**MODEL OPTION:**  
**NEW** 0600-41 Matte Black.



**20650  
ROVAL™ STAINLESS STEEL MIRROR**

**20655  
ROVAL™ STAINLESS STEEL MIRROR  
WITH INTEGRAL SHELF**

Gently radiused edges match the ASI Roval™ design. Frame fabricated of 18 gauge type 304 stainless steel with satin finish and polished seamless mitered corners. 0.25" (6.4 mm) thick plate glass mirror.



**8287  
FRAMELESS MIRROR**

Frameless mirrors offer clean lines to complement every type of interior design and are easy to care for. One-piece can be up to 28 sq. ft. (2.6 m<sup>2</sup>), as long as either H or W dimension is less than 84" (2134 mm). Mirrors larger than 28 sq. ft. (2.6 m<sup>2</sup>) or with either linear H or W dimension larger than 84" (2134 mm) shall be supplied as multiple pieces. Made of 1/4" polished plate glass.



**0600-T  
ADJUSTABLE TILT MIRROR**

Designed to provide easy visibility for wheelchair patients or return to upright position. Angle frame fabricated of 18 gauge stainless steel with corners welded and ground smooth. Tilts a full 6" (152 mm) with bottom mounted on full width stainless steel piano hinge.

STANDARD MIRROR SIZES														
Width x Height	0535	0537	0600	0600-T	0605	0620	0625	0640	0641	8026	20650	20650-B	20655	20655-B
16" x 20" (41 x 51 cm)			■		■	■				■				
16" x 24" (41 x 61 cm)			■	■	■	■	■			■				
16" x 30" (41 x 76 cm)	■	■	■	■		■								
18" x 24" (46 x 61 cm)	■		■	■	■	■	■			■				
18" x 30" (46 x 76 cm)	■	■	■	■	■	■	■			■	■	■	■	■
18" x 36" (46 x 91 cm)	■	■	■	■	■	■	■				■	■	■	■
20" x 60" (51 x 152 cm)			■			■								
24" x 24" (61 x 61 cm)						■								
24" x 30" (61 x 76 cm)	■		■		■	■	■			■				
24" x 36" (61 x 91 cm)	■		■	■	■	■	■	■	■	■	■	■	■	■
24" x 42" (61 x 107 cm)			■			■								
24" x 48" (61 x 122 cm)			■			■								
24" x 60" (61 x 152 cm)			■			■								
24" x 72" (61 x 183 cm)			■											
30" x 36" (76x 91 cm)			■			■		■	■					
30" x 48" (76x 122 cm)						■								
36" x 36" (91x 91 cm)			■			■								
36" x 48" (91 x 122 cm)						■								
48" x 30" (122 x 76 cm)			■		■	■								
48" x 36" (122 x 91 cm)			■		■	■		■	■					
60" x 24" (152 x 61 cm)			■		■	■								
60" x 36" (152 x 91 cm)			■		■	■		■	■					
72" x 36" (183 x 91 cm)			■		■	■								

Custom sizes available upon request. Standard glazing is glass. See optional reflective surfaces on page 72.



**0661-1**  
**VELARE™ STAINLESS STEEL CABINET WITH**  
**FRAMELESS MIRROR, LIQUID SOAP DISPENSER,**  
**AND HIGH-SPEED HAND DRYER (110-120 V)**

This wall mounted stainless steel cabinet conceals a hands-free automatic liquid soap dispenser with a .4 gal. (1.5 L) capacity and a high-speed hand dryer (110-120 V) equipped with a HEPA filter.

**MODEL OPTION:**  
**0661-2** Velare™ Stainless Steel Cabinet with Liquid Soap and Hand Dryer (208-240 V).

**Overall Dimensions:**  
 23<sup>5</sup>/<sub>8</sub>" x 35<sup>7</sup>/<sub>16</sub>" x 7<sup>9</sup>/<sub>16</sub>"  
 (600 x 900 x 192 mm)



**0663-1**  
**VELARE™ STAINLESS STEEL CABINET WITH**  
**FRAMELESS MIRROR, FOAM SOAP DISPENSER,**  
**AND HIGH-SPEED HAND DRYER (110-120 V)**

This wall mounted stainless steel cabinet conceals a hands-free automatic foam soap dispenser with a .4 gal. (1.5 L) capacity and a high-speed hand dryer (110-120 V) equipped with a HEPA filter.

**MODEL OPTION:**  
**0663-2** Velare™ Stainless Steel Cabinet with Foam Soap and Hand Dryer (208-240 V).

**Overall Dimensions:**  
 23<sup>5</sup>/<sub>8</sub>" x 35<sup>7</sup>/<sub>16</sub>" x 7<sup>9</sup>/<sub>16</sub>"  
 (600 x 900 x 192 mm)



**0661-T**  
**VELARE™ STAINLESS STEEL CABINET WITH**  
**FRAMELESS MIRROR, LIQUID SOAP DISPENSER,**  
**AND PAPER TOWEL DISPENSER**

This wall mounted stainless steel cabinet conceals a hands-free automatic liquid soap dispenser with a .4 gal. (1.5 L) capacity and paper towel dispenser with a 500 towel capacity.

**Overall Dimensions:**  
 23<sup>5</sup>/<sub>8</sub>" x 35<sup>7</sup>/<sub>16</sub>" x 7<sup>9</sup>/<sub>16</sub>"  
 (600 x 900 x 192 mm)



**0663-T**  
**VELARE™ STAINLESS STEEL CABINET WITH**  
**FRAMELESS MIRROR, FOAM SOAP DISPENSER,**  
**AND PAPER TOWEL DISPENSER**

This wall mounted stainless steel cabinet conceals a hands-free automatic liquid soap dispenser with a .4 gal. (1.5 L) capacity and paper towel dispenser with a 500 towel capacity.

**Overall Dimensions:**  
 23<sup>5</sup>/<sub>8</sub>" x 35<sup>7</sup>/<sub>16</sub>" x 7<sup>9</sup>/<sub>16</sub>"  
 (600 x 900 x 192 mm)

## MIRRORS



**0661-FM-14**  
**VELARE™ STAINLESS STEEL FRAMELESS MIRROR FILLER MODULE**

Wall mounted type 304 stainless steel cabinet filler module provides spacing between other Velare™ BTM modules where needed. Mirror is made from 1/4" (6 mm) thick frameless tempered glass conforming to ASTM C-1048 with pencil edges and eased corners with SS sheet intermediate stiffener and SS back plate with integral welded support mounts.

**Overall Dimensions:**  
14<sup>3</sup>/<sub>4</sub>" x 35<sup>7</sup>/<sub>16</sub>" x 7<sup>9</sup>/<sub>16</sub>"  
(375 x 900 x 192 mm)



**0661-FM-23**  
**VELARE™ STAINLESS STEEL FRAMELESS MIRROR FILLER MODULE**

Wall mounted type 304 stainless steel cabinet filler module provides spacing between other Velare™ BTM modules where needed. Mirror is made from 1/4" (6 mm) thick frameless tempered glass conforming to ASTM C-1048 with pencil edges and eased corners with SS sheet intermediate stiffener and SS back plate with integral welded support mounts.

**Overall Dimensions:**  
23<sup>1</sup>/<sub>4</sub>" x 35<sup>7</sup>/<sub>16</sub>" x 7<sup>9</sup>/<sub>16</sub>"  
(591 x 900 x 192 mm)

## VELARE™ COLLECTION

**ALL-IN-ONE CABINET HOUSES AN AUTOMATIC SOAP DISPENSER, AND YOUR CHOICE OF PAPER TOWEL DISPENSER OR HAND DRYER – NOW AVAILABLE WITH MIRROR FILLERS FOR FLEXIBILITY.**

Backlit icons etched into the frameless mirror direct the user to their choice of soap and drying option. The self-contained design reduces hazards associated with wet floors. The 1/4" thick tempered glass mirror, supported by twin, damped gas springs, opens up to 90° for easy maintenance.







## Feminine Hygiene

ASI offers a wide range of feminine hygiene vendors and disposal units, available as recessed, semi-recessed, or surface mounted with various capacities. Type 304 stainless steel fabrication with satin finish on exposed surfaces and 18 gauge doors secured with concealed full length stainless steel hinges. Coin boxes are keyed separately from door lock for maximum security. Available for 25¢, 50¢, or free operation.

**SHOWN: 0468 RECESSED SANITARY NAPKIN/TAMPON VENDOR**



**0464**  
**SEMI-RECESSED SANITARY NAPKIN & TAMPON VENDOR**

Dispenses 30 feminine napkins and 27 tampons. Furnished with an adjustable flange for recessing in wall depths from 1" to 6" (26 to 152 mm). Universal coin mechanism allows for 25¢, 50¢, and free (no coin) operation. Choose appropriate suffix (-25, -50, or -F). Coin box has a separately keyed lock.

**MODEL OPTION:**  
**0864** Surface mounted.

<b>Unit Size:</b> 13¼" x 28½" x 6½" (349 x 714 x 165 mm)	<b>Wall Opening:</b> 12½" x 26½" x 1" to 6" (318 x 673 x 25 to 152 mm)
--	--



**6468**  
**SIMPLICITY™ RECESSED SANITARY NAPKIN & TAMPON VENDOR**

Dispenses 30 feminine napkins and 27 tampons. Universal coin mechanism allows for 25¢, 50¢, and free (no coin) operation. Choose appropriate suffix (-25, -50, or -F). Its door has 2 tumbler locks. Coin box has a separately keyed lock.

**MODEL OPTION:**  
**64684** designed for 4" (102 mm) wall opening; dispenses 15 napkins and 23 tampons.

<b>Unit Size:</b> 17¼" x 27¼" x 6½" (438 x 692 x 165 mm)	<b>Wall Opening:</b> 16" x 26" x 6¼" (406 x 660 x 159 mm)
--	---



**0468**  
**RECESSED SANITARY NAPKIN &  
 TAMPON VENDOR**

Dispenses 30 napkins and 27 tampons. Fabricated of 18 gauge stainless steel. Universal coin mechanism allows for 25¢, 50¢, and free (no coin) operation. Choose appropriate suffix (-25, -50, or -F).

**MODEL OPTIONS:**

**0468-2** Semi-recessed with a stainless steel collar.

**04684** Designed for 4" (102 mm) wall. Dispenses 15 napkins, 23 tampons.

<b>Unit Size:</b> 17¼" x 27¼" x 6½" (438 x 692 x 165 mm)	<b>Wall Opening:</b> 16" x 26" x 6" (406 x 660 x 152 mm)
--	--



**204684**  
**ROVAL™ RECESSED SANITARY NAPKIN &  
 TAMPON VENDOR**

Dispenses 31 napkins and 22 tampons. Door is 18 gauge satin finish stainless steel, with 2 flush tumbler locks. Universal coin mechanism allows for 25¢, 50¢, and free (no coin) operation. Choose appropriate suffix (-25, -50, or -F).

**MODEL OPTION:**

**204684-9** Surface mounted with a stainless steel collar.

<b>Unit Size:</b> 17½" x 27¾" x 5½" (440 x 705 x 143 mm)	<b>Wall Opening:</b> 15½" x 26½" x 4" (397 x 664 x 102 mm)
--	--



**6471**  
**SIMPLICITY™ RECESSED SANITARY NAPKIN DISPOSAL**

Features a self-closing 20 gauge stainless steel push door that covers the disposal opening along with a removable 1.9 gal. (7.2 L) stainless steel waste receptacle.

<b>Unit Size:</b> 10⅝" x 19⅝" x 4½" (270 x 498 x 114 mm)	<b>Wall Opening:</b> 9⅞" x 18⅞" x 4" (232 x 460 x 102 mm)
--	---



**9471**  
**PROFILE™ RECESSED SANITARY NAPKIN DISPOSAL**

Features a self-closing 16 gauge stainless steel push door that covers the disposal opening along with a removable 1.9 gal. (7.2 L) stainless steel waste receptacle.

<b>Unit Size:</b> 10⅝" x 19⅝" x 4⅞" (270 x 498 x 125 mm)	<b>Wall Opening:</b> 9⅞" x 18⅞" x 4¼" (232 x 460 x 108 mm)
--	--

## FEMININE HYGIENE VENDORS AND DISPOSALS



**0472**  
**PARTITION MOUNTED DUAL ACCESS**  
**NAPKIN DISPOSAL**

Unit serves two compartments mounted in partitions. Receptacle removable from one side for servicing and locks to back of cabinet by means of stainless steel clips. Self-closing doors on each side are mounted to cabinet with heavy-duty full length piano hinge. 22 gauge stainless steel. Capacity: 1.5 gal. (5.7 L).

**MODEL OPTION:**  
**0472-1** Waste receptacle unit with lock.

<b>Unit Size:</b>	<b>Partition Opening:</b>
13" x 17¼" x 4"	11⅝" x 15⅝"
(330 x 438 x 102 mm)	(290 x 400 mm)



**0473**  
**RECESSED SANITARY NAPKIN**  
**DISPOSAL**

Unit features self-closing door and is fabricated of 22 gauge stainless steel. Capacity: 1.5 gal. (5.7 L).

**MODEL OPTION:**  
**0473-1** Waste receptacle unit with lock.

<b>Unit Size:</b>	<b>Wall Opening:</b>
13" x 17¼" x 4"	11¼" x 15¾" x 4"
(330 x 438 x 108 mm)	(285 x 400 x 102 mm)



**0473-A**  
**SURFACE MOUNTED END STALL**  
**SANITARY NAPKIN DISPOSAL**

Unit features self-closing door and is fabricated of 22 gauge stainless steel. Capacity: 1.5 gal. (5.7 L).

**MODEL OPTION:**  
**0473-1A** Waste receptacle unit with lock.

**Overall Dimensions:**  
 11" x 15¼" x 4"  
 (279 x 387 x 102 mm)



**0852**  
**SURFACE MOUNTED SANITARY**  
**NAPKIN DISPOSAL**

Sloping cover has full length piano hinge. Fabricated of 22 gauge stainless steel. Capacity: 1.2 gal. (4.5 L).

**Overall Dimensions:**  
 7⅞" x 9¼" x 4"  
 (200 x 246 x 102 mm)



**20470**  
**ROVAL™ RECESSED SANITARY**  
**NAPKIN DISPOSAL**

Heavy-duty ⅝" staked piano hinge adds to the robust construction. Drawn, one-piece seamless door of 22 gauge stainless steel with a satin finish. 1.0 gal. (3.8 L) waste capacity.

**Overall Dimensions:**  
 12<sup>13</sup>/<sub>16</sub>" x 11" x 5<sup>1</sup>/<sub>16</sub>"  
 (325 x 280 x 138 mm)



**20852**  
**ROVAL™ SURFACE MOUNTED**  
**SANITARY WASTE RECEPTACLE**

Lid is drawn, one-piece construction and is secured to the cabinet with a heavy-duty ⅝" multi-staked concealed piano hinge. Fabricated of 22 gauge stainless steel. Capacity: 1 gal. (3.8 L).

**Overall Dimensions:**  
 7¼" x 10" x 3½"  
 (185 x 253 x 89 mm)



## Specialty Accessories

With an extensive portfolio of washroom accessories, ASI can provide whatever you need to promote the neat and orderly use of your facilities. These designs reflect our attention to detail for durability and easy maintenance.

SHOWN: 0785-Z TOWEL RING



**7385**  
**TOWEL RING**

For bath and hand towels. Ring is 4½" (114 mm) wide, made of ¼" (6 mm) diameter stainless steel bar. Projects 2½" (64 mm) from wall. 5" (127 mm) high.

**MODEL OPTION:**  
**NEW 7385-41** Matte Black.



**8425**  
**CLOTHES HOOK**

Heavy-duty 11 gauge stainless steel with satin finish. Hook projects 1¼" (32 mm) from wall and is 2¼" (57 mm) high.



**0714**  
**COAT AND BUMPER HOOK**

Fabricated from chrome plated brass, 3" (76 mm). Neoprene bumper protects wall surface.

**0719**  
**DOOR BUMPER**

Chrome plated Zamac 2¾" (56 mm) diameter flange. Projects 1⅞" (48 mm).



**0745-Z**  
**DOUBLE ROBE HOOK**

Fabricated from triple chrome plated rust-resistant Zamac.

**MODEL OPTION:**  
**0740-Z** Single robe hook.

**Overall Dimensions:**  
2¾" x 1⅞" x 1²⁹⁄₆₄"  
(56 x 37 x 37 mm)



**7340**  
**SINGLE ROBE HOOK**

Fabricated from stainless steel. Hook extends 2" (51 mm) from wall.

**MODEL OPTION:**  
**NEW 7340-41** Matte Black.



**7345**  
**DOUBLE ROBE HOOK**

4" (102 mm) wide stainless steel bar forms hook at each end. Unit extends 2" (51 mm) from wall.



**7382  
HAT AND COAT HOOK**

Double hook made from stainless steel for both coats and hats.

**Overall Dimensions:**  
2" x 7" x 3"  
(51 x 178 x 76 mm).



**0751  
HEAVY-DUTY ROBE HOOK**

Concealed mounting satin chrome plated brass, projects 3¼" (84 mm).

**MODEL OPTION:**  
**0751-A** Exposed mounting, satin chrome plated brass, projects 3¼" (83 mm).



**0785-Z  
TOWEL RING**

Bracket formed of Zamac and towel ring formed of triple chrome plated corrosion-resistant steel.

**Overall Dimensions:**  
6¾" x 1½"  
(162 x 41 mm)



**7301-B  
TOWEL PIN**

Fabricated from stainless steel with bright finish.

Extends 3½" (89 mm) from wall.

**MODEL OPTION:**  
**7301-S** Towel pin with satin finish.

**Overall Dimensions:**  
2" x 2" x 3½"  
(51 x 51 x 89 mm)



**0002-SM  
STAINLESS STEEL PAPER CUP DISPENSER**

Dispenses 100 flat bottom cups. Adjustable for 3 oz. through 6 oz. cups. Stainless steel with bright finish.

**MODEL OPTION:**  
**0002-ASM** A square version of the unit.

**Overall Dimensions:**  
3" Diameter x 15"  
(76 x 381 mm)



**0712  
SURFACE-MOUNTED RETRACTABLE CLOTHES LINE**

Polished stainless steel unit has spring actuated 72" (1829 mm) vinyl cord with white vinyl knob and locking nut to hold stretched line taut. Installs over bathtub or in shower.



**7320  
SOAP DISH**

Drawn, one-piece stainless steel soap dish welded to support arm and flange. Has two drain holes and two ridges to support bar of soap.

**MODEL OPTION:**  
**0721-Z** Fabricated from triple chrome plated rust-resistant Zamac.

**Overall Dimensions:**  
4¼" x 2" x 4"  
(108 x 51 x 102 mm)



**7335  
TOOTHBRUSH AND TUMBLER HOLDER**

Drawn, one-piece toothbrush holder is made of stainless steel. Has 2¼" (60 mm) diameter hole in center of unit to hold tumbler. Accommodates 6 toothbrushes.

**MODEL OPTION:**  
**0735-Z** Fabricated from triple chrome plated rust-resistant Zamac.

**Overall Dimensions:**  
4¼" x 2" x 4"  
(108 x 51 x 102 mm)



**7355  
TOWEL BAR-ROUND**

3/4" (19 mm) diameter stainless steel towel bar and stainless steel mounting bracket. Available in 18", 24", and 30" (457, 610, and 762 mm) lengths in bright (-B) and satin (-S) finishes. Extends 3 1/4" (83 mm) from wall

**MODEL OPTION:**  
**NEW 7355-24-41** 24" Matte Black.



**0755-SS  
HEAVY-DUTY STAINLESS  
STEEL TOWEL BAR**

Towel bar fabricated of 1" (25 mm) O.D. x 20 gauge, stainless steel with a satin finish and designed not to turn in support posts. Support posts fabricated of heavy solid cast brass plated to have stainless steel satin finish to match stainless steel. Available in 18" and 24" (457, and 610 mm) lengths.



**0760-Z  
SQUARE TOWEL BAR**

3/4" (19 mm) square 21 gauge triple chrome plated rust-resistant Zamac. Available in 18", 24", and 30" (457, 610, and 762 mm) lengths.

Fabricated from triple chrome plated rust-resistant Zamac.



**7310-B  
TOWEL SHELF WITH  
TOWEL BAR**

8" (203 mm) deep consisting of four 3/8" (10 mm) diameter bright finish stainless steel tubes, with 1/4" (6 mm) diameter bright finish stainless steel towel bar below shelf, available in 24" (610 mm). Overall height: 4 1/4" (110 mm).

**MODEL OPTION:**  
**7310-S** Towel shelf with satin finish.



**7311-B  
TOWEL SHELF WITH  
TOWEL BAR**

Heavy-duty unit with 3/4" (19 mm) diameter drying rod and 3/8" (10 mm) diameter cross tubes in stainless steel. Bright finish only. Available 20" (508 mm) and 24" (610 mm). Overall height: 6 1/2" (165 mm); projects 8" (203 mm).



**0755-Z  
ROUND TOWEL BAR**

Triple chrome plated rust proof Zamac brackets. Triple chrome plated steel tubing 18", 24", and 30" (457, 610, and 762 mm) long.



**NEW  
0503  
HANDS-FREE ARM GRIP  
DOOR PULL**

Hands-free arm grip door pull provides an alternative to open doors without having to use hands. Grip is surface mounted with self-threading flat head screws (by others) through holes provided, at standard mid-door height, or no higher than 40" above finished floor for ADA compliance, to allow placing the forearm to pull door open. Constructed of 11 gauge stainless steel with satin finish and fully deburred edges for user safety.

**Overall Dimensions:**  
1 3/4" x 2 1/8" x 3"  
(44 x 54 x 76 mm)



**NEW  
0504  
HANDS-FREE FOOT GRIP  
DOOR PULL**

Hands-free foot grip door pull provides an alternative to open doors without having to use hands. Grip is surface mounted with self-threading flat head screws (by others) through holes provided, at base of door aligned with bottom edge or slightly above, and as close to opening side as possible. Constructed of 11 gauge stainless steel with satin finish and fully deburred edges for user safety.

**Overall Dimensions:**  
3" x 3" x 2 9/64"  
(76 x 76 x 54 mm)



**0258-SS**  
**SURFACE MOUNTED FACIAL TISSUE DISPENSER**

Fabricated of stainless steel with satin finish. Dispenses 300 single-ply or 150 two-ply sheets.



**MODEL OPTION:**  
**0259-SS** A recessed version of the unit.

**Overall Dimensions:**  
 10¼" x 5½" x 2¾"  
 (260 x 135 x 55 mm)



**048234**  
**RECESSED MULTI-ROLL TOILET TISSUE DISPENSER**

Holds and dispenses 4 rolls or 1800 sheets of standard toilet tissue.

**Unit Size:** 17¾" x 20" x 4¼"  
 (441 x 508 x 108 mm)      **Wall Opening:** 15½" x 18¾" x 4"  
 (400 x 467 x 102 mm)



**0484**  
**PARTITION MOUNTED DUAL ACCESS SEAT COVER AND TOILET TISSUE DISPENSER**

Mounts centered through partition. Internal baffles prevent line of sight view from either side through unit at any time. Holds and dispenses 1000 seat covers and 4 rolls or 1800 sheets of standard toilet paper.

**MODEL OPTIONS:**  
**0484-HC** Mounts flush to partition.  
**0485** For end-stall installation.  
**0486** Surface mounted with a stainless steel collar.

**Unit Size:** 17¾" x 30⅝" x 4½"  
 (441 x 778 x 114 mm)      **Partition Opening:** 15½" x 28⅝" x ½" to 2"  
 (394 x 733 x 13 to 51 mm)



**04813**  
**PARTITION MOUNTED DUAL ACCESS TOILET TISSUE DISPENSER WITH NAPKIN DISPOSAL**

Mounts through partition, usable by both sides but serviced from one side. Holds 4 rolls of toilet tissue.

**MODEL OPTIONS:**  
**04813-HC** One side mounts flush.  
**04823** Holds two rolls, for end-stall installation.  
**04833** Surface mounted with a stainless steel collar.

**Unit Size:** 17¾" x 20" x 4¼"  
 (441 x 508 x 108 mm)      **Partition Opening:** 15½" x 18¼"  
 (394 x 464 mm) adjustable for partitions in thickness from ½" to 2" (13 to 51 mm)



**0481**  
**PARTITION MOUNTED DUAL ACCESS SEAT COVER AND TOILET TISSUE DISPENSER WITH SANITARY DISPOSAL**

Mounts through partition usable by both sides but serviced from one side. Holds 1000 seat covers and 4 rolls of toilet tissue.

**MODEL OPTIONS:**  
**0481-HC** One side mounts flush.  
**0482** For end-stall installation.  
**0483** Surface mounted with a stainless steel collar.

**Unit Size:** 17¾" x 30⅝" x 4¼"  
 (441 x 778 x 108 mm)      **Partition Opening:** 15½" x 28⅝"  
 (394 x 733 mm) adjustable for partitions in thickness from ½" to 2" (13 to 51 mm)



**NEW**



**0487-R**  
**RECESSED ADA-COMPLIANT TOILET TISSUE AND SEAT COVER DISPENSER WITH WASTE DISPOSAL**

Recessed seat cover and toilet paper dispenser with sanitary napkin disposal. Holds 500 seat covers and 2 rolls of toilet tissue.

**MODEL OPTIONS:**  
**0487-L** All components on opposite side.  
**0487-R-9** Surface mounted with a stainless steel collar.  
**0487-L-9** Surface mounted with a stainless steel collar, with all components on opposite side.

**Unit Size:** 28" x 14¼" x 4¼"  
 (711 x 362 x 108 mm)      **Wall Opening:** 26½" x 12⅞" x 4¼"  
 (673 x 327 x 108)



SHOWN: 74022-H TOILET TISSUE DISPENSER



# TOILET TISSUE DISPENSERS

ASI offers many different designs and styles to complement the features of your washroom setting. Engineered for heavy-duty use and easy maintenance, these units stand the test of time.

Choose from a wide range of features, based on your own washroom needs. All of these options are easy to install, easy to use, durable, and affordably priced.

## WHAT MAKES THESE DISPENSERS UNIQUE?

**18-22**  
GAUGE

### STAINLESS STEEL CONSTRUCTION

Our dispensers are made of stainless steel, which is a tough, durable material that is stain-resistant and easy to clean.

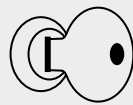

### TUMBLER LOCKS

Our tumbler locks provide convenience and security with an elegant look.

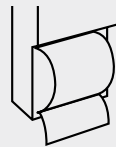

### SAFE, EASY DISPENSING

Dispensing and storage options vary, from single roll to multiple rolls or jumbo roll dispensers.

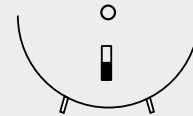

### VIEWING SLOT

Slot in front cover of jumbo roll dispensers provides easy visual indication of remaining tissue supply.

## SPINDLES:



**R-002: THEFT-RESISTANT SPINDLE FOR 0263 AND 0264 SERIES (STANDARD)**

FOR 0402-Z, 0697-GAL, 0705-Z AND VARIOUS 7000 SERIES UNITS



**R-003: CHROME-PLATED SPINDLE (OPTIONAL)**



**R-009: THEFT-RESISTANT SPINDLE (OPTIONAL)**

FOR 0030, 0031, 0032, 9030, 20030, 20031, AND ALL COMBINATION UNITS



~~**R-004: ABS SPINDLE (STANDARD)**~~



**R-005: SPINDLE FOR CORELESS ROLLS (OPTIONAL)**



**RECESSED ADA-COMPLIANT TOILET TISSUE AND SEAT COVER DISPENSER WITH WASTE DISPOSAL**

See our Toilet Tissue Combination Units, page 83.



**9030**

**PROFILE™ SURFACE MOUNTED DUAL ROLL TOILET TISSUE DISPENSER**

Stainless steel cabinet with mechanism for theft-resistant spindles holds 2 rolls up to 5¼" (133 mm) diameter (1800 sheets); the top roll automatically drops in place when the bottom roll is used up.

**Overall Dimensions:**

6" x 12" x 6¼"  
(152 x 305 x 159 mm)



**0030**

**SURFACE MOUNTED DUAL ROLL TOILET TISSUE DISPENSER**

Holds two rolls up to 5¼" (133 mm) diameter (1800 sheets). Top roll automatically drops in place when bottom roll is used up. Stainless steel cabinet and mechanism. Theft-resistant spindles.

**Unit Size:**

6" x 12" x 6½"  
(152 x 305 x 165 mm)



**0032**

**PARTITION MOUNTED DUAL ACCESS DUAL ROLL TOILET TISSUE DISPENSER**

Serves two toilet compartments by mounting through partition. Dispenses 4 toilet tissue rolls. Adjustable to accommodate partitions from ½" to 1¼" thick (13 to 32 mm).

**Unit Size:**

14" x 14⅞" x 10"  
(356 x 359 x 255 mm)

**Partition Opening:**

12⅞" x 12¼" x ½-2½"  
(308 x 311 x 13-64 mm)



**0031**

**RECESSED DUAL ROLL TOILET TISSUE DISPENSER**

Holds two rolls up to 5¼" (133 mm) diameter (1800 sheets). Top roll automatically drops in place when bottom roll is used up. Stainless steel cabinet and mechanism. Theft-resistant spindles. Includes stainless steel flange for recess mounting.

**Unit Size:**

8" x 14" x 6½"  
(203 x 356 x 165 mm)

**Wall Opening:**

6¼" x 12¼" x 3⅞"  
(159 x 311 x 86 mm)



**0039**

**SURFACE MOUNTED LOW PROFILE TWIN 9" JUMBO ROLL TOILET TISSUE DISPENSER**

Holds two 9" (229 mm) diameter rolls of 2¼" or 3" (57 or 76 mm) diameter core. When one roll is depleted, slide panel to expose other roll. Door cabinet and mounting plate fabricated of 18 gauge stainless steel with a satin finish. Door is hung on heavy-duty stainless steel pivot hinges. Equipped with tumbler lock.

**Overall Dimensions:**  
20½" x 11⅜" x 4⅛"  
(521 x 284 x 119 mm)



**0040**

**SURFACE MOUNTED TWIN 9" JUMBO ROLL TOILET TISSUE DISPENSER**

Holds two 9" (229 mm) diameter rolls of 2¼" or 3" (57 or 76 mm) diameter core. When one roll is depleted, slide panel to expose other roll. Door cabinet and mounting plate fabricated of 18 gauge stainless steel with a satin finish. Two viewing slots reveal toilet tissue rolls inside. Equipped with tumbler lock.

**Overall Dimensions:**  
20⅜" x 11⅜" x 6⅜"  
(529 x 289 x 157 mm)



**0042**

**SURFACE MOUNTED JUMBO ROLL TOILET TISSUE DISPENSER**

Holds one roll up to 10" (254 mm) diameter of 1½" or 2¼" (41 or 57 mm) diameter core. Outer cabinet is stainless steel with a satin finish. Unit has viewing slot and tumbler lock.

**MODEL OPTION:**  
**NEW 0042-41** Matte Black.

**Overall Dimensions:**  
10⅝" x 10⅝" x 4½"  
(270 x 270 x 114 mm)



**74022-H**

**RECESSED DOUBLE TOILET TISSUE HOLDER WITH HOOD**

Recessed dual roll toilet paper holder with hood is fabricated of stainless steel. Rollers are made of chrome plated ABS and spring-loaded.

**MODEL OPTIONS:**  
**74022** Same as 74022-H but without hood.  
**7402** Single roll unit.  
**7402-H** Single roll unit with hood.

**Overall Dimensions:**  
12⅝" x 6⅝"  
(320 x 160 mm)



**0263-1**  
**SURFACE MOUNTED SINGLE ROLL**  
**TOILET TISSUE DISPENSER**

Single roll toilet tissue dispenser with controlled-delivery spindle. Holds and dispenses all standard core roll tissue up to 6" (152 mm) diameter. Fabricated of heavy-duty aluminum casting with satin-matte, silver-grey powder coated finish.

**MODEL OPTION:**

**0264-1** Double roll toilet tissue dispenser.

**Overall Dimensions:**

6½" x 1¾" x 4"  
 (165 x 45 x 102 mm)



**0267**  
**VANDAL-RESISTANT HOOD**

14 gauge satin finish stainless steel for use only with 0264-1 (specified and purchased separately).

**Unit Size:**

14½" x 7¾" x 6½"  
 (359 x 197 x 175 mm)

**MODEL OPTION:**

**0266** Hood for single roll toilet tissue dispenser.

**Unit Size:**

7¼" x 7¾" x 6½"  
 (184 x 197 x 175 mm)



**0697-GAL**  
**SURFACE MOUNTED STAINLESS**  
**STEEL SHELF AND DOUBLE TOILET**  
**TISSUE HOLDER**

Shelf, 18 gauge stainless steel satin finish with front edge hemmed. Holds two 1500 sheet toilet tissue rolls.

**Overall Dimensions:**

18" x 4½" x 5"  
 (457 x 106 x 127 mm)



**7305-B**  
**SURFACE MOUNTED TOILET TISSUE**  
**HOLDER**

Bright finish stainless steel with chrome plated roller. Heavy gauge concealed bracket mounts on wall. Holds standard core roll.



**MODEL OPTIONS:**

**7305-S** Satin finish stainless steel.  
**7305-2S/2B** Holds 2 rolls.

**7305-S/B Overall Dimensions:**

7¾" x 2 x 3⅞" (207 x 51 x 98 mm)

**7305-2S/2B Overall Dimensions:**

13½" x 2 x 3⅞" (343 x 51 x 98 mm)



**0715**  
**SURFACE MOUNTED DOUBLE**  
**TOILET TISSUE HOLDER CHROME**  
**PLATED STEEL**

Provided with vandal-resistant locking device and mechanism to provide controlled delivery. High polish finish. Dispenses two standard or 1800 sheet toilet tissue rolls.

**Overall Dimensions:**

12⅞" x 2¾" x 4¼"  
 (314 x 70 x 108 mm)

**0710**

**SURFACE MOUNTED SINGLE**  
**TOILET TISSUE HOLDER**

**Overall Dimensions:**

6" x 2¾" x 4¼"  
 (152 x 70 x 108 mm)



**7403**  
**RECESSED EXTRA ROLL TOILET**  
**TISSUE HOLDER**

Spring-loaded chrome roller. Extra roll stored behind roll in use.

**MODEL OPTIONS:**

**7403-B** Rec., bright stainless steel.  
**7403-S** Rec., satin stainless steel.

NOTE: If drywall installation is required, add suffix "D" to model number. If wetwall installation is required, add suffix "W" to model number (no clamp is required for wetwall).

**Overall Dimensions:**

6⅞" x 6¼"  
 (160 x 159 mm)



**0402-Z  
RECESSED SINGLE TOILET TISSUE  
HOLDER**

Holds any standard core roll tissue up to 5" (127 mm) diameter. Die-cast of Zamac in seamless one-piece construction.

**Wall Opening:**  
5¼" x 5¼" x 2"  
(133 x 133 x 51 mm)



**0477-SM  
SURFACE MOUNTED TOILET SEAT  
COVER DISPENSER**

Dispenses 250 single or half-fold seat covers. Fabricated of 22 gauge stainless steel with satin finish.

**MODEL OPTION:**  
**NEW 0477-SM-41** Matte Black.

**Overall Dimensions:**  
15¾" x 11" x 1¼"  
(400 x 279 x 32 mm)

**0477  
RECESSED TOILET SEAT COVER  
DISPENSER**

Door has tumbler lock, dispenses 500 single or half-fold seat covers.

**Unit Size:** 17¼" x 12¾" x 2⅝"  
(438 x 324 x 60 mm)      **Wall Opening:** 15¾" x 11¼" x 2⅝"  
(400 x 285 x 67 mm)



**20477-SM  
ROVAL™ SURFACE MOUNTED  
SEAT COVER DISPENSER**

Dispenses 250 seat covers. Fabricated of 20 gauge stainless steel with a satin finish.

**Overall Dimensions:**  
15¾" x 11" x 2⅝"  
(400 x 280 x 60 mm)



**0705-Z  
SURFACE MOUNTED TOILET  
TISSUE HOLDER**

Fabricated from triple chrome plated rust-resistant Zamac. Dispenses one standard core roll tissue up to 5" (127 mm).

**Overall Dimensions:**  
5⅞" x 1⅞" x 2¾"  
(149 x 37 x 70 mm)



**7303  
EXTRA ROLL TOILET TISSUE  
HOLDER**

Extra roll of toilet tissue is placed over the horn type holder. Stainless steel set screw on bottom of flange locks unit to mounting plate.



**110-13  
RECESSED TOILET TISSUE HOLDER –  
FRONT MOUNT, SQUARE**

Fabricated of 14 gauge type 304 stainless steel with satin finish exterior, glass blasted satin finish interior 4½" (114 mm) deep accommodates one standard toilet tissue roll. Flange is 7" (179 mm) square. Includes front mounting holes.

Additional security toilet tissue holders are available at [americanspecialties.com](http://americanspecialties.com).



## Grab Bars

All ASI grab bars are made in compliance with ADA guidelines for strength requirements. Various configurations are available in satin finish 18 gauge type 304 stainless steel (peened or smooth), powder coated matte black or white, and antimicrobial finishes. These single structure units are heliarc welded, and mandrel bending ensures uniform bar diameters.

**SHOWN: 3801-24AW ANTIMICROBIAL GRAB BAR, 3701-24 STAINLESS STEEL GRAB BAR, AND 3801-24-41 GRAB BAR IN MATTE BLACK**



### EXPOSED MOUNTING

**3400 Series** — 1¼" (32 mm) O.D.  
**3500 Series** — 1½" (38 mm) O.D.

Features include flange of 3" (76 mm) diameter, ⅝" (3 mm) thick type 304 stainless steel with a satin finish; exposed mounting screw holes are drilled and countersunk.



### SNAP FLANGE

**3700 Series** — 1¼" (32 mm) O.D.  
**3800 Series** — 1½" (38 mm) O.D.

Features include cover that snaps over mounting flange dimples to conceal screws and concealed mounting flange of 3⅝" (79 mm) O.D. diameter with 2 screw holes and 3 locking dimples; ⅝" (3 mm) thick, type 304 stainless steel. Cover is type 304 stainless steel with a satin finish and 22 gauge, 3⅞" (81 mm) diameter.

### MODEL OPTIONS:

**3700-W** White.  
**3800-W** White.  
**NEW 3800-41** Matte Black.  
**NEW 3801-18-41** 18" Matte Black.  
**NEW 3801-24-41** 24" Matte Black.  
**NEW 3801-36-41** 36" Matte Black.  
**NEW 3801-42-41** 42" Matte Black.



**Ag+**

GERM GUARD™  
POWDER COATING

### ANTIMICROBIAL GRAB BAR WITH SNAP FLANGE

**3800-AW Series** — 1½" (38 mm) O.D.

ASI's Germ Guard™ grab bars are designed to suppress the growth of mold, bacteria, fungus, algae, mildew, and yeasts. They are made from stainless steel and are finished with an electrostatically applied powder coating. This powder coating is custom formulated to incorporate slow release silver ions (Ag+), the most powerful and long-lasting natural antimicrobial agent known.

:  
**3801-18AW** 18"      **3801-42AW** 42"  
**3801-24AW** 24"      **3801-48AW** 48"  
**3801-36AW** 36"      **3802-48AW\*** 48"  
 (\*with intermediate support)



## GRAB BAR CONFIGURATIONS

The following standard shapes are typical configurations. Grab bars can be custom designed and manufactured to meet any specific architectural requirement.

### Designers Note:

For a non-slip surface, specify suffix "P" (peened). When specifying grab bars insert the configuration type numbers listed below into the double zeros at the end of the grab bar series number.

Example 1: A 1½" (38 mm) concealed 18" x 33" (460 x 840 mm) horizontal grab bar has a model number—3874. When a special size is needed, add suffix "M" plus the size, to the closest standard bars.

Example 2: A 1½" (38 mm) concealed 23" x 37" (585 x 940 mm) horizontal grab bar has a model number 3874-M2337.

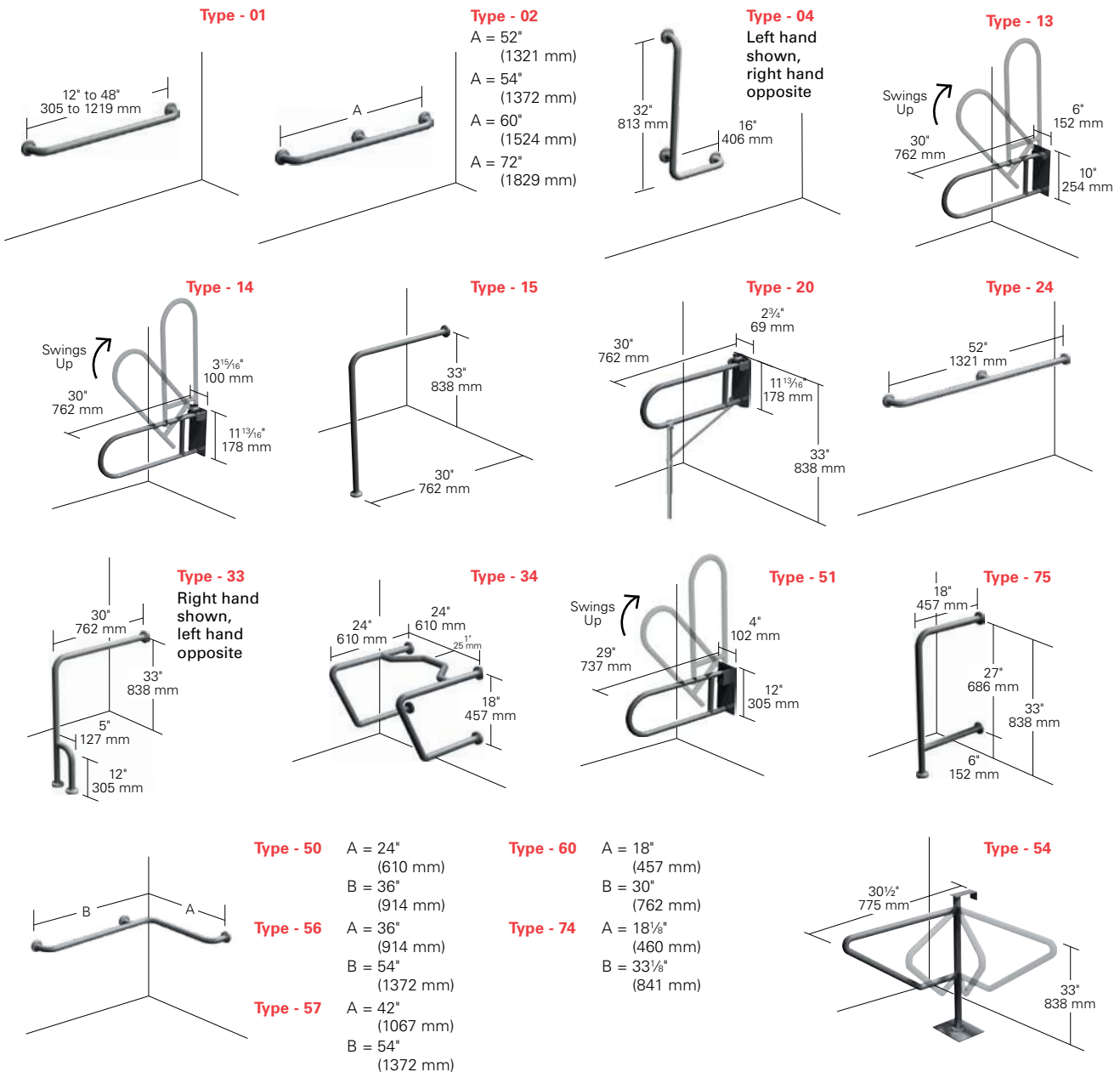



## Shower/Tub Accessories

ASI provides a full range of shower and tub accessories that show attention to details to address the safety and comfort needs of users. All items—including shower seats and benches, tub seats, soap dishes, and shower curtain rods—are designed to ensure secure installation and easy use.

SHOWN: 1201-A CURVED SHOWER CURTAIN ROD WITH MOUNTING BRACKETS



**0398**  
**RECESSED HEAVY-DUTY SOAP DISH AND BAR**

Stainless steel unit with bright polished finish exterior and sand blasted finish interior. Includes mounting clamp for stud walls.

**Overall Dimensions:**  
 7 $\frac{1}{8}$ " x 5" x 4"  
 (181 x 127 x 102 mm)

**Wall Opening:**  
 6 $\frac{1}{8}$ " x 4 $\frac{1}{8}$ " x 4"  
 (156 x 105 x 102 mm)

**MODEL OPTIONS:**

**0399** Same as 0398, but includes kit for installing in cement wall.

**0400** Without bar.

**0401** Same as 0400, but includes kit for installing in cement wall.



**0410-Z**  
**RECESSED SOAP DISH WITH BAR**

Die-cast of Zamac in seamless one-piece construction. A plastic soap tray with drying ribs interlocks with housing for retention.

**Overall Dimensions:**  
 6 $\frac{1}{4}$ " x 6 $\frac{1}{4}$ " x 3 $\frac{3}{8}$ "  
 (181 x 127 x 86 mm)

**Wall Opening:**  
 5 $\frac{1}{4}$ " x 5 $\frac{1}{4}$ " x 2"  
 (133 x 133 x 51 mm)



**7404-S**  
**RECESSED SOAP DISH**

Seamless one-piece construction fabricated of 22 gauge stainless steel with satin finish. Provided with a raised lip to retain soap.

**MODEL OPTION:**  
**7404-B** Bright stainless steel.

<b>Overall Dimensions:</b>	<b>Wall Opening:</b>
6 <sup>1</sup> / <sub>4</sub> " x 6 <sup>5</sup> / <sub>16</sub> " x 2"	5 <sup>1</sup> / <sub>2</sub> " x 5 <sup>1</sup> / <sub>2</sub> " x 2"
(159 x 160 x 51 mm)	(140 x 140 x 51 mm)



**7410-B**  
**RECESSED SOAP DISH AND BAR**

One-piece construction soap dish fabricated of 22 gauge stainless steel with bright finish. Includes a bar, held permanently between two posts at top of unit.

**MODEL OPTION:**  
**7410-S** Satin stainless steel.

<b>Overall Dimensions:</b>	<b>Wall Opening:</b>
6 <sup>5</sup> / <sub>16</sub> " x 6 <sup>1</sup> / <sub>4</sub> " x 3"	5 <sup>1</sup> / <sub>2</sub> " x 5 <sup>1</sup> / <sub>2</sub> " x 2"
(160 x 159 x 76 mm)	(140 x 140 x 51 mm)



**1204**  
**EXTRA HEAVY-DUTY SHOWER CURTAIN ROD**

3<sup>3</sup>/<sub>16</sub>" (81 mm) diameter flanges of 20 gauge type 304 stainless steel with satin finish and 1<sup>1</sup>/<sub>4</sub>" (32 mm) diameter rod of 18 gauge type 304 stainless steel tubing with satin finish. Available in lengths up to 96" (2438 mm); special order on longer lengths.

**MODEL OPTION:**  
**1214** 20 gauge, 1" (25 mm) diameter rod. Available in lengths up to 72" (1829 mm).



**1201-A**  
**CURVED SHOWER CURTAIN ROD WITH MOUNTING BRACKETS**

Fabricated of type 304 stainless steel. Tubing is 18 gauge, 1" DIA (25 mm) with a satin finish. Length is suitable for a 60" (1524 mm) wide enclosure either on opposite walls (-B) or across the face opening (-A) depending upon rod length chosen.

**MODEL OPTION:**  
**1201-B** Curved shower curtain rod with mounting brackets for opposite walls.



**1224**  
**CONCEALED MOUNTING SHOWER CURTAIN ROD**

Chrome plated brass with satin finish flanges and 1" (25 mm) diameter rod of 20 gauge type 304 stainless steel with satin finish. One flange has set screw to lock rod and prevent rotation. Available in lengths up to 72" (1829 mm); for longer lengths, specify 1204.



**1200-SHU  
SHOWER CURTAIN HOOK**

Stainless steel hook for rods 1" (25 mm) and 1¼" (32 mm) diameter.

**Overall Dimensions:**

1⅝" x 2⅞"  
(40 x 67 mm)



**1200-V  
VINYL SHOWER CURTAIN**

Flame-resistant, anti-bacterial, 10 gauge white vinyl fabric with standard height of 72" (1829 mm). Curtain should be 6" (152 mm) wider than opening up to 42" (1067 mm) and 12" (305 mm) wider than opening exceeding 42" (1067 mm).



**8203  
COMPACT FOLDING SEAT**

⅝" (8 mm) thick, one-piece, solid, white colored, black core phenolic seat. Frame, support legs, flanges, and bracket are satin finish stainless steel. Features a self-locking mechanism. Meets ADA Accessibility Guidelines and the needs of the physically disabled and elderly when properly installed. Seat measures 18" (457 mm) wide and projects 16" (406 mm) from wall. Additional width options are available in 20", 28", and 33" (order with suffix -20, -28, and -33).

**MODEL OPTIONS:**

**8204** Seat is sponge cushion covered with off-white Naugahyde® mounted on ½" (13 mm) thick marine grade plywood.  
**8207** Seat is fabricated of stainless steel, satin finish, slatted design.



**8208-R  
FOLDING SHOWER SEAT**

(Right hand) Slats are fabricated with stainless steel in satin finish. Requires only one hand operation to manually lower to horizontal position for use or raise for departure and arrival. Guide bracket with spring detent prevents seat from dropping and provides positive support in usage position as well as spring locked storage position. Meets ADA Accessibility Guidelines and the needs of the physically disabled and elderly when properly installed. Seat measures 33" (838 mm) wide and projects 23" (584 mm) from wall.

**MODEL OPTION:**

**8208-L** Left hand seat.



**0010  
CORNER SHOWER SEAT**

Seat, support brackets, and retainer clip are satin finish stainless steel. Seat is secured to one wall with full length piano hinge and support on other wall by bracket. Meets ADA Accessibility Guidelines and the needs of the physically disabled and elderly when properly installed.

**Overall Dimensions:**

15¾" x 15¾"  
(400 x 400 mm)



**8358  
FOLDING TUB SEAT**

½" (13 mm) thick, solid, white colored, black core phenolic seat. Frame, mounting bracket, and retainer hook are satin finish stainless steel. Meets ADA Accessibility Guidelines and the needs of the physically disabled and elderly when properly installed. Seat measures 15" (387 mm) wide and projects 33¾" (860 mm) from wall.



**8206-L**  
**FOLDING SHOWER SEAT**

(Left hand) Meets ADA Accessibility Guidelines and the needs of the physically disabled and elderly when properly installed. Seat is 1/2" (13 mm) thick, one-piece, solid, white colored, black core phenolic. Frame, support legs, flanges, and bracket are satin finish stainless steel. Phenolic seat ONLY is field reversible. Seat measures 33" (838 mm) wide and projects 22 7/8" (581 mm) from wall.

**MODEL OPTIONS:**

- 8206-R** Right hand seat.
- 8205-L** Left hand seat with cushion covered in off-white Naugahyde.
- 8205-R** Right hand seat with cushion covered in off-white Naugahyde.



**NEW**  
**8206-SC-L**  
**SLOW CLOSE FOLDING SHOWER SEAT**

Slow Close Phenolic L-Shaped Fold Up Shower Seat provides added safety and ease of use. Gas charged struts assist one-handed opening by allowing the slowly lowering seat to its operating position and also assists in partial closing. (Left hand) Meets ADA Accessibility Guidelines and the needs of the physically disabled and elderly when properly installed. Seat is 1/2" (13 mm) thick, one-piece, solid, white colored, black core phenolic. Frame, support legs, flanges, and bracket are satin finish stainless steel. Phenolic seat ONLY is field reversible. Seat measures 33" (838 mm) wide and projects 22 7/8" (581 mm) from wall.

- MODEL OPTION:**  
**8206-SC-R** Right hand seat.



**8209**  
**RECTANGULAR PHENOLIC FOUR-LEG FOLD-UP SHOWER BENCH**

Seat is 1/2" (13 mm) thick solid phenolic, with white top and bottom surfaces, and black edges. Frame, mounting bracket, and retainer hook are satin finish stainless steel. Meets ADA Accessibility Guidelines and the needs of the physically disabled and elderly when properly installed. Seat is 22 1/2" (572 mm) deep and 48" (1219 mm) wide, projecting 24" (610 mm) from the wall when in the open position. When retracted, legs fold up to provide low profile against wall.



**8202**  
**L-SHAPED PHENOLIC FOUR-LEG FOLD-UP SHOWER SEAT**

Seat is 1/2" (13 mm) thick solid phenolic, with white top and bottom surfaces, and black edges, and is field reversible for left or right hand. Rear load feet remain on floor with rear frame mounted to wall and never need adjustment after correct installation. Front legs fold up automatically when seat is raised. Gravity prevents seat from dropping. Seat measures 33 1/2" (851 mm) wide and projects 15 1/2" (395 mm) from wall. Meets ADA Accessibility Guidelines and the needs of the physically disabled and elderly when properly installed.

SHOWN: 9013 BABY CHANGING STATION



# BABY CHANGING STATIONS

ASI offers baby safe solutions for baby changing stations. All units are easy to install, durable, and sanitary. To meet your washroom needs, we offer numerous choices along with many ADA-compliant models.

## WHAT MAKES OUR BABY CHANGING STATIONS UNIQUE?

TESTED WEIGHT  
**350+ lbs.**

### LARGE WEIGHT CAPACITY

Our baby changing stations have been tested using ASTM F2285-04 and EN 12221-1 protocol for a static load and in addition have been tested to hold a weight in excess of 350 lbs.



### ADA ACCESSIBILITY STANDARD COMPLIANT

Our units are engineered to comply with the standards set forth by the American Disabilities Act for accessibility and safety.

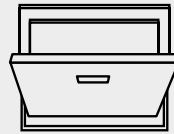

### EASY OPEN AND CLOSE

Our units are designed for easy one-handed operation and shaped to safely cradle a child's body.

**FDA**  
APPROVED

### FUNGUS- AND BACTERIA-RESISTANT PLASTIC

Our baby changing stations are made with FDA-approved fungus- and bacteria-resistant plastic.

## FEATURES

- Easy to install
- Sanitary, safe, and strong

- All units fold up; no obstruction when not in use
- Easy to clean



## SOAP DISPENSERS

See our Soap Dispensers on pages 60-67.



## SANITIZING (NO) TOUCH ACCESSORIES

See our Sanitizing (NO) Touch Accessories on pages 68-71.





**9014**  
**SURFACE MOUNTED HORIZONTAL PLASTIC BABY CHANGING STATION**

This horizontal unit has a pull handle and concealed damped gas spring, assisting in easy operation. Fabricated of FDA-approved fungus- and bacteria-resistant plastic. Unit supports a static load of 300 lbs. (136 kg). Its vinyl-coated, adjustable safety strap assures child protection.

**Overall Dimensions:**

Closed: 35 <sup>5</sup> / <sub>32</sub> " x 24 <sup>1</sup> / <sub>4</sub> " x 3 <sup>7</sup> / <sub>8</sub> " (893 x 616 x 98 mm)	Open: 35 <sup>5</sup> / <sub>32</sub> " x 24 <sup>1</sup> / <sub>4</sub> " x 22 <sup>1</sup> / <sub>32</sub> " (893 x 616 x 560 mm)
--	---



**9015**  
**SURFACE MOUNTED VERTICAL PLASTIC BABY CHANGING STATION**

This vertical unit has a pull handle and concealed damped gas spring, assisting in easy operation. Fabricated of FDA-approved fungus- and bacteria-resistant plastic. Unit supports a static load of 300 lbs. (136 kg). Its vinyl-coated, adjustable safety strap assures child protection.

**Overall Dimensions:**

Closed: 24 <sup>1</sup> / <sub>4</sub> " x 35 <sup>5</sup> / <sub>32</sub> " x 3 <sup>7</sup> / <sub>8</sub> " (616 x 893 x 98 mm)	Open: 24 <sup>1</sup> / <sub>4</sub> " x 35 <sup>5</sup> / <sub>32</sub> " x 32 <sup>15</sup> / <sub>16</sub> " (616 x 893 x 837 mm)
--	--



**9018**  
**RECESSED HORIZONTAL STAINLESS STEEL BABY CHANGING STATION**

Unit shall support a static load of 300 lbs. (136 kg) and be tested in excess of 350 lbs. (159 kg). Fabricated of FDA-approved fungus- and bacteria-resistant plastic. Door facing and collar fabricated of stainless steel.

**MODEL OPTION:**

**9018-9** Surface mounted with a stainless steel collar.

**Overall Dimensions:**

Closed: 39 <sup>9</sup> / <sub>32</sub> " x 28 <sup>1</sup> / <sub>4</sub> " x 3 <sup>7</sup> / <sub>8</sub> " (995 x 718 x 10 mm)	Open: 39 <sup>9</sup> / <sub>32</sub> " x 28 <sup>1</sup> / <sub>4</sub> " x 18 <sup>1</sup> / <sub>8</sub> " (995 x 718 x 460 mm)
--	--

**Wall Opening:**

35<sup>1</sup>/<sub>2</sub>" x 24<sup>1</sup>/<sub>2</sub>" x 4" min (902 x 622 x 102 mm)



**9017**  
**RECESSED VERTICAL STAINLESS STEEL BABY CHANGING STATION**

This vertical station has a door facing and collar made from 18 gauge stainless steel. Fabricated of FDA-approved fungus- and bacteria-resistant plastic. Unit shall support a static load of 300 lbs. (136 kg) and be tested in excess of 350 lbs. (159 kg).

**MODEL OPTION:**

**9017-9** Surface mounted with a stainless steel collar.

**Overall Dimensions:**

Closed: 28 <sup>1</sup> / <sub>4</sub> " x 39 <sup>9</sup> / <sub>32</sub> " x 3 <sup>7</sup> / <sub>8</sub> " (718 x 994 x 10 mm)	Open: 28 <sup>1</sup> / <sub>4</sub> " x 39 <sup>9</sup> / <sub>32</sub> " x 29 <sup>7</sup> / <sub>8</sub> " (718 x 994 x 746 mm)
--	--

**Wall Opening:**

24<sup>1</sup>/<sub>2</sub>" x 35<sup>1</sup>/<sub>2</sub>" x 4" min (622 x 902 x 102 mm)



**9012 SURFACE MOUNTED PLASTIC BABY CHANGING STATION**

Modern styling and easy-to-clean surface is fabricated of FDA-approved fungus- and bacteria-resistant plastic. Easy opening/closing pneumatic mechanism has oversized hinge and safety stop system. The built-in dispenser for towels or sanitary liners, hooks for diaper bag and purse, plus multi-lingual instructions add friendliness and convenience. Unit shall support a static load of 300 lbs. (136 kg). Surface mounted. Only 4" (102 mm) deep when closed.

**Overall Dimensions:**

Closed:	Open:
36" x 22" x 4"	36" x 22" x 20 <sup>7</sup> / <sub>16</sub> "
(914 x 559 x 102 mm)	(914 x 559 x 519 mm)



**9013 RECESSED STAINLESS STEEL BABY CHANGING STATION**

ADA-compliant unit features welded stainless steel for long and reliable use. Exposed surfaces are satin finish. Easy one-handed operation is assisted by a pull handle and concealed spring. The changing surface is high-impact, fungus-, and bacteria-resistant plastic for easy cleaning. Its two-part adjustable safety strap and 400 lb. (181 kg) load capacity assure child protection.

**MODEL OPTION:**

**9013-9** Surface mounted with a stainless steel collar.

**Overall Dimensions:**

Open:	Closed:
37" x 25 <sup>1</sup> / <sub>2</sub> " x 17 <sup>3</sup> / <sub>4</sub> "	37" x 25 <sup>1</sup> / <sub>2</sub> " x 3 <sup>5</sup> / <sub>8</sub> "
(940 x 648 x 451 mm)	(940 x 648 x 10 mm)

**Wall Opening:**

34<sup>1</sup>/<sub>2</sub>" x 22<sup>3</sup>/<sub>4</sub>" x 3<sup>3</sup>/<sub>4</sub>" min (870 x 578 x 95 mm)



**9020 SURFACE MOUNTED TODDLER SAFETY SEAT**

This plastic seat, mounted on the inside of the toilet partition, either on the door or panel, allows a parent to take a toddler into the stall with them. Unit shall support a static load of 50 lbs. (23 kg). Fabricated of FDA approved plastic.

**Overall Dimensions:**

Closed:	Open:
12 <sup>1</sup> / <sub>2</sub> " x 21 <sup>3</sup> / <sub>4</sub> " x 5 <sup>1</sup> / <sub>2</sub> "	12 <sup>1</sup> / <sub>2</sub> " x 21 <sup>3</sup> / <sub>4</sub> " x 11 <sup>1</sup> / <sub>8</sub> "
(318 x 552 x 140 mm)	(318 x 552 x 283 mm)



**9016 RECESSED BABY CHANGER BED LINER DISPENSER**

Holds and dispenses up to 30 paper liners. Fabricated of stainless steel.

**Unit Size:**

10" x 18" x 4"  
(254 x 457 x 101 mm)

**Wall Opening:**

8<sup>1</sup>/<sub>4</sub>" x 16<sup>1</sup>/<sub>4</sub>" x 3<sup>3</sup>/<sub>4</sub>"  
(210 x 413 x 95 mm)



## Shelves

ASI offers various configurations, sizes, and styles, including platform, recessed, and folding utility shelving—all sturdy, durable, and constructed of stainless steel.

SHOWN: 20692 SURFACE MOUNTED SHELF



**0690**  
**SHELF WITH RAISED EDGES**

Entire unit is formed of one piece of 18 gauge stainless steel having a  $\frac{3}{16}$ " (10 mm) depression with a satin finish.

See chart for standard sizes.

	Model Numbers			
	0690	0692	0694	20692
Standard Sizes:	6" depth (152 mm)	5", 6" or 8" depth (127,152, 203 mm)	5" depth (127 mm)	6" depth (152 mm)
Length				
12" (305 mm)		■		■
16" (406 mm)		■		
18" (457 mm)	■	■	■	■
24" (610 mm)	■	■	■	■
30" (762 mm)		■		■
36" (914 mm)		■		■
48" (1219 mm)		■	■	■
60" (1524 mm)		■	■	■
72" (1829 mm)				■



**0692**  
**SURFACE MOUNTED SHELF**

Fabricated of 18 gauge stainless steel with a satin finish. Front edge is hemmed for maximum rigidity and safety.

See chart for standard sizes.



**0698**  
**FOLDING UTILITY SHELF FOR TOILET COMPARTMENTS**

Fabricated of 18 gauge satin finish stainless steel with raised rim. Shelf automatically returns to upright position when not in use.

**Overall Dimensions:**  
14<sup>5</sup>/<sub>8</sub>" x 5<sup>13</sup>/<sub>16</sub>"  
(371 x 148 mm)



**0412**  
**RECESSED SHELF**

This unit is fabricated of 22 gauge, all welded construction, stainless steel with a satin finish.

**Overall Dimensions:**  
18" x 8" x 4<sup>1</sup>/<sub>4</sub>" min  
(457 x 203 x 108 mm)

**Wall Opening:**  
16<sup>1</sup>/<sub>2</sub>" x 6<sup>1</sup>/<sub>2</sub>" x 4" min  
(419 x 165 x 102 mm)



**0694**  
**SURFACE MOUNTED SHELF WITH BACKSPLASH**

Fabricated of 18 gauge stainless steel with a satin finish on exposed surfaces with 5" (127 mm) depth.



**20692**  
**ROVAL™ SURFACE MOUNTED SHELF**

Fabricated of 18 gauge stainless steel, the 6" wide shelf has a <sup>3</sup>/<sub>4</sub>" (19 mm) gently radiused edge. Choice of sizes.

**Overall Dimensions:**  
6" x 12"-72"  
(152 x 305-1829 mm)



## Custodial Accessories

Fabricated of type 304 satin finish stainless steel, our one-piece constructed custodial accessories—with various configurations of mop and broom holders and utility hooks—help keep necessary cleaning tools and supplies organized and accessible.

SHOWN: 1307-3 UTILITY HOOK STRIP WITH 3 HOOKS 26" (660 mm)



**1307-3**  
**UTILITY HOOK STRIP WITH 3 HOOKS**

Fabricated of stainless steel with satin finish, this strip is 4" (102 mm) high with edges returning  $\frac{1}{2}$ " (13 mm) to the wall. Measures 26" (660 mm) long.

**MODEL OPTIONS:**

- 1307-4** With 4 hooks 36" (914 mm) long.
- 1307-5** With 5 hooks 46" (1168 mm) long.
- 1307-6** With 6 hooks 56" (1422 mm) long.



**1308-3**  
**SHELF WITH 4 UTILITY HOOKS AND 3 MOP HOLDERS STRIP**

Fabricated of satin finish stainless steel, this shelf is 8" (203 mm) deep with  $\frac{3}{4}$ " (19 mm) return for rigidity. Mop holders are riveted to strip, and rubber cam is ribbed for grasping. Unit is 14 $\frac{1}{2}$ " (368 mm) high. Measures 34" (860 mm) long.

**MODEL OPTION:**

- 1308-4** 4 mop holders/5 utility hooks, 44" (1118 mm) long.



**1306  
HEAVY-DUTY UTILITY HOOK**

Heavy-duty 14 gauge stainless steel with satin finish.



**0533 SERIES  
CORNER GUARD**

Surface Mounted Corner Guard is constructed of robust 18 gauge stainless steel and is finished with a 1/8" radius outside edge. Guard can be mounted flush to floor or at base height. Ideal for a variety of applications.

**Overall Dimensions:**  
48" x 4 1/4" x 4 1/4" (1219 x 108 x 108 mm)

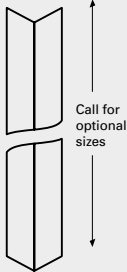

**1) CHOOSE EDGE AND MOUNTING STYLE:**

- |                                  |                                   |
|----------------------------------|-----------------------------------|
| 0533-1 Beveled w/ Adhesive       | 0533-3 Straight w/ Adhesive       |
| 0533-2 Beveled w/ Mounting Holes | 0533-4 Straight w/ Mounting Holes |

**2) ADD PREFIX FOR GAUGE:**

1 (16 Gauge) or 2 (18 Gauge)  
Ex: 0533-3-2 straight edges with adhesive mounting, 18 gauge



**8215-5  
MOP AND BROOM RACKS**

5 holders, 46" (1168 mm) long. Fabricated from one-piece hi-hat channel stainless steel.

**MODEL OPTIONS:**  
8215-3 3 holders, 26" (660 mm) long.  
8215-4 4 holders, 36" (914 mm) long.



**1315-4  
UTILITY SHELF WITH DRYING ROD, 4 MOP HOLDERS,  
AND 3 RAG HOOKS**

Fabricated of satin finish stainless steel, this shelf is 8" (203 mm) deep with 3/4" (19 mm) return for rigidity. Mop holders are riveted to strip, and rubber cam is ribbed for grasping. Rod and hooks for wet rags are included. Measures 36" (914 mm) long.

**MODEL OPTIONS:**  
1315-3 3 mop holders/2 rag hooks, 30" (762 mm) long.  
1315-6 6 mop holders/5 rag hooks, 48" (1219 mm) long.

SHOWN: 0501-4 SURFACE MOUNTED  
SURGICAL GLOVE DISPENSER



# HEALTHCARE ACCESSORIES

ASI offers many different items that are specifically designed for healthcare settings. All of these items contribute to providing an organized and hygienic environment for patients and caregivers. From innovative products like new antimicrobial

grab bars and a slow close shower seat, to glove dispensers, security cabinets, and hazardous waste disposals—ASI healthcare accessories are designed for ease of use, safety, durability, and peace of mind.

## WHAT MAKES OUR HEALTHCARE ACCESSORIES UNIQUE?

**18-22**  
GAUGE

### STAINLESS STEEL CONSTRUCTION

Our cabinets are made of stainless steel, which is tough, durable, stain-resistant and easy to clean.

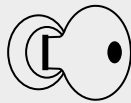

### TUMBLER LOCK

The design of our products with tumbler locks allows for the removal of internal components for sterilizing or autoclaving when necessary.

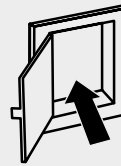

### CONVENIENT PASSAGE

Our specimen pass box and cabinet enables easy access and safe handling of specimens from patient area to laboratory.



### ADJUSTABLE SHELVES

The design of our cabinets offers flexibility with adjustable shelves for ease in storage and use.



**NEW**  
**8206-SC**  
**SLOW-CLOSE**  
**SHOWER**  
**SEAT**



**8203**  
**COMPACT**  
**FOLDING**  
**SEAT**

See our Shower Seat Collection, pages 94-95.



**8202**  
**SHOWER**  
**SEAT**



**8208**  
**SHOWER**  
**SEAT**





**0952**

**RECESSED STAINLESS STEEL MEDICINE CABINET**

Swing door mirror frame is stainless steel with satin finish. Mirror is 1/4" (6 mm), guaranteed for 15 years against silver spoilage. Door has full length piano hinge and magnetic catch. Three removable stainless steel shelves.

**Overall Dimensions:**  
18 1/4" x 24 1/4" x 4 1/2"  
(464 x 616 x 114 mm)

**Wall Opening:**  
16" x 22 3/4" x 3 1/2"  
(406 x 578 x 89 mm)

**MODEL OPTION:**  
0952-B Larger than 0952.

**Overall Dimensions:**  
24" x 26" x 4 7/8"  
(610 x 660 x 124 mm)

**Wall Opening:**  
21 3/4" x 24 1/2" x 3 1/2"  
(550 x 620 x 89 mm)



**0953**

**SURFACE MOUNTED STAINLESS STEEL MEDICINE CABINET**

Surface mounted cabinet is made from 20 gauge stainless steel with a satin finish. Mirrored door is hung on cabinet with a full length 3/8" staked piano hinge. Cabinet has three adjustable stainless steel shelves.

**Overall Dimensions:**  
18 1/4" x 24 1/4" x 4 3/4"  
(464 x 616 x 121 mm)



**0533 SERIES CORNER GUARD**

Surface Mounted Corner Guard is constructed of robust 18 gauge stainless steel and is finished with a 1/8" radius outside edge. Guard can be mounted flush to floor or at base height. Ideal for a variety of applications.

**Overall Dimensions:**  
48" x 4 1/4" x 4 1/4" (1219 x 108 x 108 mm)

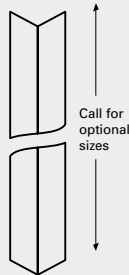

**1) CHOOSE EDGE AND MOUNTING STYLE:**

- 0533-1 Beveled w/ Adhesive
- 0533-2 Beveled w/ Mounting Holes
- 0533-3 Straight w/ Adhesive
- 0533-4 Straight w/ Mounting Holes

**2) ADD PREFIX FOR GAUGE:**

1 (16 Gauge) or 2 (18 Gauge)

Ex: 0533-3-2 straight edges with adhesive mounting, 18 gauge

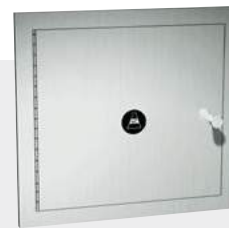

**8154**

**RECESSED PASS-THROUGH SPECIMEN CABINET**

Provides a convenient passage from patient area into laboratory. Fabricated of 18 gauge satin finish stainless steel. Internal latch prevents simultaneous door opening. Stainless steel tray is removable. Mounts in wall thickness of 1 3/4" to 5 1/2" (44 to 140 mm).

**MODEL OPTIONS:**

- 8155 Extension sleeve and flange for recessed specimen pass-through cabinet.
- 8156 Same as 8154 including 8155 extension sleeve.



8340

**RECESSED POWDER COATED MEDICINE CABINET**

One-piece, drawn cold rolled steel with white powder coated steel finish. Stainless steel channel framed mirrored door with 1/4" (6 mm) thick plate glass, has continuous piano hinge and magnetic catch. Three removable white enamel steel shelves.

**Overall Dimensions:**

18 1/4" x 24 1/4" x 4 7/8"  
(465 x 615 x 120 mm)

**Wall Opening:**

16" x 22 3/4" x 3 1/2"  
(406 x 578 x 89 mm)

**MODEL OPTIONS:**

**8338** Smaller and has two adjustable white baked enamel steel shelves.  
14 1/8" x 20 3/16" x 5"  
(359 x 513 x 125 mm)

**8339** Larger than 8338.  
16 3/16" x 22 3/16" x 5"  
(411 x 564 x 127 mm)



0546

**SECURITY MEDICINE CABINET**

Stainless steel satin finish shelves are 20 gauge with hemmed edges and are easily adjusted by owner using track clips provided. Two (2) shelves and eight (8) clips are provided.

**Overall Dimensions:**

30" x 30" x 12"  
(762 x 762 x 305 mm)



0547

**NARCOTICS CABINET - COMBINATION LOCK/DUAL DOORS**

Security cabinet for controlled narcotic substances is surface mounted and constructed from stainless steel with double wall all welded construction. Cabinet is 22 gauge and doors are 18 gauge.

**Overall Dimensions:**

11 1/4" x 15" x 8 1/4"  
(286 x 381 x 210 mm)



0350

**SURGICAL SOAP DISPENSER**

Dispenses liquid antiseptic solutions and synthetic detergent soaps. Chrome plated brass body. Capacity: 16 oz. (0.5 L) white polyethylene globe.

**Overall Dimensions:**

3 3/8" x 6 1/2" x 5 1/8"  
(86 x 165 x 130 mm)



0349

**FOOT OPERATED SURGICAL SOAP DISPENSER**

Pneumatic pump mechanism, 32 oz. (0.9 L) polyethylene container. Free turning spout is type 316 stainless steel. 96" (2438 mm) long vinyl tubing attaches to anti-slip foot pump. Dispenses liquid surgical soaps, antiseptic solutions, and synthetic detergents.

**Overall Dimensions:**

4 1/4" x 12 3/4" x 9"  
(108 x 324 x 229 mm)

Spout Projection: 9" (229 mm) from wall



**0815**  
**FLOOR STANDING FOOT OPERATED WASTE RECEPTACLE**

Foot operated waste receptacle with satin finish stainless steel body and top. Connected with multi-staked piano hinge and features hemmed edges for safety.  
 Capacity: 8 gal. (30.7 L).

**Overall Dimensions:**  
 10<sup>3</sup>/<sub>4</sub>" x 20<sup>15</sup>/<sub>16</sub>" x 10"  
 (273 x 531 x 254 mm)

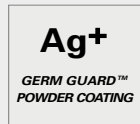

**ANTIMICROBIAL GRAB BAR WITH SNAP FLANGE**  
**3800-AW Series** — 1<sup>1</sup>/<sub>2</sub>" (38 mm) O.D.

ASI's Germ Guard™ grab bars are designed to suppress the growth of mold, bacteria, fungus, algae, mildew, and yeasts. They are made from stainless steel and are finished with an electrostatically applied powder coating. This powder coating is custom formulated to incorporate slow release silver ions (Ag+), the most powerful and long-lasting natural antimicrobial agent known.

**MODEL OPTIONS:**

- |                      |   |
|----------------------|---|
| <b>3801-18AW</b> 18" | <b>3801-42AW</b> 42"                                  |
| <b>3801-24AW</b> 24" | <b>3801-48AW</b> 48"                                  |
| <b>3801-36AW</b> 36" | <b>3802-48AW*</b> 48"<br>(*with intermediate support) |



**NEW**  
**0503**  
**HANDS-FREE ARM GRIP DOOR PULL**

Hands-free arm grip door pull provides an alternative to open doors without having to use hands. Grip is surface mounted with self-threading flat head screws (by others) through holes provided, at standard mid-door height, or no higher than 40" above finished floor for ADA compliance, to allow placing the forearm to pull door open. Constructed of 11 gauge stainless steel with satin finish and fully deburred edges for user safety.

**Overall Dimensions:**  
 1<sup>3</sup>/<sub>4</sub>" x 2<sup>1</sup>/<sub>8</sub>" x 3"  
 (44 x 54 x 76 mm)



**NEW**  
**0504**  
**HANDS-FREE FOOT GRIP DOOR PULL**

Hands-free foot grip door pull provides an alternative to open doors without having to use hands. Grip is surface mounted with self-threading flat head screws (by others) through holes provided, at base of door aligned with bottom edge or slightly above, and as close to opening side as possible. Constructed of 11 gauge stainless steel with satin finish and fully deburred edges for user safety.

**Overall Dimensions:**  
 3" x 3" x 2<sup>9</sup>/<sub>64</sub>"  
 (76 x 76 x 54 mm)



**0548**  
**RECESSED SHARPS DISPOSAL CABINET**

Satin finish stainless steel. Marked with graphic label indicating Biohazard. Holds one Becton, Dickinson and Company (BD) brand Sharps Collector model #305443 (not included).

**Overall Dimensions:** 13<sup>3</sup>/<sub>4</sub>" x 19<sup>1</sup>/<sub>16</sub>" x 5<sup>1</sup>/<sub>4</sub>"  
**Wall Opening:** 12<sup>1</sup>/<sub>8</sub>" x 17<sup>3</sup>/<sub>4</sub>" x 5"  
 (349 x 486 x 133 mm) (308 x 451 x 127 mm)

**MODEL OPTION:**  
**0548-9** Surface mounted with a stainless steel collar.



**0501-X**  
**SURFACE MOUNTED SURGICAL GLOVE DISPENSER**

Satin finish stainless steel holds and dispenses gloves from one standard surgical glove box. Fully hemmed-in rolled edges for snag-free dispensing and user safety.

**MODEL OPTIONS:**  
**0501-1** Dispenser for 1 box.  
**0501-2** Dispenser for 2 boxes.  
**0501-3** Dispenser for 3 boxes.  
**0501-4** Dispenser for 4 boxes.



**0511**  
**SURFACE MOUNTED BULK DISPENSER, SMALL**

Satin finish stainless steel. Dispenses various personal protection equipment such as gloves, caps, and shoe covers (not supplied).

**Overall Dimensions:**  
 12<sup>5</sup>/<sub>64</sub>" x 11" x 5<sup>1</sup>/<sub>2</sub>"  
 (307 x 279 x 140 mm)

**MODEL OPTION:**  
**0512** Large bulk dispenser.

**Overall Dimensions:**  
 12<sup>5</sup>/<sub>64</sub>" x 17" x 5<sup>1</sup>/<sub>2</sub>"  
 (307 x 431 x 140 mm)



**0515**  
**TURNTABLE SPECIMEN PASS BOX**

Fabricated of 18 gauge satin finish stainless steel. Turntable cylinder is 12" (305 mm) diameter with 10<sup>1</sup>/<sub>2</sub>" x 6" (267 x 152 mm) opening. Stainless steel self-lubricating ball bearing plates mounted on top and bottom permit the unit to rotate freely. Positioned bullet catches prevent uncontrolled rotation. Entire inner assembly is encased in 1" (25 mm) wide trim. Cylinder lock allows for the removal of the cylinder for sterilizing or autoclaving when necessary. Trim is adjustable for wall up to 7" (178 mm) thick.



**0551**  
**RECESSED BEDPAN AND URINAL BOTTLE CABINET**

Recessed cabinet is 22 gauge satin finish stainless steel for storage of bedpan and urinal. Cabinet provided with 1/2" (13 mm) open space across top and bottom of door to allow air circulation.

**Overall Dimensions:**  
 15" x 28" x 5<sup>1</sup>/<sub>4</sub>"  
 (381 x 711 x 133 mm)

**Wall Opening:**  
 13<sup>3</sup>/<sub>8</sub>" x 26<sup>1</sup>/<sub>2</sub>" x 5<sup>3</sup>/<sub>8</sub>"  
 (340 x 670 x 140 mm)

**MODEL OPTION:**  
**0558-1** Recessed bedpan and wash basin cabinet.



**0557**  
**SURFACE MOUNTED BEDPAN RACK**

Surface mounted rack provides convenient storage for one conventional sized bedpan.

**Overall Dimensions:**  
 12" x 11" x 4<sup>7</sup>/<sub>8</sub>"  
 (305 x 279 x 124 mm)

**MODEL OPTIONS:**  
**0556** Surface mounted bedpan and urinal rack.  
**0559** Surface mounted double bedpan rack. Similar to 0556, but designed to hold two conventional sized bedpans.



**0198-MH**  
**SAFE-DRI™ MENTAL HEALTH APPROVED RECESSED HIGH-SPEED HAND DRYER**

Anti-ligature dryer designed for Behavioral Health environments—angled top, welded corners, and single tube exhaust prevent looping, tying off, wedging, and prying. Tamper-resistant 18 gauge stainless steel cover and flush pin-hex security screws. Available in 115-120 V and 208-240 V.

**Unit Size:**  
 12<sup>5</sup>/<sub>8</sub>" x 15<sup>3</sup>/<sub>4</sub>" x 5<sup>1</sup>/<sub>16</sub>"  
 (320 x 400 x 140 mm)

**Wall Opening:**  
 12<sup>1</sup>/<sub>4</sub>" x 15<sup>1</sup>/<sub>16</sub>" x 5<sup>1</sup>/<sub>4</sub>"  
 (311 x 386 x 133 mm)

**Decibel Level:**  
 66 dB-A @ 2M



SHOWN: 7383 TOWEL SHELF WITH HANGER ROD



# HOSPITALITY ACCESSORIES

ASI offers a wide range of options to accessorize the washroom setting. These items include towel bars and racks, clothes hooks, shelving and holders. All items are easy to install and easy to clean. These items add a special touch and convenience for washroom users.

## WHAT MAKES OUR HOSPITALITY ACCESSORIES UNIQUE?

# 304

**STAINLESS STEEL**

### STAINLESS STEEL CONSTRUCTION

Our heavy-duty items are made of high-quality type 304 stainless steel, which is tough, durable, stain-resistant, and easy to clean.

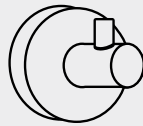

### MINIMALISTIC, CONTEMPORARY, AND CLASSIC

Different styles allow you to choose what works best to complement your washroom.

# LEED®

**FRIENDLY**

### LEED®-FRIENDLY

The robust construction made of type 304 stainless steel is LEED®-friendly and fits our sensibility about longer lifecycle building designs.



### REFINED LOOK, RICH FUNCTION

These accessories add a special touch to enhance the user's experience in the washroom setting.

### FEATURES

- Easy to install
- Hygienic and safe to use
- Durable
- Easy to clean



### FRAMELESS MIRRORS



### STAINLESS STEEL MIRRORS



### FRAMELESS MIRRORS WITH LED BACKLIGHT

See our mirrors on pages 72-76.



**7313**

**SOAP DISH WITH GLASS HOLDER**

Clear glass holder has raised ribs to elevate soap slightly above surface to promote drying. May be removed for cleaning. All other parts of the unit are fabricated of satin finish stainless steel.

**Overall Dimensions:**

4<sup>5</sup>/<sub>16</sub>" DIA x 4<sup>7</sup>/<sub>8</sub>"  
(110 DIA x 124 mm)



**7308**

**SINGLE ROBE HOOK**

Extends 2<sup>5</sup>/<sub>16</sub>" (59 mm) from wall or door. Suitable for robes, clothing, or small bags. Satin finish stainless steel hook.



**7312**

**DOUBLE ROBE HOOK**

Two hooks, set apart at 90° on center, extend 2<sup>3</sup>/<sub>8</sub>" (60 mm) from wall or door. Suitable for robes, clothing, or small bags. Satin finish stainless steel.



**7314**

**SINGLE TOILET PAPER ROLL HOLDER**

The toilet paper placed on this bail-type holder has unrestricted feed. Its design allows for easy replacement by maintenance or even guests. All exposed surfaces have a satin finish stainless steel. Paper bar is reversible to change handing.

**Overall Dimensions:**

5<sup>3</sup>/<sub>16</sub>" x 3<sup>3</sup>/<sub>8</sub>" x 2<sup>3</sup>/<sub>16</sub>"  
(131 x 86 x 56 mm)



**7317**

**COVERED WASTE RECEPTACLE**

Freestanding covered garbage can. Lid opens by depressing foot pedal. Plastic pail with wire bail included. Bright finish stainless steel. Capacity: 2 gal. (7.6 L).

**MODEL OPTION:**

**7317-S** Satin stainless steel finish.

**Overall Dimensions:**

8<sup>3</sup>/<sub>32</sub>" DIA x 12<sup>3</sup>/<sub>4</sub>"  
(210 DIA x 324 mm)



**7314-H**  
**SINGLE TOILET PAPER ROLL HOLDER WITH HOOD**

Satin finish stainless steel hood. Hood adds weight for easy tear and also protects paper roll from water droplets.

**Overall Dimensions:**  
 5¼" x 5" x 2⅞"  
 (133 x 127 x 65 mm)



**7315-H**  
**DOUBLE TOILET PAPER ROLL HOLDER WITH HOOD**

Double Toilet Paper Roll Holder with Hood is fabricated of stainless steel. All exposed surfaces have a satin finish. Roll holder bail is retained in post with concealed set screw. Hoods are captive on rod. Post is 22 gauge tubing with formed 18 gauge threaded bracket welded inside end.

**Overall Dimensions:**  
 12½" x 3" x 5"  
 (309 x 76 x 128 mm)



**7316**  
**SPARE TOILET PAPER HOLDER**

Holds one roll of toilet paper. Extends 4" (102 mm) from wall. All exposed surfaces have a satin finish stainless steel.

**Overall Dimensions:**  
 3⅝" DIA x 6⅞"  
 (90 DIA x 167 mm)



**NEW**



**0640**  
**FRAMELESS MIRROR WITH LED BACKLIGHT**

Frameless polished edge mirror with integral mounting frame and border LED halo lighting is made of ⅝" (4 mm) thick plate glass. Hard wired, concealed LED lighting system operates on 100/240 VAC 50/60 Hz and is turned on-off by an external wall switch (by others). Unit can be mounted horizontally or vertically without additional brackets or adaptations to mounting provisions.



**NEW**



**0641**  
**FRAMELESS MIRROR WITH FROSTED BORDER AND LED BACKLIGHT**

Frameless polished edge mirror with integral mounting frame and frosted glass border LED halo lighting is made of ⅝" (4 mm) thick plate glass. Hard wired, concealed LED lighting system operates on 100/240 VAC 50/60 Hz and is turned on-off by an external wall switch (by others). Unit can be mounted horizontally or vertically without additional brackets or adaptations to mounting provisions.





**7387**

**SURFACE MOUNTED TOILET BRUSH AND HOLDER**

Tube handle, round splash guard, and storage cylinder of this wall mounted unit are fabricated of satin finish stainless steel. Includes a drip cup at the bottom for easy cleaning. Brush is made of PVC with a polypropylene shaft. 15½" (394 mm) from bottom of base to top of handle and extends 5½" (131 mm) from wall. Allows for easy cleaning while maintaining an elegant washroom.

**MODEL OPTION:**

**7388** Freestanding. 15" (381 mm) from bottom of base to top of handle.



**0712**

**SURFACE-MOUNTED RETRACTABLE CLOTHES LINE**

Polished stainless steel unit has spring actuated 72" (1829 mm) vinyl cord with white vinyl knob and locking nut to hold stretched line taut. Installs over bathtub or in shower.



**7383**

**SURFACE MOUNTED TOWEL SHELF WITH HANGER ROD**

Heavy-duty unit with ¾" diameter stainless steel tubing. Stainless steel setscrew provided on bottom perimeter of flanges to lock unit to mounting plates.

**Overall Dimensions:**

23⅞" x 3½" x 8⅛"  
(600 x 89 x 227 mm)

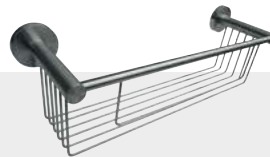

**7381**

**SURFACE MOUNTED SUNDRIES SHELF**

Stainless steel formed round wire construction and has ⅝" (10 mm) diameter. Solid retainer cross bar as front rim. Satin finish on all visible surfaces. Stainless steel setscrew provided on bottom perimeter of flanges to lock unit to mounting plates.

**Overall Dimensions:**

12⅞" x 4⅞" x 3⅝"  
(372 x 114 x 90 mm)

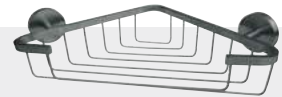

**7322**

**SURFACE MOUNTED SOAP BASKET**

Stainless steel formed round wire construction and fabricated with heavy gauge solid rectangular cross section formed bar top rim. Satin finish on all visible surfaces. Stainless steel setscrew provided on bottom perimeter of flanges to lock unit to mounting plates.

**Overall Dimensions:**

11⅝" x 2⅝" x 6½"  
(291 x 58 x 165 mm)



**7306**

**TOWEL RING**

Designed for hand towels, this 7" DIA (178 mm) towel ring is formed from a  $\frac{3}{8}$ " DIA (9.5 mm) satin finish stainless steel tube. Extends 2½" (64 mm) from wall.



**1201-A**

**CURVED SHOWER CURTAIN ROD WITH MOUNTING BRACKETS**

Fabricated of type 304 stainless steel. Tubing is 18 gauge, 1" DIA (25 mm) with a satin finish. Length is suitable for a 60" (1524 mm) wide enclosure either on opposite walls (-B) or across the face opening (-A) depending upon rod length chosen.

**MODEL OPTION:**

**1201-B** Curved shower curtain rod with mounting brackets for opposite walls.

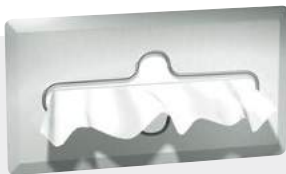

**0259-SS**

**RECESSED FACIAL TISSUE DISPENSER**

Dispenses 300 single-ply or 150 double-ply tissues. Faceplate constructed of stainless steel with satin finish.

**Overall Dimensions:**

11½" x 6¾" x 2¼"  
(302 x 162 x 57 mm)



**7307-18**

**ROUND TOWEL BAR**

Satin finish stainless steel tube and posts with round mounting brackets on ends. Extends 2½" (67 mm) from wall. 18" (457 mm) in length.

**MODEL OPTION:**

**7307-24** Same as 7307-18, but 24" (610 mm) in length, ¾" (16 mm) DIA.





## Security Accessories

ASI offers many different items that are specifically designed for settings with high security requirements. Features include design for contraband detection and clothes hooks that release when excessively loaded to deter self-harm actions.

SHOWN: 128-1 BOOK SHELF/CLOTHES HOOK—FRONT MOUNTING

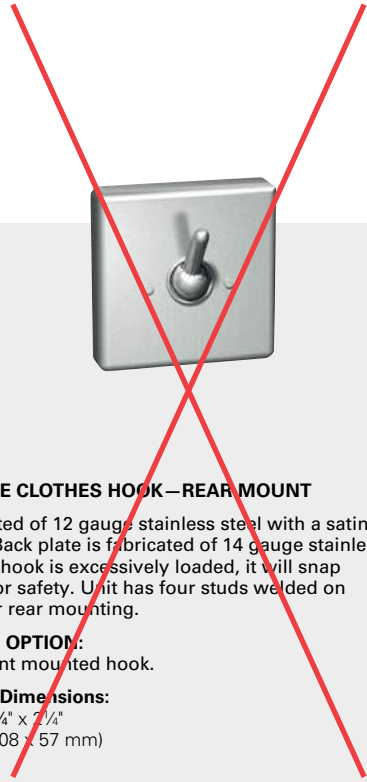

122

### SQUARE CLOTHES HOOK—REAR MOUNT

Fabricated of 12 gauge stainless steel with a satin finish. Back plate is fabricated of 14 gauge stainless steel. If hook is excessively loaded, it will snap down for safety. Unit has four studs welded on back for rear mounting.

#### MODEL OPTION:

123 Front mounted hook.

#### Overall Dimensions:

4¼" x 4¼" x 7¼"

(108 x 108 x 57 mm)



0198-MH

### SAFE-DRI™ MENTAL HEALTH APPROVED RECESSED HIGH-SPEED HAND DRYER

Anti-ligature dryer designed for Behavioral Health environments—angled top, welded corners, and single tube exhaust prevent looping, tying off, wedging, and prying. Tamper-resistant 18 gauge stainless steel cover and flush pin-hex security screws. Available in 115-120 V and 208-240 V.

#### Unit Size:

12¾" x 15¼" x 5⅞"  
(320 x 400 x 140 mm)

#### Wall Opening:

12¼" x 15⅞" x 5¼"  
(311 x 386 x 133 mm)

#### Decibel Level:

66 dB-A @ 2M



128-1

### BOOK SHELF/CLOTHES HOOK—FRONT MOUNT

Shelf and back plate are 14 gauge stainless steel with satin finish. Hooks are 12 gauge stainless steel, and back plate is 14 gauge stainless steel. Seams are welded and ground smooth. Hooks snap down for safety if excessively loaded. Unit has six holes through back for front mounting.

#### Overall Dimensions:

18" x 11" x 8"  
(457 x 279 x 203 mm)



120

**CLOTHES HOOK—FRONT MOUNT**

Bracket 11 gauge, hook 7 gauge stainless steel with satin finish. If hook is excessively loaded, it will snap down for safety. Unit has four holes through flange for front mounting.

**Overall Dimensions:**

3" x 5" x 3 1/16"  
(76 x 127 x 78 mm)

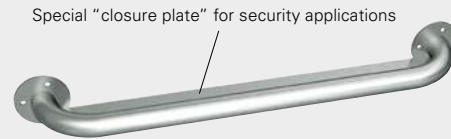

165

**GRAB BAR**

Tubing 18 gauge and flanges 1/8" (3 mm) thick stainless steel with satin finish. Closure plate is 1/8" (3 mm) thick. All welded construction. Unit has three holes through each flange for front mounting.

**MODEL OPTIONS:**

Rear Mounted	Length	Front Mounted	Length
160	24" (610)	159	18" (457)
161	30" (762)	162	30" (762)
163	36" (914)	164	36" (914)
166	42" (1067)	165	24" (610)
168	48" (1219)	167	42" (1067)
		169	48" (1219)



110-1

**SQUARE RECESSED TOILET TISSUE HOLDER—REAR MOUNT**

Fabricated of 14 gauge stainless steel with satin finish exterior, glass blasted satin finish interior 4" (102 mm) deep accommodates one standard toilet tissue roll. Flange is 7/8" (181 mm) square.

**MODEL OPTION:**

110-13 Front mounted holder.



110

**RECESSED TOILET TISSUE HOLDER—REAR MOUNT**

Fabricated of 16 gauge stainless steel, satin finish exterior, glass blasted satin finish interior. 4 1/2" (114 mm) interior depth accommodates one standard toilet tissue roll. Hidden contraband causes roll to project from holder allowing detection. Two "T" nuts welded on back for rear mounting.

**MODEL OPTION:**

110-A 7 1/4" (184 mm) DIA.

**Overall Dimensions:**

7 1/4" (184 mm) DIA.



**101-14**

**SECURITY FRAMED MIRROR—CHASE MOUNT**

Frame 14 gauge stainless steel with satin finish, corners welded, and ground smooth. Unit provided with fiberboard backing and six "T" nuts welded on back for rear mounting. Specify wall thickness if greater than 6" (152 mm). 20 gauge stainless steel with #8 mirror polish.

**Overall Dimensions:**

12" x 16" x 5/8"  
(305 x 406 x 16 mm)



**104**

**SECURITY FRAMED MIRROR—FRONT MOUNT**

Unit consists of wall mounting plate fabricated of 7 gauge stainless steel with four countersunk mounting holes and eight tapped holes. Formed mirror fabricated of 18 gauge stainless steel with #8 mirror polish finish provided with eight dimpled holes through integral frame and 1/4" x 1/4" Torx® head screws for securing to wall mounting plate. For 20 gauge No. 8 mirror polish finish use suffix -14.

**Overall Dimensions:**

10 1/16" x 11 9/16" x 7/16"  
(256 x 294 x 11 mm)



**105-14**

**SECURITY FRAMED MIRROR—FRONT MOUNT**

Frame 14 gauge stainless steel with satin finish, corners welded, and ground smooth. Front mounting furnished with Torx® vandal-resistant 1/4-20" x 2 (150 mm) machine screws. 20 gauge type 304 stainless steel with #8 mirror polish.

**Overall Dimensions:**

12" x 16" x 5/8"  
(305 x 406 x 16 mm)



**107**

**ONE-PIECE FRAMED MIRROR WITH ROUNDED CORNERS—FRONT MOUNT**

One-piece 18 gauge stainless steel formed mirror with #8 mirror polish finish, integral frame, rounded corners, and six mounting holes. For 20 gauge No. 8 mirror polish finish use suffix -14.

**Overall Dimensions:**

12" x 16" x 1/4"  
(305 x 406 x 6 mm)



**127**

**CLOTHES/TOWEL HOOK STRIP—FRONT MOUNT**

Wall plate 14 gauge with beveled edges, 11 gauge brackets, and four 7 gauge hooks. Stainless steel with satin finish. Hooks snap down for safety if excessively loaded. Unit has six mounting holes through back for front mounting.

**Overall Dimensions:**

18" x 5½" x 3"  
(457 x 140 x 76 mm)



**129**

**CLOTHES/TOWEL HOOK STRIP—FRONT MOUNT**

Fabricated of 14 gauge stainless steel with satin finish. Hooks snap down for safety if excessively loaded. Six holes through back for front mounting.

**Overall Dimensions:**

18" x 5½" x 2¼"  
(457 x 140 x 57 mm)



**140**

**RECESSED SOAP DISH—REAR MOUNT**

Soap dish 16 gauge stainless steel with satin finish. One-piece drawn construction with beveled trim and embossments for air circulation and drainage. Unit has two "T" nuts welded on back for rear mounting.

**Overall Dimensions:**

7¾" x 6" x 3"  
(187 x 152 x 76 mm)

**Wall Opening:**

6½" x 5 x 3" min  
(165 x 127 x 76 mm)



**130**

**RECESSED SHELF—REAR MOUNT**

Shelf 16 gauge type 304 stainless steel, corners welded, and ground smooth. 1" (25 mm) wide beveled satin finish trim. Interior glass blasted finish. Unit has four studs welded on back for rear mounting.

**Overall Dimensions:**

18" x 7" x 4"  
(457 x 178 x 102 mm)

**Wall Opening:**

5½" x 16½"  
(141 x 419 mm)



## Waste Receptacles

ASI offers a wide range of waste receptacles available in fully recessed, semi-recessed, surface mounted, counter mounted, and freestanding with various capacities. Type 304 Stainless Steel fabrication with fully removable waste cans allows contents to be easily discarded for efficient ongoing maintenance and cleanliness.

SHOWN: 20458 ROVAL™ SEMI-RECESSED REMOVABLE WASTE RECEPTACLE



**1000**  
**TRADITIONAL™ CIRCULAR  
 COUNTER TOP WASTE CHUTE**

Provides waste deposit access to receptacle (not furnished) placed directly below chute; made of heavy gauge stainless steel with rolled flange and exposed surfaces that have satin finish.

**MODEL OPTION:**  
**1000A** has a 9" (229 mm) outside diameter with a counter opening of 8 5/8" (206 mm) diameter.

**Unit Size:** 6 3/4" (171 mm) outside diameter  
**Counter Opening:** 5 3/4" (146 mm) diameter



**1003**  
**TRADITIONAL™ COUNTER TOP  
 MOUNTED WASTE RECEPTACLE**

Push door is self-closing. A 12" x 12" x 12" (305 x 305 x 305 mm) waste receptacle is furnished to be placed directly below waste door on the vanity floor.

**Unit Size:**  
 14 1/4" x 10" x 3/32"  
 (362 x 254 x 2 mm)

**Counter Opening:**  
 8 3/4" x 12 1/2"  
 (222 x 318 mm)



**0815**  
**FLOOR STANDING FOOT  
 OPERATED WASTE RECEPTACLE**

Foot operated waste receptacle with satin finish stainless steel body and top. Connected with multi-staked piano hinge and features hemmed edges for safety. Capacity: 8 gal. (30.7 L).

**Overall Dimensions:**  
 10 3/4" x 20 15/16" x 10"  
 (273 x 531 x 254 mm)



**0834-RB**  
**FREESTANDING 3-BIN RECYCLING STATION**

Freestanding 3-Bin Recycling Station constructed of an 18 gauge unified top and individual 22 gauge bins all of stainless steel. Bottoms of each receptacle are equipped with four (4) non-skid rubber feet. Top has shape-coordinated openings and permanent labels "TRASH," "BOTTLES," and "PAPER." Capacity: 42 gal. (159 L).

**MODEL OPTION:**  
**0839-RB** has 57 gal. (216 L) capacity with 37 $\frac{1}{8}$ " x 31 $\frac{1}{8}$ " x 12 $\frac{1}{2}$ " (943 x 810 x 318 mm).

**Overall Dimensions:**  
37 $\frac{1}{8}$ " x 31 $\frac{1}{8}$ " x 12 $\frac{1}{2}$ "  
(943 x 810 x 318 mm)



**NEW**

**0834-TWH**  
**FREESTANDING STAINLESS STEEL SANITIZER WIPES DISPENSER AND DISPOSAL STATION**

Sanitizer wipes dispenser station constructed of satin finish stainless steel, with 18 gauge top and 22 gauge bin. Holds one standard 9" DIA x 9" tall sanitizer wipes container (by others). Receptacle with top on holds 12 gallons (45L) of waste, and bottom is equipped with four (4) non-skid rubber feet.

**MODEL OPTION:**  
**0839-TWH** has 17 gal. (64 L) capacity with 12 $\frac{3}{8}$ " x 31 $\frac{1}{16}$ " x 12 $\frac{1}{2}$ " (314 x 805 x 318 mm) dimensions.

**Overall Dimensions:**  
12 $\frac{3}{8}$ " x 24 $\frac{3}{16}$ " x 12 $\frac{1}{2}$ "  
(314 x 614 x 318 mm)



**NEW**



**0834**  
**TRADITIONAL™ FREESTANDING WASTE RECEPTACLE**

Fabricated of 22 gauge stainless steel; holds 14 gallons (54 L) of waste. Top is removable for easy maintenance, and bottom is equipped with four (4) non-skid rubber feet.

**MODEL OPTION:**  
**0839** has 19 gal. (72 L) capacity with 12 $\frac{3}{8}$ " x 32" x 12 $\frac{1}{2}$ " (314 x 800 x 318 mm) dimensions.

**Overall Dimensions:**  
12 $\frac{3}{8}$ " x 24" x 12 $\frac{1}{2}$ "  
(314 x 609 x 318 mm)



**NEW**



**0834-T**  
**TRADITIONAL™ FREESTANDING WASTE RECEPTACLE WITH DUAL SWING TOP**

Fabricated of 22 gauge stainless steel; holds 14 gallons (54 L) of waste. Top has dual swing door and is removable for easy maintenance. Bottom is equipped with four (4) non-skid rubber feet.

**MODEL OPTION:**  
**0839-T** has 19 gal. (72 L) capacity with 12 $\frac{3}{8}$ " x 37 $\frac{1}{4}$ " x 12 $\frac{1}{2}$ " (314 x 946 x 318 mm) dimensions.

**Overall Dimensions:**  
12 $\frac{3}{8}$ " x 29 $\frac{3}{4}$ " x 12 $\frac{1}{2}$ "  
(314 x 756 x 318 mm)



**0458**  
**TRADITIONAL™ SEMI-RECESSED WASTE RECEPTACLE**

Stainless steel waste container locks into cabinet, removable for servicing. Fabricated of 22 gauge stainless steel.

**MODEL OPTION:**  
**0458-9** Surface mounted with a stainless steel collar.

**Unit Size:** 17 $\frac{1}{4}$ " x 30 $\frac{1}{2}$ " x 8 $\frac{1}{4}$ " (438 x 775 x 210 mm)  
**Wall Opening:** 15 $\frac{3}{4}$ " x 29" x (variable)" (400 x 737 mm)

[0458 if 4" (102 mm) x 4" and 12 gals. (46 L); 0458-CX if 1/2" (13 mm) x 7 $\frac{1}{2}$ " (191 mm) and 12 gals. (46 L); 0458-DX if 8" (203 mm) x 4" (102 mm) and 18 gals. (68 L)]



**7317**  
**COVERED WASTE RECEPTACLE**

Freestanding covered garbage can. Lid opens by depressing foot pedal. Plastic pail with wire bail included. Bright finish stainless steel. Capacity: 2 gal. (7.6 L).

**MODEL OPTION:**  
**7317-S** Satin stainless steel finish.

**Overall Dimensions:**  
8 $\frac{9}{32}$ " DIA x 12 $\frac{3}{4}$ "  
(210 DIA x 324 mm)





**0829**  
**CORNER WASTE RECEPTACLE**

Fabricated of 22 gauge stainless steel with hemmed top and bottom edges for safety; capacity of 16 gal. (60 L) of waste.

**Overall Dimensions:**  
15" x 23" x 14½"  
(381 x 584 x 368 mm)



**20826**  
**ROVAL™ SURFACE MOUNTED WASTE RECEPTACLE**

Receptacle front and sides fabricated of 20 gauge stainless steel with satin finish. 12.8 gal. (48.4 L) waste capacity.

**MODEL OPTION:**  
**20826-T** Closed top, spring-loaded door. Capacity 12.8 gal. (48.4 L).

**Overall Dimensions:**  
15½" x 23" x 8½"  
(384 x 584 x 216 mm)



**20458**  
**ROVAL™ SEMI-RECESSED REMOVABLE WASTE RECEPTACLE**

Easy maintenance—removable 20 gauge stainless steel waste receptacle locks into cabinet with a tumbler lock for security. Capacity 11.2 gal. (42.6 L). Frame and cabinet fabricated of 22 gauge stainless steel with satin finish.

**Unit Size:**  
17⅝" x 27¼" x 8⅞"  
(441 x 705 x 227 mm)

**Wall Opening:**  
15¾" x 26" x 3⅞"  
(400 x 660 x 100 mm)



**0825**  
**TRADITIONAL™ SURFACE MOUNTED WASTE RECEPTACLE**

Fabricated of 22 gauge stainless steel; holds 17 gal. (64 L) with top and bottom hemmed edges; interior hooks for liner.

**MODEL OPTION:**  
**0826** has 12 gal. (45.4 L) capacity with 15¼" x 23" x 8" (387 x 584 x 203 mm) dimensions.

**Overall Dimensions:**  
15¾" x 21⅞" x 11¼"  
(400 x 556 x 298 mm)



**0827**  
**TRADITIONAL™ SURFACE MOUNTED WASTE RECEPTACLE**

Fabricated of 22 gauge stainless steel with hemmed top and bottom edges for safety; capacity of 2 gal. (7.6 L) of waste.

**Overall Dimensions:**  
10½" x 9" x 4¾"  
(267 x 229 x 121 mm)



**0828**  
**TRADITIONAL™ SURFACE MOUNTED WASTE RECEPTACLE**

Fabricated of 22 gauge stainless steel with hemmed top and bottom edges for safety; holds 6.5 gal. (24.8 L) of waste.

**Overall Dimensions:**  
14" x 18" x 6"  
(356 x 457 x 152 mm)

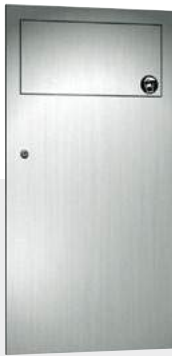

**6459**  
**SIMPLICITY™ RECESSED WASTE RECEPTACLE**

Stainless steel waste receptacle holds 4 gal. (15 L) of waste and has a self-closing panel that covers its opening. 18 gauge stainless steel door.

**Unit Size:**  
14¼" x 28" x 4½"  
(362 x 711 x 114 mm)

**Wall Opening:**  
12¾" x 26½" x 4¼"  
(324 x 673 x 108 mm)



**6474**  
**SIMPLICITY™ RECESSED WASTE RECEPTACLE**

Stainless steel waste receptacle holds 12 gal. (46 L) of washroom waste materials. 18 gauge stainless steel door.

**MODEL OPTIONS:**  
**NEW 6474-41PC** Matte Black  
**6474-2** Semi-recessed with a stainless steel collar.  
**NEW 6474-2-41PC** Matte Black.

**Unit Size:**  
17¼" x 40" x 6¾"  
(438 x 1016 x 171 mm)

**Wall Opening:**  
15¾" x 38½" x 6¼"  
(400 x 978 x 159 mm)



**6474-00**  
**SIMPLICITY™ RECESSED WASTE RECEPTACLE**

Stainless steel waste receptacle holds 12 gal. (46 L) of washroom waste materials. 18 gauge stainless steel door.

**MODEL OPTION:**  
**6474-2** Semi-recessed with a stainless steel collar.

**Unit Size:**  
17¼" x 40" x 6¾"  
(438 x 1016 x 166 mm)

**Finished Wall Opening\*:**  
17⅞" x 40⅞" x 6⅞"  
(440 x 1018 x 170 mm)



**04733**  
**TRADITIONAL™ RECESSED WASTE RECEPTACLE**

Self-closing panel covers the receptacle opening, removable 3 gal. (11.4 L) stainless steel waste receptacle. Fabricated of 22 gauge stainless steel.

**Unit Size:** 14¼" x 28" x 4½"  
(362 x 711 x 114 mm)

**Wall Opening:** 12¾" x 26½" x 4"  
(324 x 673 x 102 mm)



**9459**  
**PROFILE™ RECESSED WASTE RECEPTACLE**

Stainless steel waste receptacle holds 4 gal. (15 L) of waste and has a self-closing panel that covers its opening. 16 gauge stainless steel door.

**Unit Size:**  
14¼" x 28" x 4⅞"  
(362 x 711 x 125 mm)

**Wall Opening:**  
12¾" x 26½" x 4¼"  
(324 x 673 x 108 mm)



**9474**  
**PROFILE™ RECESSED WASTE RECEPTACLE**

Stainless steel waste receptacle holds 12 gal. (45.4 L) of washroom waste materials. 16 gauge stainless steel door.

**Unit Size:**  
17¼" x 40" x 7⅞"  
(438 x 1016 x 183 mm)

**Wall Opening:**  
15¾" x 38½" x 6¼"  
(400 x 978 x 159 mm)

## WHO WE ARE

Only ASI Group designs, engineers, and manufactures fully integrated washroom accessories, partitions, lockers, and visual display products from one source.

The ASI Group is known for innovative products, speed to market, and the widest offering of materials and products

in the industry. Our family of companies work together with one mission in mind—“To make our customers successful by providing value that exceeds price and an excellent service experience.”



1

### Port House

Architect: Zaha Hadid Architects  
ASI Alpaco™ Partitions



2

### Perimeter College

Architect: Teeple Architects  
ASI Visual Display Products







**WE ARE LASER FOCUSED ON DELIVERING EXACTLY WHAT YOU NEED—  
WHERE AND WHEN YOU NEED IT.**

With operating units and offices in the USA, Canada, Australia, Belgium, UK, Middle East, and Mexico, along with sales in more than 50 countries, our ability to serve is not limited by geography.

Our broad scope helps meet the needs of healthcare, education, office, and retail buildings, as well as airports, stadiums, government offices, cultural centers, and hotel/restaurant operations.

**SALES IN OVER 50 COUNTRIES**

**385+** DOMESTIC AND INTERNATIONAL SALES REPRESENTATIVES

**1,000+** HIGHLY SKILLED EMPLOYEES

**>1.3** MILLION SQ. FT. MANUFACTURING & OFFICE FACILITIES



2



3



4

**3** **New York-Presbyterian David H. Koch Center**  
Architect: HOK Architects  
HDPE Plastic Z lockers,  
Phenolic Z lockers,  
Metal Z lockers, and  
Stainless Steel Accessories  
and Partitions



**4** **U.S. Bank Stadium**  
Architect: HKS  
Washroom Accessories and  
Solid Plastic Partitions



# INDEX OF PRODUCTS BY CATEGORY

For additional product suffix options use the index by model number on page 128-129.

## BABY CHANGING STATIONS

Model	Page
9012	99
9013	28/96/99
9013-9	28/99
9014	98
9015	98
9016	99
9017	98
9017-9	98
9018	98
9018-9	98
9020	99

## CUSTODIAL ACCESSORIES

Model	Page
0533-1	103/106
0533-2	103/106
0533-3	103/106
0533-4	103/106
0533 SERIES	103/106
1306	103
1307-3	102
1307-4	102
1307-5	102
1307-6	102
1308-3	102
1308-4	102
1315-3	103
1315-4	103
1315-6	103
8215-3	103
8215-4	103
8215-5	103

## FEMININE HYGIENE VENDORS AND DISPOSALS

Model	Page
0464	77
0468	77/78
0468-2	78
04684	78
0472	79
0472-1	79
0473	79
0473-1	79
0473-A	79
0473-1A	79
0852	79
0864	77
20470	26/79
204684	26/78
204684-9	26/78
20852	26/79
6468	43/77
64684	43/77
6471	43/78
9468	34
94684	34
9471	35/78

## GRAB BARS

Model	Page
3400/3500	90
3700/3800	90

3700-W	90
3800-AW	90/108
3800-W	90
3800-41	90
3801-41	17
3801-18-41	17/90
3801-24-41	17/90
3801-36-41	17/90
3801-42-41	17/90
3801-18AW	90/108
3801-24AW	90/108
3801-36AW	90/108
3801-42AW	90/108
3801-48AW	90/108
3802-48AW	90/108
3874	91
3874-M2337	91

## HAND DRYERS

Model	Page
0135	40/58
0165	58
0184	59
0185	59
0192	57
0196-00	17/54/55/57
0196-41	17/54/55/57
0196-93	54/55/57
0197	57
0198-93	58
0198-MH	40/58/109/116
0199-93	57
0661-1	20/56/67/75
0661-2	20/56/67/75
0663-1	20/56/67/75
0663-2	20/56/67/75
20199	29/59
20200	59/29
64672	39
64672-1	12/39/56
64672-2	12/39/56
64672-41PC	15/39

## HEALTHCARE ACCESSORIES

Model	Page
0198-MH	40/59/109/116
0349	107
0350	107
0501-X	109
0501-1	71/109
0501-2	109
0501-3	109
0501-4	104/109
0503	82/108
0504	82/108
0511	109
0512	109
0515	109
0533-1	103/106
0533-2	103/106
0533-3	103/106
0533-4	103/106
0533 SERIES	103/106
0546	107
0547	107
0548	108
0548-9	108

0551	109
0556	109
0557	109
0558-1	109
0559	109
0815	108/120
0952	106
0952-B	106
0953	106
3800-AW	90/108
3801-18AW	90/108
3801-24AW	90/108
3801-36AW	90/108
3801-42AW	90/108
3801-48AW	90/108
3802-48AW	90/108
8154	106
8155	106
8156	106
8338	107
8339	107
8340	107

## HOSPITALITY ACCESSORIES

Model	Page
0259-SS	83/115
0640	73/74/113
0641	73/74/113
0712	81/114
1201-A	92/93/115
1201-B	93/115
7306	115
7307-18	115
7307-24	115
7308	112
7312	112
7313	112
7314	112
7314-H	113
7315-H	113
7316	113
7317	112/121
7317-S	112/121
7322	114
7381	114
7383	110/114
7387	114
7388	114

## MIRRORS

Model	Page
0535	72/74
0537	74
0600	73/74
0600-T	73/74
0600-1836-41	16
0600-2436-41	16
0600-41	16/73
0605	72/74
0620	72/74
0625	72/74
0640	73/74/113
0641	73/74/113
0661-1	20/56/67/75
0661-2	20/56/67/75
0661-T	18/20/67/75
0661-FM-14	20/76

0661-FM-23	20/76
0663-1	21/56/67/75
0663-2	21/56/67/75
0663-T	21/67/75
20650	29/72/73/74
20650-B	74
20655	29/73/74
20655-B	74
8026	72/74
8287	73

## PAPER TOWEL DISPENSERS

Model	Page
0210	51
0210-41	14/15/51
0215	51
0245-SS	51
0439	51
0452	50
0452-9	50
0457	50
0457-9	50
045210A	50
1002	53
20210	27
20452	27
204523A	27
6452	42
6452-9	42
645210	41
645210A	13/41
645210AC	13
645224	42
6457	12/42
6457-00	12
6457-41	12
68523A	43
68523A-4	43
68523AC	43
68523AC-4	43
8165	51
8522	51
8523A	51
8523AC	51
9452	34
9457	34

## PAPER TOWEL DISPENSERS & WASTE RECEPTACLES

Model	Page
0462-AD	46
0462-AD-9	46
0467	48
0467-2	48
0467-9	48
0469	44/46
0469-2	46
0469-9	46
0469-BL	46
04692	47
04692A	47
046921	49
046921A	49
046924	49
046924-9	49
046926	48

04697	47
04697-4	47
04697-9	47
04697-BL	47
1001	53
204623	24
204623-9	24
20469	22/24
20469-9	24
204692A	25
2046921A	25
645210A	13/41
645210A-00	13
645210A-41	13
645210AC	13
645210AC-00	13
645210AC-41	13
6462	13/38
6462-00	13
6462-41	10/13
6462-2	38
6462-9	38
64623	13/40
64623-00	13
64623-41	13
64623-9	40
64623-41PC	15/40
64623-9-41	13
64623-9-41PC	15/40
6467	13/36/38
6467-00	13
6467-41PC	15/38
6467-9	38
6467-9-41	38
6467-9-41PC	15/38
64672	39
64672-41PC	15/39
64672-1	12/39/56
64672-1-00	12/56
64672-1-41	12/56
64672-2	12/39/56
64672-2-00	12/56
64672-2-41	12/56
64676	38
64676-2	38
64676-9	38
646924A	39
64696	41
64696-6	41
64696-9	41
64696A	12/41
64696A-00	12
64696A-41	12
64696AC	12/41
64696AC-00	12
64696AC-41	12
94623	34
9467	33
94676	33
9469	30/32
94696	33
94696A	33

**SANITIZING  
(NO) TOUCH  
ACCESSORIES**

Model	Page
0334-B	63/68
0334-S	63/68
0335-B	63/68
0335-S	63/68
0360	62/69
0361	65/69/71
0362	62/69/71
0362-41	16/62/69/71
0502	71
20364	28/65/68/70/71
20365	28/65/70/71

**SECURITY  
ACCESSORIES**

Model	Page
101-14	118
105-14	118
0198-MH	40/58/109/116
110	117
110-1	117
110-13	89/117
110-A	117
120	117
123	116
127	119
128-1	116
129	119
130	119
140	119
159	117
160	117
161	117
162	117
163	117
164	117
165	117
166	117
167	117
168	117
169	117

**SHELVES**

Model	Page
0412	101
0690	100
0692	100/101
0694	100/101
0698	101
20692	29/100/101

**SHOWER/TUB  
ACCESSORIES**

Model	Page
0010	94
0398	92
0399	92
0400	92
0401	92
0410-Z	92
1200-SHU	94
1200-V	94
1201-A	92/93/115
1201-B	93/115
1204	93

1214	93
1224	93
7404-B	93
7404-S	93
7410-B	93
7410-S	93
8202	95
8203	94
8204	94
8205-L	95
8205-R	95
8206-L	95
8206-R	95
8206-SC-L	95
8206-SC-R	95
8207	94
8208-L	94
8208-R	94
8209	95
8358	94

**SOAP DISPENSERS**

Model	Page
0326	66
0332	64
0332-C	64
0332-CD	64
0332-D	64
0334-B	63/68
0334-S	63/68
0335-B	63/68
0335-S	63/68
0336	64
0336-D	64
0338	63
0339	63
0345	16/66
0345-41	16/66
0347	16/66
0347-41	16/66
0387	61
0388	61
0388-1A	61
0388-1AC	61
0389	61
0389-1A	61
0389-1AC	60/61
0349	107
0350	107
0357	66
0359	67
0360	62/69
0361	65/69/71
0362	62/69/71
0362-41	16/62/69/71
0390	61
0390-1A	61
0390-1A-41	61
0390-1AC	61
0390-1AC-41	61
0390-6-1A	61
0390-6-1A-41	61
0390-6-1AC	61
0390-6-1AC-41	61
0390-ARK	61
0390-BR	61
0390-R	61
0391-1A	61

0391-1A-41	61
0391-1AC	61
0391-1AC-41	61
0391-6-1A	61
0391-6-1A-41	61
0391-6-1AC	61
0391-6-1AC-41	61
0393-1A	61
0393-1A-41	61
0393-1AC	61
0393-1AC-41	61
0393-6-1A	61
0393-6-1A-41	61
0393-6-1AC	61
0393-6-1AC-41	61
0393-R	61
0394-1A	61
0394-1A-41	61
0394-1AC	60/61
0394-1AC-41	17/60/61
0394-6-1A	61
0394-6-1A-41	61
0394-6-1AC	61
0394-6-1AC-41	61
0397-1A	61
0397-1AC	60/61
0397-1A-41	61
0397-1AC-41	17/61/62
0661-1	20/56/67/75
0661-2	20/56/67/75
0661-T	18/20/67/75
0663-1	21/56/67/75
0663-2	21/56/67/75
0663-T	21/67/75
20333	64
20334	64
20363	28/65
20364	28/65/68/70/71
20365	28/65/70/71
5001-SS	65
9326	35
9343	28/35/66
9343-41	14/16/28/35/66

**SPECIALTY  
ACCESSORIES**

Model	Page
0002-SM	81
0002-ASM	81
0258-SS	83
0259-SS	83/115
0481	83
0481-HC	83
04813	83
04813-HC	83
0482	83
04823	83
048234	83
0483	83
04833	83
0484	83
0484-HC	83
0485	83
0486	83
0487-L	83
0487-L-9	83
0487-R	83

0487-R-9	83
0503	82/108
0504	82/108
0712	81/114
0714	80
0719	80
0721-Z	81
0735-Z	81
0740-Z	80
0745-Z	80
0751	81
0751-A	81
0755-SS	82
0755-Z	82
0760-Z	82
0785-Z	80/81
7301-B	81
7301-S	81
7310-B	82
7310-S	82
7311-B	82
7320	81
7335	81
7340	80
7340-41	17/80
7345	80
7355-24-41	17/82
7355-41	17/82
7382	81
7385	80
7385-41	17/80
8425	80

**TOILET TISSUE  
DISPENSERS**

Model	Page
0030	86
0031	86
0032	86
0039	87
0040	87
0042	87
0042-41	14/16/87
0263-1	88
0264-1	88
0266	88
0267	88
0402-Z	89
0477	89
0477-SM	89
0477-SM-41	15/89
0697-GAL	88
0705-Z	89
0710	88
0715	88
110-13	89/117
20030	27
20031	27
20477-SM	27/89
6477	43
7303	89
7305-2B	88
7305-2S	88
7305-B	88
7305-S	88
7305-41	16
7305-2-41	16
7402	87

7402-H	87
74022	87
74022-H	84/87
7403	88
7403-B	88
7403-S	88
9030	35/86
9477	35
9477-SM	35
R-002	85
R-003	85
R-005	85
R-009	85

**WASTE  
RECEPTACLES**

Model	Page
0458	50/121
0458-9	50/121
04733	50/123
0815	108/120
0825	52/122
0826	52/122
0827	52/122
0828	52/122
0829	52/122
0834	52/121
0834-RB	121
0834-T	52/121
0839	52/121
0839-RB	121
0839-T	52/121
1000	53/120
1000A	53/120
1003	53/120
20458	26/120/122
20826	26/122
20826-T	26/122
6459	42/123
64672-00	12/39/56
64672-2	12/39/56
64672-41PC	15/39
6467-9-41PC	15/38
6474	12/42/123
6474-00	12/123
6474-2	42/123
6474-41PC	15/42/123
6474-2-41PC	15/42/123
7317	112/121
7317-S	112/121
9459	34/123
94623	34

# INDEX OF PRODUCTS BY MODEL NUMBER

MODEL	PAGE	MODEL	PAGE	MODEL	PAGE	MODEL	PAGE	MODEL	PAGE
0002-SM	81	0389	61	0457	50	0484	83	0714	80
0002-ASM	81	0389-1A	61	0457-9	50	0484-HC	83	0715	88
0010	94	0389-1AC	60/61	0458	50/121	0485	83	0719	80
0030	86	0390	61	0458-9	50/121	0486	83	0721-Z	81
0031	86	0390-1A	61	0462-AD	46	0487-L	83	0735-Z	81
0032	86	0390-1A-41	61	0462-AD-9	46	0487-L-9	83	0740-Z	80
0039	87	0390-1AC	61	0464	77	0487-R	83	0745-Z	80
0040	87	0390-1AC-41	61	0467	48	0487-R-9	83	0751	81
0042	87	0390-6-1A	61	0467-2	48	0501-X	109	0751-A	81
0042-41	14/16/87	0390-6-1A-41	61	0467-9	48	0501-1	71/109	0755-SS	82
0135	40/58	0390-6-1AC	61	0468	77/78	0501-2	109	0755-Z	82
0165	58	0390-6-1AC-41	61	0468-2	78	0501-3	109	0760-Z	82
0184	59	0390-ARK	61	04684	78	0501-4	104/109	0785-Z	80/81
0185	59	0390-BR	61	0469	44/46	0502	71	0815	108/120
0192	57	0390-R	61	0469-2	46	0503	82/108	0825	52/122
0196-00	17/54/55/57	0391-1A	61	0469-9	46	0504	82/108	0826	52/122
0196-41	17/54/55/57	0391-1A-41	61	0469-BL	46	0511	109	0827	52/122
0196-93	54/55/57	0391-1AC	61	04692	47	0512	109	0828	52/122
0197	57	0391-1AC-41	61	04692-6	47	0515	109	0829	52/122
0198-93	58	0391-6-1A	61	04692-9	47	0533-1	103/106	0834	52/121
0198-MH	40/58/109/116	0391-6-1A-41	61	04692A	47	0533-2	103/106	0834-RB	121
0199-93	57	0391-6-1AC	61	04692A-6	47	0533-3	103/106	0834-T	52/121
0210	51	0391-6-1AC-41	61	04692A-9	47	0533-4	103/106	0839	52/121
0210-41	14/15/51	0393-1A	61	04692AC	47	0533 SERIES	103/106	0839-RB	121
0215	51	0393-1A-41	61	04692AC-6	47	0535	72/74	0839-T	52/121
0245-SS	51	0393-1AC	61	04692AC-9	47	0537	74	0852	79
0258-SS	83	0393-1AC-41	61	046921	49	0546	107	0864	77
0259-SS	83/115	0393-6-1A	61	046921-6	49	0547	107	0952	106
0263-1	88	0393-6-1A-41	61	046921-9	49	0548	108	0952-B	106
0264-1	88	0393-6-1AC	61	046921A	49	0548-9	108	0953	106
0266	88	0393-6-1AC-41	61	046921A-6	49	0551	109	101-14	118
0267	88	0393-R	61	046921A-9	49	0556	109	105-14	118
0326	66	0394-1A	61	046921AC	49	0557	109	107	118
0332	64	0394-1A-41	61	046921AC-6	49	0558-1	109	110	117
0332-C	64	0394-1AC	60/61	046921AC-9	49	0559	109	110-1	117
0332-CD	64	0394-1AC-41	17/60/61	046924	49	0600	73/74	110-13	89/117
0332-D	64	0394-6-1A	61	046924-9	49	0600-T	73/74	110-A	117
0334-B	63/68	0394-6-1A-41	61	046926	48	0600-1836-41	16	120	117
0334-S	63/68	0394-6-1AC	61	04697	47	0600-2436-41	16	123	116
0335-B	63/68	0394-6-1AC-41	61	04697-4	47	0600-41	16/73	127	119
0335-S	63/68	0397	62	04697-9	47	0605	72/74	128-1	116
0336	64	0397-1A	61	04697-BL	47	0620	72/74	129	119
0336-D	64	0397-1AC	60/61	0472	79	0625	72/74	130	119
0338	63	0397-1A-41	61	0472-1	79	0640	73/74/113	140	119
0339	63	0397-1AC-41	17/61/62	0473	79	0641	73/74/113	159	117
0345	16/66	0398	92	0473-1	79	0661-1	20/56/67/75	160	117
0345-41	16/66	0399	92	0473-A	79	0661-2	20/56/67/75	161	117
0347	16/66	0400	92	0473-1A	79	0661-T	18/20/67/75	162	117
0347-41	16/66	0401	92	04733	50/123	0661-FM-14	20/76	163	117
0349	107	0402-Z	89	0477	89	0661-FM-23	20/76	164	117
0350	107	0410-Z	92	0477-SM	89	0663-1	21/56/67/75	165	117
0357	66	0412	101	0477-SM-41	15/89	0663-2	21/56/67/75	166	117
0359	67	0439	51	0481	83	0663-T	21/67/75	167	117
0360	62/69	0452	50	0481-HC	83	0690	100	168	117
0361	65/69/71	0452-9	50	04813	83	0692	100/101	169	117
0362	62/69/71	045210A	50	04813-HC	83	0694	100/101	1000	53/120
0362-41	16/62/69/71	045210A-6	50	0482	83	0697-GAL	88	1000A	53/120
0387	61	045210A-9	50	04823	83	0698	101	1001	53
0388	61	045210AC	50	048234	83	0705-Z	89	1002	53
0388-1A	61	045210AC-6	50	0483	83	0710	88	1003	53/120
0388-1AC	61	045210AC-9	50	04833	83	0712	81/114	1200-SHU	94



MODEL	PAGE	MODEL	PAGE	MODEL	PAGE	MODEL	PAGE	MODEL	PAGE
1200-V	94	20852	26/79	6467-9	38	7310-B	82	8340	107
1201-A	92/93/115	3400 SERIES	90	6467-9-41PC	15/38	7310-S	82	8358	94
1201-B	93/115	3500 SERIES	90	6467-00	13	7311-B	82	8425	80
1204	93	3700 SERIES	90	6467-41	13	7312	112	8522	51
1214	93	3700-W	90	64672	39	7313	112	8523A	51
1224	93	3800 SERIES	90	64672-41PC	15/39	7314	112	8523AC	51
1306	103	3800-41	90	64672-1	12/39/56	7314-H	113	9012	99
1307-3	102	3800-AW SERIES	90/108	64672-1-00	12/56	7315-H	113	9013	28/96/99
1307-4	102	3800-W	90	64672-1-41	12/56	7316	113	9013-9	28/99
1307-5	102	3801-41	17	64672	39	7317	112/121	9014	98
1307-6	102	3801-18-41	17/90	64672-00	12/39/56	7317-S	112/121	9015	98
1308-3	102	3801-24-41	17/90	64672-2	12/39/56	7320	81	9016	99
1308-4	102	3801-36-41	17/90	64672-2-00	12/56	7322	114	9017	98
1315-3	103	3801-42-41	17/90	64672-2	12/39/56	7335	81	9017-9	98
1315-4	103	3801-18AW	90/108	64672-2-41	12/56	7340	80	9018	98
1315-6	103	3801-24AW	90/108	64676	38	7340-41	17/80	9018-9	98
20030	27	3801-36AW	90/108	64676-2	38	7345	80	9020	99
20031	27	3801-42AW	90/108	64676-9	38	7355	82	9030	35/86
20199	29/59	3801-48AW	90/108	6468	43/77	7355-24-41	17/82	9326	35
20200	29/59	3802-48AW	90/108	64684	43/77	7381	114	9343	28/35/66
20210	27	3874	91	646924A	39	7382	81	9343-41	14/16/28/35/66
20333	64	3874-M2337	91	646924A-9	39	7383	110/114	9452	34
20334	64	5001-SS	65	646924AC	39	7385	80	9457	34
20363	28/65	6452	42	646924AC-9	39	7385-41	17/80	9459	34/123
20364	28/65/68/70/71	6452-9	42	64696	41	7387	114	94623	34
20365	28/65/70/71	645210	41	64696-6	41	7388	114	9467	33
20452	27	645210A	13/41	64696-9	41	7402	87	94676	33
204523A	27	645210A-6	41	64696A	12/41	7402-H	87	9468	34
204523A-6	27	645210A-9	41	64696A-6	41	74022	87	94684	34
204523A-9	27	645210A-00	13	64696A-9	41	74022-H	84/87	9469	30/32
204523AC	27	645210A-41	13	64696A-00	12	7403	88	94696	33
204523AC-6	27	645210AC	13/41	64696A-41	12	7403-B	88	94696A	33
204523AC-9	27	645210AC-6	41	64696AC	12/41	7403-S	88	9471	35/78
20458	26/120/122	645210AC-9	41	64696AC-6	41	7404-B	93	9477	35
204623	24	645210AC-00	13	64696AC-9	41	7404-S	93	9477-SM	35
204623-9	24	645210AC-41	13	64696AC-00	12	7410-B	93	R-002	85
204684	26/78	645224	42	64696AC-41	12	7410-S	93	R-003	85
204684-9	26/78	645224-6	42	6471	43/78	8026	72/74	R-005	85
20469	22/24	645224-9	42	6474	12/42/123	8154	106	R-009	85
20469-9	24	645224A-6	42	6474-41PC	15/42/123	8155	106		
204692A	25	645224AC	42	6474-2	42/123	8156	106		
204692A-6	25	645224AC-6	42	6474-00	12/123	8165	51		
204692A-9	25	645224AC-9	42	6474-2-41PC	15/42/123	8202	95		
204692AC	25	6457	12/42	6477	43	8203	94		
204692AC-6	25	6457-00	12	68523A	43	8204	94		
204692AC-9	25	6457-41	12	68523A-4	43	8205-L	95		
2046921A	25	6459	42/123	68523AC	43	8205-R	95		
2046921A-6	25	6462	13/38	68523AC-4	43	8206-L	95		
2046921A-9	25	6462-2	38	7301-B	81	8206-R	95		
2046921AC	25	6462-9	38	7301-S	81	8206-SC-L	95		
2046921AC-6	25	6462-00	13	7303	89	8206-SC-R	95		
2046921AC-9	25	6462-41	10/13	7305-2B	88	8207	94		
20470	26/79	64623	13/40	7305-2S	88	8208-L	94		
20477-SM	27/89	64623-9	40	7305-B	88	8208-R	94		
20650	29/72/73/74	64623-00	13	7305-S	88	8209	95		
20650-B	74	64623-41	13	7305-41	16	8215-3	103		
20655	29/73/74	64623-41PC	15/40	7305-2-41	16	8215-4	103		
20655-B	74	64623-9-41PC	15/40	7306	115	8215-5	103		
20692	29/100/101	64623-9-41	13	7307-18	115	8287	73		
20826	26/122	6467	13/36/38	7307-24	115	8338	107		
20826-T	26/122	6467-41PC	15/38	7308	112	8339	107		





441 Saw Mill River Rd.  
Yonkers, NY 10701  
Phone: 914.476.9000  
Fax: 914.476.0688  
Web: [americanspecialties.com](http://americanspecialties.com)

© 2022 American Specialties, Inc., an ASI Group Company