

SINGER



Sewing Machine

285K

T H E S I N G E R C O M P A N Y

Form K6607
(465)

Printed in Great Britain

SINGER

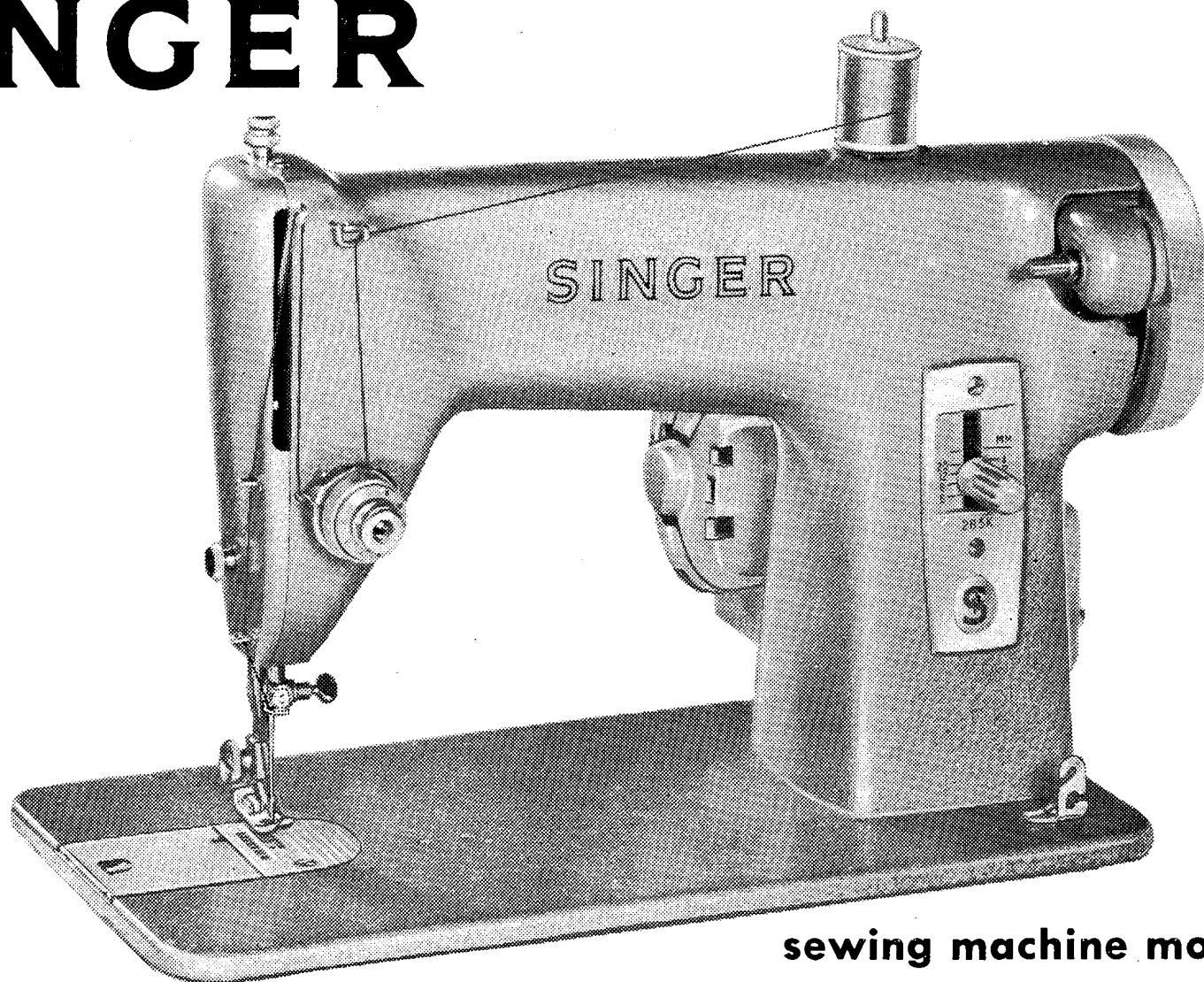

sewing machine model 285K

AS THE OWNER OF THE SINGER* 285K...

You have a modern, smooth running sewing machine which offers you a new world of sewing enjoyment. Exclusive dresses for yourself, clothing for your family, and numerous items for the home — all will be yours at a fraction of their ready-made cost.



Outstanding features include

- **“DROP-IN” BOBBIN** . . . located in front of needle.
- **SINGLE TURN TENSION** . . . calibrated for accurate adjustment.
- **REVERSIBLE FEED** . . . for back stitching and fastening seam ends.
- **THREAD CUTTER** . . . built into presser bar for added safety and convenience.



SINGER SERVICE

Wherever you go you will find expert, dependable SINGER* Service close at hand. SINGER is interested in helping you keep your SINGER Sewing Machine in top running condition. That is why you should always call your SINGER SEWING CENTER if your machine ever requires adjustment or repair. Only from your SINGER SEWING CENTER can you obtain the services of a trained SINGER repairman and warranted SINGER parts.

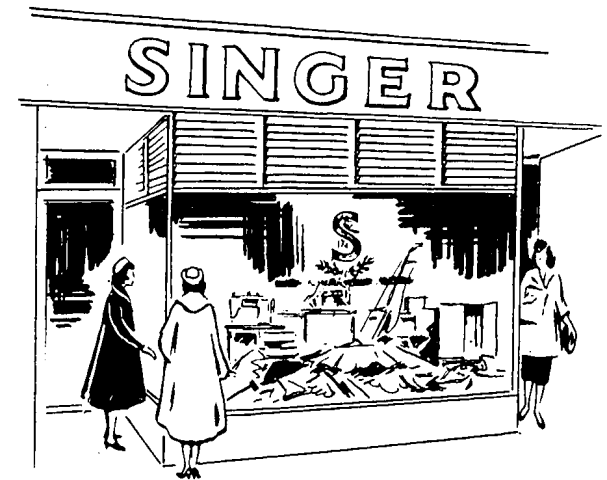

EVERYTHING FOR THE WOMAN WHO SEWS

The answer to your sewing needs is at your SINGER SEWING CENTER. There you will find a wide choice of sewing aids, notions, sewing information and services. Look for the famous red "S" and SINGER trademarks on your SINGER SEWING CENTER and the ever ready SINGER Service Van. Look under SINGER COMPANY, in phone book, for address nearest you.

PRINCIPAL PARTS OF MACHINE 285K

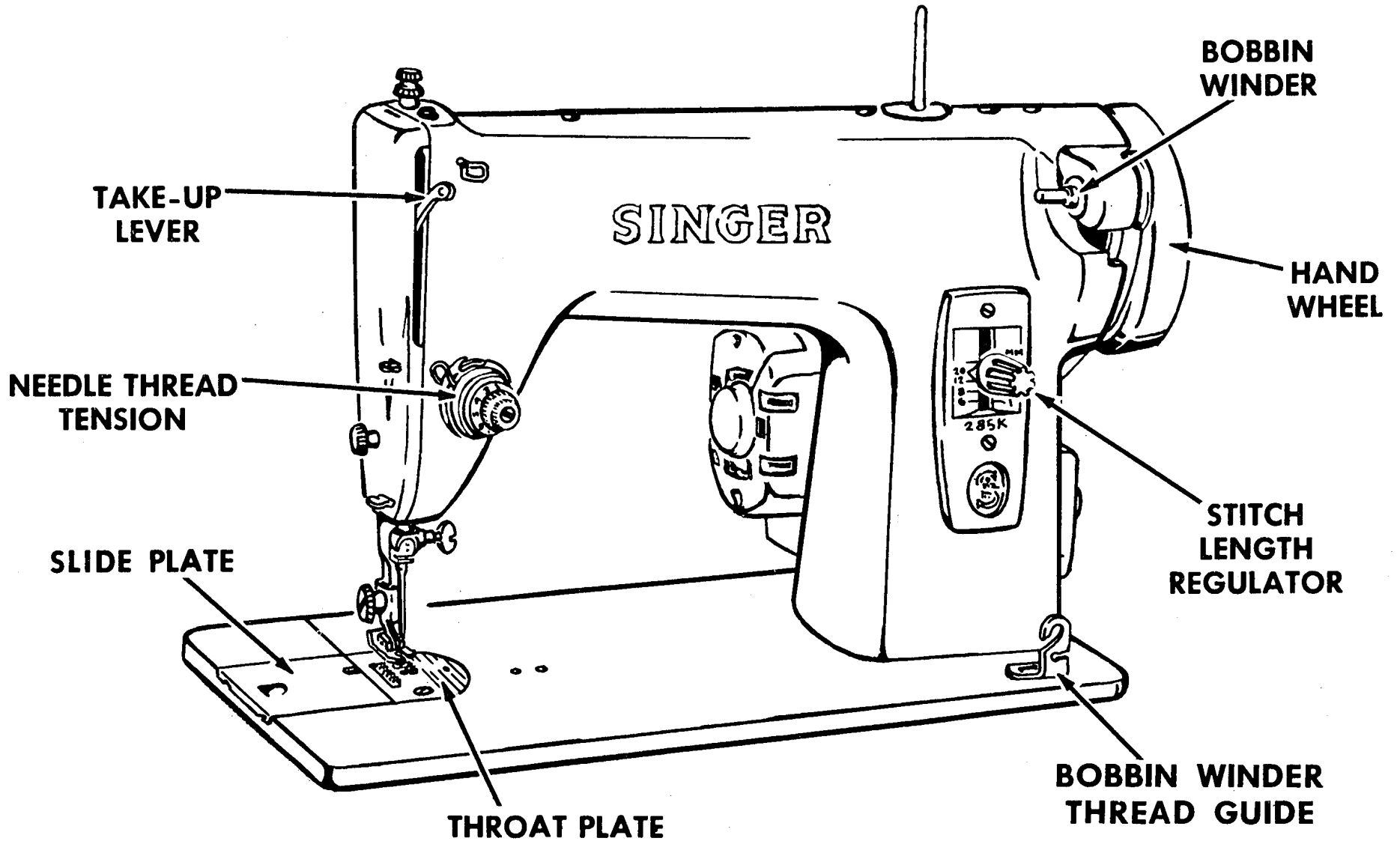

FABRIC, THREAD, NEEDLE AND STITCH LENGTH CHART

FABRICS	THREAD SIZES	NEEDLE SIZES	MACHINE STITCHES PER INCH STRAIGHT STITCHING
DELICATE —tulle, chiffon, fine lace, silk organdy, fine tricot	Fine Mercerized 100 to 150 Cotton Synthetic Thread	9	15 to 20
LIGHTWEIGHT —batiste, organdy, jersey, voile, taffeta, silk crepe, plastic film	50 Mercerized 80 to 100 Cotton A Silk Synthetic Thread	11	12 to 15 (8 to 10 for plastic)
MEDIUM WEIGHT —gingham, percale, pique, linen, chintz, faille, satin, fine corduroy, suitings	50 Mercerized 60 to 80 Cotton A Silk Synthetic Thread	14	12 to 15
MEDIUM HEAVY —gabardine, tweed, sail-cloth, denim, coatings, drapery fabrics	Heavy Duty Merc. 40 to 60 Cotton	16	10 to 12
HEAVY —overcoatings, dungaree, upholstery fabrics, canvas	Heavy Duty Merc. 24 to 40 Cotton	18	8 to 10

NEEDLES AND THREAD

This machine uses needle
Catalogue 2020 (15 x 1)
Sizes 9, 11, 14, 16 and 18.

For perfect stitching, select correct needle and thread to correspond with fabric. Be sure to use like threads for both needle and bobbin.

NEEDLE INSERTION

- Raise needle bar to highest point by turning hand wheel toward you.
- Loosen needle clamp screw.
- Insert needle upward into clamp as far as it will go, with flat side of needle toward right and **long groove toward left**.
- Tighten needle clamp screw.

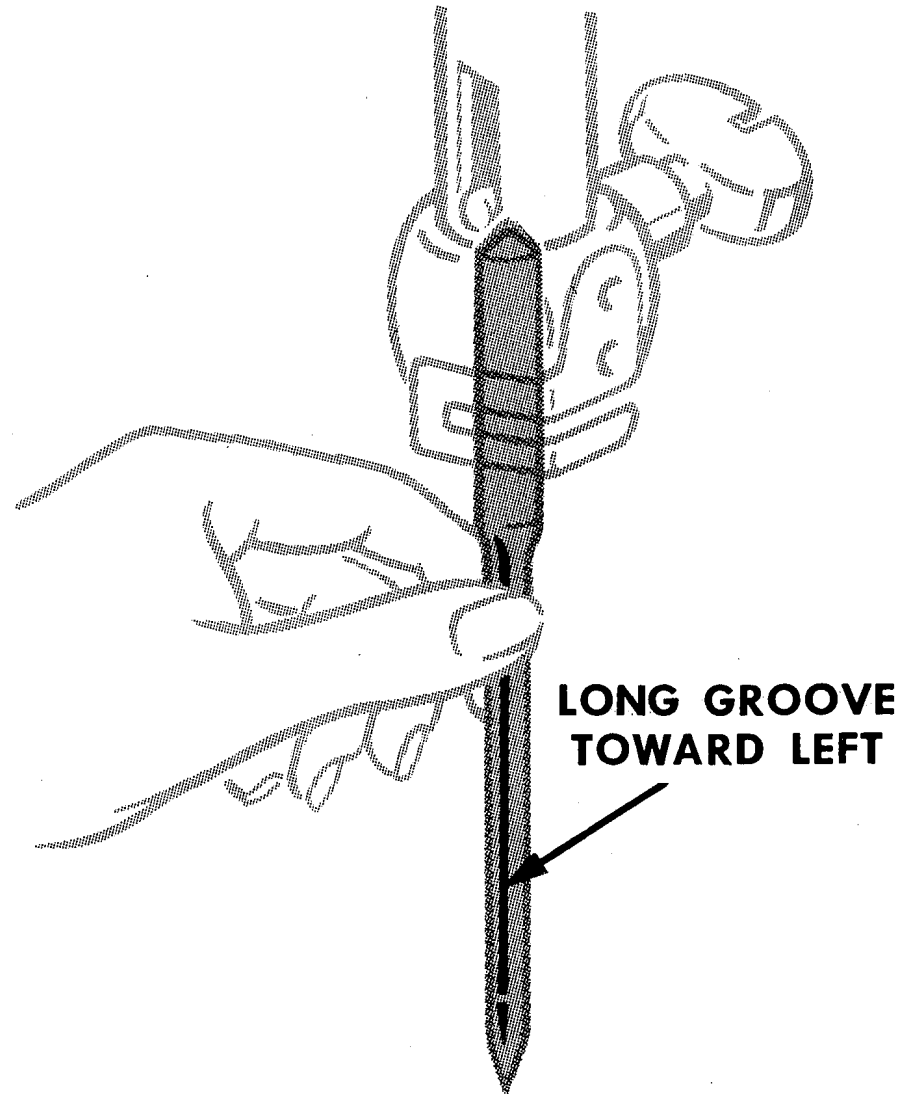

7

REMOVING THE BOBBIN

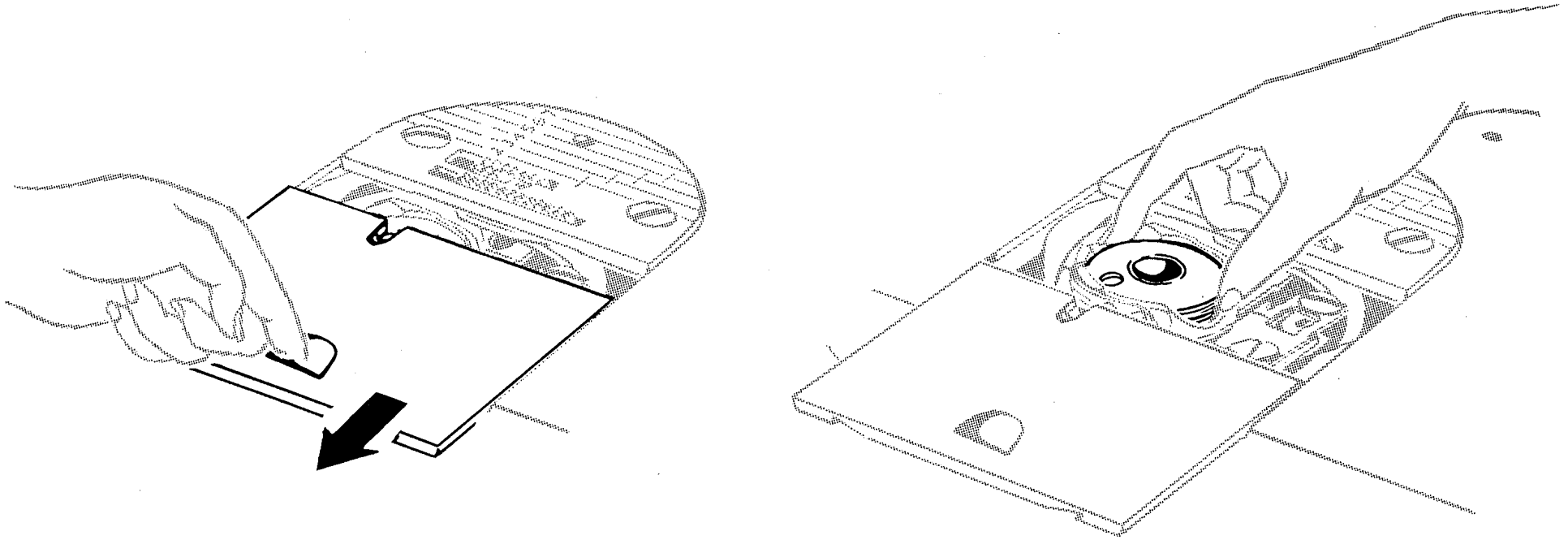

Open slide plate and lift out bobbin.

WINDING THE BOBBIN

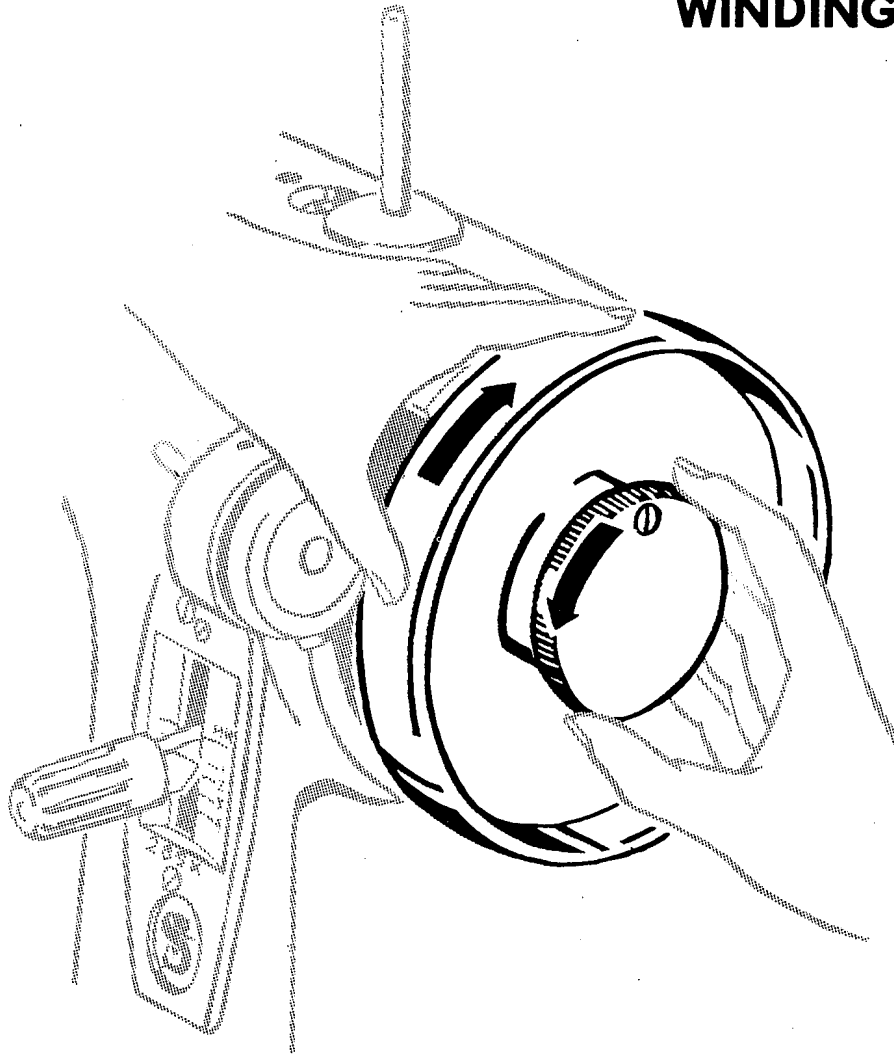

- Loosen stop motion screw with right hand.

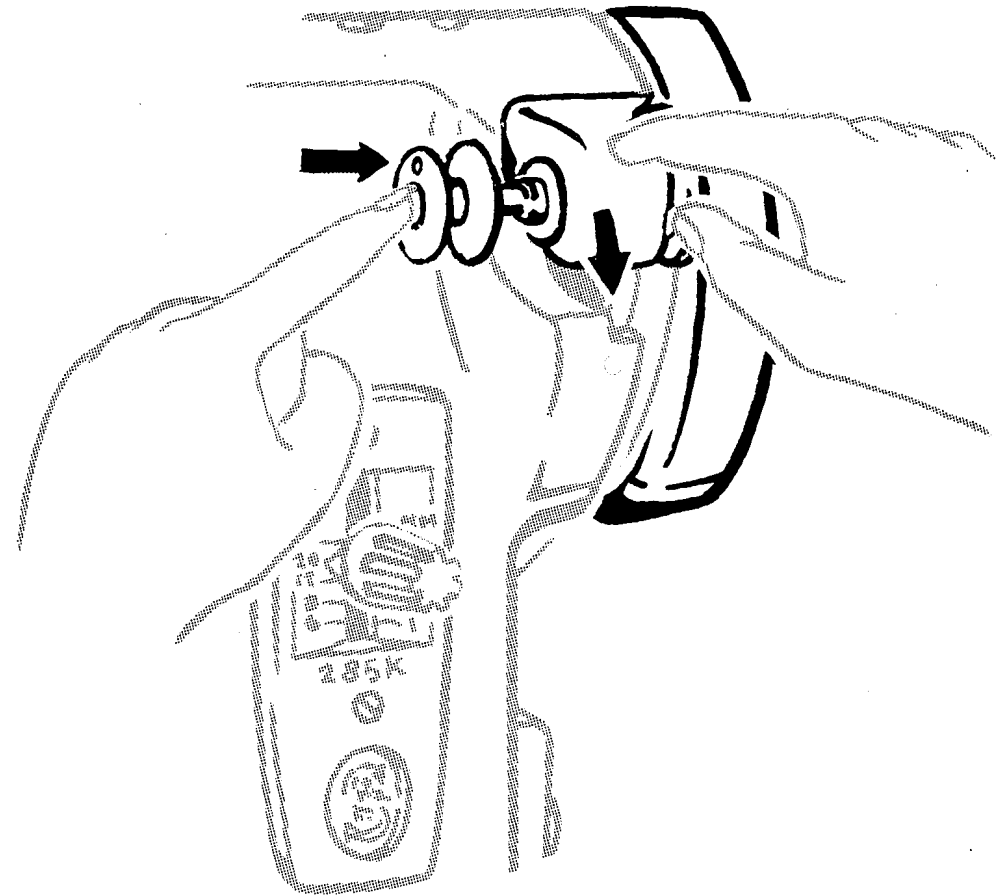

- Place empty bobbin on spindle.
- Press bobbin winder down against hand wheel.

WINDING THE BOBBIN (Cont'd)

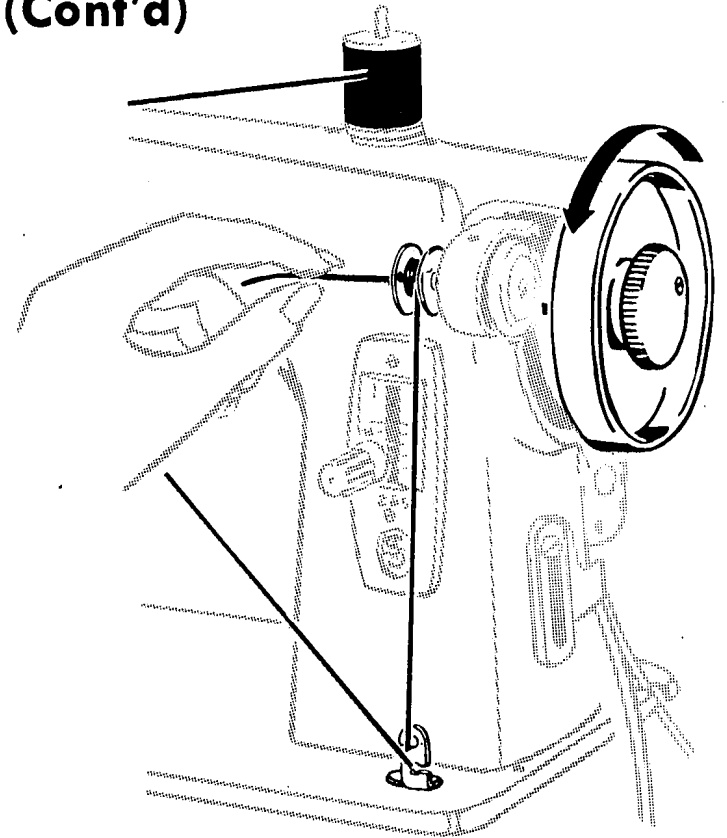
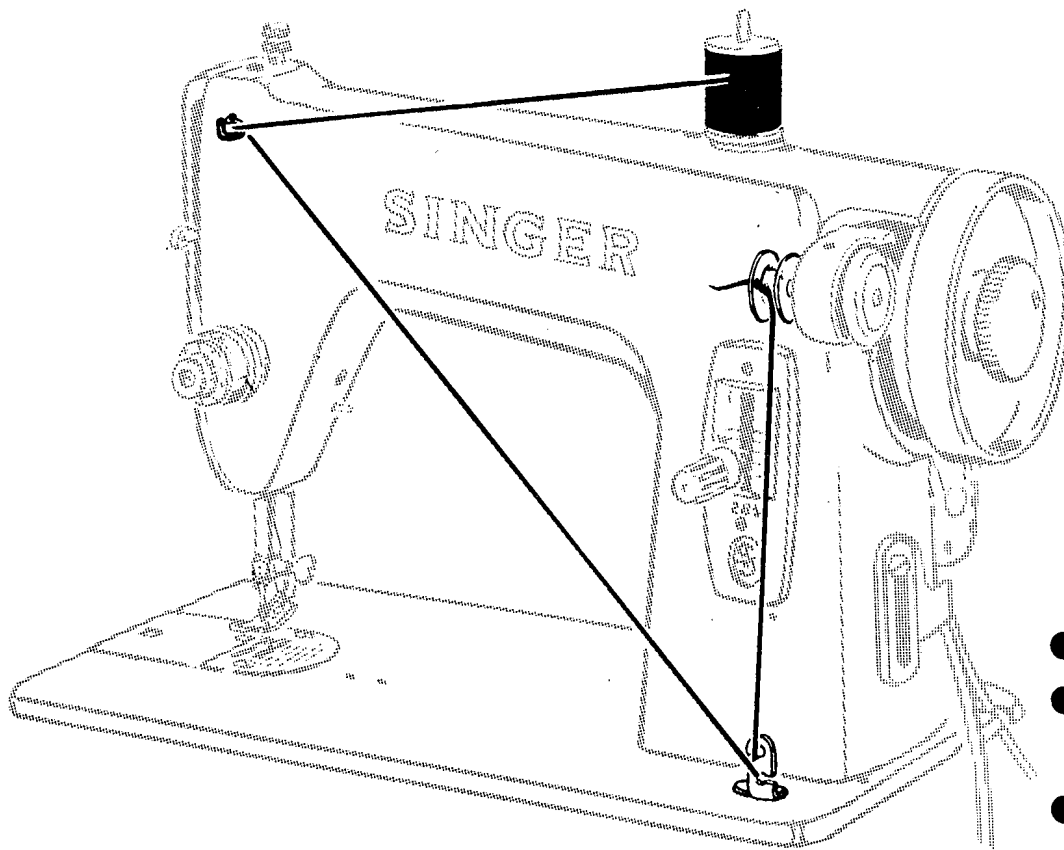

- Place spool of thread on spool pin.
- Thread between thread guides and through bobbin as shown.
- Hold end of thread and start machine. (Cut end of thread off after a few coils have been wound on bobbin.)

WINDING THE BOBBIN (Cont'd)

When bobbin is full

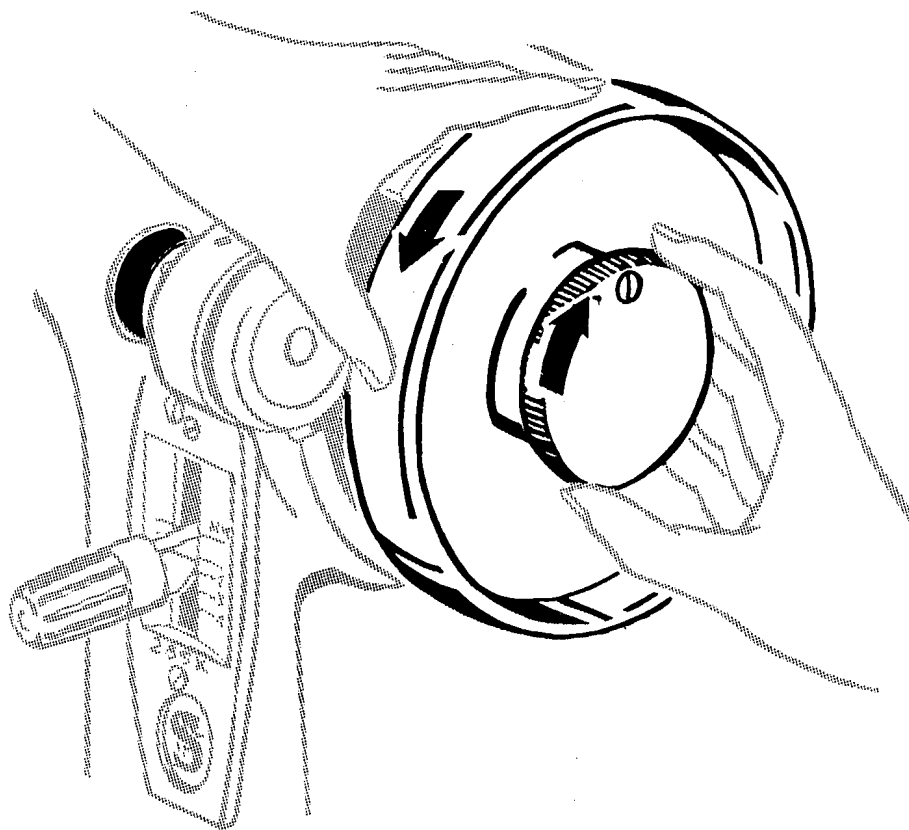

- Stop machine.
- Lift bobbin winder away from hand wheel and remove bobbin.
- Tighten stop motion screw.

If thread doesn't wind evenly

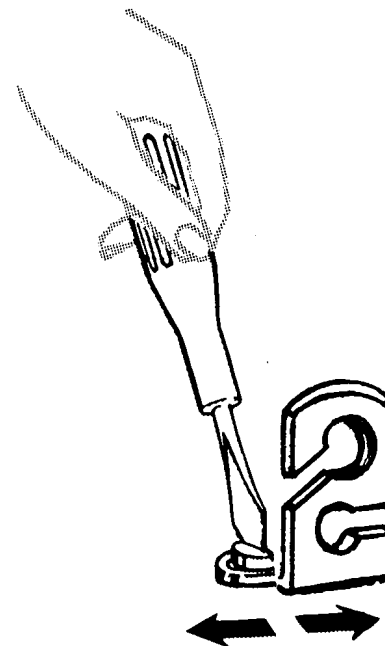

- Loosen screw which holds bobbin winder thread guide to machine bed.
- Move thread guide to left if bobbin winds high on right; move to right if bobbin winds high on left.
- Tighten thread guide screw.

THREADING THE BOBBIN CASE

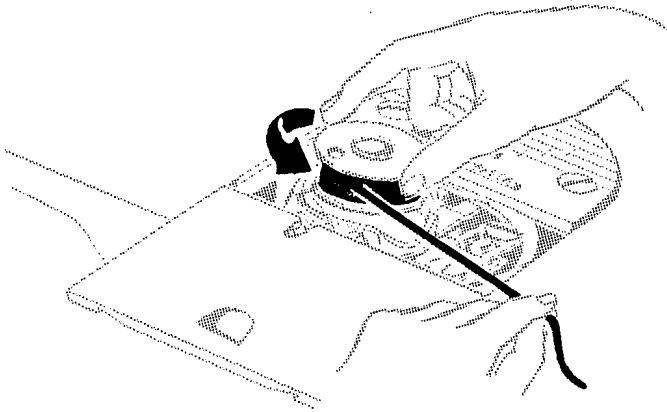

- Hold bobbin so that thread leads off in direction shown.

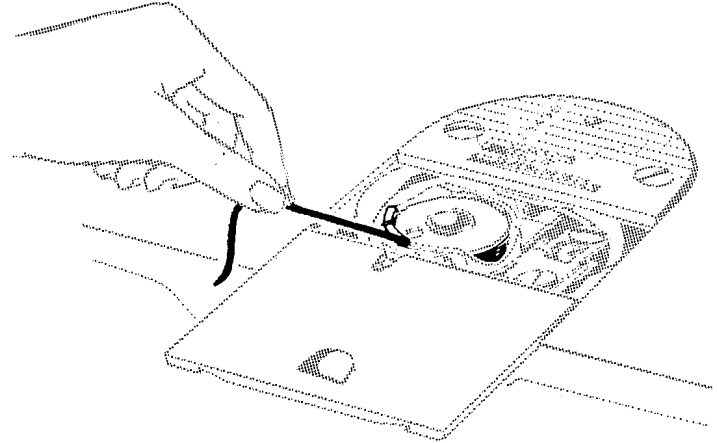

- Place bobbin in case.
- Lead thread into slot and under spring.

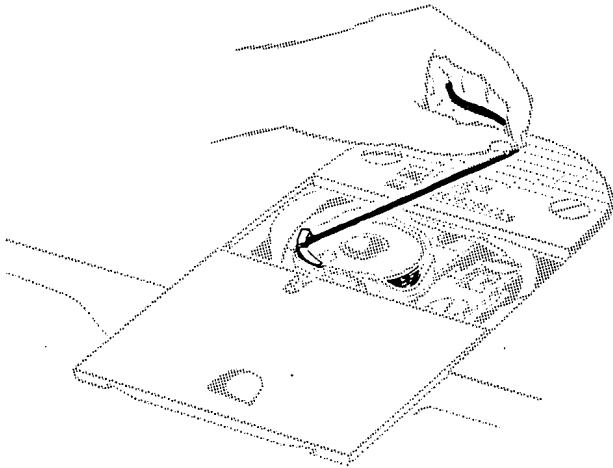

- Draw thread into notch at end of spring; pull about 3 inches of thread across bobbin.

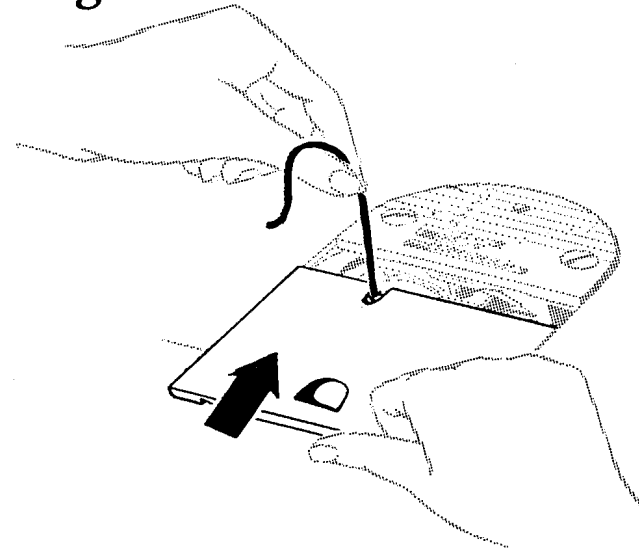

- Close slide plate.

UPPER THREADING

- Raise take-up lever to highest point.
- Lead thread through threading points shown.
- Draw sufficient thread through eye of needle with which to start sewing.

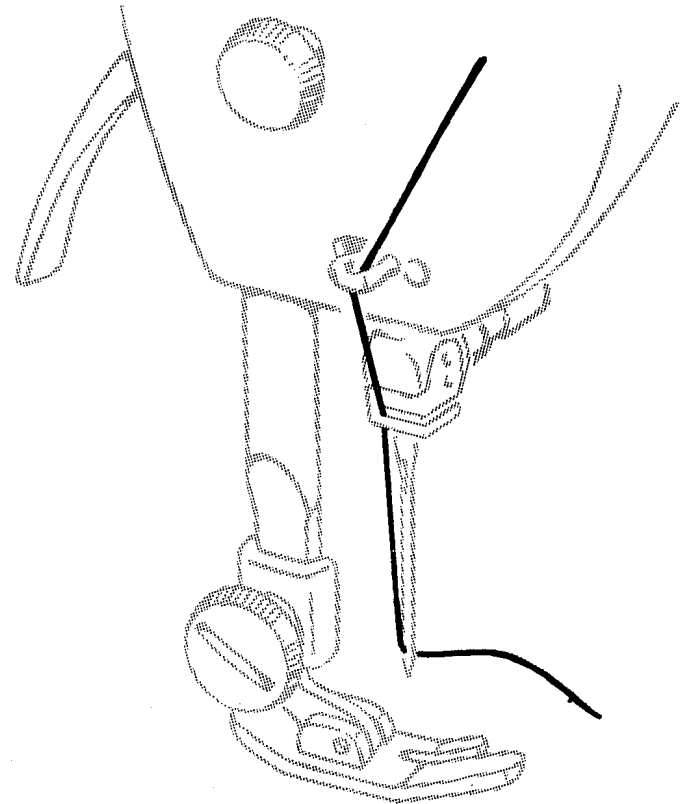
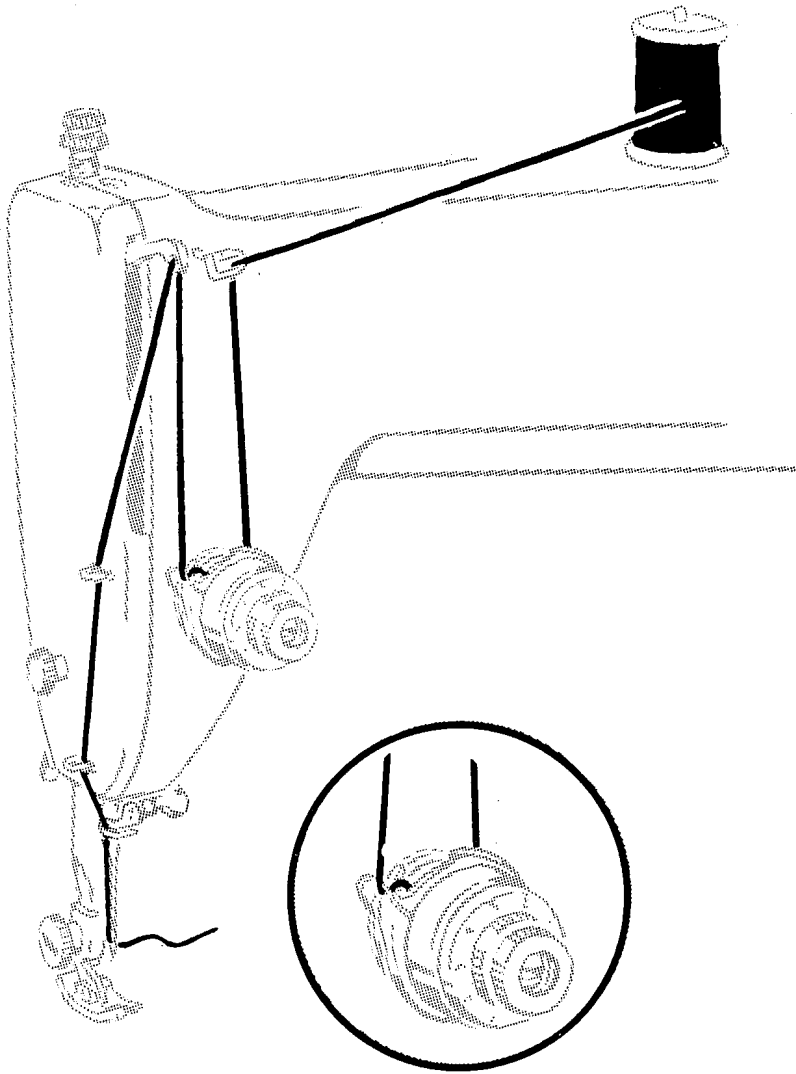

STITCH LENGTH REGULATOR

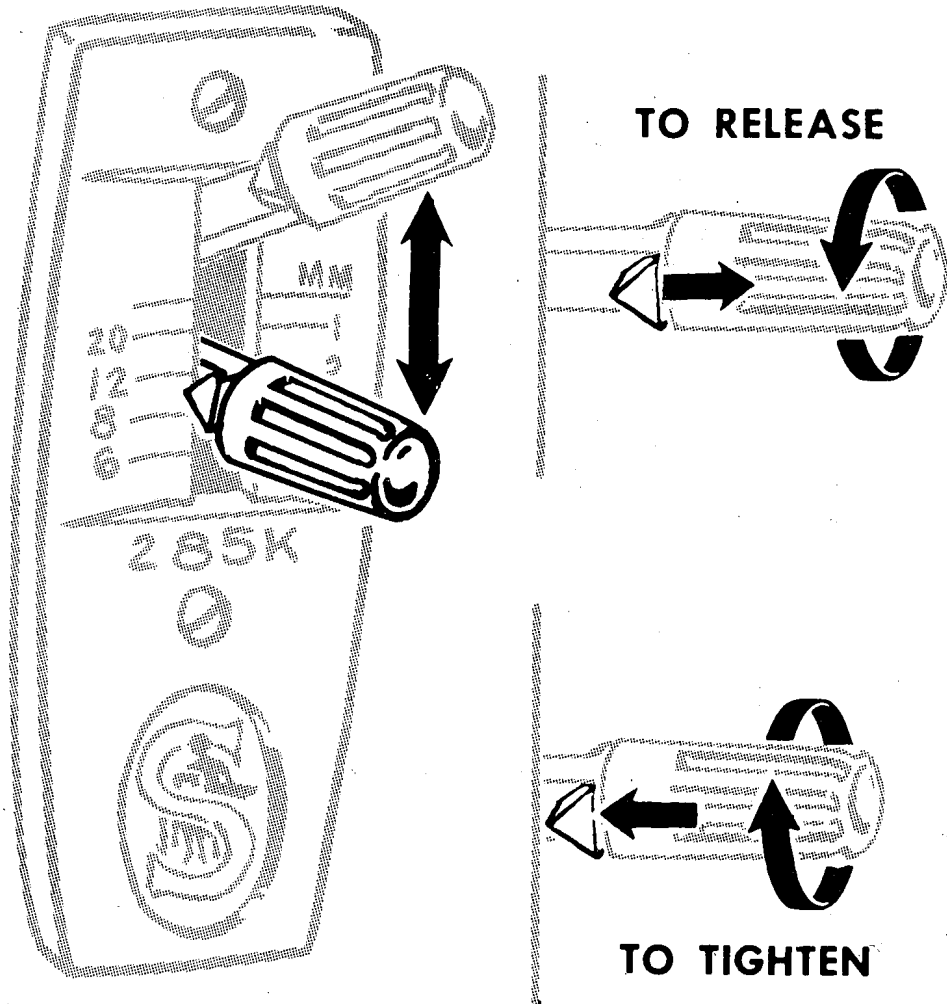

Numerals on left side of indicator represent number of stitches per inch. Numerals on right side represent stitch length in millimeters.

To set stitch length

- Release pointer by turning thumb nut to the left.
- Position lever for desired stitch length (the higher the number, the shorter the stitch length).
- Tighten pointer against indicator plate by turning thumb nut to the right.

Once the pointer has been tightened against the plate, reverse stitching is accomplished by raising the lever to its highest point.

PRESSURE ADJUSTMENTS

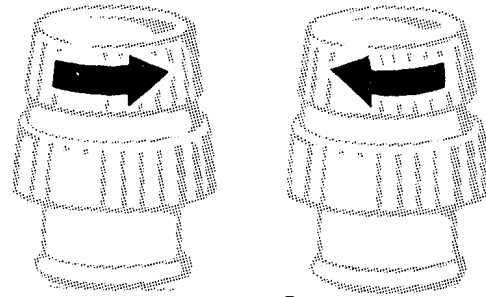

Decrease Increase

- To decrease pressure, turn thumb screw upward.
- To increase pressure, turn thumb screw downward.

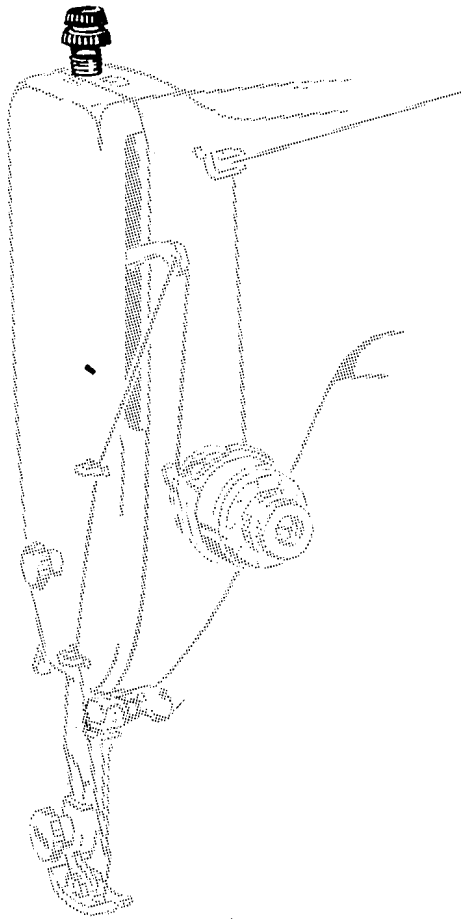

Smooth, even handling of several thicknesses of fabric results when pressure is correctly regulated.

Surface finish, as well as the weight and texture of the fabric, must be considered in determining the amount of pressure needed.

Adjustment of the thumb screw regulates the amount of pressure exerted on the material while it is being stitched.

Too light a pressure will result in irregular feeding which affects both quality of stitch and evenness of seams.

Too heavy a pressure not only affects stitch and seam quality but will mar smooth surfaces and pile fabrics.

PREPARING TO SEW

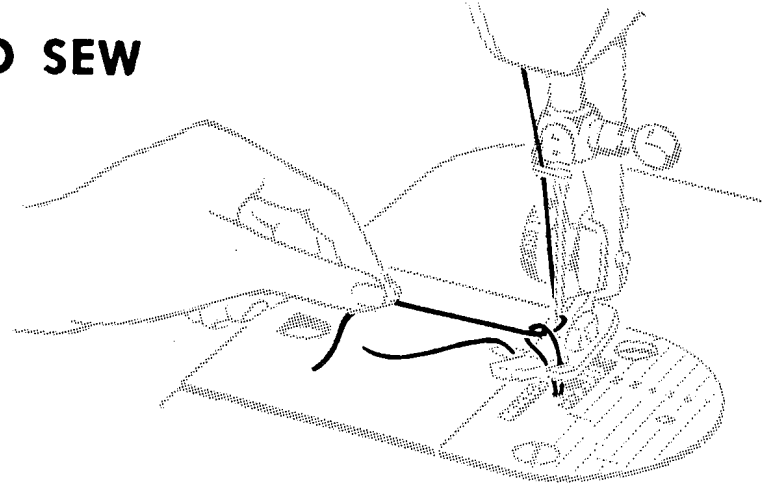
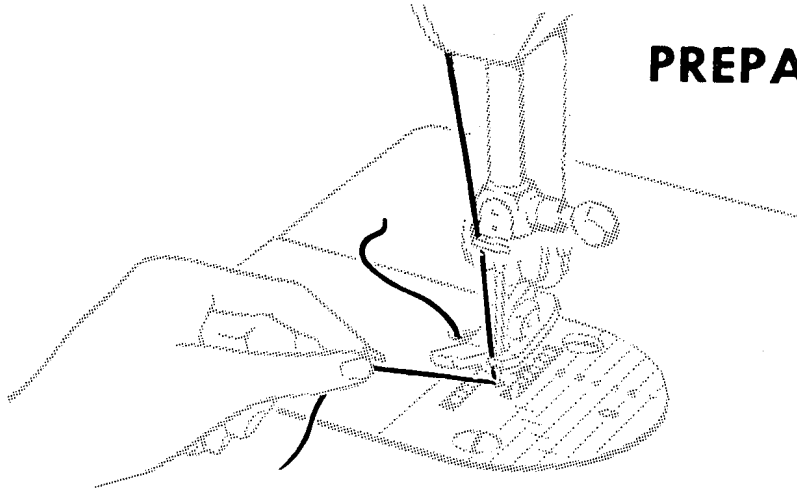

- Hold needle thread lightly with left hand.

- Turn hand wheel so that needle enters plate and brings up bobbin thread.

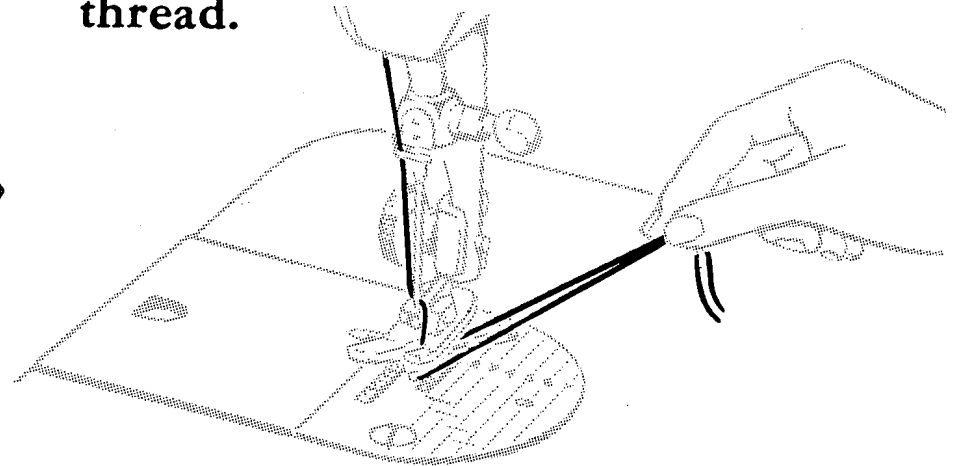
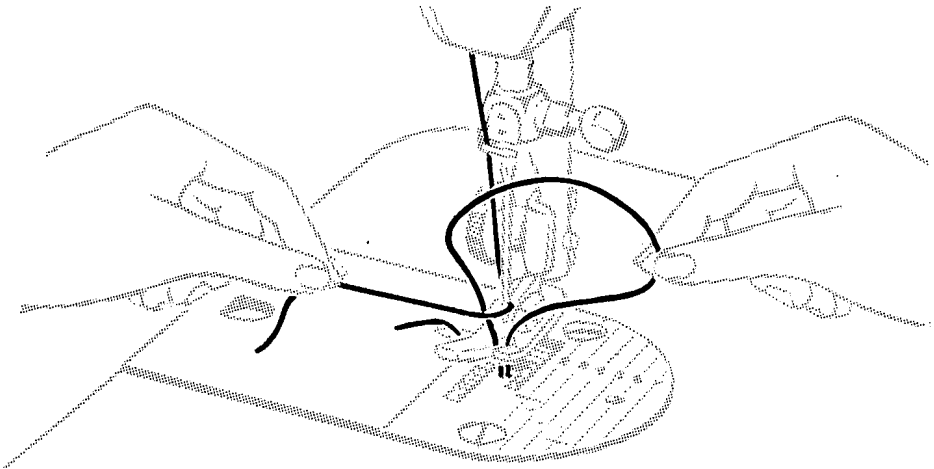

- Pull end of bobbin thread up through throat plate.

- Place both needle and bobbin threads diagonally under presser foot.

SEWING A SEAM

- Set stitch regulator for desired stitch length.
- Position needle into fabric about $\frac{1}{2}$ inch from edge.
- Lower presser foot.
- Raise stitch length regulator to reverse.

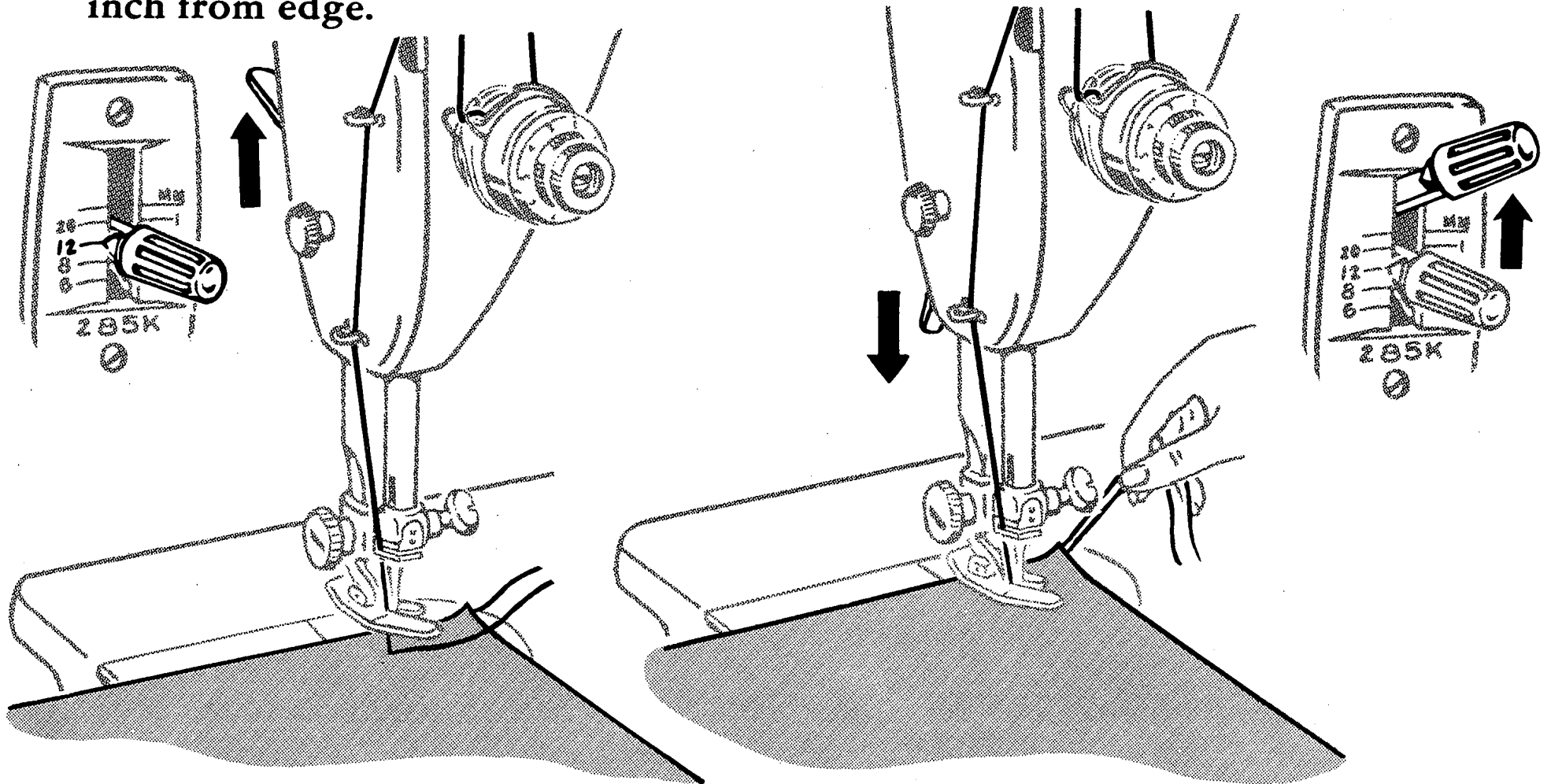

SEWING A SEAM (Cont'd)

- Back stitch to edge of fabric for reinforcement.
- Lower stitch length regulator.
- Stitch to end of seam.
- Raise stitch length regulator.

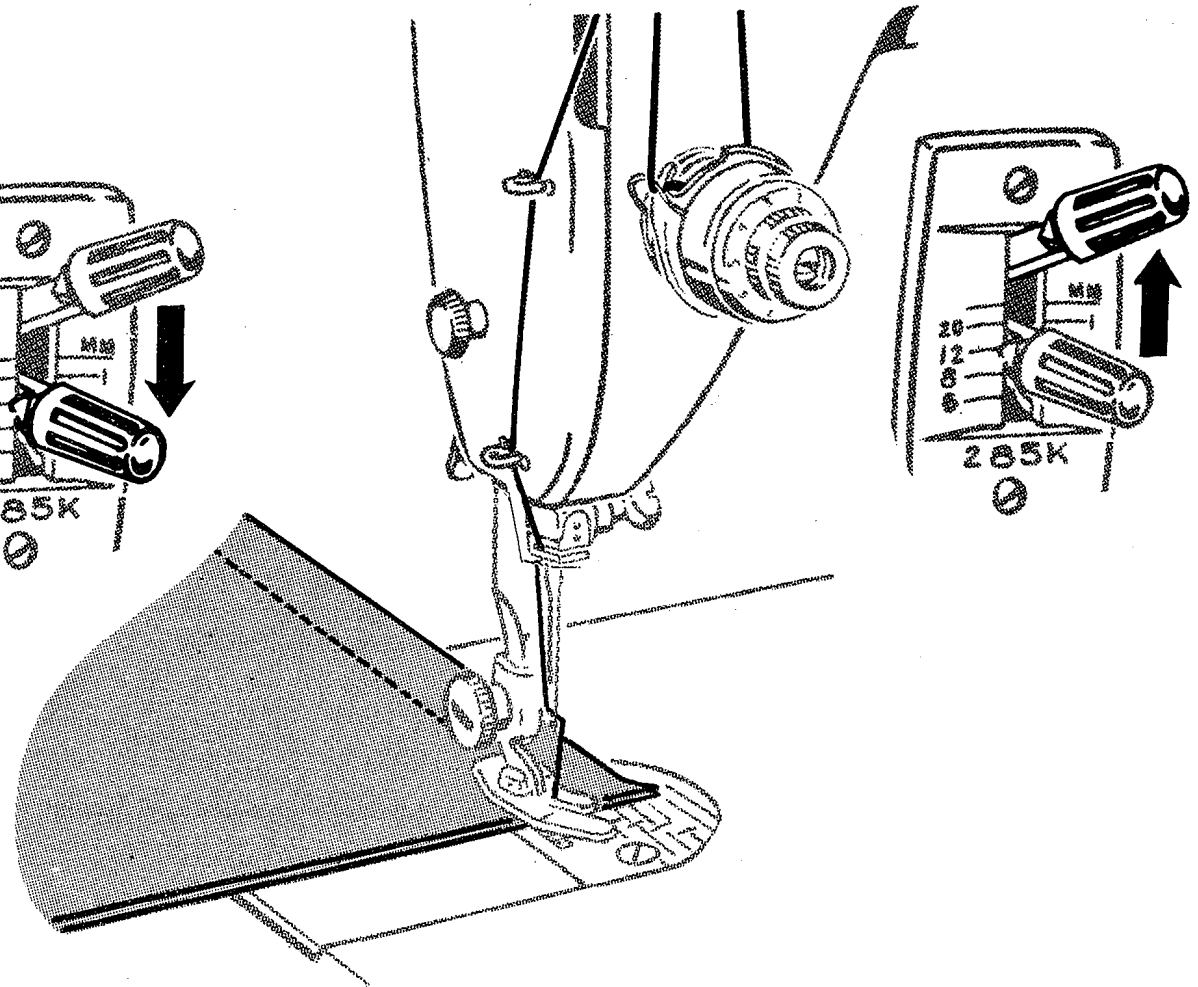
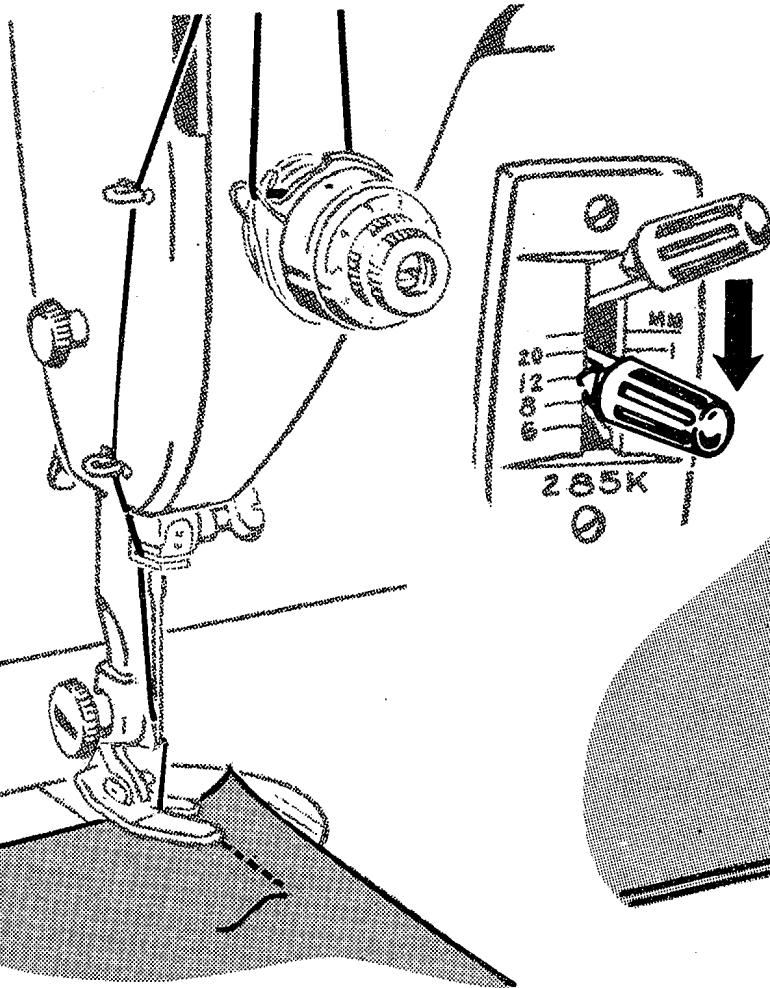

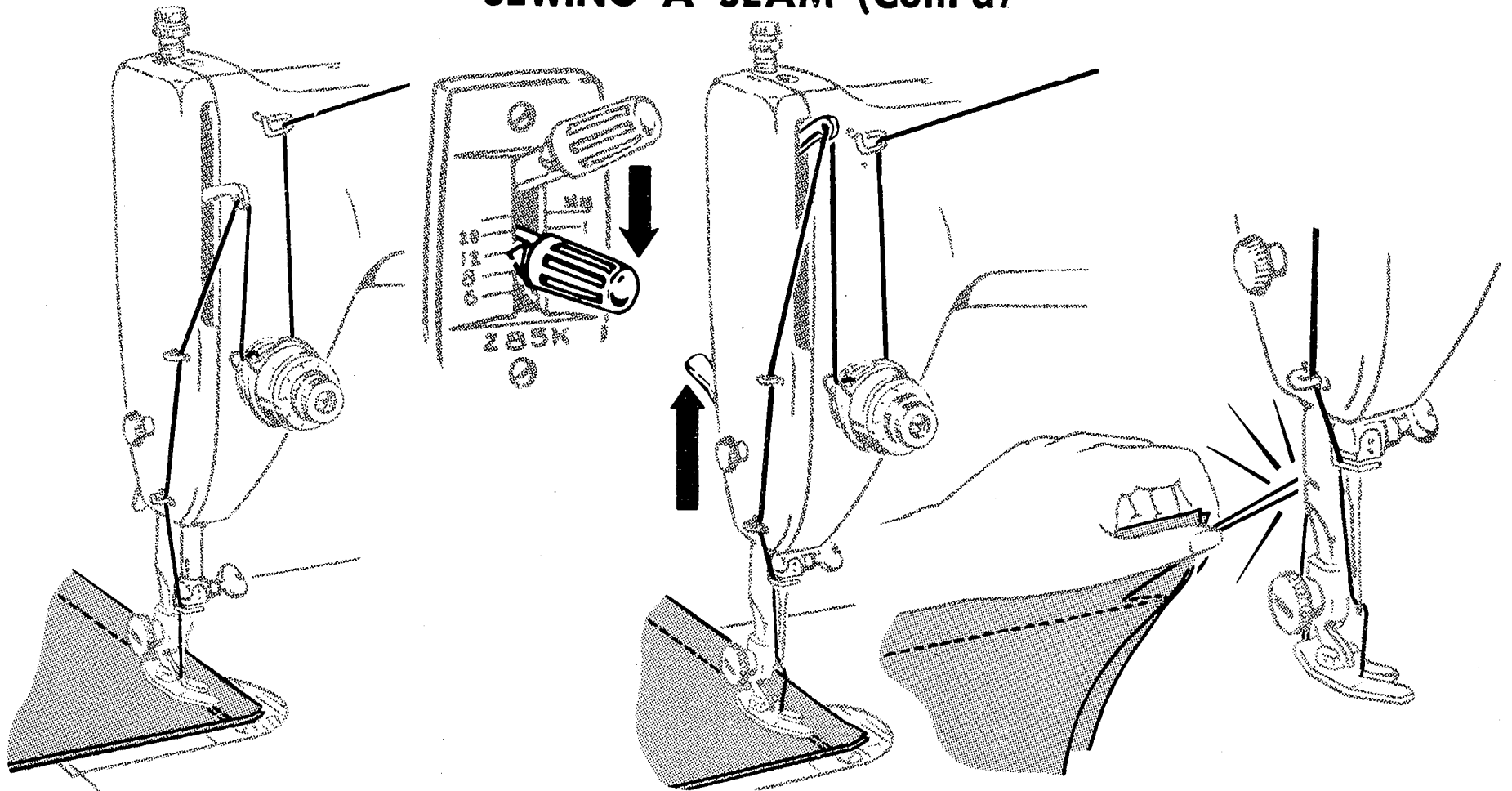
SEWING A SEAM (Cont'd)

- Back stitch to reinforce end of seam.
- Lower regulator to forward stitching position.
- With take-up lever at highest point, raise presser foot and remove fabric.

GUIDING AND SUPPORTING FABRIC

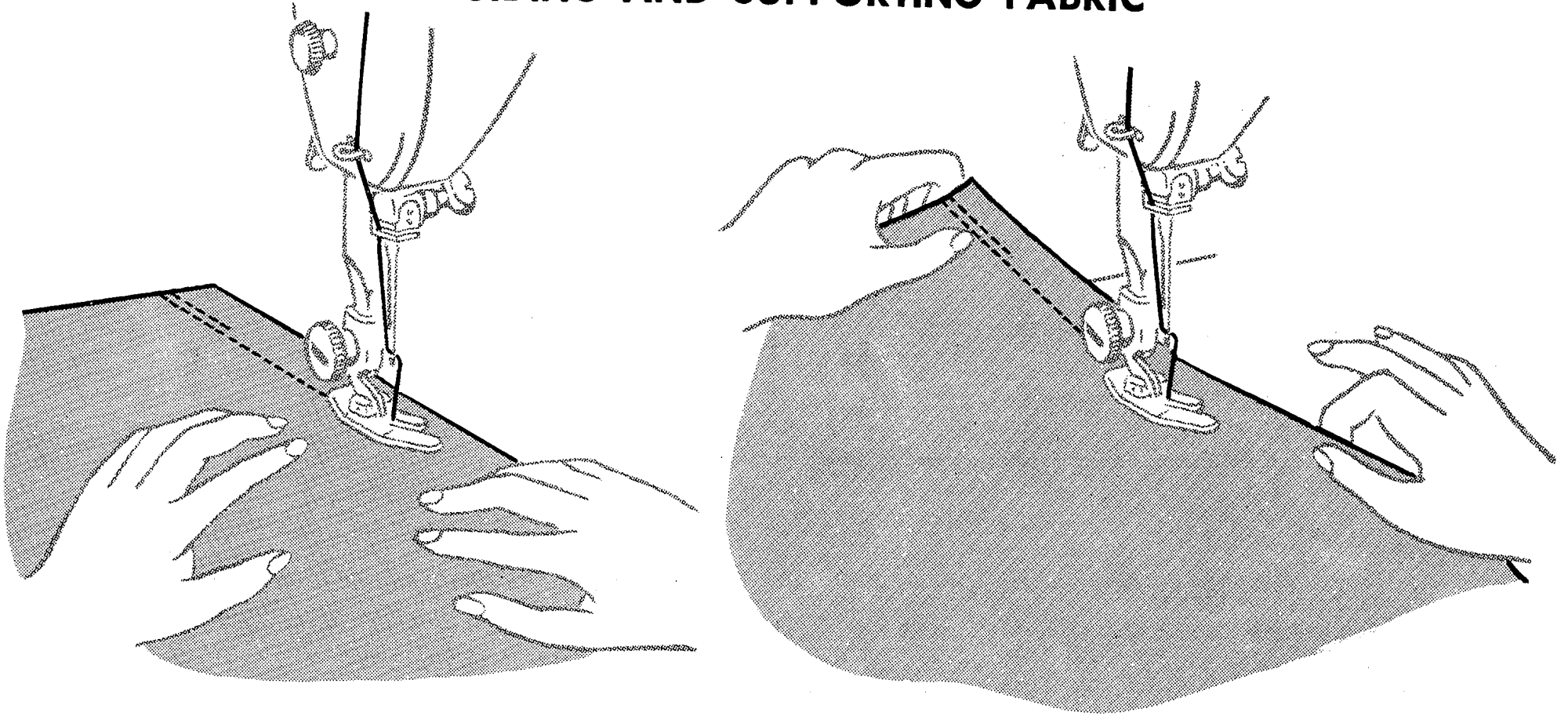

Most fabrics need to be guided only in front of the presser foot.

Fabrics of unusual texture and weave, filmy sheers, crepes, knits, tricots, etc., require support while being stitched. For such fabrics apply a gentle tension by holding seam in front and back of the presser foot as illustrated.

NEEDLE THREAD TENSION

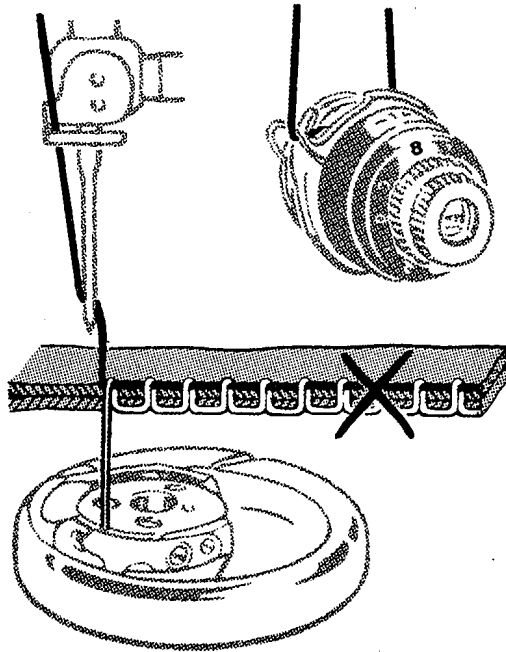

Needle thread tension too tight—correct by setting dial to lower number.

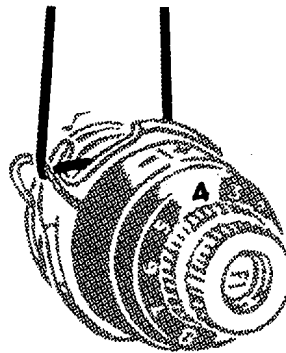

Needle thread tension too loose—correct by setting dial to higher number.

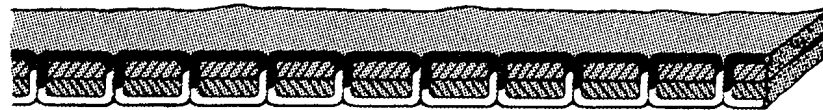

A perfectly locked stitch results with upper and lower tensions balanced so that needle and bobbin threads are drawn equally into fabric.

BOBBIN THREAD TENSION

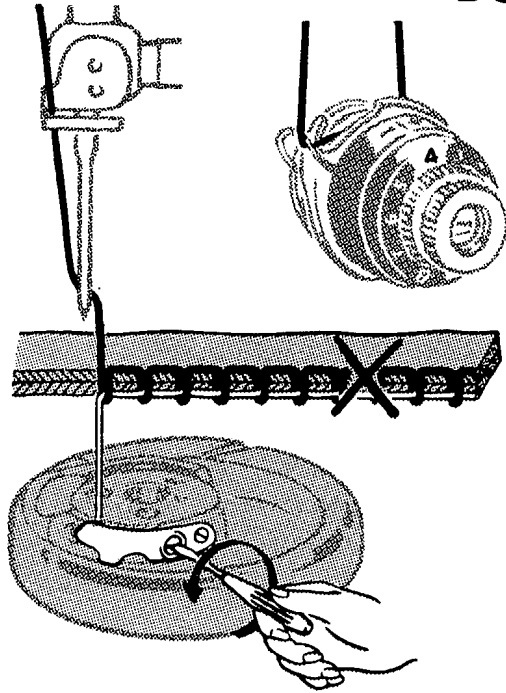

Bobbin thread tension too tight
—correct by turning screw counter-
clockwise.

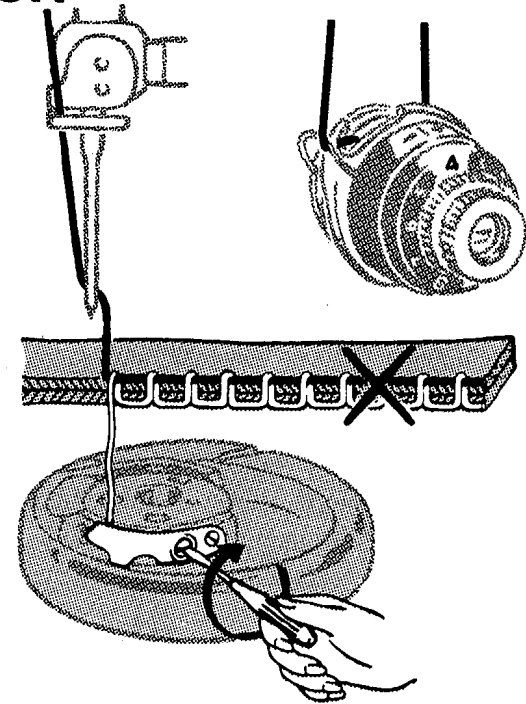

Bobbin thread tension too loose
—correct by turning screw clock-
wise.

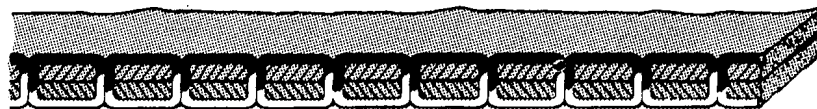

A perfectly locked stitch results with upper and lower tensions balanced so that needle and bobbin threads are drawn equally into fabric.

Instructions for using ATTACHMENTS ...



Those attachments which are not furnished with your machine are available for purchase at your local SINGER SEWING CENTER.

THE FOOT HEMMER

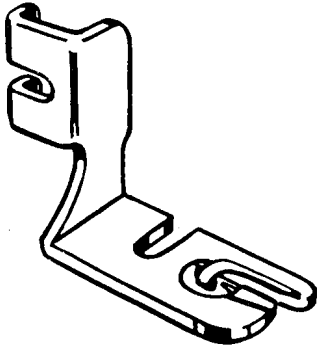

The hemmer forms and stitches a perfectly turned hem without basting or pressing. It is attached to machine in place of regular presser foot.

APPLICATIONS

Fine Hems	Hemming with Lace
Edging Ruffles	Lace Insertion
Hemmed Seams	Lingerie Finishes

Procedure

- Form a double $\frac{1}{8}$ " fold at edge of fabric; crease fold for about 2".
- Draw bobbin and needle threads under hemmer.
- Place creased hem under foot and take several stitches through fold.

- Hold thread ends in left hand and guide raw edge in front of hemmer evenly into scroll.
- Sew slowly, still holding thread ends until hem is well started.
- Feed material evenly into hemmer scroll.

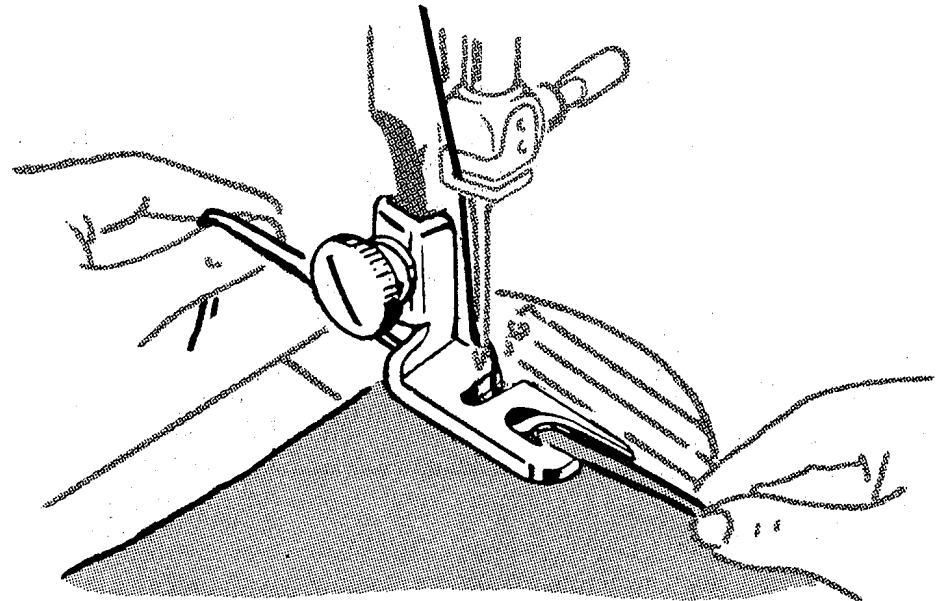

HEMMED SEAMS

Hemmed seams are appropriate where a fine narrow seam is desired.

- Allow a scant $\frac{1}{4}$ " seam allowance.
- With right sides of fabric together, place upper layer $\frac{1}{8}$ " to left of lower layer.
- Insert two fabric edges into hemmer and proceed as for plain hem.

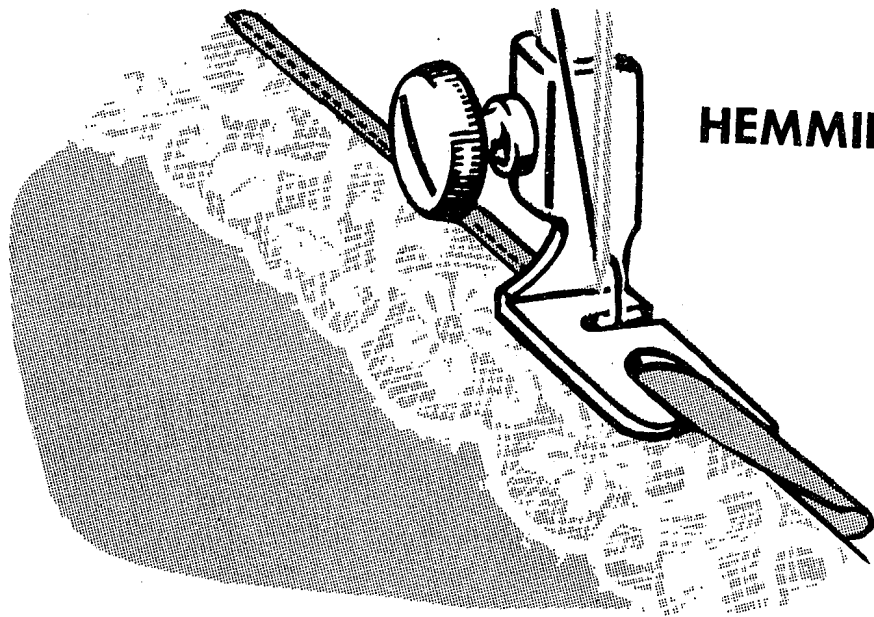
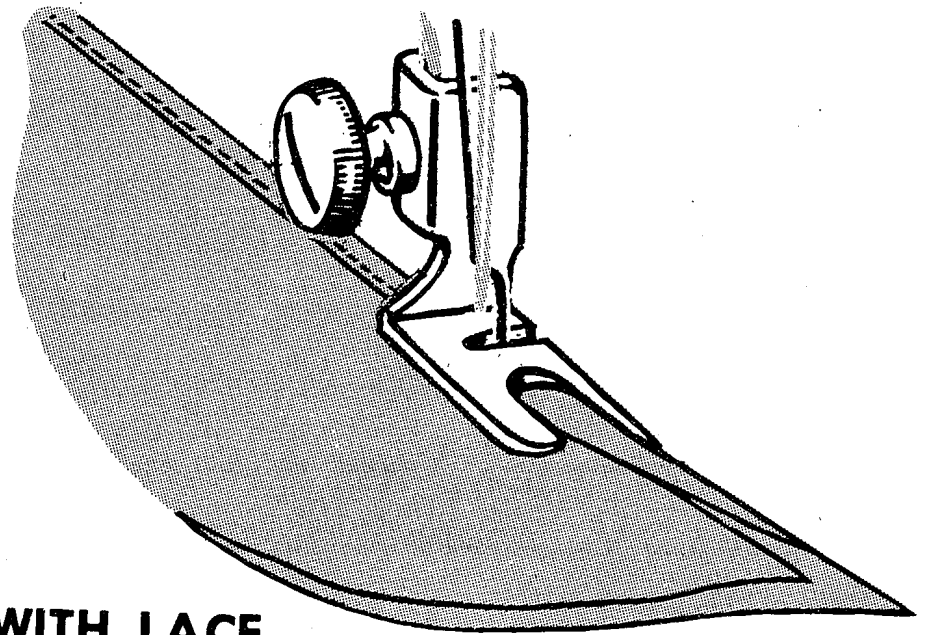

HEMMING WITH LACE

Proceed the same way as when making a hemmed seam.

- Slip lace in from left as you would the second piece of fabric.

This method is used where a neat finish is desired on both sides of the material.

THE BINDER

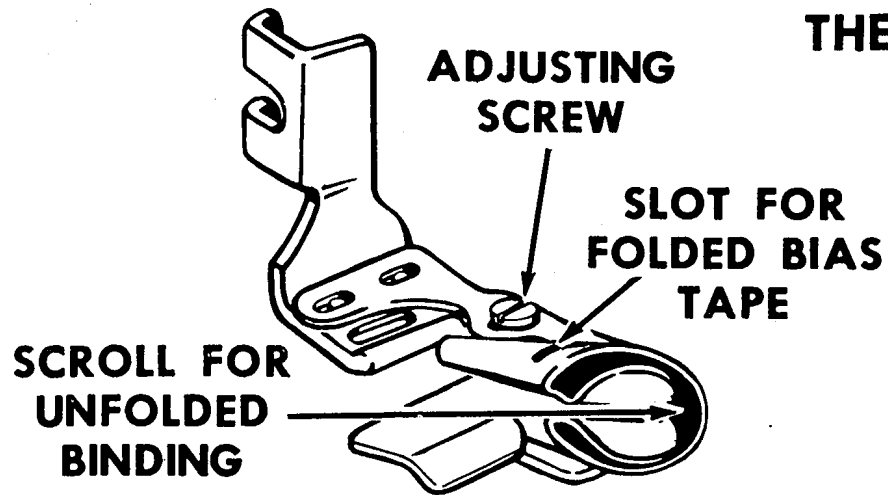

The binder is used to apply commercial as well as self-fabric bias to an unfinished edge.

This colorful trim is attractive when applied to children's wear, aprons and household textiles. It is a practical finish for seam edges that ravel and for making bound seams.

Inserting the Binding

Commercial single fold bias tape is inserted from the right into slot in binder scroll.

- Cut binding diagonally to form a long point.
- Insert pointed end into slot and pull through scroll.

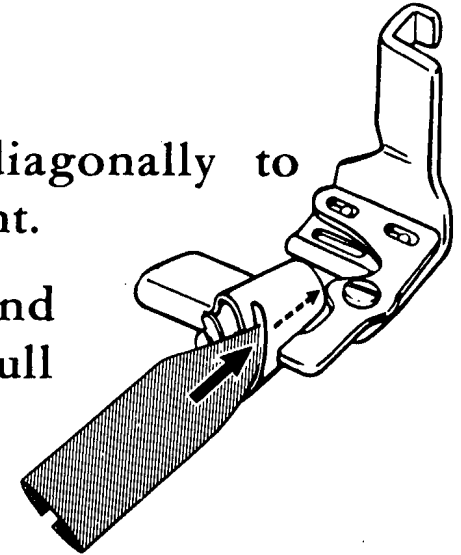

Self-fabric bias binding should be cut $15/16$ " wide on true bias.

- Insert unfolded binding directly into opening at end of scroll and pull through.

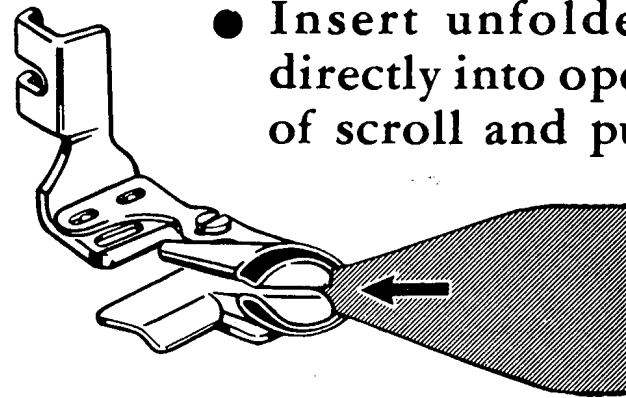

As binding passes through scroll, the raw edges are turned in.

THE BINDER (Cont'd)

Procedure

- Attach binder to presser bar in place of regular presser foot.
- Pull binding through scroll until evenly folded edges are under needle.
- Insert edge to be bound into center slot of scroll.
- Position needle, lower presser bar and stitch.

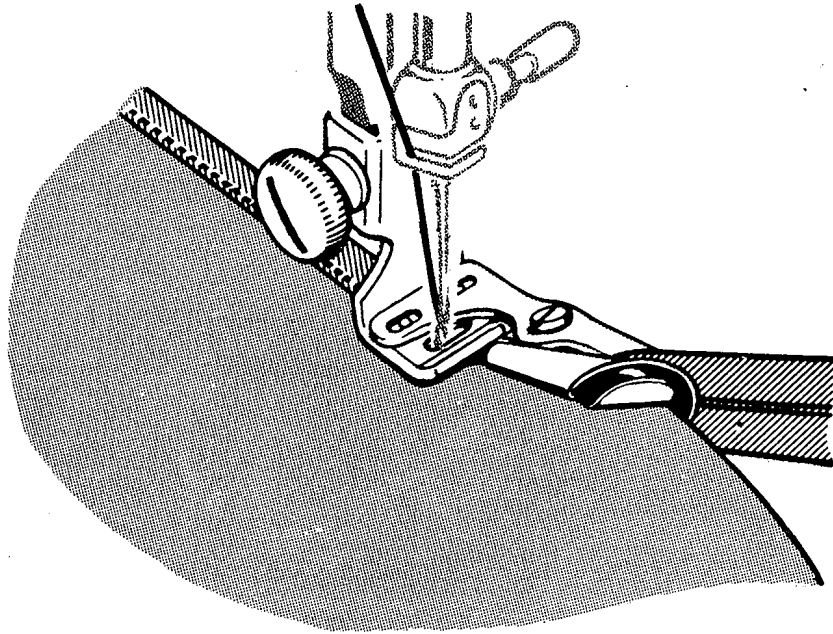

To adjust binder

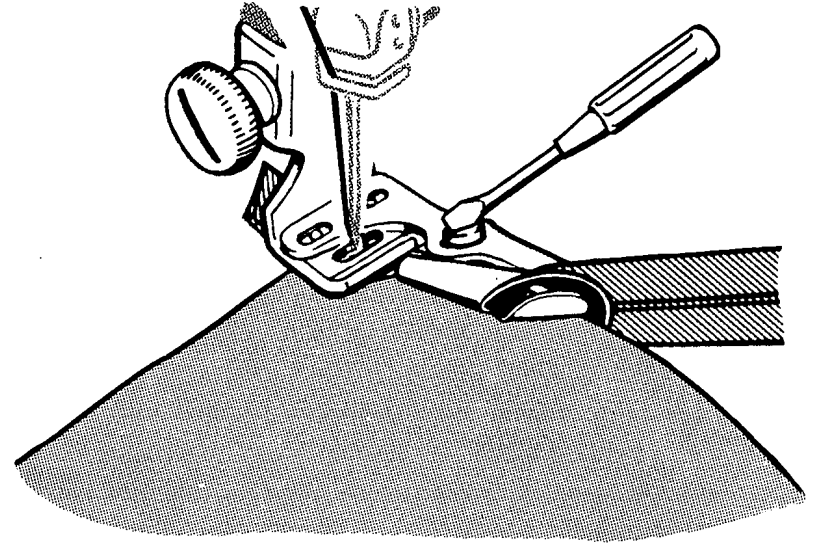

Stitching is positioned in relation to binding edge by adjustment of binder scroll.

- Loosen adjusting screw.
- Move scroll to right or left as necessary.
- Tighten adjusting screw.

Never pull binding as it feeds through scroll. Allow attachment to do the work. Merely guide edge to be bound into center of scroll as you stitch.

BINDING CURVED EDGES

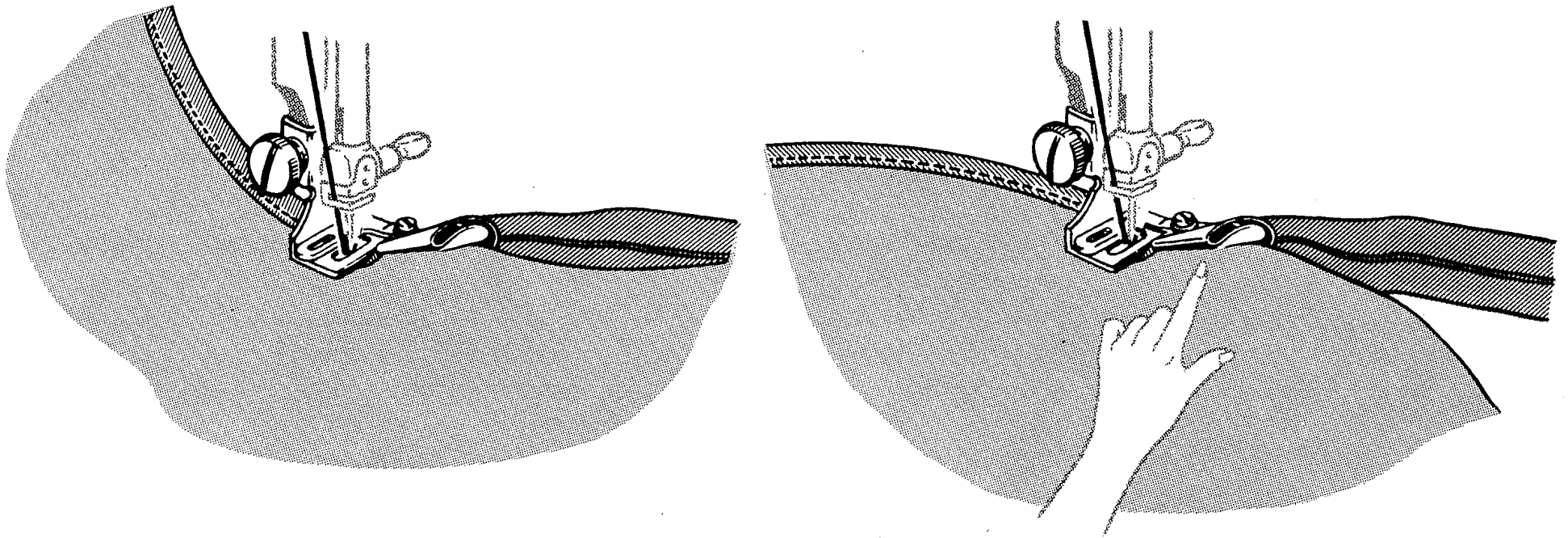

Curved edges require slightly different fabric handling from straight edges. Inside curves are straightened as they are fed into binder. If fabric is soft and has a tendency to stretch, reinforce edge with a single row of stitching before binding.

Outside curves tend to lead away from center slot of scroll and should be guided so that a full seam width is taken at needle point. Do not attempt to pull or straighten fabric into full length of scroll.

THE ZIPPER FOOT

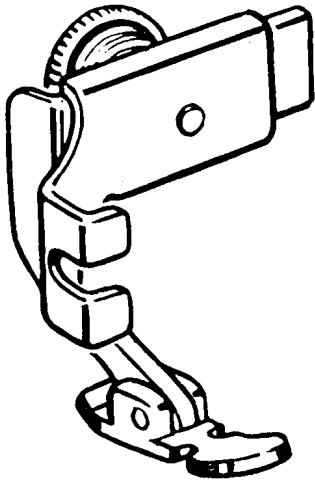

This foot is designed to facilitate the placement of stitching close to a raised edge. The hinged feature of this foot insures even feeding over pins, heavy layers of fabric or cross seams. It is attached to the machine in place of the regular presser foot, and may be adjusted to either the right or left of the needle.

APPLICATIONS

Zipper Insertions
 Tubular Cording
 Corded Seams
 Slip Cover Welting

Preparation

- Secure zipper foot to presser bar as you would the regular presser foot.

Adjustment to right or left of needle is made by loosening thumb screw at back of foot.

With foot down, check position of foot by lowering needle into side notch, making sure it clears foot.

Lock into position by tightening thumb screw.

THE ZIPPER FOOT (Cont'd)

Zipper Insertion

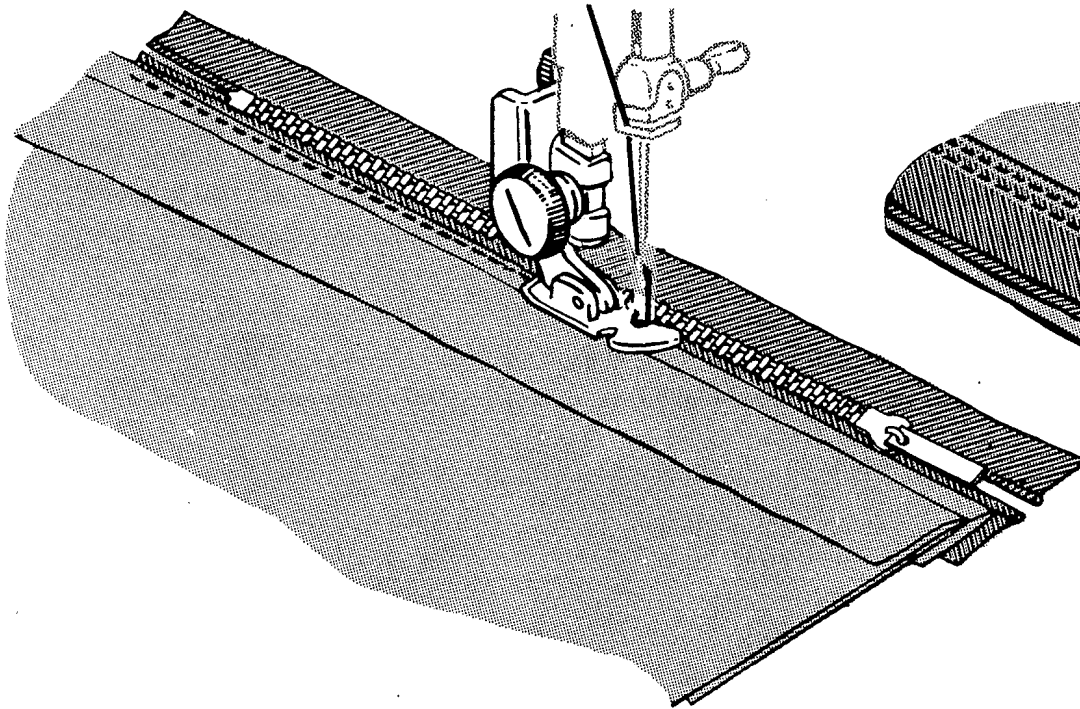

Corded Seams

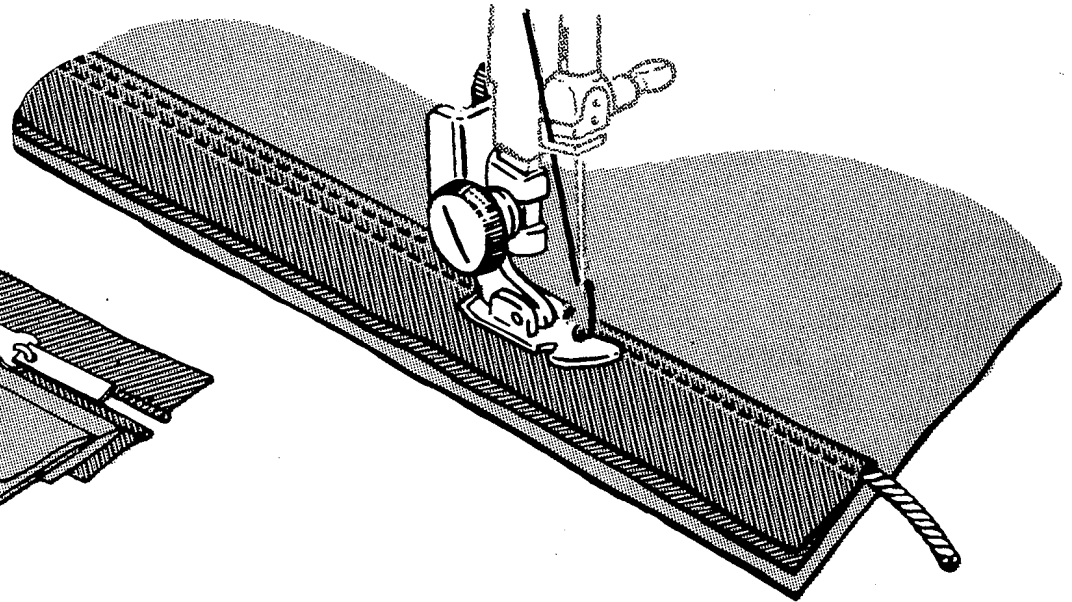

Several methods are used to insert a zipper and in any method used, the zipper foot enables you to form an even line of stitching close to the zipper.

- When raised edge is placed to right—adjust foot to left of needle.
- When raised edge is placed to left—adjust foot to right of needle.

THE SEAM GUIDE

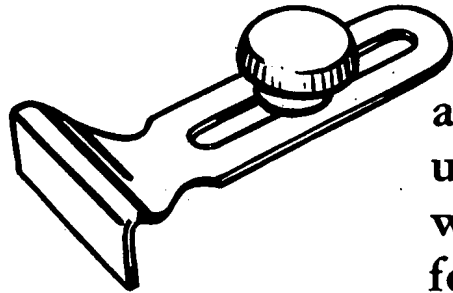

The seam guide aids in attaining uniformity of seam width. It provides for stitching to be placed at any distance between $\frac{1}{8}$ " to $1\frac{3}{8}$ " from edge of fabric.

APPLICATIONS

Seams

Stay Stitching

Top Stitching - Single
or Multiple Rows

Attachment is used in connection with a presser foot. It is secured to bed of machine in either of threaded holes to right of needle.

SEAMS

For straight seams. Align guide with presser foot. Pin seam edges and baste if necessary. Guide fabric edges lightly against guide while stitching.

For curved seams: Set attachment at an angle so that end closest to needle acts as a guide. Shorten stitch length for greater elasticity and strength.

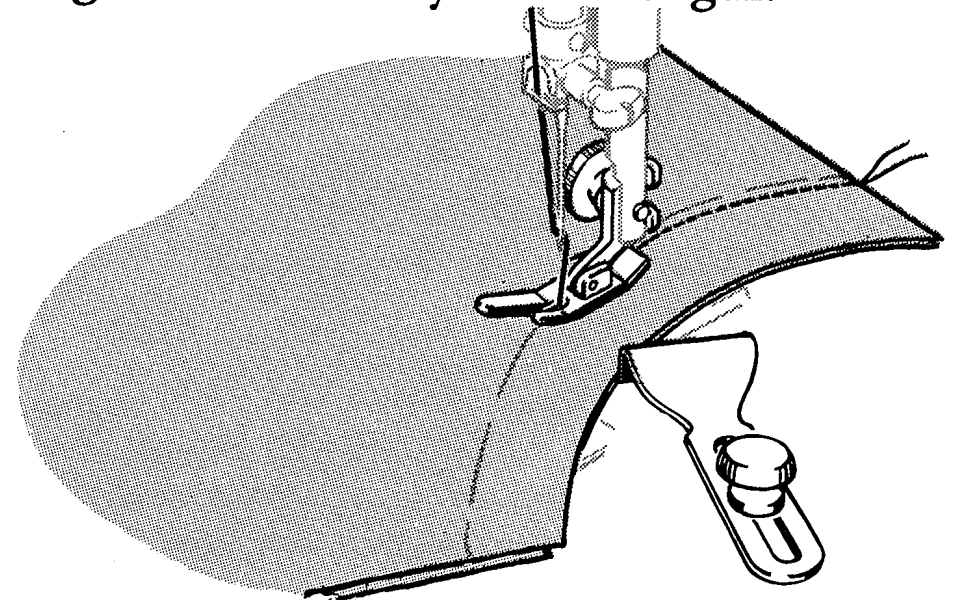

FASHION* AIDS

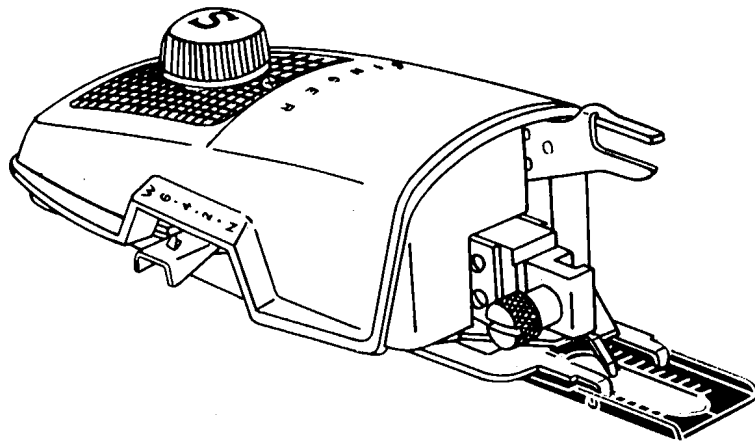

Buttonholer

Beautiful, evenly stitched buttonholes are quickly and easily made with the SINGER Buttonholer.

The attachment makes both straight and eyelet-end styles, automatically guiding them to the size and shape selected.

Nine different lengths are available, ranging from $5/16$ " to $1-1/16$ ".

Ruffler

The ruffler offers a simple and effective way to make gathered and pleated ruffles. Ruffles may be made separately or made and applied at the same time.

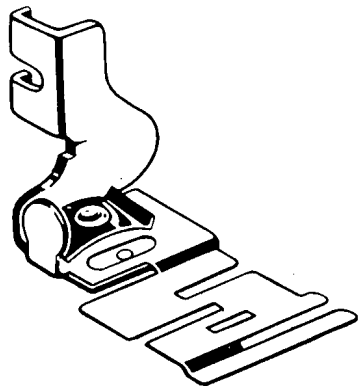
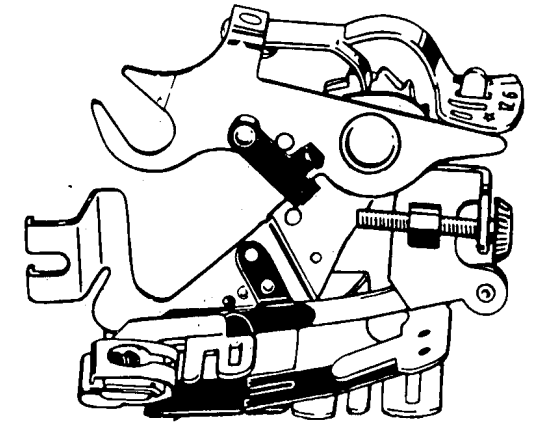

Edge Stitcher

This attachment provides a series of slotted guides which regulate the placement of stitching in relation to a fabric edge.

Among many decorative and practical applications are the joining and insertion of lace, tucking from pin width to $1/4$ ", French seaming, piping, facing and seam finishing.

TO CLEAN THE MACHINE

When in regular use

Machines should be cleaned periodically with lint brush to remove lint and fluff which may have accumulated around working parts. To clean bobbin case area, remove bobbin case as instructed on **page 33**. Oil machine after each cleaning as instructed on **pages 35, 36 and 37**.

When stored

If machine is to be stored away for an indefinite period, a thorough brush-cleaning to remove all traces of lint and fluff, followed by swabbing of all exposed parts with a lint free brush saturated with SINGER* oil is necessary to protect machine against rust damage.

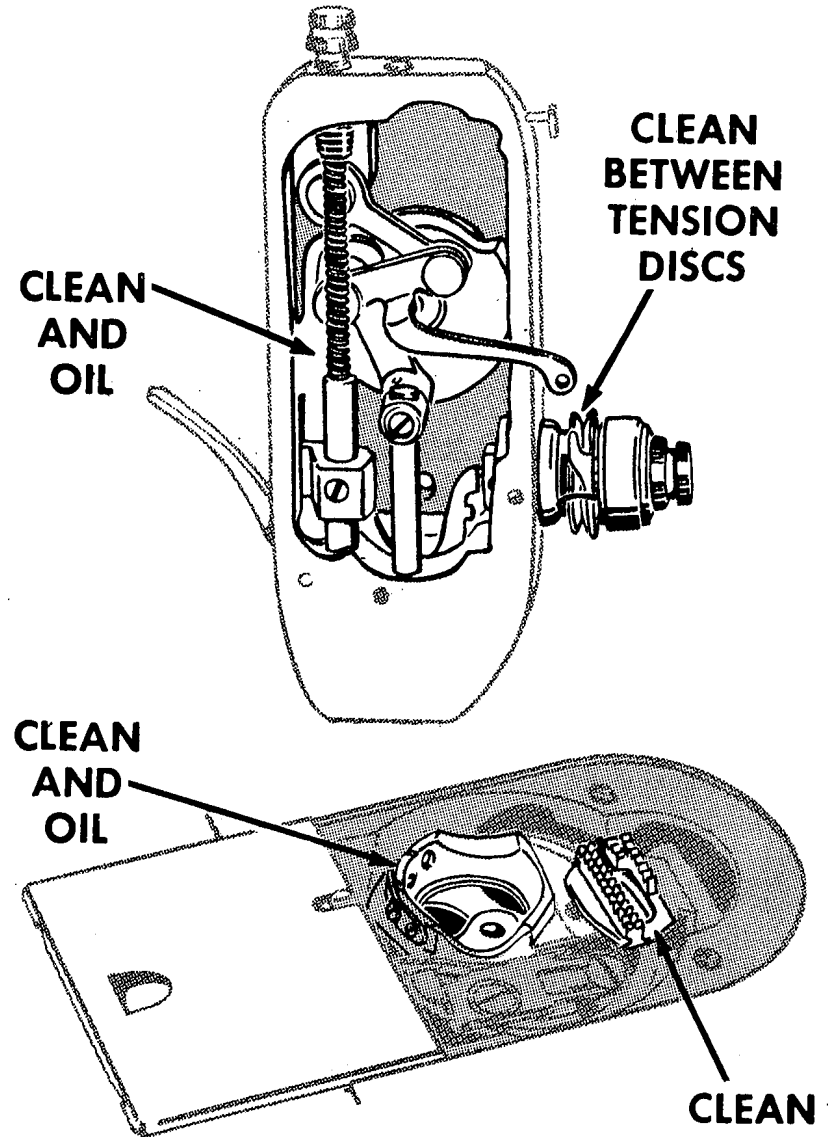

TO REMOVE THE BOBBIN CASE

Preparation

- Raise needle bar and presser bar.
- Open slide plate.
- Remove bobbin from bobbin case.

Remove bobbin case as follows

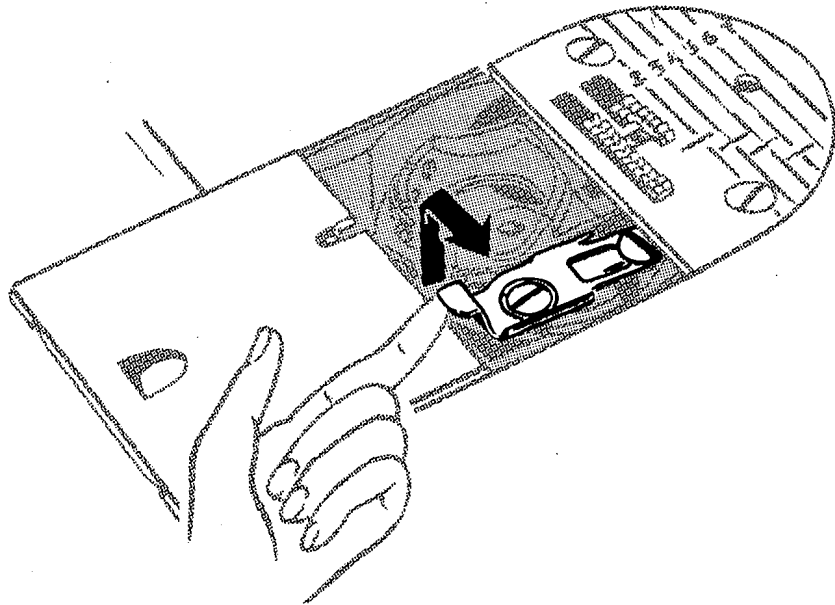

- Unlock bobbin case by lifting and pulling holder to right as shown.

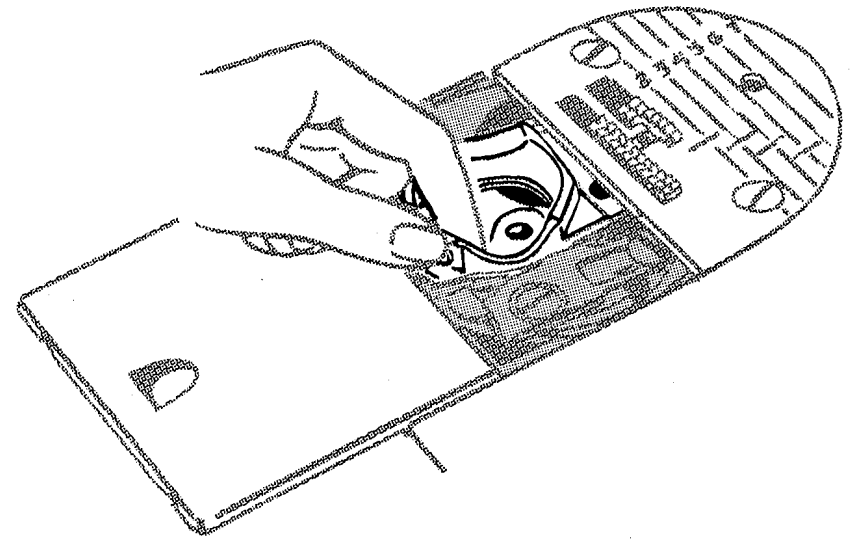

- Remove bobbin case from machine.

TO REPLACE THE BOBBIN CASE

After all lint, fluff, dust or loose thread ends have been removed from bobbin case and feed area, replace bobbin case as follows:

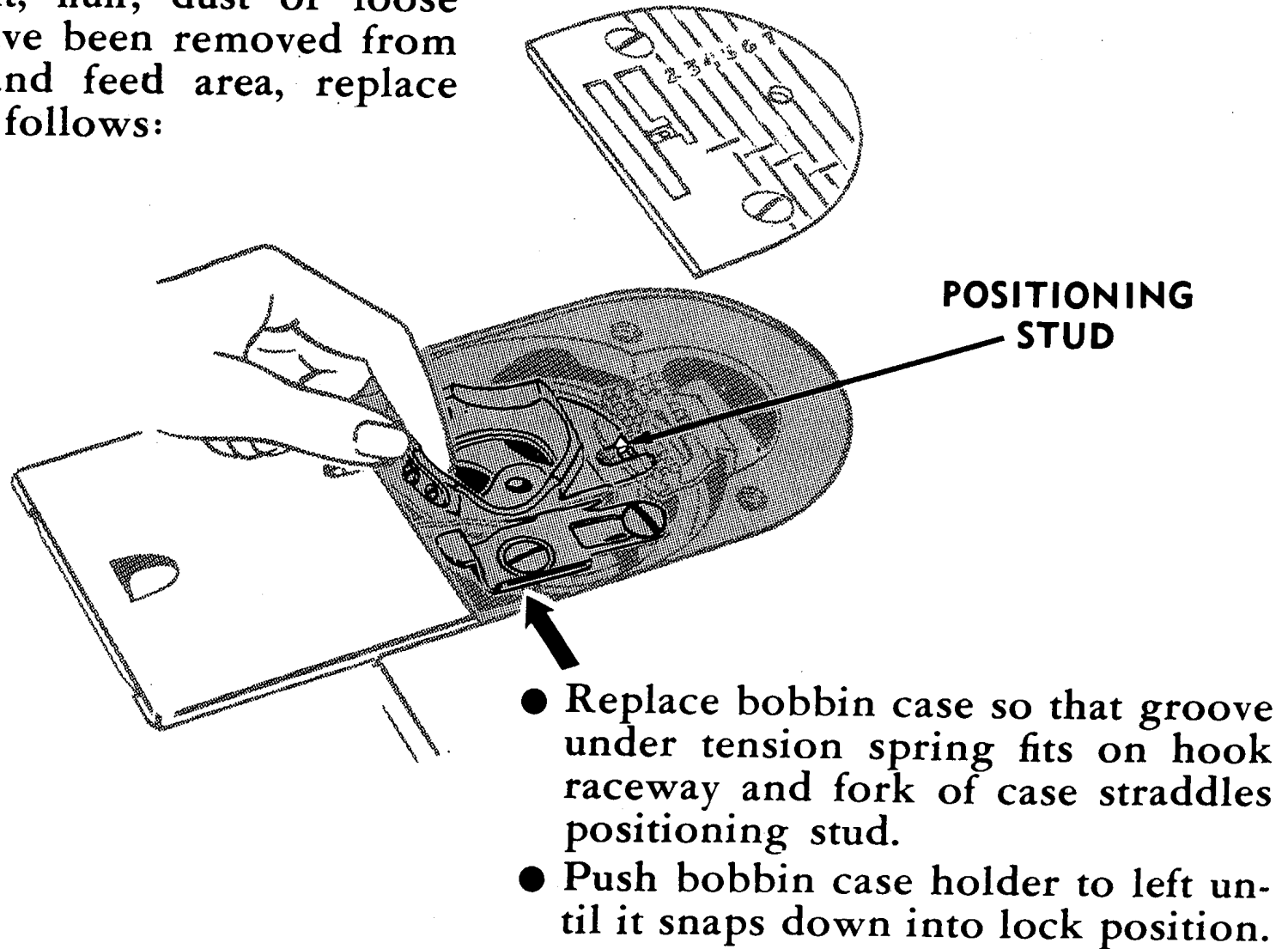

TO OIL THE MACHINE

To keep your machine in top running condition, use SINGER Oil and SINGER* Lubricant. Both are quality products especially prepared for sewing machines, and should always be used in the care of your 285K.

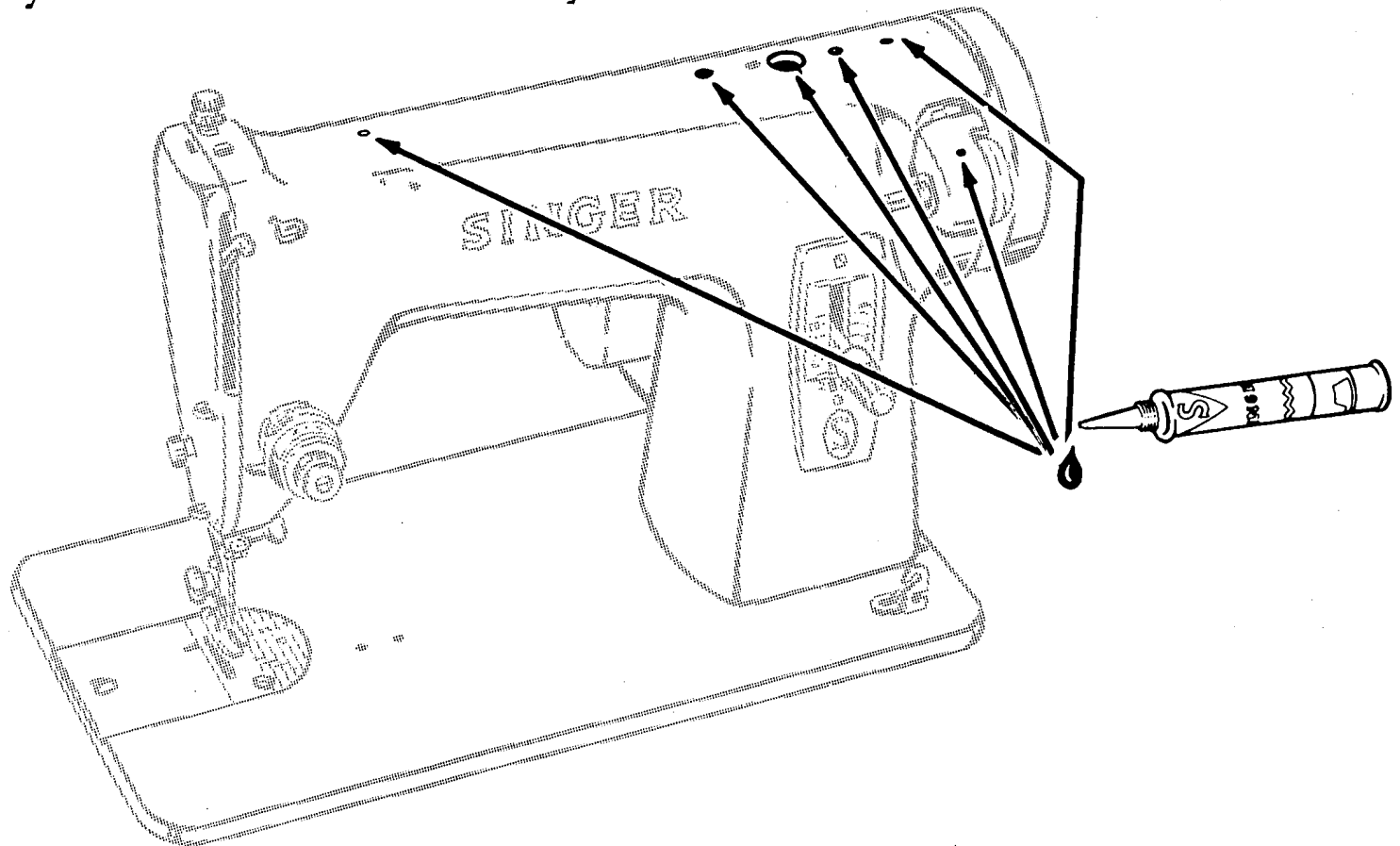

● Clean machine periodically as instructed on page 32.

● Apply a drop of oil to each place indicated.

TO OIL THE MACHINE (Cont'd)

- Remove face plate and oil the places indicated.

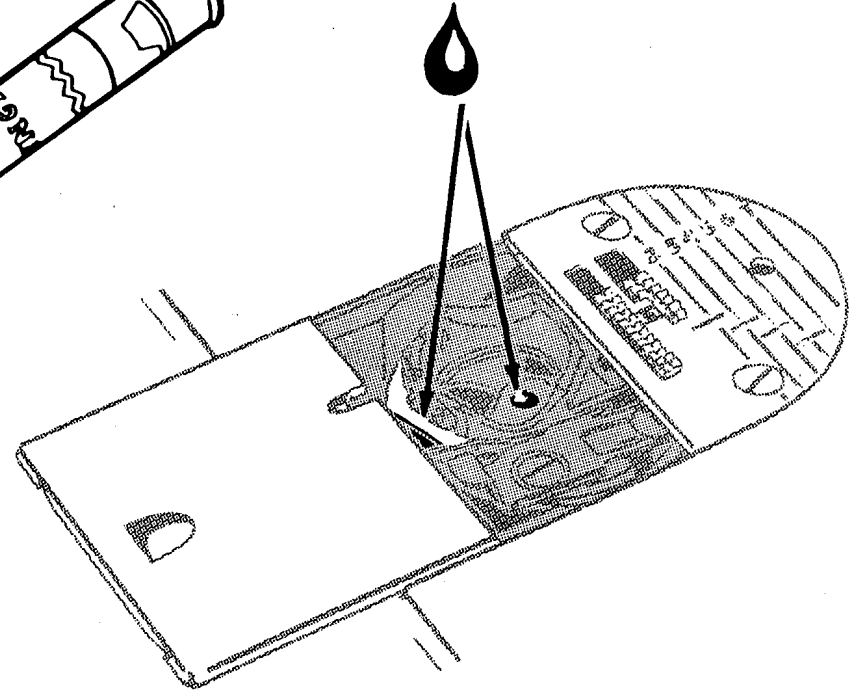
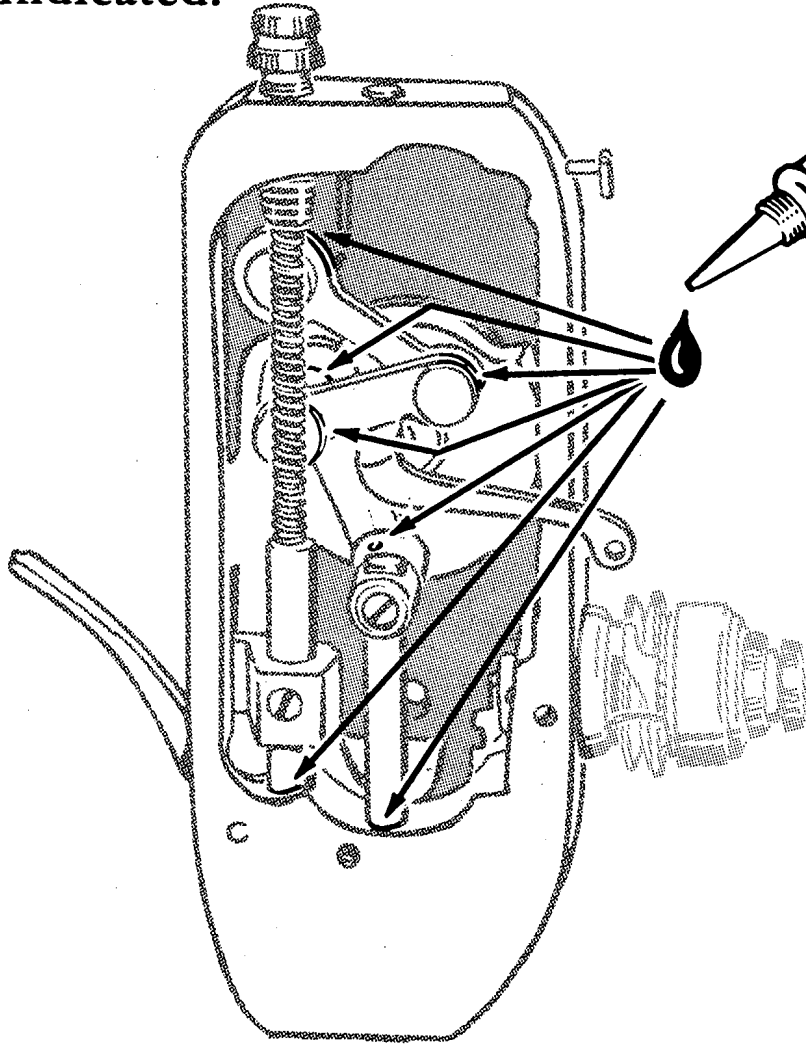

- Open slide plate and apply a drop of oil to hook raceway as indicated.
- Close slide plate and replace face plate.

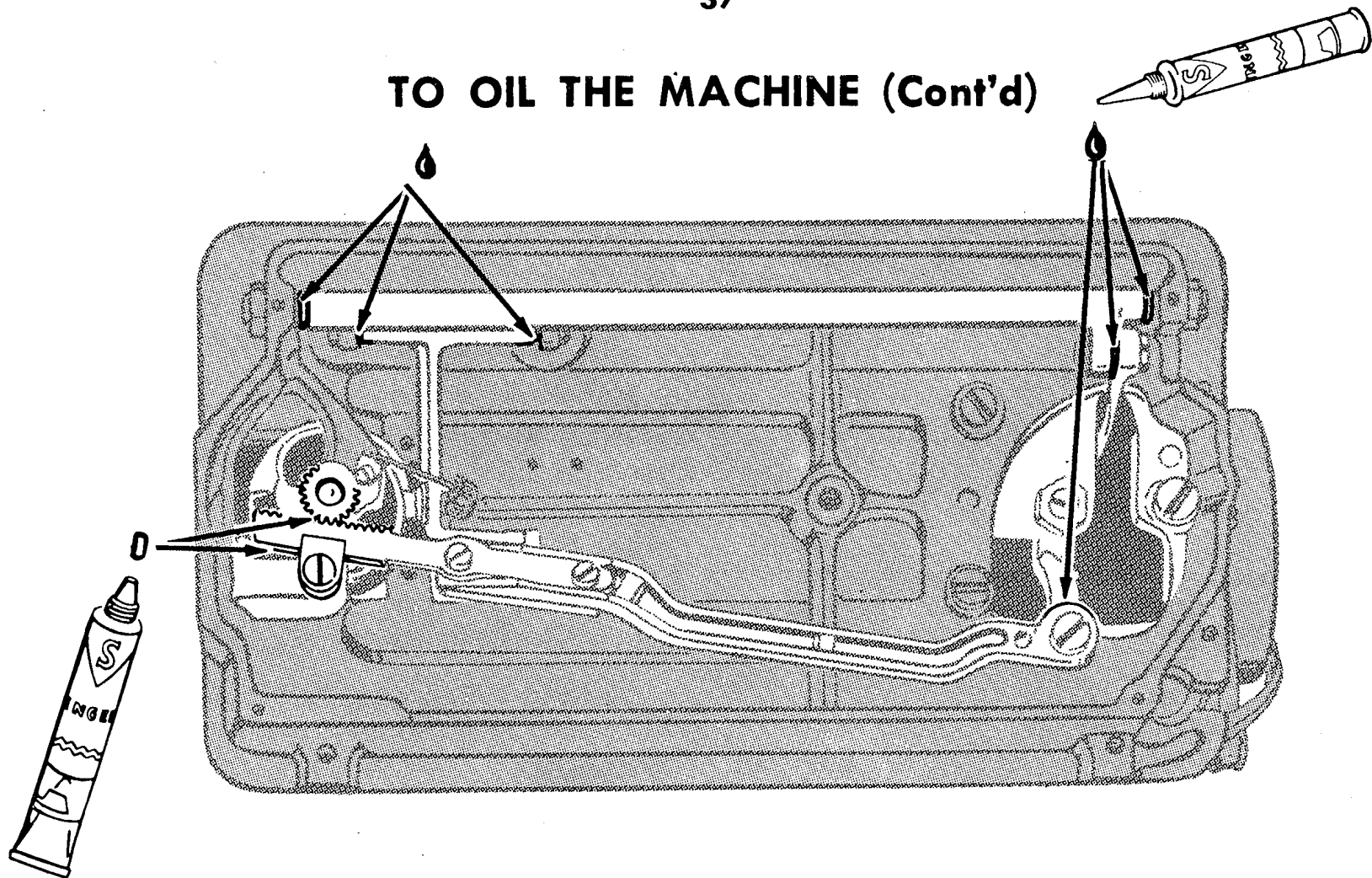
TO OIL THE MACHINE (Cont'd)

Tilt machine back and remove four screws from corners of machine cover. Remove cover. Oil each of the places indicated by arrows. Apply a small amount of lubricant to gears as shown. Replace bottom cover.

THE MOTOR REQUIRES NO LUBRICATION

ELECTRICAL INFORMATION

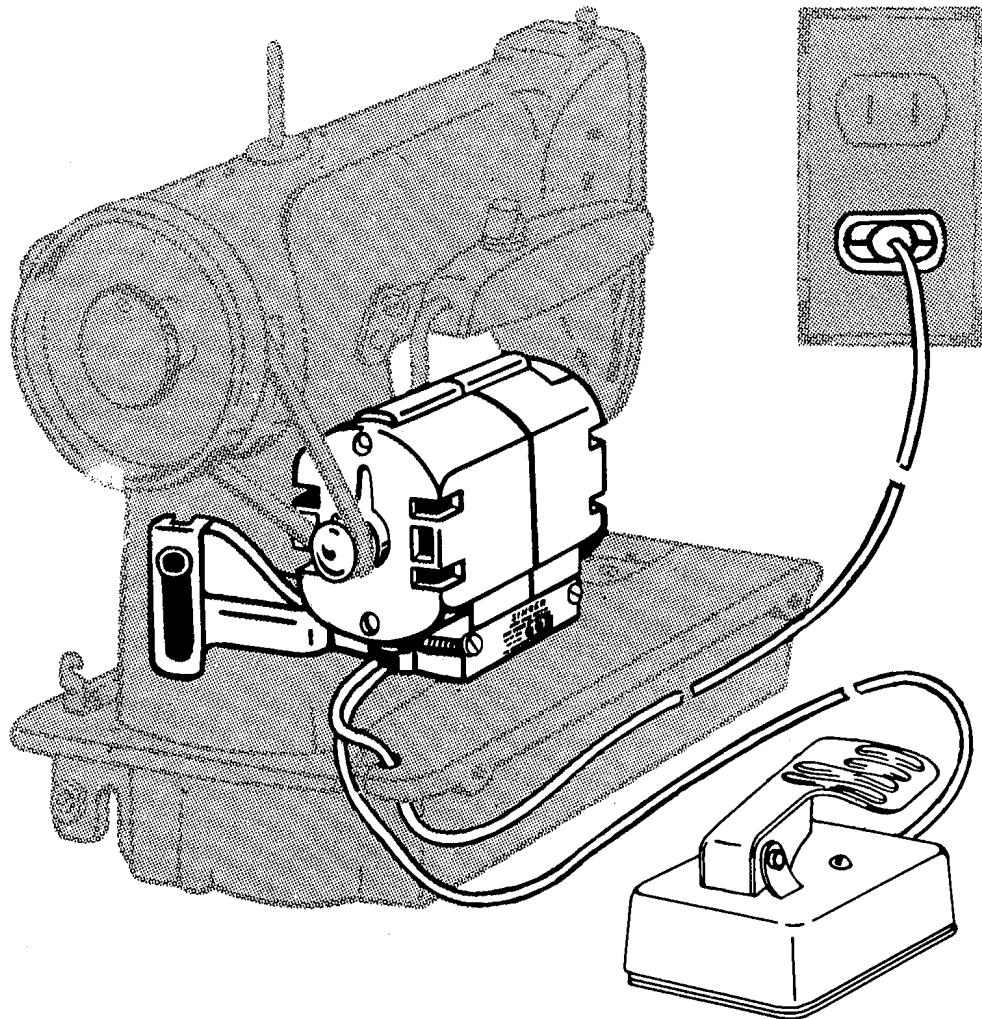

The **SINGER*** Electric Motor in your machine is furnished for operation on an alternating current of 110-120 volts, 25/75 cycles. Special motors are available for direct or alternating current for any voltage between 50 and 145, and for 32 volts direct current.

Before Inserting Electric Plug, be sure that voltage and cycles stamped on terminal cover are within range marked on your electrical meter installed by your power company.

Electrical Connection. Insert plug into nearest electrical outlet and the machine is ready for operation.

Speed Controller. Speed of machine is regulated by amount of pressure on pedal of foot controller.

BELT TENSION

Tension on the belt should be only heavy enough to keep the belt from slipping.

To adjust—loosen bracket screw a full turn, allow weight of motor to supply correct belt tension and tighten bracket screw.

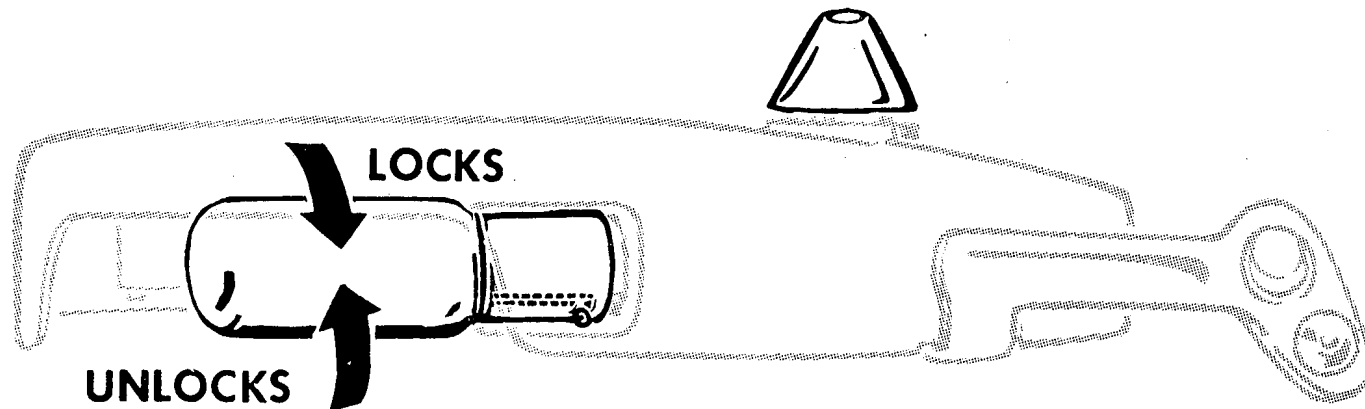
LIGHT

The light is turned "on" or "off" by the light switch.

To Remove Bulb. Do not attempt to unscrew bulb. Press bulb into socket and at the same time turn it over away from machine to unlock bulb pins. Remove bulb.

To Replace Bulb. Press new bulb into socket with bulb pins entering slots of socket. Turn bulb over toward machine to lock bulb pins in position.

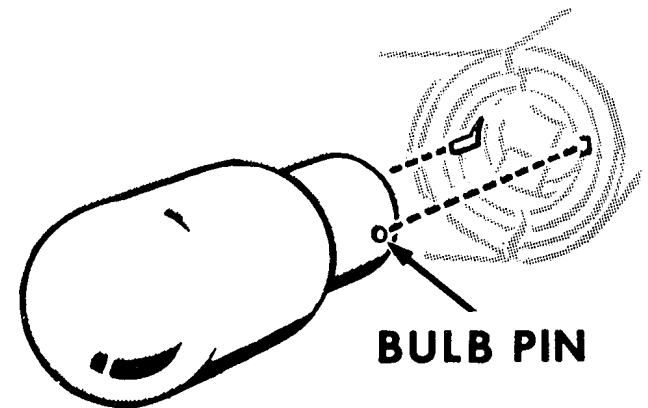

INDEX

	PAGE		PAGE
Attachments	22-30	Hemmed Seams	24
Binder	25-27	Needle and Thread Selections	5
Foot Hemmer	23-24	Needle Insertion	6
Seam Guide	30	Oiling and Lubricating	35-37
Zipper Foot	28-29	Preparing to Sew	15
Bobbin		Pressure Adjustments	14
Removing	7	Principal Parts of Machine	4
Winding	8-10	Regulating Pressure of Material	14
Bobbin Case		Sewing a Seam	16-18
Removing and Replacing	33-34	SINGER Service	3
Threading	11	Stitch Length, Regulating	13
Cleaning the Machine	32	Tension Adjustments	
Electrical Information		Bobbin Thread	21
Controller	38	Needle Thread	20
Light	39	Threading	
Motor	38	Bobbin Case	11
FASHION Aids	31	Needle	12
Guiding and Supporting Fabric.....	19		

To all whom it may concern:

The improper placing or renewal of the trademark "**SINGER**" or any other of the trademarks of The Singer Company (all of which are duly Registered Trademarks) on any machine that has been repaired, rebuilt, reconditioned, or altered in any way whatsoever outside a SINGER factory or an authorized SINGER agency is forbidden.

For your protection

SINGER Sewing Machines are sold and serviced wherever you see the famous SINGER and Red "S" Trademarks. When your machine needs servicing call your SINGER SEWING CENTER to be sure of warranted SINGER parts and service. See address in the classified telephone directory.

T H E S I N G E R C O M P A N Y