

# BT-600 Extended Range Barbecue Thermometer

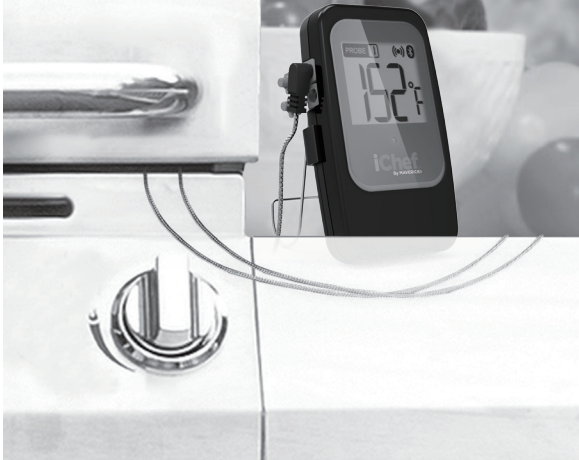

Thank you for selecting the **BT-600 Extended Range Barbecue Thermometer** with **Insta-Sync™** Technology. Simply Download the Free **iChef BT-600** App from the Apple Store or Google Play Store, and follow the easy instructions that will turn your iPhone, iPad, Android or Tablet into a remote thermometer.

**iChef**  
By MAVERICK

## GETTING STARTED

### Step 1:

Preheat your grill, smoker or oven to your desired roasting temperature.

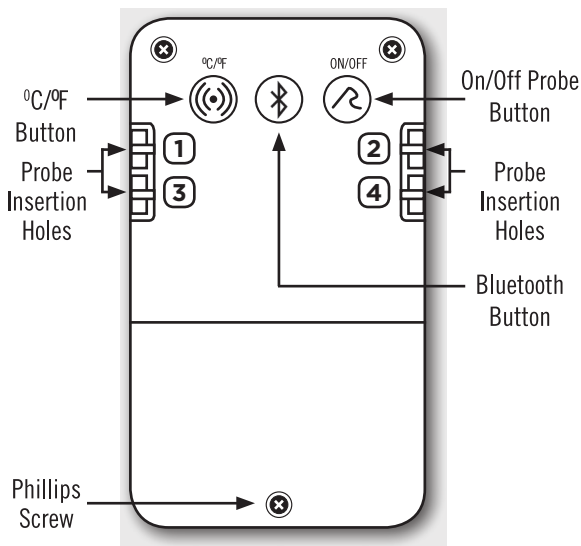

**Back of the BT-600 Extended Range Barbecue Thermometer shown here**

### Step 2:

Remove the **BT-600** Thermometer back cover with a small Phillips screwdriver. Install **2 AAA** batteries (not included) and replace back cover.

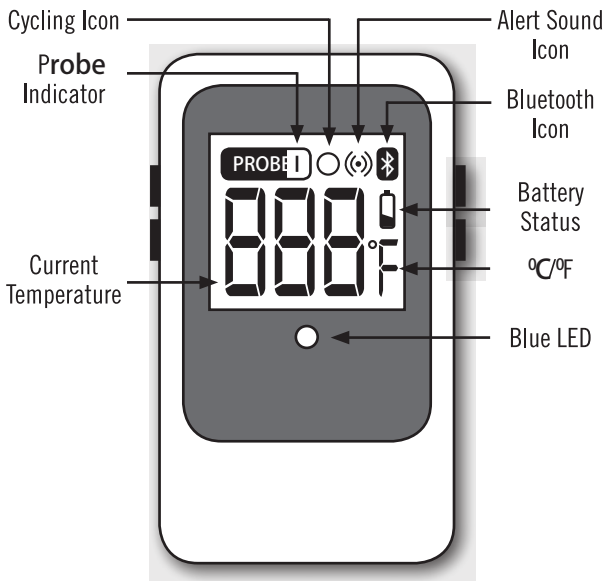

### Front of the BT-600 Extended Range Barbecue Thermometer shown here

#### Step 3:

Remove protective plastic film from the **BT-600** Thermometer front screen. On the back of the unit, press **ON/OFF Probe** button for 3 seconds. Blue LED and Bluetooth Icon will be blinking. If they don't blink, press **BLUETOOTH** Icon button to connect. Press **°C/°F** button to select temperature mode.

Front of the  
BT-600 Barbecue Thermometer  
shown here

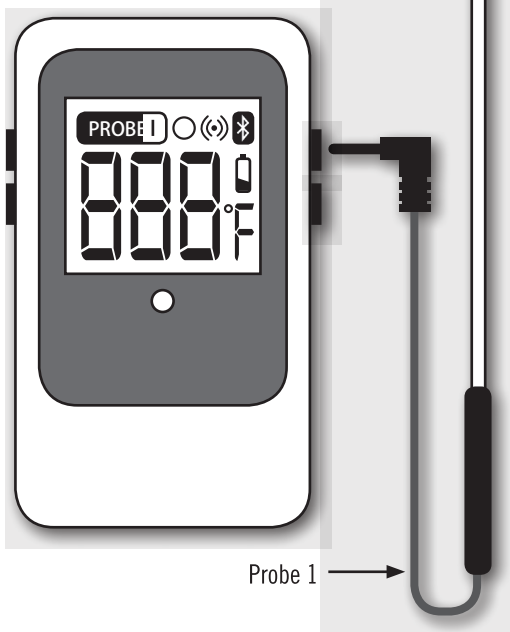

**Step 4:**

Open rubber cover and insert metal probe into slot [1]. On the front of the Thermometer, Probe indicator will be cycling 1, 2, 3, 4. Quickly press **ON/OFF Probe** button to set **Probe 1**.

### Step 5:

On your iPhone, iPad, Android or Tablet, go to **Settings** and turn on **Bluetooth**.



### Step 6:

Go to the Apple App Store or Google Play Store to download the Free **iChef BT-600** App. When searching for the App, make sure to type "**iChef BT-600**". Once you have successfully downloaded the **iChef BT-600** App, open it.



**iChef BT-600** App icon

### Step 7:

When you turn on the **iChef BT-600** App, screen (A) will appear. Tap the unit displayed at the top to pair to **Bluetooth**. Your **BT-600 Extended Range** Thermometer unit may have its own unique name which may be different than the one shown below.

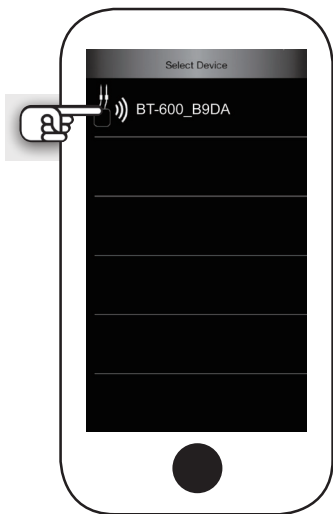

(A)

## Step 8:

Now you are on screen (B). Tap **Setting** at lower right corner of the screen.



## Step 9:

Now you are on screen (C). Select Temperature Unit **°C** or **°F**. Next, select **Alert sounds**.

### Step 10:

Now you are on screen (D). Select your preferred alert sound. Tap **Confirm**.



### Step 11:

Now you are back on screen (C). At the bottom left of the screen, tap **Thermometer**.



## Step 12:

Now you are back on screen (B). Tap photo in center of your screen to set Probe [1].

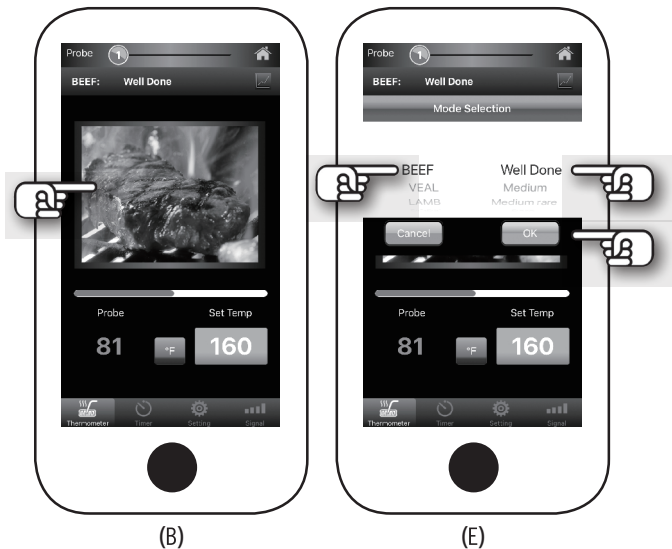

## Step 13:

You are now on screen (E). Scroll through the meat or BBQ options on the left side of your screen and make a selection. (For directions on how to set the BBQ option, go to page 14 of this manual.) Then scroll down the right side of the screen to choose a preset temperature for desired doneness or select a Customized doneness temperature. Tap **OK**.

If you select **Customized Temperature**, you will open up screen (F). Input a **Customized Temperature** setting and then tap the return arrow. It will store and go back to display the **Set Temperature**.



(F)

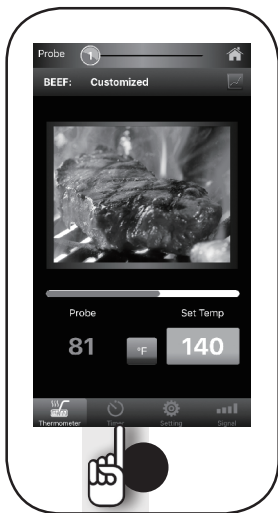

(B)

### Step 14:

You are now back on screen (B). At bottom center of the screen, tap **Timer**.

### Step 15:

You are now on screen(G1). The **Timer** may be set to determine doneness in addition to, or instead of, the preset or **Customized Temperature** setting. Tap the 00:00:00 timer and scroll to set cooking time in hours, minutes and seconds, as screen (G2). When you are ready to start the **Timer**, tap the green button.

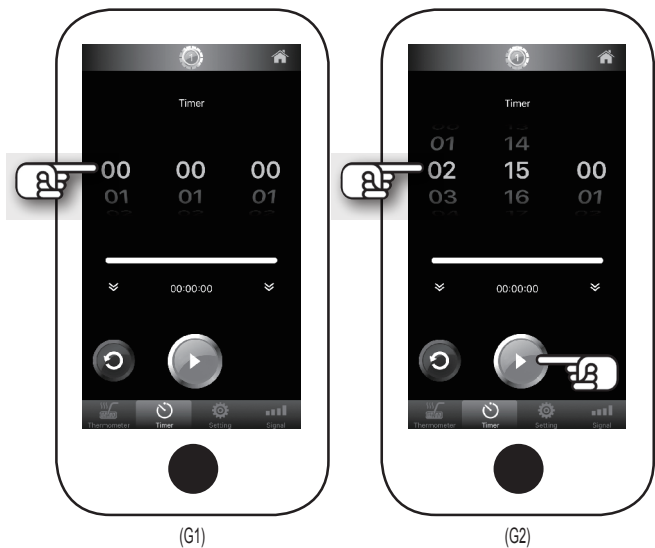

## Step 16:

Insert the metal probe tip into the center of the meat. Place the meat onto the grill or into the oven but leave the probe wire and the **BT-600** Thermometer outside the grill cover or oven door. Be sure the probes and wires do not come in direct contact with the flame on your grill. When the internal temperature of the meat reaches the programmed doneness, the alert will sound on your smart device and the temperature setting on the **iChef BT-600** App will flash.

### Monitor Your Cooking:

Tap **Home** Icon to get to screen (H). Now you can monitor your [1] Probe temperature progress.

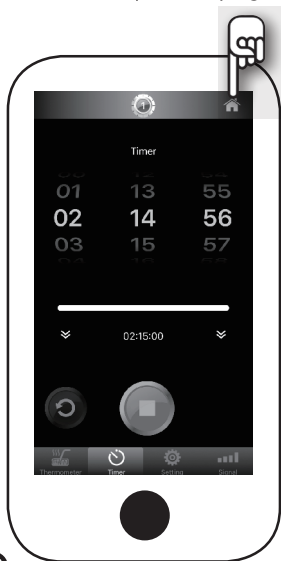

(G)

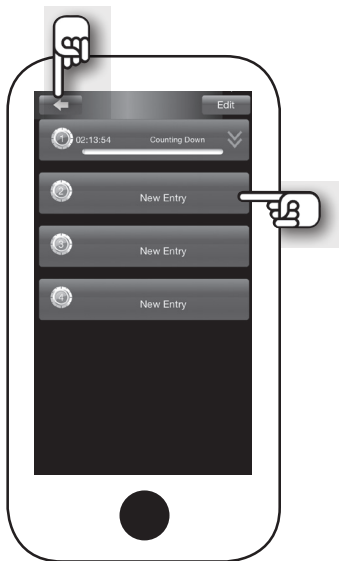

(H)

## Step 17:

Now you are back on screen(I) Tap graph icon near the top right corner to display temperature vs Time graph of each probe. You can see on screen(J) It is real time monitor the probe temperature and display the historical data in graphical format.

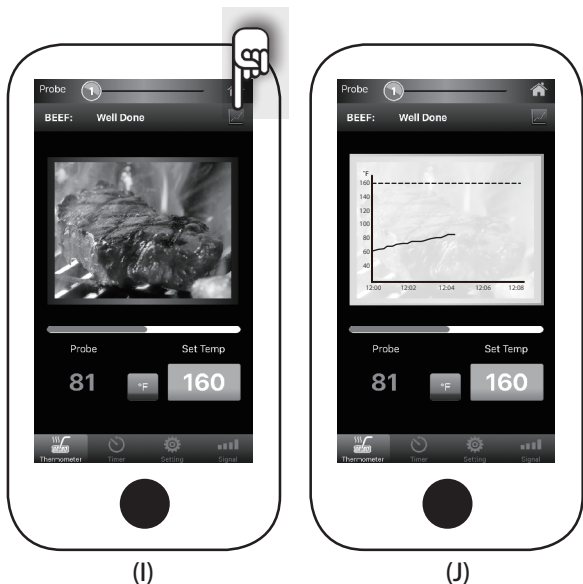

## Program Additional Probes:

Press back arrow to set additional probes. Follow previous **Step 12 and 13** to program up to three additional probes. The **BT-600 Extended Range Barbecue Thermometer** comes with two probes. To purchase additional probes, go to [www.maverickthermometers.com](http://www.maverickthermometers.com).

## BBQ Mode Selection:

Scroll to the **BBQ** setting on the left of the screen. Tap **OK**, see(K1). The **BBQ** option allows you to monitor the grilling temperature from an optimum High 572°F to an optimum Low -4 °F. Tap your desired **High Temperature** and then tap the return arrow in lower right corner, see(K2). Now tap in desired **Low Temperature**, see(K3). If the grill temperature falls out of either your High or Low set temperature range, your smart device will alert you so you can adjust the grill's heat settings.

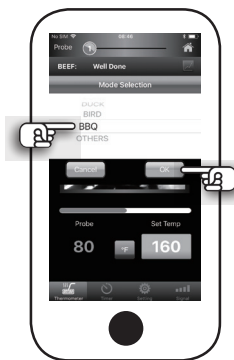

(K1)

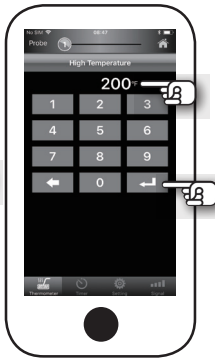

(K2)

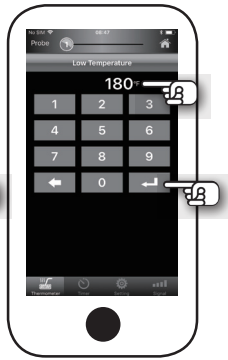

(K3)

Attach the probe securely onto the grill grates using the enclosed grill clip/s. Make sure the probes and their wires do not come in direct contact with the flame on your grill.

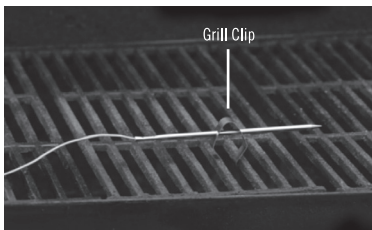

## Important BT-600 Extended Range Barbecue Thermometer Information

- To turn off the **BT-600**, press and hold the ON/OFF button for 3 seconds.
- When you are on the **Timer** screen (G), you can swipe the screen to the left to reveal the **Stopwatch** function.
- Do not touch hot stainless steel probes or wires with bare hands. Always wear heat resistant gloves before removing probes and wires from food during or just after cooking.
- **iChef BT-600** temperature range is  $-4^{\circ}\text{F}$  to  $572^{\circ}\text{F}$  ( $-20^{\circ}\text{C}$  to  $300^{\circ}\text{C}$ ).
- Clean the Food Probe and Probe Wires by wiping them with a soft cloth and warm, soapy water. Do not immerse the Probe Jacks or Thermometer in water or dishwasher.
- Optimum Bluetooth range is 300 feet. This is under ideal conditions with no obstructions and a straight line between the thermometer and your smart device. Actual range may be less.

### Cooking Tips

- When inserting the Food Probe, be sure the tip is not touching bone or resting in fat.
- For steaks and chops, insert the Food Probe from the side to the center.
- Allow meats to rest 3 to 5 minutes or longer before slicing to allow its flavorful juices time to redistribute throughout the meat.
- Meat continues to cook while resting. Final doneness temperature can increase 3 to 10 degrees.

## **Maverick Limited 1-year Warranty**

Maverick Industries, Inc. warrants this product to be free of defects in parts, materials and workmanship for a period of 1 year from date of purchase. Should any repairs or servicing under this warranty be required, contact Maverick Customer Service by mail or phone for instructions on how to pack and ship the product to Maverick's National Service Center located as follows:

## **Maverick Customer Service**

94 Mayfield Ave.

Edison, NJ 08837

Telephone: (732) 417-9666

Hours: Weekdays 8:30 am - 4:30 pm

Do not send any parts or product to Maverick without calling and obtaining a Return Authorization Number and instructions. This warranty is VOID if instructions for use are not followed; for accidental damage; for commercial use; for damage incurred while in transit; or if the product has been tampered with. This warranty gives you specific legal rights and you may also have other rights which vary from state to state.

This device complies with part 15 of the FCC Rules. Operation is subject to the following two conditions: (1) This device may not cause harmful interference, and (2) this device must accept any interference received, including interference that may cause undesired operation.



**iChef**<sup>™</sup>  
By MAVERICK

[www.maverickthermometers.com](http://www.maverickthermometers.com)