



Reign Two Story Playhouse Assembly Guide & Warranty

Please Read and Retain this document

Includes warranty replacement instructions and important safety information

Contents
Warnings
Maintenance
Assembly Prep
Tools and Part Inventory
Step-by-Step Assembly

WARNINGS AND SAFE PLAY

WARNINGS AND FAQs



Read this entire manual before assembling the playhouse.

Keep manual after assembly to easily order replacement parts or to disassemble properly.

Assembly requires two adults. If necessary, seek professional help to assemble if you are uncertain about any of the steps listed.

Prepare recommended area before beginning assembly.

Please see "Assembly and Layout" for further information.

Playhouse must be completely assembled and inspected for sharp edges or protruding hardware before use by children.

Failure to do so may result in injury and/or voiding of warranty.

Missing or damaged parts? Please email info@2mamabees.com or call 833-MAMABEE (626-2233). (You will need Playhouse Model and part number. Playhouse Model is found on the front page of this manual and part numbers and descriptions are listed on each page).



WARNING

RISK OF SERIOUS HEAD INJURY

Install and maintain proper shock absorbing material under playset as recommended. Improper installation over hard surfaces (dirt, grass, asphalt, concrete) creates a risk of serious injury or death due to falls.

COLLISION RISK

Location of playset should be at least 6 feet from all large objects. This includes house, garage, sheds, and trees and smaller objects such as fences, poles, planters, pavement, laundry/electrical lines, and overhanging branches. Create an obstacle free zone per diagram in "Assembly and Surface Preparation" section.

STRANGULATION RISK

Ropes and chains pose a strangulation risk. Never allow children to play with cord-like items in improper ways. Do not allow children to attach additional cord-like items to playset.

TIPPING RISK

Playset must be installed on flat and even surfaces to reduce the chance of the playset tipping over.

Make sure playset is properly anchored and verify stability between each use.

PROPER USE

- Adult supervision required at all times. Complying will reduce risk of serious and fatal injuries.
- Products are designed to meet voluntary and mandatory safety standards.
- Playhouse is intended for children ages 3 to 10 years of age.
- Capacity is 9 users maximum at any time.
- Weight limit of children - 110lbs (49.9kg) per child
- Maximum fall height - 51.96 inches
- Playhouse is designed for outdoor use in private at-home settings only (per ASTM F1148-18).
- Playhouse is not intended for public or business use (such as daycare, preschool, nursery, or other commercial applications). Any use of this sort will void warranty.
- Do not modify design of playhouse or swings.
- Do not let children climb on roof or top bar of swing set.
- Do not walk close to or in front of moving items.

SAFE PLAY

To reduce the risk of injury or death, you must follow these instructions:

- Adult supervision required at all times when the playhouse is being used.
- Go over warnings and proper use with children before use. Teach children proper use including safe front and back swinging practices.
- Make sure moving equipment has come to a complete stop before child gets off.
- Adults should check for damaged wood, missing or loose hardware, or any sharp edges before every use. Replace, tighten and smooth rough edges between uses. Lubricate any moving parts when needed.
- Do not install home playground equipment over concrete, asphalt, packed earth, grass, carpet, or any other hard surface. A fall onto a hard surface can result in serious injury to the equipment user.
- Children should be dressed in well fitting clothes and wearing closed toed shoes when using playhouse.
- Children should be instructed to not twist swing chains and ropes, swinging empty seats, or looping chains over top bar.
- Children should be instructed not to swing empty swings.
- Children should be instructed to not use equipment in a manner other than intended. They should be shown how to sit in the center of the swing with their full weight on the seat.
- Children should not wear bicycle or sports helmets or any headgear with chinstrap to avoid catching on playhouse.
- Adults should ensure the playhouse is on a flat and level surface and does not rock due to an uneven spot. Check the depth of surface under and around the playhouse regularly. Add material to maintain minimum required depth and rake to keep level. See Assembly and Layout for more information.
- Check surface temperatures on hot days to ensure plastic, metal and wood surfaces could burn children during use.
- Surfaces can be cooled with water. Wipe everything dry before use.
- If surfaces are wet, dry them off before use as there is a risk of child slipping and falling.

WARRANTY AND MAINTENANCE

MAINTENANCE

- All wood parts are made from weather tolerant cedar and sealed with a water-based sealant. Weathering from seasonal changes and other outdoor exposure will cause moisture content of the wood to shift and cause cracking, warping, and fading. While these changes will not impact the integrity of the product, we advise regular maintenance to slow the speed and amount of weathering.
- In order to slow normal weathering and ensure warranty is not voided, it is required that a layer of sealant be applied to all wood surfaces every 1-2 years (yearly for areas that are humid and hot, every 2 years for areas that are dry. Before sealing, lightly sand wood pieces where there might be rough spots. This will reduce the rate of fading.

As part of safe play, we recommend daily checks of playhouse before used by children. Checks should include the following:

- Check bolts and hardware at swing connections to ensure they are tight and secure. Replace as necessary when cracked, loose, or missing.
- Ensure ropes and chains have no damage or are looped around top bar.
- Check all protective coverings on bolts, pipes, edges, and corners. Replace if they are loose, cracked, or missing.
- Check all moving parts including swing seats, ropes, cables, and chains for wear, rust, or the deterioration. Replace or lubricate as needed.
- Check metal parts for rust. If found, sand and repaint using a non lead-based paint meeting the requirements of 16 CFR 1303.
- Check depth of loose fill. Rake as needed to prevent compacting and thin areas. Add additional layers of materials as needed.

Once a month during play season: Lubricate all metallic moving parts per manufacturer's instructions, check all moving parts including swing seats, ropes, cables and chains for wear, rust, or other deterioration. Replace as needed.

Twice a month during play season: Tighten all hardware, check all protective coverings on bolts, pipes, edges, and corners. Replace if they are loose, cracked, or missing. Rake and check depth of loose fill protective surfacing materials to prevent compaction and to maintain appropriate depth. Replace as necessary.

When temperatures drop below 32°F, remove and store swings.

LIMITED WARRANTY

All products carry a 1-year replacement warranty on all parts for manufacturer's defect (which covers wood, hardware, and accessories). Our wood carries a 5 year warranty on rot and decay as well.

This Limited Warranty does not cover:

- Labor for any inspection
- Labor for replacement of any defective item(s)
- Incidental or consequential damages
- Cosmetic defects which do not affect performance or integrity of a part or the entire product
- Vandalism, theft, improper use, failure due to loading or use beyond the capacities stated in the applicable Assembly Manual.
- Acts of nature including but not limited to wind, earthquake, storms, hail, floods, fires, excessive water exposure
- Improper installation including but not limited to installation on uneven, unlevelled, or soft ground
- Minor twisting, warping, cracking, or any other natural occurring properties of wood that do not affect performance or integrity

2MamaBees Playhouses have been designed for safety and quality. Modifications beyond painting could damage the structural integrity of product and lead to injury from product failure. Any modifications will void all warranties and guarantees.

PART REPLACEMENT -

- Cost of parts (damaged or missing) will be covered by 2MamaBees for the first year. This includes Shipping & Handling.
- All replacement parts after first year of ownership will be charged as follows - Discount on parts will decrease by 20% for every year of ownership of playhouse. (Ex - Year 1 customer pays 20% of cost
- Year 2 customer pays 40%, and so on). All shipping and handling will be covered by customer.
- Warranty is voided if use in any non-residential setting such as playgrounds, parks, daycares, or business settings.
- Warranty is non-transferable

This Warranty gives you specific legal rights. You may have other rights as well which vary from state to state or province to province. This warranty excludes all consequential damages, however, some states do not allow the limitation or exclusion of consequential damages and therefore this limitation may not apply to you.

ASSEMBLY AND SURFACE PREPARATION

Do not install on any hard surface (ex - concrete or asphalt). Doing so increases risk of serious head and other injuries from tripping or falling. Mats, outdoor carpet, and loose fill over hard surfaces do not have sufficient padding to reduce risk of use on hard surfaces. Do not use these options.

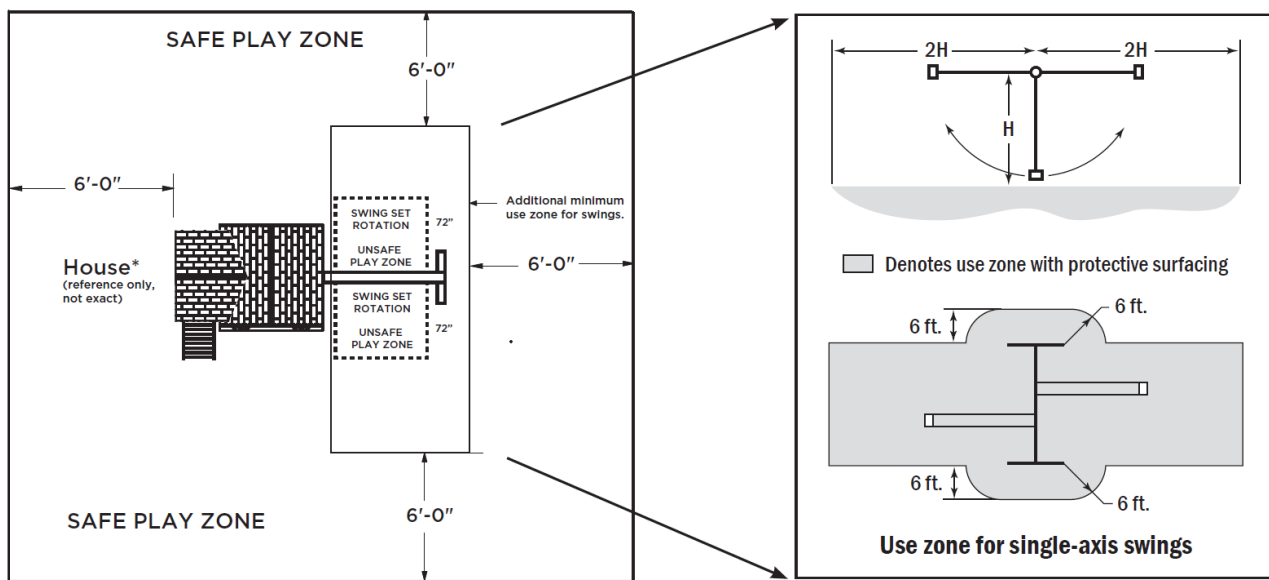

POSITIONING THE PLAYHOUSE

Playhouse is designed to be utilized on a level surface with at least 6 feet of open surface that is free of any obstruction. In order to prepare play area before beginning assembly:

- Consider locating the playhouse in an area that is convenient for adults to watch children at play.
- Remove any obstacle such as tree stumps and roots, branches, bushes, and large rocks from the play area.

RECOMMENDED PLAY AREA SURFACES

- After prepping playhouse area and installing playhouse, it is recommended to add a layer of shock absorbing material around playhouse. If used properly these materials can absorb some of the impact of a child's fall.
- We recommend the following types of surfaces: Shredded wood products and mulch, shredded tires, fine or coarse sand, or gravel
- Over time, shock-absorbing materials will compact and shift. When this happens additional material should be added and surfaces raked by an adult to maintain consistent thickness around entire playhouse.
- Please consult a landscaping professional on the required amount of material needed to meet the minimum requirement of final compressed thickness.

LOOSE-FILL MATERIALS

- Maintain a minimum depth of 9 inches of loose-fill materials such as wood mulch/chips, engineered wood fiber (EWF), or shredded/recycled rubber mulch for equipment up to 8 feet high; and 9 inches of sand or pea gravel for equipment up to 5 feet high. NOTE: An initial fill level of 12 inches will compress to about a 9-inch depth of surfacing over time. The surfacing will also compact, displace, and settle, and should be periodically refilled to maintain at least a 9-inch depth.
- Use a minimum of 6 inches of protective surfacing for play equipment less than 4 feet in height. If maintained properly, this should be adequate. (At depths less than 6 inches, the protective material is too easily displaced or compacted.)
- Use containment, such as digging out around the perimeter and/or lining the perimeter with landscape edging. Don't forget to account for water drainage.
- Check and maintain the depth of the loose-fill surfacing material. To maintain the right amount of loose-fill materials, mark the correct level on play equipment support posts. That way you can easily see when to replenish and/or redistribute the surfacing.
- Do not install loose fill surfacing over hard surfaces such as concrete or asphalt.

POURED-IN-PLACE SURFACES OR PRE-MANUFACTURED RUBBER TILES

You may be interested in using surfacing other than loose-fill materials—like rubber tiles or poured-in- place surfaces.

- Installations of these surfaces generally require a professional and are not “do-it-yourself” projects.
- Review surface specifications before purchasing this type of surfacing. Ask the installer/ manufacturer for a report showing that the product has been tested to the following safety standard: ASTM F1292 Standard Specification for Impact Attenuation of Surfacing Materials within the Use Zone of Playground Equipment. This report should show the specific height for which the surface is intended to protect against serious head injury. This height should be equal to or greater than the fall height—vertical distance between a designated play surface (elevated surface for standing, sitting, or climbing) and the protective surfacing below—of your play equipment.
- Check the protective surfacing frequently for wear.

PLACEMENT

Proper placement and maintenance of protective surfacing is essential. Be sure to;

- Extend surfacing at least 6 feet from the equipment in all directions.
- For to-fro swings, extend protective surfacing in front of and behind the swing to a distance equal to twice the height of the top bar from which the swing is suspended.
- For tire swings, extend surfacing in a circle whose radius is equal to the height of the suspending chain or rope, plus 6 feet in all directions.

PLAYGROUND SURFACING MATERIALS APPENDIX A

APPENDIX A

Information on Playground Surfacing Materials:

The following information is from the United States Consumer Product Safety

Commission's Information Sheet for playground surfacing material; also see the following website for additional information:.

www.cpsc.gov/cpscpub/pubs/323.html

X3. CONSUMER INFORMATION SHEET FOR PLAYGROUND SURFACING MATERIALS11

X3.1 Select Protective Surfacing—One of the most important things you can do to reduce the likelihood of serious head injuries is to install shock-absorbing protective surfacing under and around your play equipment. The protective surfacing should be applied to a depth that is suitable for the equipment height in accordance with ASTM Specification F 1292. There are different types of surfacing to choose from; whichever product you select, follow these guidelines:

X3.1.1 Loose-Fill Materials:

X3.1.1.1 Maintain a minimum depth of 9 inches of loose-fill materials such as wood mulch/chips, engineered wood fiber (EWF), or shredded/recycled rubber mulch for equipment up to 8 feet high; and 9 inches of sand or pea gravel for equipment up to 5 feet high. NOTE: An initial fill level of 12 inches will compress to about a 9-inch depth of surfacing overtime. The surfacing will also compact, displace, and settle, and should be periodically refilled to maintain at least a 9-inch depth.

X3.1.2 Use a minimum of 6 inches of protective surfacing for play equipment less than 4 feet in height. If maintained properly, this should be adequate. (At depths less than 6 inches, the protective material is too easily displaced or compacted.) NOTE: Do not install home playground equipment over concrete, asphalt, or any other hard surface. A fall onto a hard surface can result in serious injury to the equipment user. Grass and dirt are not considered protective surfacing because wear and environmental factors can reduce their shock absorbing effectiveness.

Carpeting and thin mats are generally not adequate protective surfacing. Ground level equipment such as a sandbox, activity wall, playhouse or other equipment that has no elevated play surface – does not need any protective surfacing.

X3.1.3 Use containment, such as digging out around the perimeter and/or lining the perimeter with landscape edging. Don't forget to account for water drainage.

X3.1.3.1 Check and maintain the depth of the loose-fill surfacing material. To maintain the right amount of loose-fill materials, mark the correct level on play equipment support posts. That way you can easily see when to replenish and/or redistribute the surfacing.

X3.1.3.2 Do not install loose-fill surfacing over hard surfaces such as concrete or asphalt.

X3.1.4 Poured-In-Place Surfaces or Pre-Manufactured Rubber Tiles — You may be interested in using surfacing other than loose-fill materials – like rubber tiles or poured-in-place surfaces.

X3.1.4.1 Installations of these surfaces generally require a professional and are not “do-it-yourself” projects.

X3.1.4.2 Review surface specification before purchasing this type of surfacing. Ask the installer/manufacturer for a report showing that the product has been tested to the following safety standard: ASTM F 1292 Standard Specification for Impact Attenuation of Surfacing Materials within the Use Zone of Playground Equipment.

This report should show the specific height for which the surface is intended to protect against serious head injury. This height should be equal to or greater than the fall height – vertical distance between a designated play surface (elevated surface for standing, sitting, or climbing) and the protective surfacing below – of your play equipment.

X3.1.4.3 Check the protective surfacing frequently for wear.

X3.1.5 Placement — Proper placement and maintenance of protective surfacing is essential. Be sure to:

X3.1.5.1 Extend surfacing at least 6 feet from the equipment in all directions.

Owner's Manual Play House

OWNER PH-2011

This information has been extracted from the CPSC publications “Playground Surfacing — Technical Information Guide” and “Handbook for Public Playground Safety.”

Copies of these reports can be obtained by sending a postcard to: Office of Public Affairs, U.S. Consumer Product Safety Commission, Washington, D.C., 20207 or call the toll-free hot-line: 1-800-638-2772.

The American Society for Testing and Materials takes no position respecting the validity of any patent right asserted in connection with any item mentioned in this standard. Users of this standard are expressly advised that determination of the validity of any such patent rights, and the risk of infringement of such rights, are entirely their own responsibility. The standard is subject to revision at any time by the responsible technical committee and must be reviewed every five years and if not revised, either approved or withdrawn. Your comments are invited either for revision of this standard or for additional standards and should be addressed to ASTM Headquarters. Your comments will receive careful consideration at a meeting of the responsible technical committee, which you may attend. If you feel that your comments have not received a fair hearing you should make your views known to the ASTM Committee on Standards, 100 Barr Harbor Drive, West Conshohocken, PA 19428.

DISPOSAL

DISPOSAL INSTRUCTIONS:

When the playhouse use is no longer desired, it should be disassembled and disposed of in such a way that no unreasonable hazards will exist at the time the unit is discarded.

Tools Required

For safe and accurate assembly of this unit, a **2-person team** is required.

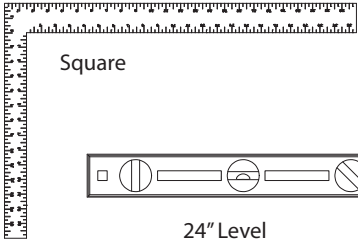
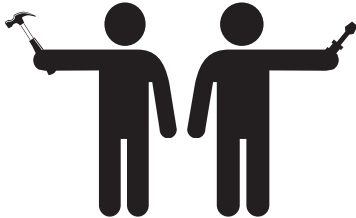

Square

24" Level



Electric Drill



Rubber Mallet



Tape Measure

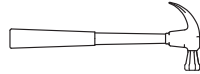

Claw Hammer

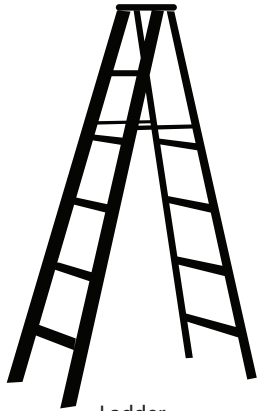

Ladder

Parts Inventory - Playhouse

All dimensions are shown in inches

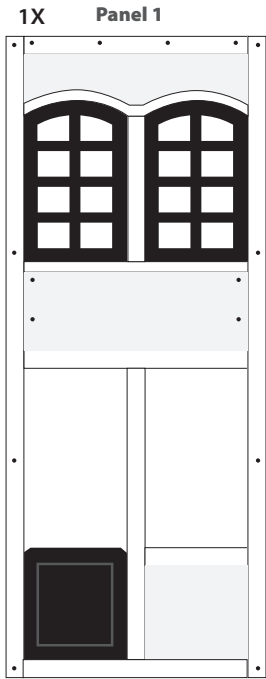

1X Panel 1

1/8 x 38 x 93 3/4

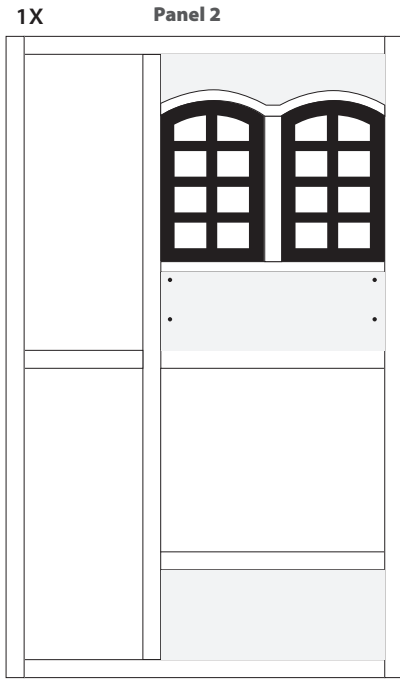

1X Panel 2

1/8 x 52 1/4 x 93 3/4

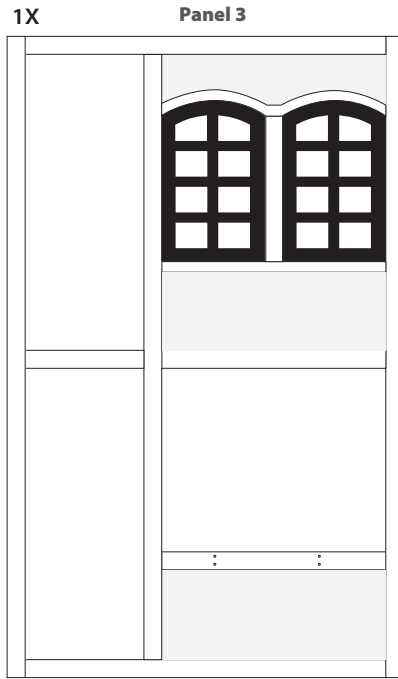

1X Panel 3

1/8 x 52 1/4 x 93 3/4

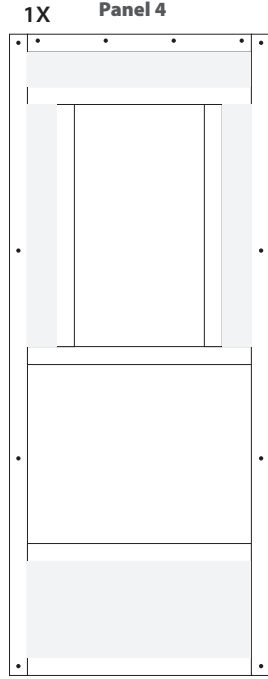

1X Panel 4

1/8 x 38 x 93 3/4

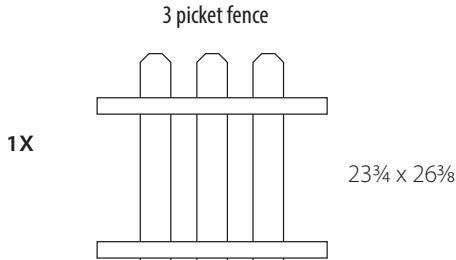

3 picket fence

1X

23 3/4 x 26 3/8

Pickets - 3/4 x 3 1/2 x 23 3/4
Cross bar - 1 1/8 x 1 7/8 x 23 3/4

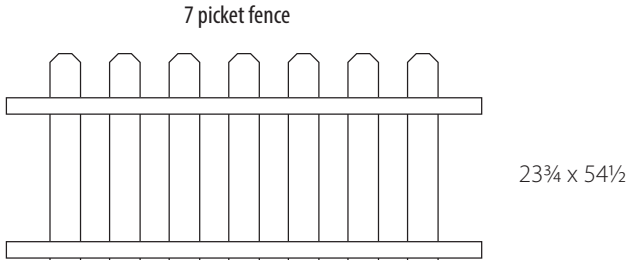

7 picket fence



1X

23 3/4 x 54 1/2

Pickets - 3/4 x 3 1/2 x 23 3/4
Cross bar - 1 1/8 x 1 7/8 x 54 1/2

Parts Included



Post Braces

- 2X  upper $\frac{3}{4} \times 2\frac{5}{8} \times 25\frac{1}{4}$
- 2X  lower $\frac{3}{4} \times 2 \times 25\frac{1}{4}$
- 2X  angle $1\frac{1}{2} \times 3\frac{1}{2} \times 25\frac{1}{4}$

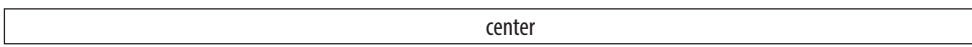

Ladder bottom brace

- 2X  $\frac{3}{4} \times 2 \times 25\frac{1}{4}$

Interior floor joists

- 1X  center $1\frac{1}{8} \times 1\frac{7}{8} \times 52\frac{1}{4}$
- 2X  side $1\frac{1}{8} \times 1\frac{7}{8} \times 52\frac{1}{4}$

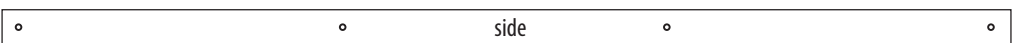

Exterior floor joists

- 1X  side $1\frac{1}{8} \times 1\frac{7}{8} \times 54\frac{1}{2}$
- 1X  w/spacing block $\frac{1}{8} \times \frac{3}{4} \times 3\frac{7}{8}$ (spacing block dim)
 $1\frac{1}{8} \times 1\frac{7}{8} \times 56$

Floorboards - interior

- 14X  $\frac{3}{4} \times 3\frac{1}{2} \times 35\frac{3}{4}$

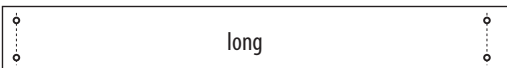
Floorboards - exterior

- 13X  long $\frac{3}{4} \times 3\frac{1}{2} \times 23\frac{3}{4}$
- 2X  short $\frac{3}{4} \times 3\frac{1}{2} \times 19\frac{1}{2}$

- 1X  deck post - left $3\frac{1}{8} \times 3\frac{1}{8} \times 92\frac{3}{4}$
- 1X  deck post - right $3\frac{1}{8} \times 3\frac{1}{8} \times 92\frac{3}{4}$

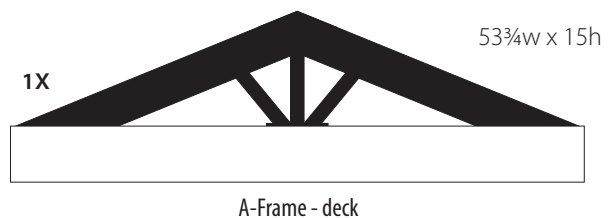
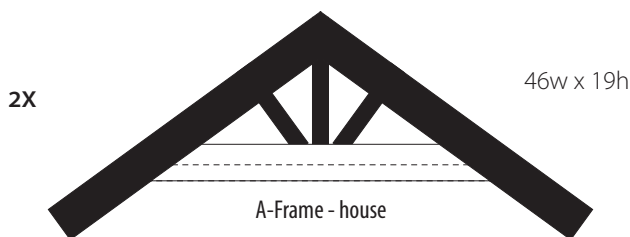

Parts Included

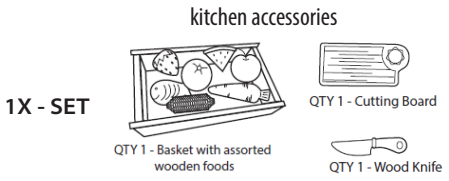
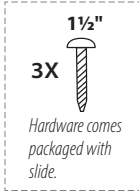
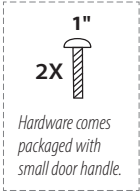
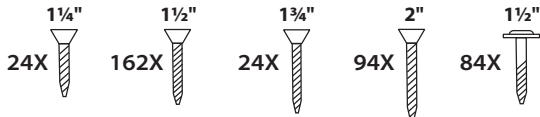
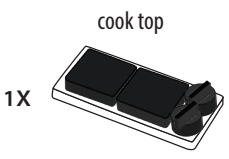
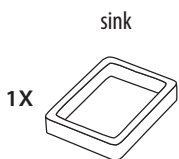
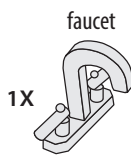
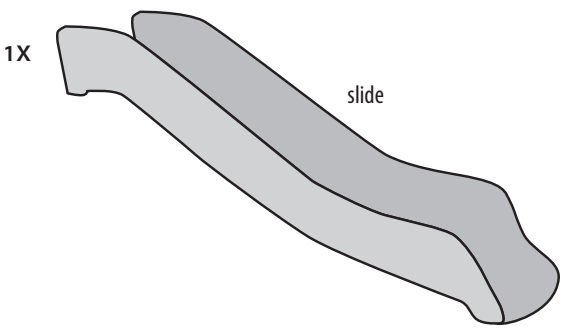
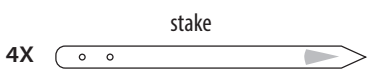
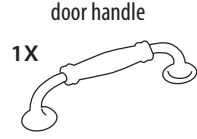
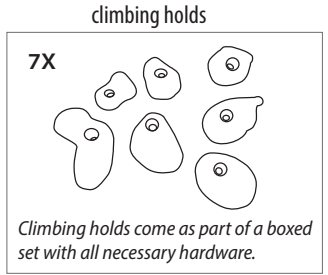
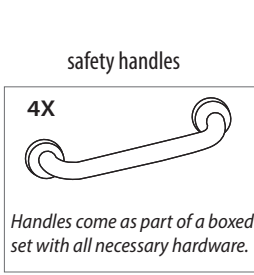
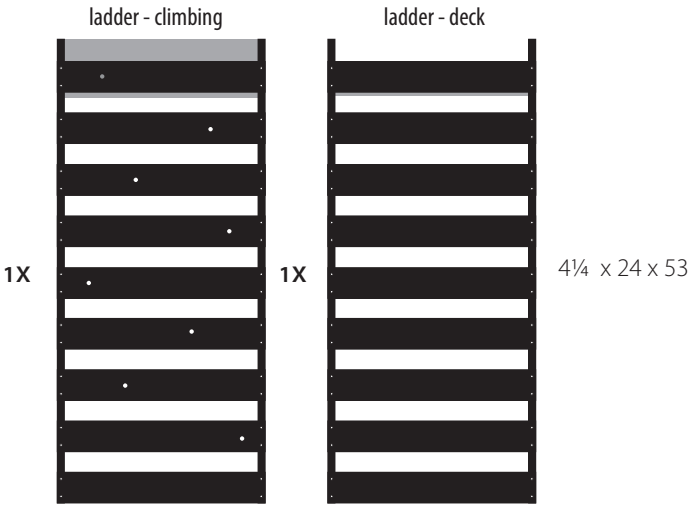
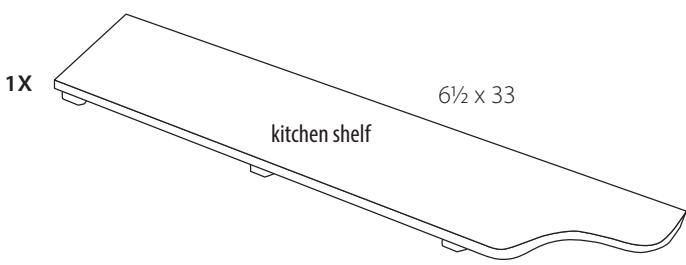
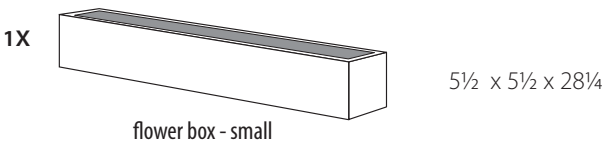
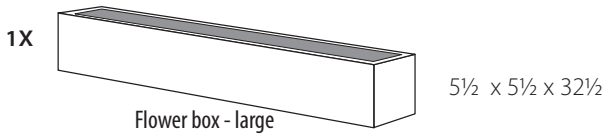
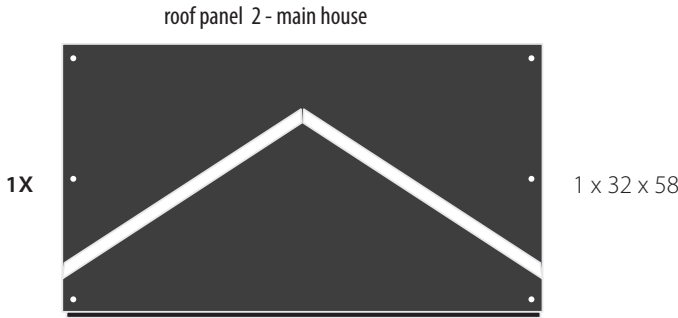
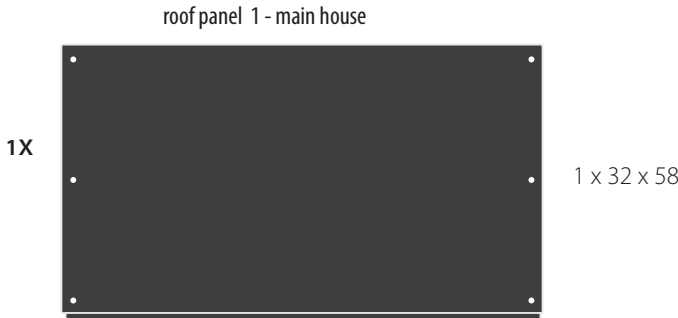
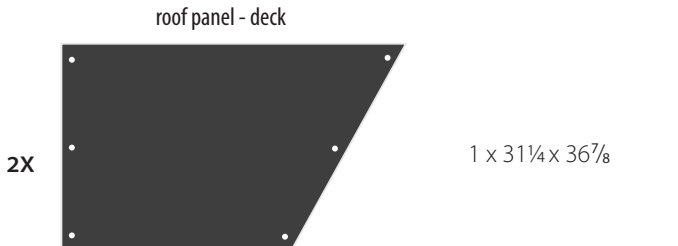

Main House

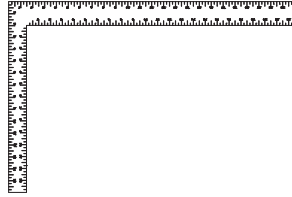

1. Attach Panel 1 to Panel 2. Use the square to ensure a 90 degree angle at the corner.

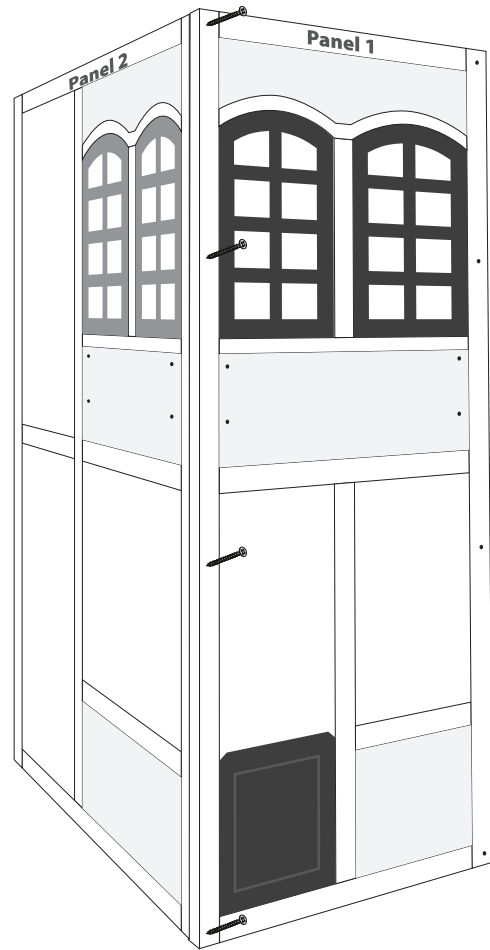
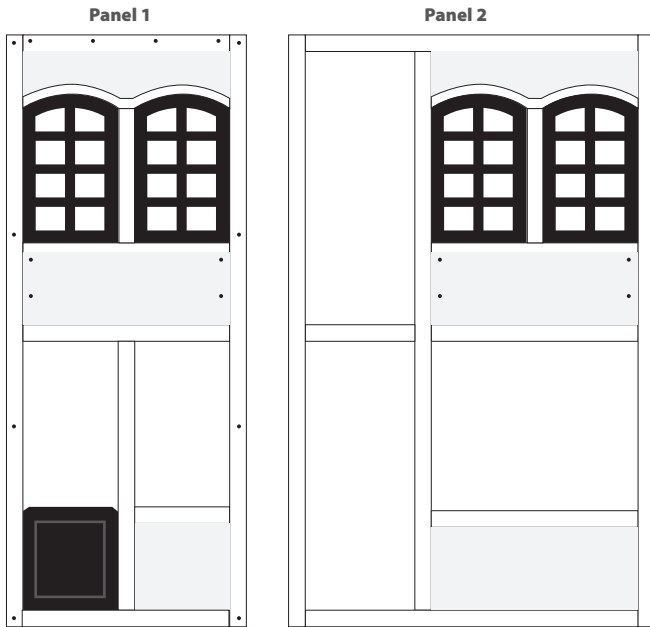
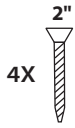

2. Attach Panel 1 to Panel 3. Use the square to ensure a 90 degree angle at the corner.

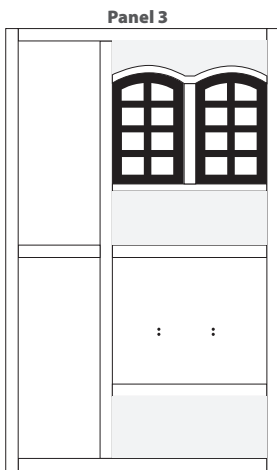

Panel 3 has pre-drilled holes for the kitchen attachment.



Main House

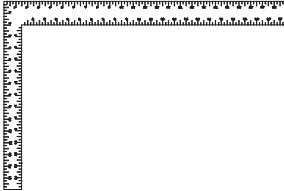

3. Attach Panel 4 to Panels 3 & 2. Use the square to ensure a 90 degree angle at the corner.

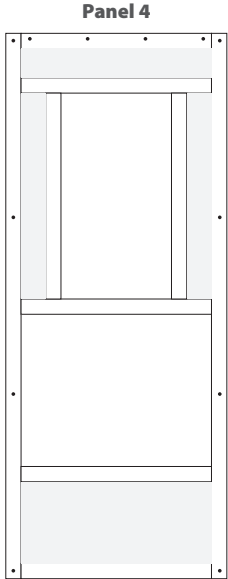

Use the square to double-check every corner has a 90 degree angle. This is essential! Additional parts may not assemble properly if this step is skipped.

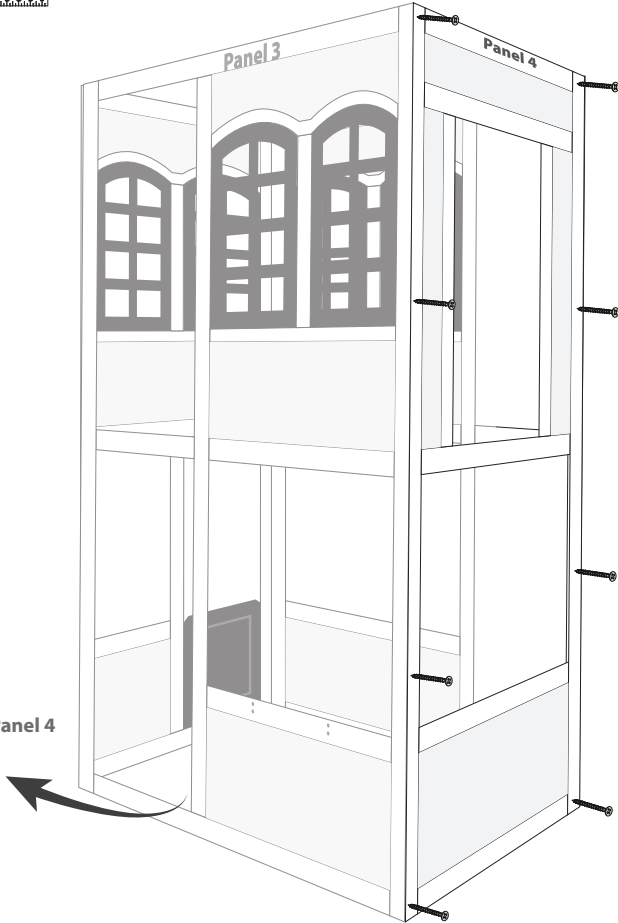
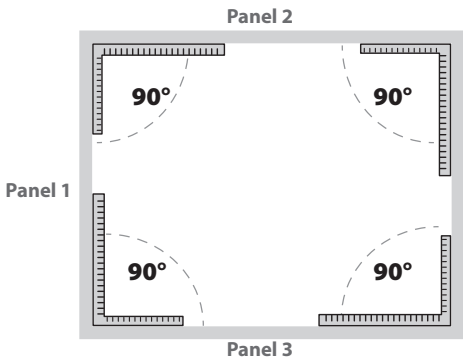

4. Attach 2 pre-drilled joists to Panels 2 & 3

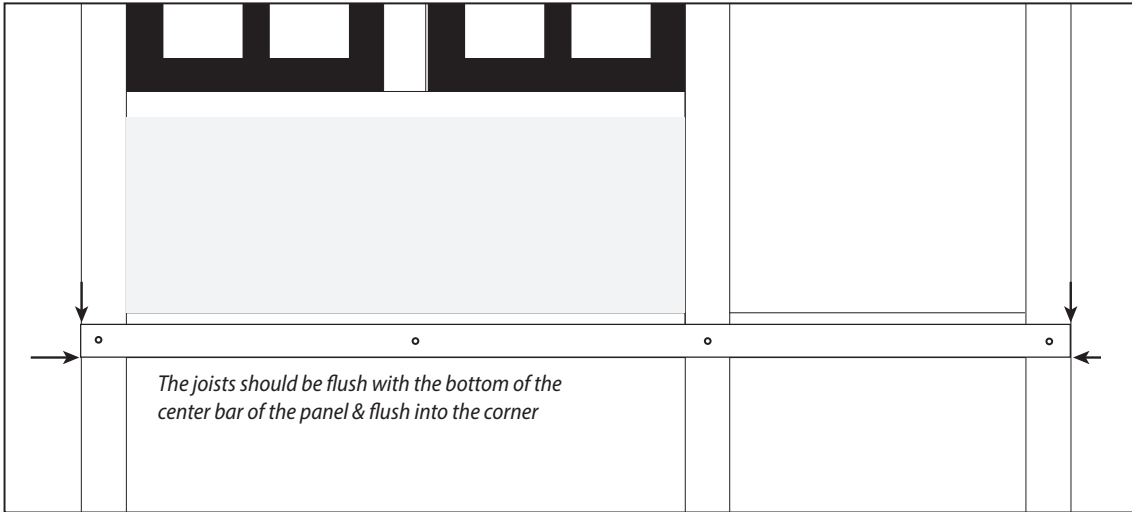
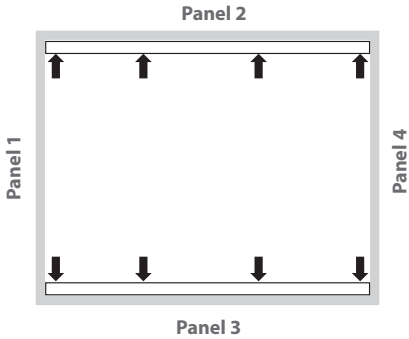

The joists should be flush with the bottom of the center bar of the panel & flush into the corner

Main House



5. Attach center joist to Panels 1 & 4

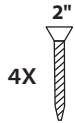

Side joists already in place.

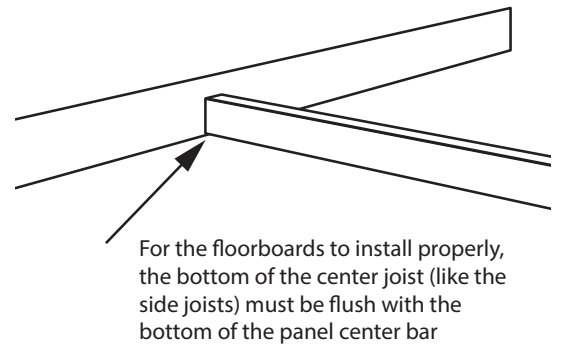
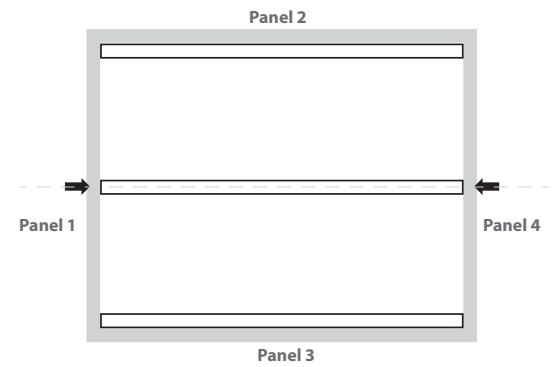
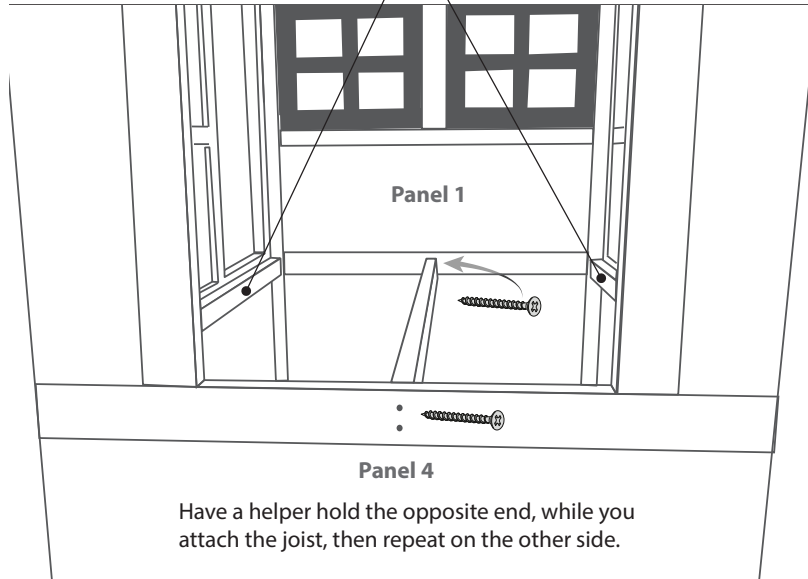

6. Install floor - First place 2 outside boards flush against the walls of panels 1 & 4, space the remaining boards evenly, attach through pre-drilled holes.

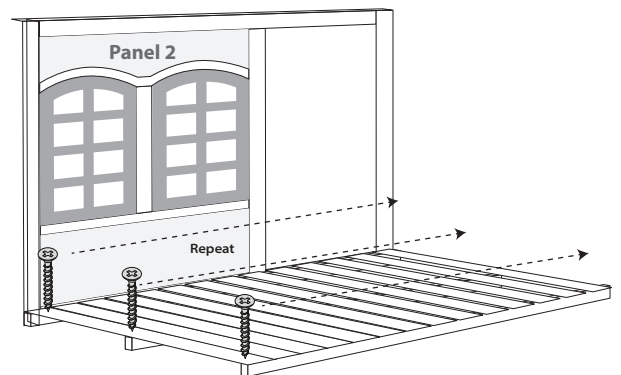
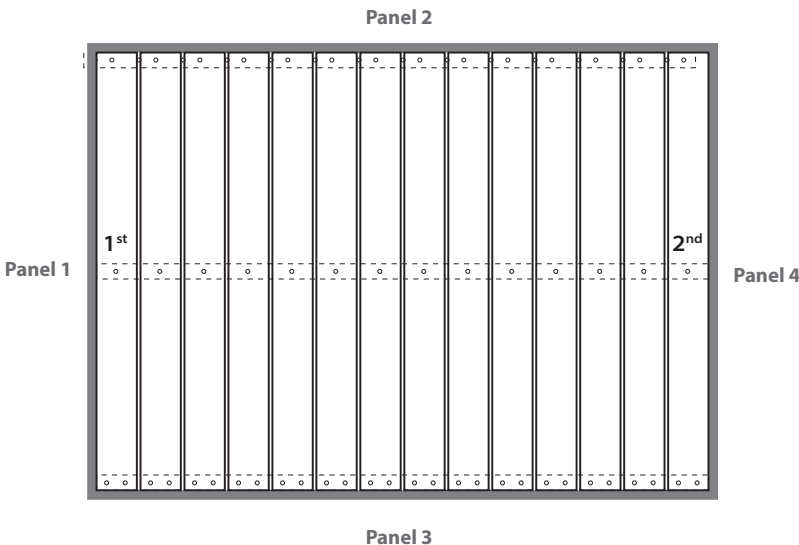
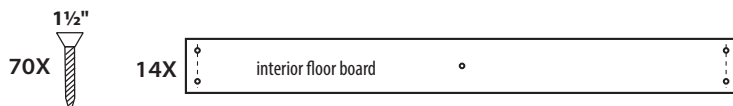

Main House

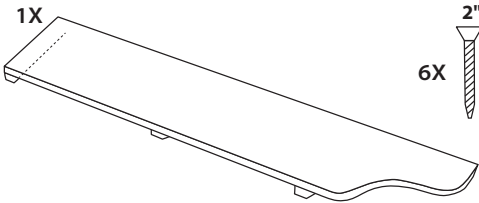

7. Attach kitchen shelf to Panels 3 & 4, flush into the corner, attach @ pre-drilled holes on Panel 3. Use 2 screws on the underside of the kitchen shelf to secure it to Panel 4.

From inside the house and underneath the shelf secure the faucet.

The sink, stove, cutting board and food should all be brought inside for safe storage.

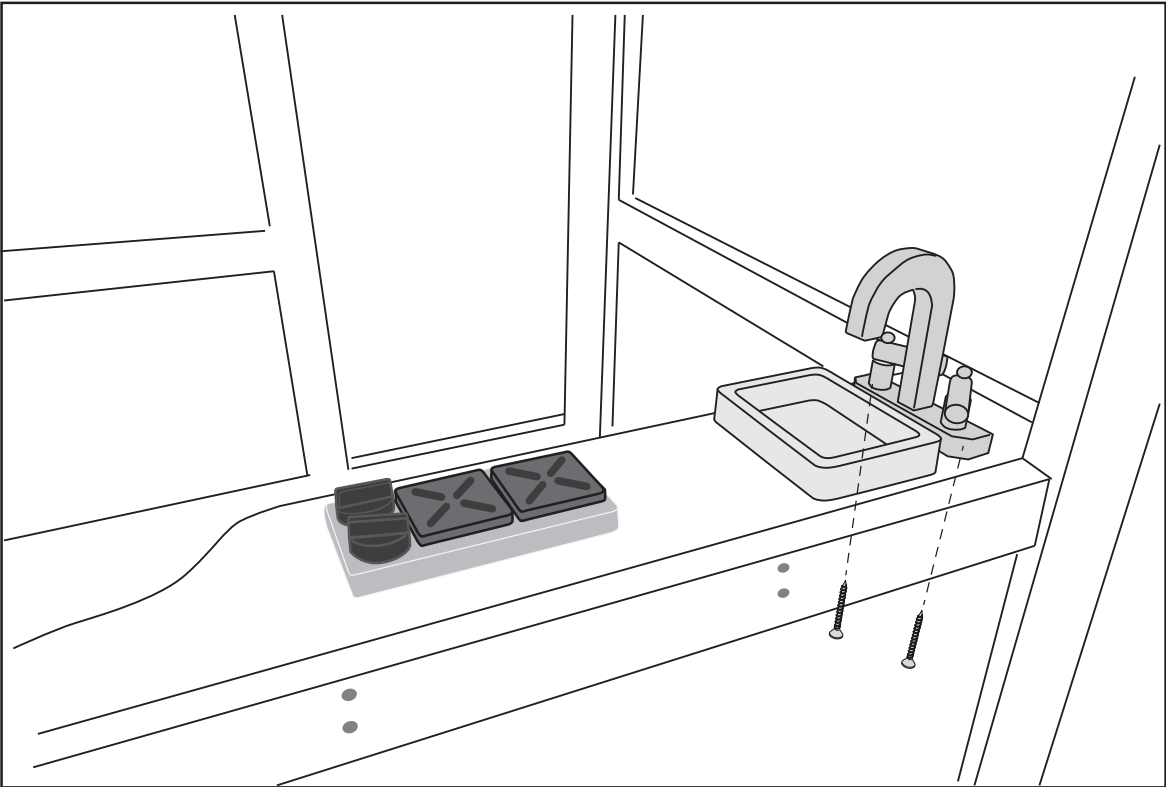
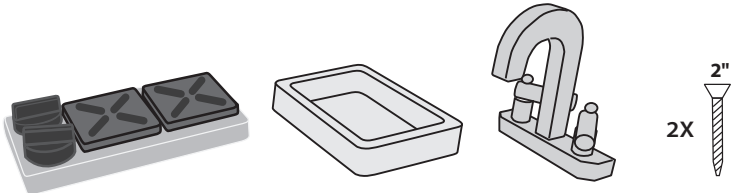
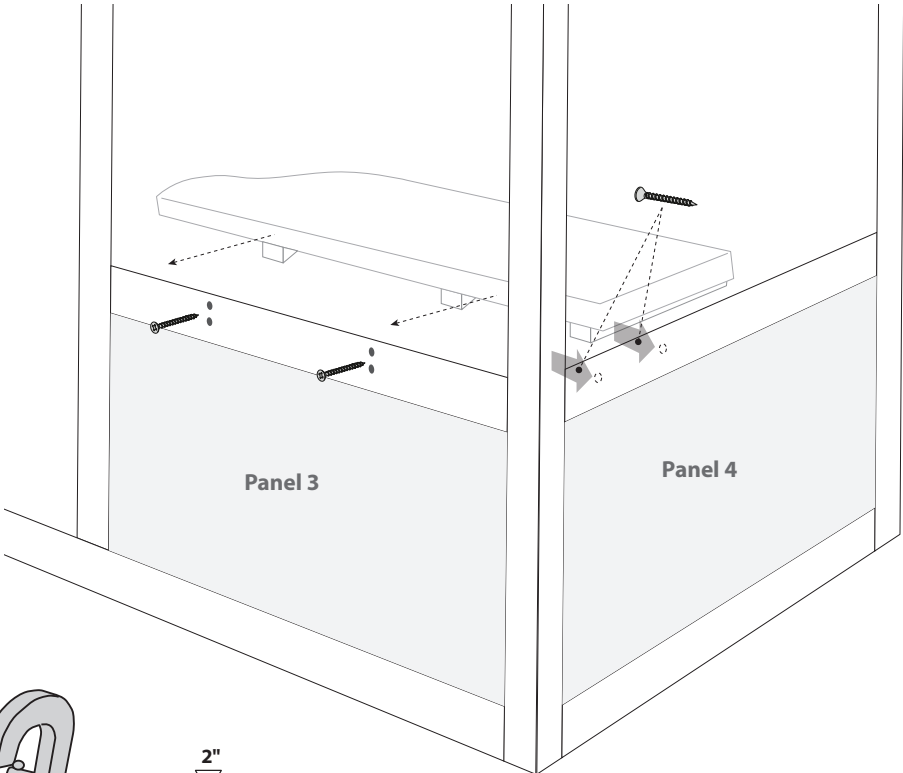

Joist & Braces

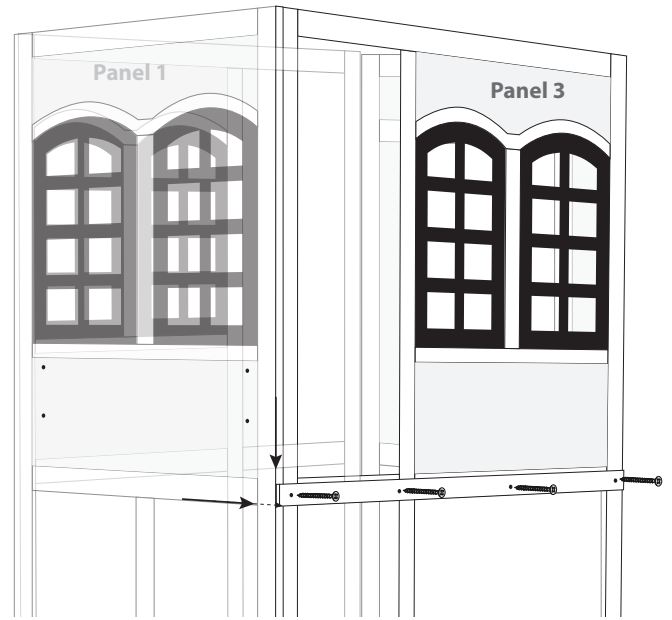

8. Attach exterior joist for deck floor – flush with bottom of middle bar on Panel 3

1X

4X

9. Attach braces. **Use LEVEL**

2X upper brace

2X lower brace

8X

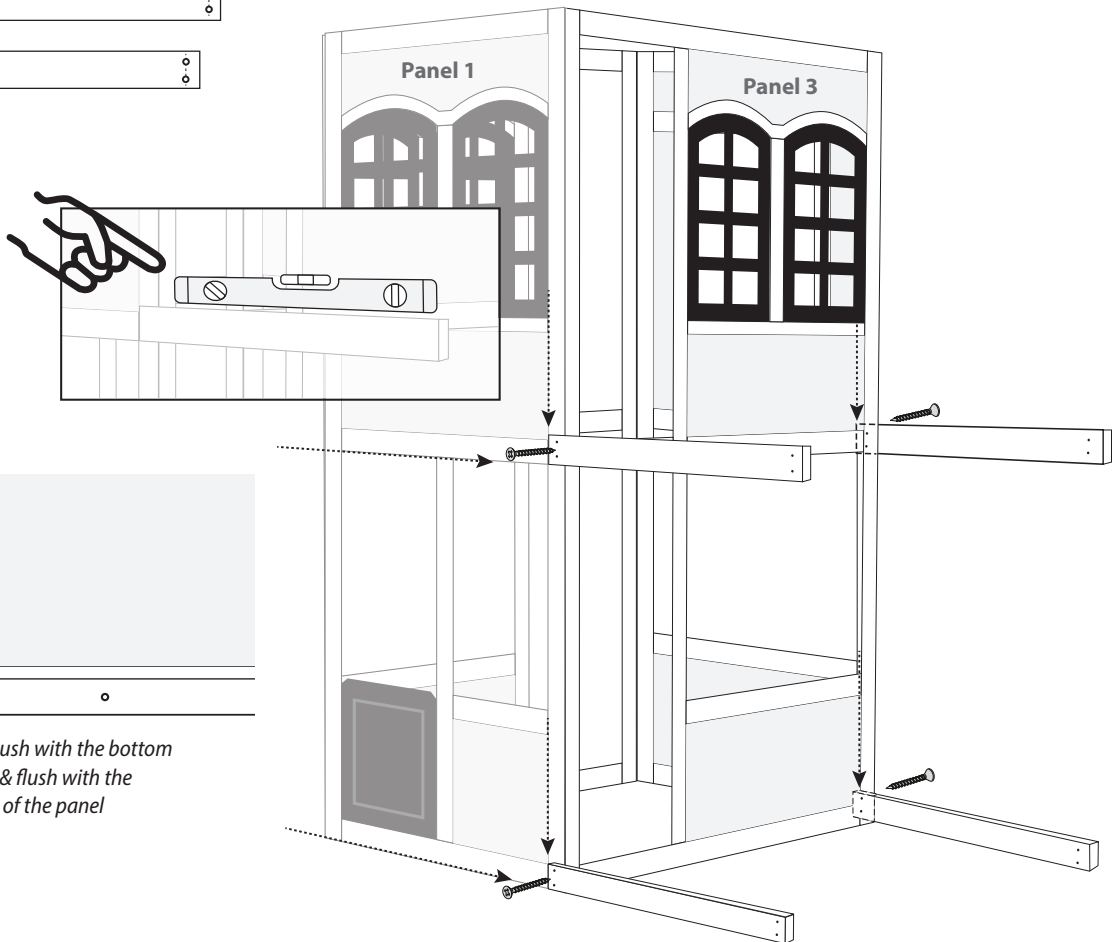

Posts & Joist



10. Attach posts to braces (with pockets facing inward)

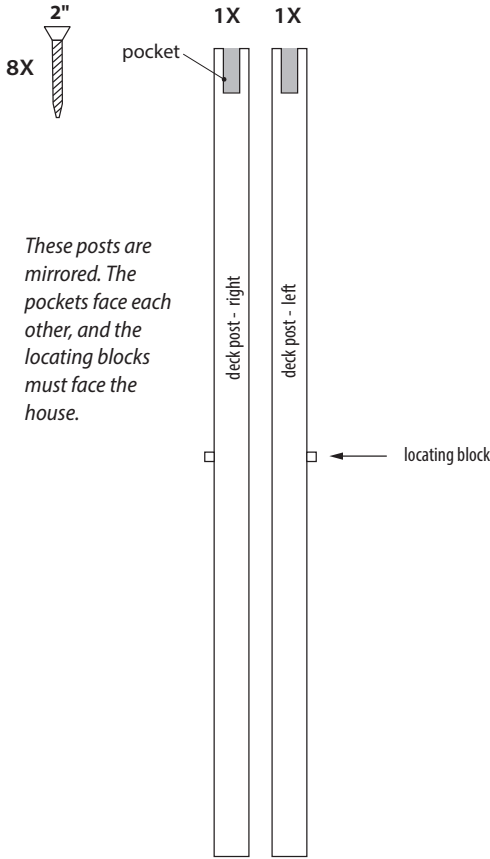

These posts are mirrored. The pockets face each other, and the locating blocks must face the house.

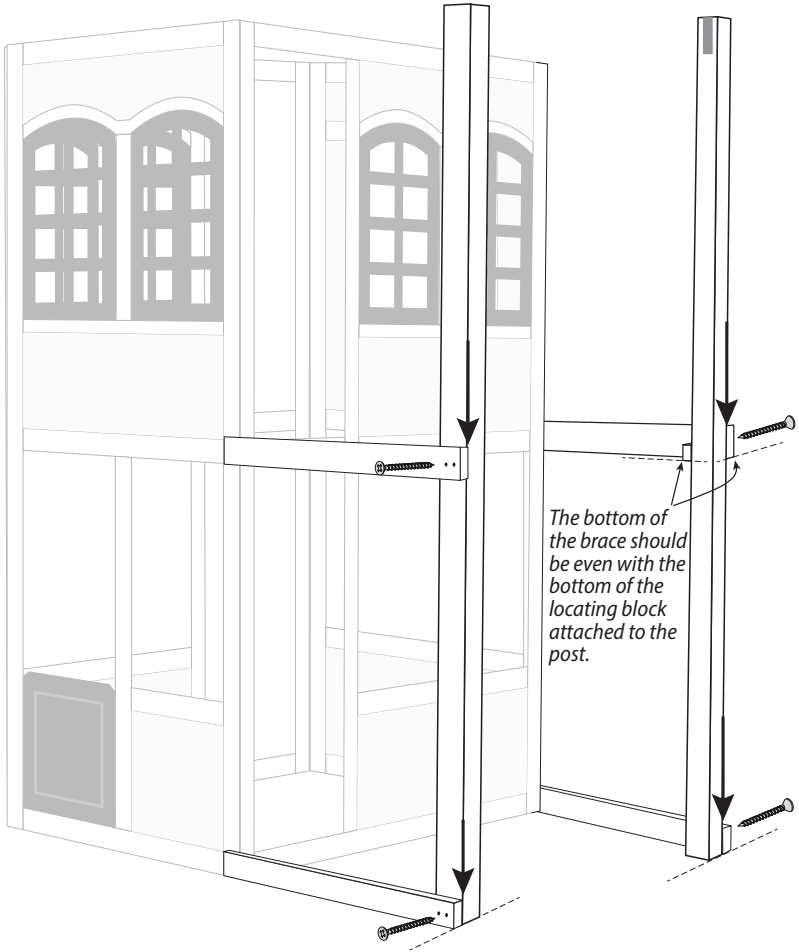

11. Attach exterior floor joist (w/spacer block on top)

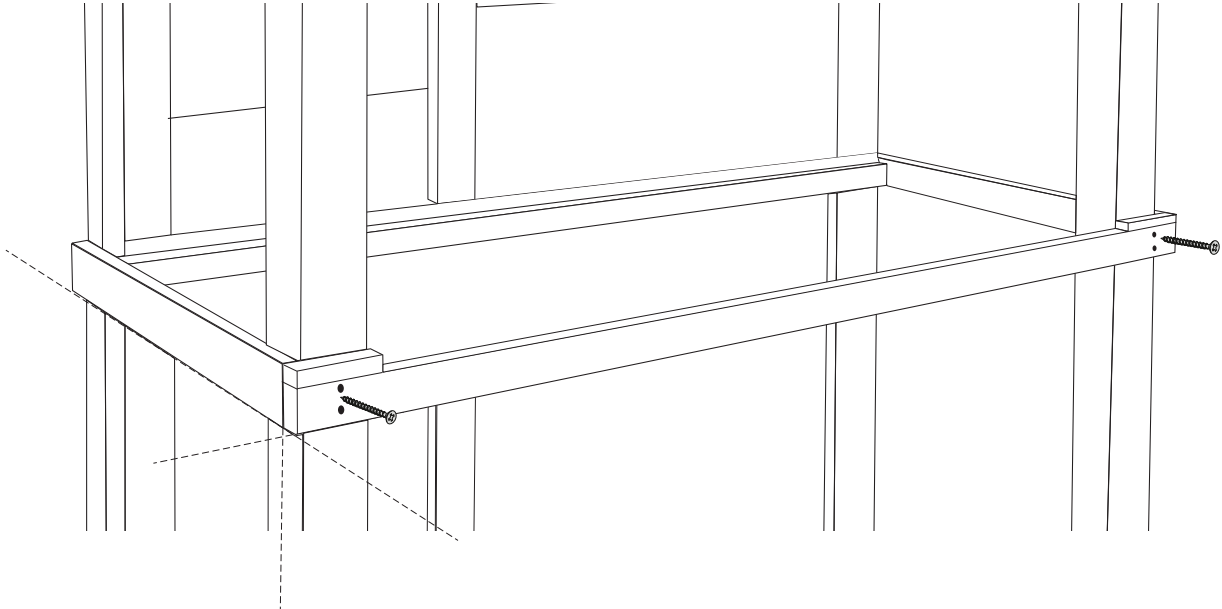
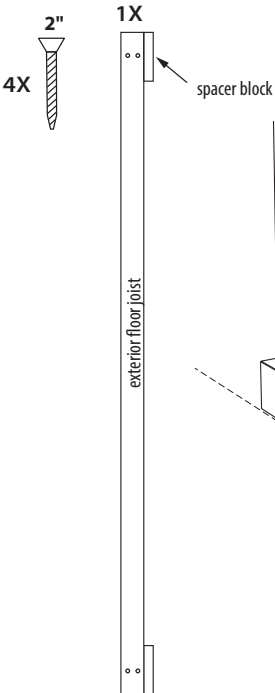

Deck & Ladders



12. Install deck floor – 2 shorter floor boards at opposite ends, remaining boards spaced evenly.

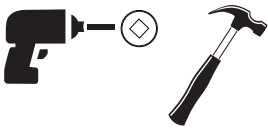
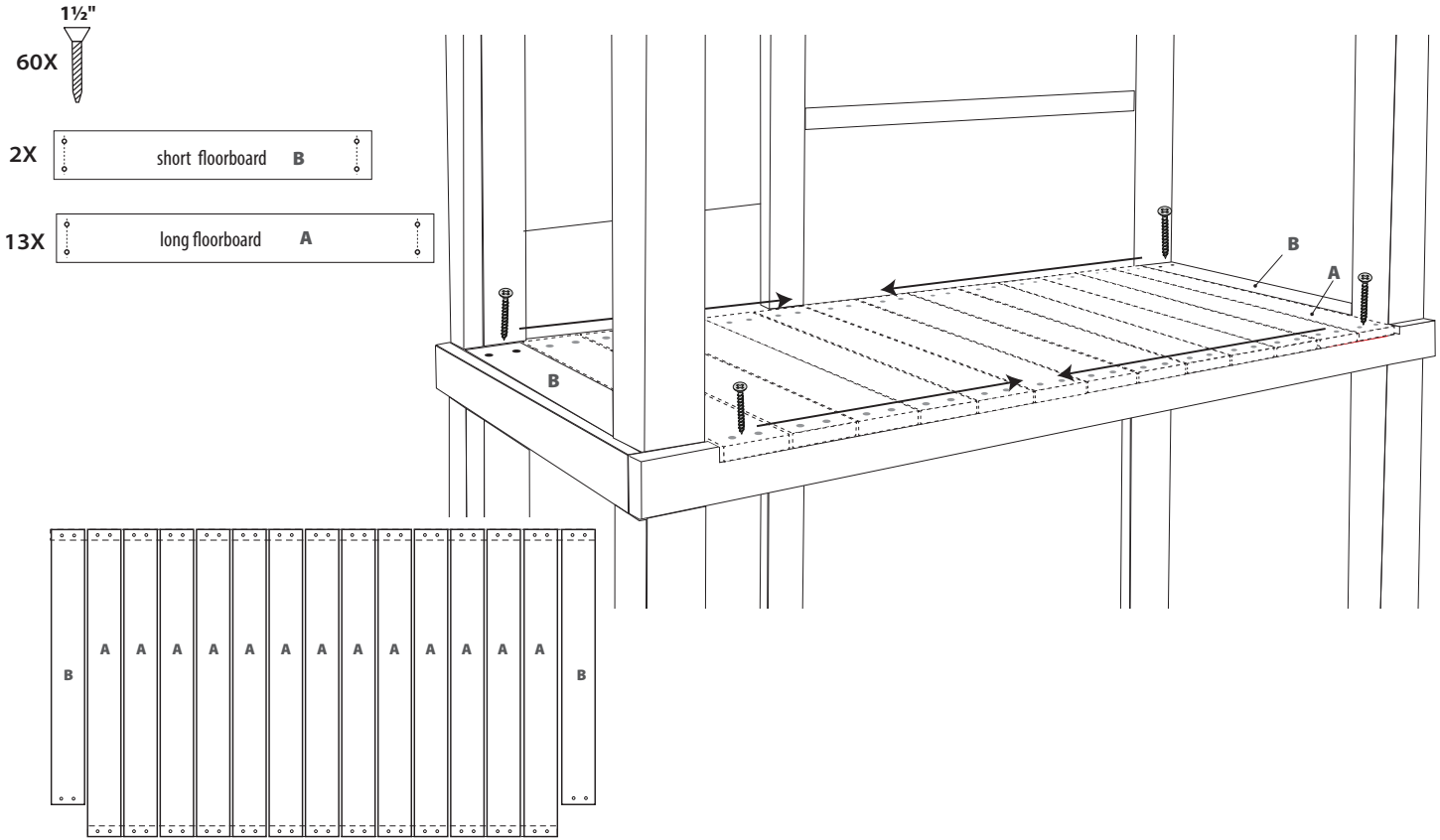

13. Installing climbing hand-holds - Turn the pre-drilled ladder over, place nuts from parts box over the pre-drilled holes and hammer firmly into the wood. Turn ladder over and install climbing hold with bolt & tighten. Repeat for remaining pieces.

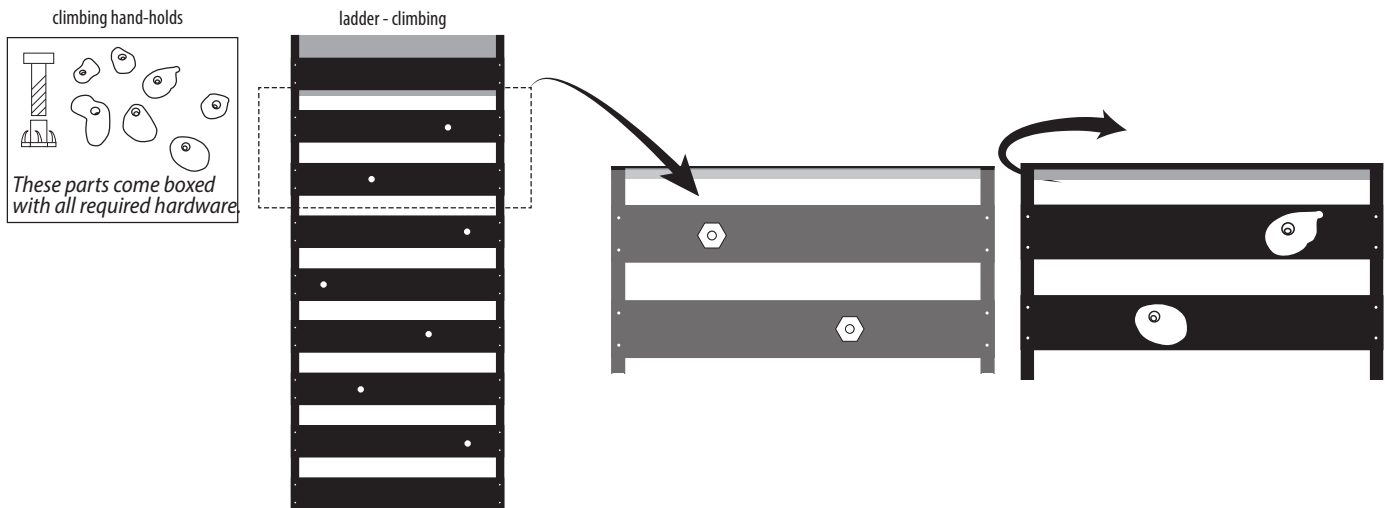

Ladders



14. Attach ladder with climbing holds to Panel 2. Attach ladder brace, 4 screws attach to panel, 4 screws to foot of ladder

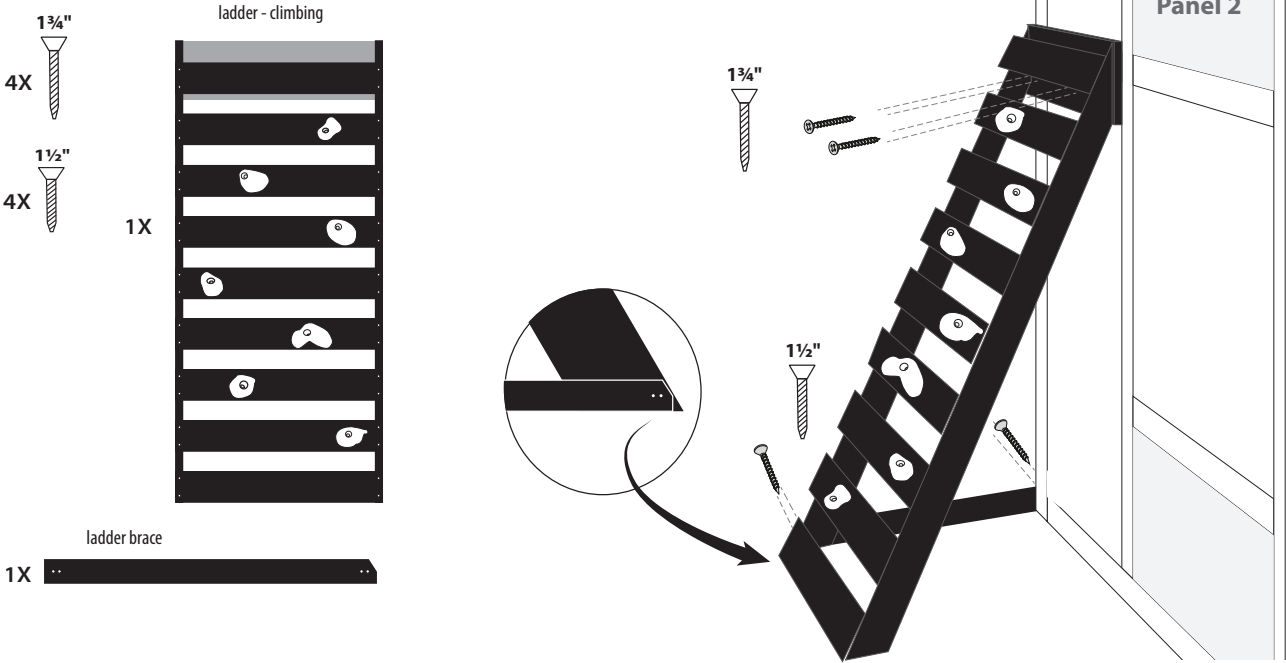

15. Attach ladder without climbing holds to the deck. Place even with the post, the locating board sits under the brace. Attach ladder brace to the post (4 screws) & base of ladder (4 screws).

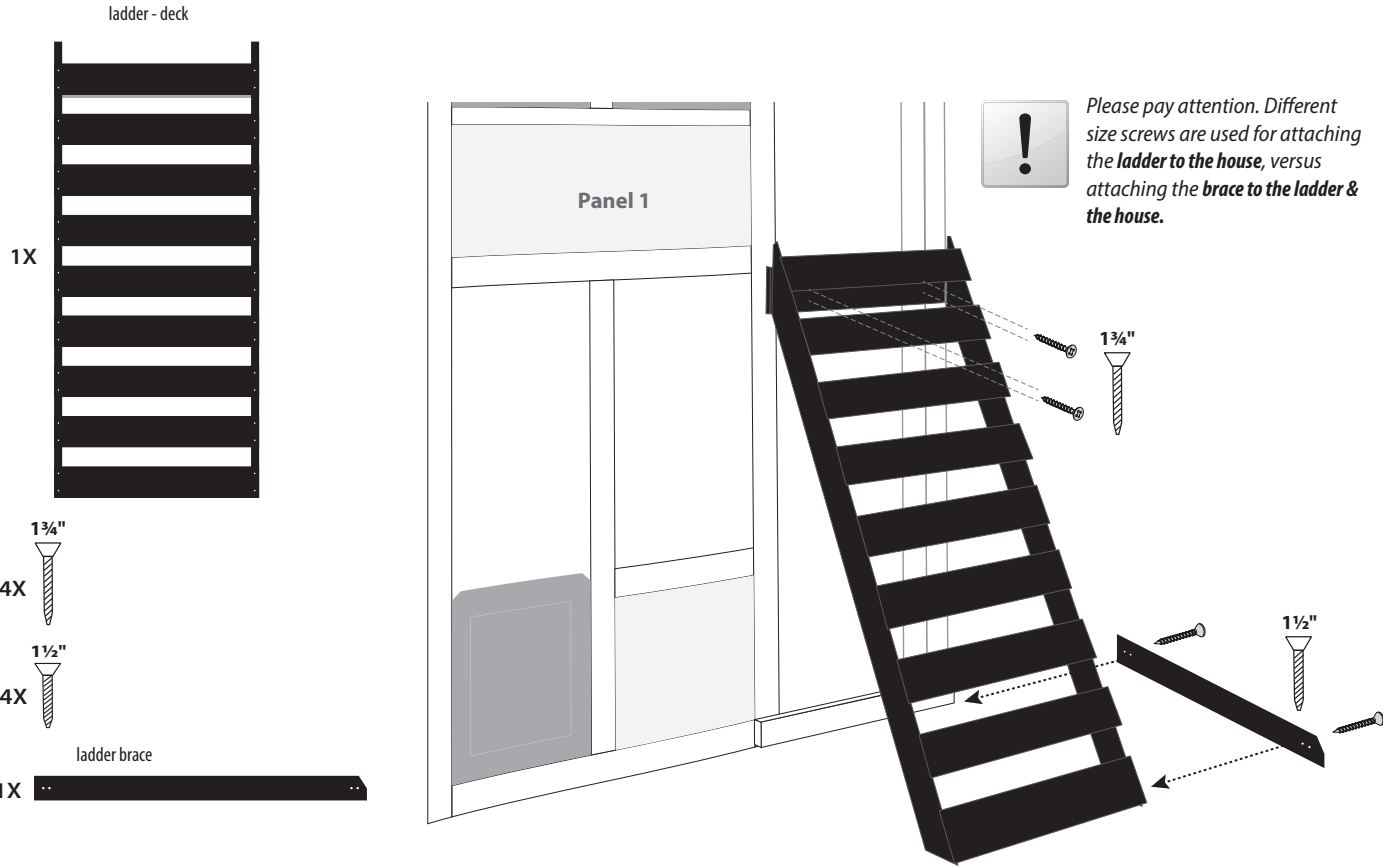

A-Frame & Fence



16. Install A-frame on deck posts – (if necessary use rubber mallet to fully secure in the post pockets). Place screws through post into A-Frame beam on both ends from the “house-side” of the A-Frame.

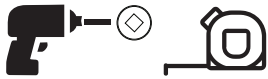
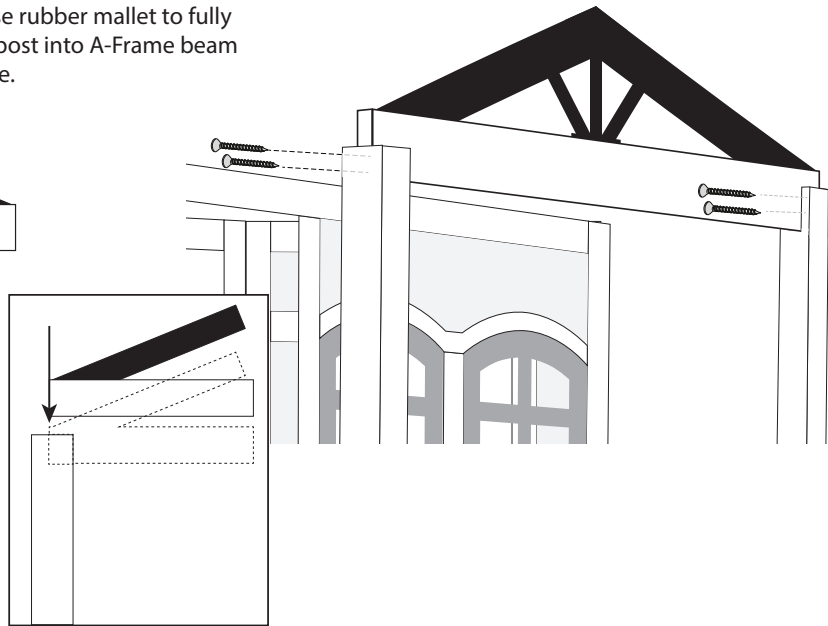
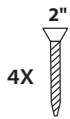
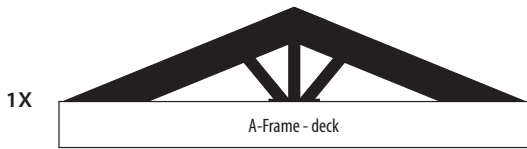

17. Attach 7-picket fence, with the horizontal cross pieces facing out, flush w/post & 3” up from brace

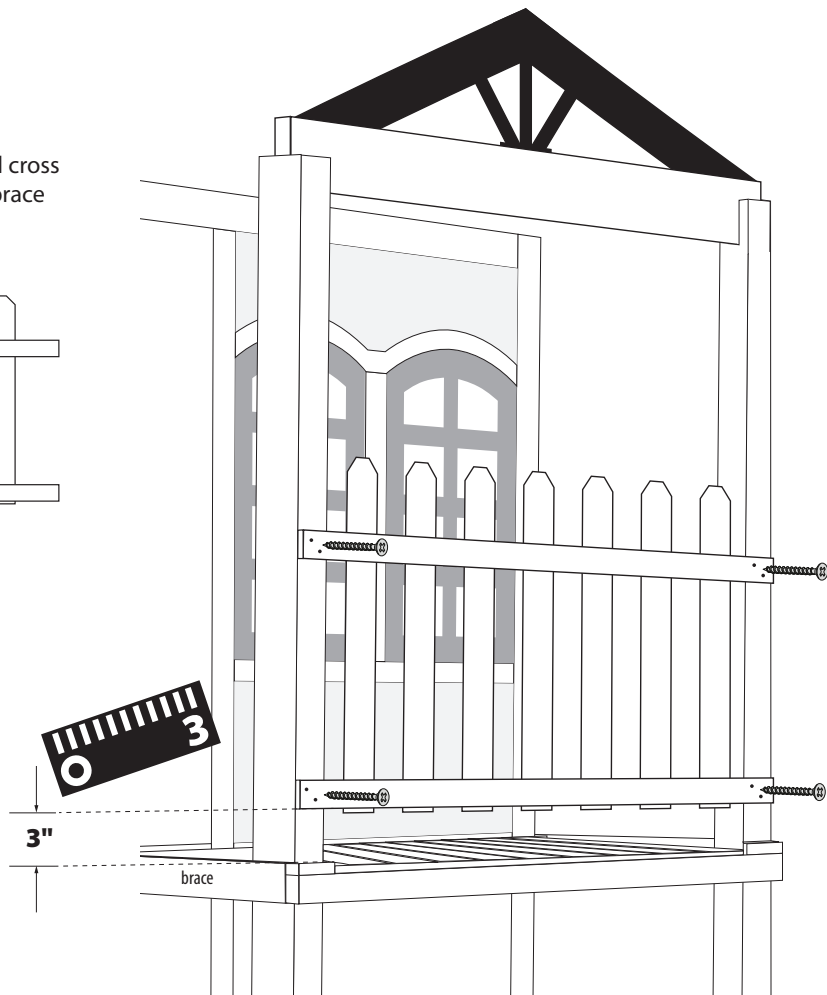
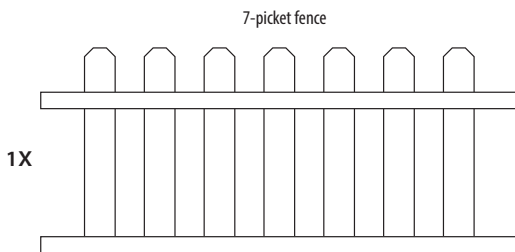

Fence & Cross-Braces

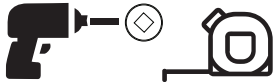

18. Attach 3-picket fence to post & Panel 4, measuring carefully for proper placement.

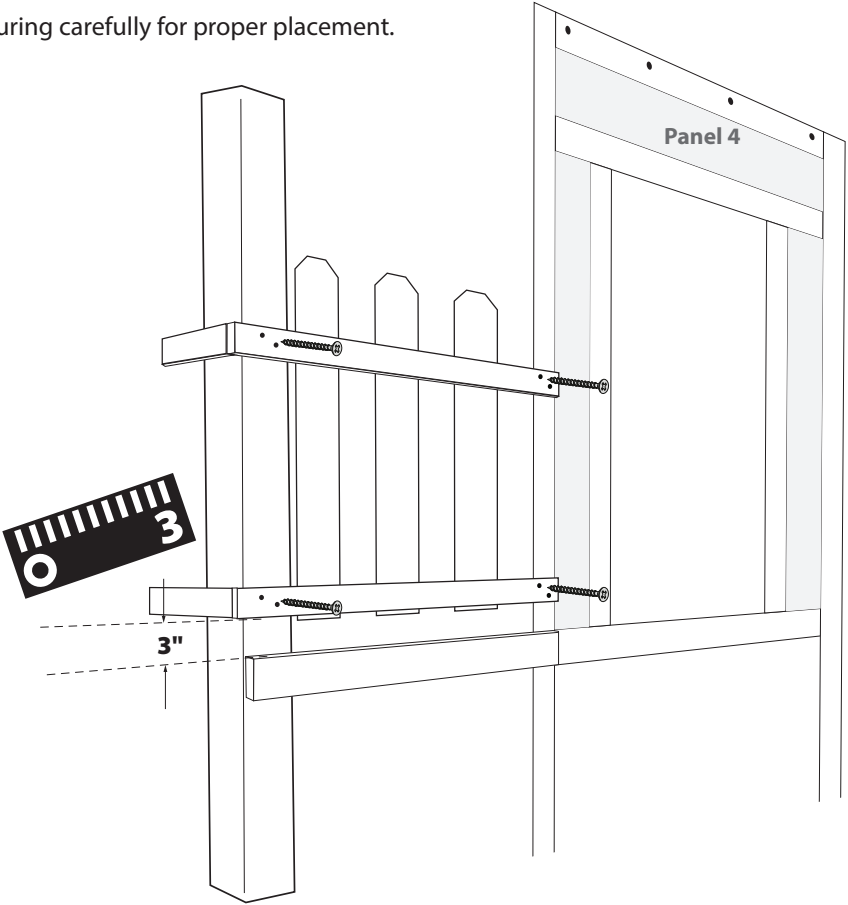
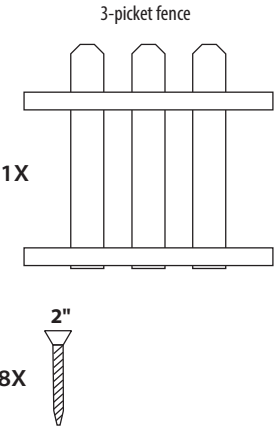

19. Attach 2 angle wood braces to posts & floor joist, flush with post, on inside of joist

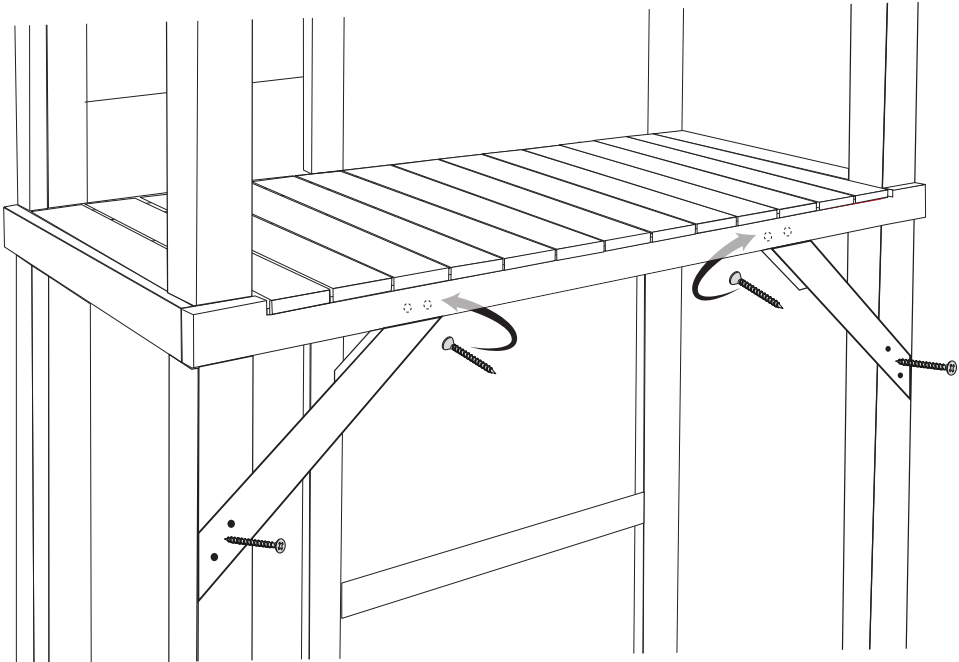
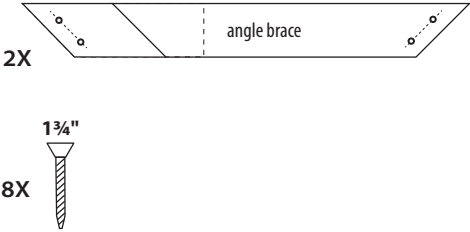

A-Frames for Roof Support



20. Before beginning this step, confirm the structure is on stable and level ground.



Standing inside the house, use the thin black locator bar (on the back of the A-Frame) to place it centered on top of the wall panel of Panel 1. Use 4 screws through pre-drilled holes in the top bar of the panel into the A-frame.

Repeat for the other side.

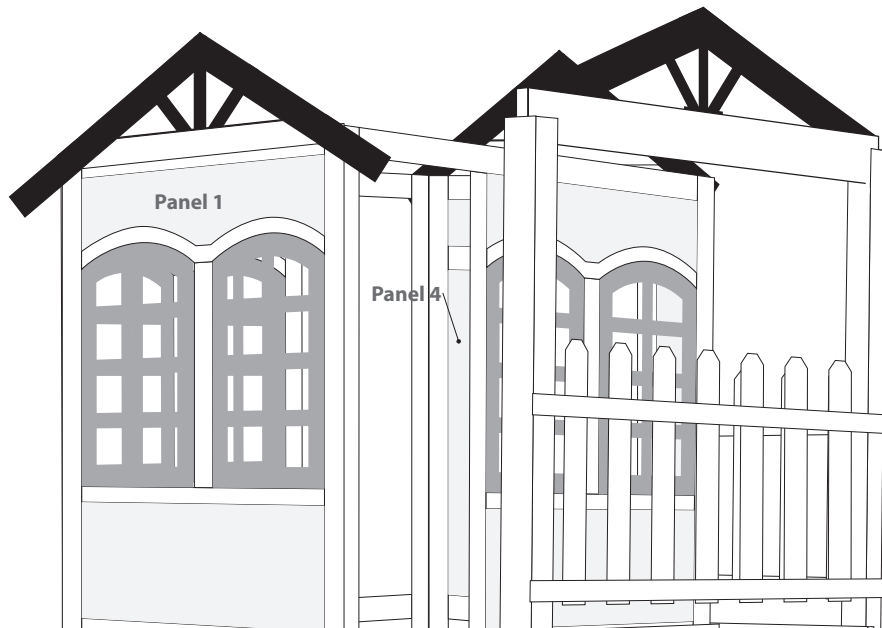
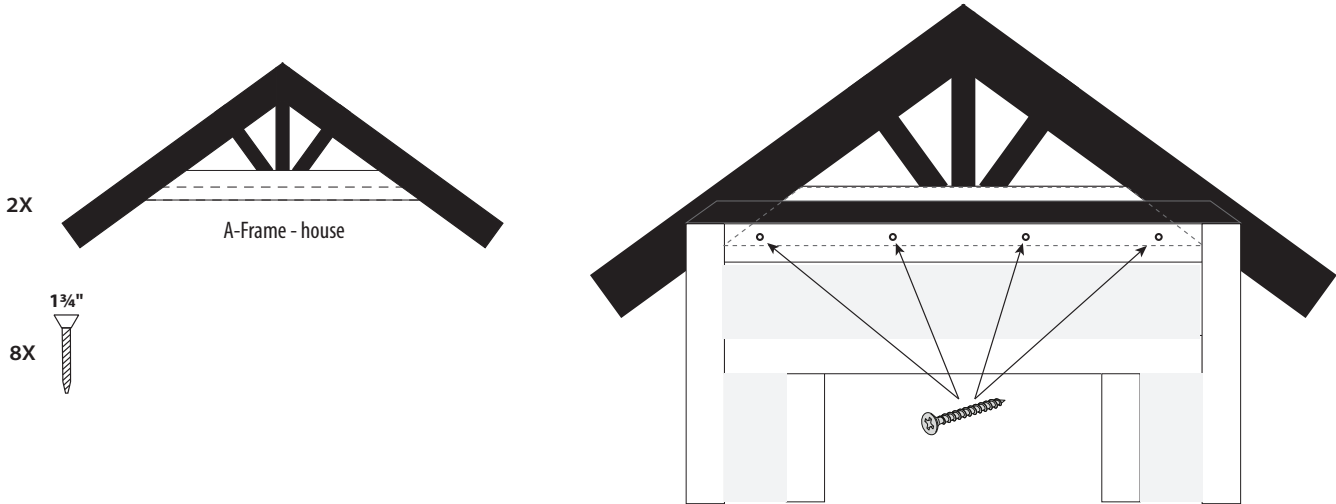

Roofing

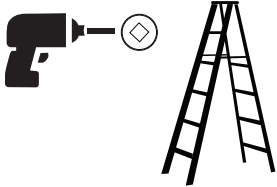

21. Install pre-drilled roof panels over the main structure. Start with Roof Panel 1, standing inside structure, and place the screws as indicated.

The top corner of the panel should be flush with the highest point of peak of the A-Frame.

Repeat for Roof Panel 2.

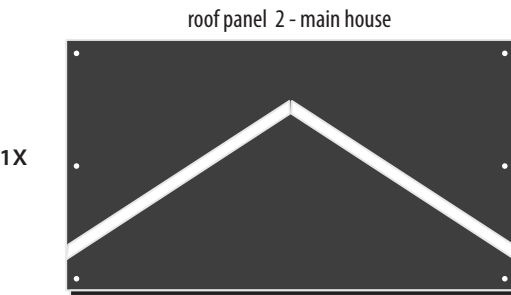
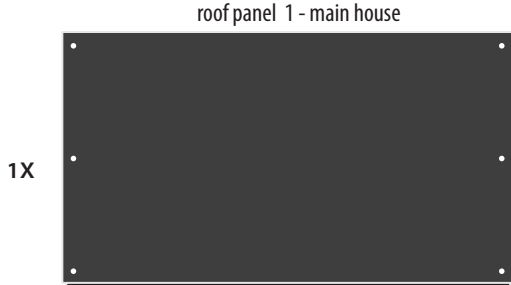
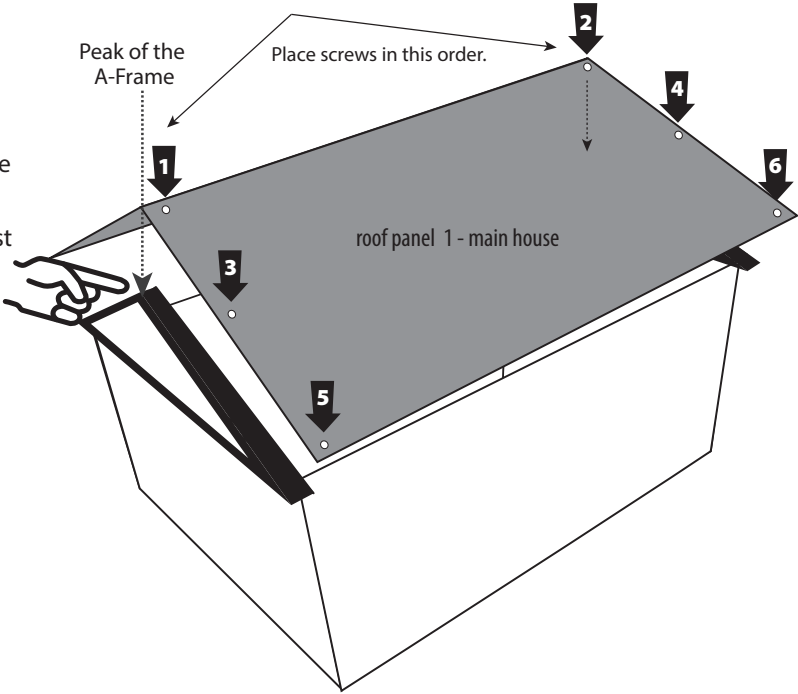

22. Install roof panels over deck

Place against main roof using the guide strip. Drive screws through pre-drilled holes into guide strips on main roof panel and in the A-Frame, in the order indicated.

Repeat for second panel.

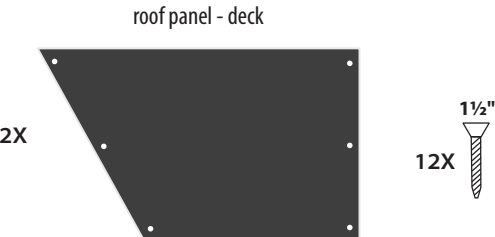
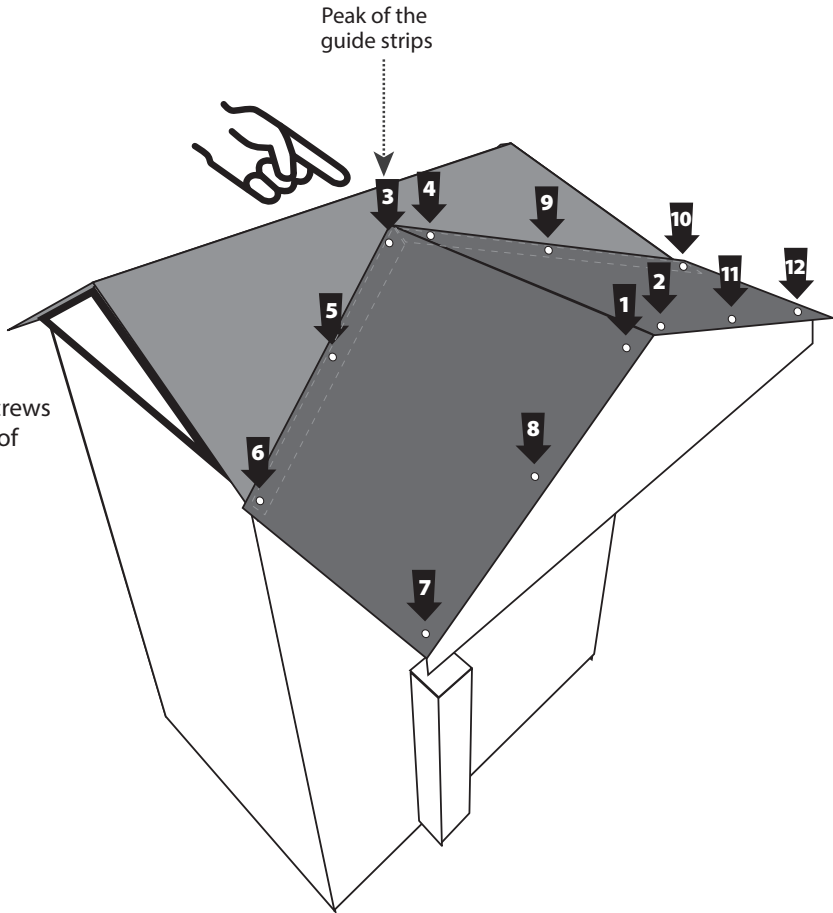

Finishing



23. Attach handles on Panels 2 & 3 on doorway, (5" to hole of handle)

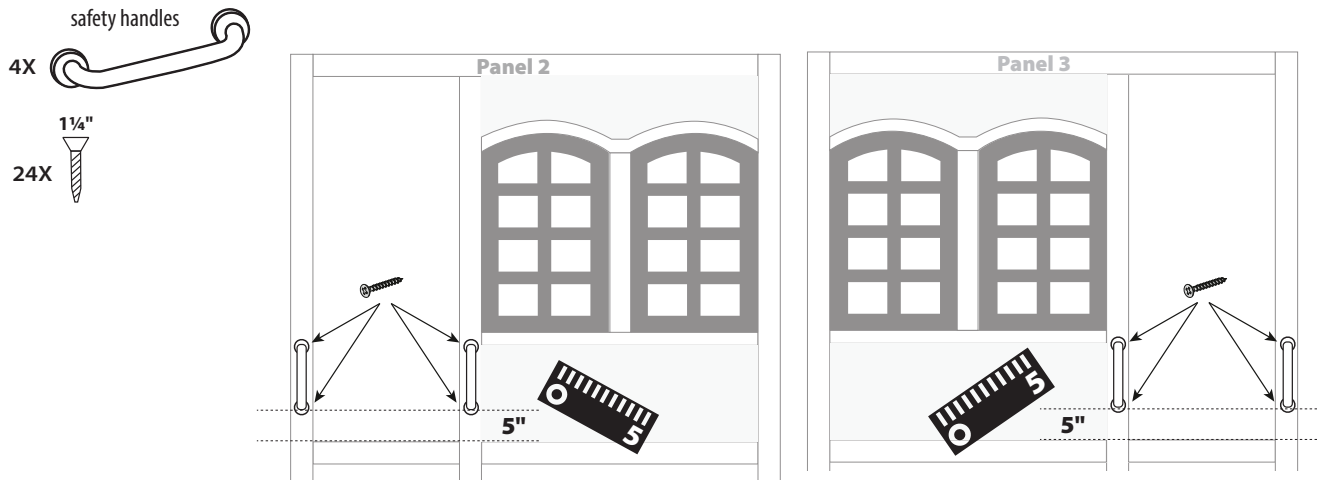

24. Attach larger flower box to **Panel 1**. Have a helper hold the flower box centered under the center bar of panel. Attach with screws from inside the structure. Repeat for Panel 2 with smaller flower box.

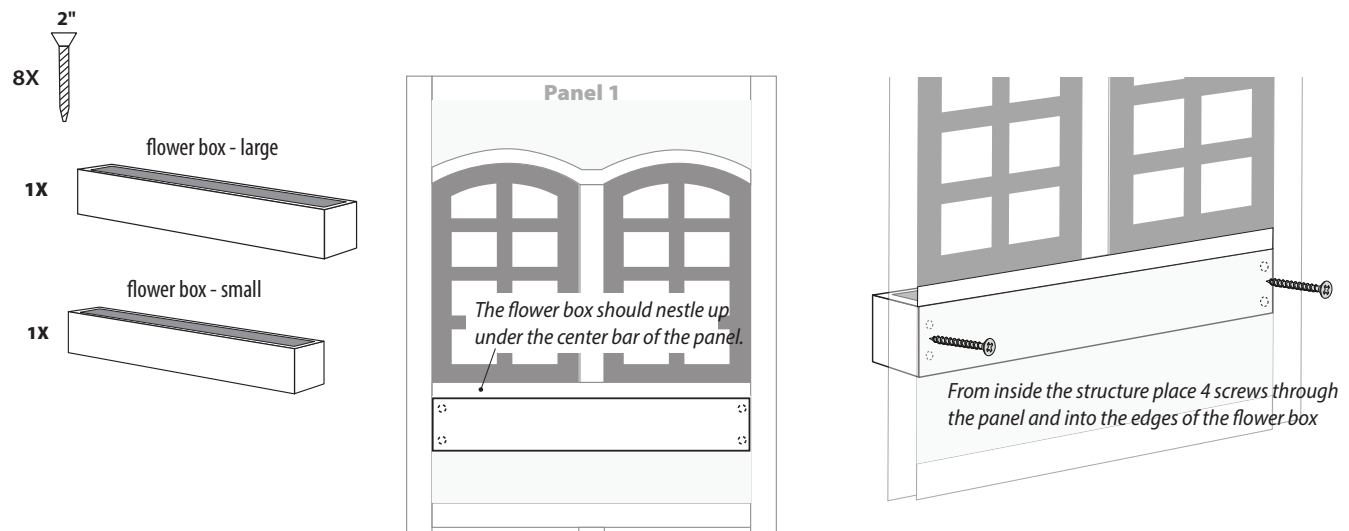

Finishing



25. Attach small door handle to the pre-installed black door on Panel 1

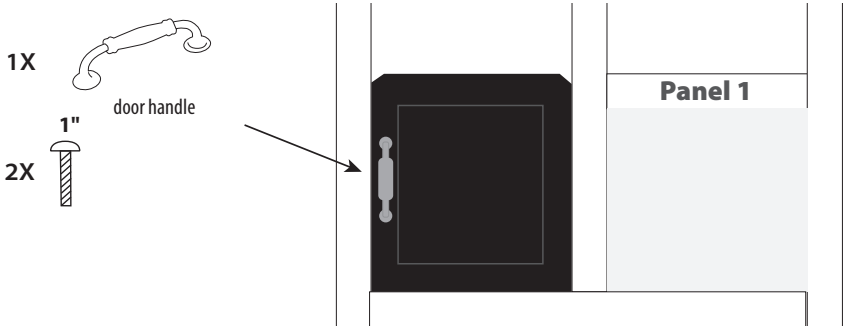

26. Attach slide – 3 screws at top of slide into bar of Panel 4.

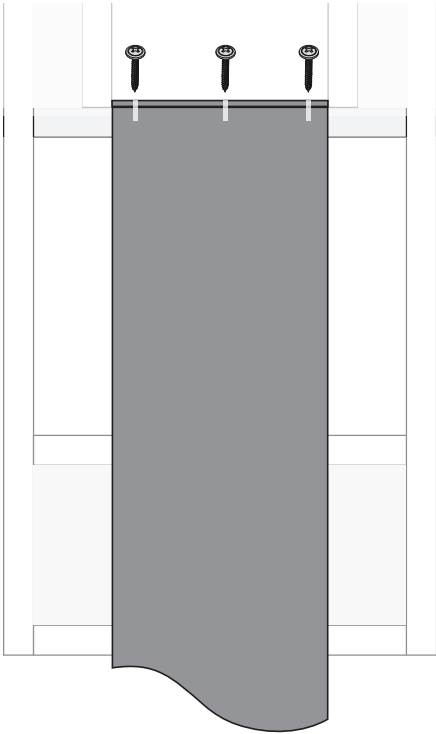
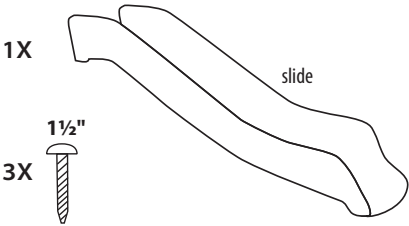

Finishing

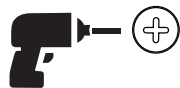

27. Once the structure is complete, and it's placement set, from inside the house, use 1 stake in each of the 2 corners farthest from the deck, and at each deck post.

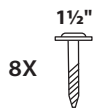

WARNING

To prevent tipping and avoid potential injury, stakes must be driven 10½" into ground. Digging or driving stakes can be dangerous if you do not check first for underground wiring, cables or gas lines.

