

Oceano Playhouse Assembly Guide & Warranty

Please Read and Retain this document

Includes warranty replacement instructions and important safety information

2MamaBees Inc.
www.2mamabees.com
info@2mamabees.com
833-MAMABEE (626-2233)

Contents
Warnings
Maintenance
Assembly Prep
Tools and Part Inventory
Step-by-Step Assembly



Warnings and FAQs

Read this entire manual before assembling the playhouse.

Keep manual after assembly to easily order replacement parts or to disassemble properly.

Assembly requires two adults. If necessary, seek professional help to assemble if you are uncertain about any of the steps listed.

Prepare recommended area before beginning assembly.

Please see "Assembly and Layout" for further information.

Playhouse must be completely assembled and inspected for sharp edges or protruding hardware before use by children. Failure to do so may result in injury and/or voiding of warranty.

Missing or damaged parts? Please email info@2mamabees.com or call 833-MAMABEE (626-2233). (You will need Playhouse Model and part number. Playhouse Model is found on the front page of this manual and part numbers and descriptions are listed on each page).



Proper Use

- Playhouse is intended for children aged 2 to 10 years of age.
- Playhouse is designed for indoor or outdoor use in private at-home settings only.
- Playhouse is not intended for public or business use (such as daycare, preschool, nursery, or other commercial applications). Any use of this sort will void warranty.

Safe Play

To reduce the risk of injury or death, you must follow these instructions:

- Adult supervision required at all times when the playhouse is being used.
- Adults should check for damaged wood, missing or loose hardware, or any sharp edges before every use. Replace, tighten and smooth rough edges between uses. Lubricate any moving parts when needed.
- Children should be dressed in well fitting clothes and wearing closed toed shoes when using playhouse.
- Children should not wear bicycle or sports helmets or any headgear with chinstrap to avoid catching on playhouse.
- Adults should ensure the playhouse is on a flat and level surface and does not rock due to an uneven spot. Check the depth of surface under and around the playhouse regularly. Add material to maintain minimum required depth and rake to keep level. See Assembly and Layout for more information.
- Check surface temperatures on hot days to ensure plastic, metal and wood surfaces could burn children during use. Surfaces can be cooled with water. Wipe everything dry before use.
- If surfaces are wet, dry them off before use as there is a risk of child slipping and falling.
- Do not let children climb on roof of playhouse.



Warranty and Maintenance



Maintenance

- As part of safe play, we recommend daily checks of playhouse before used by children.
- All wood parts are made from weather tolerant cedar and sealed with a water-based sealant. Weathering from seasonal changes and other outdoor exposure will cause moisture content of the wood to shift and cause cracking, warping, and fading. While these changes will not impact the integrity of the product, we advise regular maintenance to slow the speed and amount of weathering.
- In order to slow normal weathering and ensure warranty is not voided, it is required that a layer of sealant be applied to all wood surfaces every 1-2 years (yearly for areas that are humid and hot, every 2 years for areas that are dry. Before sealing, lightly sand wood pieces where there might be rough spots. This will reduce the rate of fading.

Limited Warranty

All products carry a 1-year replacement warranty on all parts for manufacturer's defect (which covers wood, hardware, and accessories). Our wood carries a 5 year warranty on rot and decay as well.

This Limited Warranty does not cover:

- Labor for any inspection
- Labor for replacement of any defective item(s)
- Incidental or consequential damages
- Cosmetic defects which do not affect performance or integrity of a part or the entire product
- Vandalism, theft, improper use, failure due to loading or use beyond the capacities stated in the applicable Assembly Manual.
- Acts of nature including but not limited to wind, earthquake, storms, hail, floods, fires, excessive water exposure
- Improper installation including but not limited to installation on uneven, unlevelled, or soft ground
- Minor twisting, warping, cracking, or any other natural occurring properties of wood that do not affect performance or integrity

2MamaBees Playhouses have been designed for safety and quality. Modifications beyond painting could damage the structural integrity of product and lead to injury from product failure. Any modifications will void all warranties and guarantees.

Part Replacement -

- Cost of parts (damaged or missing) will be covered by 2MamaBees for the first year. This includes Shipping & Handling.
- All replacement parts after first year of ownership will be charged as follows - Discount on parts will decrease by 20% for every year of ownership of playhouse. (Ex - Year 1 customer pays 20% of cost, Year 2 customer pays 40%, and so on). All shipping and handling will be covered by customer.
- Warranty is voided if use in any non-residential setting such as playgrounds, parks, daycares, or business settings.
- Warranty is non-transferable

This Warranty gives you specific legal rights. You may have other rights as well which vary from state to state or province to province. This warranty excludes all consequential damages, however, some states do not allow the limitation or exclusion of consequential damages and therefore this limitation may not apply to you.



Assembly and Surface Preparation



Do not install on any hard surface (ex - concrete or asphalt) Doing so increases risk of serious head and other injuries from tripping or falling. Mats, outdoor carpet, and loose fill over hard surfaces do not have sufficient padding to reduce risk of use on hard surfaces. Do not use these options.

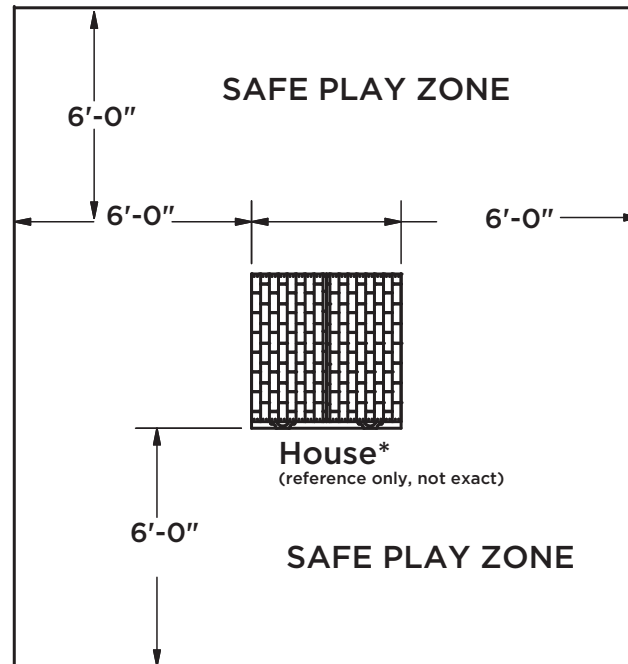

Positioning the Playhouse

Playhouse is designed to be utilized on a level surface with at least 6 feet of open surface that is free of any obstruction. In order to prepare play area before beginning assembly:

- Consider locating the playhouse in an area that is convenient for adults to watch children at play.
- Remove any obstacle such as tree stumps and roots, branches, bushes, and large rocks from the play area.

Recommended Play Area Surfaces

- After prepping playhouse area and installing playhouse, it is recommended to add a layer of shock absorbing material around playhouse. If used properly these materials can absorb some of the impact of a child's fall.
- We recommend the following types of surfaces: Shredded wood products and mulch, shredded tires, fine or coarse sand, or gravel
- Minimum recommended depth of materials should be 6 inches.
- Overtime, shock-absorbing materials will compact and shift. When this happens additional material should be added and surfaces raked by an adult to maintain consistent thickness around entire playhouse.
- Please consult a landscaping professional on the required amount of material needed to meet the minimum requirement of final compressed thickness.



Playground Surfacing Materials Appendix A



APPENDIX A

Information on Playground Surfacing Materials:

The following information is from the United States Consumer Product Safety Commission's Information Sheet for playground surfacing material; also see the following website for additional information:

www.cpsc.gov/cpsc/pub/pubs/323.html

X3. CONSUMER INFORMATION SHEET FOR PLAYGROUND SURFACING MATERIALS11

X3.1 Select Protective Surfacing—One of the most important things you can do to reduce the likelihood of serious head injuries is to install shock-absorbing protective surfacing under and around your play equipment. The protective surfacing should be applied to a depth that is suitable for the equipment height in accordance with ASTM Specification F 1292. There are different types of surfacing to choose from; whichever product you select, follow these guidelines:

X3.1.1 Loose-Fill Materials:

X3.1.1.1 Maintain a minimum depth of 9 inches of loose-fill materials such as wood mulch/chips, engineered wood fiber (EWF), or shredded/recycled rubber mulch for equipment up to 8 feet high; and 9 inches of sand or pea gravel for equipment up to 5 feet high. NOTE: An initial fill level of 12 inches will compress to about a 9-inch depth of surfacing overtime. The surfacing will also compact, displace, and settle, and should be periodically refilled to maintain at least a 9-inch depth.

X3.1.2 Use a minimum of 6 inches of protective surfacing for play equipment less than 4 feet in height. If maintained properly, this should be adequate. (At depths less than 6 inches, the protective material is too easily displaced or compacted.) NOTE: Do not install home playground equipment over concrete, asphalt, or any other hard surface. A fall onto a hard surface can result in serious injury to the equipment user. Grass and dirt are not considered protective surfacing because wear and environmental factors can reduce their shock absorbing effectiveness.

Carpeting and thin mats are generally not adequate protective surfacing. Ground level equipment such as a sandbox, activity wall, playhouse or other equipment that has no elevated play surface – does not need any protective surfacing.

X3.1.3 Use containment, such as digging out around the perimeter and/or lining the perimeter with landscape edging. Don't forget to account for water drainage.

X3.1.3.1 Check and maintain the depth of the loose-fill surfacing material. To maintain the right amount of loose-fill materials, mark the correct level on play equipment support posts. That way you can easily see when to replenish and/or redistribute the surfacing.

X3.1.3.2 Do not install loose-fill surfacing over hard surfaces such as concrete or asphalt.

X3.1.4 Poured-In-Place Surfaces or Pre-Manufactured Rubber Tiles — You may be interested in using surfacing other than loose-fill materials – like rubber tiles or poured-in-place surfaces.

X3.1.4.1 Installations of these surfaces generally require a professional and are not “do-it-yourself” projects.

X3.1.4.2 Review surface specification before purchasing this type of surfacing. Ask the installer/manufacturer for a report showing that the product has been tested to the following safety standard: ASTM F 1292 Standard Specification for Impact Attenuation of Surfacing Materials within the Use Zone of Playground Equipment. This report should show the specific height for which the surface is intended to protect against serious head injury. This height should be equal to or greater than the fall height – vertical distance between a designated play surface (elevated surface for standing, sitting, or climbing) and the protective surfacing below – of your play equipment.

X3.1.4.3 Check the protective surfacing frequently for wear.

X3.1.5 Placement — Proper placement and maintenance of protective surfacing is essential. Be sure to:

X3.1.5.1 Extend surfacing at least 6 feet from the equipment in all directions.

Owner's Manual Play House

OWNER PH-2011

11 This information has been extracted from the CPSC publications “Playground Surfacing — Technical Information Guide” and “Handbook for Public Playground Safety.”

Copies of these reports can be obtained by sending a postcard to: Office of Public Affairs, U.S. Consumer Product Safety Commission, Washington, D.C., 20207 or call the toll-free hotline: 1-800-638-2772.

The American Society for Testing and Materials takes no position respecting the validity of any parent right asserted in connection with any item mentioned in this standard. Users of this standard are expressly advised that determination of the validity of any such parent rights, and the risk of infringement of such rights, are entirely their own responsibility. The standard is subject to revision at any time by the responsible technical committee and must be reviewed every five years and if not revised, either approved or withdrawn. Your comments are invited either for revision of this standard or for additional standards and should be addressed to ASTM Headquarters. Your comments will receive careful consideration at a meeting of the responsible technical committee, which you may attend. If you feel that your comments have not received a fair hearing you should make your views known to the ASTM Committee on Standards, 100 Barr Harbor Drive, West Conshohocken, PA 19428.



Disposal



Disposal Instructions:

When the playhouse use is no longer desired, it should be disassembled and disposed of in such a way that no unreasonable hazards will exist at the time the unit is discarded.

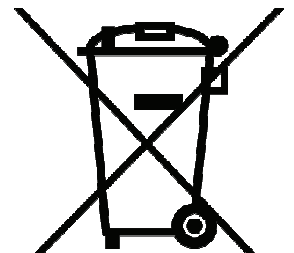



Necessary Tools (Not Included)

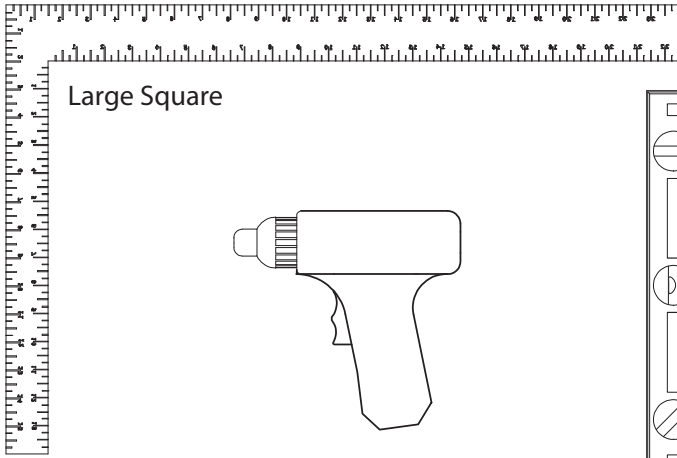

Large Square

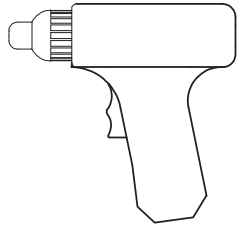

Cordless Drill or Electric Drill



24" Level

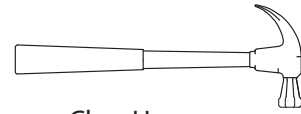

Claw Hammer

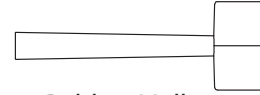

Rubber Mallet

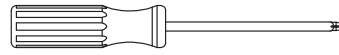

Screw Driver

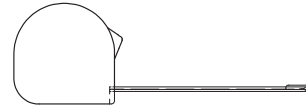

Tape Measure



Hardware Included

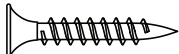

QUANTITY 84
S2 Screw - 1in

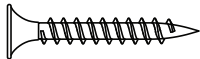

QUANTITY 70
S3 Screw - 1 1/8in

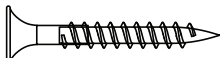

QUANTITY 52
S4 Screw - 1 1/4in

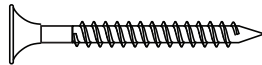

QUANTITY 10
S5 Screw - 1-1/2in

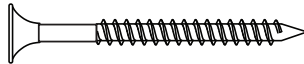

QUANTITY 4
S6 Screw - 1 3/4in

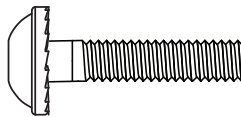

Bolt 1/4x1-1/4in



Door Handle

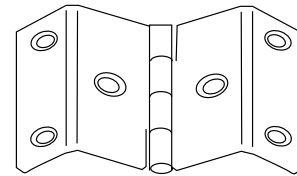

Hinge - 2

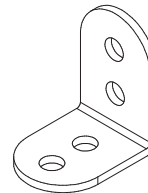

QUANTITY 18
L-Bracket



Wooden Components & Accessories

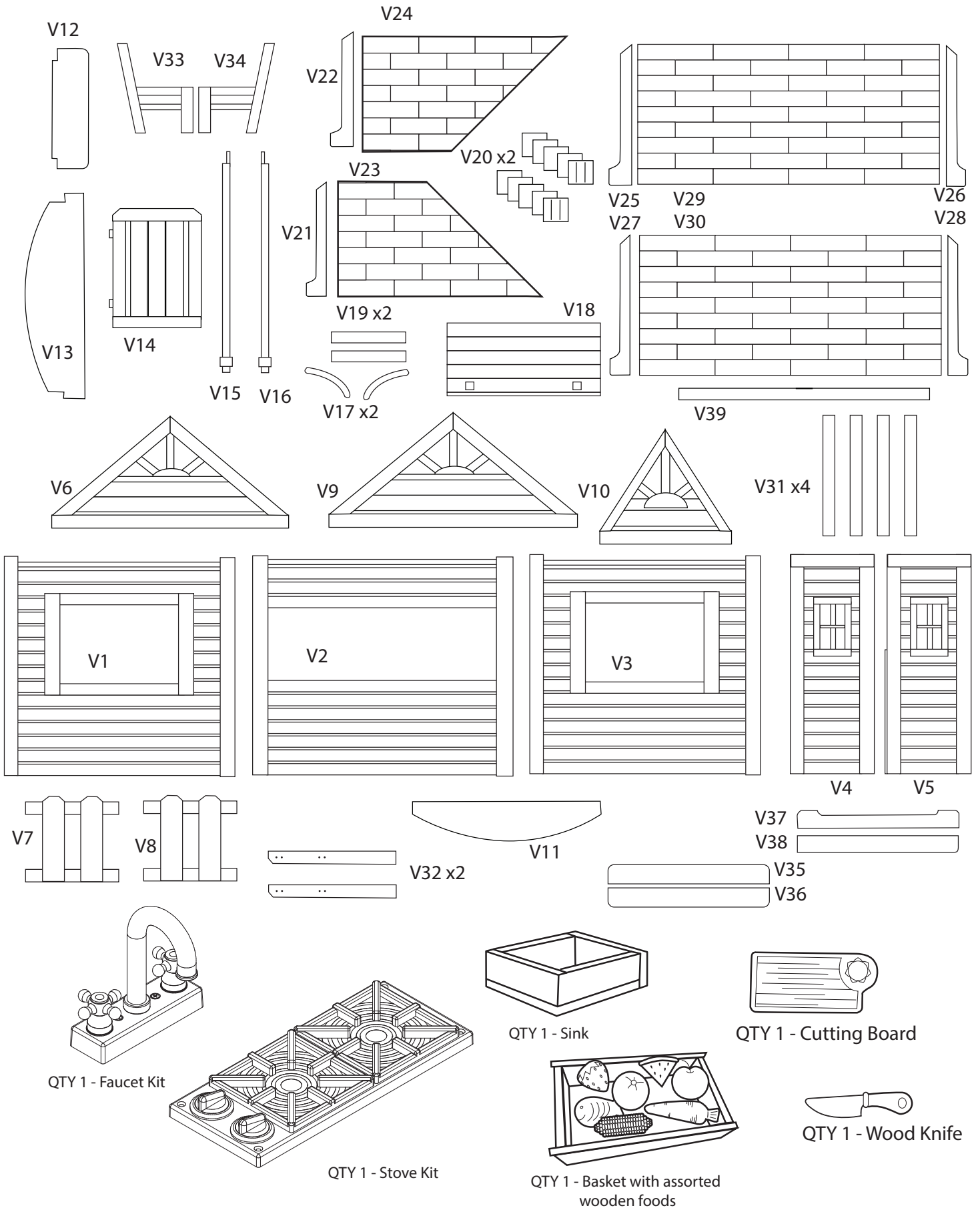

Inventory Immediately. Missing a part? Call 833-626-2233

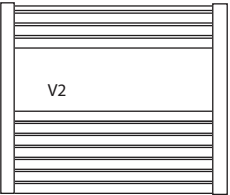
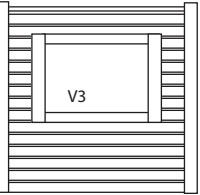
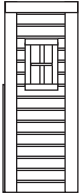
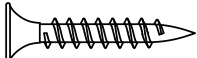
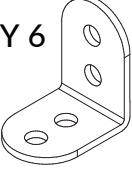
PARTS	 <p>V2</p>	 <p>V3</p>	 <p>V5</p>	HARDWARE	 <p>QUANTITY 24 1 in. S2 Screw</p>	<p>QUANTITY 6 L-Bracket</p>	
--------------	--	--	--	-----------------	--	---------------------------------	--

STEP 1:

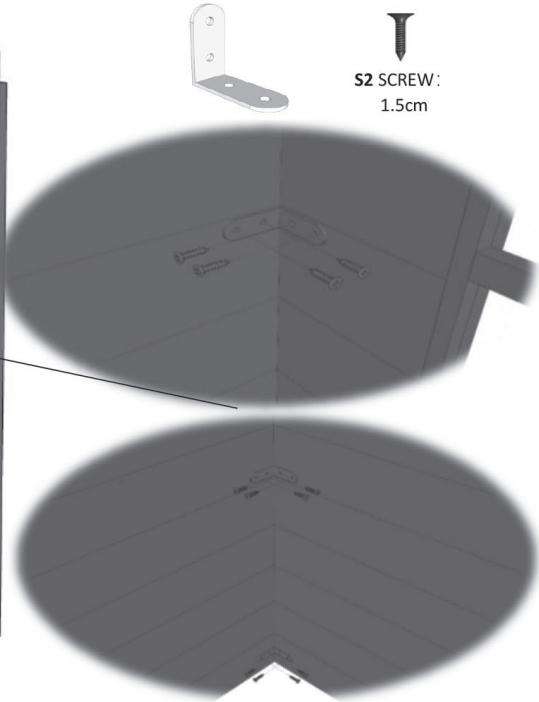
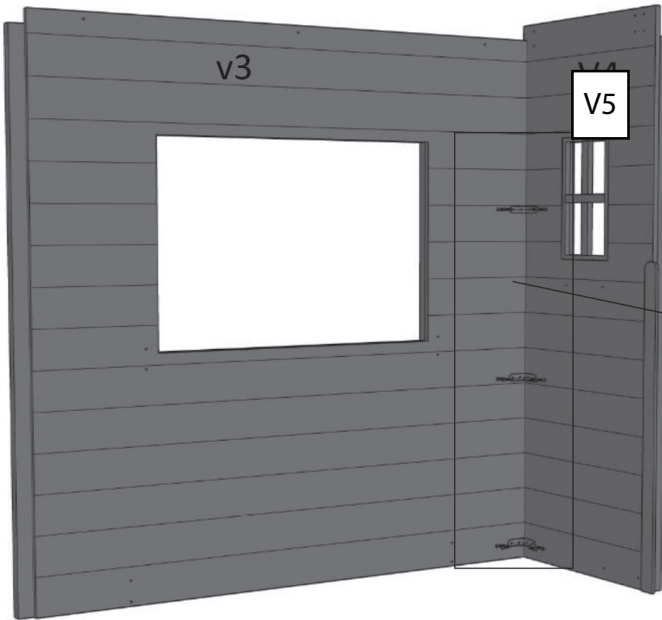

S2 SCREW:
1.5cm

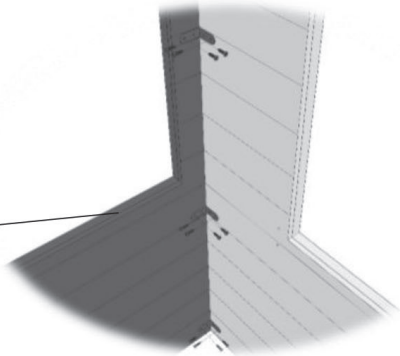
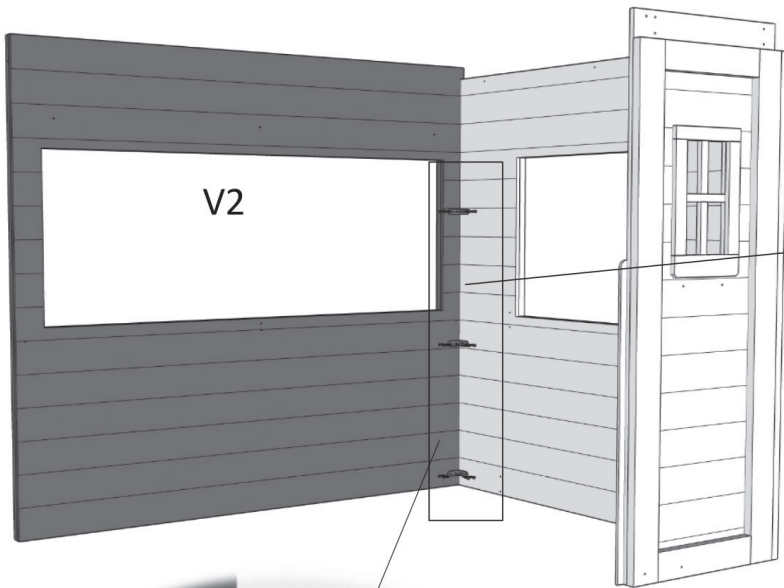

S2 SCREW: 1.5cm

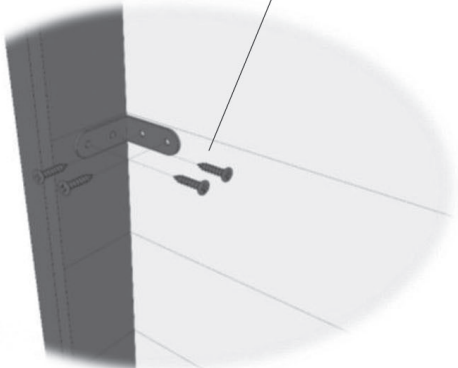

PARTS

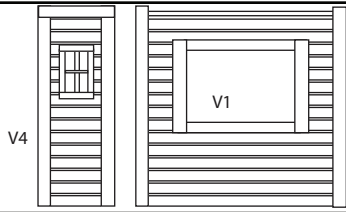

HARDWARE

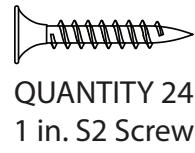

QUANTITY 6
L-Bracket

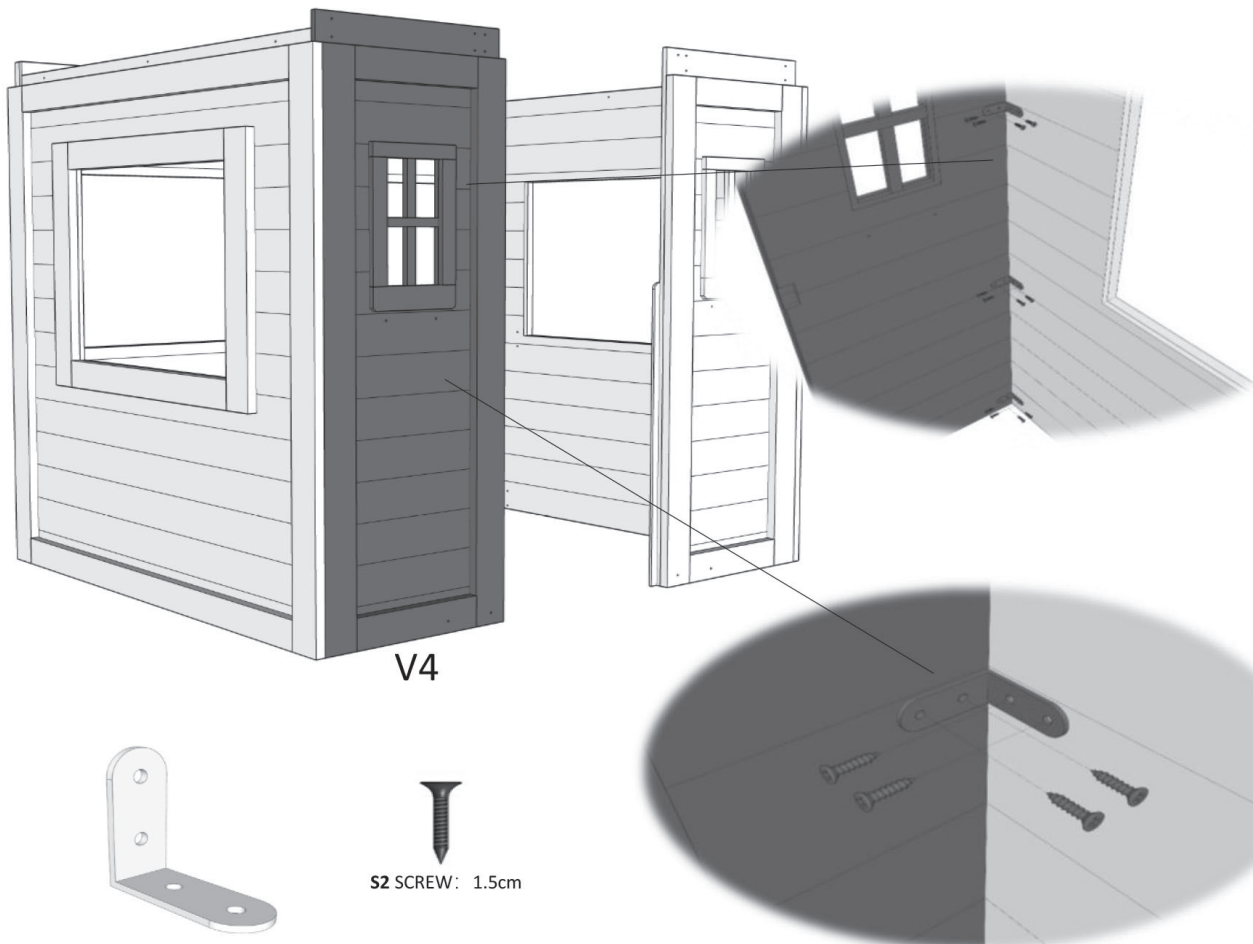
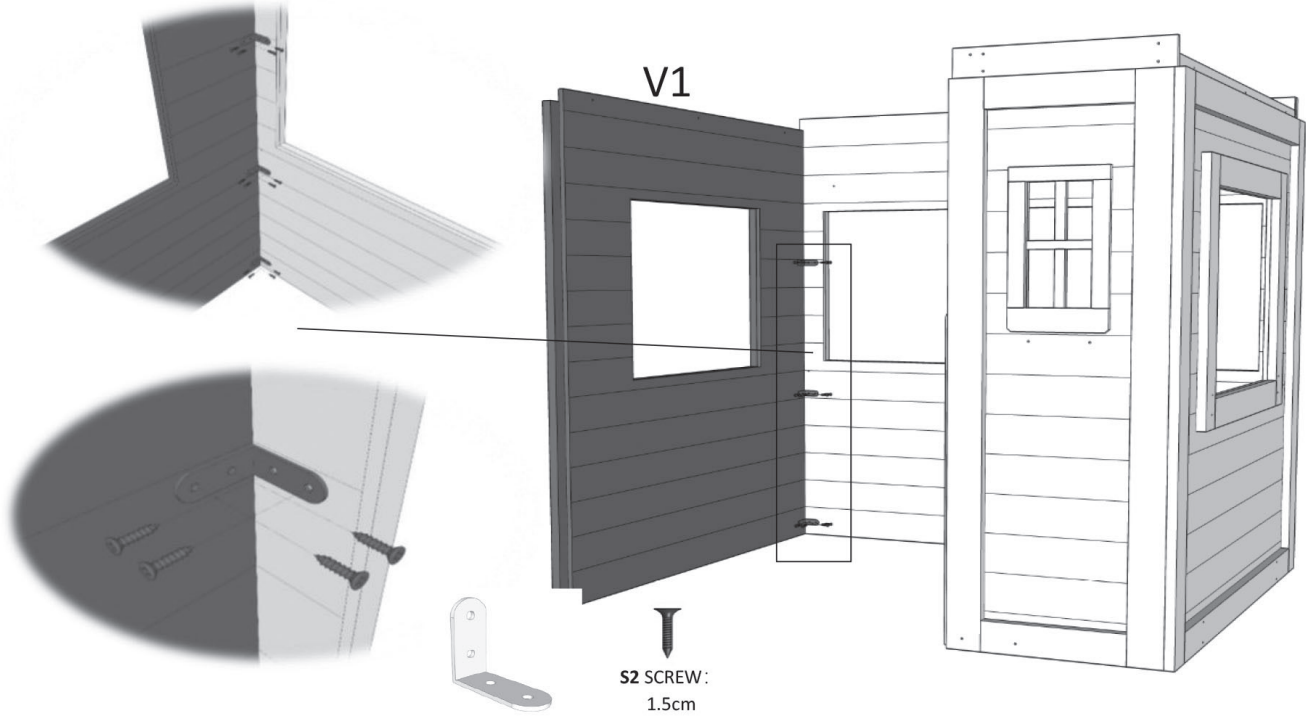
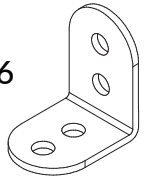

PARTS

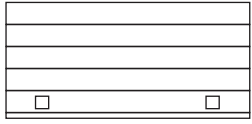

V18

V39

HARDWARE

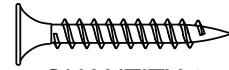



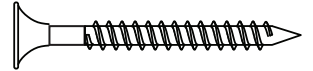

QUANTITY 8
S3 Screw - 1 1/8in

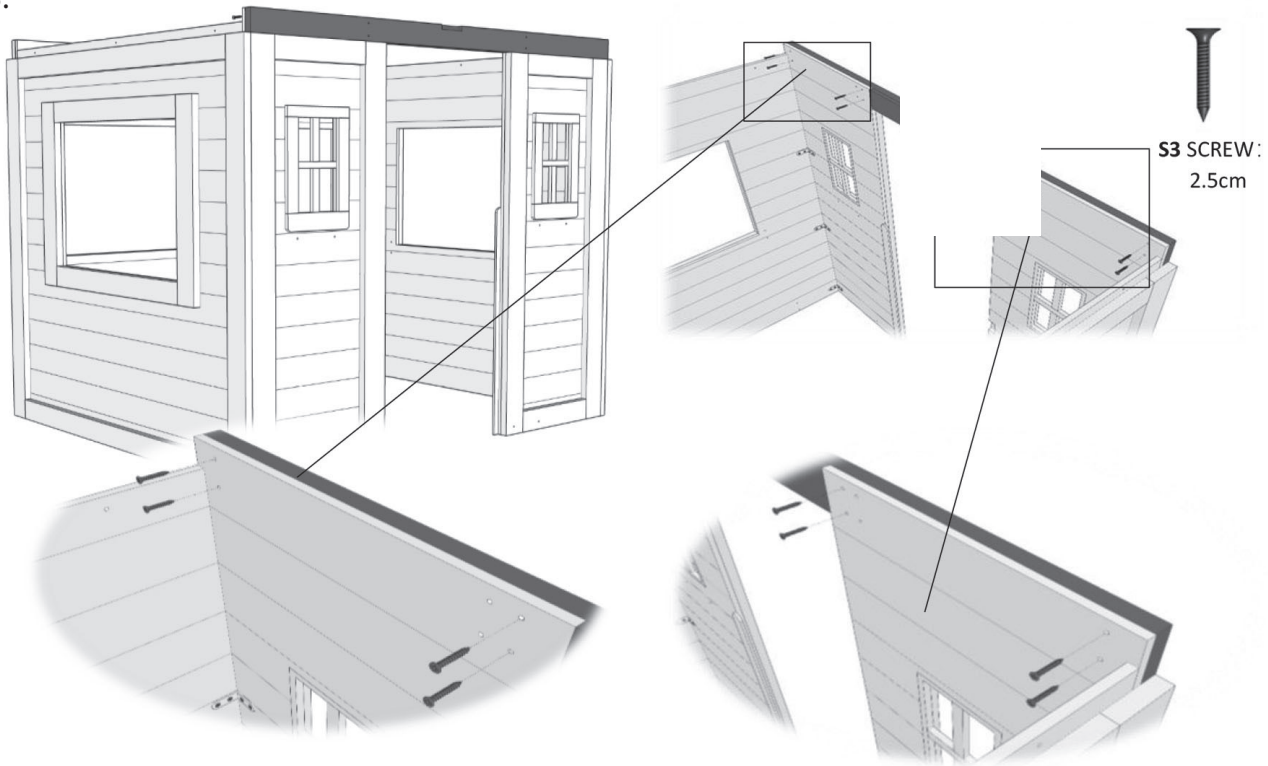

QUANTITY 4
S5 Screw - 1-1/2in

STEP 3:

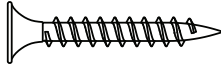
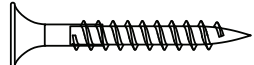
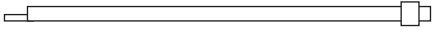

PARTS	V19 	HARDWARE		
	V16 		V17 	QUANTITY 1 S3 Screw - 1 1/8in

STEP 4:

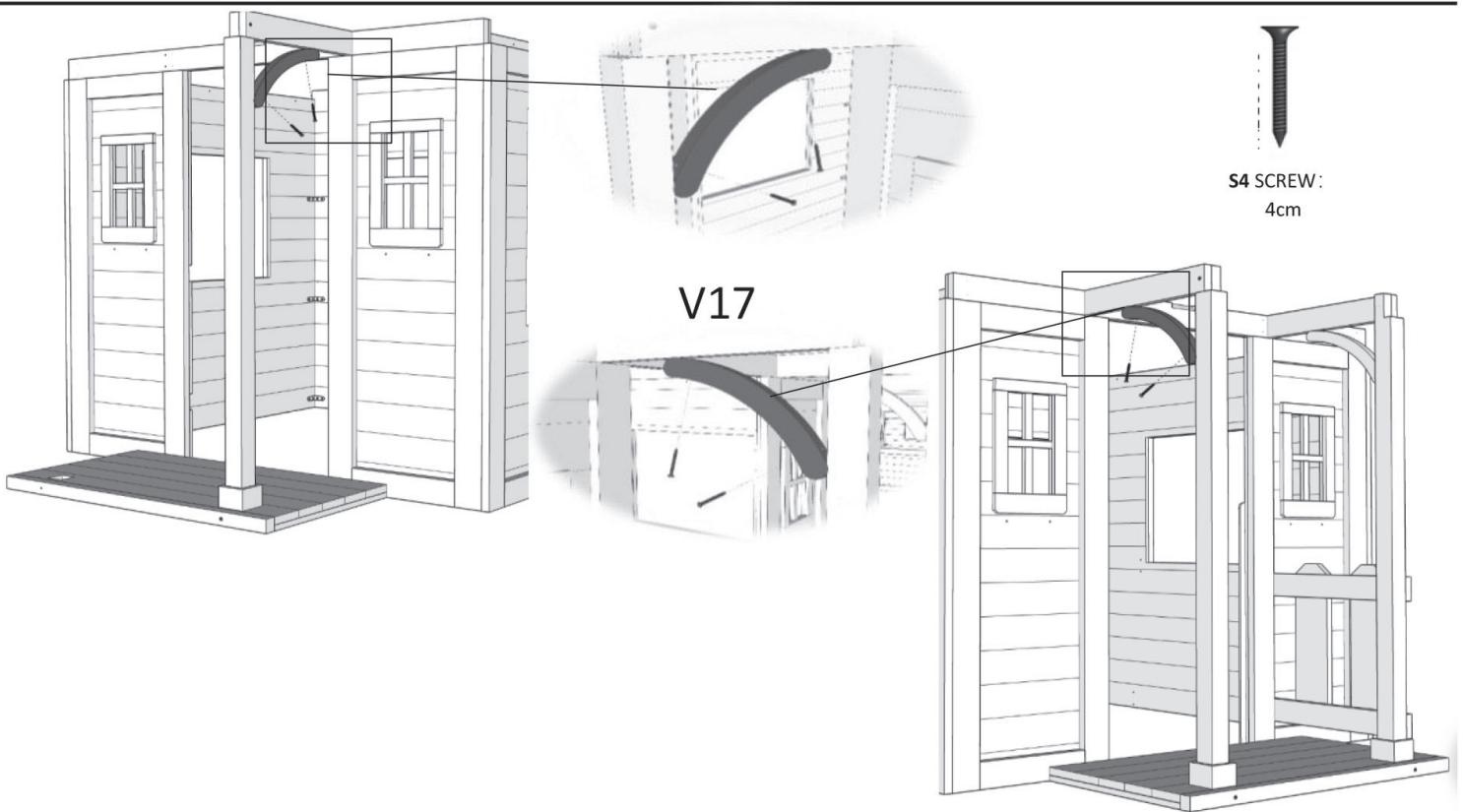
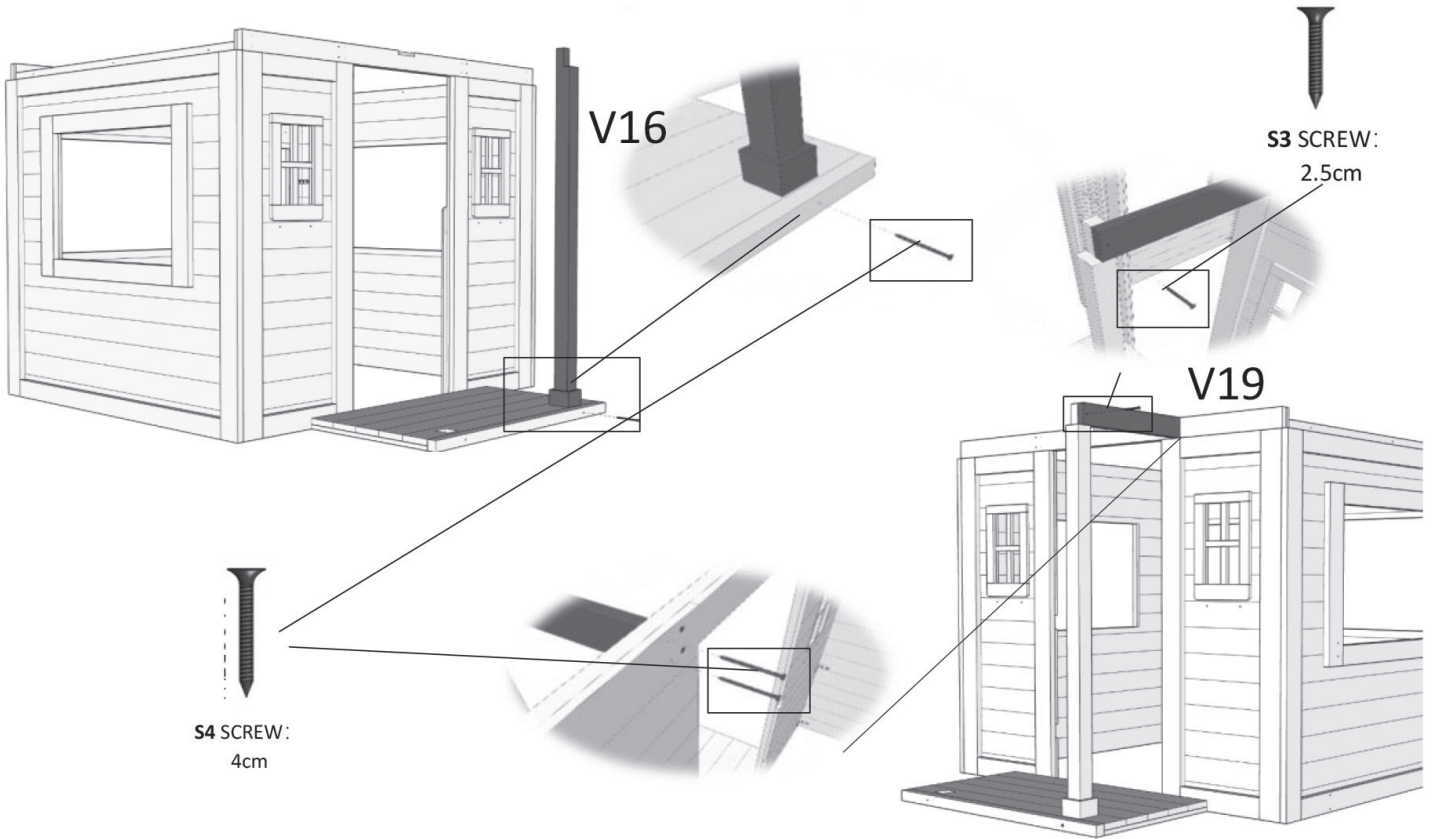

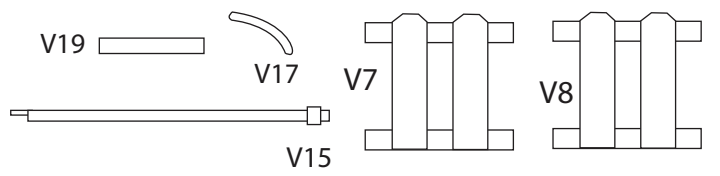
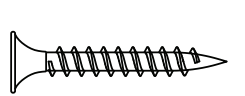
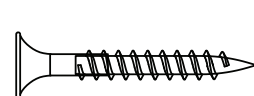
PARTS		HARDWARE	 QUANTITY 1 S3 Screw - 1 1/8in	 QUANTITY 5 S4 Screw - 1 1/4in
-------	--	----------	--	--

STEP 5:

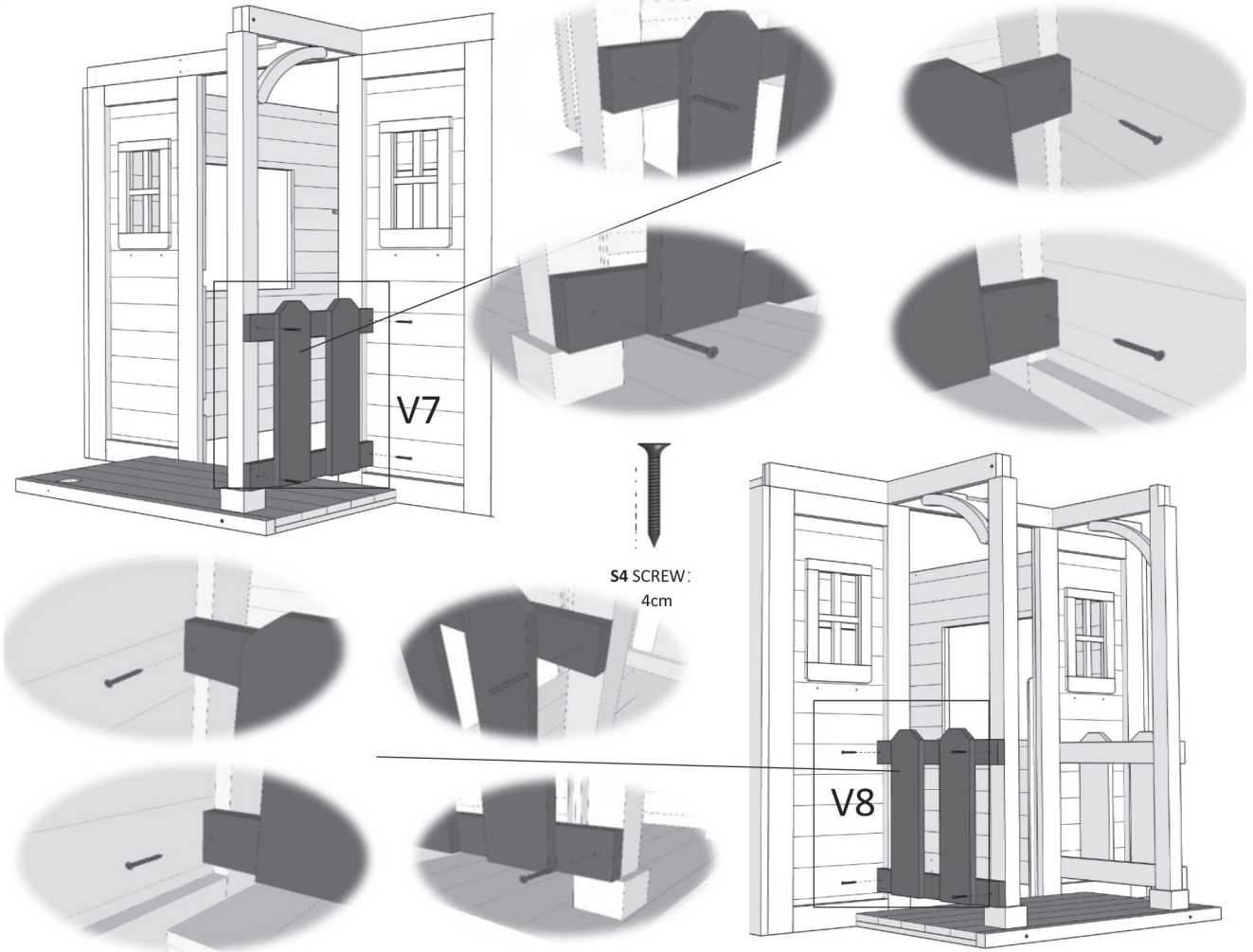
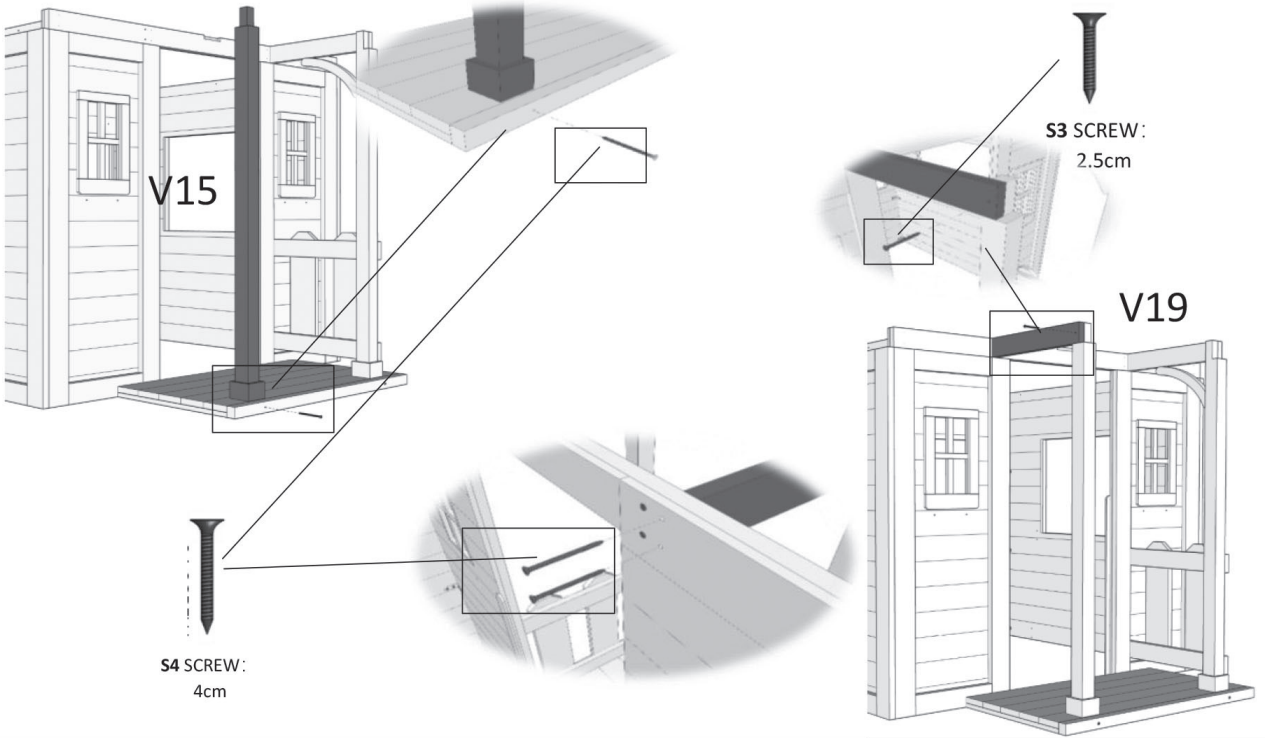

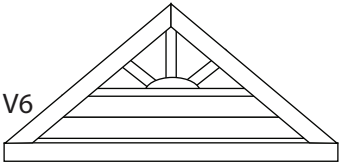
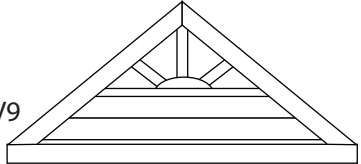
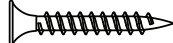
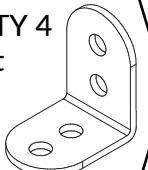
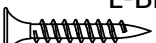
PARTS	 V6	 V9	HARDWARE	 QUANTITY 19 S3 Screw - 1 1/8in	 QUANTITY 4 L-Bracket
				 QUANTITY 19 S2 Screw - 1in	

STEP 6:

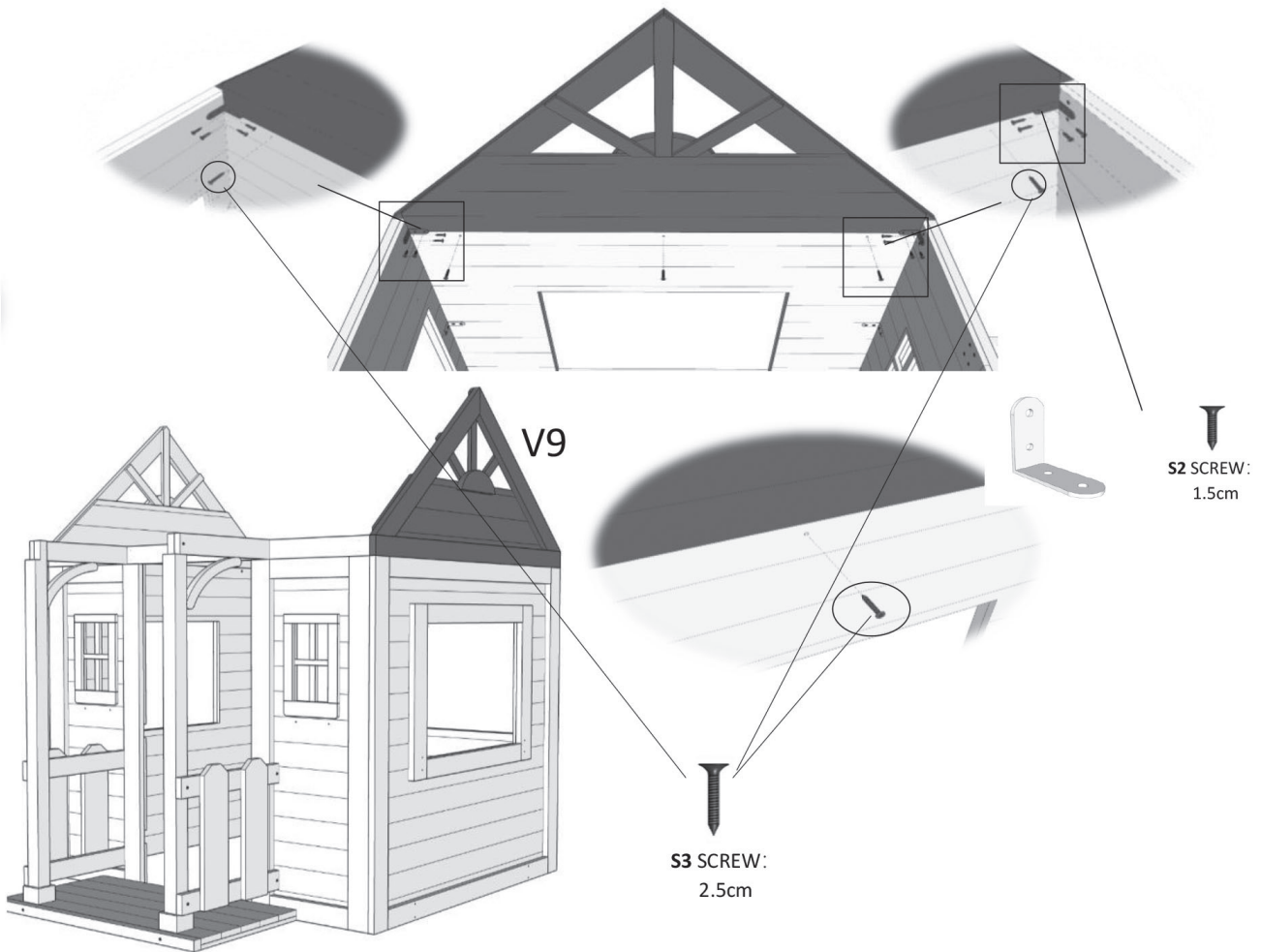
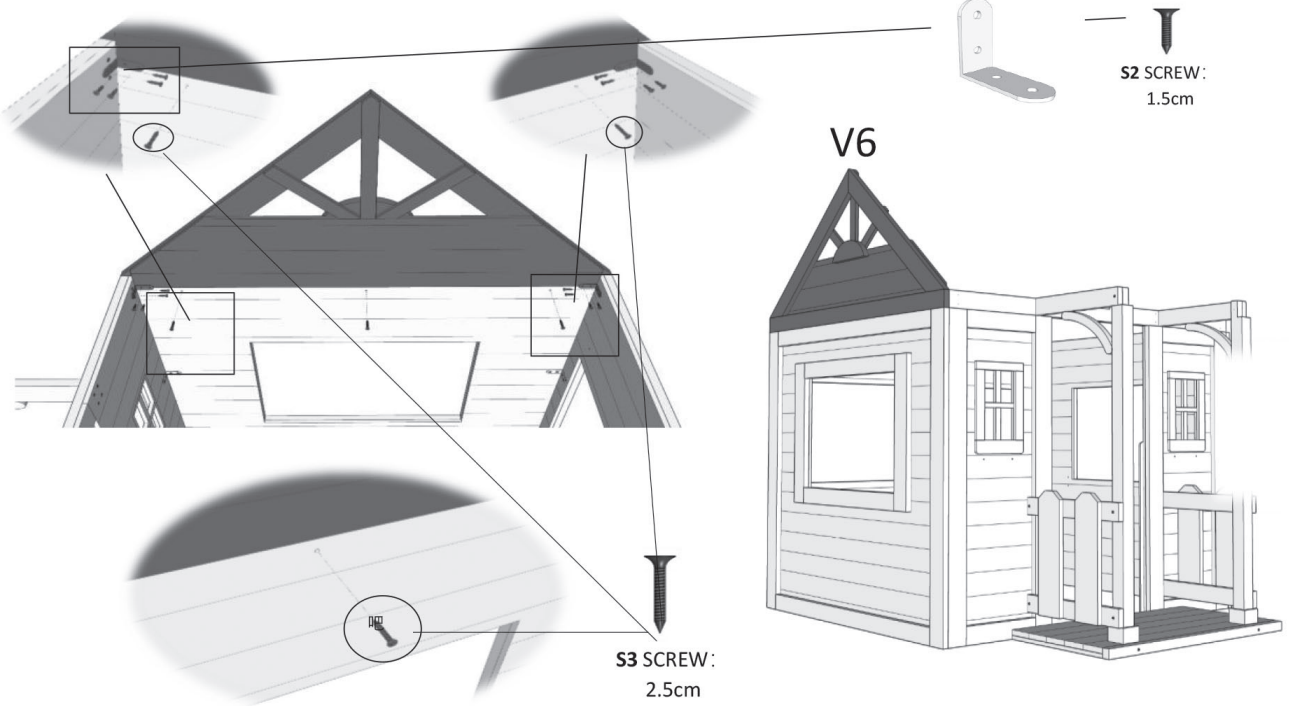

PARTS

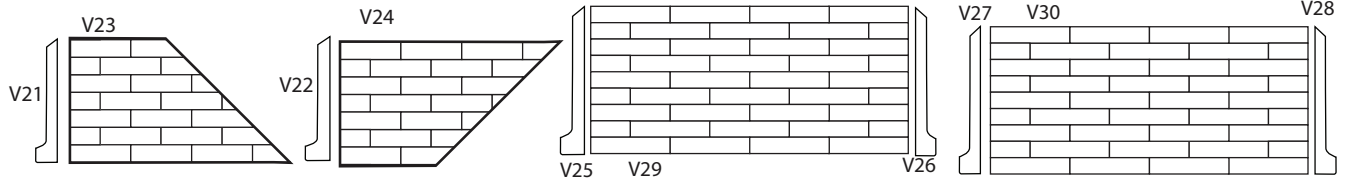

STEP 7:

HARDWARE

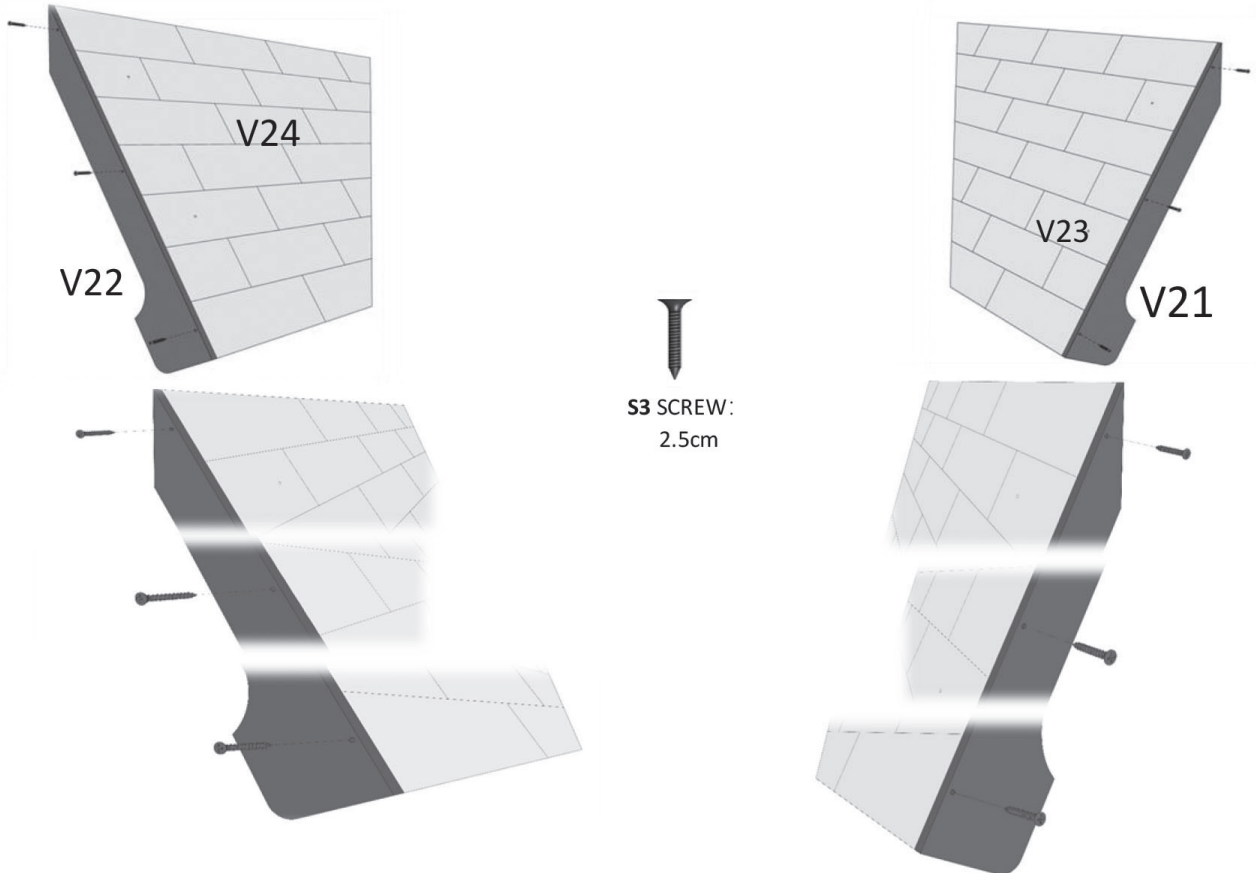
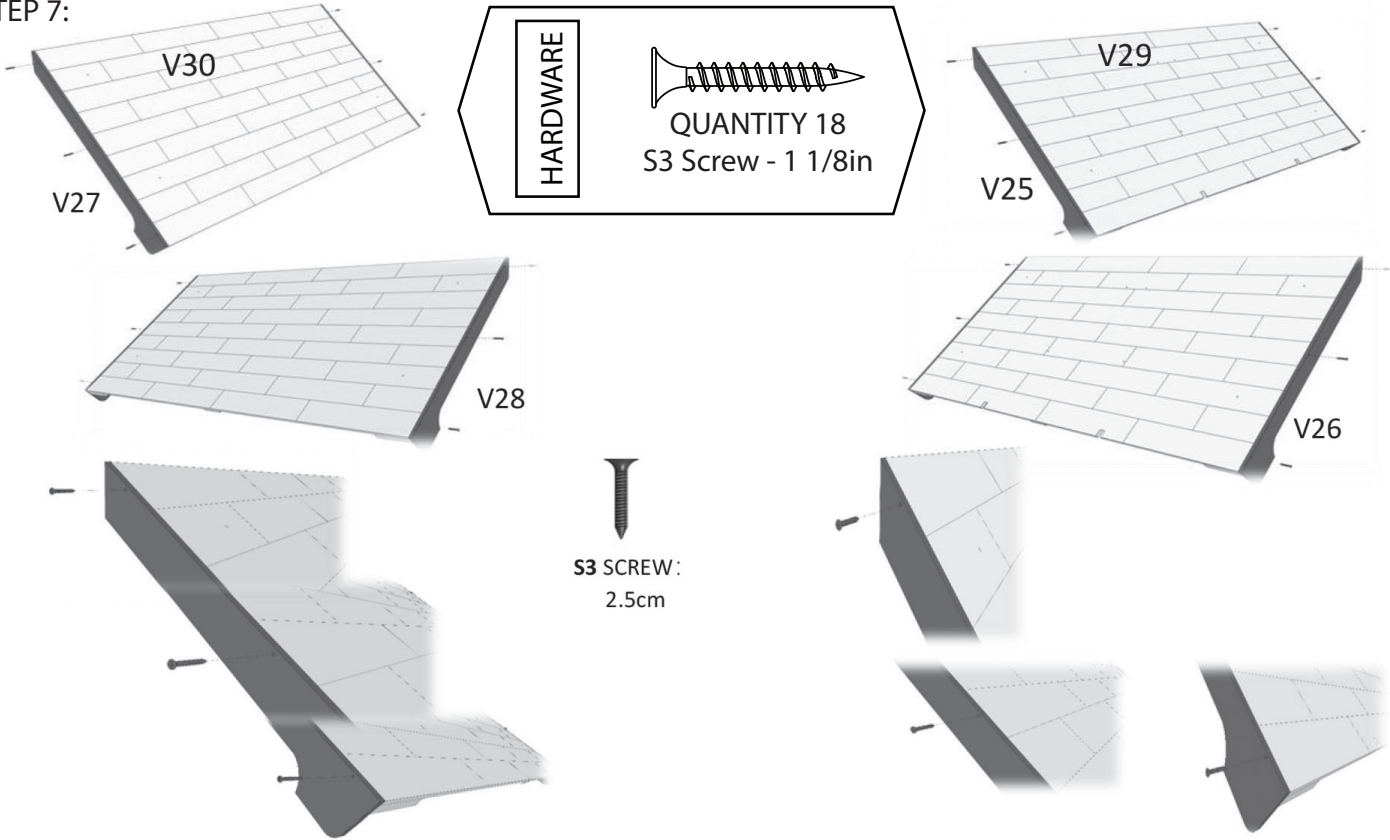
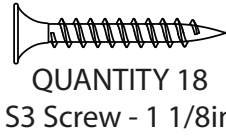

PARTS

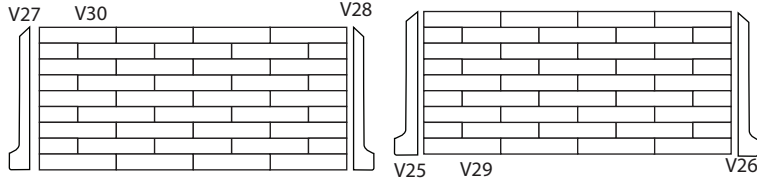

HARDWARE

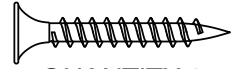

QUANTITY 8
S3 Screw - 1 1/8in

STEP 8:

Playhouse Assembly

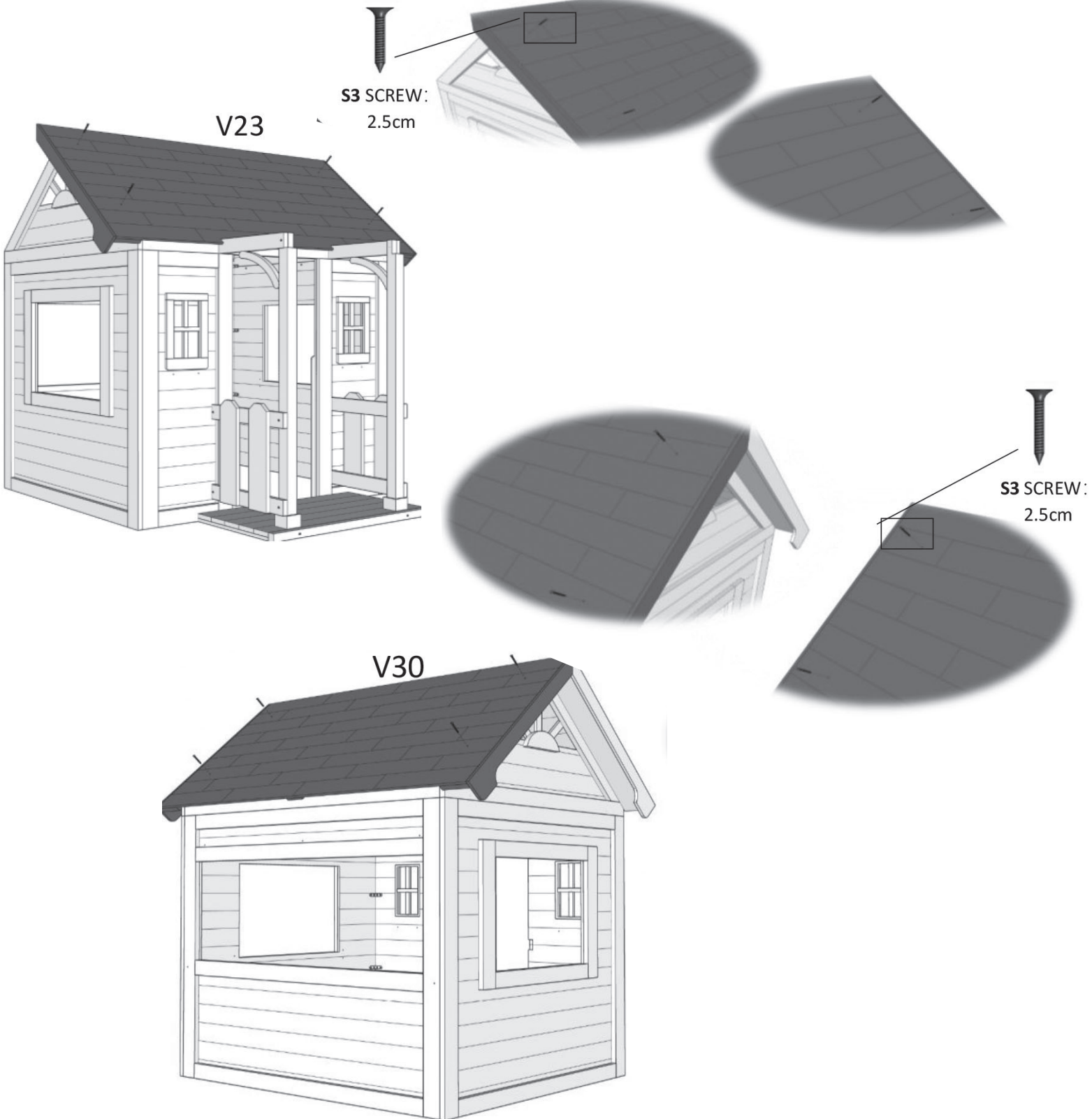

PARTS

V10

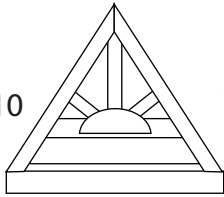

V21

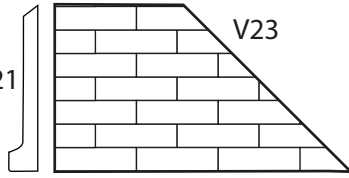

V23

HARDWARE

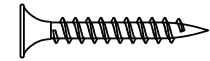

QUANTITY 4
S3 Screw - 1 1/8in

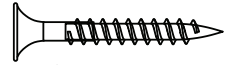

QUANTITY 2
S4 Screw - 1 1/4in

STEP 9:

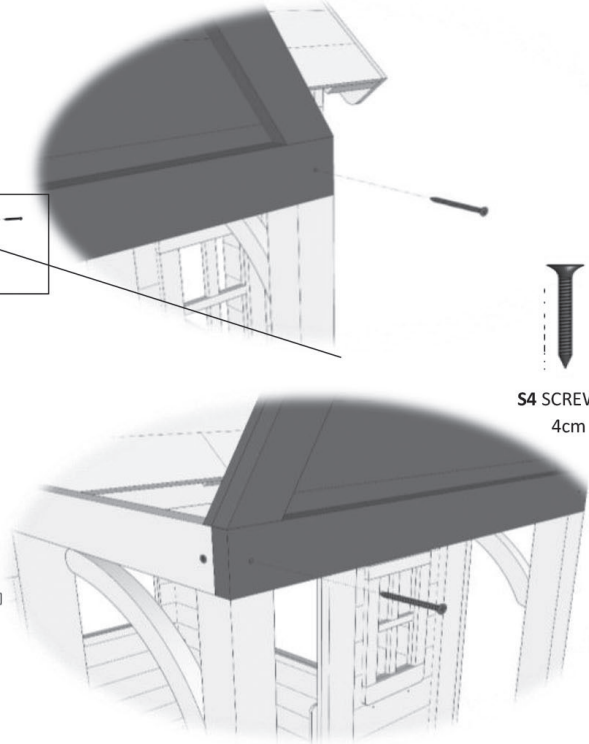
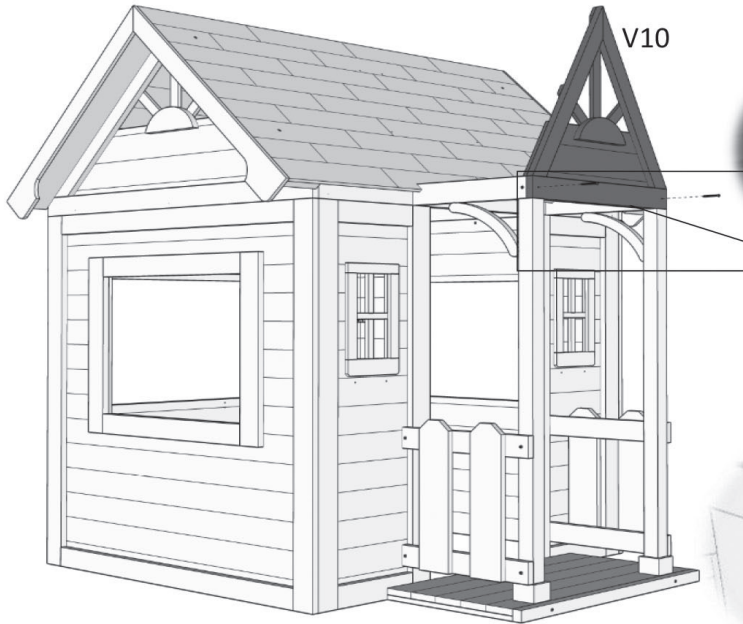

S4 SCREW:
4cm

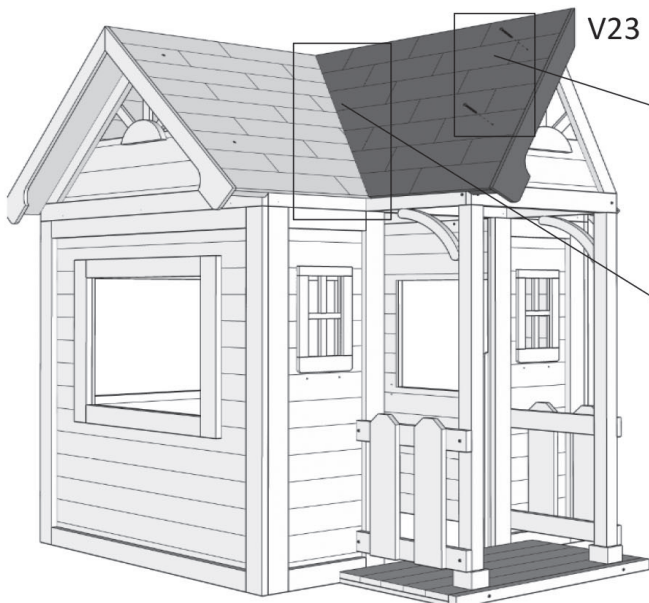

V23

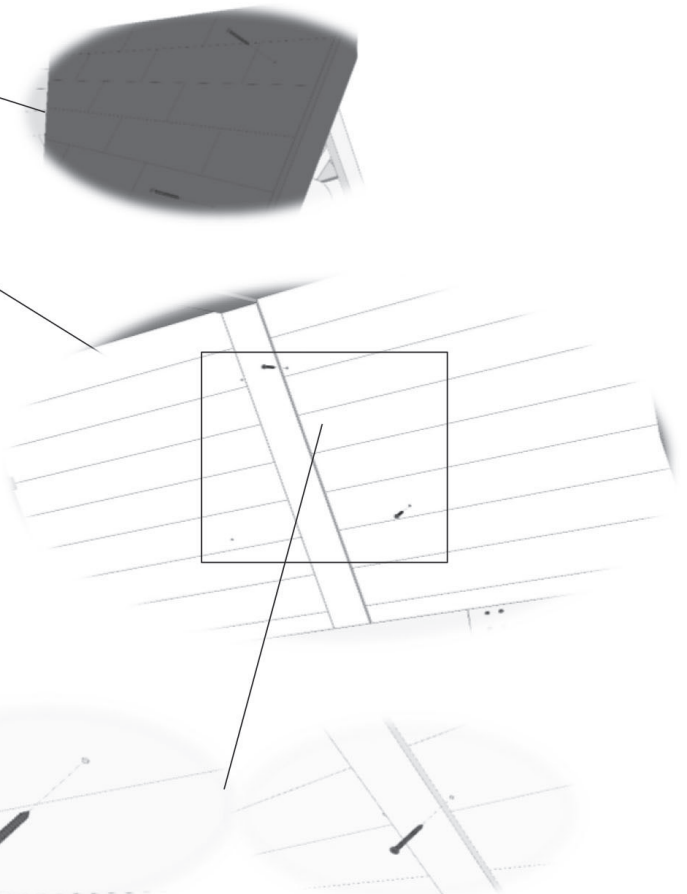

S3 SCREW: 2.5cm

PARTS

V22

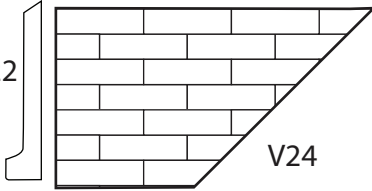

V24

V20 x2

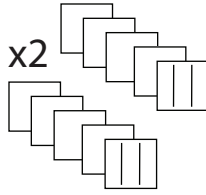

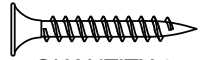

HARDWARE



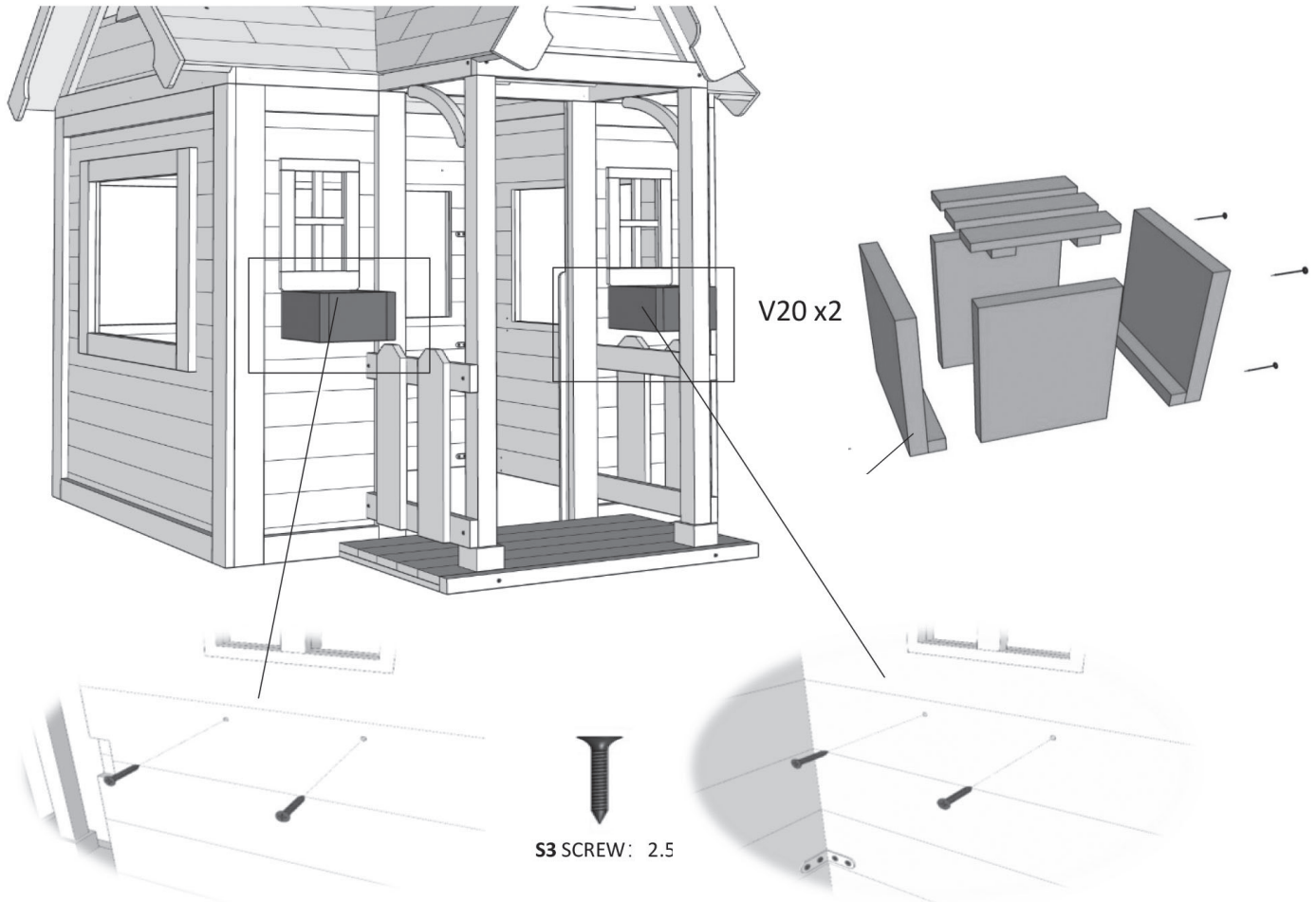
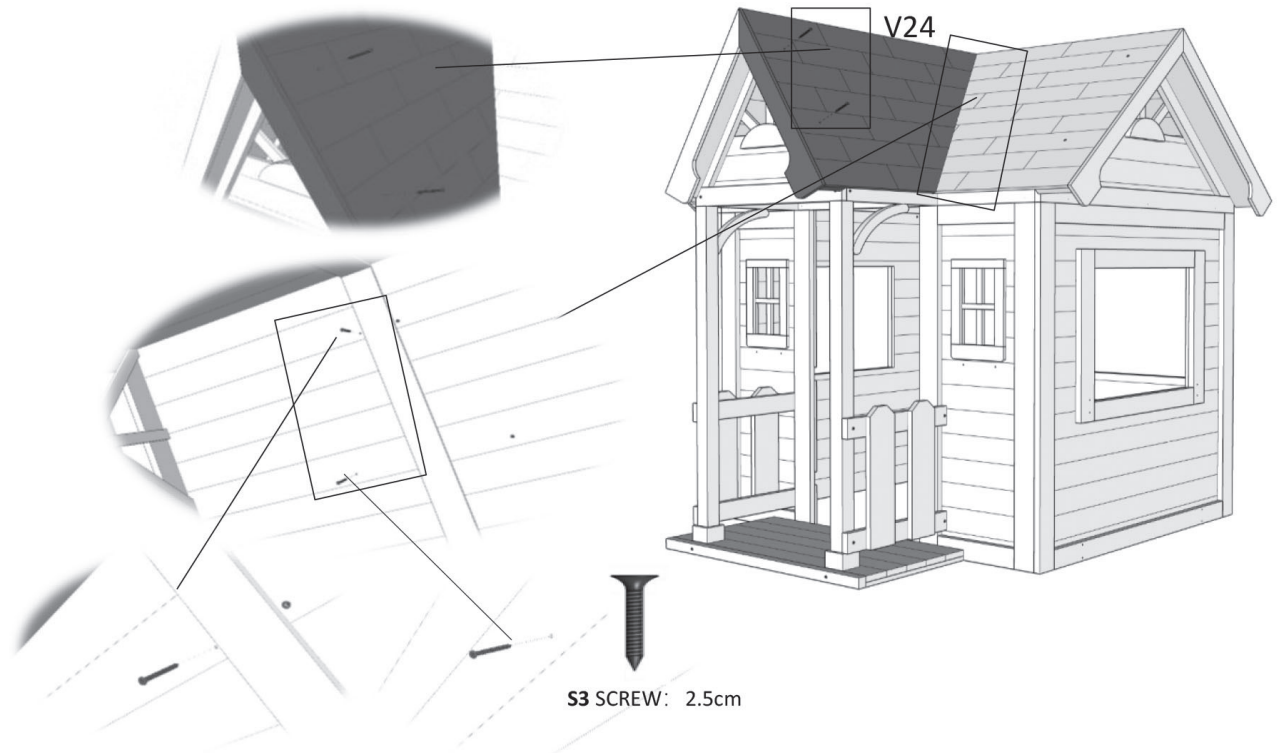

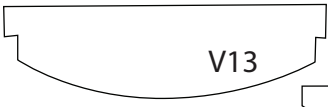
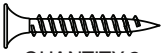
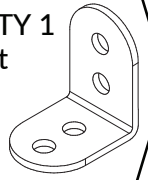

QUANTITY 8
S3 Screw - 1 1/8in

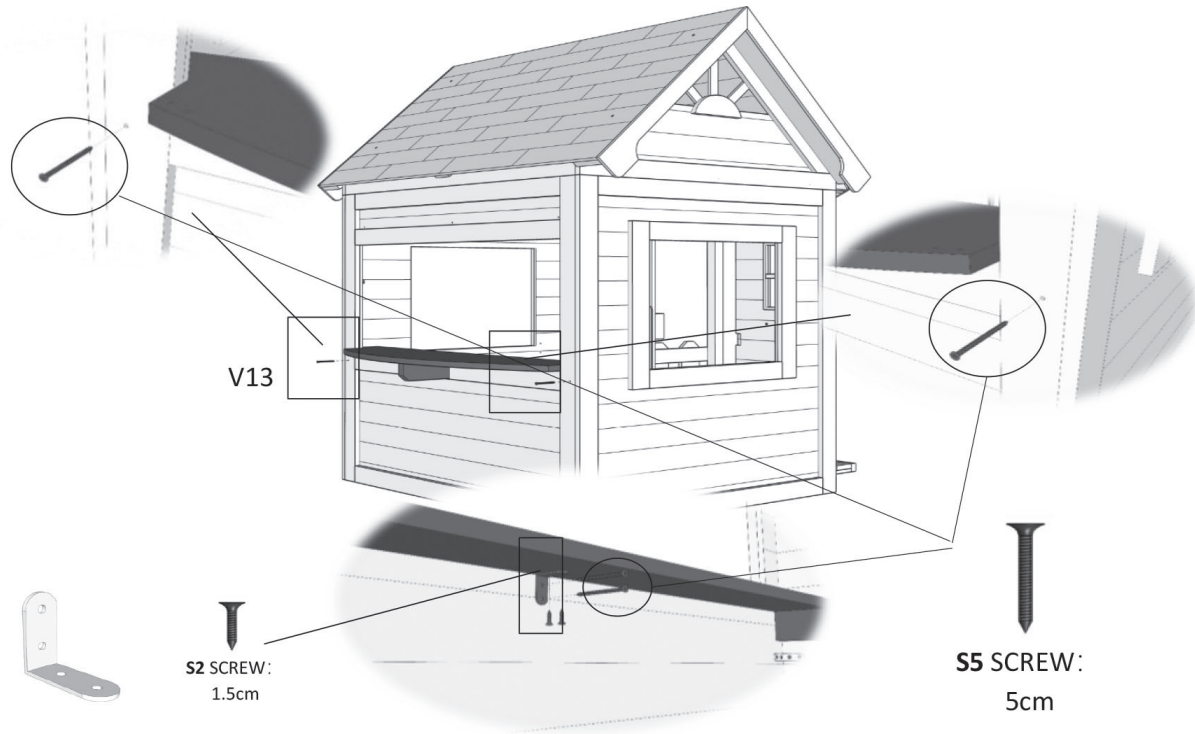

PARTS		HARDWARE		
			QUANTITY 2 S3 Screw - 1 1/8in	
			QUANTITY 2 S2 Screw - 1in	QUANTITY 3 S5 Screw - 1-1/2in

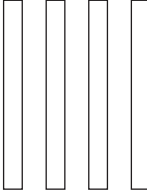
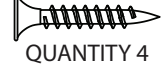
STEP 1

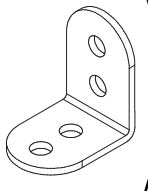

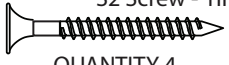
PARTS	V12	V31 x4		HARDWARE	 QUANTITY 4 S2 Screw - 1in	 QUANTITY 16 S4 Screw - 1 1/4in	 QUANTITY 1 L-Bracket
					 QUANTITY 4 S5 Screw - 1-1/2in		

STEP 12:

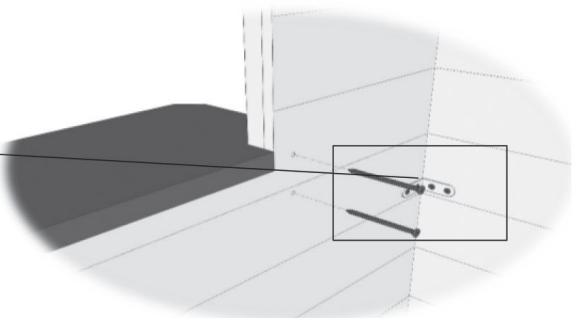
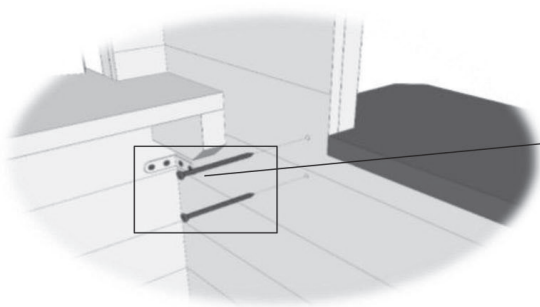
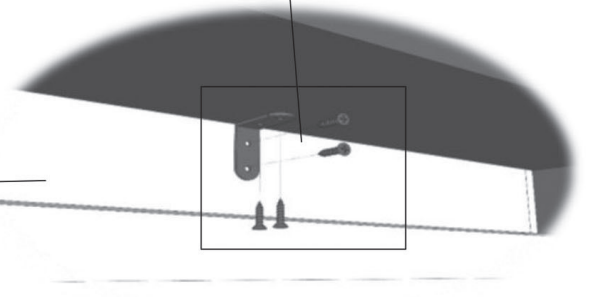
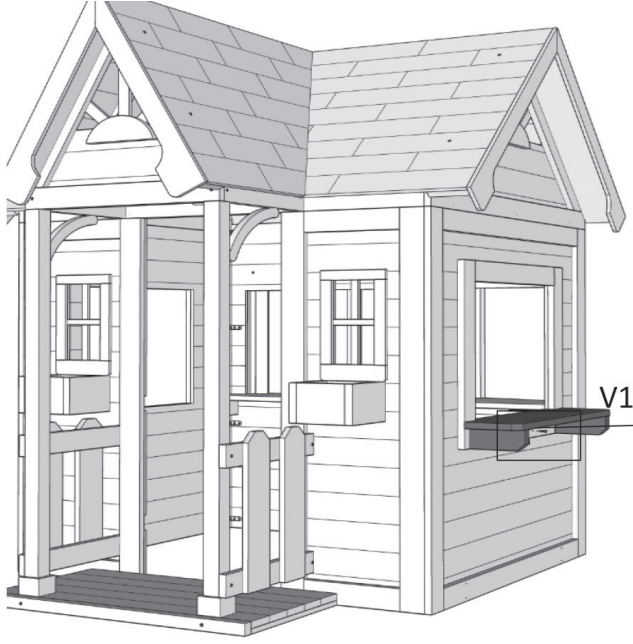
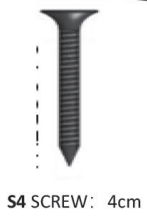
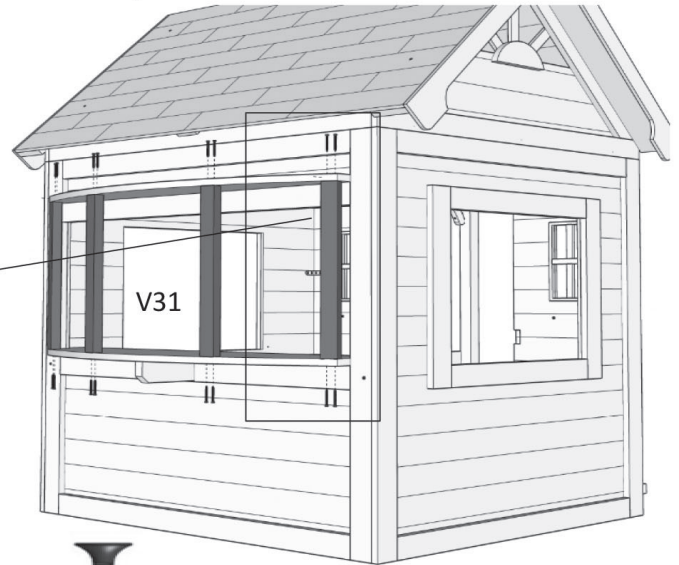
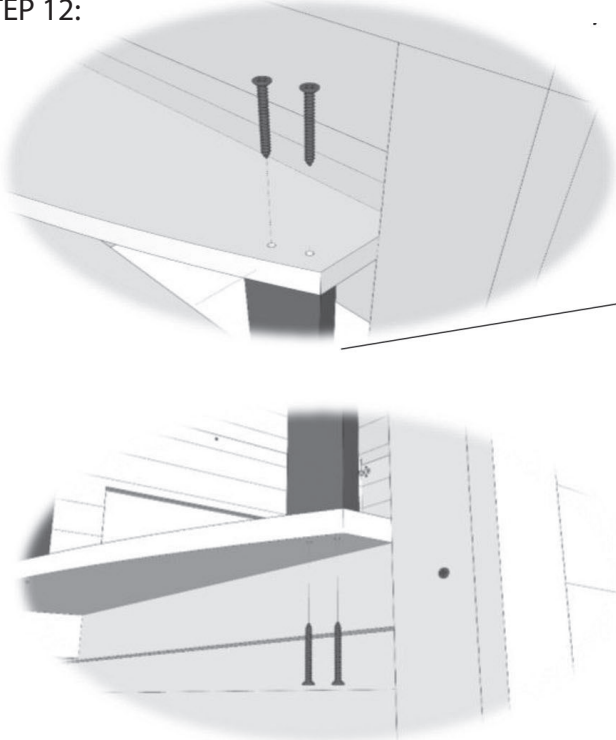

PARTS

V14

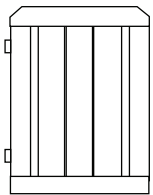

V33 V34

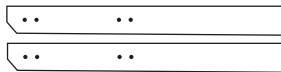
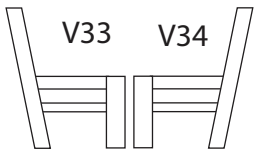

V32 x2

V35

V36

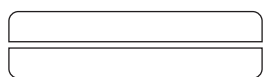

V37

V38

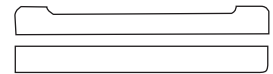

STEP 13:

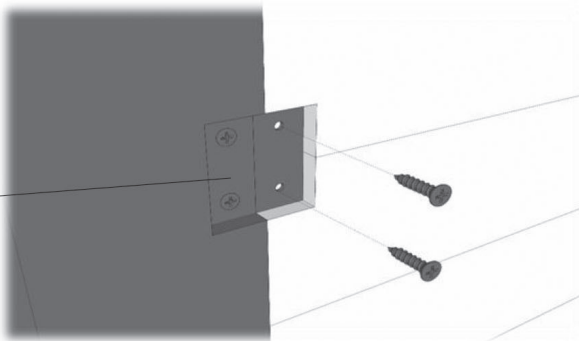
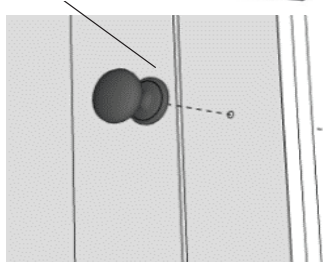
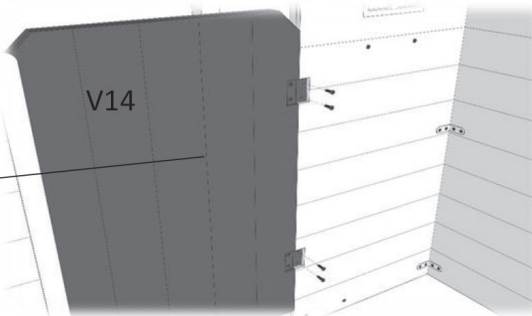
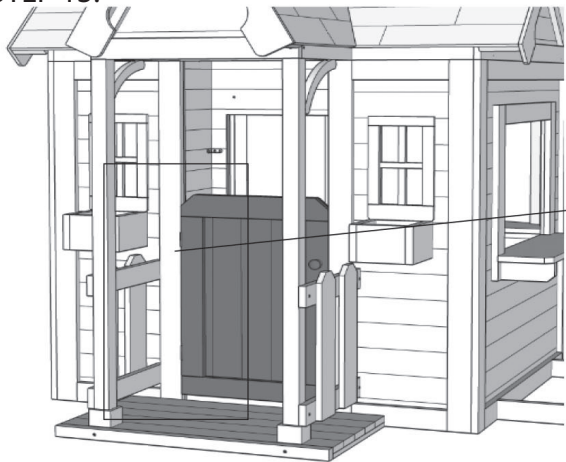

HARDWARE

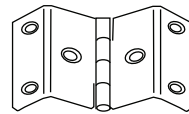

Hinge - 2

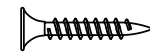

QUANTITY 8
S2 Screw - 1in



QUANTITY 8
S3 Screw - 1 1/8in



QUANTITY 16
S4 Screw - 1 1/4in

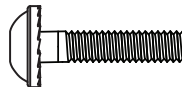

Bolt 1/4x1-1/4in



Door Handle

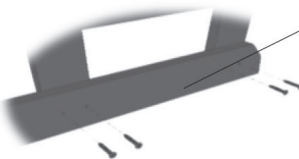
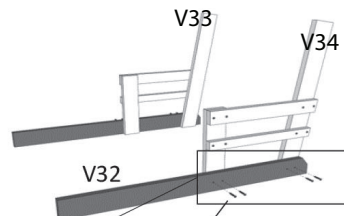
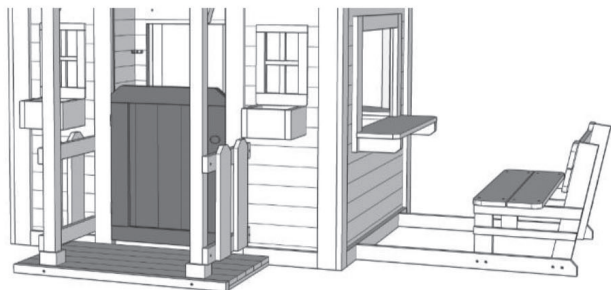

S3 SCREW:
2.5cm

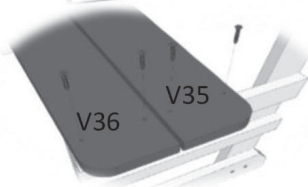
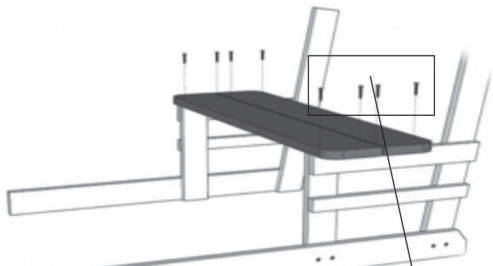

S4 SCREW:
4cm

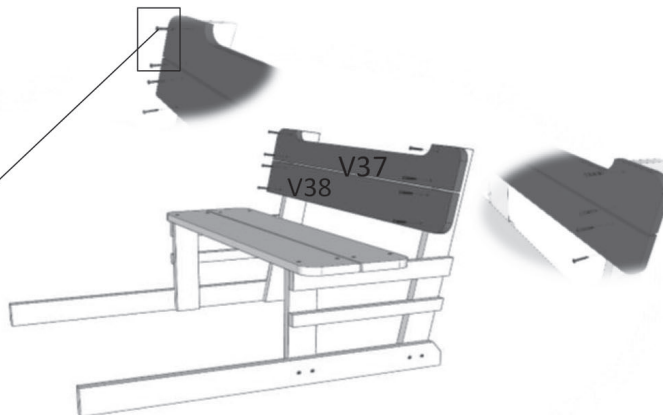

PARTS

HARDWARE

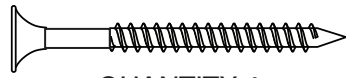

QUANTITY 4
S6 Screw - 1 3/4in

STEP 14:

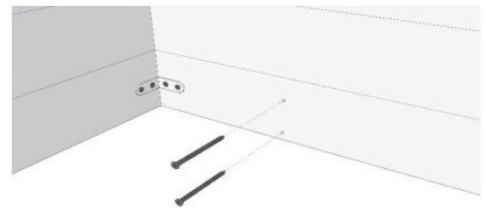
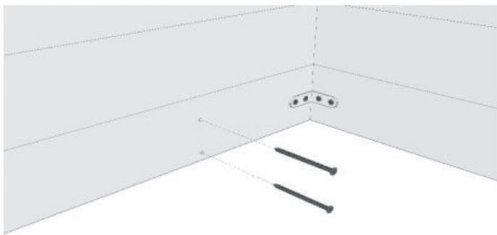
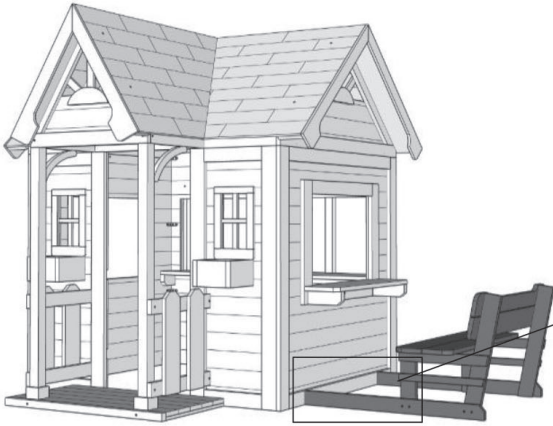

PARTS

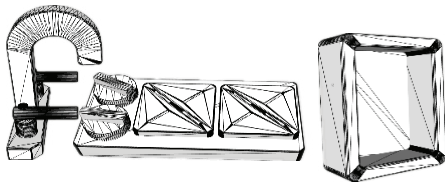

HARDWARE

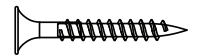

QUANTITY 6 S3 Screw

STEP 15:

