

# PR15

ULTRA-THIN LED RECESSED LIGHT



## PR15 Ultra-thin LED Recessed Light Installation Guide

PR15 fixtures are IC (Insulated Contact) rated: may be installed in ceilings with insulation.

To avoid electric shock, disconnect the power to your ceiling fixture prior to installation.

1.  Make sure the power to your ceiling fixture is turned off.

2.  Cut a hole into your ceiling/installation surface.  
Suggested cutout diameter or length (D):

PRODUCT	DIAMETER	LENGTH	PRODUCT	DIAMETER	LENGTH
4" Round PR15	4.5"	(115mm)	4" Square PR15	4 1/8"	(105mm)
6" Round PR15	6 1/8"	(155mm)	6" Square PR15	6 1/8"	(155mm)
8" Round PR15	8"	(205mm)	8" Square PR15	8"	(205mm x 205mm)

3.  Connect the input end of LED driver to line voltage in a junction box, secured with Velcro.  
(For Multiple PR15 Dimmable Light Kits, please refer to other wiring diagram below).

White (N) to Blue  
Black (L) to Brown

Junction box

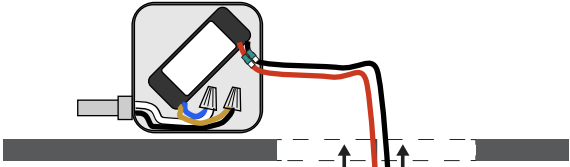
4.  Set the LED driver in the ceiling through the cutout.  
Connect the male moxex connector of the PR15 to the female moxex connector of the driver.  
Pinching both springs upward, push the PR15 into the cutout.  
The fixture should rest firmly into the ceiling.

\*PR15 fixtures are IC (Insulated Contact) rated: may be installed in ceilings with insulation.

5. Make sure all electrical connections match this wiring diagram before restoring power to the fixture.

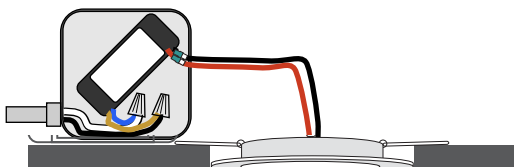

# PR15

ULTRA-THIN LED RECESSED LIGHT



Please read these instructions carefully before beginning installation.

**WARNING** : TO AVOID ELECTRIC SHOCK, DISCONNECT POWER BEFORE INSTALLATION

- Check the contents of your PR15 kit to make sure it matches the parts on the next page.
- If you have any questions or problems please call us toll free at 800.986.0169.
- All LED Waves' fixtures should be installed by a certified electrician.

## PREPARATION

Although the installation of your PR15 kit is not difficult, it does require specific tools and steps to successfully complete it.

### Tools Required for Installation (Installer)

- CORDLESS DRILL
- 4" HOLE SAW OR KEYHOLE SAW
- PHILIPS SCREWDRIVER

### Parts List (by LEDWAVES)

- 2X PR15 4-INCH LED FIXTURES
- 2X LOW-VOLTAGE QUICK-CONNECT WIRES
- 1X DIMMABLE LED DRIVER
- 1X JUNCTION BOX (Please check with LEDWaves for availability of purchasing box)

### Dimmers by others

- Low voltage electronic dimmers are recommended

## INSTALLATION

### STEP 1 Planning.

During the planning phase please determine the locations for the (where the junction box will be located) :

- Power sources for your kit (120V-277V), the driver should be accessible.
- Fixtures (LED PR Series).

See the diagram examples on the following page (Or consult our lighting experts by calling 800.986.0169).

### STEP 2 Low-Voltage Quick-Connect Wire Map.

Map out the path your low-voltage Quick-Connect wire will travel from the transformer to its farthest point. (Refer to diagrams p. 3 to 9).

### STEP 3 Cut Ceiling Holes for Fixtures (see page 1 for holes size).

Determine the locations of the joist and strapping in your ceiling and make sure to avoid cutting through them during installation. If the preferred location of your fixture falls on a joist or strapping location, move the location of the fixture to either side of it. Mark the ceiling with a pencil and cut the hole using a hand or hole saw.

Cut the appropriate circle or square in the ceiling using a Hole Saw or a Keyhole Saw, Repeat this step for all the fixtures.

### STEP 4 Running the low-voltage Quick-Connect Wire.

This is the easiest part of the installation, LEDWaves PR15 kits. These units are pre-wired so you cannot incorrectly connect them. All connectors are asymmetrical and only fit in one way (Quick-Connects).

- From the driver to the first PR15 is 8 feet.
- The distance between the first and second PR15 is 16 feet.
- The distance between the second PR15 and the driver is 8 feet.
- If the harness cables are not long enough please contact an LED expert at LEDWaves for custom harness wire cuts.

Start at the closest point to the transformer, connect the male end of the Quick-Connect wire to the female end of the connector in the red wire from the driver.



The closer the driver is to the fixture the better. The ideal location is in the center of the fixtures.

Connect the other female end of the Quick-Connect wire to the male end of another Quick-Connect wire. Continue this process until all the Quick-Connect wires are connected. If done correctly, the last wire should end with a female connector.

# PR15

ULTRA-THIN LED RECESSED LIGHT



### STEP 5 Installing the Fixtures.

Connect the wire from the fixture with the Quick-Connect wire.

There are no tools required to connect the wires, simply snap them together. Please do not cut the wires.

**ALL FIXTURES MUST BE CONNECTED BEFORE ELECTRIFYING OTHERWISE THE FIXTURES WON'T TURN ON.**

Fold the wings on the retaining clips back against the body of the fixture and press the fixture up into the opening in the ceiling, carefully pushing the wires in ahead of it. Make sure each fixture is securely in place.

For Area layouts, connect the female end of the Quick-Connect wire to the male end of the connector in the blue wire from the driver. Please, see **Diagram 1** for reference.

For linear layouts, connect the female end of the Quick-Connect wire to the male end of the custom-length wire (sold separately, call 800.986.0169 for details.) Connect the female end of the custom-length wire to the male end of the connector in the blue wire from the driver. Please see **Diagram 2** for reference.

- TOOLS ARE NOT REQUIRED TO CONNECT THE WIRES.
- SIMPLY SNAP THE MALE CONNECTOR TO THE FEMALE CONNECTOR.
- **PLEASE DO NOT CUT THE WIRES\*\*.**

2 Light-Kit : Wiring Plan - **CIRCLE**

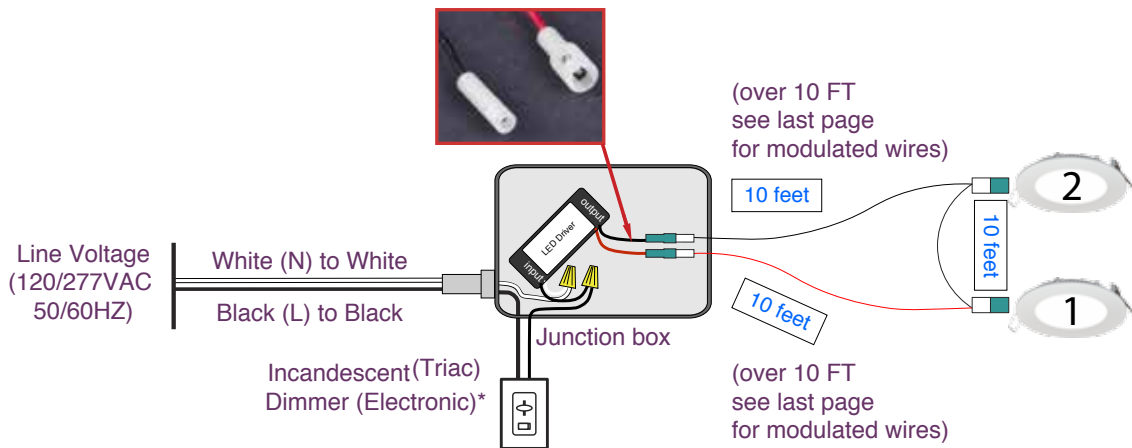

\* Works best for the **ELECTRONIC LOW VOLTAGE** dimmers.

\*\* The reason for not cutting the wires is the polarity can be reversed and short out the system.

Diagram 2 : Wiring Plan - **LINEAR**

See Above



3 Light-Kit INSTALLATION GUIDE 4", 6", 8"

3 Light-Kit : Wiring Plan - **CIRCLE**

Diagram 1

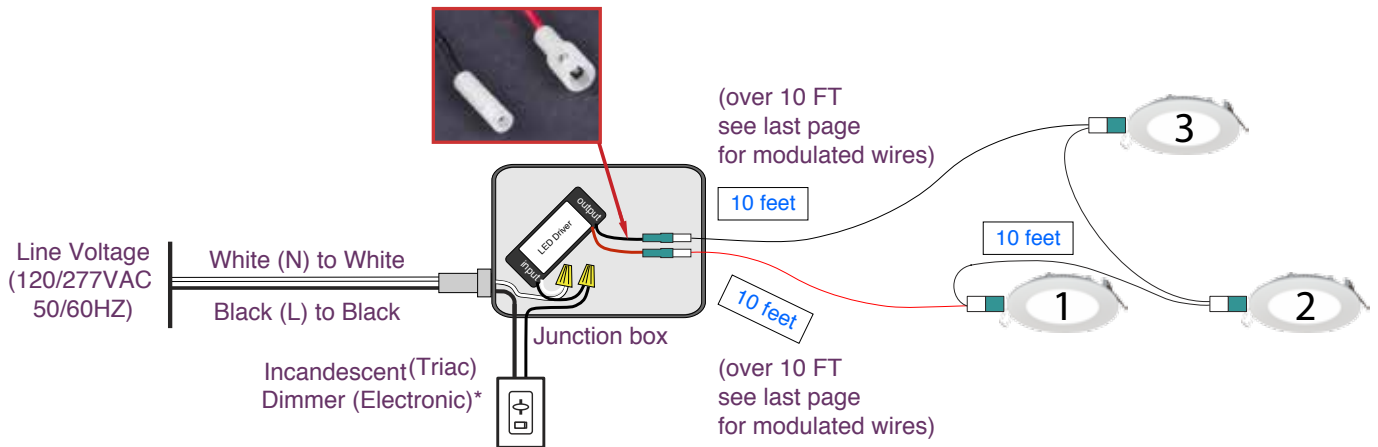

\* Works best for the **ELECTRONIC LOW VOLTAGE** dimmers.

\*\* The reason for not cutting the wires is the polarity can be reversed and short out the system.

Diagram 2

3 Light-Kit : Wiring Plan - **LINEAR**

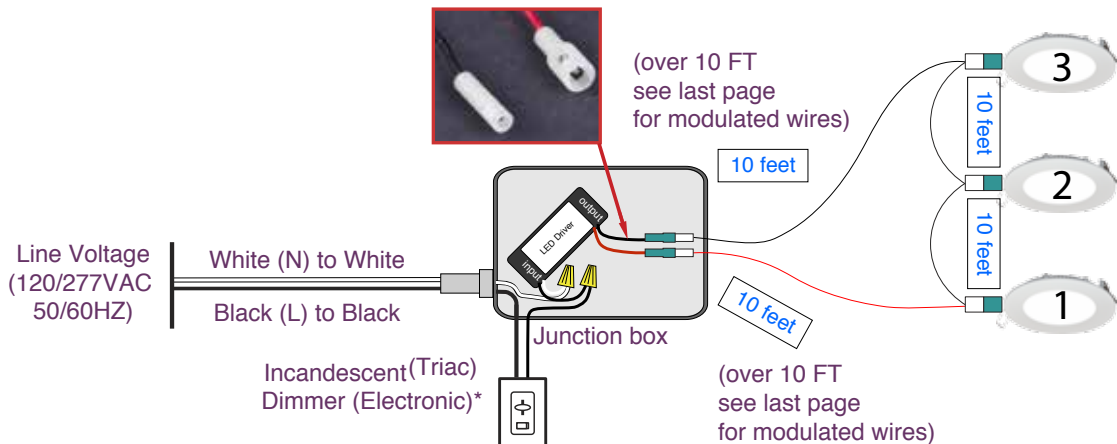



4 Light-Kit INSTALLATION GUIDE 4", 6", 8"

4 Light-Kit : Wiring Plan - CIRCLE

Diagram 1

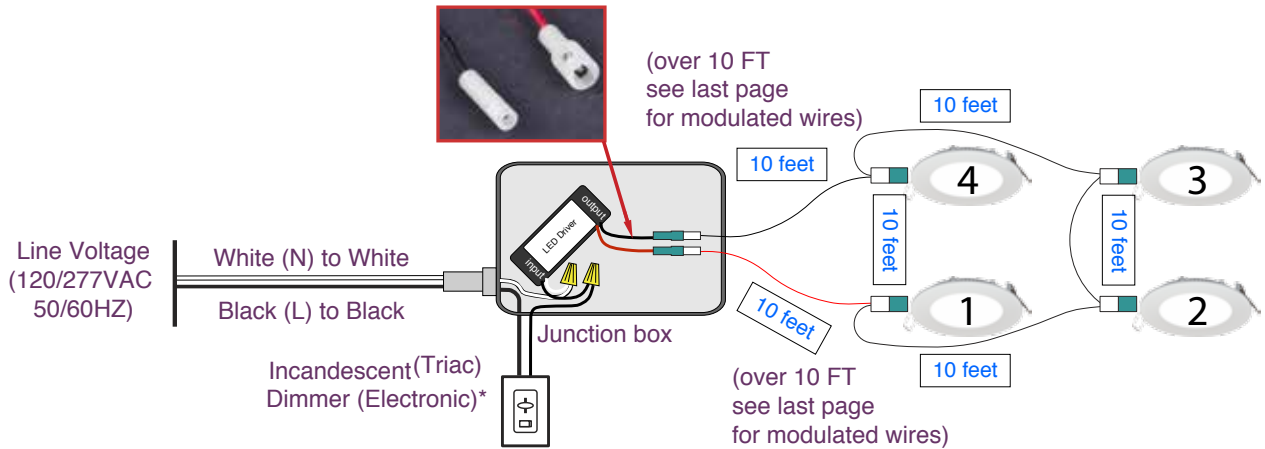

\* Works best for the **ELECTRONIC LOW VOLTAGE** dimmers.

\*\* The reason for not cutting the wires is the polarity can be reversed and short out the system.

Diagram 2

4 Light-Kit : Wiring Plan - LINEAR

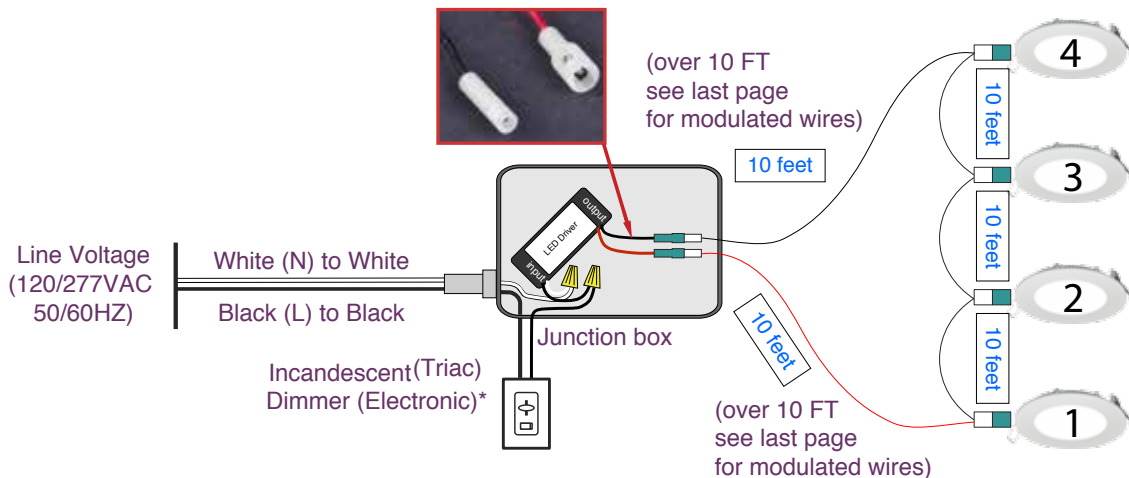

**PR15**

ULTRA-THIN LED RECESSED LIGHT



**5 Light-Kit INSTALLATION GUIDE 4", 6"**

5 Light-Kit : Wiring Plan - **CIRCLE**

Diagram 1

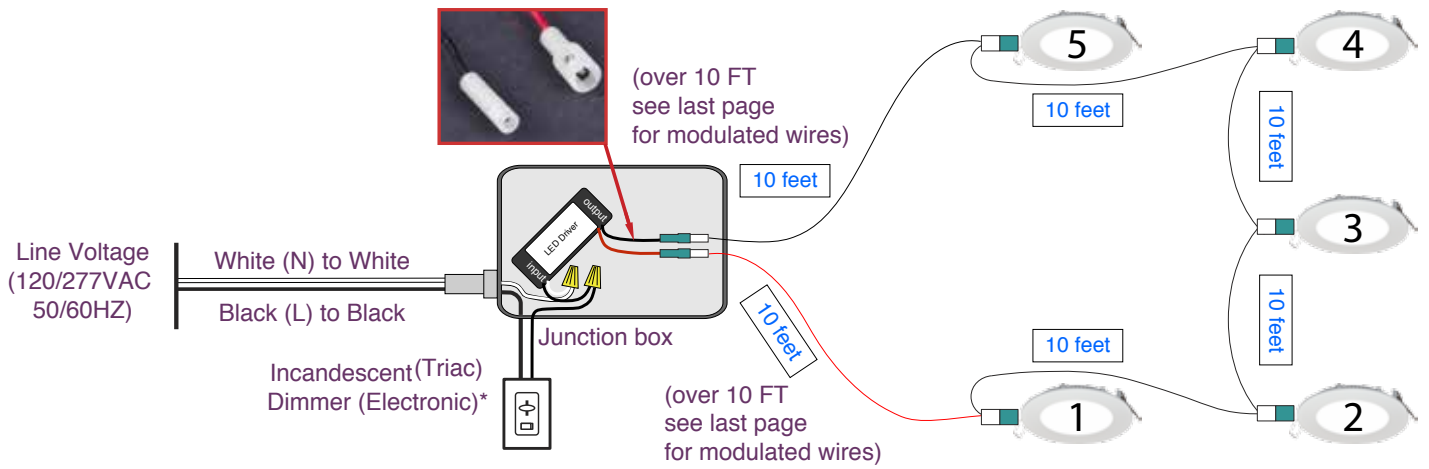

- \* Works best for the **ELECTRONIC LOW VOLTAGE** dimmers.
- \*\* The reason for not cutting the wires is the polarity can be reversed and short out the system.

Diagram 2

5 Light-Kit : Wiring Plan - **LINEAR**

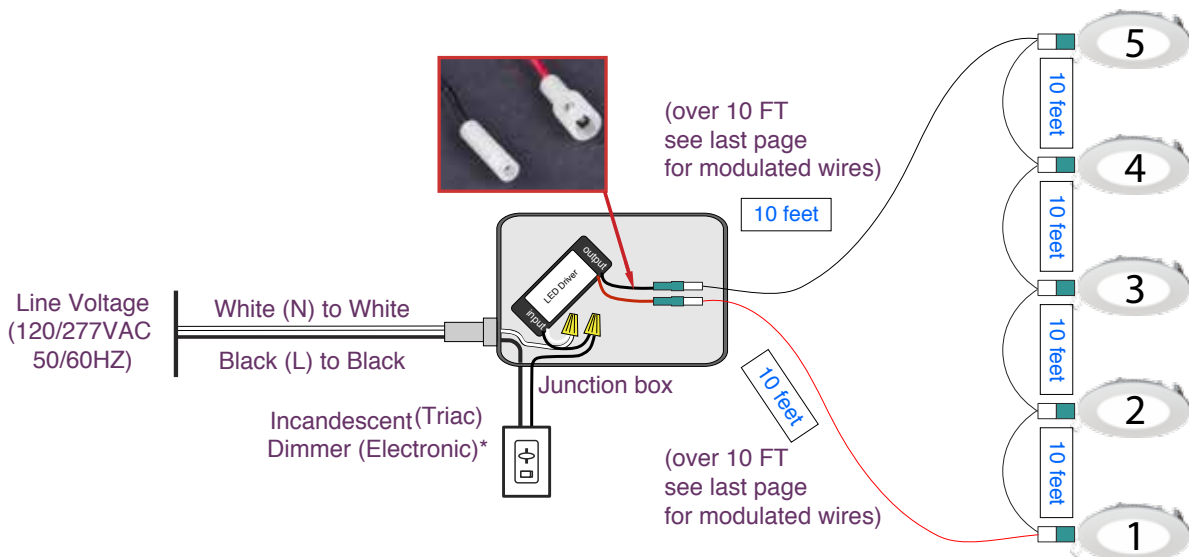



6 Light-Kit INSTALLATION GUIDE 4", 6"

6 Light-Kit : Wiring Plan - **CIRCLE**

Diagram 1

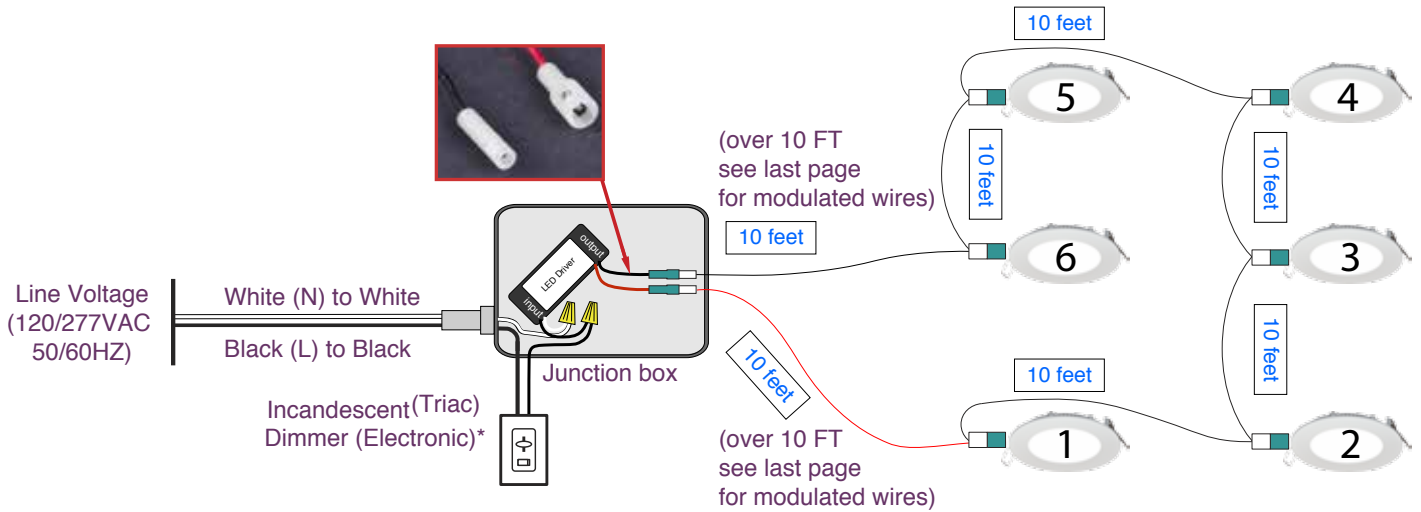

- \* Works best for the **ELECTRONIC LOW VOLTAGE** dimmers.
- \*\* The reason for not cutting the wires is the polarity can be reversed and short out the system.

Diagram 2

6 Light-Kit : Wiring Plan - **LINEAR**

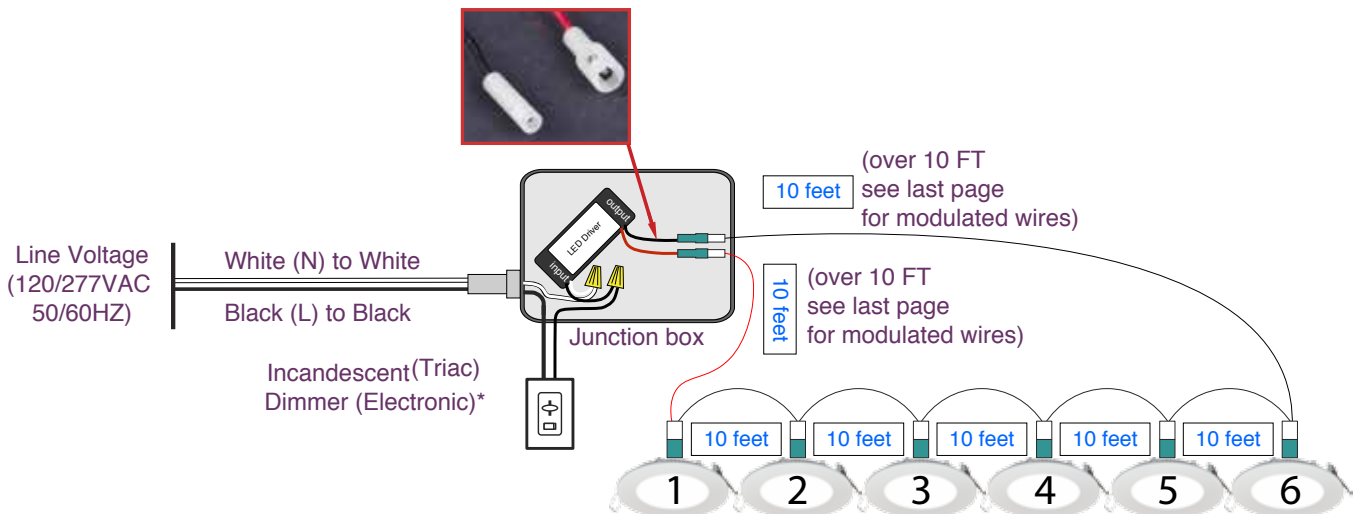



**7 Light-Kit INSTALLATION GUIDE 4", 6"**

7 Light-Kit : Wiring Plan - **CIRCLE**

Diagram 1

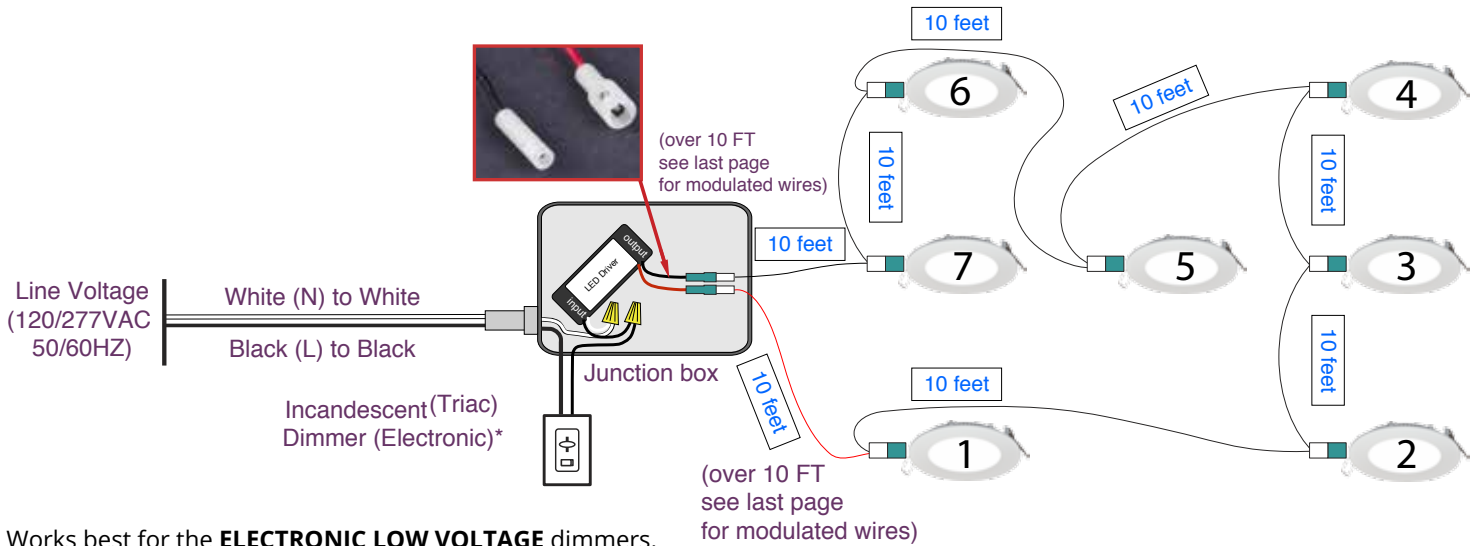

- \* Works best for the **ELECTRONIC LOW VOLTAGE** dimmers.
- \*\* The reason for not cutting the wires is the polarity can be reversed and short out the system.

Diagram 2

7 Light-Kit : Wiring Plan - **LINEAR**

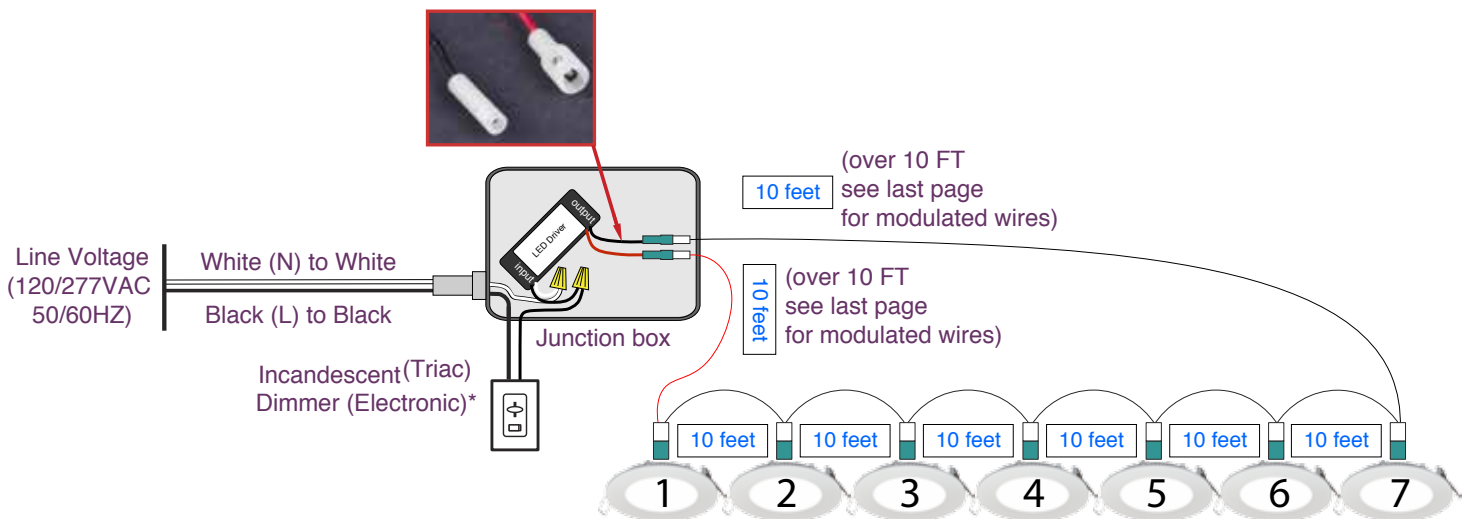





### 8 Light-Kit INSTALLATION GUIDE 4", 6"

#### 8 Light-Kit : Wiring Plan - **CIRCLE**

Diagram 1

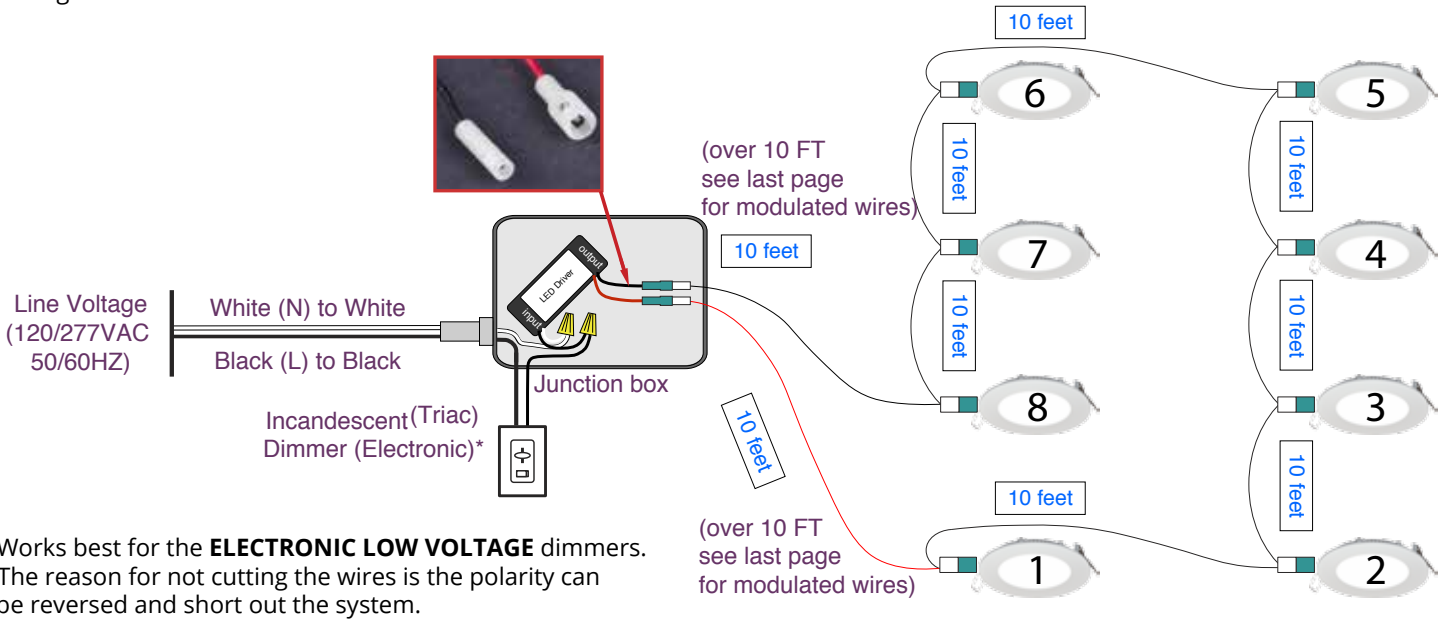

\* Works best for the **ELECTRONIC LOW VOLTAGE** dimmers.  
\*\* The reason for not cutting the wires is the polarity can be reversed and short out the system.

Diagram 2

#### 8 Light-Kit : Wiring Plan - **LINEAR**

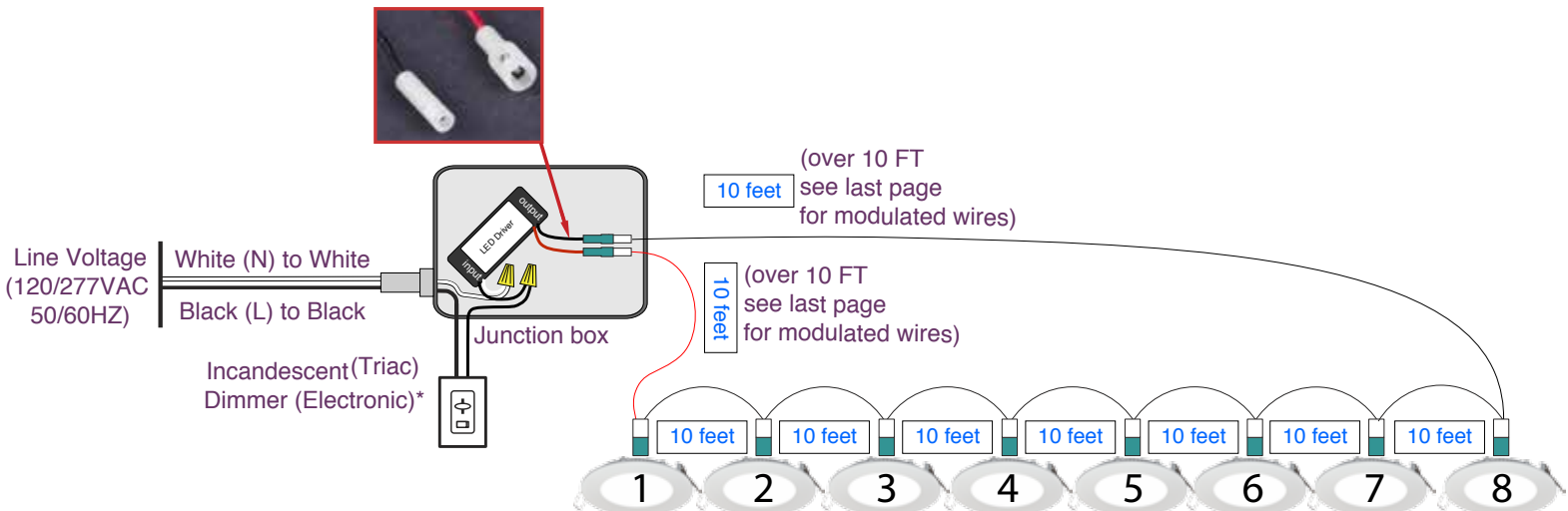

# PR15

ULTRA-THIN LED RECESSED LIGHT



## INSTRUCTIONS

(Modulated extensions for live feed & dead end)

Last Page

These extensions can be used either leaving the driver or coming back to the driver.

### Modulated extensions for live feed

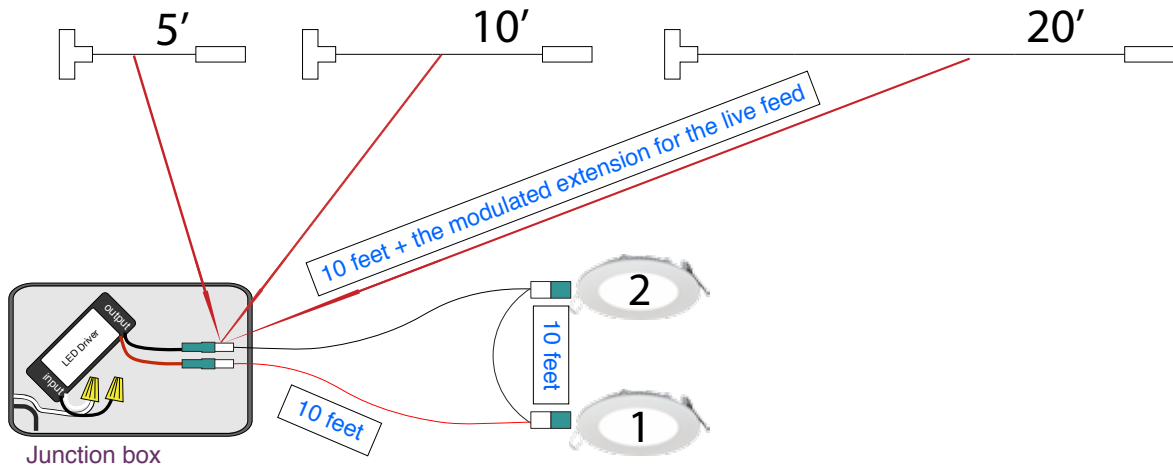

These extensions can be used either leaving the driver or coming back to the driver.

### Modulated extensions for live feed

