

upliance.ai

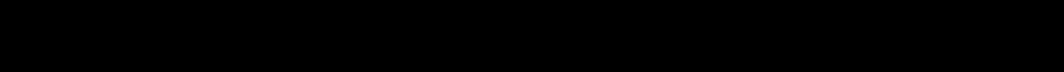

SCAN HERE FOR UPDATED VERSION

OWNER'S MANUAL



If it's a cooking emergency or you just want to say hi
Whatsapp or Call on +91 89049 62940
Email: hi@upliance.ai

COPYRIGHT

The copyright for texts, design, photography and illustrations lies with React Labs Private Limited. All rights reserved. This publication may not – in part or in whole – be reproduced, stored in a retrieval system, transmitted or distributed in any form or by any means, electronic, mechanical, photocopying, recording or otherwise.

WARRANTY & LIABILITY

For the warranty period, please refer to your product terms and conditions. upliance may only be repaired by React Labs customer service or an authorised service.

Use only parts provided with React Labs or original spare parts from React Labs. Never use the upliance in combination with parts or equipment not provided by React Labs Private Limited. Otherwise your warranty and the liability for material defects shall be rendered void.



Table of Contents

1. Let's get started!	1
2. Intended Use	2
3. Safety comes in many flavours	3
4. What's in the box	3
5. Location, Location, Location	5
6. Switching on for the first time.	6
7. Cleaning for the first time.	6
8. Familiarise yourself with the accessories	7
9. Get Cooking	13
10. Cleaning & Maintenance.	14
11. Power Outage	16
12. Hazards & safety instructions.	16
13. Specs & Features for days.	23
14. Warranty.	24
15. Customer Service.	24

1. Let's get started!

Congratulations on purchasing the upliance!

From this day forth, you will never eat boring food again. **pinky promise**

Before using your [upliance](#) for the first time, you should ideally attend a demo with Team Up . If you are too excited for that, we urge you to watch a couple of the demo videos on our channel. Start your cooking journey with confidence.

This owner's manual will show you the safety features of the upliance and contains important information on how to use it safely.

- a. Regularly consult the digital owner's manual for updates. It is posted on our website and you should receive them via email too.
- b. Please read this owner's manual carefully before using the upliance and its accessories for the first time.

If you are feeling stuck or lost, we are here to help.
Whatsapp or Call us on +91 89049 62940



1.1 Save it for a rainy day

Save this owner's manual for future reference and consult it regularly.

If you are sharing the device with multiple people, have them and your whole household read this owner's manual.

Cooking is for everyone!

1.2 What's what

Up  and upliance.ai are the brand names owned and operated by React Labs Pvt Ltd. At Up , we design and build 'upliances'. (Because appliances kinda suck in the 2020s).

upliance is a smart cooking assistant. It is the only device to get you to eat better food and assist you if you want to start cooking and ditch the apps.

Through the course of this manual, you will read the words 'upliance' or 'device' being used interchangeably - they all refer to the upliance. When we use the phrases Up  or upliance.ai we are referring to the Brand and the Team who built your fancy new "upliance".

With the legal fail safes out of the way, it's time for you to start eating great food!
Bon Appétit.

2. Intended use

- a. Use the device and accessories only for their intended purpose in order to prevent risks to you and other people. Prevent damage to the device or to other property and equipment.
- b. The upliance is a kitchen appliance intended to be used for cooking and preparing food. It is designed to be used at home and or in similar environments.
- c. The device is exclusively intended for use by adults and is not meant to be used by children. Even when we make cooking child's play, it would be best to avoid young children from using it, alone or unsupervised.

Keep children away from the upliance. Keep young children away from the power cable, so that they cannot pull it off the countertop. Always unplug the upliance when it is not in use. Make sure to warn children of the potential dangers of heat and steam, hot condensation and hot surfaces, sharp edges and blades. Close supervision is necessary when the appliance is used near young children.

Children should not play with this *upliance*.

- d. This device may be used by people with reduced physical, sensory or mental abilities or lack of experience and/or knowledge, if they have been

supervised or instructed in the safe use of the upliance and have understood the resulting dangers.

- e. This device may only be used for its intended purpose. No other use is permitted. To the extent permitted by law: the manufacturer bears no responsibility for personal injury or damages resulting from improper use or misuse; if the device is subject to technical modifications, any warranty and liability for material defects caused or contributed to by any modification may be rendered invalid; the manufacturer's obligation to compensate on the basis of product liability and/or the dealer's obligation to compensate for material defects may no longer apply if technical modifications are made to the product, which cause or contribute to the defect. Nothing in the above effects, or is intended to affect, any rights you have under The Consumer Protection Act, 2019 or otherwise that cannot be excluded or modified.
- f. When working with the device, please follow the instructions in all the accompanying documentation as well as on the display. The manufacturer accepts no liability for damages resulting from improper use.
- g. The device complies with Indian safety regulations. If the device is used in another country, compliance with the local safety standards cannot be guaranteed. Up  or upliance.ai therefore assumes no liability for any resulting safety risks for the user.

3. Safety comes in many flavours

Safety is an essential part of every Up  or upliance.ai product.

In order to use the upliance safely follow the safety instructions and warning notices in this manual.

Do not use the upliance with damaged parts or accessories.

The upliance can only be repaired by an authorised service provider.

3.1 Obligations of the user

To ensure that your upliance operates correctly, please follow the guidelines below:

- a. Before using the upliance for the first time, read the owner's manual and all accompanying documents carefully.
- b. Store the manual in a safe place near the upliance for future reference and consult it regularly.

- c. Regularly consult the digital owner's manual for updates. You will find the latest version of the manual on upliance.ai website.
- d. Ensure that any damage to the upliance is repaired by an authorised service facility without delay.

4. What's in the box

Check your delivery box for all the components listed below before you begin to cook. If anything looks damaged or missing, please contact us within 24 hours of receiving your upliance.

Before using your upliance for the first time, get to know your new upliance.

Read the owner's manual thoroughly, sign up for a demo and/or watch one of our "getting started" videos.

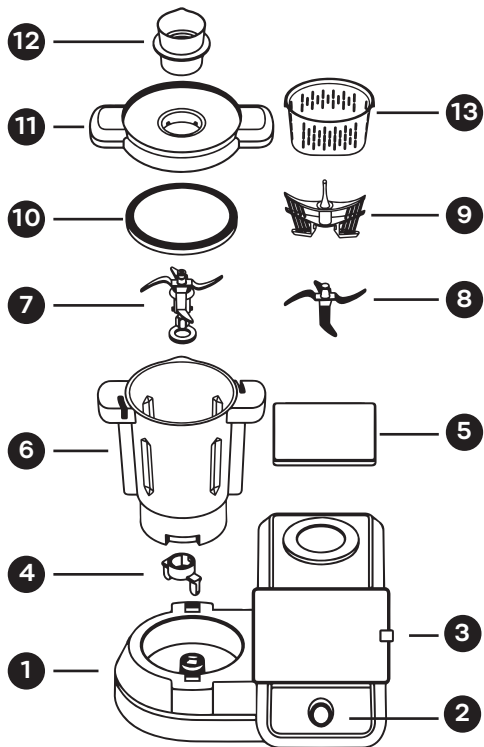

1. upliance main body
 2. Knob 14. Spatula
 3. Touchscreen 15. Measuring spoons x2
 4. Blade Lock
 5. Weighing Scale Slab
 6. Jar
 7. Blade with sealing ring
 8. Blade Cover
 9. Butterfly Whisk
 10. Gasket
 11. Jar Lid
 12. Crown
 13. Steamer Basket with handle



14



15

5. Location, Location, Location

Find your upliance a permanent spot in your kitchen so that you can operate it easily. Select a spot that has a strong Wifi connection.

When deciding where to put your upliance, please pay attention to the following:

- a. Be sure to place your upliance on a clean, solid and even surface so that it cannot slip.
- b. Ensure that there is a strong Wifi network or connection available at all times at the spot.
- c. Ensure that the ventilation opening on the back of the device is kept clean (free of grease splashes, etc.).
- d. Remove the protective guard from the touchscreen and the weighing scale.
- e. Gently pull the power cable out of the upliance housing and connect the upliance to the main power supply (220–240V).
- f. You can choose whatever length of power cable you need, up to 1.2m. If you do not need the whole length of the power cable the remaining length can be rolled up.
- g. Ensure that the cable is not near or exposed to any hot surface, including the Jar.

- b. Do not place the main body on the power cable. If you do, it will not sit evenly.

! Avoid direct heat on the main body

If the main body is placed on a hot surface, it may start to burn which could lead to a risk of injury and damage to property.

- Do not put the main body on a stove (gas stove, hob, ceramic hob, induction plate or similar) or on any other heated or heatable surface.
- Keep the upliance at a sufficient distance from hot surfaces and external heat sources.
- Ensure that the power cable does not touch hot surfaces or external heat sources.

! Fire hazard

The main body has a high power consumption. An insufficient power rating could cause a fire which could lead to a risk of injury and damage to property.

- When connecting the main body, please observe the maximum power consumption as 1100W (see also the section on Technical Data).
- Never use multi-socket boards, extension boxes, power strips or other equipment between the socket and the main body.

! Placement & Ideal locations

The process of kneading dough or chopping food may cause the appliance to move. The appliance could fall or tip and injure you.

- Place the main body on a clean, solid and even surface.
- Ensure that there is sufficient distance between the appliance and the edge of the counter or surface.
- Ensure there is a couple of inches of space from the appliance in the rear.

! Steam damage

If you place the device directly under furniture and fittings (shelving units, wall units or similar), they could sustain damage by any steam that is released. Ensure that there is sufficient clearance above and around the device.

6. Switching on for the first time

On delivery, the device can be powered on by plugging it into a 5A socket. (Check section 5 for finding the right spot in your kitchen)

Once powered on, tap on the touchscreen to open the Up  app.

7. Cleaning for the first time

! Wash it before you use it

Production residues may be present on the components of the device and are not suitable for consumption. Any production residues can pose a risk to your health.

Before first use, thoroughly wash the Jar, Jar Lid, Blade and other accessories that could come into contact with food.

When cleaning the appliance for the first time, proceed as follows:

- a. Disassemble the Jar & Blade
 - Remove the Jar from the main body.
 - Twist the Blade Lock in the base of the Jar anticlockwise
 - Remove the Blade Lock and place the Jar on a flat surface. The Blade will remain in the Jar.
 - Remove the Blade carefully, by holding the join/upper part. Avoid grabbing the sharp edges.
- b. Then wash all parts and accessories by hand or in the dishwasher (except for the main body and Jar).

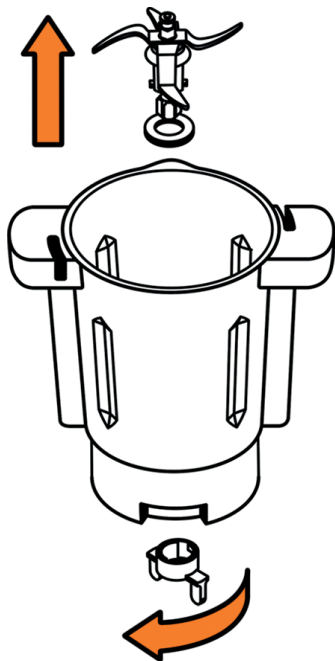

! Sharp Blade

The edges of the Blade are sharp and can injure you.

- Handle the Blade with care. Especially during washing & cleaning
- Only hold the upper or lower part of the Blade. Never hold the Blade by the edges.
- Use care when removing the Blade to prevent it from falling out.
- Do not reach into the Jar when it is hot.
- Keep parts of the body and hair away from the edges of the Blade.

8. Familiarising yourself with the accessories

Risk to health and risk of property damage from incorrect use of accessories!

All Up  accessories are specifically designed for use on or with the device and could get damaged if not used properly.

- Do not use the accessories for other purposes, particularly at high temperatures.
- Do not use the spatula in hot pots and pans.
- Never use the butterfly whisk for more than two hours (when cooking food over a long period of time, e.g. slow cooking, sous-vide, fermenting) to rule out any possible adverse effects on health.
- Should an accessory get damaged, stop using it and replace it immediately.

! Sharp Blade

Food is processed and heated in the stainless steel Jar. The Jar consists of a stainless steel container, a Lid, a Gasket, a Blade and a Blade Lock.

Fill Level Markings.

The stainless steel container has fill level marking in 0.5 litres increments. The maximum fill quantity is 2 litres ("max" mark).

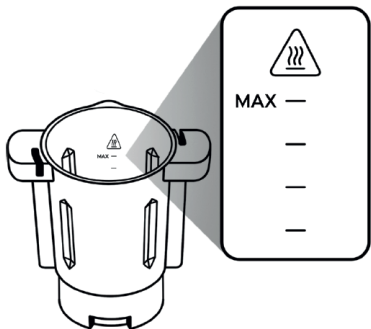

! Risk of scalding

If the hole in the Jar lid is completely sealed and heating is active, excess pressure can build up in the Jar. The hot contents may erupt from the device and scald you.

- Always place the original Jar lid with the gasket securely fit, on the Jar during cooking and chopping.
- Do not fill the Jar past the max. fill line
- To allow steam to escape and prevent excess pressure build up, ensure that the hole in the Jar lid is never blocked or covered - either from the inside (e.g by food) or from the outside (e.g. by a towel)
- Never use anything but the accompanying original accessories (Crown, Steamer Basket) to protect against splashes through the opening in the Jar Lid.
- If you notice during the cooking process that the hole in the Jar lid is blocked, unplug the main body. Do not touch the controls.

Ingredients that float to the top of the Jar during cooking can prevent steam from escaping, which can cause an increase of pressure in the Jar. The hot contents could suddenly erupt and scald you.

- Do not under any circumstances fill the Jar past the max. fill line (2 litres).
- Always follow the instructions on the device for when to keep the Crown on or off.

- Do not handle the Crown during high temperature cooking operations or remove it, unless clearly stated in the instructions.
- Ensure that the hole in the Jar lid remains free of food.
- Put the Crown onto the Jar lid to prevent splatter when mixing, chopping or puréeing hot food.
- Take extra care when adding hot liquids to the Jar.
- Remove the Jar carefully from the main body to help prevent contents from spilling or splashing.
- Do not handle the Crown when cooking at high temperatures, as it might be hot and scald you.
- Do not lean over or place any body parts over the hole in the Jar lid.

When preparing larger quantities of food at high temperatures (> 90°C), food can boil over, escape from the Jar and scald you.

- Always take extra care when cooking at high temperatures.
- If boiling over occurs turn off the upliance immediately.

8.2 Jar Lid

The Jar Lid is used to close the Jar. The device will not operate unless the lid has been positioned and locked correctly.

To lock the Jar, ensure that the Lid gasket is placed firmly in the Lid. Place the Lid on the Jar, with the arms aligned to the grooves in the Jar.

Twist the Lid into the Jar by holding the grips. You will get an alert on the touchscreen to confirm that the Lid is detected.

! Jar Lid

If the Jar lid is not correctly positioned on the Jar, hot contents can escape and scald you.

- Never try to open the Jar lid between cooking operations
- Only open the Jar lid when the cooking operations are completed - blade speed at 0, timer at 0 and no heating.
- Inspect the gasket regularly for possible damage. In case of damage or leakage, replace it immediately.
- Only use the upliance with a clean Jar lid. The rim of the Jar and the gasket must always be kept free of food residues to ensure that the lid is properly sealed.

8.3.1 How to remove the blade

If you want to clean the Blade and Jar thoroughly, you must remove the Blade.

- a. Remove the Jar from the main body.
- b. Twist the Blade Lock in the base of the Jar, anticlockwise.
- c. Remove the Blade Lock and place the Jar on a flat surface. The Blade will remain in the Jar.
- d. Remove the Blade carefully, by holding the joint/upperpart. Avoid grabbing the sharp edges.

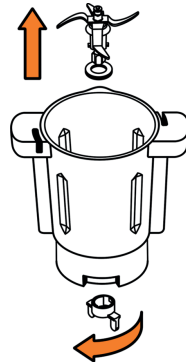
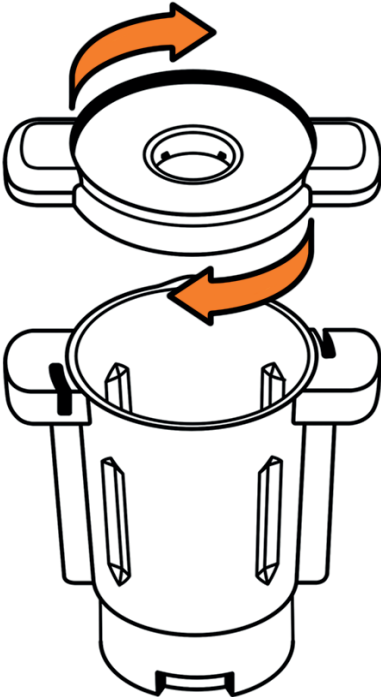

8.3.2 How to insert the Blade

- a. Hold the Jar so that the opening points upwards.
 - b. Carefully hold the upper part/joint of the Blade together with the sealing ring.
 - c. Align the grooves on the Blade to match the base of the Jar.
 - d. Insert the Blade, till it goes through and sits snugly in the base of the Jar.
 - e. Place the Blade Lock in its slot and align it to the base of the Blade.
 - f. Twist it clockwise, till it locks the Blade firmly in place.
 - g. Check if the Blade and Lock are firmly in place before placing the Jar in the main unit.
- Ensure that the Blade is correctly inserted and locked.
 - Put the blade lock in place before filling the Jar.
 - If liquid leaks or spills into the housing of the main body, unplug the device and contact Up 

! Incorrect assembly of the Blade

If the Blade is not correctly inserted and locked into place or the sealing ring is damaged or the blade lock is not used, moisture can get inside the device and damage the main body.

- Ensure that the sealing ring of the Blade is fitted to the base.
- Ensure that the sealing ring on the Blade shows no signs of damage.

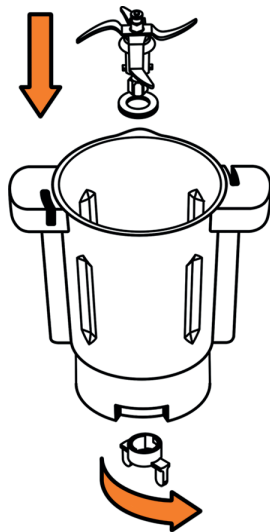

8.4 Crown

You can use the Crown to measure liquids. It has a capacity of 100ml.

It must be used to seal the opening in the Jar Lid during puréeing or chopping to prevent blended or cooked food from splashing. Follow the instructions on the screen to check when to use the Crown during cooking operations.

To add ingredients to the Jar during cooking operations, you can remove the Crown and use the hole in the Jar Lid to do so.

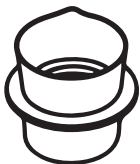

8.5 Spatula

You can use the Spatula to scrape down food in the Jar, as instructed during a guided recipe. You can also use it to empty the Jar. Do not insert the Spatula when in operation.

! Spatula

If you use other utensils apart from the spatula supplied to stir food in the Jar, they could get caught in the blade and cause injury.

- Only use the original Up  or upliance.ai spatula for stirring.
- Place only the flat end in the Jar.
- Do not use the spatula during any chopping or cutting functions.
- The soft side of the spatula, in particular, can get damaged by the Blade.
- Take care when using the spatula to press down food in the Jar or to scrape out the Jar.
- Avoid allowing the spatula to come into contact with the sharp edges of the Blade.



9. Cooking Operations

Regularly consult the digital instruction manual for updates. You will find the latest version of the manual on your device and on our website - www.upliance.ai.

9.1 Switching the main body on and off

To Switch on and off the device, you can either

- Unplug it from the socket to switch off the main body.
- Or, use the On/Off switch on the side of the main body. I is On - 0 is Off

9.2 Start Screen

The start screen will direct you to connect the upliance to your Home Wifi. Follow the steps onscreen to personalise your upliance and get cooking.

9.3 Weighing Scale

Touch the Scales icon on the Home Screen or next to any ingredients. When the weighing scale mode opens

- a. Tap on 'Bring to Zero' to get started
- b. If weighing liquids, place a bowl on the weighing Scale Slab and the tap 'Bring to Zero'
- c. Weigh your ingredients (5.0 kg maximum).

Repeat these steps for all your ingredients. You can find a drop down menu on the top left of the screen for ingredients used in the active recipe.

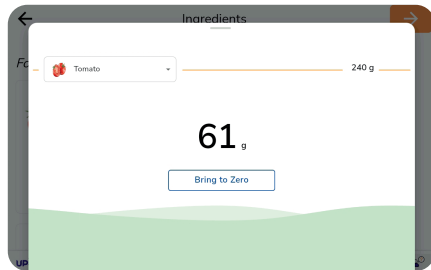

9.4 Knob

The Knob on the device today is used as a “Status” reader of the device.

Green - Powered on and ready to cook

Slow Blinking (Breathing) Orange - Cooking in progress

Orange - Cooking is paused, waiting to be resumed

Red - Over-the-air upgrade in progress

Slow Blinking (Breathing) Red - Device disconnected

In the coming weeks, we will update this section with new functions of the Knob. Including as an auto selector, how to use it on Manual Mode, etc. Keep an eye on the latest version of the Owner’s Manual on : www.upliance.ai/ownersmanual.

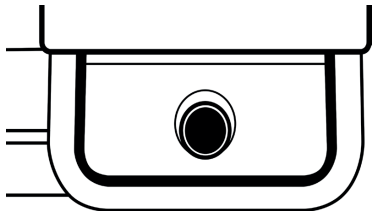

10. Cleaning and maintenance

10.1 Cleaning

All components can be cleaned manually. The Jar, main body and touchscreen are not dishwasher-safe.

Remove the Jar, Lid and Blade and wash it under running water and clean with your dishwashing liquid.

Thoroughly clean all parts of the appliance after every use.

10.2 Rinse

The Pre-Cleaning/Self Clean function is designed to dislodge any browning at the base of the Jar and get rid of grease. This function warms up water and dishwashing liquid and rinses the walls of the Jar. You must rinse the Jar thoroughly after using dishwashing liquid, like any other utensil.

10.3 Thorough Cleaning

If you want to clean the Blade and Jar thoroughly, you must disassemble the Blade.

- a. Remove the Blade
- b. Clean the inside and outside of each part, either by hand or in the dishwasher.

- c. Wipe the contact pins on the bottom of the Jar if necessary. Always ensure that the contact pins are clean and dry before putting the Jar back in the base unit.
- d. Use only soft dishcloths to clean plastic surfaces such as the Steamer Basket and the Butterfly Whisk.
- e. Do not use sharp objects or metal scouring pads.
- f. To remove particularly stubborn residues in the Jar, you can use scouring pads designed for stainless steel.

10.4 Cleaning the Base Unit

Disconnect the device from the main power supply before cleaning the main unit.

- a. Clean the main unit with a damp cloth and a gentle cleaning agent.
- b. Use water sparingly to prevent moisture from entering the base unit.

10.5 Regular Maintenance

Regular maintenance will extend the life of your device.

- a. Inspect your device and its accessories (including power cable, Jar and gasket) for possible damage.
- b. Do not use damaged accessories.

- c. To prevent any damage to your device, regularly check that the air intakes at the back are not obstructed.

! Water & electricity do not mix.

Risks of electric shocks

- If water gets into the electrical components, you could get an electric shock.
- If water enters the main unit/body of the device, you could get an electric shock.
- No water or dirt should enter the main body.
- Disconnect the device from the main power supply whenever it's not in use.
- Do not immerse the main body in water or other liquids.
- Do not hold the main body under running water.
- Do not pour/splash water over the main body.
- Disconnect the device from the mains power supply before cleaning the main body.
- Clean the main body with a dry or moist cloth only.
- Do not use the appliance outdoors or in a location where it may become wet.
- If water has managed to get into the device, contact Up  or upliance.ai for repair and service.

! Cleaning is an art

If the Jar and Blade are in contact with water, other liquids or food residues for a long time, they may be damaged.

- Clean the components shortly after use.
- Do not leave the Jar & the Blade in water for a long time as this may damage the base of the Jar.
- Do not soak the Jar in water.

Because of variations in water quality, it is possible for rust to form in the Jar when cooking food over a long period of time (slow cooking, sous-vide or fermenting). Please therefore follow the instructions on adding special ingredients (e.g. citric acid) to the cooking water.

! Corrosion inside the main body

Ensure that the Jar and especially the contact pins at the base of the Jar are thoroughly dry after cleaning. If you use the Jar when the Jar or contact pins are still wet, rust could form inside the main body.

Allow the Jar to dry fully before inserting it into the main body.

11. Power outage

If a power outage occurs while you're cooking

- The device will pause and halt the current Step's progress.
- You could either wait for the power to come back and resume the cooking or end the recipe by pressing stop..

Although the touchscreen will still continue to stay on, you can continue your cooking using your stove. Follow the guided recipes to still get great food.

12. Hazards and safety instructions

A summary of the many ways you could hurt yourself and your things, if you do not take care of your device and yourself while you cook. Here is a summary of all the things you could possibly screw up if you aren't paying attention while cooking.

! Water and electricity do not mix.



Risks of electric shocks

- If water gets into the electrical components, you could get an electric shock.
- If water enters the main unit/body of the device, you could get an electric shock.

- No water or dirt should enter the main body.
- Disconnect the device from the main power supply whenever it's not in use.
- Do not immerse the main body in water or other liquids.
- Do not hold the main body under running water.
- Do not pour/splash water over the main body.
- Disconnect the device from the mains power supply before cleaning the main body.
- Clean the main body with a dry or moist cloth only.
- Do not use the appliance outdoors or in a location where it may become wet.
- If water has managed to get into the device, contact Up  or upliance.ai for repair and service.

Only connect the main body to a 5A power socket installed by an electrician. Ensure that the 5A power socket is in working condition and the Earthing has been tested and signed off by an electrician.

- If the main body or cable are damaged, you could get an electric shock.
- Regularly inspect the main body, power cable and accessories for possible damage.

- Ensure that the power cable does not touch hot surfaces or external heat sources.
- Never use the main body if the power cable is damaged.
- Do not use the main body, if the appliance is dropped or damaged in any way.
- In the event of damage to the main body or the power cable, return the main body to Up  or Up  approved third party technician for examination, repair or electrical or mechanical adjustment.
- If the power cable on the main body has been damaged, it must be replaced by the manufacturer or customer service department or by an approved third party technician to avoid hazards.
- Inadequate power supply may damage the device. Only operate the device with the alternating current voltage and mains frequency as stated in the Technical Details.

Never attempt to repair the main body yourself. The main body must only be repaired by an authorised service facility.

Never put your fingers into the openings that are intended for the contact pins on the base of the Jar and do not insert any objects into these openings. Never put your fingers or any objects in the vents in the rear of the device.

! Avoid direct heat on the main body

If the main body is placed on a hot surface, it may start to burn which could lead to a risk of injury and damage to property.

- Do not put the main body on a stove (gas stove, hob, ceramic hob, induction plate or similar) or on any other heated or heatable surface.
- Keep the device a sufficient distance from hot surfaces and external heat sources.
- Ensure that the power cable does not touch hot surfaces or external heat sources.

! Fire hazard

The main body has a high power consumption. An insufficient power rating could cause a fire which could lead to a risk of injury and damage to property.

- When connecting the main body, please observe the maximum power consumption as 1100W (see also the section on Technical Data).
- Never use multi-socket boards, extension boxes, power strips or other equipment between the socket and the main body.

! Placement & Ideal locations

The process of kneading dough or chopping food may cause the appliance to move. The appliance could fall or tip and injure you.

- Place the main body on a clean, solid and even surface.
- Ensure that there is sufficient distance between the device and the edge of the counter or surface.
- Ensure there is a couple of inches of space from the appliance in the rear.

! Hot Surfaces

When preparing hot food, the Jar and the accessories that are used will become hot. You could burn yourself on hot surfaces, even after the heating process is completed.

- Handle the Jar, Blade and accessories with care, particularly during and after the preparation of hot food.
- Only use the designated handles and grips when touching all components.
- Allow the Jar and the Blade to cool sufficiently before dismantling the Jar and removing the Blade.

! Steam Damage

If you place the device directly under furniture and fittings (shelving units, wall units or similar), they could become damaged by any steam that is released. Ensure that there is sufficient clearance above and around the device.

! Wash it before you use it

Production residues may be present on the components of the device and are not suitable for consumption. Any production residues can pose a risk to your health.

Before first use, thoroughly wash all components and accessories that could come into contact with food.

! Taking care of the touchscreen

The touchscreen should be handled with care. Avoid spilling any water, oil, or hot liquids on it. The power cable for the touchscreen comes with a cable protector, ensure you use it to protect the device.

- Avoid spilling any liquids on or near the touchscreen.
- Avoid exposing it to hot surfaces, direct flames or sharp objects.

- The touchscreen should only be cleaned using a glass cleaner and a dry cloth.
- Do not try to forcefully remove the touchscreen from the main body.
- Keep the touchscreen plugged in using the charging wire provided and ensure the cable protector is clipped on.
- If the touchscreen detaches or breaks or it stops functioning reach out to Up  for service

! Sharp Blade

The edges of the Blade are sharp and can injure you.

- Handle the Blade with care. Especially during washing & cleaning
- Only hold the upper or lower part of the Blade. Never hold the Blade by the edges.
- Use care when removing the Blade to prevent it from falling out.
- Do not reach into the Jar when it is hot.
- Keep parts of the body and hair away from the edges of the Blade.

! Incorrect assembly of the Blade

If the Blade is not correctly inserted and locked into place or the sealing ring is damaged or the blade lock is not used, moisture can get inside the device and damage the main body.

- Ensure that the sealing ring of the Blade is fitted to the knife bearing.
- Ensure that the sealing ring on the Blade shows no signs of damage.
- Ensure that the Blade is correctly inserted and locked.
- Use the blade lock place before filling the Jar.
- If liquid leaks or spills into the housing of the main body, unplug the device and contact Up 

! Cleaning is an art

If the Jar and Blade are in contact with water, other liquids or food residues for a long time, they may be damaged.

- Clean the components shortly after use.

- Do not leave the Jar & the Blade in water for a long time as this may damage the base of the Jar.
- Do not soak the Jar in water.

Because of variations in water quality, it is possible for rust to form in the Jar when cooking food over a long period of time (slow cooking, sous-vide or fermenting). Please therefore follow the instructions on adding special ingredients (e.g. citric acid) to the cooking water.

! Corrosion inside the main body

Ensure that the Jar and especially the contact pins at the base of the Jar are thoroughly dry after cleaning. If you use the Jar when the Jar or contact pins are still wet, rust could form inside the main body.

Allow the Jar to dry fully before inserting it into the main body.

! Risk of scalding

If the hole in the Jar lid is completely sealed and heating is active, excess pressure can build up in the Jar. The hot contents may erupt from the device and scald you.

- Always place the original Jar lid with the gasket securely fit, on the Jar during cooking and chopping.
- Do not fill the Jar past the max. fill line.
- To allow steam to escape and prevent excess pressure, ensure that the hole in the Jar lid is never blocked or covered – either from the inside (e.g. by food) or from the outside (e.g. by a towel).
- Never use anything but the accompanying original accessories (Crown, Steamer Basket) to protect against splashes through the opening in the Jar lid.
- If you notice during the cooking process that the hole in the Jar lid is blocked, unplug the main body. Do not touch the controls.

Ingredients that float to the top of the Jar during cooking can prevent steam from escaping, which can cause an increase of pressure in the Jar. The hot contents could suddenly erupt and scald you.

- Do not under any circumstances fill the Jar past the max. fill line (2 litres).
- Always follow the instructions on the device for when to keep the Crown on or off.
- Do not handle the Crown during high temperature cooking operations or remove it, unless clearly stated in the instructions.
- Ensure that the hole in the Jar lid remains free of food.
- Put the Crown onto the Jar lid to prevent splatter when mixing, chopping or puréeing hot food.
- Take extra care when adding hot liquids to the Jar.
- Remove the Jar carefully from the main body to help prevent contents from spilling or splashing.
- Do not handle the Crown when cooking at high temperatures, as it might be hot and scald you.
- Do not lean over or place any body parts over the hole in the Jar lid.

When preparing larger quantities of food at high temperatures (> 90°C), food can boil over, escape from the Jar and scald you.

- Always take extra care when cooking at high temperatures.
- If boiling over occurs, use the emergency switch to turn off the main body.

If you use too high a speed in combination with high temperatures, there is a risk of hot food escaping and scalding you.

- Do not use Speed 10 and above for hot food or liquid over 60°C.
- Do not abruptly increase the blade speed when processing hot food. Increase the speed gradually.

Steam is generated during cooking which can scald you.

- Keep away from the steam.
- Do not touch the Crown when processing hot food, never cover the Crown. Ensure that steam can escape on the sides of the Crown.
- When you lift the Jar lid and set it aside, hot steam will continue to rise up through the Jar.
- When removing the Jar lid, tilt the lid away from your face and body to avoid escaping steam.
- The sauté function heats oil and fat. Water and oil mixtures may spit which may burn you.
- Never pour hot oil or fat into the Jar.
- Always follow the instructions on the display.
- Always place the Crown correctly onto the Jar lid as soon as your upliance instructs you to do so.

- Never try to open the Jar lid between cooking operations
- Only open the Jar lid when the cooking operations are completed - blade speed at 0, timer at 0 and no heating.
- Inspect the gasket regularly for possible damage. In case of damage or leakage, replace the lid immediately.
- Only use the upliance with a clean Jar lid. The rim of the Jar and the gasket must always be kept free of food residues to ensure that the lid is properly sealed.

If you use other utensils apart from the spatula supplied to stir food in the Jar, they could get caught in the blade and cause injury.

- Only use the original Up  or upliance.ai spatula for stirring.
- Do not use the spatula during any chopping or cutting functions.
- The soft side of the spatula, in particular, can get damaged by the Blade.
- Take care when using the spatula to press down food in the Jar or to scrape out the Jar.
- Avoid allowing the spatula to come into contact with the sharp edges of the Blade.
- Be cautious when removing the Steamer Basket and avoid any splash.
- Use a glove or thick fabric to grab the Steamer Basket handle and do not touch it directly.

13. Specs & Features for days

Physical Specification

Physical Specification	45.5x33x52 cm
Product Weight	6.9kg
Jar Crownacity	3 litres
Colour	Minimalist White

Touch Screen

Display	20.32cm (8") Touchscreen, 1280 x 800
IP Rating	IP54
Operating System	Android

Main Unit: Power Rating and Consumption

Rated Voltage	220-240V, 50-60Hz
Power Rating	1100W (Peak)
Motor	500W Universal motor, 5200 RPM
Coil	1000W Coil

Connectivity

802.11a/b/n/ac Wi-Fi
upliance.ai mobile app
Single control access knob
In-built guided cooking
Automatic heat cut off at high temperatures

Safety

Double Sided Insulated Grip
Safety Lid Lock
Safety Power Cut off switch
Safe base water cleaning
Leakage/Spillage prevention
Stable Base Suction

14. Warranty

For any warranty terms and conditions please refer to the Warranty section on www.upliance.ai. Any warranty is in addition to your rights under the Indian Consumer Protection Law.

15. Customer Service

Manufactured by React Labs Pvt. Ltd in India

Mailing Address:

268, 13th Main, 21st Cross Road, Sector 7
HSR Layout, Bengaluru 560102

Whatsapp or Call on +91 89049 62940

Email: hi@upliance.ai

This instruction manual is available in detail along with Product Terms & Conditions, EULA and Warranty on <https://www.upliance.ai/ownersmanual>

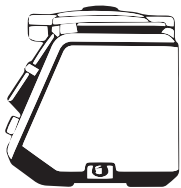

Designed in Bengaluru
Built in India
Leveling Up  Lives
Everywhere

Scan here for Updated Version

