

**DENSO**  
DENSO WAVE

MOBILE COMPUTER  
**BHT-M80**  
SERIES

*Driven by quality.*

Scanning-Excellence  
at its Core



# Sets the bar in terms of reading performance:

## The BHT-M80 Mobile Computer.

**The BHT-M80 Android device is the result of continuous perfectionism!**

Being fueled by the most powerful DENSO original scan engine to date, this mobile computer delivers a reading performance that will make you asking for nothing less ever again.

The installed Android™ 10 OS (with the option to upgrade to Android™ 11 at a later point) enables you to use the device intuitively without a long induction phase.

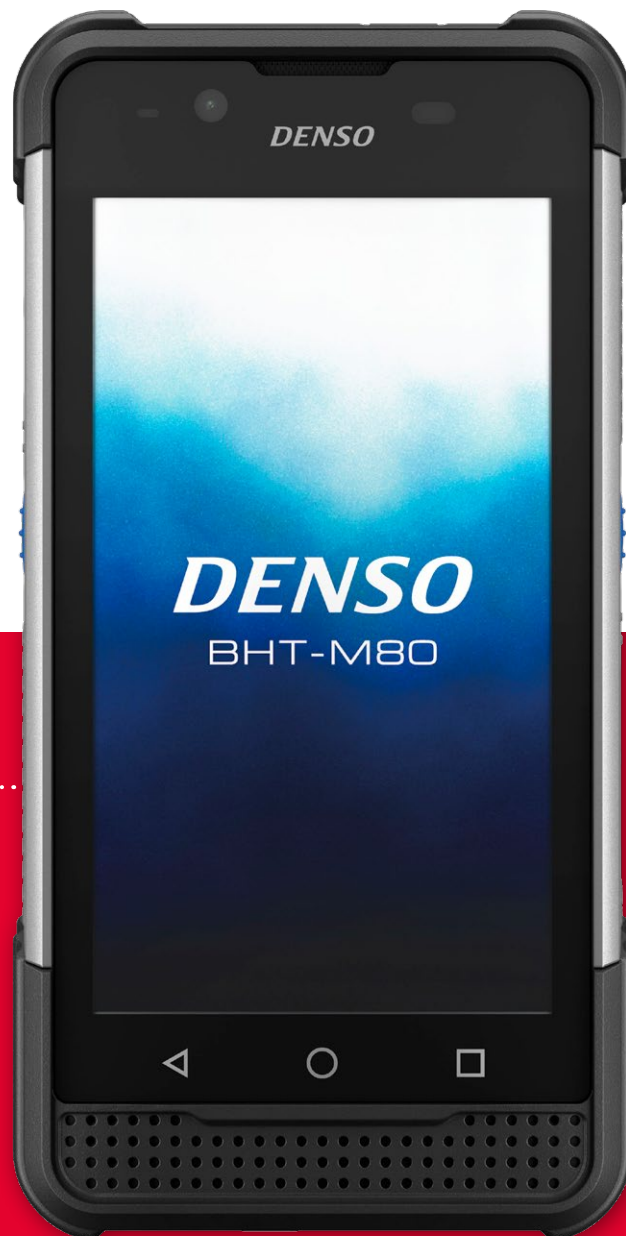

### EXCELLENT OVERVIEW:

With the 5.0" screen everything that matters is in sight.



### POWERFUL:

Octa-Core 2.2 GHz (Qualcomm SMD 660) for efficient processes without interruptions.

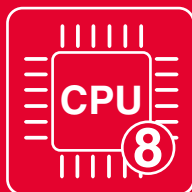

### TOUGH:

Display with crack-resistant Asahi Dragontrail™ Pro glass fitted as a standard - one of the best in the industry.



### ERGONOMIC:

Angled scan head for a natural hand posture, with the display always in view.



### UP-TO-DATE:

Running Android™ 10 with the option to upgrade to Android™ 11 at a later point.

# Focussing on the user's needs: The application areas.

**The BHT-M80 demonstrates its capabilities** especially where data has to be collected and processed in bulk. Its ergonomic concept, optimum view of the display and easy-to-use functions are perfect for speeding up reading processes.

**Its great robustness makes the BHT-M80 ideal for countless indoor and outdoor applications.**

These are just a few examples of its wide range of applications.

## ORGANIZE LOGISTICS

Scan and locate your deliveries in real time using wireless LAN\* – for tracking and tracing and improved route planning.

## OPTIMISE FIELD SERVICE

Record the process status and progress immediately on site and communicate with head office whenever you need to – via wireless LAN\*.

## PROFESSIONALISE RETAIL

Whether it's for warehousing, ordering or sales management, collect data with precision – even if codes are damaged.

# The result of continuous perfectionism: The technical highlights.

Wherever better performance is demanded, technology has to progress.

**The BHT-M80 makes advanced automatic ID technology the standard.**

## Reads even difficult labels

Thanks to a new decode engine and a high resolution sensor, the BHT-M80 is able to read even the most difficult labels.

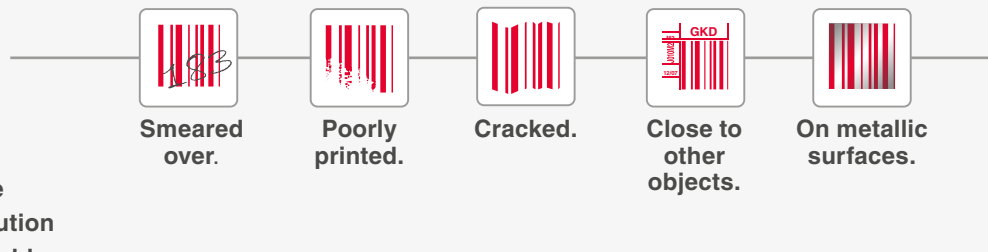

## Superior scanning range

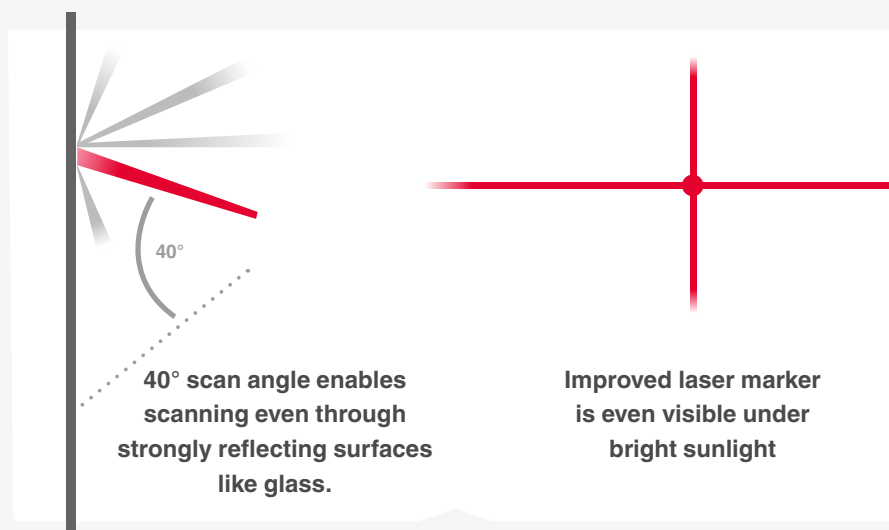
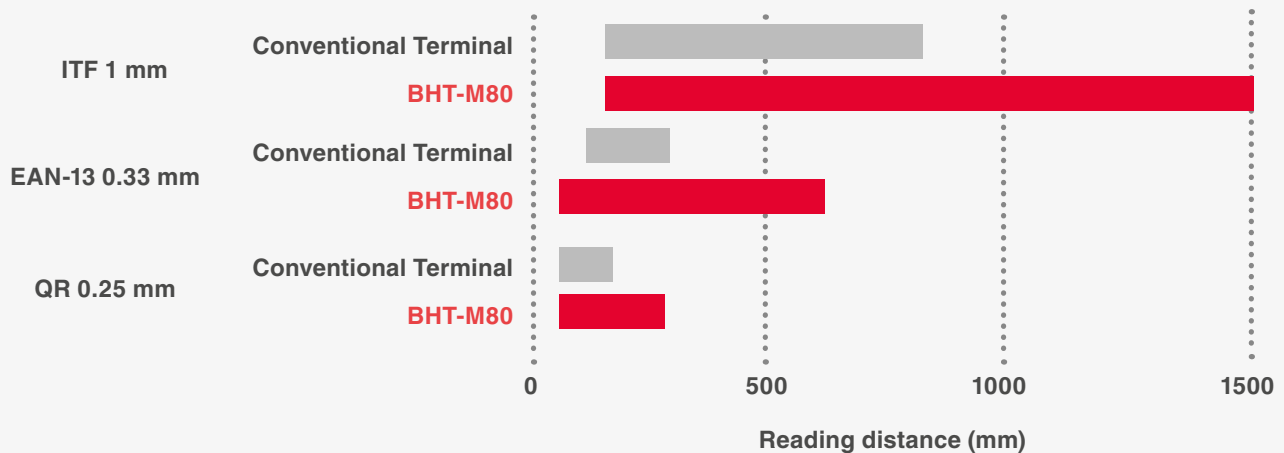

# Tested to the extreme. It wouldn't be DENSO otherwise.

Innovation simply for the sake of innovating is not what DENSO's about. The BHT-M80 has passed our rigorous quality tests for robustness and durability, **even in the harshest conditions.**



warranty



### Battery life

perfect for long working hours.



Works at extreme temperatures from **-20° to +50° Celsius.**

**3.0 metres**

### Survived umpteen fall tests

from heights of up to 3.0 m.



### IP67-certified

protection against water and dust.

## SCANS QUICKLY AND EFFORTLESSLY THANKS TO ADVANCED TECHNOLOGY FROM DENSO.

It is no secret anymore that mobile data capture devices are a much faster option for processes like goods receipts or stock takings than the pen and paper method. The BHT-M80 accelerates those processes even more: thanks to a new decode engine combined with a high performance CPU, which leads to three times faster scanings than with conventional readers.

Superior reading speed.  
Stress-less, continuous scanning.

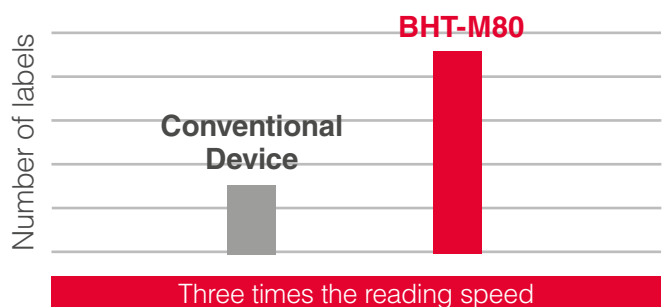

# SPECIFICATIONS

Model	BHT-M80-QWG	BHT-M80-QW	
OS	Android™ 10		
CPU	Qualcomm® SDM660 64 bit 2.20 GHz (Octa-Core)		
Memory	RAM	4 GB	
	Flash ROM	64 GB	
Display	Screen size & resolution	5 inch HD (720x1280)	
	Display device	Dot matrix liquid crystal display (colour) <sup>1</sup>	
	Backlight	White LED	
	Reading method	Area sensor	
Reader	Supported code	2D code	QR code®, Micro QR code, SQRC®, PDF417, Micro PDF417, Maxi code, Data Matrix (ECC200), and GS1 Composite
		Barcode	EAN-13/8 (JAN-13/8), UPC-A/E, UPC/EAN (with add-on), and Interleaved 2 of 5 (ITF), Codabar (NW-7), CODE39, CODE93, CODE128, GS1-128 (EAN-128), and Standard 2 of 5 (STF), GS1 DataBar (RSS)
		OCR	Supported <sup>2</sup>
	Minimum resolution	2D code	0.127 mm
		Barcode	0.076 mm
	Marker	Cross guide marker	
Reading confirmation	Blue LED, speaker, and vibration		
Keys	Number of keys		5 keys (including power key) + 2 trigger keys
Touch Panel	Asahi Dragontrail™ Pro <sup>3</sup> - wet touch / gloved fingertip / stylus		
Communication	Wireless LAN connection	Standard	Compliant with IEEE802.11a/b/g/n/ac and MU-MIMO 2x2
		Frequency	5 GHz-band (W52, W53, and W56, W58), 2.4 GHz-band (1 to 13 channels)
		Security	Encryption: OPEN, Enhanced Open, WEP(40/128), TKIP and AES WPA authentication: WPA and WPA2 and WPA3 User authentication: PSK, EAP-TLS, and PEAP
	WWAN	Supported: GSM/W-CDMA/LTE and VoLTE FDD-LTE (4G) - Bands 1, 2, 3, 4, 5, 7, 8, 12, 13, 17, 19, 20, 25, 26, 28 W-CDMA/UMTS/HSPA/HSPA+ (3G) - Bands 1, 2, 5, 6, 8, 19 GSM/GPRS/EDGE (2G) - Bands 850, 900, 1800, 1900MHz	
	GPS	A-GPS/GLONASS/QZSS/BeiDou/Galileo	
	Bluetooth®	Bluetooth® Ver5.1+EDR/LE Supported Profile: RFCOMM/A2DP/AVCTP/ACDTP/GVDP/AVRCP/DUN/DI/HFP/HID/HSP/IOP/MAP/OPP/BNEP/PAN/PBAP/SAP/SPP	
	USB	USB2.0 (Type-C)	
	NFC <sup>4</sup>	ISO/IEC14443A&B and FeliCa, ISO/IEC15693 (RFID)	
Camera	Front 5MP autofocus, Rear 13MP autofocus		
Card slot	microSD (SDHC and SDXC (up to 128 GB)) SDHC Speed class 4 supported		
	nanoSIMx2 DSDV (4Gx4G)		
Microphone receiver	Attached <sup>5</sup>		
Speaker	90dB or more at 10 cm distance (at 2.8kHz)		
Sensor	G-sensor, gyro sensor, proximity sensor, light intensity sensor, and geomagnetic sensor		
Power supply	Main battery	Lithium-ion battery: 4,020mAh / 5,800mAh	
	Wireless charging	Supported (excl. battery and charger)	
	Quick charging	Supported (Quick charge 3.0)	
	Operating time <sup>8</sup>	2,900 mAh battery: 14 h <sup>9</sup> / 4,020 mAh battery: 20 h <sup>9</sup> / 5,800 mAh battery: 29 h <sup>9</sup>	
Environmental requirements	Operating temperature <sup>6</sup>	-20°C to 50°C	
	Operating humidity	20 to 80%RH (non-condensing and non-icing)	
	Protection rating <sup>7</sup>	IP65 / IP67	
	Drop resistance <sup>7</sup>	60 or more drops from 1.5 m, 3.0 m	
Weight (incl. battery)	ca. 365g (incl. BT1) / ca. 395g (incl. BT1L)		

<sup>1</sup> The LCD display is manufactured with precise technology. The rate of non-defective pixels is 99.99% or more, which means that 0.01% or less pixels could be stuck or dead.

<sup>2</sup> License is required.

<sup>3</sup> Dragontrail® Pro is a registered trademark of AGC Inc.

<sup>4</sup> Before using the NFC function, perform test reading sufficiently using the target NFC card.

<sup>5</sup> A headset or headphone can be connected through the USB Type-C cable. A USB Type-C-to-audio jack (3.5 mm) conversion cable is optional.

<sup>6</sup> 0°C to 40°C during charging.

<sup>7</sup> These are the values tested at a room temperature, and not guaranteed values.

<sup>8</sup> The operating time is a reference value at a room temperature and may differ depending on the operating conditions.

<sup>9</sup> This is a result of measurement based on the JEITA HT Standard Operation Mode G, and may change depending on the operating environment and system settings.

## ACCESSORIES (sold separately)

### Communication / Charger

- USB type charger CU-M80U
- USB type charger CU-M80UQ (CQ3.0)
- Charger CU-M80L
- 4 slot unit charger CH-M80-4
- 4 slot battery charger CH-BT1-4
- AC adaptor
- AC adaptor (CQ3.0)

### Batteries

- BT1 (4020 mAh)
- BT1L (5800 mAh)
- BT1S-W Wireless (2900 mAh)

### Others

- Hand strap, waist case, stylus pen
- USB Type-C conversion cable (1.5m)

# SOFTWARE

- SDK
- Scan Settings
- BHT Browser
- BHT Link
- BHT Setting
- BHT DMS
- Battery Monitor
- WLAN Manager
- BHT Remote
- Application Launcher
- BHT Security Package

# DIMENSIONS

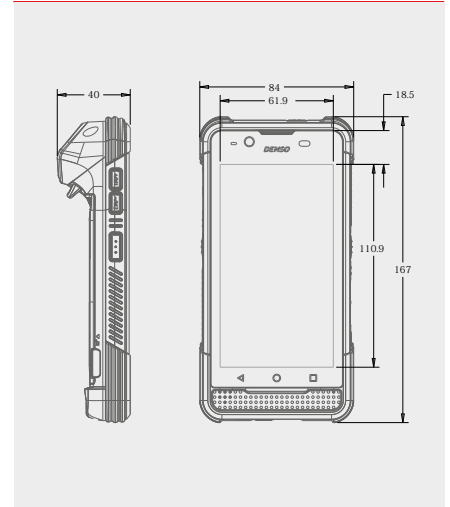

**DENSO**

DENSO WAVE EUROPE GmbH

Parsevalstr. 9 A

D-40468 Düsseldorf

+49 211 540 138 40

info@denso-wave.eu

For more information, please visit our website.

www.denso-wave.eu



TO USE THIS PRODUCT SAFELY

Before using this product, read its User's Manual thoroughly.

QR Code is a registered trademark of DENSO WAVE INCORPORATED.

Product appearance and specifications are subject to change without notice. | © 2020 DENSO WAVE EUROPE GmbH