



ML17XP1

Merit® Series

R-410A - 60 Hz

Bulletin No. 211007

October 2023

Supersedes January 2023

**RESIDENTIAL
PRODUCT SPECIFICATIONS**



**MERIT®
SERIES**



SEER2 up to 17.0 / SEER up to 18.6
HSPF2 up to 8.5 / HSPF up to 10.6
1.5 to 5 Tons
Cooling Capacity - 18,000 to 58,000 Btuh
Heating Capacity - 16,200 to 54,500 Btuh

MODEL NUMBER IDENTIFICATION

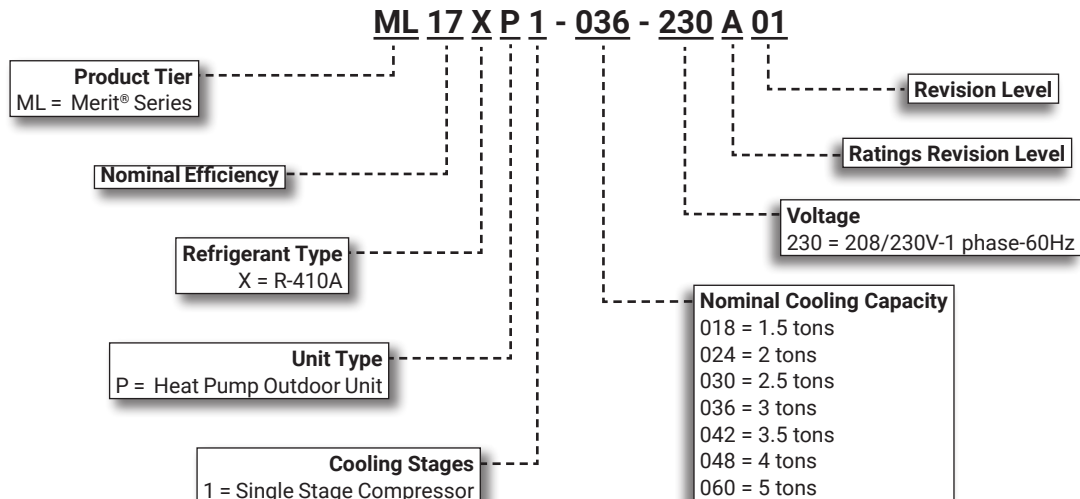

FEATURE HIGHLIGHTS

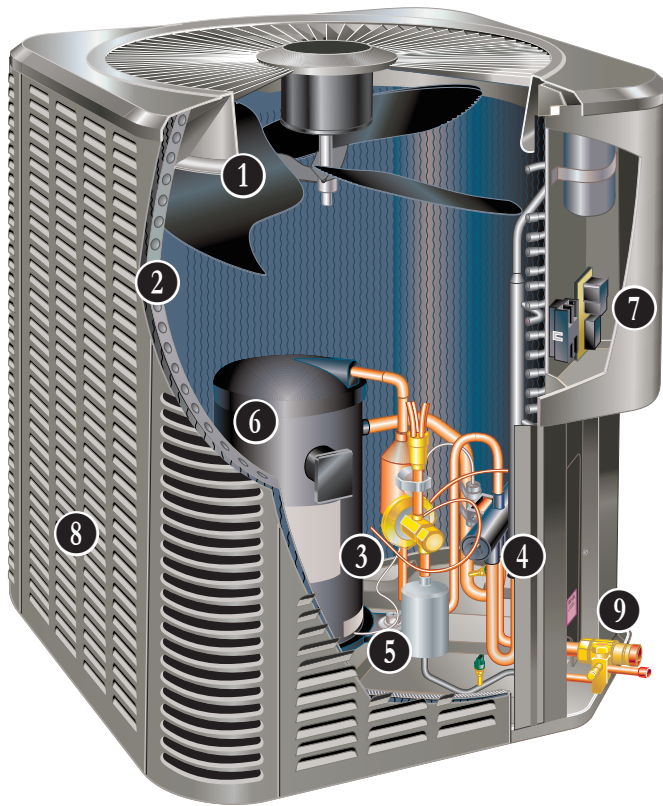

1. Outdoor Coil Fan
2. Quantum™ Coil
3. Expansion Valve - Outdoor Unit
4. Four-Way Reversing Valve
5. High Capacity Liquid Line Drier
6. Scroll Compressor
7. Defrost Control
8. Heavy Gauge Steel Cabinet
9. Refrigerant Line Connections

CONTENTS

Approvals And Warranty	3
Controls - Order Separately	7
Dimensions - Unit	10
Electrical Data	7
Features	3
Field Wiring	9
Installation Clearances	9
Model Number Identification.	1
Optional Accessories - Order Separately	7
Sound Data	9
Specifications	7
TXV Substitution	11
TXV Usage.	11

APPROVALS AND WARRANTY

APPROVALS

- AHRI Certified to AHRI Standard 210/240-2023
- For AHRI Certified system match-ups and expanded ratings, visit www.LennoxPros.com
- ENERGY STAR® certified
- Sound rated to AHRI Standard 270-2008 test conditions
- Tested in the Lennox Research Laboratory environmental test room
- Rated according to U.S. Department of Energy (DOE) test procedures
- Units and components UL, NEC, and CEC bonded for grounding to meet safety standards for servicing
- ETL certified (U.S. and Canada)
- ISO 9001 Registered Manufacturing Quality System

WARRANTY

- Compressor:
 - Limited five years in residential installations
 - Limited five years in non-residential installations
- All other covered components:
 - Limited five years in residential installations
 - Limited one year in non-residential installations

NOTE - Refer to Lennox® Basic Limited Warranty at www.Lennox.com for additional details.

FEATURES

APPLICATIONS

- 1.5 through 5 ton
- Sound levels as low as 74 dBA
- Single phase power supply
- Vertical air discharge
- Applicable to indoor air handlers or gas furnaces with indoor add-on coils
- Shipped completely factory assembled, piped, and wired
- Factory tested operated

NOTE - When heat pumps are used with gas furnaces, a dual-fuel compatible thermostat or a zone control system with dual-fuel capabilities must be used (order separately).

NOTE - Installer must set heat pump, connect refrigerant lines, and make electrical connections to complete job.

REFRIGERATION SYSTEM

R-410A Refrigerant

- Non-chlorine, ozone friendly
- Unit is factory pre-charged

NOTE - Total system refrigerant charge is dependent on outdoor unit size, indoor unit size and refrigerant line length.

NOTE - Refer to the unit-mounted charging sticker to determine correct amount of charge required.

1 Outdoor Coil Fan

- Direct drive fan
- Vertical air discharge
- Fan motor is inherently protected

- Totally enclosed motor
- PSC motor (018, 024, 030 and 036 models)
- ECM motor (042, 048 and 060 models)
- Louvered steel top fan guard

2 Quantum™ Coil

- Lennox designed and fabricated coil
- Enhanced aluminum alloy tube/enhanced fin coil
- Ripple-edged aluminum fins
- Aluminum tube construction
- Lanced fins for maximum fin surface exposure
- Fin collars grip tubing for maximum contact area
- Flared shoulder tubing connections
- Factory tested under high pressure
- Entire coil is accessible for cleaning

High Pressure Switch

- Protects the system from high pressure conditions that can be a result of fan failure or a blocked/dirty coil
- Automatic reset

Low Pressure Switch

- Shuts off unit if suction pressure falls below setting
- Provides loss of charge and freeze-up protection
- Automatic reset

3 Expansion Valve - Outdoor Unit

- Designed and sized for heat pump systems
- Sensing bulb senses evaporator suction temperature during heating cycle

FEATURES

REFRIGERATION SYSTEM (continued)

- 4 Four-Way Reversing Valve**
- Rapid changeover of refrigerant flow direction from cooling to heating and vice versa
 - Operates on pressure differential between outdoor unit and indoor unit of the system
 - Factory installed
- 5 High-Capacity Liquid Line Drier**
- Factory installed in the liquid line
 - Drier traps moisture or dirt
 - 100% molecular-sieve, bead type, bi-flow drier

Optional Accessories

Check/Expansion Valve Kits

- Field installed on certain indoor units
- See TXV Usage table
- Chatleff style fitting

Freezestat

- Installs on or near the vapor line of the indoor coil or on the suction line
- Senses suction line temperature
- Cycles compressor off when suction line temperature falls below its setpoint
- Opens at 29°F and closes at 58°F
- Installs on or near the discharge line of the evaporator or on the suction line

Refrigerant Line Kits

- Refrigerant lines are shipped refrigeration clean
- Lines are cleaned, dried, pressurized and sealed at factory
- Suction line fully insulated
- Lines are stubbed at both ends

COMPRESSOR

- 6 Scroll Compressor**
- High efficiency with uniform suction flow
 - Constant discharge flow, high volumetric efficiency and quiet operation
 - Low gas pulses during compression reduces operational sound levels
 - Compressor motor is internally protected from excessive current and temperature
 - Compressor is installed in the unit on resilient rubber mounts for vibration free operation

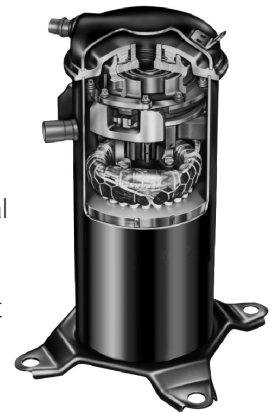

Scroll Compressor Operation

- Two involute spiral scrolls matched together generate a series of crescent-shaped gas pockets between them
- During compression, one scroll remains stationary while the other scroll orbits around it
- Gas is drawn into the outer pocket, the pocket is sealed as the scroll rotates
- As the spiral movement continues, gas pockets are pushed to the center of the scrolls. Volume between the pockets is simultaneously reduced
- When the pocket reaches the center, gas is now at high pressure and is forced out of a port located in the center of the fixed scrolls
- During compression, several pockets are compressed simultaneously resulting in a smooth continuous compression cycle
- Continuous flank contact, maintained by centrifugal force, minimizes gas leakage and maximizes efficiency
- Compressor is tolerant to the effects of slugging and contaminants. If this occurs, scrolls separate, allowing liquid or contaminants to be worked toward the center and discharged

Compressor Crankcase Heater (Factory Installed on 036, 042, 048, 060)

- Protects against refrigerant migration that can occur during low ambient operation

Optional Accessories

Crankcase Heater (Optional for 018, 024, 030 models)

- Protects against refrigerant migration that can occur during low ambient operation

Compressor Sound Cover

- Reinforced vinyl compressor cover
- 1-1/2 inch thick batt fiberglass insulation
- Hook and loop fastening tape on all open edges

FEATURES

CONTROLS

7 Defrost Control

- Control furnished as standard
- Gives a demand defrost cycle whenever system heating performance falls below optimum levels
- Sensing element on coil determines when defrost cycle is required and when to terminate cycle
- Anti-short cycle (5 minutes) incorporated into the board
- Diagnostic LEDs furnished as an aid in troubleshooting
- Conveniently located in control box

Optional Accessories

M30 Smart Wi-Fi Thermostat

- Wi-Fi-enabled, electronic 7-day, universal, multi-stage, programmable, touchscreen thermostat
- 4 Heat/2 Cool
- Auto-changeover
- Dual-fuel control with optional outdoor sensor
- Controls dehumidification during cooling mode and humidification during heating mode
- Offers enhanced capabilities including humidification / dehumidification / dewpoint measurement and control, Humiditrol® control, and equipment maintenance reminders
- Easy to read 4.3 in. color touchscreen (measured diagonally)
- LCD display with backlight shows the current and set temperature, time, inside relative humidity, system status (operating mode and schedules) and outside temperature (optional outdoor sensor required)
- Smooth Setback Recovery starts system early to achieve setpoint at start of program period
- Compressor short-cycle protection (5 minutes)
- Up to four separate schedules are available plus Schedule IQ™
- One-Touch Away Mode - A quick and easy way to set the cooling and heating setpoints while away
- Smart Away™ - Uses geo-fencing technology to determine when the homeowner is within a predetermined distance from the home to operate the system when leaving, away and arriving
- Wi-Fi remote monitoring and adjustment through a home wireless network for desktop PCs, laptops and apps for smartphones or tablets
- Smart home automation compatible with Amazon Alexa®, Google Assistant and IFTTT
- Service Dashboard features online real-time monitoring of installed Lennox® smart thermostats



NOTE - See the Lennox® M30 Smart Wi-Fi Thermostat Product Specifications bulletin for more information.

Remote Outdoor Temperature Sensor

- Used with the Lennox® M30 Smart Wi-Fi Thermostat
- Outdoor sensor allows thermostat to display outdoor temperature

NOTE - Sensor is required for the Enhanced Dehumidification Accessory (EDA) applications.

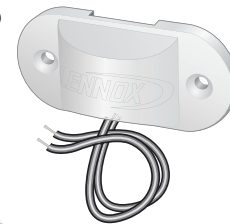

Thermostat

- Thermostat is not furnished with unit
- See Lennox Price Book for selection

Compressor Hard Start Kit

- Single-phase units are equipped with a PSC compressor motor
- This type of motor normally doesn't need a potential relay and start capacitor
- For conditions such as low voltage kit may be required to increase the compressor starting torque

Compressor Low Ambient Cut-Off Switch

- Non-adjustable switch (low ambient cut-out) prevents compressor operation when outdoor temperature is below 35°F
- Freezestat Installs on or near the vapor line of the indoor coil or on the suction line
- Senses suction line temperature and cycles the compressor off when suction line temperature falls below it's setpoint
- Opens at 29°F and closes at 58°F

Indoor Blower Off Delay Relay

- Delays the indoor blower-off time during the cooling cycle

Low Ambient Kit

- Air conditioners can operate down to 45°F outdoor air temperature without additional controls
- Allows unit to operate properly down to 30°F

NOTE - Crankcase heater and freezestat should be installed on compressors equipped with a low ambient kit.

NOTE - A Compressor Low Ambient Cut-Off should be added to terminate compressor operation below recommended operation conditions.

Mild Weather Kit

- Units can operate in the heating mode at outdoor air temperatures up to 75°F
- Field installed kit allows heating operation above 75°F

Monitor Kit - Service Light

- Ambient compensating thermistor
- Service light thermostat
- For thermostats requiring indicator light inputs
- For use with thermostats requiring input for indicator lights

FEATURES

CONTROLS (continued)

Optional Accessories (continued)

Outdoor Thermostat Kit

- An outdoor thermostat can be used to lock out some of the electric heating elements on indoor units where two-stage control is applicable
- Outdoor thermostat maintains the heating load on the low power input as long as possible before allowing the full power load to come on the line
- Thermostat kit and Mounting Box must be ordered separately

CABINET

- 8 • Heavy gauge steel construction
- Louvered heavy gauge steel panels surround unit on all four sides
- Five station metal wash process
- Powder paint finish
- Control box is conveniently located with all controls factory wired
- Corner patch plate allows access to compressor components
- Drainage holes are provided in base section for moisture removal

PermaGuard™ Unit Base

- Durable zinc-coated base section resists rust and corrosion

9 Refrigerant Line Connections, Electrical Inlets, Service Valves

- Sweat connection suction and liquid lines
- Located on corner of unit cabinet
- Suction valve can be fully shut off, while liquid valve may be front seated to manage refrigerant charge while servicing system
- Refrigerant line connections and field wiring inlets are located in one central area of the cabinet
- See dimension drawing

Optional Accessories

Unit Stand-Off Kit

- Black high density polyethylene feet
- Raises unit off of mounting surface
- Four feet are furnished per order number

SPECIFICATIONS

General Data		Model No.	ML17XP1-018	ML17XP1-024	ML17XP1-030	ML17XP1-036	
		Nominal Tonnage	1.5	2	2.5	3	
Connections (sweat)	Liquid line OD - in.		3/8	3/8	3/8	3/8	
	Vapor (Suction) line OD - in.		3/4	3/4	3/4	7/8	
¹ Refrigerant		R-410A charge furnished	5 lbs. 12 oz.	5 lbs. 10 oz.	6 lbs 15 oz.	8 lbs. 3 oz.	
Outdoor Coil	Net face area - sq. ft.		Outer coil	24.5	24.5	18.7	22.2
			Inner coil	- - -	- - -	18.0	21.5
			Tube diameter - in.	5/16	5/16	5/16	5/16
			No. of rows	1	1	2	2
			Fins per inch	22	22	22	22
Outdoor Fan	Diameter - in.		22	22	22	26	
	No. of blades		2	2	2	3	
	Motor hp		1/8	1/8	1/6	1/5	
	Cfm		2840	2840	2670	3590	
	Rpm		825	825	825	825	
	Watts		127	127	162	200	
	Shipping Data - lbs. 1 pkg.			185	185	185	220

ELECTRICAL DATA

Line voltage data - 60 Hz - 1 ph		208/230V-1ph	208/230V-1ph	208/230V-1ph	208/230V-1ph	
² Maximum overcurrent protection (MOCP) amps		20	25	25	30	
³ Minimum circuit ampacity (MCA)		13.6	15.1	15.6	17.8	
Compressor	Rated load amps		10.3	11.5	11.7	13.1
	Locked rotor amps		45.7	59.5	71.3	83.1
Outdoor Fan Motor	Full load amps		0.7	0.7	1.0	1.4

CONTROLS - ORDER SEPARATELY

M30 Smart Wi-Fi Thermostat	15Z69	•	•	•	•
Remote Outdoor Temperature Sensor	X2658	•	•	•	•

OPTIONAL ACCESSORIES - ORDER SEPARATELY

Compressor Crankcase Heater	93M04	•	•	•	
Compressor Hard Start Kit	LG 88M91			•	•
	Copeland 10J42	•	•		
Compressor Sound Cover	18J42	•	•	•	•
Compressor Low Ambient Cut-Off	45F08	•	•	•	•
Freezestat	3/8 in. tubing 93G35	•	•	•	•
	5/8 in. tubing 50A93	•	•	•	•
Indoor Blower Off Delay Relay	58M81	•	•	•	•
⁴ Low Ambient Kit	54M89	•	•	•	•
Mild Weather Kit	11B97	•	•	•	•
Monitor Kit - Service Light	76F53	•	•	•	•
Outdoor Thermostat Kit	Thermostat 10Z23	•	•	•	•
	Mounting Box 31461	•	•	•	•
Refrigerant Line Sets	3/8 x 3/4 x 3/8 - 20 ft. 89J56				
	3/8 x 3/4 x 3/8 - 30 ft. 89J57	•	•	•	
(Liq. x Suc. OD x Insulation Thickness - Length)	3/8 x 3/4 x 3/8 - 40 ft. 89J58				
	3/8 x 3/4 x 3/8 - 50 ft. 89J59				
	3/8 x 7/8 x 3/8 - 30 ft. 89J60				
	3/8 x 7/8 x 3/8 - 40 ft. 89J61				•
	3/8 x 7/8 x 3/8 - 50 ft. 89J62				
Unit Stand-Off Kit	94J45	•	•	•	•

NOTE - Extremes of operating range are plus 10% and minus 5% of line voltage.

¹ Refrigerant charge sufficient for 15 ft. length of refrigerant lines. For longer line set requirements see the Installation Instructions for information about line set length and additional refrigerant charge required.

² HACR type breaker or fuse.

³ Refer to National or Canadian Electrical Code manual to determine wire, fuse and disconnect size requirements.

⁴ Crankcase Heater and Freezestat are recommended with Low Ambient Kit.

SPECIFICATIONS

General Data		Model No.	ML17XP1-042	ML17XP1-048	ML17XP1-060
		Nominal Tonnage	3.5	4	5
Connections (sweat)	Liquid line OD - in.		3/8	3/8	3/8
	Vapor (Suction) line OD - in.		7/8	7/8	1-1/8
¹ Refrigerant		R-410A charge furnished	9 lbs. 12 oz.	8 lbs. 12 oz.	9 lbs. 14 oz.
Outdoor Coil	Net face area- sq. ft.		Outer coil 24.93	24.93	29.09
			Inner coil 24.13	24.13	28.16
	Tube diameter - in.		5/16	5/16	5/16
	No. of rows		2	2	2
	Fins per inch		22	22	22
	Diameter - in.		26	26	26
Outdoor Fan	No. of blades		3	3	3
	Motor hp		1/3	1/3	1/3
	Cfm		4110	4110	4060
	Rpm		825	825	825
	Watts		213	213	224
	Shipping Data - lbs. 1 pkg.			250	250

ELECTRICAL DATA

Line voltage data - 60 Hz - 1 ph		208/230V-1ph	208/230V-1ph	208/230V-1ph	
² Maximum overcurrent protection (MOCP) amps		40	50	50	
³ Minimum circuit ampacity (MCA)		25.9	33.9	32.5	
Compressor	Rated load amps		18.6	25	23.9
	Locked rotor amps		110	120	124.5
Outdoor Fan Motor		Full load amps	2.4 - 2.6	2.4 - 2.6	2.4 - 2.6

CONTROLS - ORDER SEPARATELY

M30 Smart Wi-Fi Thermostat	15Z69	•	•	•
Remote Outdoor Temperature Sensor	X2658	•	•	•

OPTIONAL ACCESSORIES - ORDER SEPARATELY

Compressor Hard Start Kit	LG	88M91			•
	Copeland	10J42	•	•	
Compressor Sound Cover		18J42	•	•	•
Compressor Low Ambient Cut-Off		45F08	•	•	•
Freezestat	3/8 in. tubing		93G35	•	•
	5/8 in. tubing		50A93	•	•
Indoor Blower Off Delay Relay		58M81	•	•	•
⁴ Low Ambient Kit		54M89	•	•	•
Mild Weather Kit		11B97	•	•	•
Monitor Kit - Service Light		76F53	•	•	•
Outdoor Thermostat Kit	Thermostat		10Z23	•	•
	Mounting Box		31461	•	•
Refrigerant Line Sets (Liq. x Suc. OD x Insulation Thickness - Length)	3/8 x 7/8 x 3/8 - 30 ft.		89J60		
	3/8 x 7/8 x 3/8 - 40 ft.		89J61	•	•
	3/8 x 7/8 x 3/8 - 50 ft.		89J62		
3/8 x 1-1/8 x 3/8 - 30 ft.		X0570			•
3/8 x 1-1/8 x 3/8 - 50 ft.		73P91			
Unit Stand-Off Kit		94J45	•	•	•

NOTE - Extremes of operating range are plus 10% and minus 5% of line voltage.

¹ Refrigerant charge sufficient for 15 ft. length of refrigerant lines. For longer line set requirements see the Installation Instructions for information about line set length and additional refrigerant charge required.

² HACR type breaker or fuse.

³ Refer to National or Canadian Electrical Code manual to determine wire, fuse and disconnect size requirements.

⁴ Crankcase Heater and Freezestat are recommended with Low Ambient Kit.

SOUND DATA

¹ Model	Octave Band Sound Power Levels dBA, re 10 ⁻¹² Watts Center Frequency - HZ							¹ Sound Rating Number (dBA)	² Estimated Sound Pressure Level at Distance From Unit (dBA at distance in ft.)				
	125	250	500	1000	2000	4000	8000		3	5	10	15	50
018	56.5	62	68.0	71.5	66.0	57.0	50	74	67	62	56	53	42
024	56.0	62	66.5	71.0	66	60	55.0	74	67	62	56	53	42
030	56.0	64	69.5	70.0	65	59	52.5	74	67	62	56	53	42
036	59	68	71.5	68.5	66	61	54	75	68	63	57	54	43
042	62	71.0	74.5	72.5	70	63	55.5	78	71	66	60	57	46
048	61	70.5	75.5	73.0	70	64	56.0	79	72	67	61	58	47
060	61.5	70.0	73.0	71	71	68	63	79	73	68	62	59	48

NOTE - the octave sound power data does not include tonal correction.

¹ Tested according to AHRI Standard 270-2008 test conditions.

² Estimated sound pressure level at distance based on AHRI Standard 275-2010 method for equipment located on the ground, roof, or on side of building wall with no adjacent reflective surface within 9.8 feet. Sound pressure levels will increase based on changes to assumptions. For other applications, refer to AHRI Standard 275.

FIELD WIRING

- A - Two Wire Power (see Electrical Data)
 - B - Two or Three Wire Power (size to heater capacity)
 - C - Twelve Wire Low Voltage 18 ga. minimum
Fourteen Wire Low Voltage with Optional Outdoor
Thermostat
 - D - Eight Wire Low Voltage 18 ga. minimum
Ten Wire Low Voltage with Optional Outdoor Thermostat
- NOTE - Field Wiring Not Furnished*
- All wiring must conform to NEC or CEC and local electrical codes.

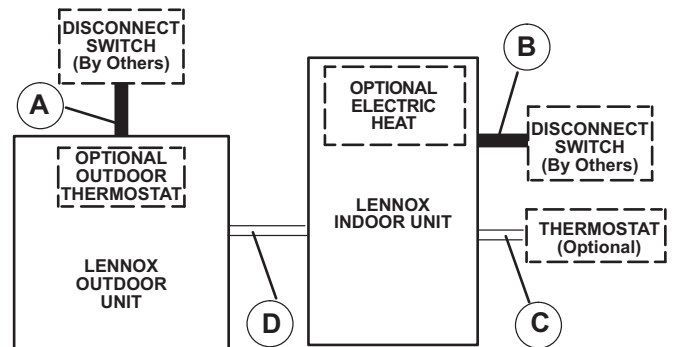

INSTALLATION CLEARANCES

NOTES:

Service clearance of 30 in. (762 mm) must be maintained on one of the sides adjacent to the control box.

Clearance to one of the other three sides must be 36 in. (914 mm)

Clearance to one of the remaining two sides may be 12 in. (305 mm) and the final side may be 6 in. (152 mm).

A clearance of 24 in. must be maintained between two units.

48 in. (1219 mm) clearance required on top of unit.

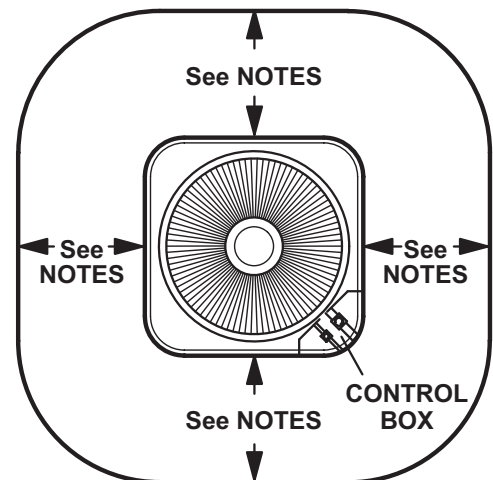

DIMENSIONS - UNIT

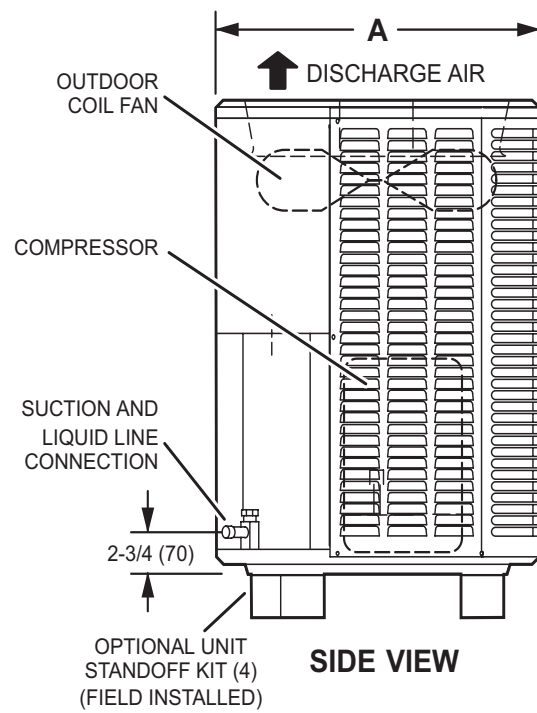
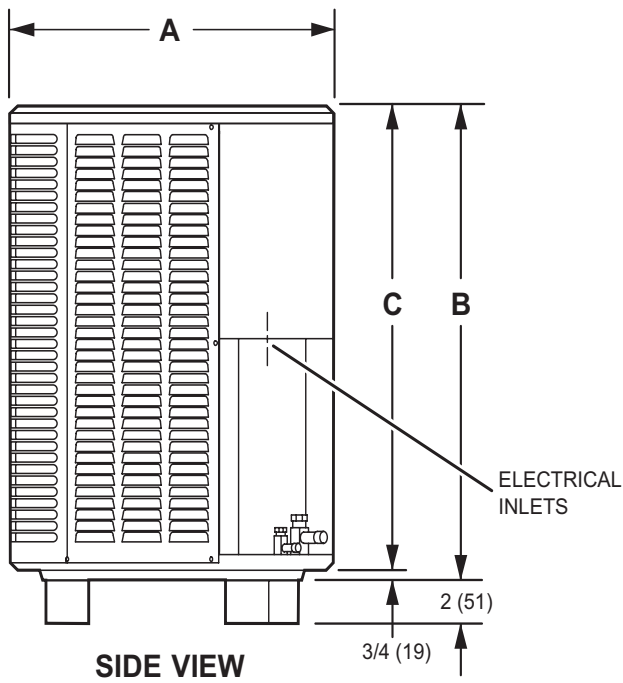
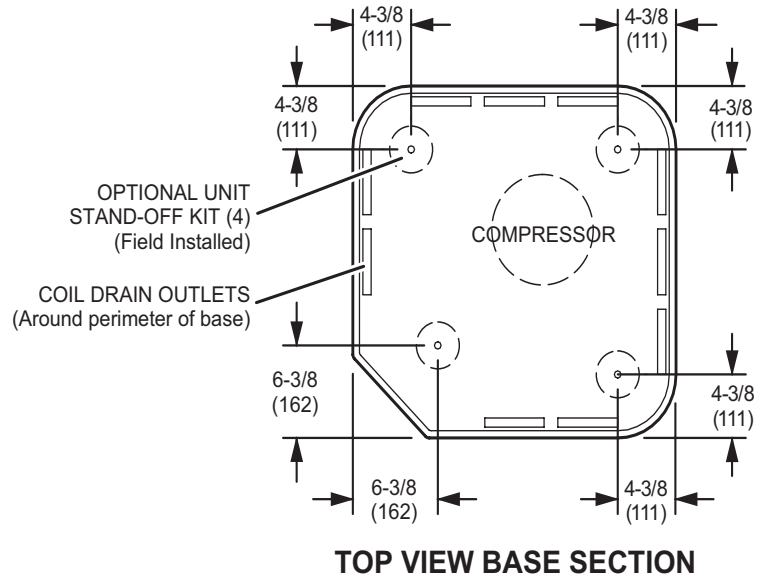
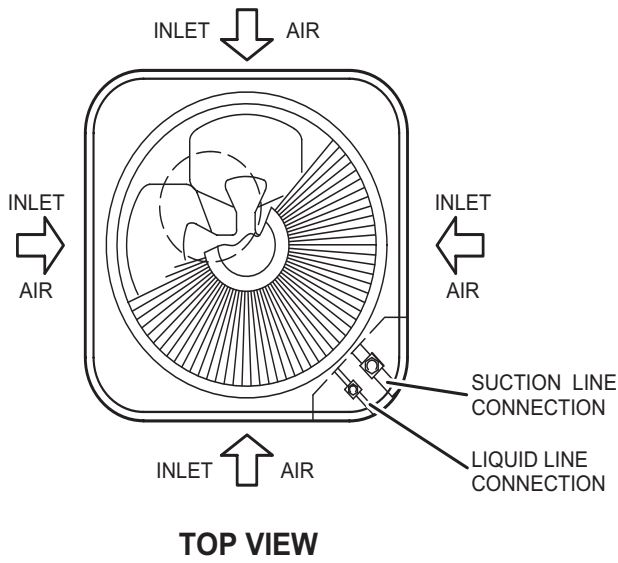

Model	A		B		C	
	in.	mm	in.	mm	in.	mm
018	28-1/4	718	43-1/4	1099	42-1/2	1080
024	28-1/4	718	43-1/4	1099	42-1/2	1080
030	28-1/4	718	33-1/4	845	32-1/2	826
036	32-1/4	817	33-1/4	845	32-1/2	826
042	32-1/4	817	37-1/4	946	36-1/2	927
048	32-1/4	817	37-1/4	946	36-1/2	927
060	32-1/4	817	43-1/4	1099	42-1/2	1080

TXV USAGE

Use this table for C35, CH23 and CR33 Field Installed TXV Match-Ups

Model	Order No.
018	12J18
024	12J18
030	12J18
036	12J19
042	12J20
048	12J20
060	12J20

CX35 and CHX35 coils and all Lennox air handlers are shipped with a factory installed TXV.

C35 coils - Replace the factory installed RFC orifice with the expansion valve listed.

CH23 and CR33 - Use the expansion valve listed.

AHRI STANDARD 210/240-2023

Standard Ratings relating to cooling or heating capacities shall be net values, including the effects of circulating-fan heat, but not including supplementary electric heat. Power input used for calculating efficiency shall be the Total Power.

Standard Ratings of units which do not have indoor air-circulating fans furnished as part of the model, i.e., Coil-only System, shall be established by subtracting from the total cooling capacity 1,505 Btu/h per 1,000 SCFM, and by adding the same amount to the heating capacity for non-mobile-home, non-Space Constrained units. Total Power for both heating and cooling shall be increased by 441 W per 1,000 SCFM of indoor air circulated.

TXV SUBSTITUTION

A general guide for replacing the factory installed TXV if the indoor unit (coil/air handler) is larger or smaller than the outdoor unit.

Outdoor Unit		Indoor Unit		TXV Furnished	TXV Replacement
Size	Tons	Size	Tons		
018	1.5	30/36	2.5/3	12J19	12J18
018	1.5	36	3	12J19	12J18
018	1.5	42	3.5	12J20	12J18
018	1.5	48	4	12J20	12J18
018	1.5	49	4	12J20	12J18
018	1.5	50/60	4/5	12J20	12J18
018	1.5	51/61	4/5	12J20	12J18
018	1.5	60	5	12J20	12J18
024	2	42	3.5	12J20	12J18
024	2	48	4	12J20	12J18
024	2	49	4	12J20	12J18
024	2	50/60	5	12J20	12J18
024	2	51/61	5	12J20	12J18
024	2	60	5	12J20	12J18
030	2.5	42	3.5	12J20	12J18
030	2.5	43	3.5	12J20	12J18
030	2.5	48	4	12J20	12J18
030	2.5	49	4	12J20	12J18
036	3	24	2	12J18	12J19
036	3	30	2.5	12J18	12J19
042	3.5	24	2	12J18	12J20
042	3.5	30	2.5	12J18	12J20
042	3.5	30/36	3	12J19	12J20
042	3.5	36	3	12J19	12J20
048	4	30/36	2.5/3	12J19	12J20
048	4	36	3	12J19	12J20

TXV Ranges:

12J18 - 1.5 to 2.5 ton systems - Use on 2.5 ton (030) and lower systems.

12J19 - 3 ton systems - Use down to 2 ton (024) systems.

12J20 - 3.5 to 5 ton systems - Use down to 3 ton (036) systems.

REVISIONS

Section	Description
Optional Accessories	Updated Hard Start Kit usage.
Specifications	Updated Refrigerant values.



Visit us at www.Lennox.com

For the latest technical information, www.LennoxPros.com

Contact us at 1-800-9-LENNOX

NOTE - Due to Lennox' ongoing commitment to quality, Specifications, Ratings and Dimensions subject to change without notice and without incurring liability. Improper installation, adjustment, alteration, service or maintenance can cause property damage or personal injury. Installation and service must be performed by a qualified installer and servicing agency.

©2023 Lennox Industries, Inc.