



A WORLD OF PERFORMANCE

CATALOGUE / 20  
CATÁLOGO / 20

---

FEMI SpA is an Italian company that after over fifty years of history keeps unchanged the will to be a reference brand in the world of machines intended for professional users.

Our mission is the continuous search for novelties and best solutions to design and produce innovating, safe and high-quality products.

Year by year, FEMI brand has known how to renew itself by offering efficient and innovative solutions for those who want the best tool to work in a precise and safe way or even just for those who want to build with their own hands and their creativity the objects of daily life.

FEMI es una empresa italiana que, después de más de cincuenta años de historia, mantiene la voluntad de ser una marca de referencia en el mundo de las máquinas destinadas al trabajo de profesionales.

Nuestra misión es la búsqueda continua de novedades y la mejor solución para diseñar y construir productos de vanguardia, seguros y de alta calidad. Con el tiempo, la marca FEMI ha sabido renovarse ofreciendo soluciones eficaces e innovadoras para aquellos que quieren lo mejor para trabajar de una manera precisa y segura aunque sea para aquellos que quieren construir sus propias manos y con su creatividad los objetos de la vida cotidiana.



**A WORLD OF PERFORMANCE**

## METAL CUTTING LINE | LÍNEA CORTE METAL

BANDSAWS - INDUSTRIAL RANGE   SIERRAS DE CINTA INDUSTRIALES	pag.	4
<b>NEW</b> N276 DA XL	pag.	8
<b>NEW</b> N257 DA DG	pag.	10
<b>NEW</b> ABS 1750 XL	pag.	16
BIMETAL BANDSAWS BLADES - INDUSTRIAL RANGE   HOJAS DE CINTA BIMETÁLICAS - SERIE INDUSTRIAL	pag.	18
ACCESSORIES - INDUSTRIAL RANGE   ACCESORIOS - SERIE INDUSTRIAL	pag.	19
BANDSAWS PROFESSIONAL RANGE   SIERRAS DE CINTA PROFESIONALES	pag.	20
<b>NEW</b> DCS NG 110	pag.	26
<b>NEW</b> 787 DA XL ALLROAD	pag.	30
BIMETAL BANDSAW BLADES - PROFESSIONAL RANGE   HOJAS DE CINTA BIMETÁLICAS - SERIE PROFESIONAL	pag.	36
ACCESSORIES - PROFESSIONAL RANGE   ACCESORIOS - SERIE PROFESIONAL	pag.	37

## GRINDING - POLISHING LINE | LÍNEA LIJADORAS - ESMERILADORAS

BELT SANDERS - INDUSTRIAL RANGE   LIJADORAS DE BANDA INDUSTRIALES	pag.	38
<b>NEW</b> 577	pag.	40
<b>NEW</b> 575	pag.	41
<b>NEW</b> 574	pag.	41
BENCH GRINDERS   ESMERILADORAS	pag.	45
<b>NEW</b> 294	pag.	50
<b>NEW</b> 295	pag.	50
SHARPENING MACHINES   AFILADORAS	pag.	53
ACCESSORIES   ACCESORIOS	pag.	54
GRINDING WHEELS, BRUSHES AND BELTS   MUELAS, CEPILLOS Y BANDAS	pag.	56

## WOOD LINE | LÍNEA MADERA

MITRESAWS   TRONZADORAS DE MADERA	pag.	60
CIRCULAR BLADES   DISCOS	pag.	72
ACCESSORIES   ACCESORIOS	pag.	74
DISPLAYS	pag.	76

# RANGE OF INDUSTRIAL BANDSAWS | GAMA SIERRAS DE CINTA INDUSTRIALES

## 2700 LINE - LÍNEA 2700

## 2600 LINE - LÍNEA 2600

THREE-PHASE WITH  
AUTOMATIC DOWNFEED  
AND SLIDING VICE

TRIFÁSICA CON  
BAJADA AUTOMÁTICA  
Y VICIO DESLIZANTE



### N310DA DG

SLIDING VICE  
MORDAZA DESLIZANTE

320 Ø 225

Three-phase motor with  
automatic downfeed.  
Motor trifásica con bajada  
automática.

PAG. 6

THREE-PHASE WITH  
AUTOMATIC DOWNFEED

TRIFÁSICA CON  
BAJADA AUTOMÁTICA



### NEW N276DA XL

265 Ø 255

Three-phase motor with  
automatic downfeed.

Motor trifásica con  
bajada automática.

PAG. 8

THREE-PHASE  
TRIFÁSICA

### N266 XL

265 Ø 225

Three-phase motor.  
Motor trifásica.

PAG. 9



SINGLE-PHASE WITH  
AUTOMATIC DOWNFEED

MONOFÁSICA CON  
BAJADA AUTOMÁTICA

SINGLE-PHASE  
MONOFÁSICA

# RANGE OF INDUSTRIAL BANDSAWS | GAMA SIERRAS DE CINTA INDUSTRIALES

## 2500 LINE - LÍNEA 2500

**NEW**

### N257DA DG

SLIDING VICE  
MORDAZA DESLIZANTE

$\square$  253  $\varnothing$  225

Three-phase motor with automatic downfeed.  
Motor trifásica con bajada automática.

PAG. 10



## 2200 LINE - LÍNEA 2200

### N251DA XL

$\square$  250  $\varnothing$  225

Three-phase motor with automatic downfeed.

Motor trifásica con bajada automática.

PAG. 12



### N250DA XL

$\square$  250  $\varnothing$  225

Single-phase motor with automatic downfeed.  
Motor monofásica con bajada automática.

PAG. 13



### 2200DA XL

$\square$  200  $\varnothing$  175

Single-phase motor with automatic downfeed.  
Motor monofásica con bajada automática.

PAG. 14



**NEW**

### ABS 1750 XL

$\square$  160  $\varnothing$  155

Universal motor.  
Motor universal.

AUTOMATIC BLADE SYSTEM

PAG. 16



### 2200 XL

$\square$  200  $\varnothing$  175

Universal motor.  
Motor universal.

PAG. 15



### 1750 XL

$\square$  160  $\varnothing$  155

Universal motor.  
Motor universal.

PAG. 17



# N310<sub>DA</sub> DG

AUTOMATIC DOWN FEED | BAJADA AUTOMÁTICA

BANDSAW 2700 - INDUSTRIAL RANGE  
SIERRA DE CINTA 2700 - SERIE INDUSTRIAL

ART.

N310 DA DG

CODE | CÓDIGO

8.48.90.26



MAX 320 mm

SLIDING VICE  
0°/60° LEFT  
0°/45° RIGHT

MORDAZA DESLIZANTE  
0°/60° IZQUIERDA  
0°/45° DERECHA

### TECHNICAL FEATURES

- Powerful two speed three-phase motor with oil lubricated gear box
- Arm, vice and swivel group made in cast iron
- Side sliding vice and cut up to 45° right and up to 60° left
- Arm downfeed system with hydraulic cylinder and adjustable flow
- Blade tensioning level pressure gauge
- Sliding blade guide with double ball bearings
- Electric/hydraulic front integrated panel
- Motor thermic protection and end-cut switch
- Blade cleaning brush

### STANDARD EQUIPMENT

- Column in assembly kit
- Quick locking system vice
- End-cut automatic switch
- Alu frame lubrication pump
- Bar-stop rod for mass-produced cuts
- Workpiece roller support

### CARACTERÍSTICAS TÉCNICAS

- Potente motor trifásico a dos velocidades con motoriductor lubricado
- Brazo, mordaza y base rotatoria en hierro fundido
- Mordaza deslizante lateral y corte hasta 45° derecha y 60° izquierda
- Sistema de bajada brazo con cilindro hidráulico y regulador de flujo
- Manómetro que indica la tensión de la hoja
- Guía-hoja deslizante en acero con doble cojinetes
- Panel de control eléctrico / hidráulico delantero integrado
- Protección térmica del motor y interruptor de fin del corte
- Cepillo limpio hoja

### EQUIPAMIENTO DE SERIE

- Base en kit de montaje
- Mordaza con sistema de bloqueo rápido
- Interruptor de parada automática fin del corte
- Bomba de lubricación con cuerpo en aluminio
- Varilla regulable para cortar en serie
- Rodillo de soporte de la pieza



- Side sliding vice and cut up to 45° right and up to 60° left
- Mordaza deslizante lateral y corte hasta 45° derecha y 60° izquierda



- Large knob for an easy blade tensioning and pressure gauge indicating blade tensioning level
- Perilla grande para una tensión de la hoja fácil y manómetro que indica tensión de la hoja



- Electric/hydraulic front integrated panel for a practical and easy use
- Panel de control eléctrico/hidráulico delantero para un uso práctico y fácil

### CUTTING CAPACITY | CAPACIDAD DE CORTE

0°	320x200 mm	225 mm	195 mm
45° left/izquierda	210x80 mm	205 mm	195 mm
60° left/izquierda	120x135 mm	125 mm	125 mm
45° right/derecha	170x190 mm	205 mm	175 mm



1,0/1,5



2750x27x0.9



6/10\*



35/70



110

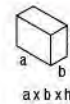

1720x700x1540



344

\*Standard bimetal cobalt blade | De serie hoja bimetálica al cobalto  
 400 Volt - Hz 50 three-phase motor | Motor trifásico 400 Volt - Hz 50

# N276DA XL

AUTOMATIC DOWN FEED | BAJADA AUTOMÁTICA

BANDSAW 2600 - INDUSTRIAL RANGE  
SIERRA DE CINTA 2600 - SERIE INDUSTRIAL

ART.

CODE | CÓDIGO

N276DA XL

8.48.80.71

**NEW**





### TECHNICAL FEATURES

- Blade height 27 mm
- Hydraulic control system for automatic down feed
- Automatic or manual function
- Adjustable left cutting angle from 0° to 60° equipped with quick stop device at 45° and 60° positions
- Blade tensioner with indicator lamp and safety microswitch for proper blade integrity and tensioning

### STANDARD EQUIPMENT

- Adjustable bar stop-rod for mass-produced cuts (L=600 mm)
- Steel column with built-in tool-holder
- Column in assembly kit

### CARACTERÍSTICAS TÉCNICAS

- Altura hoja 27 mm
- Sistema hidráulico de control de bajada automática
- Funcionamiento automático o manual
- Ángulo de corte regulable de 0° a 60° izquierda, con dispositivo de bloqueo rápido en las posiciones 45° y 60°
- Tensor de hoja con indicador luminoso y microinterruptor de seguridad para garantizar tensado de la hoja correcto

### EQUIPAMIENTO DE SERIE

- Varilla de sujeción del material regulable para realizar cortes en serie (L=600 mm)
- Base de acero, con espacio porta-objetos integrado
- Base in kit de montaje



**GREAT CUTTING CAPACITY Ø 255 MM !!**  
**GRAN CAPACIDAD DE CORTE Ø 255 MM !!**



- Cast iron arm for a great strength (total weight 305 Kg)
- Brazo de hierro fundido de gran robustez (peso total 305 Kg)



- Hydraulic control system for automatic down feed
- Sistema hidráulico de control de bajada automática

### CUTTING CAPACITY | CAPACIDAD DE CORTE

0°	265x200 mm	255 mm	200x200 mm
45°	200x160 mm	175 mm	170x170 mm
60°	115x100 mm	110 mm	100x100 mm



1,0/1,3



2565x27x0,9



8/12\*



35/70



60

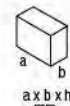

1410x870x1650



311

\*Standard bimetal cobalt blade | 400 Volt - Hz 50 three-phase motor | \*De serie hoja bimetálica al cobalto | Motor trifásico 400 Volt - Hz 50

# N266 XL

BANDSAW 2600 - INDUSTRIAL RANGE  
SIERRA DE CINTA 2600 - SERIE INDUSTRIAL

ART.	CODE   CÓDIGO
N266 XL	8.48.80.27

## TECHNICAL FEATURES

- Blade height 27 mm
- Cast iron arm for a great strenght
- Vise with quick clamping device and non-skid jaws
- Blade tensioner with indicator lamp and safety microswitch for proper blade integrity
- Adjustable left cutting angle from 0° to 60° equipped with quick stop device at 45° and 60° positions
- Cutting angle front indicator

## STANDARD EQUIPMENT

- Adjustable bar stop-rod for mass- produced cuts (L=600 mm)
- Stainless steel column with built-in tool-holder
- Column in assembly kit

## CARACTERÍSTICAS TÉCNICAS



- Altura hoja 27 mm
- Brazo en hierro fundido de gran robustez
- Mordaza con bloqueo rápido y bocas antideslizantes
- Tensor de hoja con indicador luminoso y microinterruptor de seguridad para garantizar tensado de la hoja correcto
- Ángulo de corte regulable de 0° a 60°, con dispositivo de bloqueo rápido en las posiciones 45° y 60°
- Indicador frontal del ángulo de corte

## EQUIPAMIENTO DE SERIE

- Varilla de sujeción del material regulable para realizar cortes en serie (L=600 mm)
- Base de acero, con espacio porta-objetos integrado
- Base in kit de montaje



## CUTTING CAPACITY | CAPACIDAD DE CORTE







			
0°	265x200 mm	225 mm	200x200 mm
45°	200x160 mm	175 mm	170x170 mm
60°	115x100 mm	110 mm	100x100 mm



- Powerful three phase 2 speeds induction motor
- Potente motor de inducción trifásico a 2 velocidades

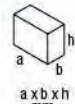

- Vise with quick clamping device and non-skid jaws
- Mordaza con bloqueo rápido y bocas antideslizantes (peso total 305 Kg)

 KILOWATT	 mm	 Zn"	 m/min	 WATT	 a x b x h mm	 Kg
1,0/1,3	2565x27x0,9	8/12*	35/70	60	1410x870x1650	311

\*Standard bimetal cobalt blade | 400 Volt - Hz 50 three-phase motor | \*De serie hoja bimetalica al cobalto | Motor trifásico 400 Volt - Hz 50

# N257DA DG

AUTOMATIC DOWN FEED | BAJADA AUTOMÁTICA

**NEW**

BANDSAW 2500 - INDUSTRIAL RANGE  
SIERRA DE CINTA 2500 - SERIE INDUSTRIAL

ART.

N257DA DG

CODE | CÓDIGO

8.48.80.56

## TECHNICAL FEATURES

- Powerful three phase 2 speeds induction motor, oil lubricated motor gearbox
- Arm, vice and swivel group in cast iron
- Steel sliding blade guide with bearings
- Vice with quick clamping device
- Lubrication pump with aluminium body
- Large knob for an easy blade tensioning
- Pressure gauge indicating blade tension level (600-1000 Kg/cm<sup>2</sup>)

## STANDARD EQUIPMENT

- Column in assembly kit
- Tank for lubricating oil
- Lubricating pump
- Bar stop-rod for mass-produced cuts
- Branches for adjustments, blade replacement and blade protection disassembly
- Blade cleaning brush
- Hydraulic cylinder with flow regulation

## CARACTERÍSTICAS TÉCNICAS

- Potente motor de inducción trifásico a 2 velocidades con motorreductor lubricado
- Brazo, mordaza y base rotatoria en hierro fundido
- Guía-hoja deslizante en acero con cojinetes
- Mordaza con sistema de bloqueo rápido
- Bomba de lubricación con cuerpo en aluminio
- Perilla grande para una tensión de la hoja fácil
- Manómetro que indica tensión de la hoja (600-1000 kg/cm<sup>2</sup>)

## EQUIPAMIENTO DE SERIE

- Base en kit de montaje
- Tanque de recogida por aceite lubricante
- Bomba de lubricación
- Varilla de sujeción para realizar cortes en serie
- Llaves para remplazar la hoja y para el desmontaje de la protección de la hoja
- Cepillo para limpiar la hoja
- Cilindro hidráulico con regulador de flujo

THREE-PHASE  
TRIFÁSICA

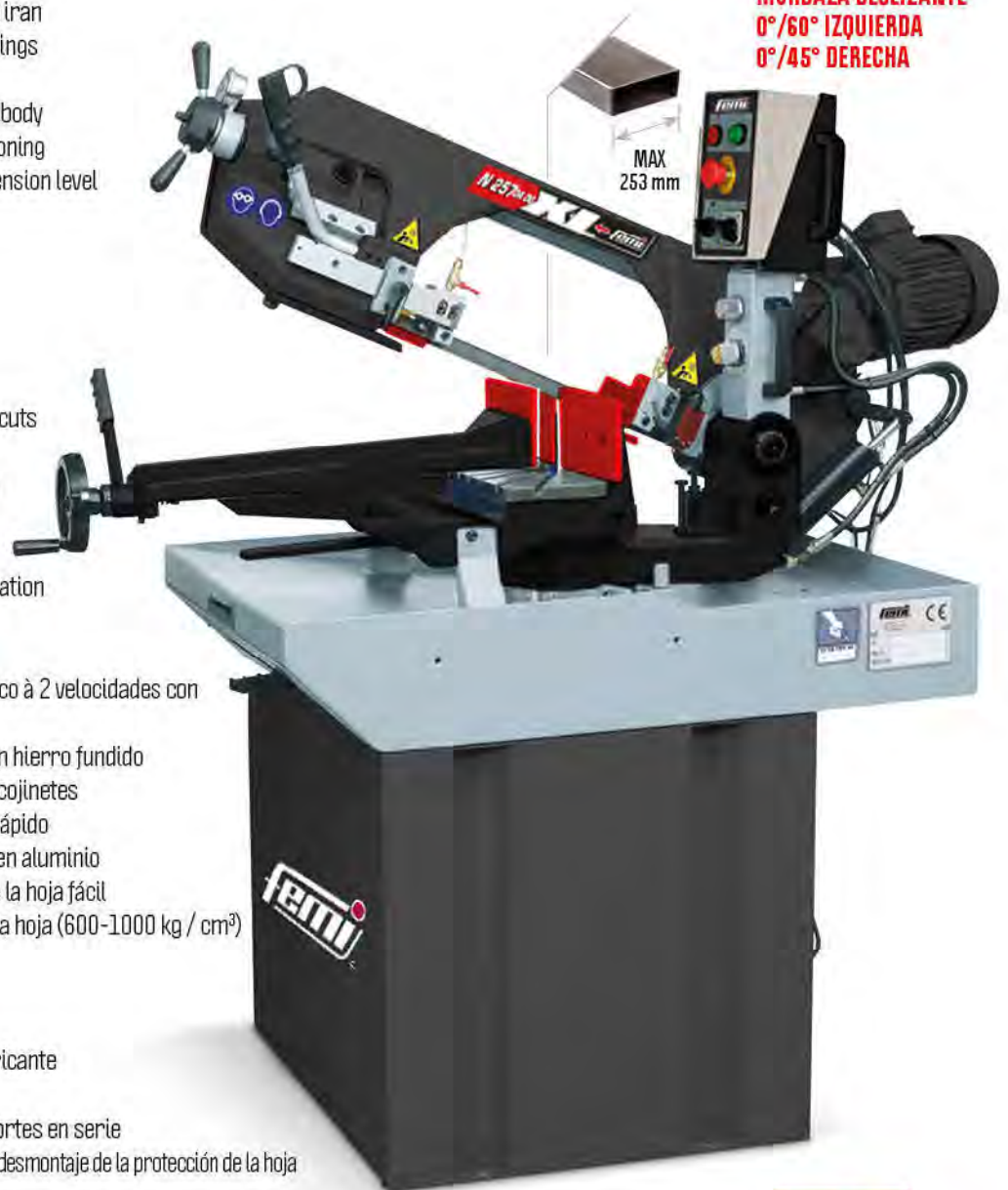

## CUTTING CAPACITY | CAPACIDAD DE CORTE

0°	245xH148- 253xH70	225 mm	180
45° left   izquierda	90xH180	140 mm	120
60° left   izquierda	85xH115	90 mm	90
45° right   derecha	132xH180	148 mm	140



- Hydraulic cylinder with flow regulation
- Cilindro hidráulico con regulador de flujo



0,75/1,1 □



2480x27x0,9



6/10\*



45/90



100

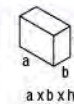

1385x580x890



235

\*Standard bimetal cobalt blade | □ 400 Volt - Hz 50 three-phase motor | \*De serie hoja bimetálica al cobalto | Motor trifásico 400 Volt - Hz 50



BLADES-HOJAS PAG. 18 | ACCESSORIES-ACCESORIOS PAG. 19

# N251DA XL

AUTOMATIC DOWN FEED | BAJADA AUTOMÁTICA

BANDSAW 2500 - INDUSTRIAL RANGE  
SIERRA DE CINTA 2500 - SERIE INDUSTRIAL

ART.	CODE   CÓDIGO
N251DA XL	8.48.80.50

## TECHNICAL FEATURES

- Powerful three phase 2 speeds induction motor, oil lubricated motor gearbox
- Arm, vice and swivel group in cast iron
- Steel sliding blade guide with bearings
- Vice with quick clamping device
- Frontal swivel release lever integrated in the base
- Lubrication pump with aluminium body
- Large knob for an easy blade tensioning
- Pressure gauge indicating blade tension level (600-1000 Kg/cm<sup>3</sup>)

## STANDARD EQUIPMENT

- Column in assembly kit
- Tank for lubricating oil
- Lubricating pump
- Bar stop-rod for mass-produced cuts
- Branches for adjustments, blade replacement and blade protection disassembly
- Blade cleaning brush
- Hydraulic cylinder with flow regulation

## EQUIPAMIENTO DE SERIE

- Base en kit de montaje
- Tanque de recogida por aceite lubricante
- Bomba de lubricación
- Varilla de sujeción para realizar cortes en serie
- Llaves para remplazar la hoja y para el desmontaje de la protección de la hoja
- Cepillo para limpiar la hoja
- Cilindro hidráulico con regulador de flujo

## CARACTERÍSTICAS TÉCNICAS

- Potente motor de inducción trifásico a 2 velocidades con motorreductor lubricado
- Brazo, mordaza y base rotatoria en hierro fundido
- Guía-hoja deslizante en acero con cojinetes
- Mordaza con sistema de bloqueo rápido
- Palanca frontal de desbloqueo de la base giratoria integrada en la base
- Bomba de lubricación con cuerpo en aluminio
- Perilla grande para una tensión de la hoja fácil
- Manómetro que indica tensión de la hoja (600-1000 kg / cm<sup>3</sup>)



THREE-PHASE  
TRIFÁSICA

## CUTTING CAPACITY | CAPACIDAD DE CORTE

			
0°	L 240 x H 160 mm L 250 x H 110 mm	225 mm	185x185 mm
45°	L 135 x H 185 mm L 145 x H 150 mm	150 mm	145x145 mm
60°	L 63 x H 107 L 69 x H 90	70 mm	70x70 mm



- Powerful three phase 2 speeds induction motor
- Potente motor de inducción trifásico a 2 velocidades



- Hydraulic cylinder with flow regulation
- Cilindro hidráulico con regulador de flujo



0,75/1,1 



2480x27x0,9



6/10\*



45/90



100

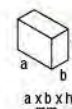

1385x580x890



200

\*Standard bimetal cobalt blade |  400 Volt - Hz 50 three-phase motor | \*De serie hoja bimetálica al cobalto | Motor trifásico 400 Volt - Hz 50

# N250DA XL

AUTOMATIC DOWN FEED | BAJADA AUTOMÁTICA

BANDSAW 2500 - INDUSTRIAL RANGE  
SIERRA DE CINTA 2500 - SERIE INDUSTRIAL

ART.	CODE   CÓDIGO
N250DA XL	8.48.80.52

## TECHNICAL FEATURES

- Powerful single phase induction motor, oil lubricated motor gearbox
- Arm, vice and swivel group in cast iron
- Arm down feed system through hydraulic cylinder with flow regulation
- Steel sliding blade guide with bearings
- Vice with quick clamping device
- Frontal swivel release lever integrated in the base
- Lubrication pump with aluminium body
- Pressure gauge indicating blade tension level (600-1000 Kg/cm<sup>3</sup>)

## STANDARD EQUIPMENT

- Column in assembly kit
- Tank for lubricating oil
- Lubricating pump
- Bar stop-rod for mass-produced cuts
- Branches for adjustments, blade replacement and blade protection disassembly
- Blade cleaning brush
- Hydraulic cylinder with flow regulation

## CARACTERÍSTICAS TÉCNICAS

- Potente motor de inducción monofásico con motorreductor lubricado
- Brazo, mordaza y base en hierro fundido
- Sistema de bajada del brazo a través de cilindro hidráulico con regulador de flujo
- Guía-hoja deslizante en acero con cojinetes
- Mordaza con sistema de bloqueo rápido
- Palanca frontal de desbloqueo de la base giratoria integrada en la base
- Bomba de lubricación con cuerpo en aluminio
- Manómetro que indica tensión de la hoja (600-1000 kg / cm<sup>3</sup>)

## EQUIPAMIENTO DE SERIE

- Base en kit de montaje
- Tanque de recogida por aceite lubricante
- Bomba de lubricación
- Varilla de sujeción para realizar cortes en serie
- Llaves para remplazar la hoja y para el desmontaje de la protección de la hoja
- Cepillo para limpiar la hoja
- Cilindro hidráulico con regulador de flujo



SINGLE PHASE  
MONOFÁSICA

## CUTTING CAPACITY | CAPACIDAD DE CORTE

0°	L 240 x H 160 mm L 250 x H 110 mm	225 mm	185x185 mm
45°	L 135 x H 185 mm L 145 x H 150 mm	150 mm	145x145 mm
60°	L 63 x H 107 L 69 x H 90	70 mm	70x70 mm



- Rear blade guide with blade cleaning brush
- Guía hoja posterior con cepillo para limpiar la hoja



- Large knob for an easy blade tensioning and pressure gauge indicating blade tensioning level
- Perilla grande para una tensión de la hoja fácil y manómetro que indica tensión de la hoja



1100



2480x27x0,9



6/10\*



72



100

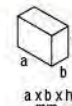

1385x580x890



200

\*Standard bimetal cobalt blade | De serie hoja bimetálica al cobalto - 230 Volt - Hz 50 single-phase motor - Motor monofásico 230 Volt - Hz 50



BLADES-HOJAS PAG. 18 | ACCESSORIES-ACCESORIOS PAG. 19

# 2200 DA XL

AUTOMATIC DOWN FEED | BAJADA AUTOMÁTICA

BANDSAW 2200 - INDUSTRIAL RANGE  
SIERRA DE CINTA 2200 - SERIE INDUSTRIAL

ART.

2200DA XL

CODE | CÓDIGO

8.48.70.24

## TECHNICAL FEATURES

- Hydraulic control system of arm down feed speed
- End-cut stop by micro switch system
- Blade tensioning device with light indicator and safety micro-switch to check the proper blade tension
- Powerful 2000 W universal single-phase motor equipped with digital electronic speed regulator "Constant Speed" and amperometric limiting device

## STANDARD EQUIPMENT

- Integrated and protected lubricating system
- Filter-circuit for electromagnetic interference damping according to rules in force
- Column included in assembly kit

## CARACTERÍSTICAS TÉCNICAS

- Sistema de control hidráulico de la velocidad de bajada
- Micro interruptor de fin carrera de corte
- Tensado de la hoja con indicador luminoso y microinterruptor de seguridad para controlar la integridad de la hoja
- Potente motor monofásico universal (2000 W) con regulación electrónica digital de velocidad "Constant Speed" con limitador amperimétrico y protección térmica

## EQUIPAMIENTO DE SERIE

- Instalación de lubricación/refrigeración integrada y protegida
- Circuito-filtro para la eliminación de interferencias electromagnéticas conforme con las normativas vigentes
- Base en kit de montaje



SINGLE-PHASE  
MONOFÁSICA

## CUTTING CAPACITY | CAPACIDAD DE CORTE

0°	200x75 mm 190x135 mm	175 mm	175x175 mm
45°	150x110 mm	110 mm	110x110 mm
60°	100x70 mm	75 mm	75x75 mm



-Control panel in ergonomic position for starting and adjusting the cutting operations.  
-Panel de control en posición ergonómica para iniciar y ajustar las operaciones de corte.



-Closed circuit hydraulic system for arm descent control.  
-Sistema hidráulico de circuito cerrado para control de la bajada del brazo.



2000 □



2140x19x0,9



6/10\*



35 + 80

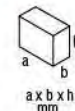

780x1240x1080



143

\*Standard bimetal cobalt blade | De serie hoja bimetálica al cobalto - □ 230 Volt - Hz 50 single-phase motor - Motor monofásico 230 Volt - Hz 50

# 2200 XL

BANDSAW 2200 - INDUSTRIAL RANGE  
SIERRA DE CINTA 2200 - SERIE INDUSTRIAL

ART.	CODE   CÓDIGO
2200 XL	8.48.70.22

## TECHNICAL FEATURES

- Blade tensioning device with light indicator and safety micro-switch to check the proper blade tension
- Powerful 2000 W universal single-phase motor equipped with digital electronic speed regulator "Constant Speed" and amperometric limiting device
- Cast iron quick locking vice with quick sliding system
- Front sliding saw blade guide

## STANDARD EQUIPMENT

- Integrated and protected lubricating system
- Filter-circuit for electromagnetic interference damping according to rules in force
- Column included in assembly kit

## CARACTERÍSTICAS TÉCNICAS

- Tensado de la hoja con indicador luminoso y microinterruptor de seguridad para controlar la integridad de la hoja
- Potente motor monofásico universal (2000 W) con regulación electrónica digital de velocidad "Constant Speed" con limitador amperimétrico y protección térmica
- Mordaza de hierro fundido de bloqueo rápido, provista de sistema de deslizamiento veloz
- Guía-hoja deslizable anterior

## EQUIPAMIENTO DE SERIE

- Instalación de lubricación/refrigeración integrada y protegida
- Circuito-filtro para la eliminación de interferencias electromagnéticas conforme con las normativas vigentes
- Base en kit de montaje



**SINGLE-PHASE  
MONOFÁSICA**

## CUTTING CAPACITY | CAPACIDAD DE CORTE

0°	200x75 mm 190x135 mm	175 mm	175x175 mm
45°	150x110 mm	110 mm	110x110 mm
60°	100x70 mm	75 mm	75x75 mm



- Cut with lubrication system max 200 mm.
- Corte con lubricación max 200 mm.



- Cast iron quick locking vice with quick sliding system.
- Mordaza de hierro fundido de bloqueo rápido, provista de sistema de deslizamiento veloz.



2000 □



2140x19x0,9



6/10\*



35 + 80

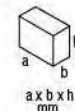

780x1240x1080



140

\*Standard bimetal cobalt blade | De serie hoja bimetálica al cobalto  
□ 230 Volt - Hz 50 single-phase motor - Motor monofásico 230 Volt - Hz 50



BLADES-HOJAS PAG. 18 | ACCESSORIES-ACCESORIOS PAG. 19

ART.	CODE   CÓDIGO
ABS 1750 XL	8.48.60.91

**TECHNICAL FEATURES**

- Push-Click System with mechanical selector and automatic cut-off switches
- Integrated lubricating system, easy to adjust for cutting pieces of different sizes
- Sliding rolls for supporting in- and outgoing workpieces
- Safety emergency button to stop cutting
- Blade tensioning device with clutch to achieve the proper blade tension (PATENTED)
- Energy saving 100% motor efficiency is granted by the exclusive ABS System

**STANDARD EQUIPMENT**

- Column in assembly kit
- Removable Tank for lubricating oil
- Lubricating pump
- Bar stop-rod for mass-produced cuts
- Sliding rolls for supporting both in- and out-going workpieces

**CARACTERÍSTICAS TÉCNICAS**

- Push-click: 4 velocidades de corte, con selector mecánico
- Sistema integrado de lubricación, fácil a orientar para cortar piezas de diferentes tamaños
- Rodillas deslizantes por el apoyo de las piezas en entrada y salida
- Botón de seguridad para detener el corte
- Tensor de la hoja con embrague para la correcta regulación del tensado (PATENTADO)
- El exclusivo sistema ABS asegura el 100% del rendimiento del motor

**EQUIPAMIENTO DE SERIE**

- Base en kit de montaje
- Bañera extraíble por aceite lubricante
- Bomba de lubricación
- Varilla de sujeción para realizar cortes en serie
- Rodillos deslizantes por el apoyo de las piezas en entrada y salida



BLADE HEIGHT  
19 mm!  
LAMA ALTURA  
19 mm!

**CUTTING CAPACITY | CAPACIDAD DE CORTE**

0°	160x140 mm	155 mm	150x150 mm
45°	100x120 mm	110 mm	100x100 mm



- Blade height 19 mm for a more heavy duty work.
- Lama altura 19 mm para un trabajo más intenso y continuo.



- Push-Click system: 4 downfeed speeds with mechanical selector
- Push-Click: 4 velocidad de corte con selector mecánico



2000 □



1735x19x0,9



8/12\*



35 + 80

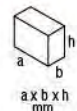

780x1240x1080



75

\*Standard bimetal cobalt blade | De serie hoja bimetálica al cobalto  
□ 230 Volt - Hz 50 single-phase motor - Motor monofásico 230 Volt - Hz 50



# 1750 XL

BANDSAW 1750 - INDUSTRIAL RANGE  
SIERRA DE CINTA 1750 - SERIE INDUSTRIAL

ART.	CODE   CÓDIGO
1750 XL	8.48.60.90

## TECHNICAL FEATURES

- Blade height 19 mm for a more heavy duty work
- Integrated lubricating system, easy to adjust for cutting pieces of different sizes
- Sliding rolls for supporting in- and out-going workpieces
- Integrated quick sliding vice
- Blade tensioning device with clutch to achieve the proper blade tension (PATENTED)
- Double sliding saw blade guide

## STANDARD EQUIPMENT

- Column in assembly kit
- Removable Tank for lubricating oil
- Lubricating pump
- Bar stop-rod for mass-produced cuts
- Sliding rolls for supporting both in- and out-going workpieces

## CARACTERÍSTICAS TÉCNICAS

- Lama altura 19 mm para un trabajo más intenso y continuo
- Sistema integrado de lubricación, fácil de orientar para cortar piezas de diferentes tamaños
- Rodillos deslizantes por el apoyo de las piezas en entrada y salida
- Base con mordaza integrada y sistema de deslizamiento veloz
- Tensor de la hoja con embrague para la correcta regulación del tensado (PATENTADO) Características técnicas

## EQUIPAMIENTO DE SERIE

- Base en kit de montaje
- Bañera extraíble por aceite lubricante
- Bomba de lubricación
- Varilla de sujeción para realizar cortes en serie
- Rodillos deslizantes por el apoyo de las piezas en entrada y salida



## CUTTING CAPACITY | CAPACIDAD DE CORTE

0°	160x140 mm	155 mm	150x150 mm
45°	100x120 mm	110 mm	100x100 mm



2000	1735x19x0,9	8/12*	35 ÷ 80	LT min 8,5	780x1240x1080	75
------	-------------	-------	---------	------------	---------------	----

\*Standard bimetal cobalt blade | De serie hoja bimetalica al cobalto · 230 Volt - Hz 50 single-phase motor | Motor monofásico 230 Volt - Hz 50



### TECHNICAL FEATURES

- Bimetal cobalt blades M42 for high cutting performance
- Suitable for dry cutting, too
- High resistance and productivity both for solid materials and for profiles
- Available in standard packs of 1 or 5 pieces

### CARACTERÍSTICAS TÉCNICAS

- Hojas bimetálicas al cobalto M42 para elevadas prestaciones de corte
- Ideales también para cortes en seco
- Gran resistencia y productividad tanto en materiales macizos como en perfilados
- Disponibles en paquetes estándar de 1 ó 5 piezas

CODE  
CÓDIGO



PACK  
CAJA

#### ART. N310 DA DG 2700

3.28.00.56	2750x27x0,9	6/10*	1 pc
3.28.00.60	2750x27x0,9	6/10*	5 pc
3.28.00.55	2750x27x0,9	4/6	1 pc
3.28.00.59	2750x27x0,9	4/6	5 pc
3.28.00.54	2750x27x0,9	8/12	1 pc
3.28.00.58	2750x27x0,9	8/12	5 pc
3.28.00.57	2750x27x0,9	10/14	1 pc
3.28.00.61	2750x27x0,9	10/14	5 pc

#### ART. N276DAXL-N266DAXL-N266XL-N265XL 2600

3.28.00.28	2565x27x0,9	8/12*	1 pc.
3.28.00.32	2565x27x0,9	8/12*	5 pc.
3.28.00.26	2565x27x0,9	4/6	1 pc.
3.28.00.30	2565x27x0,9	4/6	5 pc.
3.28.00.27	2565x27x0,9	5/8	1 pc.
3.28.00.31	2565x27x0,9	5/8	5 pc.
3.28.00.29	2565x27x0,9	10/14	1 pc.
3.28.00.33	2565x27x0,9	10/14	5 pc.

#### ART. N257DADG-N251DAXL-N250DAXL 2500

3.28.00.42	2480x27x0,9	6/10*	1 pc.
3.28.00.44	2480x27x0,9	6/10*	5 pc.
3.28.00.39	2480x27x0,9	4/6	1 pc.
3.28.00.41	2480x27x0,9	4/6	5 pc.
3.28.00.38	2480x27x0,9	8/12	1 pc.
3.28.00.40	2480x27x0,9	8/12	5 pc.
3.28.00.43	2480x27x0,9	10/14	1 pc.
3.28.00.45	2480x27x0,9	10/14	5 pc.

#### ART. N216XL-2200XL-2200DAXL-787XL\*\* 2200

3.27.99.36	2140x19x0,9	6/10*	1 pc.
3.27.99.39	2140x19x0,9	6/10*	5 pc.
3.28.00.24	2140x19x0,9	8/12**	1 pc.
3.28.00.25	2140x19x0,9	8/12**	5 pc.
3.27.99.38	2140x19x0,9	4/6	1 pc.
3.27.99.41	2140x19x0,9	4/6	5 pc.
3.27.99.37	2140x19x0,9	14	1 pc.
3.27.99.40	2140x19x0,9	14	5 pc.

#### ART. ABS 1750XL-1750XL H19mm - 1750

3.28.00.47	1735x19x0,9	8/12*	1 pc.
3.28.00.51	1735x19x0,9	8/12*	5 pc.
3.28.00.48	1735x19x0,9	4/6	1 pc.
3.28.00.52	1735x19x0,9	4/6	5 pc.
3.28.00.46	1735x19x0,9	6/10	1 pc.
3.28.00.50	1735x19x0,9	6/10	5 pc.
3.28.00.49	1735x19x0,9	14	1 pc.
3.28.00.53	1735x19x0,9	14	5 pc.

\* Standard fitting on bandsaws - En dotación estándar en las SIERRA

## ROLLER STANDS | SOPORTE RODILLOS MODULARES

ART.	CODE CÓDIGO	SIZE AxBxH (mm) DIMENSIONES AxBxH (mm)	ROLLER CAPACITY CAPACIDAD DEL RODILLO	APPLICATION   APLICACIÓN	FOR ART.   PARA ART.
326	7.13.37.03	1000x300x880÷970	200 Kg.	Bars loading/unloading   Carga/descarga barras	N310DA DG - N257 DADG - N276DA XL N250DA XL - N251DA XL - N266DA XL
327	7.13.37.04	1000x300x880÷970	200 Kg.	Supplemental module   Módulo adicional	- N266XL - N265XL - N216XL - 2200XL - 2200DA XL

### TECHNICAL FEATURES

- Steel rollers  $\varnothing$  50 mm fitted with bearings
- Liquid collection tank made of sturdy steel sheet
- Pipe steel structure. Adjustable support feet
- Possibility to fit 8 vertical antifall rollers

### CARACTERÍSTICAS TÉCNICAS

- Rodillos de acero  $\varnothing$  50 mm montados sobre cojinetes
- Recipiente de recogida del líquido de robusta chapa de acero
- Estructura tubular de acero. Pies de apoyo de altura regulable
- Adaptación para 8 rodillos verticales anticaída

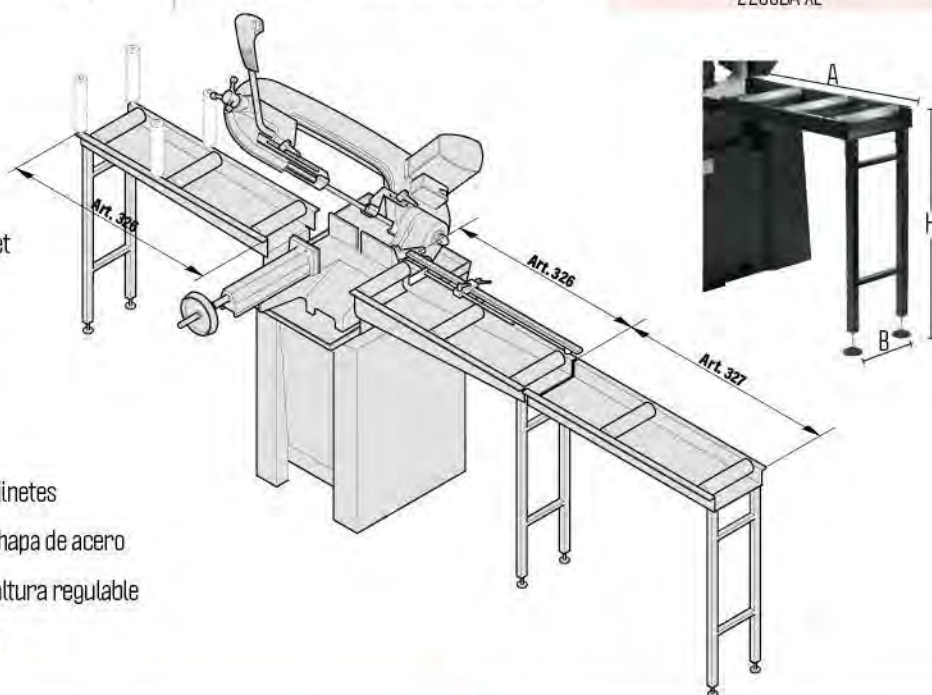

## VERTICAL ANTIFALL TEFLON ROLLER\* | RODILLO VERTICAL REVESTIDO DE TEFLÓN\*

CODE   CÓDIGO	SIZE mm   DIMENSIONES mm
7.21.42.11	$\varnothing$ 40x150



\*On request - \*Bajo pedido

## MILLIMETRIC BAR STOP RODS\* | VARILLAS DE SUJECIÓN DE LA BARRA MILLIMETRADA\*

CODE   CÓDIGO	FOR ART.   PARA ART.	LENGHT   LARGO
7.13.05.76	326	1000 mm
7.13.05.77	327	1000 mm



## SINGLE-ROLLER SUPPORT | SOPORTE MONO-RODILLO

ART.	CODE CÓDIGO	SIZE AxBxH (mm) DIMENSIONES AxBxH (mm)	WEIGHT PESO
301	7.13.36.02	520x400x680÷1140	6,5 Kg.

### TECHNICAL FEATURES

- Zinc-plated steel roller  $\varnothing$  57 mm
- Sturdy steel structure
- Base equipped with leveling feet
- Support height adjustment

### CARACTERÍSTICAS TÉCNICAS

- Rodillo de acero galvanizado  $\varnothing$  57 mm
- Robusta estructura de acero, hierro fundido
- Base provista de pies de nivelación
- Regulación de la altura de apoyo

**RANGE OF PROFESSIONAL BANDSAWS | GAMA SIERRAS DE CINTA PROFESIONALES**

**1330 LINE - LÍNEA 1330**

**ABS**  
Automatic Blade System



DOWNLOAD  
THE VIDEO  
DESCARGA  
EL VIDEO

**ABS 105**

∅105

PAG. 24



**NG**  
NEW GENERATION



**DCS**  
DIGITAL CUTTING SYSTEM **NEW**

DCS NG110

∅110

PAG. 26



DOWNLOAD  
THE VIDEO  
DESCARGA  
EL VIDEO

**780XL**

∅105

PAG. 35



**782XL**

∅105

PAG. 33



**XL**  
EXTRA LARGE

**783XL**

∅105

PAG. 33



**782XL 48 VOLT**

∅105

PAG. 34



# RANGE OF PROFESSIONAL BANDSAWS | GAMA SIERRAS DE CINTA PROFESIONALES

## 1440 LINE - LÍNEA 1440



**ABS NG 120**

∅ 120

PAG. 23



DOWNLOAD  
THE VIDEO  
DESCARGA  
EL VIDEO

## 1750 LINE - LÍNEA 1750



**ABS NG 160**

∅ 160

PAG. 22



DOWNLOAD  
THE VIDEO  
DESCARGA  
EL VIDEO

## 2200 LINE - LÍNEA 2200



**NG120XL**

∅ 120

PAG. 29



DOWNLOAD  
THE VIDEO  
DESCARGA  
EL VIDEO



**NG160**

∅ 160

PAG. 28



**NEW**

**787 DA XL**

∅ 213

**allroad**



DOWNLOAD  
THE VIDEO  
DESCARGA  
EL VIDEO

PAG. 30

**784XL**

∅ 120

PAG. 32



**785XL**

∅ 205

PAG. 31



**787 XL**

∅ 213

**allroad**

ART.	CODE   CÓDIGO
ABS NG160	8.48.60.80

**PATENTED**

### TECHNICAL FEATURES

- Push-click: 4 downfeed speeds with mechanical selector
- Automatic cut-off switch after finishing cutting operation
- Safety emergency button to stop cutting
- Energy saving 100% motor efficiency is granted by the exclusive ABS system
- Maximum cutting versatility on all metal materials **AL Acc INOX**
- More than 10 % saving on blade consumption

### STANDARD EQUIPMENT

- Adjustable bar stop-rod for mass-produced cuts (L= 500mm)
- Handles for easy handling
- Filter-circuit for electromagnetic interference damping according to rules in force.

### CARACTERÍSTICAS TÉCNICAS

- Push-click 4 velocidades de corte, con selector mecánico
- Interruptor de parada automática al final del corte
- Botón de seguridad para detener el corte
- El exclusivo sistema abs asegura el 100% del rendimiento del motor
- Máxima versatilidad de corte sobre todo tipo de metal **AL Acc INOX**
- Más del 10% de ahorro en el consumo de la hoja de sierra

### EQUIPAMIENTO DE SERIE

- Varilla de sujeción regulable para realizar cortes en serie (L= 500mm)
- Asas para el transporte
- Circuito-filtro para la eliminación de interferencias electromagnéticas conforme con las normativas vigentes



**NG**  
NEW GENERATION

### CUTTING CAPACITY | CAPACIDAD DE CORTE

0°	160x140 mm	150 mm	150X150 mm
45°	105x120 mm	100 mm	100X100 mm

For solid materials we suggest to reduce the maximum cutting diameter  
Para el material macizo se aconseja reducir el diámetro máximo de corte

### FULLY AUTONOMOUS CUTTING CYCLE WITHOUT OPERATOR | CICLO DE CORTE COMPLETAMENTE AUTÓNOMO, SIN PRESENCIA DEL OPERARIO

**ABS**  
Automatic Blade System



2000



1735x13x0,9



14\*



35 + 80

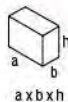

1000x390x570



36



DOWNLOAD THE VIDEO  
DESCARGA EL VIDEO

\*Standard bimetal cobalt blade | De serie hoja bimetálica al cobalto  
 230 Volt - Hz 50 single-phase motor - Motor monofásico 230 Volt - Hz 50

ART.	CODE   CÓDIGO
ABS NG120	8.48.50.80

### TECHNICAL FEATURES

- Push-click: 4 downfeed speeds with mechanical selector
- Automatic cut-off switch after finishing cutting operation
- Safety emergency button to stop cutting
- Energy saving 100% motor efficiency is granted by the exclusive ABS system
- Maximum cutting versatility on all metal materials (AL, Acc, Inox)
- More than 10 % saving on blade consumption

### STANDARD EQUIPMENT

- Adjustable bar stop-rod for mass-produced cuts (L=500mm)
- Tools for changing blade
- Filter-circuit for electromagnetic interference damping according to rules in force

### CARACTERÍSTICAS TÉCNICAS

- Push-click 4 velocidades de corte, con selector mecánico
- Interruptor de parada automática al final del corte
- Botón de seguridad para detener el corte
- El exclusivo sistema abs asegura el 100% del rendimiento del motor
- Máxima versatilidad de corte sobre todo tipo de metal (AL, Acc, Inox)
- Más del 10% de ahorro en el consumo de la hoja de sierra

### EQUIPAMIENTO DE SERIE

- Varilla tope regulable para realizar cortes en serie (L= 500mm)
- Herramienta para el cambio de la hoja
- Circuito-filtro para la eliminación de interferencias electromagnéticas conforme con las normativas vigentes

**WITHOUT LUBRICATION  
SIN LUBRICACION**

**PATENTED**



**60%**  
FASTER | MAS VELOZ

**NG**  
NEW GENERATION

	CUTTING CAPACITY   CAPACIDAD DE CORTE		
0°	120x102 mm	120 mm	112x112 mm
45°	78x78 mm	80 mm	78x78 mm
60°	50x43 mm	50 mm	48x48 mm

## FULLY AUTONOMOUS CUTTING CYCLE WITHOUT OPERATOR | CICLO DE CORTE COMPLETAMENTE AUTÓNOMO, SIN PRESENCIA DEL OPERARIO

**ABS**  
Automatic Blade System



• Cut start up  
Puesta en marcha del corte



• Autonomous cutting cycle  
Ciclo de corte autónomo



• Automatic switch off  
Parada automática



1300



1440x13x0,65



14\*



35 + 80

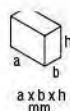

900x400x520



19



DOWNLOAD THE VIDEO  
DESCARGA EL VIDEO

\*Standard bimetal cobalt blade | De serie hoja bimetálica al cobalto  
□ 230 Volt - Hz 50 single-phase motor - Motor monofásico 230 Volt - Hz 50



ART.	CODE   CÓDIGO
ABS 105	8.48.46.81

### TECHNICAL FEATURES

- Push-click: 4 downfeed speeds with mechanical selector
- Automatic cut-off switch after finishing cutting operation
- Safety emergency button to stop cutting
- Energy saving 100% motor efficiency is granted by the exclusive ABS system
- Maximum cutting versatility on all metal materials  $\triangleleft$  AL  $\triangleleft$  Acc  $\triangleleft$  Inox
- More than 10 % saving on blade consumption

### STANDARD EQUIPMENT

- Adjustable bar stop-rod for mass-produced cuts (L= 500mm)
- Blade cleaning felt spares kit
- Filter-circuit for electromagnetic interference damping according to rules in force

### CARACTERÍSTICAS TÉCNICAS

- Push-click 4 velocidades de corte, con selector mecánico
- Interruptor de parada automática al final del corte
- Botón de seguridad para detener el corte
- El exclusivo sistema abs asegura el 100% del rendimiento del motor
- Máxima versatilidad de corte sobre todo tipo de metal  $\triangleleft$  AL  $\triangleleft$  Acc  $\triangleleft$  Inox
- Más del 10% de ahorro en el consumo de la hoja de sierra

### EQUIPAMIENTO DE SERIE

- Varilla de sujeción de la barra regulable, para realizar cortes en serie (L= 500mm)
- Kit de recambio filtro de limpieza de la hoja
- Circuito-filtro para la eliminación de interferencias electromagnéticas conforme con las normativas vigentes



**WITHOUT LUBRICATION  
SIN LUBRICACION**

### CUTTING CAPACITY | CAPACIDAD DE CORTE

0°	100x85 mm	105 mm	95x95 mm
45°	65x60 mm	65 mm	65x65 mm

### FULLY AUTONOMOUS CUTTING CYCLE WITHOUT OPERATOR | CICLO DE CORTE COMPLETAMENTE AUTÓNOMO, SIN PRESENCIA DEL OPERARIO



- Cut start up
- Puesta en marcha del corte



- Autonomous cutting cycle
- Ciclo de corte autónomo



- Automatic switch off
- Parada automática



950 □



1335x13x0,65



8/12\*



60/80

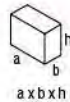

730x390x500



17



DOWNLOAD THE VIDEO  
DESCARGA EL VIDEO

\*Standard bimetal cobalt blade | De serie hoja bimetálica al cobalto  
□ 230 Volt - Hz 50 single-phase motor - Motor monofásico 230 Volt - Hz 50





# ABS

Automatic Blade System

## SYSTEM REVOLUTION

Fully autonomous cutting cycle,  
without operator.

Ciclo de corte completamente  
autónomo, sin presencia del operador.



ART.	CODE   CÓDIGO
DCS NG 110	8.48.48.20



**LASER LIGHT**

**PATENTED**

FASTER | MÁS VELOZ  
**40%**

### TECHNICAL FEATURES

- Up to 40% faster cutting compared to the traditional bandsaw thanks to the opposite rotation direction of the bandsaw blade ("NG SYSTEM")
- 5 pre-set cutting modes
- Innovative blade tensioning device with clutch to check and adjust the proper tension of the blade (patented)
- Low voltage start button power
- Adjustable left cutting angle from 0° to 45°
- Sturdy die-cast aluminium base with integrated vice

### STANDARD EQUIPMENT

- Adjustable bar stop-rod for massproduced cuts (L= 500 mm)
- Filter-circuit for electromagnetic interference damping according to rules in force

• Packaging completely in Eco-Sustainable Cardboard

### CARACTERÍSTICAS TÉCNICAS

- Reducción del tiempo de corte hasta un 40% respecto a una sierra tradicional gracias al sentido de rotación contrario de la hoja ("NG SYSTEM")
- 5 modos de corte programados
- Innovador tensor mediante embrague para el control y la regulación del correcto tensado de la hoja (patentado)
- Botón de inicio de baja tensión
- Ángulo de corte regulable de 0° a 45° izquierda
- Robusta base de aluminio fundido a presión con vicio integrado

### EQUIPAMIENTO DE SERIE

- Varilla tope regulable para realizar cortes en serie (L= 500mm)
- Circuito-filtro para la eliminación de interferencias electromagnéticas conforme con las normativas vigentes

• Embalaje completo en tarjeta ecosostenible



950 □



1330x13x0,65



14\*



35 + 80

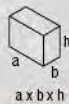

730x390x500



17

\*Standard bimetal cobalt blade | De serie hoja bimetálica al cobalto  
□ 230 Volt - Hz 50 single-phase motor - Motor monofásico 230 Volt - Hz 50

### CUTTING CAPACITY | CAPACIDAD DE CORTE

0°	110x85 mm	105 mm	100x100 mm
45°	75x37 mm	74 mm	72x72 mm

# DCS

DIGITAL CUTTING SYSTEM

Revolutionary electronic control system that guarantees optimal cutting in the main conditions of use through 5 pre-set working modes.

Sistema revolucionario de control electrónico que asegura un corte óptimo en las principales condiciones de uso a través de 5 modos de trabajo preestablecidos.

## MODE

## SPEED

## FORCE CONTROL

1

For demanding cuts with particularly resistant materials, stainless steel and solid sections with thickness > 30 mm

Para cortes exigentes con materiales particularmente resistentes, acero inoxidable y secciones sólidas con espesor > 30 mm

30 mt/min  
STEEL-INOX

> 30mm



2

For cutting steel with tubular sections up to 30 mm thickness and full up to 30 mm

Para cortar acero con secciones tubulares de hasta 30 mm de espesor y llenos hasta 30 mm

45 mt/min  
STEEL

0 □ ●  
> 8mm < 30mm



3

Ideal for cutting iron and steel for any shape with thickness between 5 and 8 mm

Ideal para cortar hierro y acero de cualquier forma con espesor entre 5 y 8 mm

55 mt/min  
STEEL

0 L H □  
> 5mm < 8mm



4

Ideal for tubular sections including L and H sections with thin thickness from 3 to 5 mm. All materials, including aluminium.

Ideal para secciones tubulares que incluyen secciones L y H con espesor fino de 3 a 5 mm. Todos los materiales, incluido el aluminio.

65 mt/min  
STEEL - ALU

0 □  
> 3mm < 5mm



5

Only for very fine section tubulars with thicknesses under 3 mm. All materials, including aluminium

Solo para tubulares de sección muy fina con espesores inferiores a 3 mm. Todos los materiales, incluido el aluminio

80 mt/min  
STEEL - ALU

0 □  
> 3mm



Manual adjustment of the blade rotation speed

Regulación manual de la velocidad de rotación de la hoja.

Overload indicator to avoid excessive engine strain, possible blade breakages and inaccurate cuts

Indicador de sobrecarga para evitar la tensión excesiva del motor, posibles roturas de la hoja y cortes imprecisos.



ART.	CODE   CÓDIGO
NG160	8.48.60.21

### TECHNICAL FEATURES

- Up to 40% faster cutting compared to the traditional bandsaw thanks to the opposite rotation direction of the bandsaw blade ("NG SYSTEM")
- Base with integrated quick sliding vice
- Powerful 2000 W single-phase motor equipped with digital electronic speed regulator "Constant Speed" with amperometric limiting device and thermal protection
- Guard safety microswitch for blade protection

### STANDARD EQUIPMENT

- Adjustable bar stop-rod for mass-produced cuts (L= 500mm)
- Handles for easy handling
- Filter-circuit for electromagnetic interference damping according to rules in force.

### CARACTERÍSTICAS TÉCNICAS

- Reducción del tiempo de corte hasta un 40% respecto a una sierra tradicional gracias al sentido de rotación contrario de la hoja ("NG SYSTEM")
- Base con mordaza y sistema deslizante rápido integrada
- Potente motor monofásico (2000 W) con regulación electrónica digital de velocidad "Constant Speed" con limitador amperimétrico y protección térmica
- Cambio de la hoja rápido y sin necesidad de herramientas.

### EQUIPAMIENTO DE SERIE

- Varilla de sujeción regulable para realizar cortes en serie (L= 500mm)
- Asas para el transporte
- Circuito-filtro para la eliminación de interferencias electromagnéticas conforme con las normativas vigentes

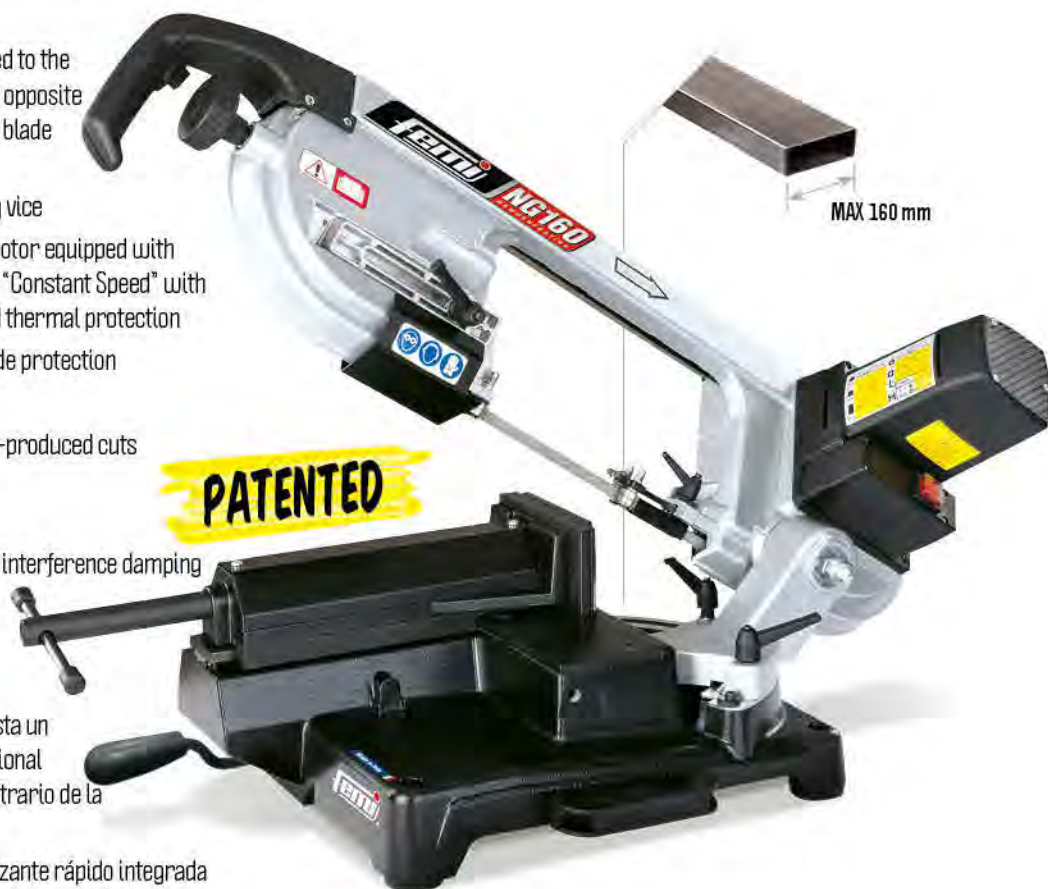

**WITHOUT LUBRICATION  
SIN LUBRICACION**

### CUTTING CAPACITY | CAPACIDAD DE CORTE

0°	160x140 mm	150 mm	150x150 mm
45°	105x120 mm	100 mm	100x100 mm

For solid materials we suggest to reduce the maximum cutting diameter  
Para el material macizo se aconseja reducir el diámetro máximo de corte

FASTER MÁS VELOZ  
**40%**

# NG

NEGENERATION

"NG SYSTEM": opposite blade rotation direction  
"NG System": rotación inversa de la hoja.



- Adjustable double sliding saw blade guides
- Guías de corte dobles ajustables



- Innovative clutched band tensioning system (patented)
- Nuevo sistema de tensado de la hoja por fricción (patentado)



2000 □



1735x13x0,9



6/10\*



35 = 80

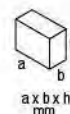

1000x390x570



35

\*Standard bimetal cobalt blade | De serie hoja bimetálica al cobalto - □ 230 Volt - Hz 50 single-phase motor - Motor monofásico 230 Volt - Hz 50

ART.	CODE   CÓDIGO
NG120 XL	8.48.50.22

### TECHNICAL FEATURES

- Up to 60% faster cutting compared to the traditional bandsaw thanks to the opposite rotation direction of the bandsaw blade ("NG SYSTEM")
- Innovative blade tensioning device with clutch to check and adjust the proper tension of the blade (patented)
- Adjustable left cutting angle from 0° to 60° with quick block at 45° and 60°
- Powerful 1300 W single-phase motor equipped with digital electronic speed regulator "Constant Speed" with amperometric limiting device
- Double front and rear sliding saw blade guides

### STANDARD EQUIPMENT

- Adjustable bar stop-rod for mass-produced cuts (L= 500 mm)
- Tools for changing blade
- Filter-circuit for electromagnetic interference damping according to rules in force

### CARACTERÍSTICAS TÉCNICAS

- Reducción del tiempo de corte hasta un 60% respecto a una sierra tradicional gracias al sentido de rotación contrario de la hoja ("NG SYSTEM")
- Innovador tensor mediante embrague para el control y la regulación del correcto tensado de la hoja (patentado)
- Ángulo de corte regulable de 0° a 60° izquierda con bloqueo rápido 45° y 60°.
- Potente motor 1300 W con regulación electrónica de velocidad "velocidad constante", con limitador amperimétrico y protección térmica.
- Doble guía-hoja ambas deslizables anterior y posterior.

### EQUIPAMIENTO DE SERIE

- Varilla tope regulable para realizar cortes en serie (L= 500mm)
- Herramienta para el cambio de la hoja
- Circuito-filtro para la eliminación de interferencias electromagnéticas conforme con las normativas vigentes



**WITHOUT LUBRICATION  
SIN LUBRICACION**

	CUTTING CAPACITY   CAPACIDAD DE CORTE		
0°	120x102 mm	120 mm	112x112 mm
45°	78x78 mm	80 mm	78x78 mm
60°	50x43 mm	50 mm	48x48 mm

FASTER | MÁS VELOZ  
**60%**

# NG

NEW GENERATION

"NG SYSTEM": opposite blade rotation direction

"NG System": rotación inversa de la hoja.



- Maximum cutting capacity 120 x 102 mm
- Capacidad de corte máxima 120 x 102 mm



- Easy to carry
- Fácil de transportar



1300



1440x13x0,65



14\*



35 + 80

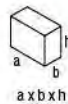

900x400x520



18



DOWNLOAD THE VIDEO  
DESCARGA EL VIDEO

\*Standard bimetal cobalt blade | De serie hoja bimetálica al cobalto  
 230 Volt - Hz 50 single-phase motor - Motor monofásico 230 Volt - Hz 50



# XL 787 DA XL | 787 XL allroad

BANDSAW 2200 - PROFESSIONAL RANGE  
SIERRA DE CINTA 2200- SERIE PROFESIONAL

AUTOMATIC DOWN FEED | BAJADA AUTOMÁTICA

ART. CODE | CÓDIGO

ART. CODE | CÓDIGO

**NEW**

787 DA XL Allroad

8.48.70.25

787 XL Allroad

8.48.70.23



## TECHNICAL FEATURES

- Exclusive "roto-translating" arm system (patented)
- Blade height 19 mm
- Possibility to make cuts with lubrication
- Base complete with wheels ideal for transport

## EQUIPAMIENTO DE SERIE

- Circuito-filtro para la eliminación de interferencias electromagnéticas conforme con las normativas vigentes

## CARACTERÍSTICAS TÉCNICAS

- Sistema exclusiva del brazo "roto-traslación" (patentado)
- Altura hoja 19 mm
- Posibilidad de hacer cortes con la lubricación
- Base completa con ruedas ideal para el transporte

## STANDARD EQUIPMENT

- Filter-circuit for electromagnetic interference damping according to rules in force

## 787 DA XL



- Control panel in ergonomic position for starting and adjusting cutting operation
- Panel de control en posición ergonómica para iniciar y ajustar las operaciones de corte



- Closed circuit hydraulic system for arm down feed and descent control
- Sistema hidráulico de circuito cerrado para control de la bajada del brazo

## CUTTING CAPACITY | CAPACIDAD DE CORTE

0°	213x150 mm	175 mm	150x150 mm
45°	145x80 mm	140 mm	140x140 mm



WATT

1850



2140X19X0,9



8/12\*



60/80

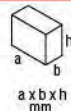

500x1300x700



Kg

59



DOWNLOAD THE VIDEO  
DESCARGA EL VIDEO

\*Standard bimetal cobalt blade | De serie hoja bimetálica al cobalto • □ 230 Volt - Hz 50 single-phase motor - Motor monofásico 230 Volt - Hz 50

# XL 785 XL

BANDSAW 1750 - PROFESSIONAL RANGE  
SIERRA DE CINTA 1750 - SERIE PROFESIONAL

ART.	CODE   CÓDIGO
785 XL	8.48.60.26

## TECHNICAL FEATURES

- Unique and great cutting capacity:  
□ 205 x 150 mm
- Powerful 1600 Watt motor with two speeds electric switchover and thermal protection
- Blade tensioning system fitted with light indicator
- Easy to carry

## STANDARD EQUIPMENT

- Adjustable bar stop-rod for mass-produced cuts (L= 500mm)
- Handles for easy handling
- Filter-circuit for electromagnetic interference damping according to rules in force

## CARACTERÍSTICAS TÉCNICAS

- Gran capacidad de corte:  
□ 205 x 150 mm
- Potente motor 1600 W - dos velocidades de conmutación eléctrica, con protección térmica
- Tensor de la hoja práctico de usar con indicador visual
- Fácil de transportar

## EQUIPAMIENTO DE SERIE

- Varilla tope regulable, para realizar cortes en serie (L= 500mm)
- Asas para el transporte
- Circuito-filtro para la eliminación de interferencias electromagnéticas conforme con las normativas vigentes

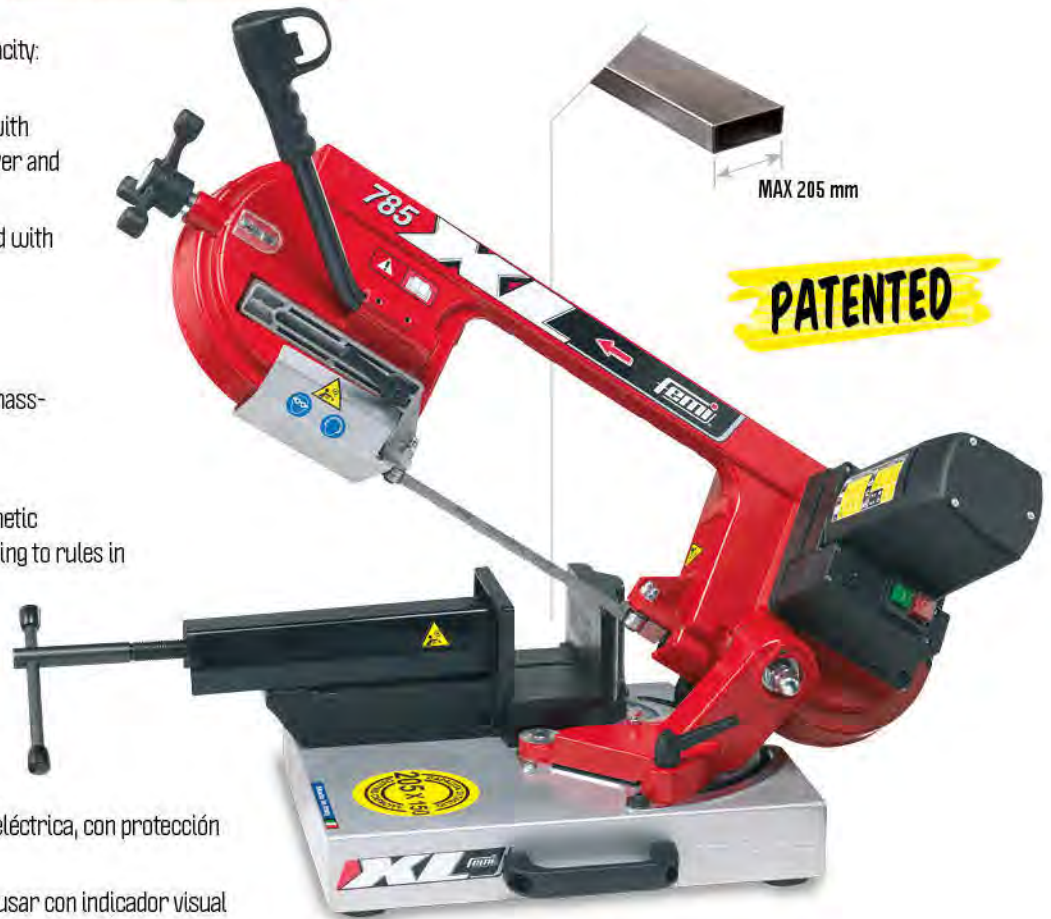

**WITHOUT LUBRICATION  
SIN LUBRICACION**

## CUTTING CAPACITY | CAPACIDAD DE CORTE

	□	∅	□
0°	205x150 mm	152 mm	150x150 mm
45°	105x95 mm	106 mm	102x102 mm



•Exclusive "roto-translating" arm system (patented)  
•Sistema exclusivo del brazo "roto-traslación" (patentado).



•Ideal for cutting large profiles like conduits and profiles  
•Ideal para el corte de grandes perfiles como los conductos y tubulares.



1600 □



1735x13x0,9



14\*



60 ÷ 80



1000x390x570



38

\*Standard bimetal cobalt blade | De serie hoja bimetálica al cobalto  
□ 230 Volt - Hz 50 single-phase motor - Motor monofásico 230 Volt - Hz 50



ART.	CODE   CÓDIGO
784 XL	8.48.50.23

### TECHNICAL FEATURES

- Innovative blade tensioning device with clutch to check and adjust the proper tensioning of the blade (patented)
- Powerful 1200 W universal motor
- Digital electronic speed regulator "Constant Speed" with amperometric limiting device
- Die-cast vice with prismatic guides
- Easy to carry: only 17 Kgs

### STANDARD EQUIPMENT

- Adjustable bar stop-rod for mass-produced cuts
- Tool for changing blade
- Filter-circuit for electromagnetic interference damping according to rules in force

### CARACTERÍSTICAS TÉCNICAS

- Innovador tensor mediante embrague para el control y la regulación del correcto tensado de la hoja (patentado)
- Potente motor universal 1200 W
- Regulación electrónica velocidad "velocidad constante", con limitador amperimétrico y protección térmica
- Mordaza moldeada a presión con guías prismáticas
- Sólo 17 kg de peso para la máxima portabilidad

### EQUIPAMIENTO DE SERIE

- Varilla tope regulable para realizar cortes en serie
- Herramienta para el cambio de la hoja
- Circuito-filtro para la eliminación de interferencias electromagnéticas conforme con las normativas vigentes



### CUTTING CAPACITY | CAPACIDAD DE CORTE

0°	120x115 mm	120 mm	119x119 mm
45°	85x70 mm	85 mm	80x80 mm



- Cutting capacity up to  $\varnothing$  120 mm and up to  $\square$  120 x 115 mm
- Capacidad de corte hasta  $\varnothing$  120 mm y hasta  $\square$  120 x 115 mm



- Powerful motor with digital electronic speed regulator
- Potente motor con regulación electrónica de velocidad



1200  $\square$



1440x13x0,65



8/12\*



30 - 80

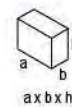

900x400x520



17

\*Standard bimetal cobalt blade | De serie hoja bimetálica al cobalto  
 $\square$  230 Volt - Hz 50 single-phase motor - Motor monofásico 230 Volt - Hz 50



### TECHNICAL FEATURES

- Easy blade tensioning device
- Powerful 950 W single phase motor with digital electronic speed regulator "Constant speed" with amperometric limiting device (ART. 783XL)
- Two speeds, electronic switch (ART. 782XL).
- Anti-reset safety function
- Steady and sturdy pressed steel base.
- Arm-locking device for easy handling.

### STANDARD EQUIPMENT

- Adjustable bar stop-rod for mass-produced cuts (L= 500mm).
- Blade cleaning felt spares kit
- Filter-circuit for electromagnetic interference damping according to rules in force.

### CARACTERÍSTICAS TÉCNICAS

- Tensor de la hoja práctico de usar
- Potente motor 950 W con regulación electrónica de velocidad "Velocidad constante", con limitador amperimétrico (ART. 783XL)
- 2 velocidades de conmutación electrónica (ART. 782XL)
- Sistema de seguridad anti-arranque.
- Base de acero fundido estable y robusta.
- Dispositivo de bloqueo arco para facilitar el transporte.

### EQUIPAMIENTO DE SERIE

- Varilla de sujeción de la barra regulable, para realizar cortes en serie (L= 500mm)
- Kit de recambio filtro de limpieza de la hoja
- Circuito-filtro para la eliminación de interferencias electromagnéticas conforme con las normativas vigentes



### CUTTING CAPACITY | CAPACIDAD DE CORTE

0°	100x85 mm	105 mm	95x95 mm
45°	65x60 mm	65 mm	65x65 mm

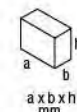

<b>782 XL</b>	950	1335x13x0,65	8/12*	60/80	730x390x500	16
<b>783 XL</b>	950	1335x13x0,65	8/12*	30 + 80	730x390x500	16

\*Standard bimetal cobalt blade | De serie hoja bimetalica al cobalto - 230 Volt - Hz 50 single-phase motor - Motor monofásico 230 Volt - Hz 50



ART.	CODE   CÓDIGO
782 XL	8.48.46.22

MAX 105 mm

**PATENTED**



ART.	CODE   CÓDIGO
783 XL	8.48.46.23

MAX 105 mm

ELECTRONIC SPEED  
REGULATION

REGULACIÓN  
ELECTRÓNICA DE  
VELOCIDAD



782 XL



783 XL

# XL 782 XL - 48 VOLT



BANDSAW 1330 - PROFESSIONAL RANGE  
SIERRA DE CINTA 1330- SERIE PROFESIONAL

ART.	CODE   CÓDIGO
782 XL - 48 VOLT	8.48.46.00

## TECHNICAL FEATURES

- 48 Volt - 560 Watt motor
- Easy blade tensioning device
- Anti reset safety function
- Cut without lubrication
- Arm locking device for an easy handling
- Thanks to 48 Volt power supply it is very suitable for:
  - shipyards or on board ship
  - underground environments

## STANDARD EQUIPMENT

- Adjustable bar stop-rod for mass-produced cuts (L= 500 mm)
- Blade cleaning felt spare kit
- Filter-circuit for electromagnetic interference damping according to rules in force

## CARACTERÍSTICAS TÉCNICAS

- Motor 48 Volt - 560 Watt
- Tensor de la hoja práctico de usar
- Sistema de seguridad anti-arranque
- Corte sin lubricación
- Dispositivo de bloqueo arco para facilitar el transporte
- Gracias a la fuente de alimentación de 48 Volt, está particularmente indicado en las siguientes aplicaciones:
  - astilleros, a bordo de los barcos y plataformas off-shore
  - ambientes subterráneos

## EQUIPAMIENTO DE SERIE

- Varilla de sujeción de la barra para realizar cortes en serie (L= 500 mm).
- Kit de recambio fieltro de limpieza de la hoja
- Circuito-filtro para la eliminación de interferencias electromagnéticas conforme con las normativas vigentes



MAX 105 mm



## CUTTING CAPACITY | CAPACIDAD DE CORTE

0°	105x93 mm	105 mm	102x102 mm
45°	105x93 mm	72 mm	68x68 mm



Thanks to 48 Volt power supply it is very suitable for:  
- shipyards or on board ship  
- underground environments

Gracias a la fuente de alimentación de 48 Volt, está particularmente indicado en las siguientes aplicaciones:  
- astilleros, a bordo de los barcos y plataformas off-shore  
- ambientes subterráneos



560



1335x13x0,65



8/12\*



70

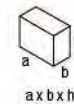

730x390x500



17

\*Standard bimetal cobalt sawblade | De serie hoja bimetálica al cobalto  
 48 Volt - Hz 50 single-phase motor - Motor monofásico 48 Volt - Hz 50

ART.	CODE   CÓDIGO
780 XL	8.48.43.21

### TECHNICAL FEATURES

- Greater cutting capacity:  $\varnothing$  105 mm
- Practical blade tensioning device
- Powerful 850W motor, 2 speeds electronically switched
- Anti-reset safety function
- Cut without lubrication
- Arm-blocking device for easy handling
- Labelling with clear cutting indications

### STANDARD EQUIPMENT

- Adjustable bar stop-rod for mass-produced cuts (L= 500 mm)
- Blade cleaning felt spare kit.
- Filter-circuit for electromagnetic interference damping according to rules in force

### CARACTERÍSTICAS TÉCNICAS

- Capacidad de corte mayor:  $\varnothing$  105 mm
- Tensor de la hoja práctico de usar
- Potente motor 850 W, dos velocidades de conmutación electrónica
- Sistema de seguridad anti-arranque
- Corte sin lubricación
- Dispositivo de bloqueo arco para facilitar transporte
- Forma gráfica con claras indicaciones de los parámetros de corte

### EQUIPAMIENTO DE SERIE

- Varilla tope regulable, para realizar cortes en serie (L= 500 mm).
- Kit de recambio filtro de limpieza de la hoja
- Circuito-filtro para la eliminación de interferencias electromagnéticas conforme con las normativas vigentes



### CUTTING CAPACITY | CAPACIDAD DE CORTE

0°	105x93 mm	105 mm	102x102 mm
45°	70x60 mm	72 mm	68x68 mm



- Maximum versatility of use
- Máxima versatilidad de uso



- Work table and goniometer kit
- Kit mesa de trabajo y goniómetro



850



1335x13x0,65



8/12\*



60/80

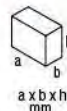

730X390X500



17



DOWNLOAD THE VIDEO  
DESCARGA EL VIDEO

\*Standard bimetal cobalt blade | De serie hoja bimetalica al cobalto - 230 Volt - Hz 50 single-phase motor - Motor monofásico 230 Volt - Hz 50

CODE  
CÓDIGO



PACK  
CAJA

**ART. 785XL-785P-785 1750**

3.28.99.25	1735x13x0,9	14*	1 pc.
3.27.99.28	1735x13x0,9	14*	5 pc.
3.28.99.24	1735x13x0,9	6/10	1 pc.
3.27.99.27	1735x13x0,9	6/10	5 pc.
3.28.99.26	1735x13x0,9	6	1 pc.
3.27.99.29	1735x13x0,9	6	5 pc.

**ART. 784XL-784 1440**

3.29.00.00	1440x13x0,65	8/12*	1 pc.
3.29.00.04	1440x13x0,65	8/12*	5 pc.
3.28.99.99	1440x13x0,65	14	1 pc.
3.29.00.03	1440x13x0,65	14	5 pc.
3.29.00.01	1440x13x0,65	6	1 pc.
3.29.00.05	1440x13x0,65	6	5 pc.
3.29.00.02	1440x13x0,65	18	1 pc.
3.29.00.06	1440x13x0,65	18	5 pc.

**ART. ABS 105-782XL-783XL-780XL-782XL 48 VOLT 1330**

3.28.99.48	1335x13x0,65	8/12*	1 pc.
3.27.99.20	1335x13x0,65	8/12*	5 pc.
3.28.99.49	1335x13x0,65	6	1 pc.
3.27.99.21	1335x13x0,65	6	5 pc.
3.28.99.18	1335x13x0,65	14	1 pc.
3.27.99.22	1335x13x0,65	14	5 pc.
3.28.99.19	1335x13x0,65	18	1 pc.
3.27.99.23	1335x13x0,65	18	5 pc.

\* Standard fitting on bandsaws - En dotación estándar en las SIERRA

**TECHNICAL FEATURES**

- Bimetal cobalt blades M42 for high cutting performance
- Suitable for dry cutting, too
- High resistance and productivity both for solid materials and for profiles
- Available in standard packs of 1 or 5 pieces

**CARACTERÍSTICAS TÉCNICAS**

- Hojas bimetálicas al cobalto M42 para elevadas prestaciones de corte
- Ideales también para cortes en seco
- Gran resistencia y productividad tanto en materiales macizos como en perfilados
- Disponibles en paquetes estándar de 1 ó 5 piezas



**"NG SYSTEM" Bimetal bandsaw blades**

Special blades ideal for use on "NG System" sawing machines

**"NG SYSTEM" Hojas de cinta bimetálicas**

Hojas específicas ideales para la utilización en SIERRA "NG SYSTEM"

CODE  
CÓDIGO



PACK  
CAJA

**ART. ABS NG160 1750**

3.28.99.65	1735x13x0,9	14*	1 pc.
3.27.99.66	1735x13x0,9	14*	5 pc.
3.28.99.63	1735x13x0,9	6/10	1 pc.
3.27.99.64	1735x13x0,9	6/10	5 pc.
3.28.99.67	1735x13x0,9	6	1 pc.
3.27.99.68	1735x13x0,9	6	5 pc.

**ART. NG160 1750**

3.28.99.63	1735x13x0,9	6/10*	1 pc.
3.27.99.64	1735x13x0,9	6/10*	5 pc.
3.28.99.65	1735x13x0,9	14	1 pc.
3.27.99.66	1735x13x0,9	14	5 pc.
3.28.99.67	1735x13x0,9	6	1 pc.
3.27.99.68	1735x13x0,9	6	5 pc.

**ART. ABS NG120-NG120XL-NG120 1440**

3.28.99.57	1440x13x0,65	14*	1 pc.
3.27.99.61	1440x13x0,65	14*	5 pc.
3.28.99.55	1440x13x0,65	8/12	1 pc.
3.27.99.59	1440x13x0,65	8/12	5 pc.
3.28.99.56	1440x13x0,65	6	1 pc.
3.27.99.60	1440x13x0,65	6	5 pc.
3.28.99.58	1440x13x0,65	18	1 pc.
3.27.99.62	1440x13x0,65	18	5 pc.

**NEW**

**ART. DSC NG 110 1330**

3.28.00.63	1335x13x0,65	14*	1 pc.
3.28.00.67	1335x13x0,65	14*	5 pc.
3.28.00.64	1335x13x0,65	8/12	1 pc.
3.28.00.68	1335x13x0,65	8/12	5 pc.
3.28.00.65	1335x13x0,65	6	1 pc.
3.28.00.69	1335x13x0,65	6	5 pc.
3.28.00.66	1335x13x0,65	18	1 pc.
3.28.00.70	1335x13x0,65	18	5 pc.

\* Standard fitting on bandsaws - En dotación estándar en las SIERRA

VARIABLE PITCH TOOTHING  
DENTADO DE PASO VARIABLE

FIXED PITCH TOOTHING  
DENTADO DE PASO FIJO

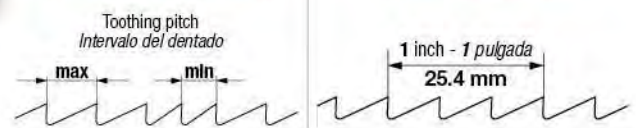

## STANDY UNIVERSAL TABLE BASE EXPOSITORA UNIVERSAL

### TECHNICAL FEATURES

- Sturdy stoved painted steel structure
- Pre-arranged to be fixed on the floor
- Maximum charge 150 Kg

### CARACTERÍSTICAS TÉCNICAS

- Robusta estructura de acero pintada en caliente
- Está adaptada para ser fijada al piso
- Max posibilidad de carga: 150 Kg



ART.	CODE   CÓDIGO
390	7.13.36.87

### FOR ART. | PARA ART.

ABS105-ABSNG160-ABSNG120-780XL-782XL  
783XL-784XL-NG160-NG120XL-785XL



a x b x h  
mm  
550X150X840



15

## JOBBY FOLDING TABLE BANCO PLEGABLE

### TECHNICAL FEATURES

- Foldable for easy handling
- Sturdy steel section structure
- Height adjustable in three positions
- Maximum charge 50 Kg

### CARACTERÍSTICAS TÉCNICAS

- Plegable para un fácil transporte
- Estructura de perfil de acero robusto
- Altura regulable en tres posiciones
- Max posibilidad de carga 50 Kg



ART.	CODE   CÓDIGO
300 PLUS	7.13.36.48

### FOR ART. | PARA ART.

ABS105-ABS NG160-ABS NG120 780XL-782XL  
783XL-784XL-NG120XL-785XL-NG160



a x b x h  
mm  
1130X490X100



11

## SINGLE-ROLLER SUPPORT SOPORTE MONO-RODILLO

### TECHNICAL FEATURES

- Zinc-plated steel roller Ø 57 mm
- Sturdy steel structure
- Base equipped with leveling feet
- Support height adjustment

### CARACTERÍSTICAS TÉCNICAS

- Rodillo de acero galvanizado Ø 57 mm
- Robusta estructura de acero, hierro fundido
- Base provista de pies de nivelación
- Regulación de la altura de apoyo



ART.	CODE   CÓDIGO
301	7.13.36.02



a x b x h  
mm  
450X450X125



6,5

## MULTY FOLDING TABLE BANCO PLEGABLE

### TECHNICAL FEATURES

- Sturdy solid aluminium structure
- Universal couple of brackets for the bandsaw and mitresaw fixing
- Possibility to electrically connect three tools
- Integrated handle for an easy transport
- Side supports extensible, height and width adjustable
- Maximum charge: 120 Kg

### CARACTERÍSTICAS TÉCNICAS

- Robusta estructura en perfilado de aluminio.
- Par de abrazaderas universales para fijar tronadoras y sierra de cinta.
- Posibilidad de conectar eléctricamente hasta 3 aparatos
- Empuñadura integrada para un fácil transporte
- Apoyos laterales extensibles, regulables en alto y ancho
- Max posibilidad de carga 120 Kg



(cod. 7.13.06.58)  
Universal brackets for fixing mitresaws and bandsaws. Additional kit on request.

Abrazaderas universales para fijar tronadoras y SIERRA de cinta. Kit adicional bajo pedido.

ART.	CODE   CÓDIGO
390	7.13.36.47

### FOR ART. | PARA ART.

780XL-782XL-783XL-784XL-NG160-NG120XL  
782XL 48Volt-ABS 105-ABS NG160-ABS NG120



a x b x h  
mm  
1235X260X290



20

## WORK TABLE KIT KIT MESA DE TRABAJO

CODE   CÓDIGO
7.07.50.65

### TECHNICAL FEATURES

- Aluminium work table with goniometer guides
- Equipped with anti-tips support
- Quick and easy assembly

### CARACTERÍSTICAS TÉCNICAS

- Mesa de aluminio con guías para goniómetro
- Apoyo contra vuelcos
- Montaje simple y rápido



## GONIOMETER FOR WORK TABLE GONIÓMETRO PARA MESA DE TRABAJO

Cutting angle adjustment 0°-60° right-left  
Regulación de ángulo 0°-60° de-iz

CODE   CÓDIGO
5.13.07.52



BELT SANDERS RANGE  
GAMA LIJADORAS DE BANDA



Bench belt  
sanders  
Lijadoras de  
banda de banco

PAG. 42



Disk sanders  
Lijadoras de disco

PAG. 44

BENCH GRINDERS RANGE  
GAMA ESMERILADORAS



Bench grinders with brake  
Esmeriladoras con freno

PAG. 45



Expert line  
Linea expert

PAG. 52

**GRINDING - POLISHING LINE SANDING | LÍNEA LIJADORAS - ESMERILADORAS PULIDORAS**



Tilting belt sanders  
Lijadoras de banda inclinable

PAG. 42



Belt/disk combined sanders  
Lijadoras combinadas banda/disco

PAG. 44



Linishers  
Lijadoras

PAG. 51



Horizontal Belt sanders  
Lijadoras de banda horizontal

**NEW**

PAG. 40



Industrial line  
Linea Industrial

PAG. 46

**NEW**

Bench grinder/Linishers  
Esmeriladora/Lijadora de banda



PAG. 50



**NEW**  
**Evo**  
DESIGN

Bench grinders/Linisher  
Esmeriladoras/Lijadora de banda

PAG. 48



Sharpening Machine  
Afiladoras

PAG. 53

# HORIZONTAL BELT SANDERS | LIJADORAS DE BANDA HORIZONTAL

## TECHNICAL FEATURES AND STANDARD EQUIPMENT

- Powerful, reliable and silent induction motor - 4000 Watt
- Three phase motor 2 speeds
- Easy and quick belt replacement
- Sturdy belt tensioning system
- Working table 460 mm x 100 mm
- Belt tensioning device
- 2 operation possibilities: on table and on support

## STANDARD FITTINGS

- Start-stop switch with anti-reset safety fitted with mushroom button
- Possibility to be connected to an extraction system
- Zirconium Sand belt - grain 60
- Electric control panel
- Adjustable accident prevention guards
- Stainless steel column

## CARACTERÍSTICAS TÉCNICAS Y EQUIPAMIENTO DE SERIE

- Motore de induccion, potente, silencioso y fiable - 4000 Watt
- Motor trifasico 2 velocidades
- Cambio practico y rapido de la banda
- Sistema robusto de tensión de la banda
- Mesa de trabajo 460 mm x 100 mm
- Dispositivo centrado de la banda
- 2 trabajos: en plano y en apoyo

## EQUIPAMIENTO DE SERIE

- Interruptor de arranque-parada con sistema de seguridad antiarranque provisto de pulsador fungiforme y de proteccion termica
- Adaptacion para equipo de aspiracion del polvo
- Banda abrasiva de zirconio - grano 60
- Cuadro de mandos electricos
- Protecciones de seguridad regulable
- Base en acero

# 577

H 960 cm INCREASED HEIGHT FOR A BETTER AND PRACTICAL USE

H 960 cm ALTURA AUMENTADA PARA USO MEJOR Y MAS PRÁCTICO



ZIRCONIUM BELT  
GRAIN 60

BANDA ABRASIVA  
DE ZIRCONIO  
GRANO 60



- Electric control panel - 2 speeds
- Cuadro de mandos electricos - 2 velocidades



- Working table 460 mm x 100 mm
- Mesa de trabajo 460 mm x 100 mm

ART.	CODE CÓDIGO	WATT	RPM	m/sec	mm x mm	mm x mm	mm	Kg
577	8.26.51.30	4.000	1400/2800	15/30	150x2000	460x180	100	90

☑ 400 Volt - Hz 50 three-phase motor | Motor trifásico 400 Volt - Hz 50



# HORIZONTAL BELT SANDERS | LIJADORAS DE BANDA HORIZONTAL

## TECHNICAL FEATURES AND STANDARD EQUIPMENT

- Powerful, reliable and silent induction motor
- Easy and quick belt replacement
- Sturdy belt tensioning system
- Working table 460 mm x 75 mm
- Belt tensioning device
- 2 operation possibilities: on table and on support

## STANDARD FITTINGS

- Start-stop switch with anti-reset safety fitted with mushroom button
- Possibility to be connected to an extraction system
- Zirconium Sand belt – grain 60
- Adjustable accident prevention guards
- Stainless steel column

## CARACTERÍSTICAS TÉCNICAS Y EQUIPAMIENTO DE SERIE

- Motore de induccion, potente, silencioso y fiable
- Cambio practico y rapido de la banda
- Sistema robusto de tensión de la banda
- Mesa de trabajo 460 mm x 75 mm
- Dispositivo centrado de la banda
- 2 trabajos: en plano y en apoyo

## EQUIPAMIENTO DE SERIE

- Interruptor de arranque-parada con sistema de seguridad antiarranque provisto de pulsador fungiforme y de proteccion termica
- Adaptacion para equipo de aspiracion del polvo
- Banda abrasiva de zirconio – grano 60
- Protecciones de seguridad regulable
- Base en acero

# 575/574

H 960 cm INCREASED HEIGHT FOR A BETTER AND PRACTICAL USE

H 960 cm ALTURA AUMENTADA PARA USO MEJORY Y MAS PRÁCTICO



ZIRCONIUM BELT  
GRAIN 60

BANDA ABRASIVA  
DE ZIRCONIO  
GRANO 60

**NEW**



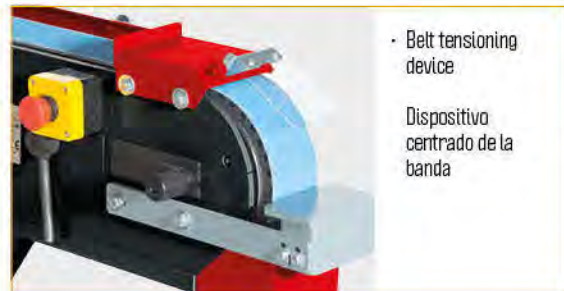

- Rubberized drive pulley
- Polea conductora de goma



- Belt tensioning device
- Dispositivo centrado de la banda

ART.	CODE CÓDIGO	 WATT	 RPM	 m/sec	 mm x mm	 mm x mm	 mm	 Kg
575	8.26.50.30	3.000	2800	30	75x2000	460x75	60	79
574	8.26.60.20	2.200	2800	30	75x2000	460x75	60	79

 230 Volt - Hz 50 single-phase motor | Motor monofásico 230 Volt - Hz 50 -  400 Volt - Hz 50 three-phase motor | Motor trifásico 400 Volt - Hz 50



542B



504B



510



388

BENCH SUPPORT (ON REQUEST)  
SOPORTE PARA EL BANCO (BAJO PEDIDO)

# BELT SANDERS - INDUSTRIAL RANGE | LIJADORAS DE BANDA - SERIE INDUSTRIAL

ART.	CODE CÓDIGO	WATT	RPM	m/sec.	mm x mm	mm x mm	a x b x h mm	Kg
<b>BENCH BELT SANDERS   LIJADORAS DE BANDA DE BANCO</b>								
510	8.26.60.31	600 [3]	2800	16	100x100	100X220	620x400x200	15
511	8.26.60.21	550 [1]	2800	16	100x100	100X220	620x400x200	15

[1] 230 Volt - Hz 50 single-phase motor | Motor monofásico 230 Volt - Hz 50 • [3] 400 Volt - Hz 50 three-phase motor | Motor trifásico 400 Volt - Hz 50

<b>TILTING BELT SANDERS   LIJADORAS DE BANDA INCLINABLE BANCO</b>								
542B	8.26.61.33	1000 [3]	1400	27	120x1500	160X410	1200x800x1600	52
543B	8.26.61.22	750 [1]	1400	27	120x1500	160X410	1200x800x1600	52
504B	8.26.61.32	600/900 [3]	1400/2800	27	120x1500	160X410	1200x800x1600	52
507B	8.26.62.32	1350/1600 [3]	1400/2800	30	150x1750	200X500	1200x800x1600	67

Assembled steel column (included) | Montadas en base de acero (de serie)

[1] 230 Volt - Hz 50 single-phase motor | Motor monofásico 230 Volt - Hz 50 • [3] 400 Volt - Hz 50 three-phase motor | Motor trifásico 400 Volt - Hz 50

## TECHNICAL FEATURES AND STANDARD EQUIPMENT

These products are aimed at industrial machining thanks to their high reliability and sturdiness

- Operation possibilities: on table, on support
- Tilting belt tale unit
- Three phase motor 2 speeds (art. 504B / art. 507B)
- Powerful, reliable and silent induction motors
- Conforming to CE Standards
- Easy and quick belt replacement

## STANDARD FITTINGS

- Electric control panel (ART. 510-511-542B-543B not included)
- Start-stop switch with anti-reset safety fitted with mushroom button
- Adjustable accident prevention guards
- Possibility to be connected to an extraction system
- Sand belt
- Stainless steel column with tool-holder shelf (art 510-511 not included)

## CARACTERÍSTICAS TÉCNICAS Y EQUIPAMIENTO DE SERIE

Productos orientados a trabajos industriales gracias a su gran fiabilidad y robustez

- Trabajos: en plano, en apoyo
- Aparato banda inclinable
- Motor trifásico 2 velocidades (art. 504B / art. 507B)
- Motores de inducción, potentes, silenciosos y fiables
- Conformes con las normativas CE
- Cambio práctico y rápido de la banda

## EQUIPAMIENTO DE SERIE

- Cuadro de mandos eléctricos (excluido ART. 510-511-542B-543B)
- Interruptor de arranque-parada con sistema de seguridad antiarranque provisto de pulsador fungiforme y de protección térmica
- Protecciones de seguridad regulable
- Adaptación para equipo de aspiración del polvo
- Banda abrasiva
- Base en acero con mesa portaobjetos (excepto art. 510-511)



ON REQUEST VERSION  
WITH EXTRACTION  
SYSTEM (ASP 050)

BAJO PEDIDO: VERSION  
CON EQUIPO  
DE ASPIRACIÓN  
INTEGRADO (ASP 050)



- Work on table
- Trabajo en plano



- Work on support
- Trabajo en apoyo

# BELT SANDERS - INDUSTRIAL RANGE | LIJADORAS DE BANDA - SERIE INDUSTRIAL

## TECHNICAL FEATURES

These products are aimed at industrial machining thanks to their high reliability and sturdiness

- Operation possibilities: on table, on support
- Tilting belt and disk tale unit
- Three phase motor 2 speed
- Powerful, reliable and silent induction motors
- Conforming to CE Standards
- Easy and quick belt replacement

## STANDARD FITTINGS

- Electric control panel
- Start-stop switch with anti-reset safety fitted with mushroom-shaped button
- Adjustable accident prevention guards
- Possibility to be connected to an extraction system
- Sand belt
- Stainless steel column with tool-holder shelf

## CARACTERÍSTICAS TÉCNICAS

Productos orientados a trabajos industriales gracias a su gran fiabilidad y robustez

- Trabajos: en plano, en apoyo
- Aparato banda inclinable
- Motor trifásico 2 velocidades
- Motores de inducción, potentes, silenciosos y fiables
- Conformes con las normativas CE
- Cambio práctico y rápido de la banda

## EQUIPAMIENTO DE SERIE

- Cuadro de mandos eléctricos
- Interruptor de arranque-parada con sistema de seguridad antiarranque provisto de pulsador fungiforme y de protección térmica
- Protecciones de seguridad regulable
- Adaptación para equipo de aspiración del polvo
- Banda abrasiva
- Base en acero con mesa portaobjetos



ART.	CODE CÓDIGO	WATT	RPM	mm/sec.	mm x mm	mm x mm	mm	mm	mm	Kg
------	-------------	------	-----	---------	---------	---------	----	----	----	----

### BELT/DISK COMBINED SANDERS | LIJADORAS COMBINADAS BANDA/DISCO

539B	8.28.62.32	1350/1600	1400/2800	30	150X1750	200X500	435X200	400	90°-135°	81
------	------------	-----------	-----------	----	----------	---------	---------	-----	----------	----

Assembled steel column (included) | Montadas en base de acero (de serie) - 400 Volt - Hz 50 three-phase motor | Motor trifásico 400 Volt - Hz 50

### DISK SANDERS WITH TILTING TABLE | LIJADORAS DE DISCO CON MESA INCLINABLE

525B	8.27.62.32	1350/1600	1400/2800	-	-	-	435X200	400	90°-135°	52
------	------------	-----------	-----------	---	---	---	---------	-----	----------	----

Assembled steel column (included) | Montadas en base de acero (de serie) - 400 Volt - Hz 50 three-phase motor | Motor trifásico 400 Volt - Hz 50

# BENCH GRINDERS WITH BRAKE ESMERILADORAS CON FRENO

All FEMI bench grinders, both with single phase and three-phase motor, can be delivered (upon request) in version with electronic PCB with brake. The braking allows the machine to stop smoothly and in the maximum working safety.

Todas las esmeriladoras FEMI sea con motor monofasico que trifasico pueden ser entregadas (bajo pedido) en version con cuadro electrónico y tarjeta de frenado. El frenado garantiza una parada sin tirones en la máxima seguridad de utilización.

### TECHNICAL FEATURES:

- Control panel complete with braking PCB with integrated protection fuse.
- Safety emergency stop button (class 2)
- Braking time from 4 to 8 seconds
- Anti-reset function

### CARACTERISTICAS TECNICAS:

- Cuadro de mandos con tarjeta de frenado con fusible de protección integrado
- Pulsador de seguridad por parada de emergencia (class 2)
- Tiempo de frenado de 4 hasta 8 segundos
- Función antireset



CODE	DESCRIPTION	FOR ARTICLES
7.80.02.75	<b>BRAKE</b> kit for three phase bench grinders > = 450W Kit para esmeriladoras trifasicas > = 450W	241-241/M - 243-243/M - 245-245/M - 247-247/M - 214-191-191/M 192-192/M - 196-196/M - 197-197/M - 204
7.80.02.76	<b>BRAKE</b> kit for three phase bench grinders 1100/1500 W Kit para esmeriladoras trifasicas 1100/1500 W	143-143/M - 145-145/M-163-163/M- 165-165/M - 209-193-193/M 194-194/M- 198-198/M-199-199/M-202- and/∅ EVO models
7.80.02.77	<b>BRAKE</b> kit for three phase bench grinders 2200 W Kit para esmeriladoras trifasicas 2200W	146-146/M-166-166/M-211-195-195/M- 200-203 and/∅ EVO models
7.80.02.79	<b>BRAKE</b> kit for single phase bench grinders < = 750W Kit para esmeriladoras trifasicas < = 750W	240-240/M-242-242/M-244-244/M-246-246/M-213



## 145/M EVO

NEW  
**Evo**  
DESIGN



## 243/M

### RANGE OF DOUBLE GRINDING WHEEL BENCH GRINDERS

Sturdy and reliable are suitable for roughing-out operations and for removal of material. They can be equipped with grinding wheels of different grits.

### GAMA DE ESMERILADORAS DE DOBLE MUELA

Robustas y fiables, están indicadas para operaciones de desbastado de material. Pueden estar provistas de muelas abrasivas con grano diferenciado.



## 165/M EVO

### RANGE OF COMBINED BENCH GRINDERS (GRINDING WHEEL/BRUSH)

In addition to the features of the double grinding wheel, these bench grinders also shave and polish the workpieces. Possibility of assembling various types of grinding wheels and brushes.

### GAMA DE ESMERILADORAS COMBINADAS (MUELA/CEPILLO)

A las características de la doble muela se añade la funcionalidad para las operaciones de desbarbado y pulido de piezas. Están adaptadas para el montaje de muelas y cepillos de diferente tipo.



## 211















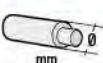

























### RANGE OF POLISHING MACHINES



Ideal for use at an industrial level in the metal deburring and polishing sector. Possibility of assembling different types or brushes (metal wire or in fabric fibre, etc.).

### GAMA DE PULIDORAS

Ideales para el uso a nivel industrial en el campo del desbarbado y pulido de metales. Están adaptadas para el montaje de cepillos de diferente tipo (filamento metálico o de fibra de tejido, etc.).

# BENCH GRINDERS/POLISHERS- INDUSTRIAL RANGE | ESMERILADORAS/PULIDORAS - SERIE INDUSTRIAL

ART.	CODE CÓDIGO	 WATT	 Ø mm	 Ø mm	 RPM	 mm	 mm	 a x b x h mm	 Kg
<b>RANGE OF DOUBLE GRINDING WHEEL BENCH GRINDERS (WITH GRINDING WHEELS)   GAMA DE ESMERILADORAS DE DOBLE MUELA (PROVISTAS DE MUELAS)</b>									
240/M	8.01.31.21	450 	150x20x16	-	2800	-	-	520x210x320	11
241/M	8.01.32.31	450 	150x20x16	-	2800	-	-	520x210x320	11
242/M	8.01.33.21	750 	200x25x20	-	2800	-	-	570x290x340	18
243/M	8.01.34.31	850 	200x25x20	-	2800	-	-	570x290x340	18
143/M EVO	8.01.35.32	1100 	200x30x20	-	2800	-	-	690x280x360	22
145/M EVO	8.01.36.32	1500 	250x35x25	-	1400	-	-	720x340x420	32
146/M	8.01.87.31	2200 	300x40x30	-	1400	-	-	770x470x760	64
<b>RANGE OF DOUBLE GRINDING WHEEL BENCH GRINDERS (GRINDING WHEELS NOT INCLUDED)   GAMA DE ESMERILADORAS DE DOBLE MUELA (MUELAS NO INCLUIDAS)</b>									
240	8.01.11.21	450 	150x20x16	-	2800	-	-	520x210x320	9
241	8.01.12.31	450 	150x20x16	-	2800	-	-	520x210x320	9
242	8.01.13.21	750 	200x25x20	-	2800	-	-	570x290x340	14
243	8.01.14.31	850 	200x25x20	-	2800	-	-	570x290x340	14
143 EVO	8.01.15.32	1100 	200x30x20	-	2800	-	-	690x280x360	18
145 EVO	8.01.16.32	1500 	250x35x25	-	1400	-	-	720x340x420	27
146	8.01.67.31	2200 	300x40x30	-	1400	-	-	770x470x760	56
<b>RANGE OF COMBINED BENCH GRINDERS (COMPLETE WITH GRINDING WHEEL - BRUSH NOT INCLUDED)   GAMA DE ESMERILADORAS COMBINADAS (PROVISTAS DE MUELA - SIN CEPILLO)</b>									
244/M	8.02.31.22	450 	150x20x16	150x25x16	2800	16	90	520x210x320	11
245/M	8.02.32.32	450 	150x20x16	150x25x16	2800	16	90	520x210x320	11
246/M	8.02.33.21	750 	200x25x20	200x25x16	2800	16	90	570x290x340	16
247/M	8.02.34.31	850 	200x25x20	200x25x16	2800	16	90	570x290x340	16
163/M EVO	8.02.35.31	1100 	200x30x20	200x30x20	2800	20	130	690x280x360	24
165/M EVO	8.02.36.32	1500 	250x35x25	250x30x20	1400	20	135	720x340x420	30
166/M	8.02.87.31	2200 	300x40x30	300x35x25	1400	25	190	1000x400x760	60
<b>RANGE OF COMBINED BENCH GRINDERS (WHEEL AND BRUSH NOT INCLUDED)   GAMA DE ESMERILADORAS COMBINADAS (MUELA Y CEPILLO NO INCLUIDOS)</b>									
244	8.02.11.22	450 	150x20x16	150x25x16	2800	16	90	520x210x320	10
245	8.02.12.32	450 	150x20x16	150x25x16	2800	16	90	520x210x320	10
246	8.02.13.21	750 	200x25x20	200x25x16	2800	16	90	570x290x340	14
247	8.02.14.31	850 	200x25x20	200x25x16	2800	16	90	570x290x340	14
163 EVO	8.02.15.32	1100 	200x30x20	200x30x20	2800	20	130	690x280x360	20
165 EVO	8.02.16.32	1500 	250x35x25	250x30x20	1400	20	135	720x340x420	22
166	8.02.67.31	2200 	300x40x30	300x30x25	1400	25	190	1000x400x760	54
<b>RANGE OF POLISHING MACHINES (BRUSHES NOT INCLUDED)   GAMA DE PULIDORAS (CEPILLOS NO INCLUIDOS)</b>									
213	8.04.13.21	750 	-	200x25x16	2800	16	90	630x240x320	14
214	8.04.14.31	850 	-	200x25x16	2800	16	90	630x240x320	14
209 EVO	8.04.15.32	1100 	-	250x30x20	2800	20	135	850x290x390	27
211	8.04.57.31	2200 	-	300x35x25	2800	25	190	1200x400x760	50

 230 Volt - Hz 50 single-phase motor | Motor monofásico 230 Volt - Hz 50 ·  400 Volt - Hz 50 three-phase motor | Motor trifásico 400 Volt - Hz 50

## TECHNICAL FEATURES AND STANDARD EQUIPMENT

- These products are suitable for industrial purposes
- 5 years warranty
- Powerful, reliable and silent induction motors
- Integrated safety thermal protection (for motors > 500 W)
- According to CE Standards
- Complete with accident prevention guards and suction fittings
- Switch with anti-reset safety function and padlockable mushroom button
- Standard control panel and cast iron body (ART. 146-146/M-166-166/M-211)

## CARACTERÍSTICAS TÉCNICAS Y EQUIPAMIENTO DE SERIE

- Productos orientados a trabajos industriales gracias a su gran robustez
- 5 años de garantía
- Potentes motores de inducción, fiables y silenciosos
- Protección térmica de seguridad integrada (para motores > 500 W).
- Conformes con las normativas CE
- Provistas de protección para prevención de accidentes y toma para aspiración
- Provistas de interruptor arranque-parada con sistema de seguridad anti-arranque y pulsador fungiforme con posibilidad de bloqueo
- Cuadro de mandos de serie y cuerpo de hierro fundido (ART.146-146/M-166-166/M-211)



## 199/M EVO

### RANGE OF COMBINED ECOLOGICAL BENCH GRINDERS

In addition to the features of the double grinding wheel, these bench grinders also deburring and polish the workpieces.

Possibility of assembling various types of grinding wheels and brushes.

### GAMA DE ESMERILADORAS COMBINADAS ECOLÓGICAS

A las características de la doble muela se añade la funcionalidad para operaciones de desbarbado y pulimento de piezas.

Están adaptadas para el montaje de muelas y cepillos de diferente tipo.



**NEW**  
**EVO**  
DESIGN

## 192/M

### RANGE OF DOUBLE GRINDING WHEEL ECOLOGICAL BENCH GRINDER

Designed with a view to fully comply with workplace health and safety regulations thanks to the extraction system provided, built-into the base.

They can be equipped with grinding wheels with different grits.

### GAMA DE ESMERILADORAS ECOLÓGICAS DE DOBLE MUELA

Concebidas en el total respeto de las normas de seguridad e higiene del ambiente de trabajo, gracias a la presencia del sistema de aspiración integrado en la base. Pueden estar provistas de muelas abrasivas con grano diferenciado.



## 203

### RANGE OF ECOLOGICAL POLISHING MACHINES

Designed for industrial polishing operations fully complying with safety and environmental regulations. Possibility of assembling different types of brushes (metal wire, etc.).







### GAMA DE PULIDORAS ECOLÓGICAS

Concebidas para operaciones de pulimento industrial con pleno respeto de la seguridad y del ambiente.

Están adaptadas para el montaje de cepillos de diferente tipo (filamento metálico, etc.).



# ECOLOGICAL BENCH GRINDERS - INDUSTRIAL RANGE | ESMERILADORAS ECOLÓGICAS - SERIE INDUSTRIAL

ART.	CODE CÓDIGO	 WATT	 Ø mm	 Ø mm	 RPM	 mm	DUST COLLECTOR ASPIRADOR	 Kg
<b>RANGE OF DOUBLE GRINDING WHEEL ECOLOGICAL BENCH GRINDERS (WHEELS INCLUDED)   GAMA DE ESMERILADORAS ECOLÓGICAS DE DOBLE MUELA (PROVISTAS DE MUELAS)</b>								
191/M	8.00.31.31	450 	150x20x16	-	2800	-	ASP 020	34
192/M	8.00.33.31	850 	200x25x20	-	2800	-	ASP 020	38
193/M EVO	8.00.35.32	1100 	200x30x20	-	2800	-	ASP 020	48
194/M EVO	8.00.39.32	1500 	250x35x25	-	1400	-	ASP 020	55
195/M	8.00.43.31	2200 	300x40x20	-	1400	-	ASP 020	93
<b>RANGE OF COMBINED ECOLOGICAL BENCH GRINDERS (GRINDING WHEELS NOT INCLUDED)   GAMA DE ESMERILADORAS ECOLÓGICAS DE DOBLE MUELA (MUELAS NO INCLUIDAS)</b>								
191	8.00.30.31	450 	150x20x16	-	2800	-	ASP 020	29
192	8.00.32.31	850 	200x25x20	-	2800	-	ASP 020	34
193 EVO	8.00.34.32	1100 	200x30x20	-	2800	-	ASP 020	39
194 EVO	8.00.38.32	1500 	250x35x25	-	1400	-	ASP 020	46
195	8.00.13.31	2200 	300x40x20	-	1400	-	ASP 020	85
<b>RANGE OF COMBINED ECOLOGICAL BENCH GRINDERS (COMPLETE WITH GRINDING WHEEL - BRUSH NOT INCLUDED)   GAMA DE ESMERILADORAS COMBINADAS ECOLÓGICAS (PROVISTAS DE MUELA - CEPILLO NO INCLUIDOS)</b>								
196/M	8.00.51.32	450 	150x20x16	150x25x16	2800	90	ASP 020	32
197/M	8.00.53.31	850 	200x25x20	200x25x16	2800	90	ASP 020	37
198/M EVO	8.00.55.32	1100 	200x30x20	200x30x20	2800	130	ASP 020	47
199/M EVO	8.00.59.32	1500 	250x35x25	250x30x20	1400	135	ASP 020	52
200/M	8.00.63.31	2200 	300x40x30	300x35x30	1400	190	ASP 020	91
<b>RANGE OF COMBINED ECOLOGICAL BENCH GRINDERS (WHEEL AND BRUSH NOT INCLUDED)   GAMA DE ESMERILADORAS COMBINADAS ECOLÓGICAS (MUELA Y CEPILLO NO INCLUIDOS)</b>								
196	8.00.50.32	450 	150x25x16	150x25x16	2800	90	ASP 020	30
197	8.00.52.31	850 	200x25x20	200x25x16	2800	90	ASP 020	36
198 EVO	8.00.54.32	1100 	200x30x20	200x30x20	2800	130	ASP 020	41
199 EVO	8.00.58.32	1500 	250x35x25	250x30x20	1400	135	ASP 020	48
200	8.00.18.31	2200 	300x40x30	300x35x25	1400	190	ASP 020	87
<b>RANGE OF ECOLOGICAL POLISHING MACHINES (BRUSHES NOT INCLUDED)   GAMA DE PULIDORAS ECOLÓGICAS (CEPILLOS NO INCLUIDOS)</b>								
204	8.00.71.31	850 	-	200x25x16	2800	90	ASP 020	34
202 EVO	8.00.72.32	1100 	-	250x30x20	2800	135	ASP 020	49
203	8.00.29.31	2200 	-	300x35x25	2800	190	ASP 020	98

 400 Volt - Hz 50 three-phase motor | Motor trifásico 400 Volt - Hz 50

## TECHNICAL FEATURES AND STANDARD EQUIPMENT

Products suitable for industrial purposes thanks to their high reliability and sturdiness

- Three-phase electric motor equipped with safety thermal protection (for motors > 500 w)
- Standard integrated dust extractor
- 5 years warranty
- Equipped with removable water reservoir, built-in suction system fit with self-extinguishing filter-bag
- Powerful, reliable and silent induction motors
- According to CE Standards
- Complete with accident prevention guards
- START-STOP switch with anti-reset safety function and padlockable mushroom-shaped button
- Standard control panel and cast iron body (ART.195, 195/M, 200, 200/M, 203)

## CARACTERÍSTICAS TÉCNICAS Y EQUIPAMIENTO DE SERIE

Productos orientados a trabajos industriales gracias a su gran fiabilidad y robustez

- Motores eléctricos trifásicos provistos de protección térmica de seguridad (para motores > 500 w)
- Equipo de aspiración integrado de serie
- 5 años de garantía
- Potentes motores de inducción, fiables y silenciosos
- Conformes con las normativas CE
- Provistas de protección para prevención de accidentes y toma para aspiración
- Provistas de interruptor arranque-parada con sistema de seguridad anti-arranque y pulsador fungiforme con posibilidad de bloqueo
- Cuadro de mandos de serie y cuerpo de hierro fundido (ART.146-146/M-166-166/M-211)

**294N**  
**293N**  
**NEW**



**BENCH GRINDERS/LINISHERS**

Sturdy and reliable, this article combines the versatility of the linishers to the traditional grinding wheel.

**ESMERILLADORAILIJADORA DE BANDA**

Robusta y fiable, une a la tradicional muela abrasiva, la versatilidad de las lijadoras de banda.



**TECHNICAL FEATURES AND STANDARD EQUIPMENT**

Reliable products suitable for industrial purposes owing to the high quality components used.

- 5 years warranty
- Possibility to work both on the table and on the rubber-coated wheel
- Powerful and silent motors equipped with safety thermal protection
- According to CE Standards
- START-STOP switch with anti-reset safety function and padlockable mushroom-shaped button
- Easy and practical belt replacement
- Tilting belt unit
- Adjustable accident prevention guards equipped with suction fitting
- Complete with grinding wheel and sand belt

**CARACTERISTICAS TÉCNICAS Y EQUIPAMIENTO DE SERIE**

- Productos fiables orientados a trabajos industriales gracias a la gran calidad de los componentes utilizados
- 5 años de garantía
- Trabajos en la mesa de apoyo y sobre la polea de goma
- Motores potentes y silenciosos provistos de protección térmica de seguridad
- Conformes con las normativas CE
- Provistos de interruptor arranque-parada con sistema de seguridad anti-arranque y pulsador fungiforme con posibilidad de bloqueo
- Sustitución práctica y rápida de la banda
- Aparato banda inclinable
- Protecciones de seguridad regulables provistas de unión para aspiración
- Provistas de muelas y bandas abrasivas

ART.	CODE CÓDIGO	WATT	RPM	mm x mm	Ø mm
294N	8.07.10.31	850	2800	100x1000	200x25x20
293N	8.07.10.21	750	2800	100x1000	200x25x20

• Column ART.303 available on request | Base Art.303 disponible bajo pedido  
 400 Volt - Hz 50 three-phase motor | Moteur triphasée 400 Volt-Hz 50 | Motor trifásico 400 Volt-Hz50  
 230 Volt -Hz 50 single-phase motor | Moteur monophasée 230 Volt-Hz 50 | Motor monofásico 230 Volt-Hz50





**NEW**  
**Evo**  
DESIGN

**TECHNICAL FEATURES AND STANDARD EQUIPMENT**

Reliable products suitable for industrial purposes owing to the high quality components used.

- 5 years warranty
- Possibility to work both on the table and on the rubber-coated wheel
- Powerful and silent motors equipped with safety thermal protection
- According to CE Standards
- START-STOP switch with anti-reset safety function and padlockable mushroom-shaped button
- Easy and practical belt replacement
- Tilting belt unit
- Adjustable accident prevention guards equipped with suction fitting
- Complete with grinding wheels and sand belts

**CARACTERÍSTICAS TÉCNICAS Y EQUIPAMIENTO DE SERIE**

Productos fiables orientados a trabajos industriales gracias a la gran calidad de los componentes utilizados

- 5 años de garantía
- Trabajos en la mesa de apoyo y sobre la polea de goma
- Motores potentes y silenciosos provistos de protección térmica de seguridad
- Conformes con las normativas CE
- Provistas de interruptor arranque-parada con sistema de seguridad anti-arranque y pulsador fungiforme con posibilidad de bloqueo
- Sustitución práctica y rápida de la banda
- Aparato banda inclinable
- Protecciones de seguridad regulables provistas de unión para aspiración
- Provistas de muelas y bandas abrasivas

**296 EVO**

**BENCH GRINDERS/LINISHERS**

Sturdy and reliable, this article combines the versatility of the linishers to the traditional grinding wheel.

**ESMERILADORA/LIJADORA DE BANDA**

Robusta y fiable, une a la tradicional muela abrasiva, la versatilidad de las lijadoras de banda.



**298 EVO**

**LINISHERS**

Equipped with different grits belt equipment and mobile surrounding guards. Its ideal use is for shaving operations and foundry casting treatment owing to the high peripheral speed of the belt.

**LIJADORA DE BANDA**

Provista de banda de lija de grano diferenciado, está equipada con protecciones integrales móviles. Es sumamente adecuada para las operaciones de desbarbado y tratamiento de fundiciones gracias a la elevada velocidad periférica de la banda.



**303**

**COLUMN (ON REQUEST)  
BASE (BAJO PEDIDO)**

**BENCH GRINDER/LINISHERS | ESMERILADORA/LIJADORA DE BANDA**

296* EVO	8.06.10.32	1100 [3]	2800	50x2200	200X25x20
----------	------------	----------	------	---------	-----------

**LINISHER | LIJADORA DE BANDA**

298* EVO	8.06.11.31	1100 [3]	2800	50x2200	-
----------	------------	----------	------	---------	---

\* Column ART.303 available on request | Base ART.303 disponible bajo pedido  
[3] 400 Volt - Hz 50 three-phase motor | Motor trifásico 400 Volt - Hz 50



# EXPERT BENCH GRINDERS - PROFESSIONAL RANGE | ESMERILADORAS EXPERT - SERIE PROFESIONAL



## 404

BENCH GRINDERS DOUBLE WHEEL Ø 150  
ESMERILADORAS DOBLE MUELA Ø 150



## 405

BENCH GRINDERS DOUBLE WHEEL Ø 200  
ESMERILADORAS DOBLE MUELA Ø 200



## 424

COMBINED BENCH GRINDERS Ø 150  
ESMERILADORAS COMBINADAS Ø 150



## 425

COMBINED BENCH GRINDERS Ø 200-150  
ESMERILADORAS COMBINADAS Ø 200-150

### TECHNICAL FEATURES

- Reliable and silent induction motors
- Equipped with accident prevention guards and suction fitting (not contemplated for ART. 404-424)
- Equipped with START-STOP switch with anti-reset safety function
- Complete with grinding wheels and steel brushes (ART. 424 and 425)
- Possibility of being applied to the steel column ART. 303

### CARACTERÍSTICAS TÉCNICAS

- Motores de inducción, fiables y silenciosos
- Provistas de protecciones para prevención de accidentes y unión para aspiración (no previsto para ART. 404 y 424)
- Provistas de interruptor arranque-parada con sistema de seguridad anti-arranque
- Equipadas con muelas abrasivas y cepillos de acero (ART. 424 y 425)
- Adaptadas para aplicaciones sobre base de acero ART. 303

ART.	CODE CÓDIGO	WATT	Ø mm	Ø mm	RPM	a x b x h mm	Kg
404	8.01.54.20	370	150x20x16	-	2800	520x210x320	10
405	8.01.56.20	500	200x20x16	-	2800	570x290x340	15
424	8.02.54.20	370	150x20x16	150x20x16	2800	520x210x320	12
425	8.02.56.20	500	200x20x16	150x20x16	2800	520x290x340	15

□ 230 Volt - Hz 50 single-phase motor | Motor monofásico 230 Volt - Hz 50

ART.	CODE   CÓDIGO
182 PLUS	8.13.23.21

## 182 PLUS



### COMBINED SHARPENING MACHINE

Machine equipped with two grinding wheels that rotate at differentiated speed; grinding wheel suitable for all the common grinding and shaving operations; slow-turning water bath sharpening wheel for sharpening scissors, knives, chisels and blades in general.

#### TECHNICAL FEATURES

- Reliable and silent induction motors
- Conforming to CE Standards

#### STANDARD EQUIPMENT

- Accident prevention guards
- Wheel wiper brush
- High quality white corundum sharpening unit with large grinding wheel
- Sharpening and grinding wheels

### AFILADORA COMBINADA

Máquina provista de dos muelas coaxiales giratorias de velocidad diferenciada; muela esmeriladora apta para todas las operaciones de esmerilado y desbarbado; muela afiladora de vueltas lentas en baño de agua que permite afilar tijeras, cuchillos, cinceles y todo tipo de hoja en general.

#### CARACTERÍSTICAS TÉCNICAS

- Motores de inducción, fiables y silenciosos
- Conforme con las normativas CE

#### EQUIPAMIENTO DE SERIE

- Protecciones para prevención de accidentes
- Cepillo limpiamuela
- Grupo de afilado con muela de grandes dimensiones de corindón blanco fino
- Muela esmeriladora



500 WATT 150x20x16 Ø mm 2800 RPM 180x30x20 Ø mm 200 RPM 400x255x250 a x b x h mm 10 Kg

□ 230 Volt - Hz 50 single-phase motor  
Motor monofásico 230 Volt - Hz 50

ART.	CODE   CÓDIGO
177	8.13.22.21

## 177



### WATER-OPERATED SHARPENING MACHINE

Single-wheel professional sharpening machine with ABS shockproof structure equipped with high quality white corundum wheel partially soaked in water for the perfect sharpening of all types of blades and cutting tools

#### TECHNICAL FEATURES AND STANDARD FITTINGS

- Reliable and silent induction motor.
- High quality white corundum sharpening wheel.
- Double safety insulation.

### AFILADORA DE AGUA

Afiladora profesional mono-muela con estructura de ABS antichoque provista de muela de corindón fino blanco parcialmente sumergido en agua para garantizar el perfecto afilado de todos los tipos de hojas y herramientas de corte.

#### CARACTERÍSTICAS TÉCNICAS Y EQUIPAMIENTO DE SERIE

- Motor de inducción, fiable y silencioso.
- Muela afiladora de corindón blanco fino.
- Doble aislamiento de seguridad.



150 WATT 200x40x20 Ø mm 120 RPM 425x275x270 a x b x h mm 6,5 Kg

□ 230 Volt - Hz 50 single-phase motor  
Motor monofásico 230 Volt - Hz 50

# COLUMNS | BASES



**303**



**308N**

**338**



### TECHNICAL FEATURES

Sturdy column in pressed and shaped steel fitter with removable water reservoir for tool cooling (Art. 303).

### CARACTERÍSTICAS TÉCNICAS

Robusta base de acero estampado y perfilado provista de recipiente para agua, desmontable para el enfriamiento de las herramientas (Art. 303).

ART	CODE   CÓDIGO	FOR ARTICLES   PARA ARTICULOS
303	7.13.35.06	143-143/M-145-145/M-163-163/M-165-165/M-208-209-213-214-240-240M - 241-241/M-242-242/M-243-243/M-244-244/M-245-245/M-246-246/M - 247-247/M-282-296-298-404-405-424-425 + EVO models
304	7.13.35.07	146-146/M-166-166/M-211
338	7.13.36.50	510-511
308N	7.13.35.83	All belt sanders   Todos las lijadoras



### CONTROL PANEL - ULTRA-LOW TENSION (24 V) | CUADRO DE MANDOS - DE BAJÍSIMA TENSIÓN (24 V)

CODE   CÓDIGO	DESCRIPTION   DESCRIPCIÓN
7.80.02.27	For bench grinders W 450-850   Para esmeriladoras W 450-850
7.80.02.30	For bench grinders W 1100-1500   Para esmeriladoras W 1100-1500
7.80.02.31	For bench grinders W 2200   Para esmeriladoras W 2200
7.80.02.32	For 1-speed belt sanders   Para lijadoras 1 velocidad
7.80.02.29	For 2-speed belt sanders   Para lijadoras 2 velocidades

The control panel is equipped with a 24-volt transformer, magnetothermal circuit breaker, emergency mushroom-shaped button, start/stop buttons and power LED. IP 55 insulation class. Complete with support for assembly operations. Particularly suitable for technical schools, public bodies and industries for absolute safety.

Cuadro de mandos provisto de transformador 24 V, interruptor magnetotérmico, pulsador fungiforme de emergencia, pulsadores de marcha/parada y testigo luminoso de tensión. Grado de protección IP 55. Provisto de soporte para el montaje. Especialmente adecuado para institutos técnicos, entes estatales e industriales por la absoluta seguridad.







### CONTROL PANEL | CUADRO DE MANDOS

CODE   CÓDIGO	DESCRIPTION   DESCRIPCIÓN
7.80.02.07	Control panel for bench grinders W 450 - 750 Cuadro de mandos para esmeriladoras 450 - 750 W <span style="float: right;">□ 230 Volt - Hz 50</span>
7.80.02.08	Control panel for bench grinders W 450 - 850 Cuadro de mandos para esmeriladoras 450 - 850 W <span style="float: right;">□ 400 Volt - Hz 50</span>
7.80.02.09	Control panel for bench grinders W 1100 - 1500 Cuadro de mandos para esmeriladoras 1100 - 1500 W <span style="float: right;">□ 400 Volt - Hz 50</span>
7.80.02.13	For belt sanders   Para lijadoras 510 - 542b
7.80.02.16	For belt sanders   Para lijadoras 511 - 543b

Control panel equipped with magnetothermal circuit breaker and emergency mushroom-shaped button. Insulation class. Complete with support for assembly operations.

Cuadro de mandos provisto de interruptor magnetotérmico y pulsador fungiforme de emergencia. Grado de protección IP 55. Provisto de soporte para el montaje.

ART.	CODE CÓDIGO	WATT	M <sup>3</sup> /h	press. mm H <sub>2</sub> O	Ø mm	FOR ART.   PARA ART.
<b>CENTRIFUGAL DUST COLLECTORS   ASPIRADORES CENTRIFUGOS</b>						
ASP 020	7.11.20.10 7.11.20.51*	150 	410	95	35	143-143/M-145-145/M-146-146/M-163-163/M-165-165/M-166-166/M 208-209-211-213-214-240-240/M-241-241/M-242-242/M-243-243/M 244-244/M-245-245/M-246-246/M-247-247/M- 282-296-298-510-511 + EVO models
<b>NEW</b>						
ASP 020	7.11.20.57	150 	410	95	35	577 - 575
	7.11.20.58		410	95	35	574
ASP 050	7.11.20.12 7.11.20.52*	370 	980	120	90	542B-543B-504B-505B-507B-522B-525B-534B-535B 536B-537B-539B-502-503-504

\* Delivered installed on the column (column non included) - Provistos de montaje en la base de la máquina (base no incluida)  
 400 Volt - Hz 50 three-phase motor - Motor trifásico 400 Volt - Hz 50

**CENTRIFUGAL DUST COLLECTORS\***

Suitable for extracting metallic dust coming from the grinding, sanding and polishing processes. Complete with coupling flange for being assembled onto columns 303 and 304 (bench grinders) and 308/N (belt sanders). Fitted with filter bag made of self-extinguishing fabric. Version ASP 020 is provided with 2 suction air inlets for pipes Ø 35 (450 W - 750 W - 1100 W - 1500 W bench grinders). Inlets are also available for pipes with Ø 50 (2200 W bench grinders) and Ø 60 (polishing machines). All the suction inlets in the ASP 050 version are for pipes Ø 90 (belt sanders). \*THREE-PHASE 400 VOLT - STANDARD - SINGLE PHASE 230 VOLT - ON REQUEST



**ASPIRADORES CENTRIFUGOS\***

Aptos para la aspiración y la recogida de polvos metálicos provenientes de trabajos de esmerilado, lijado y pulido. Provistos de brida de acoplamiento para el montaje sobre las bases 303, 303E y 304 (esmeriladoras) y 308/N (lijadoras). Con bolsa filtro recogedor de hebra autoextinguible. En la versión ASP. 020 están incluidas dos bocas de aspiración para tubos Ø 35 (esmeriladoras 450 W - 750 W - 1100 W - 1500 W). También están disponibles bocas para tubos Ø 50 (esmeriladoras 2200 W) y Ø 60 (pulidoras). En la versión ASP 050 las bocas de aspiración son todas para tubo de Ø 90 (lijadoras). \*TRIFÁSICO 400 VOLT - DE SERIE - MONOFÁSICO 230 VOLT - BAJO PEDIDO

**DUST FILTER-BAGS. IN SELF-EXTINGUISHING FABRIC  
 BOLSAS-FILTRO DE RECOGIDA DEL POLVO. DE MATERIAL AUTOEXTINGUIBLE**

CODE CÓDIGO	FOR ARTICLES PARA ARTICULOS
5.07.32.05	ASP 020
5.07.32.06	ASP 050



**ADAPTERS | BOCAS ASPIRACIÓN**

CODE CÓDIGO	FOR PIPES Ø mm PARA TUBOS Ø mm	FOR ARTICLES PARA ARTICULOS
5.24.13.28	35	ASP 020
5.24.13.20	50	ASP 020
5.24.13.21	60	ASP 020





**ALUMINIUM PIPES FOR DUST COLLECTORS  
 TUBOS DE ALUMINIO PARA ASPIRADORES**

CODE CÓDIGO	Ø mm	Minimum order (mt) Pedido mínimo (mt)
1.95.35.01	35	3
1.95.50.01	50	3
1.95.60.01	60	3
1.95.90.02	90	3
1.95.99.02	100	3



# GRINDING WHEELS, BRUSHES AND BELTS | MUELAS, CEPILLOS Y BANDAS

## WHEELS, SAND BELT SAND BRUSHES FOR INDUSTRIAL RANGE | MUELAS, BANDAS ABRASIVAS CEPILLOS PARA SERIE INDUSTRIAL

CODE CÓDIGO	 Ø mm	 Ø mm	 mm x mm	GRAIN GRANO	PIECES NR. PIEZAS N°	FOR ART.   PARA ART
<b>IN SINGLE PACK - EN PAQUETE UNITAR</b>						
3.22.99.23	150x20x16/12*/12,7*	-	-	36	1	191-191/M-196-196/M-240-240/M-241-241/M-244-244/M-245-245/M
3.22.99.24	150x20x16/12*/12,7*	-	-	60	1	191-191/M-196-196/M-240-240/M-241-241/M-244-244/M-245-245/M
3.22.99.30	200x25x20	-	-	36	1	192-192/M-197-197/M-242-242/M-243-243/M-246-246/M-247-247/M-296
3.22.99.31	200x25x20	-	-	60	1	192-192/M-197-197/M-242-242/M-243-243/M-246-246/M-247-247/M-296
3.22.99.32	200x30x20	-	-	36	1	143-143/M-163-163/M-193-193/M-198-198/M
3.22.99.33	200x30x20	-	-	60	1	143-143/M-163-163/M-193-193/M-198-198/M
3.22.12.61	250x35x25	-	-	36	1	145-145/M-165-165/M-194-194/M-199-199/M
3.22.13.59	250x35x25	-	-	60	1	145-145/M-165-165/M-194-194/M-199-199/M
3.22.11.75	300x40x30	-	-	24	1	146-146/M-166-166/M-195-195/M-200-200/M
3.23.99.40	-	200x25x16	-	60	1	246 - 246/M - 247 - 247/M - 213 - 214 - 167 - 197/M - 204
3.23.99.41	-	200x30x20	-	60	1	163 EVO - 163 M EVO - 198 EVO - 198 M EVO
3.23.99.42	-	250x30x20	-	60	1	165 EVO - 165 M EVO - 209 EVO - 199 EVO - 199/M EVO - 202 EVO
3.23.99.43	-	300x35x25	-	60	1	166 - 166/M - 211 - 200 - 200/M - 203

**NEW**

### SAND BELTS - BANDAS ABRASIVAS EN PAQUETE ESTÁNDAR

3.23.99.17	-	-	50x2200	40	10	296-298
3.23.99.18	-	-	50x2200	60	10	296-298
3.23.99.19	-	-	50x2200	80	10	296-298

\*With reduction bushing included in the packaging | \*Con reducciones incluidas

## WHEELS, BRUSHES AND SANDING BELTS PROFESSIONAL RANGE | MUELAS /CEPILLOS/BANDAS ABRASIVAS PARA SERIE PROFESIONAL

CODE CÓDIGO	 Ø mm	 Ø mm	 Ø mm	 mm x mm	GRAIN GRANO	PIECES NR. PIEZAS N°	FOR ART.   PARA ART
3.22.99.23	150x20x16/12*/12,7*	-	-	-	36	1	404-424-182PLUS
3.22.99.24	150x20x16/12*/12,7*	-	-	-	60	1	404-424-182PLUS
3.22.99.25	200x20x16	-	-	-	36	1	405 - 425
3.22.99.26	200x20x16	-	-	-	60	1	405 - 425
3.22.99.28	-	180x30x20	-	-	150	1	182 PLUS
3.22.99.27	-	200x40x20	-	-	150	1	177
3.23.99.35	-	-	150x20x16	-	-	1	424-425

\*With reduction bushing included in the packaging | \*Con reducciones incluidas

### WHEELS, BRUSHES AND SANDING BELTS

Disk grinding wheels either made of gray corundum (carborundum) and ceramics binder (bench grinders) or of high quality white corundum and glazed ceramics binder (sharpening machines). Corundum sand belts, high resistance reinforced fabric support and ground joints for greater smoothness. Grinding wheels and belts available in different grits: the higher the number the finer the grit (suitable for deburring and finishing), whereas the lower the number the rougher the grit (suitable for grinding and roughing-out).

### MUELAS, CEPILLOS Y BANDAS

Mueles de disco de corindón gris (carburo de silicio) y aglutinante cerámico (esmeriladoras) o bien de corindón fino blanco y aglutinante cerámico vitrificado (afiladoras).

Bandas abrasivas de corindón, soporte de tela reforzada de gran resistencia,

Uniones lijadas para garantizar un mayor deslizamiento. Mueles y bandas disponibles en diferentes granos: a un número más alto corresponde un grano más fino (ideal para desbarbados y acabados), mientras que a un número más bajo corresponde un grano más grueso (ideal para esmerilado y desbastado).





SANDING BELTS - STANDARD PACK | BANDAS ABRASIVAS - EN PAQUETE ESTÁNDAR

CODE CÓDIGO	 mm x mm	GRAIN GRANO	PIECES NR. PIEZAS N°	FOR ART. PARA ART.
3.23.99.20	100x1000	50	10	510 - 511
3.23.99.21	100x1000	80	10	
3.23.99.22	120x1500	40	10	542B - 543B - 504B - 534B - 535B - 536B - 502 - 503 - 504
3.23.99.23	120x1500	60	10	
3.23.99.24	120x1500	80	10	
3.23.99.25	150x1750	40	10	
3.23.99.26	150x1750	60	10	505B - 507B - 537B - 539B
3.23.99.27	150x1750	80	10	

**NEW**

SANDING BELTS - STANDARD PACK | BANDAS ABRASIVAS - EN PAQUETE ESTÁNDAR

CODE CÓDIGO	 mm x mm	GRAIN GRANO	PIECES NR. PIEZAS N°	FOR ART. PARA ART.
3.23.99.36	100x1000	60	3	293N - 294N
3.23.99.37	75x2000	60	3	574 - 575
3.23.99.38	150x2000	60	3	577

SANDING DISK - STANDARD PACK  
DISCOS ABRASIVOS - EN PAQUETE ESTÁNDAR

CODE CÓDIGO		GRAIN GRANO	PIECES NR. PIEZAS N°	FOR ART. PARA ART.
3.23.99.28	Ø 350 mm	40	10	534B - 535B - 536B - 522B
3.23.99.29	Ø 350 mm	60	10	
3.23.99.30	Ø 350 mm	80	10	
3.23.99.31	Ø 400 mm	40	10	537B - 539B - 525B
3.23.99.32	Ø 400 mm	60	10	
3.23.99.33	Ø 400 mm	80	10	

ADAPTERS FOR VELCRO DISK - ADAPTADORES PARA DISCOS VELCRO

3.23.75.09	For disk - Para discos Ø 350 mm
3.23.75.10	For disk - Para discos Ø 400 mm

# GRINDY

## TECHNICAL FEATURES

- Display unit column in bended steel metal for displaying four bench grinders
- Maximum charge for each shelf: 25 kg (no limit charge for exposition on the base)

## CARACTERÍSTICAS TÉCNICAS

- Base expositora de acero laminado y pensado para la exhibición de cuatro esmerillas de banco
- Maxima carga posible por cada piso: 25 kg (sin limite de peso sobre la base)

### DISPLAY UNIT COLUMN | BASE EXPOSITORA

ART.	CODE CÓDIGO	SIZE DIMENSIONES a x b x h (mm)	Kg
GRINDY	7.13.36.96	1450x500x300	13



1450 mm

TO EXHIBIT ALL INDUSTRIAL BENCH GRINDERS  
PARA EXPONER TODAS LAS ESMERILLADORAS INDUSTRIALES



TO EXHIBIT ALL EXPERT BENCH GRINDERS  
PARA EXPONER TODAS LAS ESMERILLADORAS EXPERT





TO EXHIBIT SHARPENING MACHINES  
PARA EXPONER AFILADORAS



500 mm

300 mm

## CENTRIFUGAL PUMPS | ELECTROBOMBAS CENTRÍFUGAS

ART.	CODE CÓDIGO	 WATT	 mm	TYPE OF PUMP USED TIPO DE BOMBA APLICADA
120	8.38.20.21	60 □	60	-
121	8.38.21.21	60 □	85	-
122	8.38.22.21	60 □	120	-
123	8.38.23.21	60 □	150	-
220	8.38.16.31	180 □	200	-
221	8.38.17.31	180 □	260	-
222	8.38.18.31	250 □	200	-
223	8.38.19.31	250 □	260	-
226	8.38.10.31	120 □	-	art. 228
227	8.38.07.31	120 □	90	-
228	8.38.08.31	120 □	120	-
229	8.38.09.31	120 □	200	-

□ 230 Volt - Hz 50 single-phase motor - Motor monofásico 230 Volt - Hz 50

□ 400 Volt - Hz 50 three-phase motor - Motor trifásico 400 Volt - Hz 50

The continuous service self-priming electric pumps are suitable for continuous coolant flow and assure absolute operating safety even at high temperatures.

Las electrobombas con autocebado para servicio continuo, son aptas para la circulación continua de líquidos refrigerantes, y garantizan una absoluta seguridad de funcionamiento con elevadas temperaturas.

## LOADING DIAGRAMS | DIAGRAMAS DE CARGA

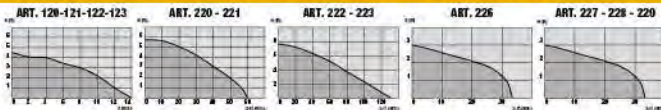

## ELECTRIC PUMP DIMENSIONS | DIMENSIONES DE LAS ELECTROBOMBAS

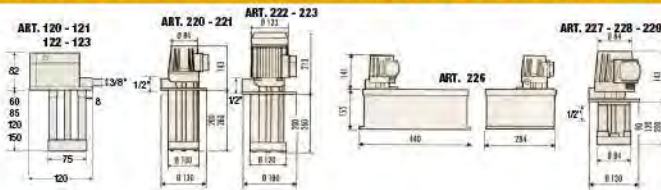

# 120



# 228



# 221



# 223



# 226



## HANDING FLEXIBLE SYSTEM | EQUIPO FLEXIBLE PÉNSIL

ART.	CODE CÓDIGO	 WATT	 RPM	FLEXIBLE SHAFT ÁRBOL FLEXIBLE	BUNDLE PIEZA DE MANO	CHUCK MANDRIL	 Kg
623	8.31.07.21	350 □	21000	∅ 6x14x1200	∅ 24	∅ 6	3,2

□ 230 Volt - Hz 50 single-phase motor - Motor monofásico 230 Volt - Hz 50

### TECHNICAL FEATURE

- Handy and versatile.
- Electronic device for speed adjustment.
- Double safety insulation.

### STANDARD FITTINGS

- Flexible shaft.
- Chuck for ∅ 6mm tools.
- Electronic pedal rheostat.

### ACCESSORIES

- Chuck ∅ 2.3 - 3 - 4 mm.
- Support rod.

### CARACTERÍSTICAS TÉCNICAS

- Sumamente manejable y versátil.
- Velocidad regulable electrónicamente.
- Doble aislamiento de seguridad.

### EQUIPAMIENTO DE SERIE

- Arbol flexible.
- Mandril para herramienta ∅ 6 mm.
- Reóstato electrónico a pedal.

### ACCESORIOS

- Madril ∅ 2.3 - 3 - 4 mm.
- Varilla de soporte.



GREAT PERFORMANCES LINE LÍNEA DE ALTAS PRESTACIONES Ø 305

**305 PRO**  
**168x78**



PAG. 65

Global versatility for the everyday job.  
Versatilidad total para el trabajo diario.

**305S**  
**170x78**



PAG. 68

The strength for tradition  
La fuerza por tradición

**999 EVO**  
**165x100**



PAG. 65

Energy and power in 18 kgs  
Energía y potencia en 18 Kg



ALU LINE | LÍNEA DE ALU Ø 305



**XXX EVO ALU**

**170x70**

Once more, one step ahead!  
Otra vez, otro paso hacia el futuro!

PAG. 71

GREAT PERFORMANCES LINE LÍNEA DE ALTAS PRESTACIONES Ø 305

**911 EVO**  
**165x100**



PAG. 64

Outstanding leading performances  
Prestaciones líderes

**XXX EVO**  
**170x70**



PAG. 63



DOWNLOAD THE VIDEO  
DESCARGA EL VIDEO

Once more, one step ahead!  
Otra vez, otro paso hacia el futuro!



DOWNLOAD THE VIDEO  
DESCARGA EL VIDEO

**1050 3D**  
**305x90**



PAG. 62

PORTABLE LINE | LÍNEA DE FÁCIL TRANSPORTE Ø 250÷280

**732**  
LMAX HMAX  
**162x78**



PAG. 70

The indispensable  
La indispensable

**733**  
LMAX HMAX  
**162x75**



PAG. 70

Silent and reliable.  
Silenciosa y fiable.

**280S**  
**150x70**



PAG. 69

Really unique.  
Realmente única.



**XPANDER**  
Parquet cutter:  
Corta parquet.

PAG. 67



DOWNLOAD THE VIDEO  
DESCARGA EL VIDEO



**IB500**  
Edge bander:  
Encoladora de cantos.



DOWNLOAD THE VIDEO  
DESCARGA EL VIDEO

PAG. 73

# 1050 3D

MITRESAWS  
TRONZADORAS DE MADERA

ART.	CODE   CÓDIGO
1050 3D	8.43.50.23

## TECHNICAL FEATURES

Three combined functions:

Mitresaw with upper table, sliding compound mitresaw, bench circular saw.

- Maximum cutting capacity on the upper table: 60 mm! (only with blade protection mounted)
- Cutting angles 60° right and 50° left with automatic locking device 0° - 15° - 22,5° - 30° - 45°
- Patented change function system from mitresaw to circular saw easy and quick
- Telescopic sliding bars  $\varnothing$  30 mm

## STANDARD EQUIPMENT

- Side extensions for big cuttings
- Vertical clamp for clamping of cutting material
- Blade protection for cutting on the upper table
- Key set / wood pusher

## CARACTERÍSTICAS TÉCNICAS

Tres funciones combinadas: Corte inferior; corte superior y corte longitudinal telescópico.

- Corte en la mesa superior maxima: 60 mm! (sólo con protección de disco montada)
- Ángulo de corte 60° derecha y 50° izquierda, con dispositivo de bloqueo automático a 0° - 15° - 22,5° - 30° - 45°
- Sistema patentado de cambio de función de trozadora a tronadora de disco, rápido y fácil
- Barras de desplazamiento radial  $\varnothing$  30 mm

## EQUIPAMIENTO DE SERIE

- Extensiones laterales para cortes de grandes dimensiones
- Morzada vertical para el bloqueo de la pieza
- Protección de disco para cortes en la mesa superior
- Llaves en dotación / accesorio para empujar la madera

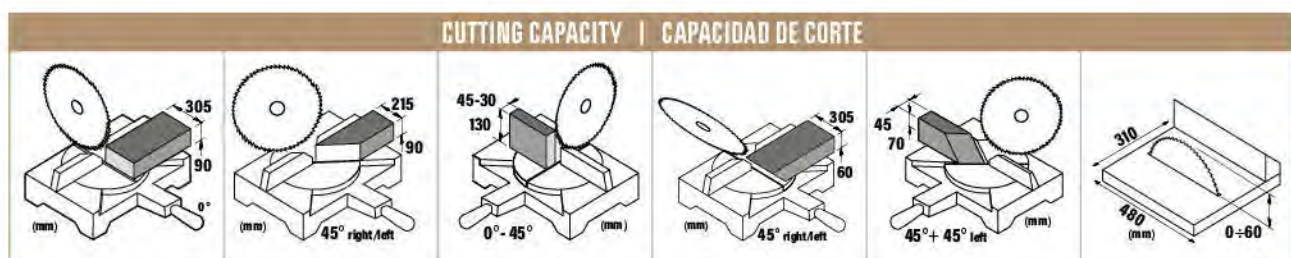

1800 W



3600



D305 - d30

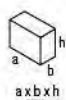

990x650x460



28



90 mm



305 mm



DOWNLOAD  
THE VIDEO  
DESCARGA  
EL VIDEO

230 Volt - Hz 50 single-phase motor | Motor monofásico 230 Volt - Hz 50

ART.	CODE   CÓDIGO
XXX EVO	8.43.60.45

## TECHNICAL FEATURES

- Movements on bearings of the turning table, head and joint
- Powerful 1500 Watt induction motor
- Piece support with sliding kit (INCLUDED)
- New T.P.S. (Three Positions System) handle (Patented)
- Micrometric adjustment of the upper working table

## STANDARD EQUIPMENT

- Chrome coated blade with Widia inserts and noise dampening-slots with key set.
- Vertical clamp
- Adjustable bar stop-rod for mass-produced cuts.
- Supplementary protection and wood pusher
- Sliding Kit

## CARACTERÍSTICAS TÉCNICAS

- Movimientos sobre cojinetes de la mesa giratoria, cabeza y articulación
- Motor de inducción silencioso y potente 1500 Watt
- Apoyo de la pieza con kit deslize incluido
- Nueva empuñadura TPS (Three Position System) (Patentado)
- Regulación micrométrica de la mesa superior de trabajo

## EQUIPAMIENTO DE SERIE

- Hoja con inserciones en Widia cromada y con hendiduras silenciadoras con llaves
- Mordaza vertical
- Varilla de sujeción de la barra para realizar cortes en serie
- Protección adicional y dispositivo de empuje madera.
- Kit de deslizamiento



Piece support with sliding kit (INCLUDED)  
Apoyo de la pieza con kit de deslizamiento incluido

**PATENTED**

T.P.S. THREE POSITIONS SYSTEM



## CUTTING CAPACITY | CAPACIDAD DE CORTE

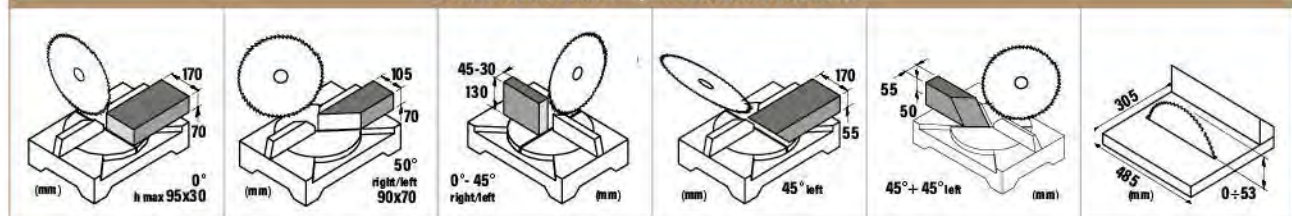

1500



2850



Ø305 - d30

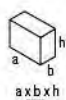

630x630x500



24



70 mm



170 mm



DOWNLOAD  
THE VIDEO  
DESCARGA  
EL VIDEO

□ 230 Volt - Hz 50 single-phase motor | Motor monofásico 230 Volt - Hz 50

ART.	CODE   CÓDIGO
911 EVO	8.43.60.47

### TECHNICAL FEATURES

- Large upper working table (305x503 mm) with micrometric height adjustment
- Aluminium section upper table straightedge adjustable in two positions and with dual front and rear fixing system
- Silent and more powerful 1600 Watt induction motor with thermal protection
- Silent and reliable "POLY-V" belt transmission
- Base with integrated release lever protection

### STANDARD EQUIPMENT

- Chromed blade with Widia inserts
- Additional sliding pieces support
- Adjustable bar stop-rod for mass-produced cuts
- Supplementary protection and wood pusher and key set
- Vertical clamp

### CARACTERÍSTICAS TÉCNICAS

- Mesa de trabajo superior de grandes dimensiones (305x503 mm) con regulación micrométrica de la altura
- Regla superior de perfil de aluminio con regulación en 2 posiciones y con sistema de fijación doble (delantera y trasera)
- Motor de inducción silencioso y potente 1600 W con protección térmica
- Transmisión de correa "POLY-V" silenciosa y segura
- Base con protección integrada de la palanca para el desbloqueo

### EQUIPAMIENTO DE SERIE

- Disco con inserciones en Widia cromada
- Varilla de sujeción de la barra para realizar cortes en serie
- Llaves en dotación
- Protección adicional y dispositivo de empuje madera
- Kit de deslizamiento
- Mordaza vertical



**PATENTED**

T.P.S. THREE POSITIONS SYSTEM



### CUTTING CAPACITY | CAPACIDAD DE CORTE

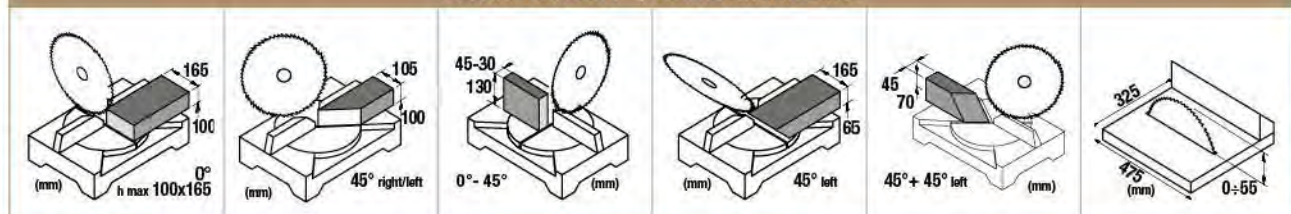

1600



2850



305 - d30

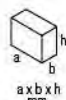

640x640x510



22,5



100

mm



165

□ 230 Volt - Hz 50 single-phase motor | Motor monofásico 230 Volt - Hz 50



ART.	CODE   CÓDIGO
999 EVO	8.43.60.43

## TECHNICAL FEATURES

- Aluminium section upper table straightedge adjustable in two positions and with dual front and rear fixing system
- Large upper working table (305x503 mm) with micrometric height adjustment
- Electronic control of the anti-reset safety function
- Base with integrated release lever protection with mechanical end-run limit
- Double mitre cut 45°+45° left

## STANDARD EQUIPMENT

- Chromed blade with Widia inserts
- Piece support with sliding KIT (included)
- Adjustable bar stop-rod for mass-produced cuts
- Supplementary protection and wood pusher
- Vertical clamp

## CARACTERÍSTICAS TÉCNICAS

- Regla superior de perfil de aluminio con regulación en 2 posiciones y con sistema de fijación doble (delantera y trasera)
- Mesa de trabajo superior de grandes dimensiones (305x503 mm) con regulación micrométrica de la altura
- Control electrónico del sistema de seguridad anti-arranque
- Base con protección integrada de la palanca para el desbloqueo con fin de carrera
- Corte combinado 45°+45° izquierda

## EQUIPAMIENTO DE SERIE

- Disco cromado con inserciones en Widia
- Apoyo de la pieza con kit e deslizamiento incluido
- Varilla de sujeción de la barra para realizar cortes en serie
- Protección adicional y accesorio para empujar la madera
- Mordaza vertical



Powerful universal motor 1700 watt  
Potente motor universal 1700 W

Ø 305 mm

Piece support with sliding kit (INCLUDED)  
Apoyo de la pieza con kit de deslizamiento incluido

**PATENTED**

T.P.S. THREE POSITIONS SYSTEM



## CUTTING CAPACITY | CAPACIDAD DE CORTE

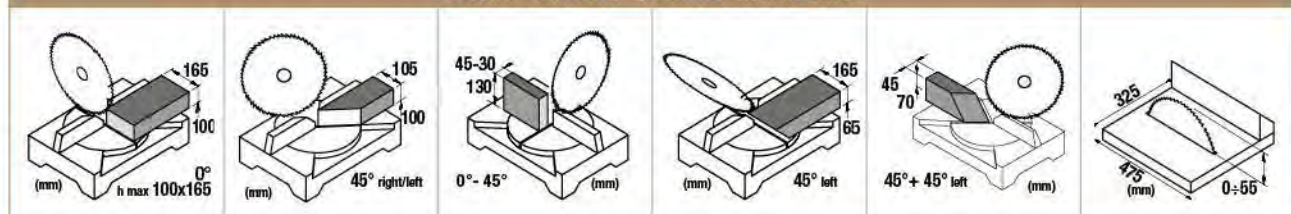

1700 W



4200



Ø305 - d30



640x640x510



18



100 mm



165 mm

□ 230 Volt - Hz 50 single-phase motor | Motor monofásico 230 Volt - Hz 50

# 305 PRO

MITRESAWS  
TRONZADORAS DE MADERA

ART.	CODE   CÓDIGO
305 PRO	8.43.60.44

## TECHNICAL FEATURES

- Powerful 1300 Watt induction motor
- Base suitable for Sliding Kit (OPTIONAL)
- T.P.S. (Three Positions System) handle (Patented)
- Upper table in aluminium extrusion with lateral extension (OPTIONAL - see pag 75)
- Base with integrated release lever protection with mechanical end stroke

## STANDARD EQUIPMENT

- Chrome coated blade with Widia inserts and noise dampening-slots with key set
- Vertical clamp
- Supplementary protection and wood pusher

## CARACTERÍSTICAS TÉCNICAS

- Potente motor de inducción 1300 W
- Mesa de trabajo con predisposición para el kit de deslizamiento (OPCIONAL)
- Empunadura TPS (Three Positions System) (Patentado)
- Mesa superior de trabajo de extrusión con extensión lateral (OPCIONAL - Ver página 75)
- Base con y protección integrada de la palanca para el desbloqueo con fin de carera

## EQUIPAMIENTO DE SERIE

- Hoja con inserciones en Widia cromada y con hendiduras silenciadoras con llaves
- Mordaza vertical
- Protección adicional y dispositivo de empuje madera



## PATENTED T.P.S. THREE POSITIONS SYSTEM



- Raised support base suitable for Sliding Kit mounting (Optional - see page 75)
- Mesa de trabajo adaptada con predisposición para el kit de deslizamiento (Opcional - vea pág. 75)



## CUTTING CAPACITY | CAPACIDAD DE CORTE

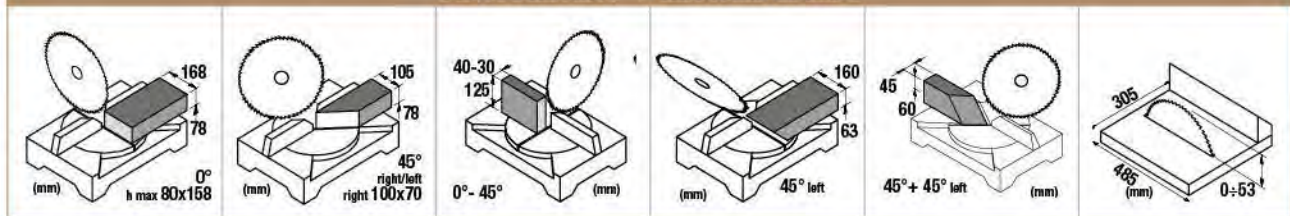

1300



2850

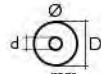

Ø305 - d30



630x630x500



21



78 mm



168 mm

□ 230 Volt - Hz 50 single-phase motor | Motor monofásico 230 Volt - Hz 50

ART.	CODE   CÓDIGO
XPANDER	7.07.50.76

**TECHNICAL FEATURES**

- Made in aluminium, it increases the cutting capacity up to 30%
- It allows compound cuts up to 48° to compensate walls out of square
- Designed for the application of both the horizontal clamp and the vertical clamp
- Easy and fast assembling on the machine thanks to 2 fast fixing points
- Exclusive and patented design

**CARACTERÍSTICAS TÉCNICAS**

- En aluminio, mayor capacidad de corte hasta el 30%
- Ángulo de corte regulable hasta 48° para el ajuste de las paredes exteriores
- Predisposición para el uso de la mordaza horizontal y vertical
- Montaje fácil y rápido del accesorio sobre la máquina por medio de 2 puntos de montaje rápido
- Diseño exclusivo y patentado



- Cut at 0°: 210 mm
- Corte a 0°: 210 mm



- Cut at 45°: 143 mm
- Corte a 45°: 143 mm



- Cutting capacity up to 210 mm at 0° and 143 mm at 45°
- Corte hasta 210 mm a 0° y 143 mm a 45°



- Use with vertical clamp
- Utilización con mordaza vertical

**CUTTING CAPACITY | CAPACIDAD DE CORTE**

		Cut at 0°/Corte a 0°	Cut at 45°/Corte a 45°
XXX EVO	Ø 305	200 mm × h 10 mm	130 mm × h 10 mm
XXX EVO ALU	Ø 305	205 mm × h 10 mm	140 mm × h 10 mm
305 PRO	Ø 305	210 mm × h 10 mm	142 mm × h 10 mm
911 EVO	Ø 305	210 mm × h 10 mm	142 mm × h 10 mm
999 EVO	Ø 305	210 mm × h 10 mm	142 mm × h 10 mm

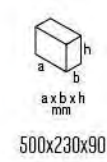

DOWNLOAD THE VIDEO  
DESCARGA EL VIDEO

ART.	CODE   CÓDIGO
305 S	8.43.80.22

### TECHNICAL FEATURES

- Very sturdy and robust structure: great reliability and cutting precision
- Movement of the turning table entirely on bearings
- Head return system protected with anti-fall spring
- Sheet metal frontal blade protection
- Silent 1400W induction motor
- Cutting angle adjustable from 0° to 45° right and left

### STANDARD EQUIPMENT

- Blade with Widia inserts
- Adjustable bar stop-rod for mass-produced cuts
- Key set
- Supplementary protection and wood pusher

### CARACTERÍSTICAS TÉCNICAS

- Estructura muy sólida y rígida: gran fiabilidad y precisión de corte
- Movimientos de la mesa giratoria enteramente sobre cojinetes
- Sistema de retorno de la cabeza con muelle anti-caída
- Cáster de corte frontal en chapa laminada
- Motor de inducción silencioso 1400 Watt
- Ángulo de corte regulable de 0° a 45° izquierda y derecha

### EQUIPAMIENTO DE SERIE

- Disco con inserciones en Widia
- Varilla de sujeción de la barra para realizar cortes en serie
- Llaves en dotación
- Protección adicional y accesorio para empujar la madera



- Great precision and cutting capacity (170 mm x 78 mm)
- Gran precisión y capacidad de corte (170 mm x 78 mm)



- Upper working table 475 mm x 325 mm with 66 mm cutting height
- Mesa superior 475 mm x 325 mm con capacidad de corte 66 mm

### CUTTING CAPACITY | CAPACIDAD DE CORTE

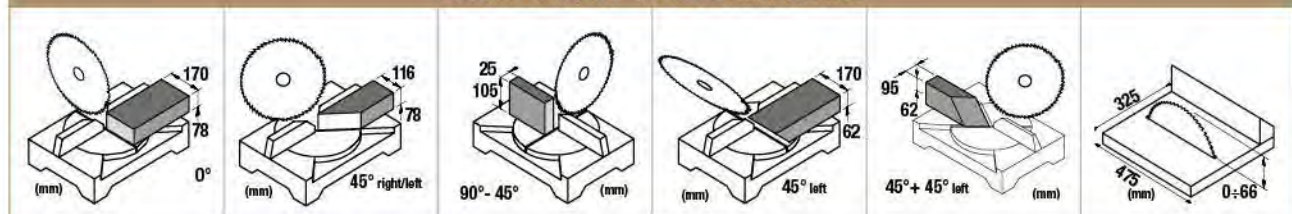

1400 W



3000



Ø305 - d30

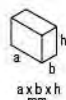

640x640x510



29



78 mm



475 mm

□ 230 Volt - Hz 50 single-phase motor | Motor monofásico 230 Volt - Hz 50

# 280 S

MITRESAWS  
TRONZADORAS DE MADERA

ART.	CODE   CÓDIGO
280 S	8.42.80.21

## TECHNICAL FEATURES

- The only mitersaw in the world with Ø 280 mm blade
- Movement of the turning table entirely on bearings
- Great cutting performances 150 x 70 mm
- Silent 1300W induction motor
- Ideal handle for ground working
- 2-positions upper work table cutting guide
- Double mitre cut 45°+45° left

## STANDARD EQUIPMENT

- Blade with Widia inserts for the maximum material penetration
- Adjustable bar stop-rod for mass-produced cuts
- Key set
- Supplementary protection and wood pusher

## CARACTERÍSTICAS TÉCNICAS

- La única tronzadora en el mundo con disco Ø 280 mm
- Movimientos de la mesa giratoria enteramente sobre cojinetes
- Grandes prestaciones de corte 150 x 70 mm
- Motor de inducción silencioso 1300 W
- Empuñadura ideal para trabajos en tierra
- Guía corte mesa superior de dos posiciones
- Corte combinado 45°+45° izquierda

## EQUIPAMIENTO DE SERIE

- Disco con inserciones en Widia para la máxima penetración en material
- Varilla de sujeción de la barra para realizar cortes en serie
- Llaves en dotación
- Protección adicional y accesorio para empujar la madera



- Cutting angle adjustable from 0° to 45° right and left
- Ángulo de corte regulable de 0° a 45° izquierda y derecha



- Sturdy and robust structure for a great cutting precision
- Estructura sólida y rígida para una gran precisión de corte

## CUTTING CAPACITY | CAPACIDAD DE CORTE

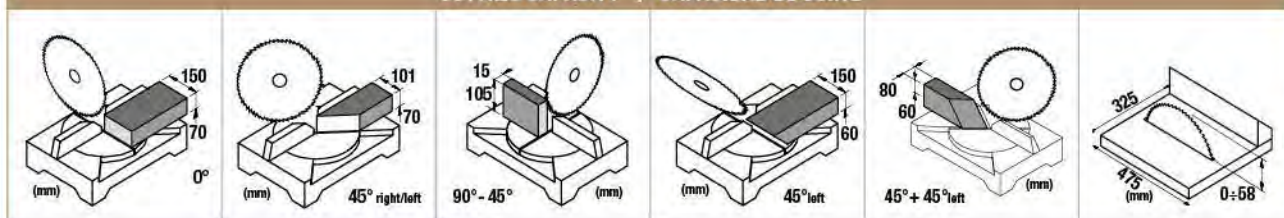

1300 W



3000



Ø280 - d30

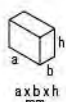

640x640x510



27



70 mm

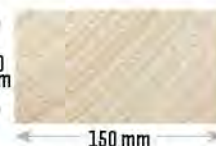

150 mm

□ 230 Volt - Hz 50 single-phase motor | Motor monofásico 230 Volt - Hz 50

ART. 732 CODE | CÓDIGO 8.42.00.28

## 732



### TECHNICAL FEATURES

- Die cast aluminium body
- Cutting capacity 162 mm!
- Powerful universal motor 1550 Watt
- Double mitre cut 45° + 45° left
- Upper table 360x462 mm!!

### STANDARD EQUIPMENT

- Blade with Widia inserts
- Adjustable bar stop-rod for mass-produced cuts
- Supplementary protection and wood pusher and key set
- Vertical clamp

### CARACTERÍSTICAS TÉCNICAS

- Estructura de aluminio fundido a presión
- Capacidad de corte 162 mm!
- Potente motor universal 1550 W
- Corte combinado 45° + 45° izquierda
- Mesa superior provista de guía, con altura regulable (360x462 mm)

### EQUIPAMIENTO DE SERIE

- Disco con inserciones de Widia
- Varilla de sujeción de la barra
- Protección adicional y accesorio para empujar la madera y llaves
- Mordaza vertical

1550	4200	D254 -d30	530x535x390	14,5	H max 78 mm	L max 162 mm

□ 230 Volt - Hz 50 single-phase motor | Motor monofásico 230 Volt - Hz 50

### CUTTING CAPACITY | CAPACIDAD DE CORTE

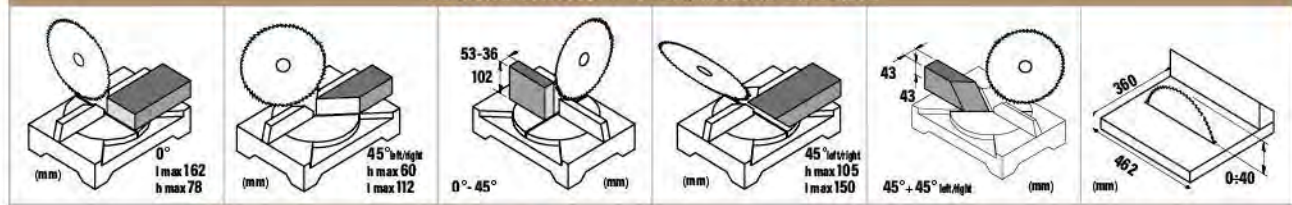

ART. 733 CODE | CÓDIGO 8.42.00.29

## 733



### TECHNICAL FEATURES

- Die cast aluminium body
- Cutting capacity 162 mm!
- Silent and powerful induction motor 1300 W
- Upper table 360x462 mm!!
- Adjustable cutting angle from 0° to 47° right and left

### STANDARD EQUIPMENT

- Blade with Widia inserts
- Key set
- Adjustable bar stop-rod for mass-produced cuts
- Supplementary protection and wood pusher
- Vertical clamp

### CARACTERÍSTICAS TÉCNICAS

- Estructura de aluminio fundido a presión
- Capacidad de corte 162 mm!
- Motor de inducción 1300 W silencioso y potente
- Mesa superior provista de guía, con altura regulable (360x462 mm)
- Ángulo de corte regulable de 0° a 47° derecha e izquierda

### EQUIPAMIENTO DE SERIE

- Disco con inserciones de Widia para la máxima penetración en el material
- Llaves en dotación
- Varilla de sujeción de la barra
- Protección adicional y accesorio para empujar la madera
- Nordaza vertical

1300	2850	D254 -d30	530x535x390	17,5	H max 75 mm	L max 162 mm

□ 230 Volt - Hz 50 single-phase motor | Motor monofásico 230 Volt - Hz 50

### CUTTING CAPACITY | CAPACIDAD DE CORTE

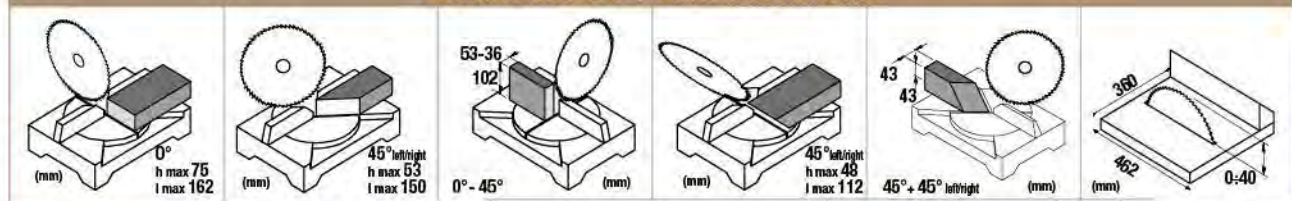

# XXX EVO ALU

ALUMINIUM MITRESAWS  
TRONZADORAS DE ALUMINIO

ART. XXX EVO ALU  
CODE | CÓDIGO 8.43.60.46

## TECHNICAL FEATURES

- New T.P.S. (Three Position System) handle (PATENTED)
- Movements on bearings of the turning table, head and joint.
- Powerful 1500 Watt silent induction motor.
- Piece support with sliding kit (INCLUDED)

## STANDARD EQUIPMENT

- Chrome coated blade with Widia inserts and noise dampening-slot.
- Vertical clamp.
- Adjustable bar stop-rod for mass-produced cuts.
- Sliding kit.

## CARACTERÍSTICAS TÉCNICAS

- Nueva empuñadura TPS (Three Position System) (PATENTADO)
- Movimientos sobre cojinetes de la mesa giratoria, cabeza y articulación.
- Motor de inducción silencioso y potente 1500 Watt.
- Apoyo de la pieza con kit de deslize incluido.

## EQUIPAMIENTO DE SERIE

- Hoja con inserciones en Widia cromada y con hendiduras silenciadoras.
- Mordaza vertical.
- Varilla de sujeción de la barra para realizar cortes en serie.
- Kit de deslizamiento.



- Vertical clamp included
- Mordaza vertical incluida



- Special Z84 blade for alu
- Disco Especial Z84 para aluminio

## PATENTED T.P.S. THREE POSITIONS SYSTEM



## CUTTING CAPACITY | CAPACIDAD DE CORTE

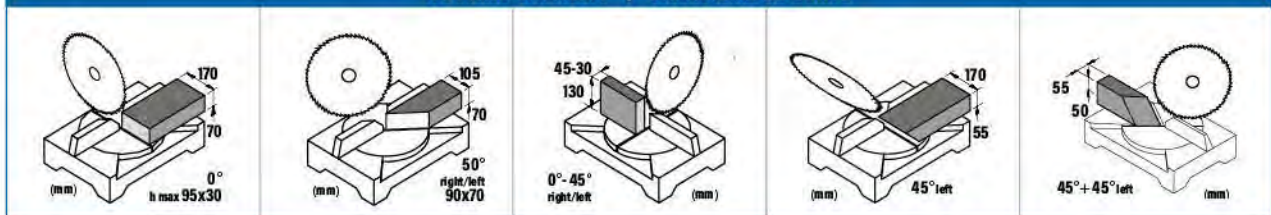

1500 W



2850

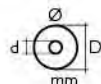

Ø305 - d30

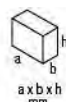



630x630x500



21,5



□ 230 Volt - Hz 50 single-phase motor | Motor monofásico 230 Volt - Hz 50

CODE CÓDIGO				USES USOS	FOR ART. PARA ART.
<b>BLADES FOR WOOD AND PLASTIC MATERIALS   DISCOS PARA MADERA Y MATERIAS PLÁSTICAS</b>					
3.27.85.26	250x30	24	2,5	Shredding and ripping of: soft woods, hard woods, solid woods Troceado y corte a lo largo de la veta de: maderas blandas, duras y macizas	842*
3.27.85.28	250x30	40*	2,5	Shredding and ripping of: soft woods, hard woods, solid woods Troceado y corte a lo largo de la veta de: maderas blandas, duras y macizas	
3.27.85.07	250x30	60	2,5	Ripping and crosscutting of: soft and hard woods, solid and exotic woods, chipboard and stratified panels. Corte a lo largo y a través de la veta de: maderas blandas, exóticas, aglomerada y paneles estratificados.	
3.27.85.08	250x30	80	3,2	Ripping and crosscutting of: soft and hard woods, solid and exotic woods, chipboard and stratified panels. Crosscutting of: chipboard, thermoplastic, MDF, laminated on one side. Trimming of: wooden frames, skirting board, excellent quality woods. Corte a lo largo y a través de la veta de: maderas blandas, duras, macizas, exóticas, aglomerada y paneles estratificados. Corte a través de la veta de: madera aglomerada, termoplásticos, MDF, laminados sobre una sola cara. Acabado de: marcos, listones y maderas preciosas.	
3.27.85.39	254x30	24*	2,5	Shredding and ripping of: soft woods, hard woods, solid woods Troceado y corte a lo largo de la veta de: maderas blandas, duras y macizas	732*-733
3.27.85.40	254x30	40*	2,5	Shredding and ripping of: soft woods, hard woods, solid woods Troceado y corte a lo largo de la veta de: maderas blandas, duras y macizas	732-733*
3.29.00.08	280x30	64*	2,5	Ripping and crosscutting of: soft and hard woods, solid and exotic woods, chipboard and stratified panels. Corte a lo largo y a través de la veta de: maderas blandas, duras, macizas, exóticas, aglomerada y paneles estratificados.	280S*
3.27.85.29	300x30	48	2,5	Shredding and ripping of: soft woods, hard woods, solid woods. Troceado y corte a lo largo de la veta de: maderas blandas, duras y macizas.	846 300 SPECIAL
3.27.85.13	300x30	72	3,2	Ripping and crosscutting of: soft and hard woods, solid and exotic woods, chipboard and stratified panels. Corte a lo largo y a través de la veta de: maderas blandas, duras, macizas, exóticas, aglomerada y paneles estratificados.	
3.27.85.14	300x30	96	3,2	Ripping and crosscutting of: soft and hard woods, solid and exotic woods, chipboard and stratified panels. Crosscutting of: chipboard, thermoplastic, MDF, laminated on one side. Trimming of: wooden frames, skirting board, excellent quality woods. Corte a lo largo y a través de la veta de: maderas blandas, duras, macizas, exóticas, aglomerada y paneles estratificados. Corte a través de la veta de: madera aglomerada, termoplásticos, MDF, laminados sobre una sola cara. Acabado de: marcos, listones y maderas preciosas.	
3.27.85.31	305x30	48*	2,5	Shredding and ripping of: soft woods, hard woods, solid woods Troceado y corte a lo largo de la veta de: maderas blandas, duras y macizas	XXX EVO* 305 PRO* 911 EVO* 999 EVO* 305S* 10503D*
3.27.99.51	305x30	72	3,0	Ripping and crosscutting of: soft and hard woods, solid and exotic woods, chipboard and stratified panels. Corte a lo largo y a través de la veta de: maderas blandas, duras, macizas, exóticas, aglomerada y paneles estratificados.	
3.27.99.52	305x30	96	3,2	Ripping and crosscutting of: soft and hard woods, solid and exotic woods, chipboard and stratified panels. Crosscutting of: chipboard, thermoplastic, MDF, laminated on one side. Trimming of: wooden frames, skirting board, excellent quality woods. Corte a lo largo y a través de la veta de: maderas blandas, duras, macizas, exóticas, aglomerada y paneles estratificados. Corte a través de la veta de: madera aglomerada, termoplásticos, MDF, laminados sobre una sola cara. Acabado de: marcos, listones y maderas preciosas.	

\* Standard fitting - En dotación estándar

<b>BLADES FOR ALUMINIUM   DISCOS PARA ALUMINIO</b>					
3.27.85.09	250x30	80	3,2	Cutting of: aluminium sections and extrusions Tronzado de: elementos perfilados y extrusionados de aluminio y metales no ferrosos.	842
3.27.85.41	254x30	80	3,2	Cutting of: aluminium sections and extrusions Tronzado de: elementos perfilados y extrusionados de aluminio y metales no ferrosos.	732-733
3.29.00.09	280x30	64	3,0	Cutting of: aluminium sections and extrusions Tronzado de: elementos perfilados y extrusionados de aluminio y metales no ferrosos.	280S
3.27.85.21	300x30	84	3,0	Cutting of: aluminium sections and extrusions Tronzado de: elementos perfilados y extrusionados de aluminio y metales no ferrosos.	846 Alu 846 300 SPECIAL
3.27.85.15	300x30	96	3,0	Cutting of: aluminium sections and extrusions Tronzado de: elementos perfilados y extrusionados de aluminio y metales no ferrosos.	XXX EVO 305 PRO 911 EVO-999 EVO XXX EVO XXX EVO Alu* 305S
3.27.99.53	305x30	84*	3,0	Cutting of: aluminium sections and extrusions Tronzado de: elementos perfilados y extrusionados de aluminio y metales no ferrosos.	
3.27.99.54	305x30	96	3,0	Cutting of: aluminium sections and extrusions Tronzado de: elementos perfilados y extrusionados de aluminio y metales no ferrosos.	

\* Standard fitting - En dotación estándar



ART.	CODE   CÓDIGO
IB 500	8.62.01.26

### TECHNICAL FEATURES

- Solid metal sheet frame, adjustable support feet for the maximum stability
- Hot air flow – 2 speeds: 18-30 m<sup>3</sup> / h
- Adjustable heating temperature from 350 °C to 500 °C
- Folding outrigger support

### EDGE BANDING SYSTEM

- Designed for hot-melt adhesives edge banding materials higher no more than 48 mm
- Ideal for finishing linear and moulded panels

### CARACTERÍSTICAS TÉCNICAS

- Estructura robusta, con patas de nivelación ajustables para un trabajo en máxima estabilidad
- Flujo de calor 2 velocidades: 18-30 m<sup>3</sup> / h
- Temperatura de calentamiento ajustable desde 350° hasta 500°
- Soporte para el rodillo de sujeción plegable

### ENCOLADORA DE CANTOS

- Para el pegado por calor de rollos de altura máxima 48 mm
- Ideal para el acabado de paneles lineales y perfilados



- Double edge guide max H 48 mm and edge cutting knob
- Doble guía de la banda max H 48 mm y cizalla para el corte de borde



- Stable steel metal work table 682 x 191 mm
- Mesa de trabajo estable 682 x 191 mm



- Working table extension for curved surfaces
- Extensión de la mesa de trabajo para el tratamiento de superficies curvas



2000 W



18-30



∅ max 48 mm



350° - 500°



12 Kg



730x420x255



DOWNLOAD  
THE VIDEO  
DESCARGA  
EL VIDEO

# STANDY

ART.	CODE   CÓDIGO
390	7.13.36.87



## TECHNICAL FEATURES

- Sturdy stoved painted steel structure.
- Pre-arranged to be fixed on the floor.
- Maximum charge 150 Kg.

## CARACTERÍSTICAS TÉCNICAS

- Robusta estructura de acero pintada en caliente.
- Está adaptada para ser fijada al piso
- Max posibilidad de carga: 150 Kg.

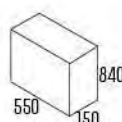

WOOD SUPPORT FOR  
FIXING MITRESAWS  
TO THE COLUMN  
(INCLUDED)  
BASE DE FIJACIÓN DE  
MADERA INCLUIDA



## UNIVERSAL COLUMN FOR MITRESAWS BASE EXPOSITORA UNIVERSAL PARA TRONZADORAS DE MADERA

ART.	CODE CÓDIGO	FOR ART. PARA ART.	Kg
390	7.13.36.87	All the mitresaws Todas las tronadoras	15

# JOBBY

ART.	CODE   CÓDIGO
300 PLUS	7.13.36.48



Safety system against  
accidental locking  
Sistema de seguridad  
contra un cierre  
accidental

## TECHNICAL FEATURES

- Foldable for easy handling.
- Sturdy steel section structure.
- Height adjustable in three positions.
- Maximum charge 50 Kg.

## CARACTERÍSTICAS TÉCNICAS

- Plegable para un fácil transporte.
- Estructura de perfil de acero robusto.
- Altura regulable en tres posiciones.
- Max posibilidad de carga 50 Kg.

## FOLDING TABLE | BANCO PLEGABLE

Size AxBxH   Dimensiones AxBxH	For ART.   Para ART.
650x420x740/820/870	ABS105-ABS NG160-ABS NG120 780XL-782XL-783XL-784XL NG120XL-785XL-NG160

# MULTY

ART.	CODE   CÓDIGO
360	7.13.36.47



## TECHNICAL FEATURES

- Sturdy solid aluminium structure
- Universal couple of brackets for the bandsaw and mitresaw fixing
- Possibility to electrically connect three tools
- Integrated handle for an easy transport
- Side supports extensible, height and width adjustable
- Maximum charge: 120 Kg

## CARACTERÍSTICAS TÉCNICAS

- Robusta estructura en perfilado de aluminio.
- Par de abrazaderas universales para fijar tronadoras y SIERRA de cinta.
- Posibilidad de conectar eléctricamente hasta 3 aparatos
- Empuñadura integrada para un fácil transporte
- Apoyos laterales extensibles, regulables en alto y ancho
- Max posibilidad de carga 120 Kg

## FOLDING TABLE | BANCO PLEGABLE

For ART. Para ART.	Kg
All the mitresaws   Todas las tronadoras	20



SLIDING KIT | KIT DE DESLIZE



CODE / CÓDIGO

FOR ART. / PARA ART.

7.07.50.36

911 EVO - 999 EVO  
XXX EVO - XXX EVO ALU - 305 PRO



CLAMPS | MORDAZAS UNIVERSALES



CODE / CÓDIGO

FOR ART. / PARA ART.

7.13.05.57 - Frontal/Horizontal

305S - 280S - 732 - 733

7.13.07.01 - Vertical/Vertical

XXX EVO - 305 PRO - 911 - 999 EVO  
XXX EVO ALU - 846 - 846 ALU - 300 SPECIAL - 842

7.13.06.07 - Frontal/Horizontal

XXX EVO - XXX EVO ALU

7.13.06.41 - Frontale/Horizontal

305 PRO - 911 - 999 - 846 - 846 ALU  
300 SPECIAL - 842

LATERAL EXTENSION | EXTENSIÓN LATERAL

Lateral extension of the upper table

- Lateral extension in aluminium extrusion
- Accurate and steady fixing
- Increases the upper table dimensions from 305mm x 485 mm to 455mm x 485mm

Extensión lateral de la mesa superior

- Extensión lateral en extrusión de aluminio
- Fijación precisa y estable
- Aumenta el tamaño de la mesa superior de 305mm x 485 mm a 455mm x 485mm

CODE / CÓDIGO

FOR ART. / PARA ART.

7.07.50.77

911 EVO - 999 EVO - XXX EVO - 305 PRO



ART.

CODE | CÓDIGO

301

7.13.36.02

SINGLE-ROLLER SUPPORT | SOPORTE MONO-RODILLO

ART.

CODE | CÓDIGO

SIZE | DIMENSIONES AxBxH (mm)

WEIGHT | PESO

301

7.13.36.02

520x400x680=1140

6,5 Kg.

TECHNICAL FEATURES

- Zinc-plated steel roller Ø 57 mm.
- Sturdy steel structure.
- Base equipped with leveling feet.
- Support height adjustment.

CARACTERÍSTICAS TÉCNICAS

- Rodillo de acero galvanizado Ø 57 mm.
- Robusta estructura de acero, hierro fundido.
- Base provista de pies de nivelación.
- Regulación de la altura de apoyo.



GRADUATED GONIOMETER | GONIÓMETRO GRADUADO

CODE / CÓDIGO

CODE / CÓDIGO

FOR ART. / PARA ART.

5.13.07.68

0° - 60° left-right

60LD-XXX2-911-999-846-300 SPECIAL-842



DUST COLLECTION BAG | BOLSA DE RECOGIDA DE VIRUTAS

CODE / CÓDIGO

FOR ART. / PARA ART.

7.07.50.32

All the mitresaws / Todas las tronadoras



MITRESAW DUST COLLECTOR ADAPTER | ADAPTADOR ASPIRACION PARA TRONAZADORAS

CODE  
CÓDIGO

Ø REDUCTION  
Ø REDUCCIÓN

Ø MITRESAW COUPLING  
Ø ACOPLE TRONAZADORA

FOR ART.  
PARA ART.

5.06.10.44

100 mm

40 mm

All the mitresaws  
Todas las tronadoras

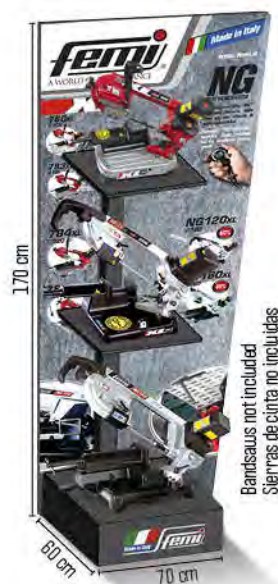

Bandsaws not included  
Sierras de cinta no incluidas

## METAL LINE LÍNEA METAL

**Metal display**  
**Expositor metal**

cod. 7.13.36.72  
weight / peso: 30 kg  
Maximum charge of each shelf:  
30 kg.  
Máxima posibilidad de carga de los  
estantes: 30 kg  
Maximum charge of bottom base:  
35 kg.  
Máxima posibilidad de carga de la  
base: 35 kg

**Cardboard panel**  
**Panel de cartón**

cod. 7.13.36.74



Mitresaws not included  
Tronzadoras no incluidas

## WOOD LINE LÍNEA MADERA

**Metal display**  
**Expositor metal**

cod. 7.13.36.72  
weight / peso: 30 kg  
Maximum charge of each shelf:  
30 kg.  
Máxima posibilidad de carga de los  
estantes: 30 kg  
Maximum charge of bottom base:  
35 kg.  
Máxima posibilidad de carga de la  
base: 35 kg

**Cardboard panel**  
**Panel de cartón**

cod. 7.13.36.69



Blades not included  
Hojas de cinta no incluidas

## PODIUM

cod. 0.00.06.26  
62,5 x 87 x 62,5 cm  
weight / peso: 14 kg

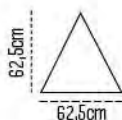

Blades not included  
Discos no incluidas

## PODIUM

cod. 0.00.06.26  
62,5 x 87 x 62,5 cm  
weight / peso: 14 kg

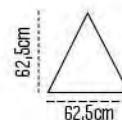

**Cardboard display**  
**for 787 xl allroad**

**Panel de cartón**  
**para 787 xl allroad**

cod. 7.13.36.71  
h. 180 cm  
weight / peso: 1 kg

## BENCH GRINDERS ESMERILADORAS

**GRINDV**

cod. 7.13.36.96  
Display column for bench grinders  
Base expositora para esmeriladoras  
weight / peso: 13 kg



## TRY ME! DEMO KIT

Cardboard display  
Panel de cartón

cod. 0.00.07.86  
weight/peso: 3,8 kg

ASK to  
TRY ME!

Made in Italy

**femi**  
A WORLD OF PERFORMANCE



Bandsaw  
not included  
Sierra de cinta  
no incluida

Made in Italy

**femi**  
A WORLD OF PERFORMANCE

www.femi.it



**femi**

45 cm

78 cm

190 cm



ART. 300  
"JOBBY"

Metal band saw spare blade  
Hoja de cinta adicional



Metal piece for cutting tests  
Pieza de metal para pruebas de corte



Flyers 16 x 23 cm  
Folletos 16 x 23 cm



DOWNLOAD  
THE VIDEO  
DESCARGA  
EL VIDEO

# SYMBOLS | SIMBOLOGIA

-  Winding safety thermic protection  
Protección térmica de seguridad de los bobinados
-  Single-phase electricmotor 230 v - 50 hz  
Motor eléctrico monofásico 230 v - hz 50
-  Three-phase electric motor at 1 or 2 speeds 400 v - 50 hz  
Motor eléctrico trifásico de 1 ó 2 velocidades 400v - hz 50
-  Blade tensioning device with light indicator and safety microswitch  
Tensor de la hoja con indicador luminoso y microinterruptor deseguridad
-  Ce certification: in compliance with eec directives 2004/108 - 2006/42 - 2006/95  
Certificación ce: conformidad con las directivas cee 2004/108 - 2006/42- 2006/95
-  Digital electronically controlled constant speed  
Velocidad constante con control electrónico digital
-  Electronic speed adjustment  
Regulación electrónica de la velocidad
-  Two speeds, electronically switched  
Dos velocidades con conmutación electrónica
-  Two speeds, polar switched motor  
Dos velocidades con conmutación polar del motor
-  Dust collection system  
Sistema de aspiración del polvo
-  Double safety insulation  
Doble aislamiento de seguridad
-  Grit: the higher the number the finer the grain.  
Granulometría a un número más alto corresponde un gr
-  Ultra-low safety tension controls (24 volt)  
Mandos de seguridad de bajísima tensión (24v)

FEMI SpA reserves the right to make without prior notice all changes which may be necessary to improve the product.  
The general descriptions, pictures and drawings are not binding but only indicative

FEMI SpA se reserva el derecho a realizar cualquier cambio necesario para la mejora del producto, sin necesidad de previo aviso.  
Las descripciones generales, imágenes o dibujos serán sólo indicativos y no vinculantes.



A WORLD OF PERFORMANCE



**FEMI SpA**

Via del Lavoro, 4  
40023 Castel Guelfo (BO) · ITALY  
tel. +39 0542 487611  
fax +39 0542 488226  
infocom@femi.it



**FEMI France Sarl**

16 ter Avenue de la République  
69200 Vénissieux · FRANCE  
Tel: +33 (0) 6-70872212  
Fax: +33 (0) 9-71703428  
stephane.femi@orange.fr

**[www.femi.it](http://www.femi.it)**