

# KOMATSU

## PC490-11 PC490LC-11



Hydraulic excavator

**Engine power**  
270 kW / 362 HP @ 1900 rpm

**Operating weight**  
PC490-11: 46470 - 47410 kg  
PC490LC-11: 47370 - 48860 kg

**Bucket capacity**  
max. 3.50 m<sup>3</sup>

## PC490/LC-11



Engine power  
**270 kW / 362 HP @ 1900 rpm**

Operating weight  
**PC490-11: 46470 - 47410 kg**  
**PC490LC-11: 47370 - 48860 kg**

Bucket capacity  
**max. 3.50 m<sup>3</sup>**

# Exceptional workability and environmental performance

## Powerful and environmentally friendly

- EU Stage V engine
- Adjustable idle shutdown
- Komatsu fuel-saving technology

## First-class comfort

- Fully air-suspended operator station
- Low-noise design
- Widescreen monitor with evolutionary interface

## Maximised efficiency

- Up to 11% less fuel consumption
- Built-in versatility and superior productivity
- Enhanced engine management
- Lower hydraulic pressure loss
- Komatsu Integrated Attachment Control (KIAC)

## Safety first

- Komatsu SpaceCab™ (FOPS optional)
- KomVision surround view system
- Neutral position detection system

## Quality you can rely on

- Komatsu-quality components
- Extensive dealer support network

## Komtrax

- Komatsu Wireless Monitoring System
- 4G mobile communications
- Integrated communication antenna
- Increased operational data and fuel savings



A maintenance program for Komatsu customers



### Higher productivity

The PC490/LC-11 is quick and precise. It features a powerful Komatsu EU Stage V engine, Komatsu's Closed Center Load Sensing (CLSS) hydraulic system and first-class Komatsu comfort to provide a fast response and unrivalled productivity for its class.

### Komatsu fuel-saving technology

Fuel consumption on the PC490/LC-11 is lower by up to 11%. Engine management is enhanced. The variable speed matching of the engine and hydraulic pumps guarantee efficiency and precision during single and combined movements.

### Adjustable idle shutdown

The Komatsu auto idle shutdown automatically turns off the engine after it idles for a set period of time. This feature can easily be programmed from 5 to 60 minutes, to reduce unnecessary fuel consumption and exhaust emissions, and to lower operating costs. An Eco-gauge and the Eco guidance tips on the cab monitor further encourage efficient operations.

## Powerful and environmentally friendly

### Komatsu EU Stage V

The Komatsu EU Stage V engine is productive, dependable and efficient. With ultra-low emissions, it provides a lower environmental impact and a superior performance to help reduce operating costs and lets the operator work in complete peace of mind.

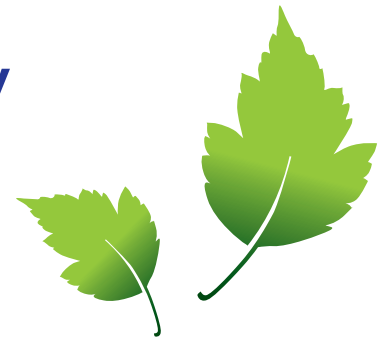

### Heavy-duty aftertreatment

The aftertreatment system combines a Komatsu Diesel Particulate Filter (KDPF) and Selective Catalytic Reduction (SCR). The SCR injects the correct amount of AdBlue® into the system at the proper rate to break down NOx into water (H<sub>2</sub>O) and non-toxic nitrogen gas (N<sub>2</sub>). NOx emissions are reduced by 80% vs. EU Stage IIIB engines.

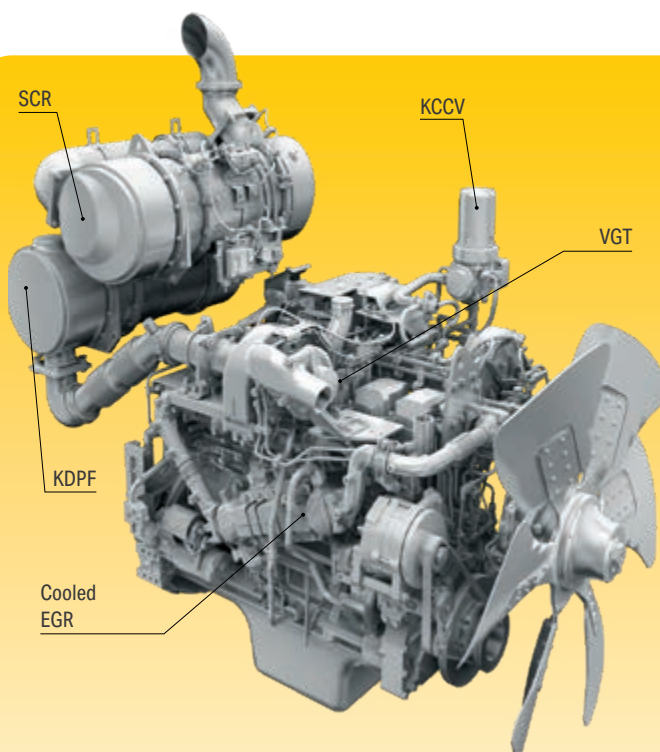
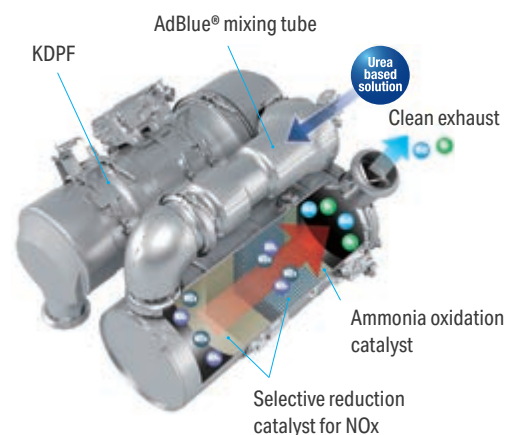

#### High-Pressure Common Rail (HPCR)

To achieve complete fuel burn and lower exhaust emissions, the heavy-duty High-Pressure Common Rail fuel injection system is computer controlled to deliver a precise quantity of pressurised fuel into the redesigned engine combustion chamber by multiple injections.

#### Exhaust Gas Recirculation (EGR)

Cooled EGR is a technology well-proven in current Komatsu engines. The increased capacity of the EGR cooler now ensures very low NOx emissions and a better engine performance.

#### Komatsu Closed Crankcase Ventilation (KCCV)

Crankcase emissions (blow-by gas) are passed through a CCV filter. The oil mist trapped in the filter is returned back to the crankcase while the filtered gas is returned to the air intake.

#### Variable Geometry Turbo (VGT)

The VGT provides optimal airflow to the engine combustion chamber under all speed and load conditions. Exhaust gas is cleaner, fuel economy is improved while machine power and performance are maintained.

# PC490/LC-11

## Large digging force

The two boom mode settings provide a "power" mode for a more effective excavating digging force and a "smooth" mode for gathering material and for fine grading operations. Pressing the PowerMax function button temporarily gives the PC490/LC-11's digging force a further boost.

## 6 working modes

The PC490/LC-11 delivers the power required with the lowest fuel usage. 6 working modes are available: Power, Lifting/Fine Operation, Breaker, Economy, Attachment Power and Attachment Economy. The operator can ideally balance the Economy mode between power and economy to match the work at hand. The oil flow delivered to hydraulic attachments is also adjustable directly on the class-leading widescreen monitor panel.

## A wide choice of options

Two optional attachment lines are available and 15 attachment memory settings are simply customised. Combined with a standard-fit hydraulic quick coupler power circuit, it's easier than ever to switch working styles. For tougher loading applications, the lift capacity and productivity of the PC490/LC-11 can be further enhanced with a short 6.7 m boom, double grouser track shoes, full length track roller guards and an OPG top and a front guard.

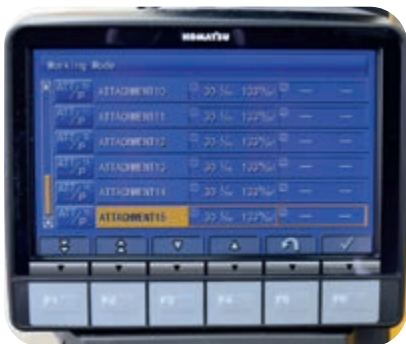

Komatsu Integrated Attachment Control (KIAC) for up to 15 tool presets for oil flow and pressure

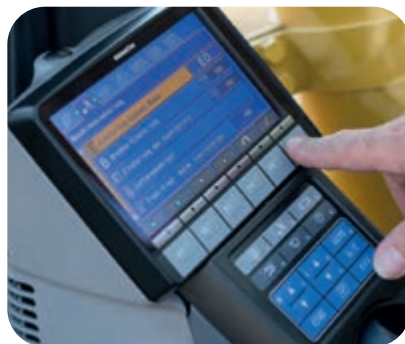

Versatility at your fingertips: select the perfect setting for each job

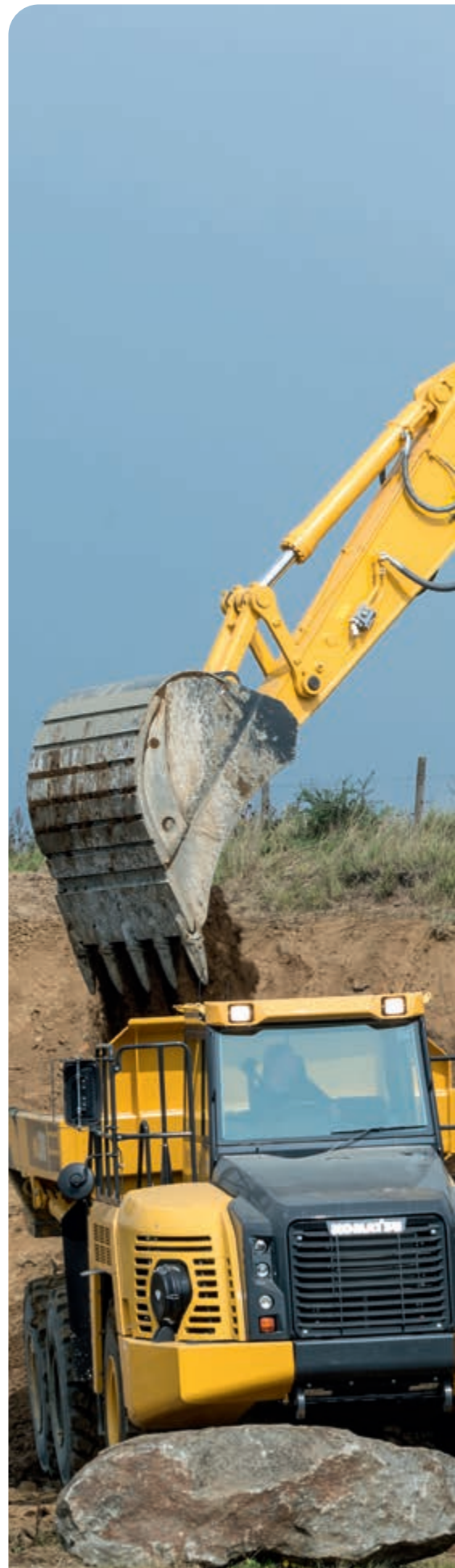

## Maximised efficiency

### Built-in versatility

Powerful and precise, the Komatsu PC490/LC-11 is equipped to efficiently carry out any task your business requires. On all jobsites, big or small, for digging, trenching, landscaping or site preparation, the Komatsu hydraulic system always provides maximum productivity and control.



## First-class comfort

### Increased comfort

In the wide Komatsu SpaceCab™, a standard air-suspended high-back seat, heated for improved comfort and with fully adjustable armrests, is the centre of a comfortable and low-fatigue working environment. High visibility and ergonomic controls further assist to maximise the operator's productivity.

### Perfect operator convenience

In addition to the standard radio, the PC490/LC-11 has an auxiliary input for connecting external devices and play music through the cab speakers. Two 12-volt power ports are also incorporated in the cab. Proportional controls are fitted as standard for safe and precise operation of attachments.

### Low-noise design

Komatsu crawler excavators have very low external noise levels and are especially well-suited for work in confined spaces or urban areas. The optimal usage of sound insulation and of sound absorbing materials helps to make noise levels inside the cab comparable to those of an executive car.



Convenient, ergonomic and precise control: joysticks with proportional control button for attachments



Plenty of storage room, a hot and cool box, a magazine box and a cup holder



Armrest with simple height adjustment



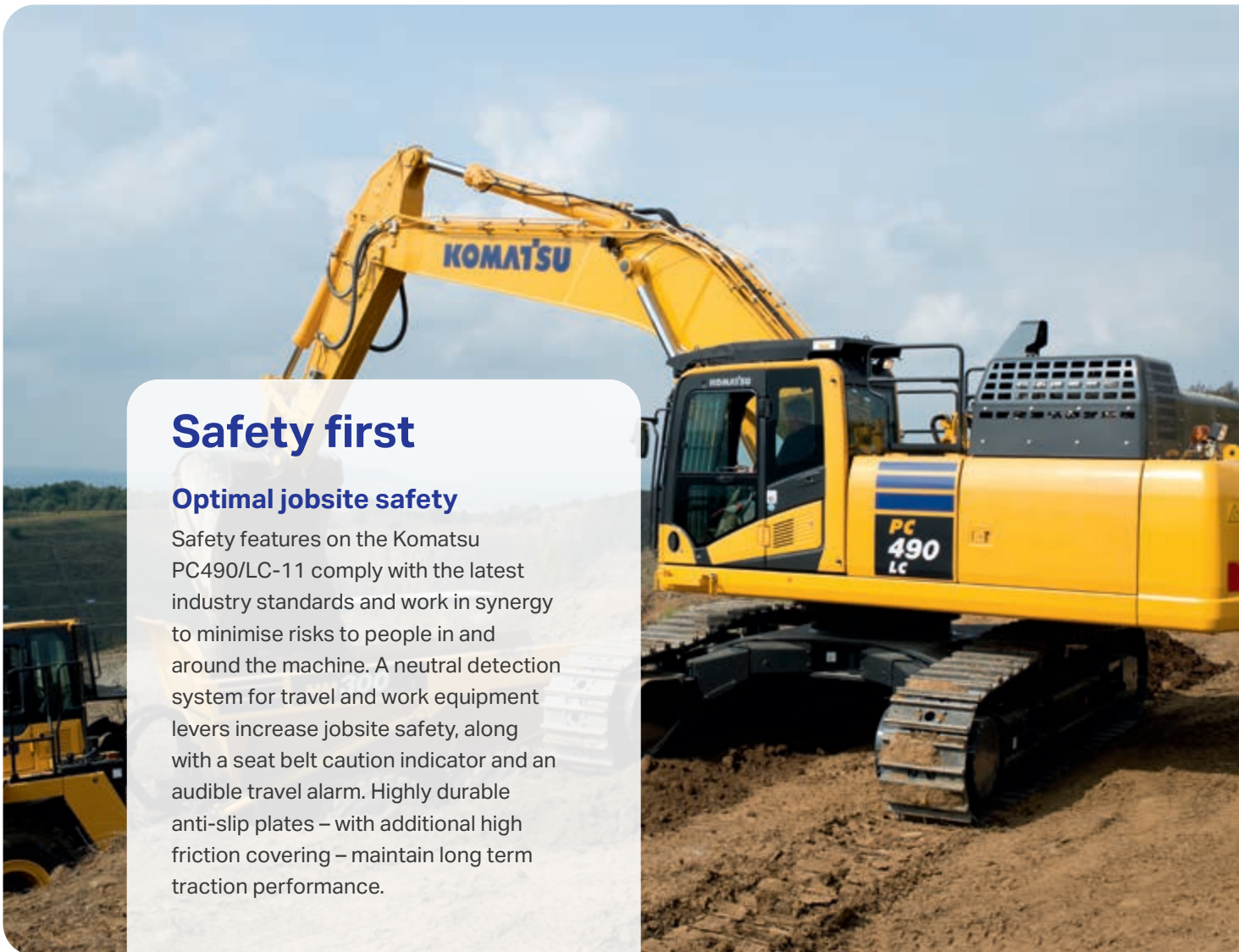

## Safety first

### Optimal jobsite safety

Safety features on the Komatsu PC490/LC-11 comply with the latest industry standards and work in synergy to minimise risks to people in and around the machine. A neutral detection system for travel and work equipment levers increase jobsite safety, along with a seat belt caution indicator and an audible travel alarm. Highly durable anti-slip plates – with additional high friction covering – maintain long term traction performance.



### Safe maintenance

Thermal guards around high temperature areas of the engine, protected fan belt and pulleys, a pump/engine partition that prevents hydraulic oil from spraying onto the engine, a wide catwalk and exceptionally sturdy handrails: in Komatsu tradition, the highest safety level is provided for a fast and smooth maintenance.



### Komatsu SpaceCab™

The ROPS cab has a tubular steel frame and provides high shock absorbency, impact resistance and durability. The seat belt is well designed to keep the operator in the safety zone of the cab in the event of a rollover. Optionally the cab can be fitted with a Falling Object Protective System (FOPS) with openable front guard.



### KomVision

KomVision machine visibility gives the operator a constant clear view of the safety zone around the machine. This allows the operator to focus on the work at hand even in low light conditions.



## An evolutionary interface

Helpful information is now easier than ever to find and understand with the upgraded monitor interface. An optimal main screen for the ongoing work can be selected simply by pressing the F3 key.

## Lower operating costs

Komatsu ICT contributes to the reduction of operating costs by assisting to comfortably and efficiently manage operations. It raises the level of customer satisfaction and the competitive edge of our products.

## Widescreen monitor

Conveniently customisable and with a choice of 26 languages, the widescreen monitor with simple switches and multifunction keys gives fingertip access to a large range of functions and operating info. The rear camera view and an AdBlue® level gauge are now incorporated into the default main screen.



Quick view on the operation logs



With KomVision, various camera view options are available whilst maintaining constant "birdview" from above the machine



Operator identification function

## Information & communication technology



### Knowledge

You get quick answers to basic and critical questions about your machines – what they're doing, when they did it, where they're located, how they can be used more efficiently and when they need to be serviced. Performance data is relayed by wireless communication technology (satellite, GPRS or 4G depending on model) from the machine to a computer and to the local Komatsu distributor – who's readily available for expert analysis and feedback.

### Convenience

Komtrax enables convenient fleet management on the web, wherever you are. Data is analysed and packaged specifically for effortless and intuitive viewing in maps, lists, graphs and charts. You can foresee eventual maintenance issues and required spare parts, and troubleshoot a problem before Komatsu technicians arrive on site.



### The way to higher productivity

Komtrax uses the latest wireless monitoring technology. Compatible on PC, smartphone or tablet, it delivers insightful and cost saving information about your fleet and equipment, and offers a wealth of information to facilitate peak machine performance. By creating a tightly integrated web of support it allows proactive and preventive maintenance and helps to efficiently run a business.

### Power

The detailed information that Komtrax puts at your fingertips 24 hours a day, 7 days a week gives the power to make better daily and long-term strategic decisions – at no extra cost. Problems can be anticipated, maintenance schedules customised, downtime minimised and machines kept where they belong: working on the jobsite.



## Easy maintenance



### Central service points

Komatsu designed the PC490/LC-11 with centralised and conveniently located service points to make necessary inspections and maintenance quick and easy.

### Komatsu Care

Komatsu Care is a maintenance program that comes as standard with your new Komatsu machine. It covers factory-scheduled maintenance, performed with Komatsu Genuine parts by Komatsu-trained technicians. Depending on your machine's engine, it also offers extended coverage of the Komatsu Diesel Particulate Filter (KDPF) and of the Selective Catalytic Reduction (SCR). Please contact your local Komatsu distributor for terms and conditions.

### Long-life oil filters

The Komatsu Genuine hydraulic oil filter uses high-performance filtering material for long replacement intervals, which significantly reduces maintenance costs.



### AdBlue® tank

For simple access, the AdBlue® tank is installed on the front stairway.

### Flexible warranty

When you purchase Komatsu equipment, you gain access to a broad range of programmes and services that have been designed to help you get the most from your investment. For example, Komatsu's Flexible Warranty Programme provides a range of extended warranty options on the machine and its components. These can be chosen to meet your individual needs and activities. This programme is designed to help reduce total operating costs.

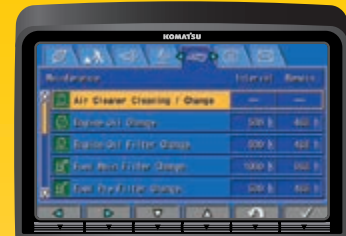

Basic maintenance screen

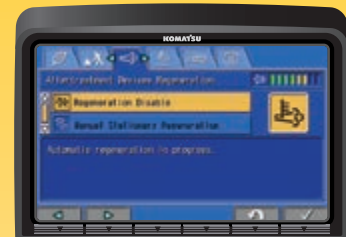

Aftertreatment device regeneration screen for the KDPF

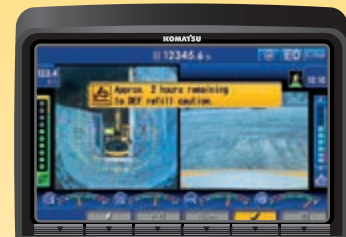

AdBlue® level and refill guidance



## Quality you can rely on

### Komatsu-quality

With the latest computer techniques and a thorough test programme, Komatsu produces equipment to meet your highest standards. All major components of the PC490/LC-11 are designed and directly manufactured by Komatsu, and essential machine functions are perfectly matched for a highly reliable and productive excavator.

### Rugged design

Maximum toughness and durability are the cornerstones of Komatsu's philosophy – along with safety and top class customer service. Single piece plates and castings are used in key areas of the machine's structure for good load distribution. Highly durable rubbing strips on the underside of the arm protect the structure against impact damage.

### Extensive support network

The extensive Komatsu distribution and dealer network is standing by to help keep your fleet in optimum condition. Customised servicing packages are available, with express availability of spare parts, to make sure that your Komatsu equipment continues to perform at its peak.



Durable and reliable undercarriage design for maximum protection



Work equipment designed for strength and durability

# Specifications

## Engine

Model	Komatsu SAA6D125E-7
Type	Common rail direct injection, water-cooled, emissionised, turbocharged, after-cooled diesel
Engine power	
at rated engine speed	1900 rpm
ISO 14396	270 kW / 362 HP
ISO 9249 (net engine power)	268 kW / 359 HP
No. of cylinders	6
Bore × stroke	125 × 150 mm
Displacement	11.04 l
Air filter type	Double element type with monitor panel dust indicator and auto dust evacuator
Cooling	Suction type cooling fan with radiator fly screen
Fan drive type	Hydraulic, reversible
Fuel	Diesel fuel, conforming to EN 590 Class 2/Grade D. Paraffinic fuel capability (HVO, GTL, BTL), conforming to EN 15940:2016

## Hydraulic system

Type	HydrauMind. Closed-centre system with load sensing and pressure compensation valves
Additional circuits	2 additional circuits with proportional control can be installed
Main pump	2 variable displacement piston pumps supplying boom, arm, bucket, swing and travel circuits
Maximum pump flow	2 × 345 l/min
Relief valve settings	
Implement	380 kg/cm <sup>2</sup>
Travel	380 kg/cm <sup>2</sup>
Swing	285 kg/cm <sup>2</sup>
Pilot circuit	33 kg/cm <sup>2</sup>

## Service refill capacities

Fuel tank	650 l
Radiator	47.0 l
Engine oil	37.0 l
Swing drive	20.0 l
Hydraulic tank	248 l
Final drive (each side)	10.5 l
AdBlue® tank	39.0 l

## Swing system

Type	Axial piston motor driving through planetary double reduction gearbox
Swing lock	Electrically actuated wet multidisc brake integrated into swing motor
Swing speed	0 - 9.1 rpm
Swing torque	132 kNm

## Drives and brakes

Steering control	2 levers with pedals giving full independent control of each track
Drive method	Hydrostatic
Travel operation	Automatic 3-speed selection
Gradeability	70%, 35°
Max. travel speeds	
Lo / Mi / Hi	3.0 / 4.2 / 5.5 km/h
Maximum drawbar pull	34000 kg
Brake system	Hydraulically operated discs in each travel motor

## Undercarriage

Construction	X-frame centre section with box section track frames
Track assembly	
Type	Fully sealed
Shoes (each side)	46 (PC490), 49 (PC490LC)
Tension	Combined spring and hydraulic unit
Rollers	
Track rollers (each side)	7 (PC490), 8 (PC490LC)
Carrier rollers (each side)	2

## Environment

Engine emissions	Fully complies with EU Stage V exhaust emission regulations
Noise levels	
LwA external	107 dB(A) (2000/14/EC Stage II)
LpA operator ear	71 dB(A) (ISO 6396 dynamic test)
Vibration levels (EN 12096:1997)	
Hand/arm	≤ 2.5 m/s <sup>2</sup> (uncertainty K = 0.25 m/s <sup>2</sup> )
Body	≤ 0.5 m/s <sup>2</sup> (uncertainty K = 0.25 m/s <sup>2</sup> )
Contains fluorinated greenhouse gas HFC-134a (GWP 1430). Quantity of gas 1.0 kg, CO <sub>2</sub> equivalent 1.43 t	

## Operating weight (appr.)

	PC490-11		PC490LC-11	
	Operating weight	Ground pressure	Operating weight	Ground pressure
Triple grouser shoes				
600 mm	46470 kg	0.88 kg/cm <sup>2</sup>	47370 kg	0.84 kg/cm <sup>2</sup>
700 mm	46940 kg	0.76 kg/cm <sup>2</sup>	47870 kg	0.73 kg/cm <sup>2</sup>
800 mm	47410 kg	0.68 kg/cm <sup>2</sup>	48370 kg	0.64 kg/cm <sup>2</sup>
900 mm	-	-	48860 kg	0.58 kg/cm <sup>2</sup>
Double grouser shoes				
600 mm	46590 kg	0.89 kg/cm <sup>2</sup>	47490 kg	0.84 kg/cm <sup>2</sup>

Operating weight, including specified work equipment, 7.1 m mono boom, 3.4 m arm, 1915 kg bucket, operator, lubricant, coolant, full fuel tank and the standard equipment.

## PC490-11 / Max. bucket capacity and weight

Arm length	Mono boom									
	2.4 m		2.9 m		3.4 m		4.0 m		4.8 m	
Material weight up to 1.2 t/m <sup>3</sup>	2.76 m <sup>3</sup>	2175 kg	2.76 m <sup>3</sup>	2175 kg	2.76 m <sup>3</sup>	2175 kg	2.76 m <sup>3</sup>	2175 kg	2.76 m <sup>3</sup>	2175 kg
Material weight up to 1.5 t/m <sup>3</sup>	2.76 m <sup>3</sup>	2175 kg	2.76 m <sup>3</sup>	2175 kg	2.76 m <sup>3</sup>	2175 kg	2.76 m <sup>3</sup>	2175 kg	2.73 m <sup>3</sup>	2175 kg
Material weight up to 1.8 t/m <sup>3</sup>	2.76 m <sup>3</sup>	2175 kg	2.76 m <sup>3</sup>	2175 kg	2.71 m <sup>3</sup>	2175 kg	2.71 m <sup>3</sup>	2175 kg	2.38 m <sup>3</sup>	2000 kg

## PC490LC-11 / Max. bucket capacity and weight

Arm length	Mono boom									
	2.4 m		2.9 m		3.4 m		4.0 m		4.8 m	
Material weight up to 1.2 t/m <sup>3</sup>	2.76 m <sup>3</sup>	2175 kg	2.76 m <sup>3</sup>	2175 kg	2.76 m <sup>3</sup>	2175 kg	2.76 m <sup>3</sup>	2175 kg	2.76 m <sup>3</sup>	2175 kg
Material weight up to 1.5 t/m <sup>3</sup>	2.76 m <sup>3</sup>	2175 kg	2.76 m <sup>3</sup>	2175 kg	2.76 m <sup>3</sup>	2175 kg	2.76 m <sup>3</sup>	2175 kg	2.73 m <sup>3</sup>	2175 kg
Material weight up to 1.8 t/m <sup>3</sup>	2.76 m <sup>3</sup>	2175 kg	2.76 m <sup>3</sup>	2175 kg	2.76 m <sup>3</sup>	2175 kg	2.75 m <sup>3</sup>	2175 kg	2.38 m <sup>3</sup>	2000 kg

## PC490-11 / Max. bucket capacity and weight

Arm length	Short boom			
	2.4 m		2.9 m	
Material weight up to 1.2 t/m <sup>3</sup>	3.50 m <sup>3</sup>	2450 kg	3.50 m <sup>3</sup>	2450 kg
Material weight up to 1.5 t/m <sup>3</sup>	3.50 m <sup>3</sup>	2450 kg	3.50 m <sup>3</sup>	2450 kg
Material weight up to 1.8 t/m <sup>3</sup>	3.18 m <sup>3</sup>	2432 kg	2.95 m <sup>3</sup>	2308 kg

## PC490LC-11 / Max. bucket capacity and weight

Arm length	Short boom			
	2.4 m		2.9 m	
Material weight up to 1.2 t/m <sup>3</sup>	3.50 m <sup>3</sup>	2450 kg	3.50 m <sup>3</sup>	2450 kg
Material weight up to 1.5 t/m <sup>3</sup>	3.50 m <sup>3</sup>	2450 kg	3.50 m <sup>3</sup>	2450 kg
Material weight up to 1.8 t/m <sup>3</sup>	3.38 m <sup>3</sup>	2450 kg	3.10 m <sup>3</sup>	2375 kg

Max. capacity and weight have been calculated according to ISO 10567:2007.

Please consult with your distributor for the correct selection of buckets and attachments to suit the application.

## Bucket and arm force

Arm length	2.4 m	2.9 m	3.4 m	4.0 m	4.8 m
Bucket digging force	26100 kg	26100 kg	26100 kg	26100 kg	26100 kg
Bucket digging force at PowerMax	28000 kg	28000 kg	28000 kg	28000 kg	28000 kg
Arm crowd force	24200 kg	24400 kg	20400 kg	18100 kg	15800 kg
Arm crowd force at PowerMax	25900 kg	26200 kg	21800 kg	19400 kg	17000 kg

## Dimensions and performance figures

Machine dimensions	PC490-11	PC490LC-11
A Overall width of upper structure	2995 mm	2995 mm
B Overall height of cab	3360 mm	3360 mm
C Overall length of basic machine	6135 mm	6300 mm
D Tail length	3605 mm	3605 mm
Tail swing radius	3645 mm	3645 mm
E Clearance under counterweight	1385 mm	1385 mm
F Machine tail height	2560 mm	2560 mm
F' Machine tail height (top of engine cover)	3630 mm	3630 mm
G Ground clearance	700 mm	700 mm
H Tumbler centre distance	4020 mm	4350 mm
I Track length	5055 mm	5385 mm
J Track gauge	2890 mm	2890 mm
K Track shoe width	600, 700, 800 mm	600, 700, 800, 900 mm
L Overall track width with 600 mm shoes	3490 - 2990 mm*	3490 - 2990 mm*
Overall track width with 700 mm shoes	3590 - 3090 mm*	3590 - 3090 mm*
Overall track width with 800 mm shoes	3690 - 3190 mm*	3690 - 3190 mm*
Overall track width with 900 mm shoes	-	3790 - 3290 mm*

\* Transport dimensions (retracted)

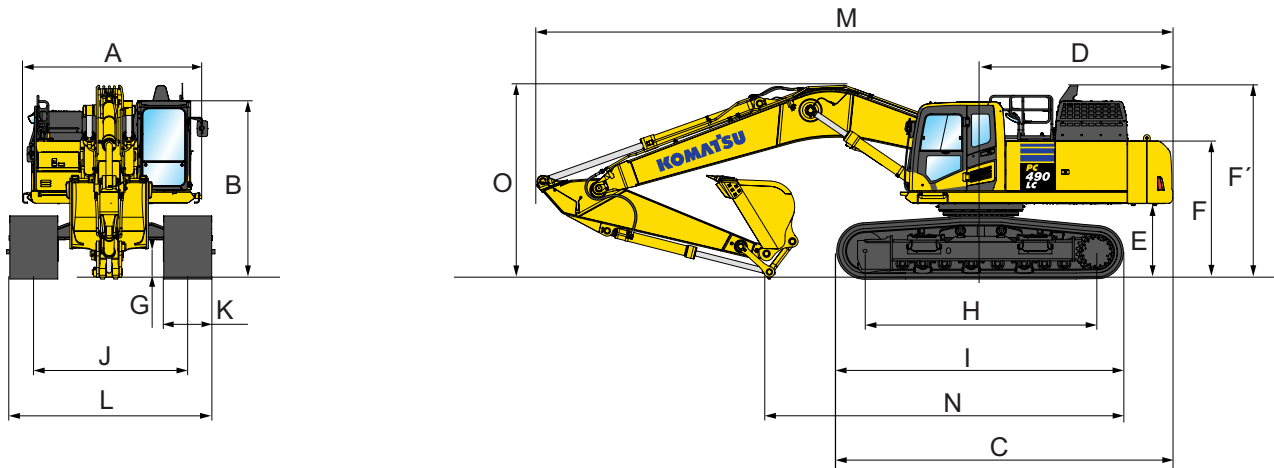

Transport dimensions	Mono boom					Short boom	
	2.4 m	2.9 m	3.4 m	4.0 m	4.8 m	2.4 m	2.9 m
M Transport length	11910 mm	12000 mm	11930 mm	11950 mm	11825 mm	11470 mm	11570 mm
N Length on ground (transport) (PC490-11)	7720 mm	7455 mm	6710 mm	6130 mm	5885 mm	7675 mm	7210 mm
Length on ground (transport) (PC490LC-11)	7885 mm	7620 mm	6875 mm	6295 mm	6050 mm	7840 mm	7380 mm
O Overall height (to top of boom)	3875 mm	3760 mm	3635 mm	3885 mm	4435 mm	3630 mm	3710 mm



# Working range

## Mono boom

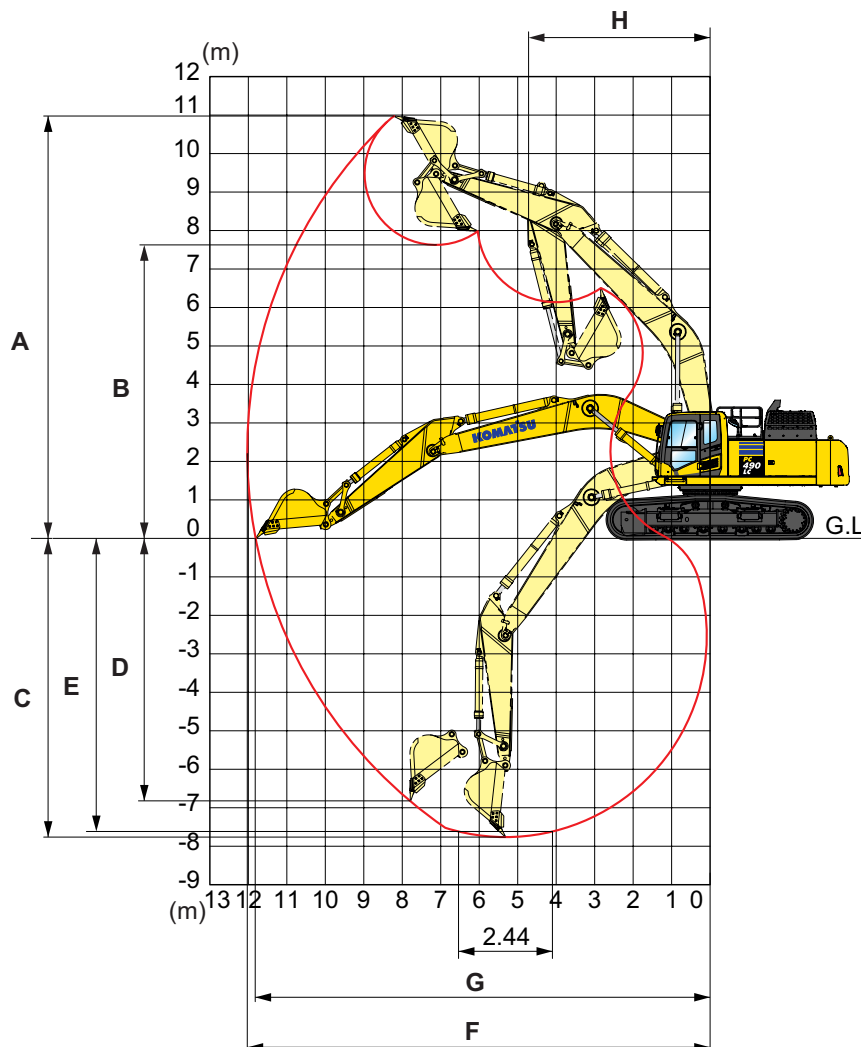

### Working range

### Mono boom

### Short boom

Arm length	2.4 m	2.9 m	3.4 m	4.0 m	4.8 m	2.4 m	2.9 m
A Max. digging height	10375 mm	10350 mm	10980 mm	11090 mm	11550 mm	10510 mm	10550 mm
B Max. dumping height	7135 mm	7145 mm	7630 mm	7780 mm	8210 mm	7075 mm	7115 mm
C Max. digging depth	6780 mm	7280 mm	7755 mm	8380 mm	9190 mm	6365 mm	6865 mm
D Max. vertical wall digging depth	5240 mm	5635 mm	6805 mm	7220 mm	8085 mm	4365 mm	4950 mm
E Max. digging depth of cut for 2.44 m level	6585 mm	7090 mm	7615 mm	8250 mm	9080 mm	5630 mm	6710 mm
F Max. digging reach	11080 mm	11445 mm	12030 mm	12565 mm	13365 mm	10605 mm	10985 mm
G Max. digging reach at ground level	10840 mm	11215 mm	11810 mm	12355 mm	13170 mm	10360 mm	10750 mm
H Min. swing radius	4835 mm	4810 mm	4735 mm	4800 mm	4885 mm	4265 mm	4295 mm

## Lifting capacity

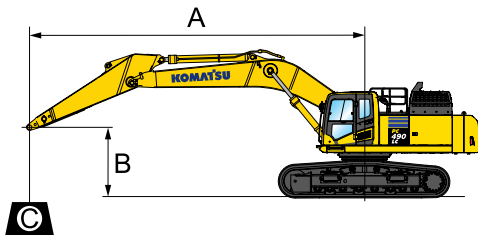

A – Reach from swing center

B – Bucket hook height

C – Lifting capacities

– Rating over front

– Rating over side

– Rating at maximum reach

Weights:  
Bucket linkage and  
bucket cylinder: 490 kg

### PC490-11 Mono boom











With 600 mm shoes

Arm length	A		9.0 m		7.5 m		6.0 m		4.5 m		3.0 m			
	B													
 4.8 m	7.5 m	kg	*6370	*6370	*9480	9310								
	6.0 m	kg	*6300	*6300	*9820	9180								
	4.5 m	kg	*6370	6290	*10440	8940	*11480	*11480						
	3.0 m	kg	*6570	6040	*11170	8660	*12760	11240	*15370	*15370	*20330	*20330		
	1.5 m	kg	*6910	5950	11300	8390	*13960	10770	*17410	14630	*23980	22090		
	0.0 m	kg	*7450	6020	11050	8150	14260	10390	*18740	14030	*24610	21150	*10120	*10120
	-1.5 m	kg	*8260	6270	10880	7990	14000	10140	*19160	13680	*25780	20750	*13950	*13950
	-3.0 m	kg	9180	6790	10820	7940	13880	10040	*18660	13560	*24560	20690	*18840	*18840
	-4.5 m	kg	*9990	7740	*10610	8020	*13580	10080	*17100	13620	*22080	20870	*25120	*25120
	-6.0 m	kg	*9580	*9580			*10700	10320	*14070	13890	*17970	*17970	*23550	*23550

 4.0 m	7.5 m	kg	*7880	*7880	*9970	9150								
	6.0 m	kg	*7820	7630	*10720	9060	*11480	*11480						
	4.5 m	kg	*7940	7050	*11240	8860	*12520	11550	*14620	*14620				
	3.0 m	kg	*8250	6740	11540	8620	*13690	11120	*16750	15170	*22810	*22810		
	1.5 m	kg	*8780	6640	11290	8390	14600	10720	*18460	14470	*23800	21680		
	0.0 m	kg	9060	6750	11100	8210	14280	10420	*19320	14020	*22690	21110		
	-1.5 m	kg	9560	7100	10990	8110	14100	10250	*19230	13800	*25360	20950	*15150	*15150
	-3.0 m	kg	10560	7810	11010	8130	14070	10220	*18170	13780	*23390	21050	*21760	*21760
	-4.5 m	kg	*10710	9200			*12490	10360	*15910	13940	*20120	*20120	*25940	*25940
	-6.0 m	kg	*9760	*9760					*11580	*11580	*14840	*14840		

 3.4 m	7.5 m	kg	*9140	*9140			*11710	*11710						
	6.0 m	kg	*9040	8290	*11420	8970	*12310	11800						
	4.5 m	kg	*9190	7620	11740	8820	*13280	11450	*15730	*15730	*20530	*20530		
	3.0 m	kg	*9560	7270	11520	8620	*14340	11060	*17720	15010	*24590	22490		
	1.5 m	kg	9590	7170	11320	8420	14600	10720	*19130	14420	*17760	*17760		
	0.0 m	kg	9820	7320	11170	8290	14340	10480	*19600	14080	*20720	*20720		
	-1.5 m	kg	10450	7770	11120	8240	14220	10370	*19100	13950	*24620	21230	*15450	*15450
	-3.0 m	kg	*11400	8690			*14020	10400	*17580	14000	*22140	21400	*24050	*24050
	-4.5 m	kg	*10880	10560			*11020	10640	*14650	14230	*18250	*18250	*22170	*22170
	-6.0 m	kg												



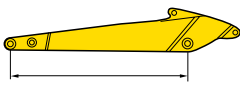

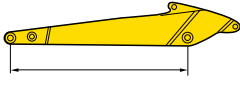





\* Load is limited by hydraulic capacity rather than tipping. Ratings are based on SAE Standard No. J1097. Rated loads do not exceed 87% of hydraulic lift capacity or 75% of tipping load. Lifting capacity stated is based on lifting with bare arm. When lifting with additional equipment installed to the arm, please subtract the weight of all additional equipment from the values stated.

Arm length	A		9.0 m		7.5 m		6.0 m		4.5 m		3.0 m			
	B													
 <p>2.9 m</p>	7.5 m	kg	*12150	10610			*12310	11810						
	6.0 m	kg	*11930	9070			*12790	11620	*14530	*14530				
	4.5 m	kg	10980	8230	11600	8680	*13680	11280	*16380	15470				
	3.0 m	kg	10440	7800	11410	8500	*14630	10910	*18200	14750				
	1.5 m	kg	10320	7690	11230	8340	14460	10590	*19330	14220				
	0.0 m	kg	10610	7870	11110	8230	14240	10390	*19460	13940				
	-1.5 m	kg	11420	8440			14170	10330	*18630	13890	*23440	21190		
	-3.0 m	kg	*12110	9630			*13280	10410	*16740	14000	*20660	*20660	*24100	*24100
	-4.5 m	kg	*11370	*11370					*13180	*13180	*16280	*16280		
	-6.0 m	kg												

 <p>2.4 m</p>	7.5 m	kg	*11060	10910			*13240	11760						
	6.0 m	kg	*10630	9330			*13540	11630	*15500	*15500				
	4.5 m	kg	*10570	8490	11660	8760	*14340	11340	*17310	15450				
	3.0 m	kg	10770	8080	11510	8620	14890	11010	*18990	14800				
	1.5 m	kg	10690	8000	11380	8490	14610	10750	*19810	14370				
	0.0 m	kg	11040	8240	11310	8430	14440	10590	*19580	14190				
	-1.5 m	kg	11940	8880			14420	10570	*18400	14190	*22330	21690		
	-3.0 m	kg	*11380	10220			*12470	10720	*16070	14340	*19340	*19340	*20410	*20410
	-4.5 m	kg	*9680	*9680					*11510	*11510	*14400	*14400		
	-6.0 m	kg												

PC490-11 Short boom

With 600 mm shoes

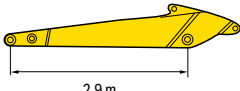
Arm length	A		9.0 m		7.5 m		6.0 m		4.5 m		3.0 m			
	B													
 <p>2.9 m</p>	6.0 m	kg	*12660	9390			*13750	12610	*14950	*14950				
	4.5 m	kg	11440	8470	11440	8470	*14750	12240	*16640	15290	*21690	*21690		
	3.0 m	kg	10850	8010			*15840	11810	*18380	14600				
	1.5 m	kg	10730	7900			15890	11440	*19480	14070				
	0.0 m	kg	11070	8110			15640	11210	*19560	13770	*25650	20810		
	-1.5 m	kg	12010	8760			15560	11140	*18520	13700	*23550	20870	*20560	*20560
	-3.0 m	kg	*12030	10150			*13660	11250	*16160	13830	*20180	*20180	*23870	*23870
	-4.5 m	kg	*10620	*10620					*11420	*11420	*14740	*14740		

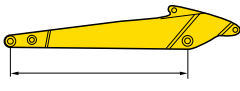
 <p>2.4 m</p>	6.0 m	kg	*13690	10170			*14570	12600	*15930	15840			
	4.5 m	kg	12300	9120			*15480	12270	*17560	15260			
	3.0 m	kg	11640	8620			16360	11890	*19140	14650			
	1.5 m	kg	11530	8510			16030	11590	*19940	14210			
	0.0 m	kg	11950	8790			15840	11420	*19650	14010			
	-1.5 m	kg	*12910	9590			*15600	11400	*18200	14000	*22490	21330	
-3.0 m	kg	*12110	11330			*12550	11590	*15260	14180	*18700	*18700	*20230	*20230
-4.5 m	kg												

\* Load is limited by hydraulic capacity rather than tipping. Ratings are based on SAE Standard No. J1097. Rated loads do not exceed 87% of hydraulic lift capacity or 75% of tipping load. Lifting capacity stated is based on lifting with bare arm. When lifting with additional equipment installed to the arm, please subtract the weight of all additional equipment from the values stated.

## Lifting capacity

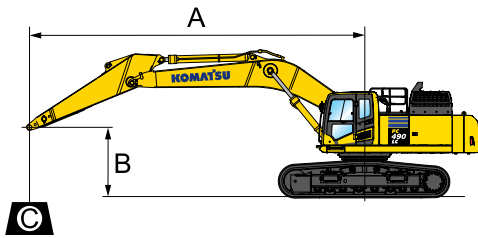

A – Reach from swing center

B – Bucket hook height

C – Lifting capacities

– Rating over front

– Rating over side

– Rating at maximum reach

Weights:  
Bucket linkage and  
bucket cylinder: 490 kg

### PC490LC-11 Mono boom











With 600 mm shoes

Arm length	A		9.0 m		7.5 m		6.0 m		4.5 m		3.0 m			
	B													
 4.8 m	7.5 m	kg	*6370	*6370	*9480	9460								
	6.0 m	kg	*6300	*6300	*9820	9320								
	4.5 m	kg	*6370	*6370	*10440	9090	*11480	*11480						
	3.0 m	kg	*6570	6140	*11170	8810	*12760	11420	*15370	*15370	*20330	*20330		
	1.5 m	kg	*6910	6050	*11870	8530	*13960	10950	*17410	14880	*23980	22460		
	0.0 m	kg	*7450	6130	12350	8300	*14820	10570	*18740	14270	*24610	21510	*10120	*10120
	-1.5 m	kg	*8260	6390	12180	8140	*15160	10330	*19160	13930	*25780	21120	*13950	*13950
	-3.0 m	kg	*9540	6910	*12080	8080	*14830	10220	*18660	13800	*24560	21060	*18840	*18840
	-4.5 m	kg	*9990	7880	*10610	8160	*13580	10260	*17100	13870	*22080	21240	*25120	*25120
	-6.0 m	kg	*9580	*9580			*10700	10510	*14070	*14070	*17970	*17970	*23550	*23550

 4.0 m	7.5 m	kg	*7880	*7880	*9970	9290								
	6.0 m	kg	*7820	7750	*10720	9200	*11480	*11480						
	4.5 m	kg	*7940	7170	*11240	9010	*12520	11730	*14620	*14620				
	3.0 m	kg	*8250	6860	*11860	8770	*13690	11300	*16750	15410	*22810	*22810		
	1.5 m	kg	*8780	6760	*12410	8540	*14690	10900	*18460	14710	*23800	22050		
	0.0 m	kg	*9600	6870	12400	8360	*15290	10600	*19320	14260	*22690	21470		
	-1.5 m	kg	10660	7230	12290	8260	*15280	10430	*19230	14040	*25360	21320	*15150	*15150
	-3.0 m	kg	*10920	7950	*11560	8270	*14500	10400	*18170	14020	*23390	21410	*21760	*21760
	-4.5 m	kg	*10710	9360			*12490	10540	*15910	14180	*20120	*20120	*25940	*25940
	-6.0 m	kg	*9760	*9760					*11580	*11580	*14840	*14840		

 3.4 m	7.5 m	kg	*9140	*9140			*11710	*11710						
	6.0 m	kg	*9040	8430	*11420	9120	*12310	11980						
	4.5 m	kg	*9190	7750	*11820	8960	*13280	11640	*15730	*15730	*20530	*20530		
	3.0 m	kg	*9560	7390	*12340	8760	*14340	11250	*17720	15260	*24590	22860		
	1.5 m	kg	*10220	7300	12620	8570	*15180	10900	*19130	14660	*17760	*17760		
	0.0 m	kg	10930	7450	12470	8430	*15540	10660	*19600	14320	*20720	*20720		
	-1.5 m	kg	*11510	7910	*12360	8380	*15240	10560	*19100	14200	*24620	21590	*15450	*15450
	-3.0 m	kg	*11400	8840			*14020	10590	*17580	14250	*22140	21770	*24050	*24050
	-4.5 m	kg	*10880	10740			*11020	10820	*14650	14480	*18250	*18250	*22170	*22170
	-6.0 m	kg												



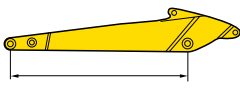

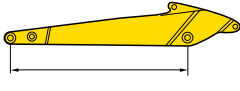





\* Load is limited by hydraulic capacity rather than tipping. Ratings are based on SAE Standard No. J1097. Rated loads do not exceed 87% of hydraulic lift capacity or 75% of tipping load. Lifting capacity stated is based on lifting with bare arm. When lifting with additional equipment installed to the arm, please subtract the weight of all additional equipment from the values stated.

Arm length	A		9.0 m		7.5 m		6.0 m		4.5 m		3.0 m			
	B													
 2.9 m	7.5 m	kg	*12150	10780			*12310	11990						
	6.0 m	kg	*11930	9220			*12790	11800	*14530	*14530				
	4.5 m	kg	*11890	8370	*12130	8830	*13680	11460	*16380	15720				
	3.0 m	kg	11630	7940	*12530	8650	*14630	11090	*18200	14990				
	1.5 m	kg	11510	7820	12530	8480	*15310	10770	*19330	14460				
	0.0 m	kg	11840	8010	12410	8370	*15480	10570	*19460	14190				
	-1.5 m	kg	*12250	8590			*14920	10510	*18630	14130	*23440	21560		
	-3.0 m	kg	*12110	9800			*13280	10600	*16740	14240	*20660	*20660	*24100	*24100
	-4.5 m	kg	*11370	*11370					*13180	*13180	*16280	*16280		
	-6.0 m	kg												

 2.4 m	7.5 m	kg	*11060	*11060			*13240	11940						
	6.0 m	kg	*10630	9480			*13540	11810	*15500	*15500				
	4.5 m	kg	*10570	8630	*12710	8900	*14340	11520	*17310	15690				
	3.0 m	kg	*10810	8220	12820	8770	*15180	11190	*18990	15050				
	1.5 m	kg	*11370	8140	12680	8640	*15710	10930	*19810	14620				
	0.0 m	kg	12300	8380	12610	8570	*15660	10780	*19580	14430				
	-1.5 m	kg	*12040	9040			*14790	10750	*18400	14430	*22330	22050		
	-3.0 m	kg	*11380	10400			*12470	10910	*16070	14590	*19340	*19340	*20410	*20410
	-4.5 m	kg	*9680	*9680					*11510	*11510	*14400	*14400		
	-6.0 m	kg												

PC490LC-11 Short boom

With 600 mm shoes

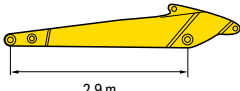
Arm length	A		9.0 m		7.5 m		6.0 m		4.5 m		3.0 m			
	B													
 2.9 m	6.0 m	kg	*12660	9550			*13750	12810	*14950	*14950				
	4.5 m	kg	*12530	8610	*12530	8610	*14750	12430	*16640	15530	*21690	*21690		
	3.0 m	kg	12100	8150			*15840	12000	*18380	14840				
	1.5 m	kg	11980	8030			*16600	11640	*19480	14310				
	0.0 m	kg	12370	8260			*16690	11410	*19560	14010	*25650	21170		
	-1.5 m	kg	*12460	8920			*15860	11340	*18520	13940	*23550	21230	*20560	*20560
	-3.0 m	kg	*12030	10330			*13660	11450	*16160	14070	*20180	*20180	*23870	*23870
-4.5 m	kg	*10620	*10620					*11420	*11420	*14740	*14740			

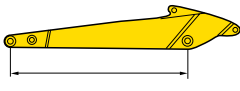
 2.4 m	6.0 m	kg	*13690	10340			*14570	12800	*15930	*15930			
	4.5 m	kg	*13450	9270			*15480	12470	*17560	15500			
	3.0 m	kg	12970	8760			*16440	12090	*19140	14890			
	1.5 m	kg	12860	8660			*17000	11790	*19940	14450			
	0.0 m	kg	*13200	8940			*16810	11620	*19650	14250			
	-1.5 m	kg	*12910	9750			*15600	11600	*18200	14240	*22490	21690	
-3.0 m	kg	*12110	11520			*12550	11780	*15260	14420	*18700	*18700	*20230	*20230
-4.5 m	kg												

\* Load is limited by hydraulic capacity rather than tipping. Ratings are based on SAE Standard No. J1097. Rated loads do not exceed 87% of hydraulic lift capacity or 75% of tipping load. Lifting capacity stated is based on lifting with bare arm. When lifting with additional equipment installed to the arm, please subtract the weight of all additional equipment from the values stated.

## Standard and optional equipment

### Engine

Komatsu SAA6D125E-7 turbocharged common rail direct injection diesel engine	●
EU Stage V compliant	●
Remote hydraulically driven, variable speed, reversible cooling fan	●
Automatic engine warm-up system	●
Engine overheat prevention system	●
Fuel control dial	●
Auto-deceleration function	●
Adjustable idle shutdown	●
Engine key stop	●
Engine ignition can be password secured on request	●
Alternator 24 V / 90 A	●
Starter motor 24 V / 11 kW	●
Batteries 2 × 12 V / 180 Ah	●

### Hydraulic system

Electronic closed-centre load sensing (E-CLSS) hydraulic system (HydrauMind)	●
Pump and engine mutual control (PEMC) system	●
6-working mode selection system; Power mode, Economy mode, Breaker mode, Attachment Power and Attachment Economy mode, and Lifting/Fine Operation mode	●
PowerMax function	●
PPC wrist control levers for arm, boom, bucket and swing, with sliding proportional control for attachments and 3 auxiliary buttons	●
Two-mode boom control	●
Prepared for hydraulic quick-coupler	●
Additional hydraulic functions	○
Komatsu Integrated Attachment Control (KIAC)	○

### Undercarriage

Track roller guards	●
Track frame under-guards	●
600, 700, 800, 900 mm triple grouser shoes	○
600 mm double grouser shoes	○
Full length track roller guards	○

### Drives and brakes

Hydrostatic, 3-speed travel system with automatic shift and planetary gear type final drives, and hydraulic travel and parking brakes	●
PPC control levers and pedals for steering and travel	●

### Cabin

Reinforced safety SpaceCab™; highly pressurised and tightly sealed hyper viscous mounted cab with tinted safety glass windows, large roof window with sun shade, pull-up type front window with locking device, removable lower window, front window wiper with intermittent feature, sun roller blind, cigarette lighter, ashtray, luggage shelf, floor mat	●
Heated, high-back air-suspended seat with lumbar support, console mounted height adjustable arm rests, and retractable seat belt	●
Automatic climate control system	●
12/24 Volt power supplies	●
Beverage holder and magazine rack	●
Hot and cool box	●
Radio (AM/FM)	●
Auxiliary input (MP3 jack)	●
Lower wiper	○
Rain visor (not with OPG)	○
DAB+ digital radio w. auxiliary input (MP3 jack)	○

### Service and maintenance

Automatic fuel line de-aeration	●
Double element type air cleaner with dust indicator and auto dust evacuator	●
Komtrax – Komatsu wireless monitoring system (4G)	●
Komatsu Care – a maintenance program for Komatsu customers	●
Multifunction video compatible colour monitor with Equipment Management and Monitoring System (EMMS) and efficiency guidance	●
Toolkit	●
Service points	○
Automatic greasing system	○

### LED lighting system

Working lights: 2 revolving frame, 1 boom (l.h.)	●
Additional working lights (#1): 2 cab roof (front), 1 cab roof (rear), 1 boom (r.h.), 1 counterweight, beacon	○
Additional working lights (#2): 4 cab roof (front), 1 cab roof (rear), 1 boom (r.h.), 1 counterweight, 2 boom cylinders, 2 revolving frame (l.h. + r.h.), beacon	○

## Safety equipment

KomVision surround view system	●
Electric horn	●
Overload warning device	●
Audible travel alarm	●
Boom safety valves	●
Large handrails, rear-view mirrors	●
Battery main switch	●
ROPS compliant to ISO 12117-2:2008	●
Emergency engine stop switch	●
Seat belt caution indicator	●
Neutral position detection system	●
Arm safety valve	●
OPG Level II front guard (FOPS), hinged type	○
OPG Level II top guard (FOPS)	○

## Work equipment

Mono boom (7.1 m)	○
Short boom (6.7 m)	○
2.4 m; 2.9 m; 3.4 m; 4.0 m; 4.8 m arms	○
Komatsu buckets	○
Komatsu breakers	○

## Other equipment

Standard counterweight	●
Remote greasing for swing circle and pins	●
Electric refuelling pump with automatic shut-off function	●
Biodegradable oil for hydraulic system	○
Customised paint	○

Further equipment on request

- standard equipment
- optional equipment



A wide range of buckets and attachments is available. Your Komatsu distributor is ready to assist you with the selection of suitable options.

This specification sheet may contain attachments and optional equipment that are not available in your area. Please consult your local Komatsu distributor for those items you may require. Materials and specifications are subject to change without notice.

---

Your Komatsu partner:

**KOMATSU**

[komatsu.eu](https://www.komatsu.eu)

