

BUILT TO LAST!
LEADERS IN FRAME STRENGTH

LUNA

GLAMPING



Geodesic Glamping Domes

Specifications Manual 2023



A better way
to experience
nature!

GEODESIC DOMES	04	THE LUNA DOME	38
THE STARGAZER DOME	06	3m Spherical Dome	39
5m Stargazer Dome	08	3m Outdoorsman Dome	40
6m Stargazer Dome	10	3m Chillout Dome	41
7m Stargazer Dome	12		
8m Stargazer Dome	14		
9m Stargazer Dome	16		
10m Stargazer Dome	18		
12m Stargazer Dome	20		
15m Stargazer Dome	22		
STARGAZER ADD-ONS	24		
2 Layer Insulation	26		
Solar Fan	27		
Rooftop Skylight	28		
Skylight Motorized Blind	29		
Curtains	30		
Keyless Entry	31		
Stove Jack	32		
Circle PVC Window	33		
Circle Glass Window	34		
Triangle Mesh Roll-up Window	35		
Glass Door	36		

“I absolutely love my Stargazer units and I couldn’t have been happier with the quality and service from Luna Glamping.”











Amy Rivers, Verified Owner



Endless Opportunities

Applications for Geodesic Dome Kits

-  Glamping Tents
-  Parties
-  Weddings
-  Hotels & Resorts
-  Backyard Gazebos
-  Events & Exhibitions
-  Sports Events
-  Vacation Properties

Get cozy and take a breath of fresh air

Imagine an experience that combines your love of nature with eco-friendly luxury.

Glamping, or glamorous camping, combines the natural experience of a weekend in the woods with the comfort of home. Stargaze from the sofa with a glass of wine in hand, shower in privacy under the open skies, and drift off to sleep under your own comforter in a glamping dome.



The advantages of Geodesic Domes?

Geodesic dome homes are so much more than a conversation piece. Regardless of how your dome home appears in your dreams, these eco-friendly structures are good for your heart and wallet.



DURABILITY

Built with a hot-dipped galvanized steel frame, domes are as durable as they are affordable. This has helped the dome become one of the strongest housing alternatives.



FOUR SEASONS

With options for insulation and chimney stoves available, these easy-to-build structures can withstand winters in the tundra, summers in the desert, and everything in between. And, with the eye-catching hemispherical design, there's less home to heat and cool saving you money all year-round.



PORTABILITY

Built to be moved and removed as you need, even our largest domes can be put together and taken down in a day with the help of a few friends, making dome homes one of the most portable temporary or permanent residences available.

The Stargazer offers endless opportunities. Are you looking to create a dynamic glamping resort? A single studio dwelling? A business facility? Yoga studio or greenhouse?

Stargazer Geodesic Domes



The Stargazer

Relax and enjoy the panoramic view of your surroundings in your geodesic glamping dome.

Nighttime brings on the “stargazing,” when you are able to admire the beautiful night sky from the comfort of your dome. The geodesic dome maximizes living space with a minimal footprint, rendering 30% more space with a third of the building materials and just as strong as a modern structure.

Depending on its size, your new Stargazer comes in 3v, 4v, or Kiewitt designs. Referencing the number of struts and their layout, these designs, also known as dome frequencies, give your Stargazer structural integrity and the ability to withstand heavy rain, gale-force winds, and Canadian winters.

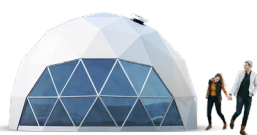

5m Stargazer

Our smallest stargazer sized comfortably as a one bedroom or small office.



6m Stargazer

Our coziest Stargazer. Ideal for glamping couples, a studio space or office.



7m Stargazer

Ideal for glamping couples or as a workspace.



8m Stargazer

Small family glamping, a workspace or small yoga studio.



9m Stargazer

The midsize Stargazer with a little extra room, perfect for small family glamping or entrepreneur work.

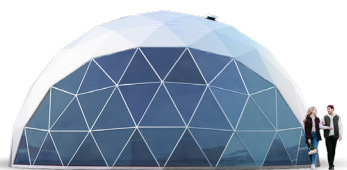

10m Stargazer

Our large dome for an off-grid home, studio, events or vacation property.



12m Stargazer

Our extra large Stargazer. Ideal for family glamping and endless opportunities.



15m Stargazer

Our XXL Stargazer. Ideal for events, family gatherings and endless opportunities.

Stargazer Geodesic Domes

5m

Stargazer Geodesic Dome

Our smallest stargazer sized comfortably as a one bedroom or small office.

The 5m Stargazer is best suited for a one bed glamping space, spare room or office space. Offering 19.6 sq m (211 sq ft), it can be customized with a small kitchenette or bathroom. A Murphy bed can be added for the optimal use of living space.



BUILT TO LAST!
LEADERS IN FRAME STRENGTH

STRUCTURE DIMENSIONS
3V Design

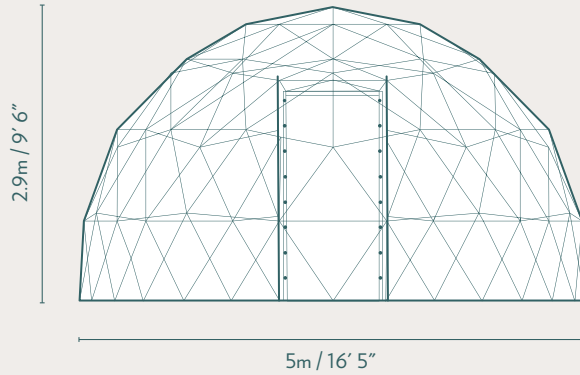

OVERHEAD DIMENSIONS
Floor Area 19.6sqm / 211sqft

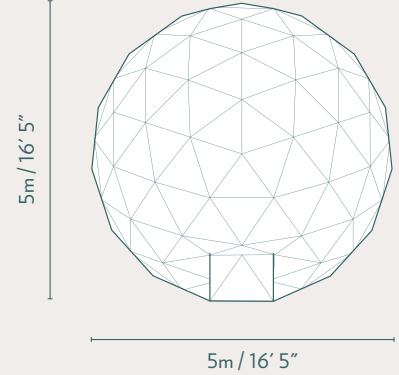

SINGLE DOOR FRAME
Inside



PVC CLEAR VIEW STRUCTURE WINDOWS
With Cover On

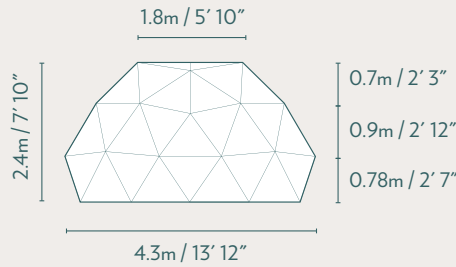

SKYLIGHT DIMENSIONS

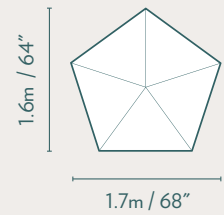

CIRCLE GLASS WINDOW
(Operable)

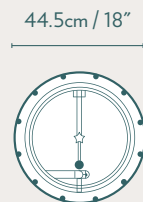

CIRCLE PVC WINDOW
(Inoperable)



TRIANGLE ROLL-UP WINDOW
(With Screen)

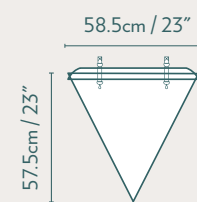



*Arist rendering only. Discrepancies may occur between picture and final purchased product.

SPECIFICATIONS

Diameter	5m / 16' 5"
Center Height	2.9m / 9' 6"
Floor Area	19.6sqm / 211sqft
Structure Weight	400kg / 882lbs
Structure Design	3V
Exterior Colours*	<input type="radio"/> <input type="radio"/> <input type="radio"/>

*Custom exterior colours available on request

FRAMEWORK

A galvanized steel frame and sturdy geodesic dome design create a strong yet simple structure. Thick steel footing elevates the frame for added protection and allows you to secure your dome to any surface. Need to increase your wind and snow loads or change the color of your powder-coated framework? Visit us online or talk to a Luna associate to learn more about frame upgrades and framework colors.

Standard Framework Thickness	32mm x 2mm
Framework Thickness Upgrade	42mm x 2.5mm

ADD-ONS

Want to customize your Stargazer even more?
Check out pricing online.

Two-layer Insulation	Colour Options <input type="radio"/> <input type="radio"/> <input type="radio"/>
Glass Door	Frame Colours <input type="radio"/> <input type="radio"/> Clear or Frosted Glass <input type="radio"/> <input type="radio"/>
Curtains	Colour Options <input type="radio"/> <input type="radio"/> <input type="radio"/>
Keyless Entry	<input checked="" type="checkbox"/>
Solar Fan	Colour Options <input type="radio"/> <input checked="" type="radio"/>
Stove Jack 5" or 9"	Colour Options <input type="radio"/> <input checked="" type="radio"/>
Glass Structure Window	Single or Double Pane
Rooftop Skylight	<input checked="" type="checkbox"/>
Skylight Motorized Blind	<input checked="" type="checkbox"/>
Circle Glass Windows	<input checked="" type="checkbox"/>
Circle PVC Windows	<input checked="" type="checkbox"/>
Triangle Roll-up Window with Screen	<input checked="" type="checkbox"/>

ADDITIONAL INFORMATION Structure bolt lengths: M10*70 without insulation, M10*90 with insulation
Wrench size required: 17mm Installation tools: Electric hand drill, 2m ladder. Placement of windows, doors, stove jack and other add-ons will be specified once quote is received and confirmed. All measurements rounded to nearest cm/ inch.

09 www.lunaglamping.com

5m Stargazer Geodesic Dome

6m

Stargazer Geodesic Dome

Our coziest Stargazer. Ideal for glamping couples, a studio space or office.

The 6m Stargazer is best suited for a couples weekend stay or small studio space. Offering 28.3 sq m (305 sq ft), it can be customized with a small kitchenette and bathroom. A Murphy bed can be added for the optimal use of living space.

BUILT TO LAST!
LEADERS IN FRAME STRENGTH

STRUCTURE DIMENSIONS
3V Design

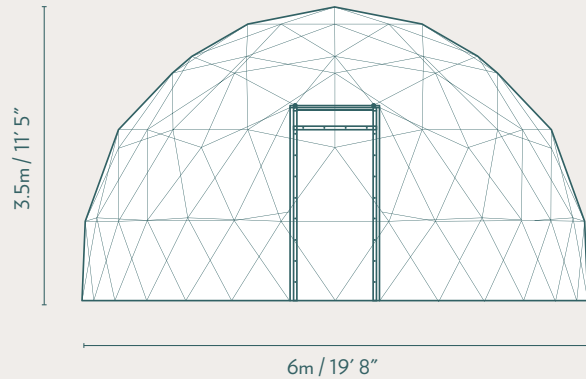

OVERHEAD DIMENSIONS
Floor Area 28.3sqm / 305sqft

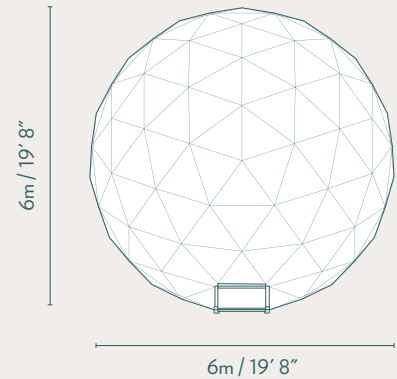

SINGLE DOOR FRAME
Inside



CLEAR VIEW STRUCTURE WINDOWS
With Cover On

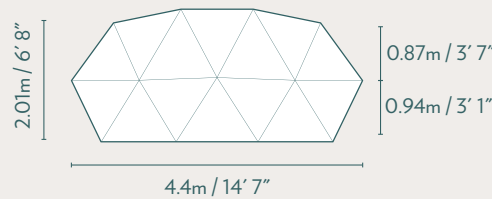

SKYLIGHT DIMENSIONS

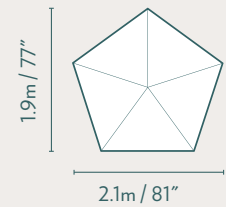

CIRCLE GLASS WINDOW
(Operable)



CIRCLE PVC WINDOW
(Inoperable)



TRIANGLE ROLL-UP WINDOW
(With Screen)

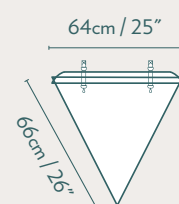



*Arist rendering only. Discrepancies may occur between picture and final purchased product.

SPECIFICATIONS

Diameter	6m / 19' 8"
Center Height	3.5m / 11' 5"
Floor Area	28.3 sqm / 305 sqft
Structure Weight	500kg / 1102lbs
Structure Design	3V
Exterior Colours*	<input type="radio"/> <input type="radio"/> <input type="radio"/>

*Custom exterior colours available on request

FRAMEWORK

A galvanized steel frame and sturdy geodesic dome design create a strong yet simple structure. Thick steel footing elevates the frame for added protection and allows you to secure your dome to any surface. Need to increase your wind and snow loads or change the color of your powder-coated framework? Visit us online or talk to a Luna associate to learn more about frame upgrades and framework colors.

Standard Framework Thickness	32mm x 2mm
Framework Thickness Upgrade	42mm x 2.5mm

ADD-ONS

Want to customize your Stargazer even more? **Check out pricing online.**

Two-layer Insulation	Colour Options <input type="radio"/> <input type="radio"/> <input type="radio"/>
Glass Door	Frame Colours <input type="radio"/> <input type="radio"/> Clear or Frosted Glass <input type="radio"/> <input type="radio"/>
Curtains	Colour Options <input type="radio"/> <input type="radio"/> <input type="radio"/>
Keyless Entry	<input checked="" type="checkbox"/>
Solar Fan	Colour Options <input type="radio"/> <input checked="" type="radio"/>
Stove Jack 5" or 9"	Colour Options <input type="radio"/> <input checked="" type="radio"/>
Glass Structure Window	Single or Double Pane
Rooftop Skylight	<input checked="" type="checkbox"/>
Skylight Motorized Blind	<input checked="" type="checkbox"/>
Circle Glass Windows	<input checked="" type="checkbox"/>
Circle PVC Windows	<input checked="" type="checkbox"/>
Triangle Roll-up Window with Screen	<input checked="" type="checkbox"/>

ADDITIONAL INFORMATION Structure bolt lengths: M10*70 without insulation, M10*90 with insulation. Wrench size required: 17mm Installation tools: Electric hand drill, 3m ladder. Placement of windows, doors, stove jack and other add-ons specified once quote is received and confirmed. **All measurements rounded to nearest cm/inch.**

7m

Stargazer Geodesic Dome

Ideal for glamping as a couple or as a workspace.

The 7m Stargazer is best suited for a couple who enjoy a little more space. Offering 38.5 sq m (415 sq ft), there is a more room for furniture or a seating area in addition to a small bathroom and or kitchenette.

BUILT TO LAST!
LEADERS IN FRAME STRENGTH

STRUCTURE DIMENSIONS
3V Design

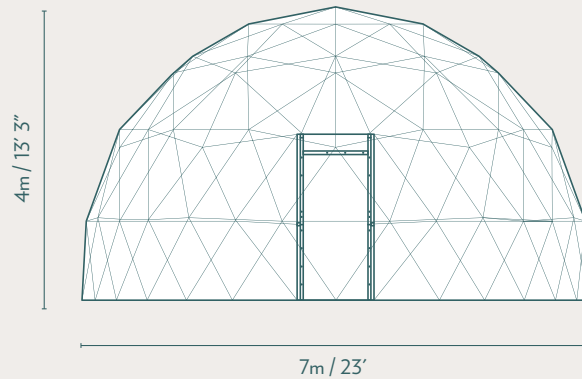

OVERHEAD DIMENSIONS
Floor Area 38.5sqm / 414sqft

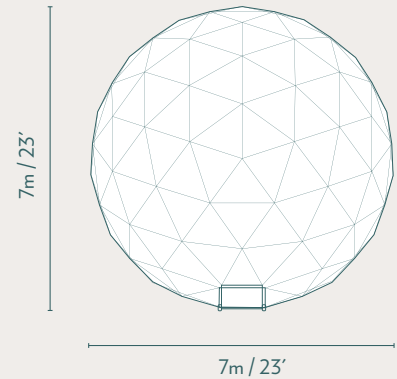

SINGLE DOOR FRAME
Inside



CLEAR VIEW STRUCTURE WINDOWS
With Cover On

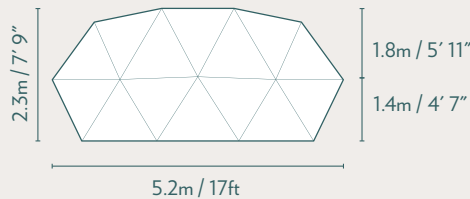

SKYLIGHT DIMENSIONS

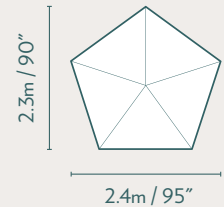

CIRCLE GLASS WINDOW
(Operable)



CIRCLE PVC WINDOW
(Inoperable)



TRIANGLE ROLL-UP WINDOW
(With Screen)

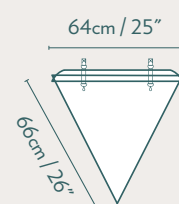



*Arist rendering only. Discrepancies may occur between picture and final purchased product.

SPECIFICATIONS

Diameter	7m / 23'
Center Height	4m / 13' 3"
Floor Area	38.5 sqm / 414 sqft
Structure Weight	550kg / 1213lbs
Structure Design	3V
Exterior Colours*	<input type="radio"/> <input type="radio"/> <input type="radio"/>

*Custom exterior colours available on request

FRAMEWORK

A galvanized steel frame and sturdy geodesic dome design create a strong yet simple structure. Thick steel footing elevates the frame for added protection and allows you to secure your dome to any surface. Need to increase your wind and snow loads or change the color of your powder-coated framework? Visit us online or talk to a Luna associate to learn more about frame upgrades and framework colors.

Standard Framework Thickness	32mm x 2mm
Framework Thickness Upgrade	42mm x 2.5mm

ADD-ONS

Want to customize your Stargazer even more? **Check out pricing online.**

Two-layer Insulation	Colour Options <input type="radio"/> <input type="radio"/> <input type="radio"/>
Glass Door	Frame Colours <input type="radio"/> <input type="radio"/> Clear or Frosted Glass <input type="radio"/> <input type="radio"/>
Curtains	Colour Options <input type="radio"/> <input type="radio"/> <input type="radio"/>
Keyless Entry	<input checked="" type="checkbox"/>
Solar Fan	Colour Options <input type="radio"/> <input checked="" type="radio"/>
Stove Jack 5" or 9"	Colour Options <input type="radio"/> <input checked="" type="radio"/>
Glass Structure Window	Single or Double Pane
Rooftop Skylight	<input checked="" type="checkbox"/>
Skylight Motorized Blind	<input checked="" type="checkbox"/>
Circle Glass Windows	<input checked="" type="checkbox"/>
Circle PVC Windows	<input checked="" type="checkbox"/>
Triangle Roll-up Window with Screen	<input checked="" type="checkbox"/>

ADDITIONAL INFORMATION Structure bolt lengths: M10*70 without insulation, M10*90 with insulation
Wrench size required: 17mm **Installation tools:** Electric hand drill, 3m ladder. Placement of windows, doors, stove jack and other add-ons specified once quote is received and confirmed. **All measurements rounded to nearest cm/inch.**

8m

Stargazer Geodesic Dome

Midsize Stargazer. Small family glamping, a workspace or small yoga studio.

The 8m Stargazer gives a roomy and rich feeling for a couple and can easily fit two beds for additional guests. Offering 50.2 sq m (540 sq ft), this unit has ample space for a full size kitchen and bathroom.



BUILT TO LAST!
LEADERS IN FRAME STRENGTH

STRUCTURE DIMENSIONS
3V Design

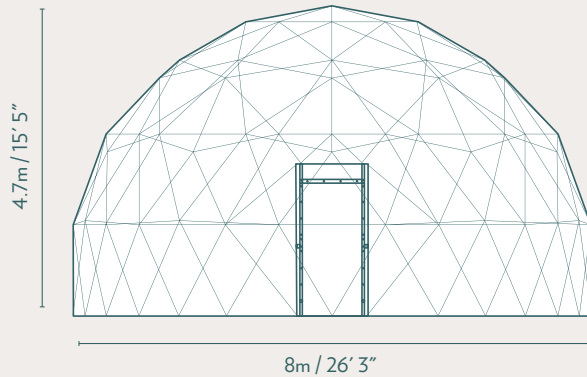

OVERHEAD DIMENSIONS
Floor Area 50.2sqm

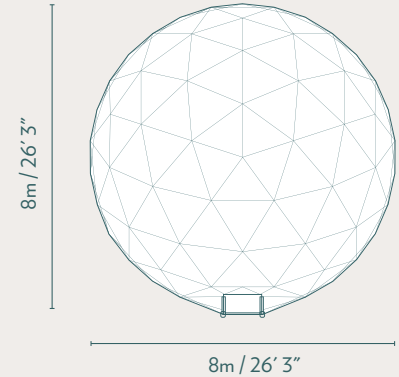

SINGLE DOOR FRAME
Inside



CLEAR VIEW STRUCTURE WINDOWS
With Cover On

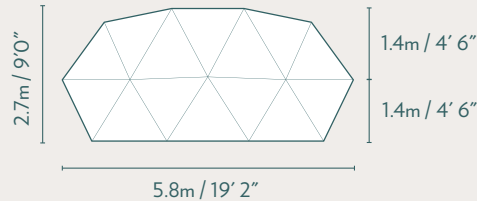

DOUBLE DOOR FRAME
Inside

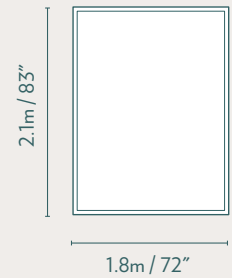

SKYLIGHT DIMENSIONS

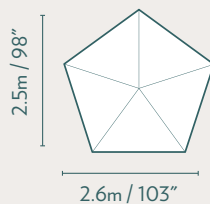

CIRCLE GLASS WINDOW
(Operable)



CIRCLE PVC WINDOW
(Inoperable)

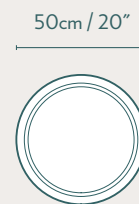

TRIANGLE ROLL-UP WINDOW
(With Screen)

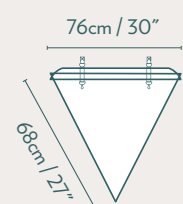



*Arist rendering only. Discrepancies may occur between picture and final purchased product.

SPECIFICATIONS

Diameter	8m / 26' 3"
Center Height	4.7m / 15' 5"
Floor Area	50.2 sqm / 540 sqft
Structure Weight	600kg / 1323lbs
Structure Design	3V
Exterior Colours*	<input type="radio"/> <input type="radio"/> <input type="radio"/>

*Custom exterior colours available on request

FRAMEWORK

A galvanized steel frame and sturdy geodesic dome design create a strong yet simple structure. Thick steel footing elevates the frame for added protection and allows you to secure your dome to any surface. Need to increase your wind and snow loads or change the color of your powder-coated framework? Visit us online or talk to a Luna associate to learn more about frame upgrades and framework colors.

Standard Framework Thickness	32mm x 2mm
Framework Thickness Upgrade	42mm x 2.5mm

ADD-ONS

Want to customize your Stargazer even more? **Check out pricing online.**

Two-layer Insulation	Colour Options <input type="radio"/> <input type="radio"/> <input type="radio"/>
Single Glass Door	Frame Colours <input type="radio"/> <input type="radio"/> Clear or Frosted Glass <input type="radio"/> <input type="radio"/>
Double Glass Door	Frame Colours <input type="radio"/> <input type="radio"/> Clear or Frosted Glass <input type="radio"/> <input type="radio"/>
Curtains	Colour Options <input type="radio"/> <input type="radio"/> <input type="radio"/>
Keyless Entry	<input checked="" type="checkbox"/>
Solar Fan	Colour Options <input type="radio"/> <input checked="" type="radio"/>
Stove Jack 5" or 9"	Colour Options <input type="radio"/> <input checked="" type="radio"/>
Glass Structure Window	Single or Double Pane
Rooftop Skylight	<input checked="" type="checkbox"/>
Skylight Motorized Blind	<input checked="" type="checkbox"/>
Circle Glass Windows	<input checked="" type="checkbox"/>
Circle PVC Windows	<input checked="" type="checkbox"/>
Triangle Roll-up Window with Screen	<input checked="" type="checkbox"/>

ADDITIONAL INFORMATION Structure bolt lengths: M10*70 without insulation, M10*90 with insulation
Wrench size required: 17mm **Installation tools:** Electric hand drill/scaffolding. Placement of windows, doors, stove jack and other add-ons specified once quote is received and confirmed. **All measurements rounded to nearest cm/inch.**
15 www.lunaglamping.com

8m Stargazer Geodesic Dome

9m

Stargazer Geodesic Dome

The midsize Stargazer with a little extra room. Ideal for small family glamping or an entrepreneur workspace.

The 9m Stargazer is best suited for a family, collaborative workspace or even a yoga studio. Offering 63.6 sq m, (685 sq ft), it can be customized with a kitchenette, bathroom and living space or a modest yoga studio.

BUILT TO LAST!
LEADERS IN FRAME STRENGTH

STRUCTURE DIMENSIONS
4V Design

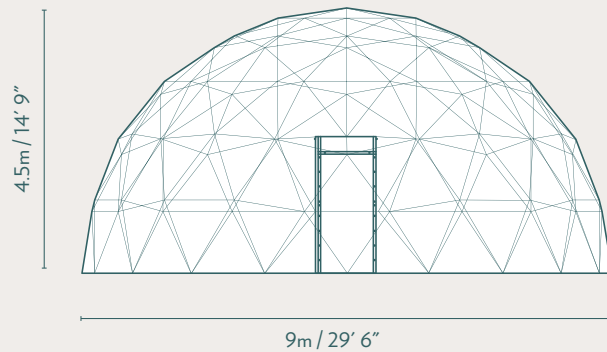

OVERHEAD DIMENSIONS
Floor Area 63.6sqm / 685sqft

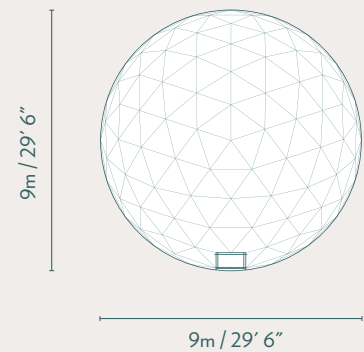

SINGLE DOOR FRAME
Inside



CLEAR VIEW STRUCTURE WINDOWS
With Cover On

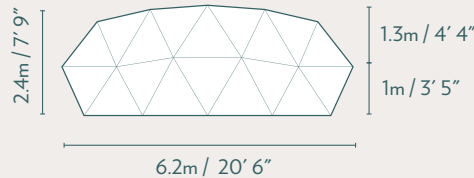

DOUBLE DOOR FRAME
Inside

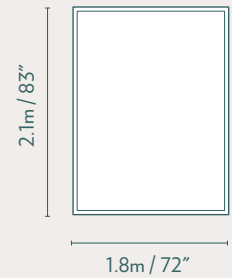

SKYLIGHT DIMENSIONS

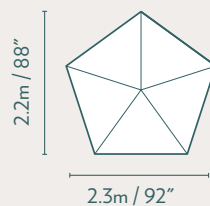

CIRCLE GLASS WINDOW
(Operable)



CIRCLE PVC WINDOW
(Inoperable)

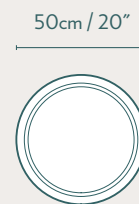

TRIANGLE ROLL-UP WINDOW
(With Screen)

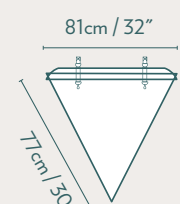

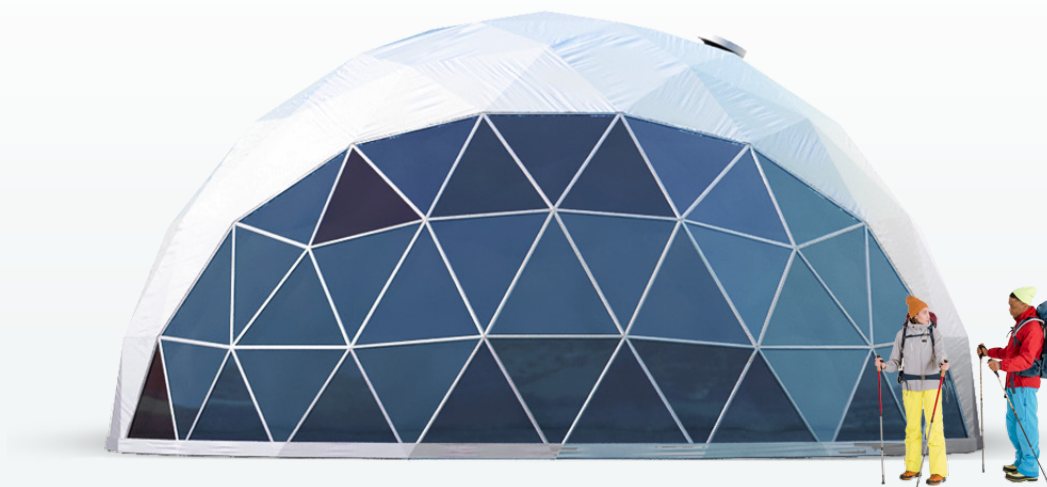

*Arist rendering only. Discrepancies may occur between picture and final purchased product.

SPECIFICATIONS

Diameter	9m / 29' 6"
Center Height	4.5m / 14' 9"
Floor Area	63.6sqm / 685sqft
Structure Weight	800kg / 1764lbs
Structure Design	4V
Exterior Colours*	<input type="radio"/> <input type="radio"/> <input type="radio"/>

*Custom exterior colours available on request

FRAMEWORK

A galvanized steel frame and sturdy geodesic dome design create a strong yet simple structure. Thick steel footing elevates the frame for added protection and allows you to secure your dome to any surface. Need to increase your wind and snow loads or change the color of your powder-coated framework? Visit us online or talk to a Luna associate to learn more about frame upgrades and framework colors.

Standard Framework Thickness	32mm x 2mm
Framework Thickness Upgrade	42mm x 2.5mm

ADD-ONS

Want to customize your Stargazer even more? **Check out pricing online.**

Two-layer Insulation	Colour Options <input type="radio"/> <input type="radio"/> <input type="radio"/>
Single Glass Door	Frame Colours <input type="radio"/> <input type="radio"/> Clear or Frosted Glass <input type="radio"/> <input type="radio"/>
Double Glass Door	Frame Colours <input type="radio"/> <input type="radio"/> Clear or Frosted Glass <input type="radio"/> <input type="radio"/>
Curtains	Colour Options <input type="radio"/> <input type="radio"/> <input type="radio"/>
Keyless Entry	<input checked="" type="checkbox"/>
Solar Fan	Colour Options <input type="radio"/> <input checked="" type="radio"/>
Stove Jack 5" or 9"	Colour Options <input type="radio"/> <input checked="" type="radio"/>
Glass Structure Window	Single or Double Pane
Rooftop Skylight	<input checked="" type="checkbox"/>
Skylight Motorized Blind	<input checked="" type="checkbox"/>
Circle Glass Windows	<input checked="" type="checkbox"/>
Circle PVC Windows	<input checked="" type="checkbox"/>
Triangle Roll-up Window with Screen	<input checked="" type="checkbox"/>

ADDITIONAL INFORMATION Structure bolt lengths: M10*70 without insulation, M10*90 with insulation
Wrench size required: 17mm **Installation tools:** Electric hand drill/scaffolding. Placement of windows, doors, stove jack and other add-ons specified once quote is received and confirmed. **All measurements rounded to nearest cm/inch.**

17 www.lunaglamping.com

9m Stargazer Geodesic Dome

10m Stargazer Geodesic Dome

Our large dome for an off-grid home, studio, events, vacation property.

The 10m Stargazer is best suited for an off grid home or large studio. Offering 78.5 sq (845 sq ft), there is ample room for your family to live year round in this large dome. The 10m Stargazer can also be used as a larger studio or to host small events.



BUILT TO LAST!
LEADERS IN FRAME STRENGTH

STRUCTURE DIMENSIONS
Kiewitt Design

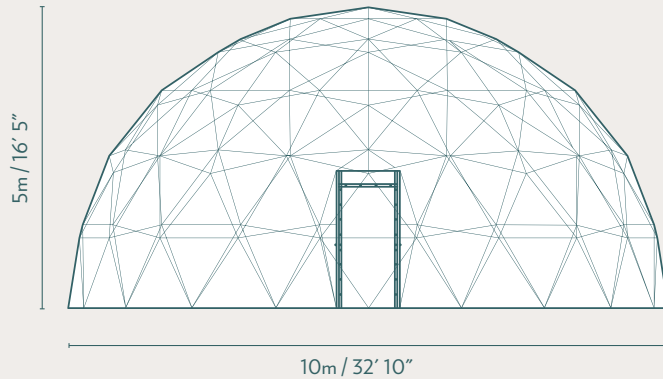

OVERHEAD DIMENSIONS
Floor Area 78.5sqm/845sqft

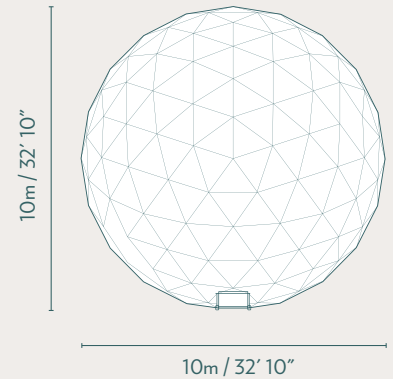

SINGLE DOOR FRAME
Inside



CLEAR VIEW STRUCTURE WINDOWS
With Cover On

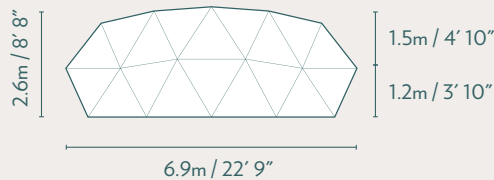

DOUBLE DOOR FRAME
Inside

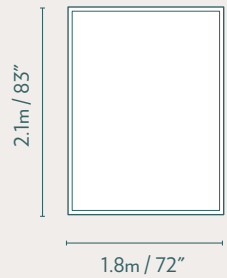

SKYLIGHT DIMENSIONS

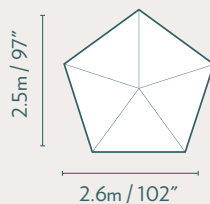

CIRCLE GLASS WINDOW
(Operable)

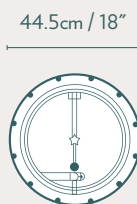

CIRCLE PVC WINDOW
(Inoperable)



TRIANGLE ROLL-UP WINDOW
(With Screen)

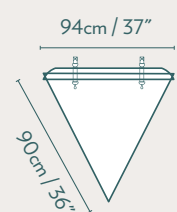



*Arist rendering only. Discrepancies may occur between picture and final purchased product.

SPECIFICATIONS

Diameter 10m / 32' 10"

Center Height 5m / 16' 5"

Floor Area 78.5sqm / 845sqft

Structure Weight 800kg / 1764lbs

Structure Design Kiewitt

Exterior Colours*

*Custom exterior colours available on request

FRAMEWORK

A galvanized steel frame and sturdy geodesic dome design create a strong yet simple structure. Thick steel footing elevates the frame for added protection and allows you to secure your dome to any surface. Need to increase your wind and snow loads or change the color of your powder-coated framework? Visit us online or talk to a Luna associate to learn more about frame upgrades and framework colors.

Standard Framework Thickness 42mm x 2.5mm

Framework Thickness Upgrade 48mm x 3mm

ADD-ONS

Want to customize your Stargazer even more? **Check out pricing online.**

Two-layer Insulation Colour Options

Single Glass Door Frame Colours Clear or Frosted Glass

Double Glass Door Frame Colours Clear or Frosted Glass

Curtains Colour Options

Keyless Entry

Solar Fan Colour Options

Stove Jack 5" or 9" Colour Options

Glass Structure Window Single or Double Pane

Rooftop Skylight

Skylight Motorized Blind

Circle Glass Windows

Circle PVC Windows

Triangle Roll-up Window with Screen

ADDITIONAL INFORMATION Structure bolt lengths: M10*70 without insulation, M10*90 with insulation
Wrench size required: 17mm Installation tools: Electric hand drill/scaffolding. Placement of windows, doors, stove jack and other add-ons specified once quote is received and confirmed. All measurements rounded to nearest cm/inch.

19 www.lunaglamping.com

10m Stargazer Geodesic Dome

12m

Stargazer Geodesic Dome

Our extra large Stargazer. Ideal for family glamping and endless opportunities.

The 12m Stargazer is best suited for events, collaborative work space or a yoga studio. Offering 144 sq m (1550 sq ft), there is ample room for guests, bathrooms, additional rooms and seating if required.

BUILT TO LAST!
LEADERS IN FRAME STRENGTH

STRUCTURE DIMENSIONS
Kiewitt Design

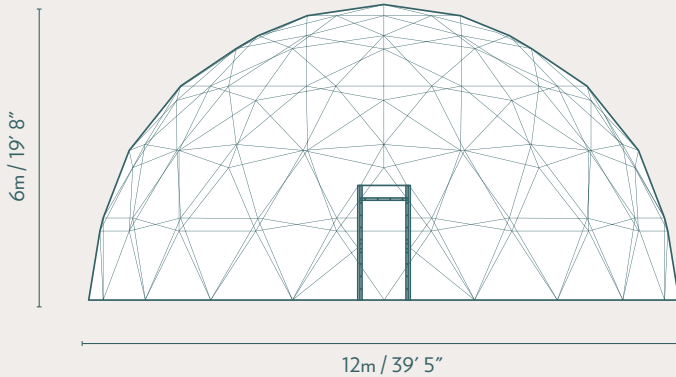

OVERHEAD DIMENSIONS
Floor Area 144sqm / 1550sqft

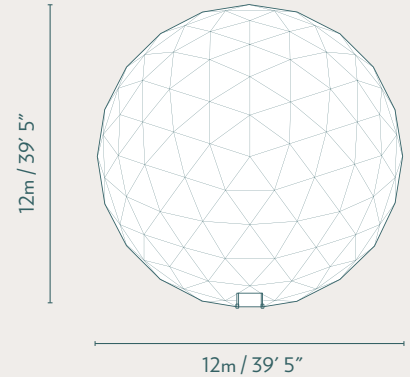

SINGLE DOOR FRAME
Inside



CLEAR VIEW STRUCTURE WINDOWS
With Cover On

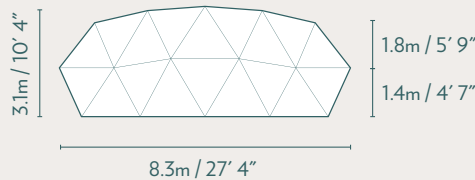

DOUBLE DOOR FRAME
Inside

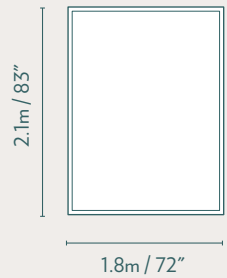

SKYLIGHT DIMENSIONS

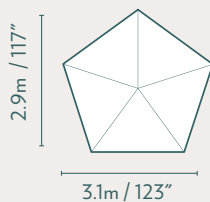

CIRCLE GLASS WINDOW
(Operable)



CIRCLE PVC WINDOW
(Inoperable)

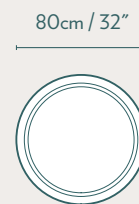

TRIANGLE ROLL-UP WINDOW
(With Screen)

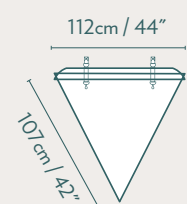



*Arist rendering only. Discrepancies may occur between picture and final purchased product.

SPECIFICATIONS

Diameter	12m / 39' 5"
Center Height	6m / 19' 8"
Floor Area	144sqm / 1550sqft
Structure Weight	1800kg / 3968lbs
Structure Design	Kiewitt
Exterior Colours*	<input type="radio"/> <input type="radio"/> <input type="radio"/>

*Custom exterior colours available on request

FRAMEWORK

A galvanized steel frame and sturdy geodesic dome design create a strong yet simple structure. Thick steel footing elevates the frame for added protection and allows you to secure your dome to any surface. Need to increase your wind and snow loads or change the color of your powder-coated framework? Visit us online or talk to a Luna associate to learn more about frame upgrades and framework colors.

Standard Framework Thickness	42mm x 2.5mm
Framework Thickness Upgrade	48mm x 3mm

ADD-ONS

Want to customize your Stargazer even more? **Check out pricing online.**

Two-layer Insulation	Colour Options <input type="radio"/> <input type="radio"/> <input type="radio"/>
Single Glass Door	Frame Colours <input type="radio"/> <input checked="" type="radio"/> Clear or Frosted Glass <input type="radio"/> <input type="radio"/>
Double Glass Door	Frame Colours <input type="radio"/> <input checked="" type="radio"/> Clear or Frosted Glass <input type="radio"/> <input type="radio"/>
Curtains	Colour Options <input type="radio"/> <input type="radio"/> <input type="radio"/>
Keyless Entry	<input checked="" type="checkbox"/>
Solar Fan	Colour Options <input type="radio"/> <input checked="" type="radio"/>
Stove Jack 5" or 9"	Colour Options <input type="radio"/> <input checked="" type="radio"/>
Glass Structure Window	Single or Double Pane
Rooftop Skylight	<input checked="" type="checkbox"/>
Skylight Motorized Blind	<input checked="" type="checkbox"/>
Circle Glass Windows	<input checked="" type="checkbox"/>
Circle PVC Windows	<input checked="" type="checkbox"/>
Triangle Roll-up Window with Screen	<input checked="" type="checkbox"/>

ADDITIONAL INFORMATION Structure bolt lengths: M18*80 without insulation, M 18*110 with insulation
Wrench size required: 27mm **Installation tools:** Electric hand drill/scaffolding. Placement of windows, doors, stove jack and other add-ons specified once quote is received and confirmed. **All measurements rounded to nearest cm/inch.**

21 www.lunaglamping.com

12m Stargazer Geodesic Dome

15m

Stargazer Geodesic Dome

Our XXL Stargazer. Ideal for events, family gatherings and endless opportunities.

The 15m Stargazer is best suited for events, collaborative work space or a large studio. Offering 177 sq m (1905 sq ft), there is ample room for guests, bathrooms, additional rooms and seating if required.

BUILT TO LAST!
LEADERS IN FRAME STRENGTH

STRUCTURE DIMENSIONS Floor Area
Kiewitt Design

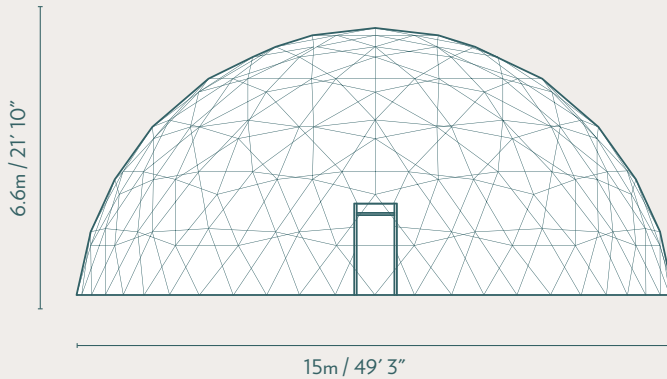

OVERHEAD DIMENSIONS
Floor Area 177sqm / 1905sqft

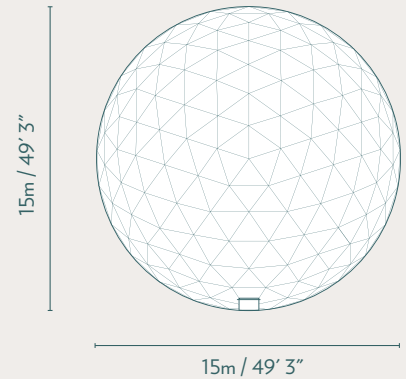

SINGLE DOOR FRAME
Inside



CLEAR VIEW STRUCTURE WINDOWS
With Cover On

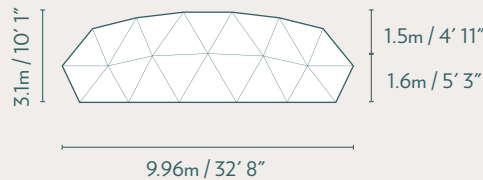

DOUBLE DOOR FRAME
Inside

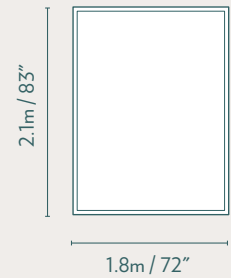

SKYLIGHT DIMENSIONS

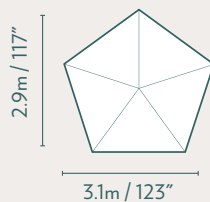

CIRCLE GLASS WINDOW
(Operable)



CIRCLE PVC WINDOW
(Inoperable)

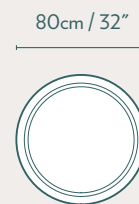

TRIANGLE ROLL-UP WINDOW
(With Screen)

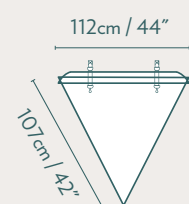

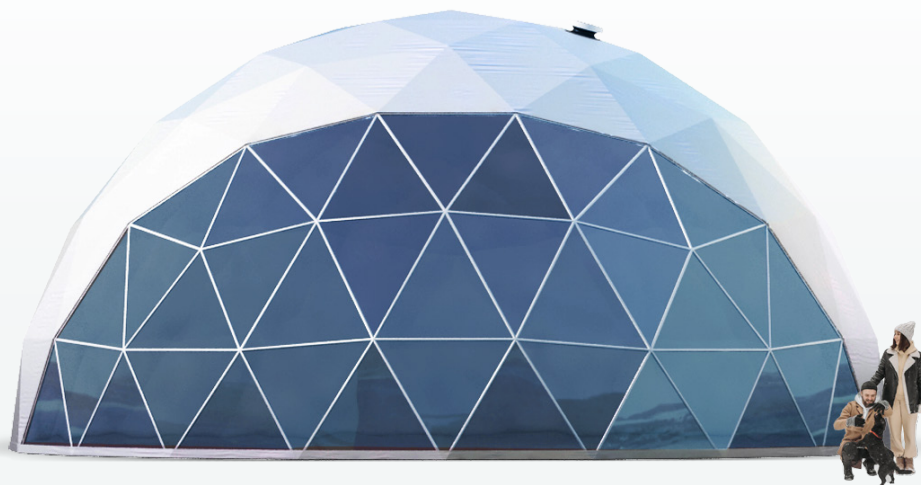

*Arist rendering only. Discrepancies may occur between picture and final purchased product.

SPECIFICATIONS

Diameter	15m / 49' 3"
Center Height	6.6m / 21' 10"
Floor Area	177sqm / 1905sqft
Structure Weight	2500kg / 5512lbs
Structure Design	Kiewitt
Exterior Colours*	<input type="radio"/> <input type="radio"/> <input type="radio"/>

*Custom exterior colours available on request

FRAMEWORK

A galvanized steel frame and sturdy geodesic dome design create a strong yet simple structure. Thick steel footing elevates the frame for added protection and allows you to secure your dome to any surface. Need to increase your wind and snow loads or change the color of your powder-coated framework? Visit us online or talk to a Luna associate to learn more about frame upgrades and framework colors.

Standard Framework Thickness	42mm x 2.5mm
Framework Thickness Upgrade	48mm x 3mm

ADD-ONS

Want more customizations? [Check out pricing online.](#)

Two-layer Insulation	Colour Options <input type="radio"/> <input type="radio"/> <input type="radio"/>
Single Glass Door	Frame Colours <input type="radio"/> <input type="radio"/> Clear or Frosted Glass <input type="radio"/> <input type="radio"/>
Double Glass Door	Frame Colours <input type="radio"/> <input type="radio"/> Clear or Frosted Glass <input type="radio"/> <input type="radio"/>
Curtains	Colour Options <input type="radio"/> <input type="radio"/> <input type="radio"/>
Keyless Entry	<input checked="" type="checkbox"/>
Solar Fan	Colour Options <input type="radio"/> <input checked="" type="radio"/>
Stove Jack 5" or 9"	Colour Options <input type="radio"/> <input checked="" type="radio"/>
Glass Structure Window	Single or Double Pane
Rooftop Skylight	<input checked="" type="checkbox"/>
Skylight Motorized Blind	<input checked="" type="checkbox"/>
Circle Glass Windows	<input checked="" type="checkbox"/>
Circle PVC Windows	<input checked="" type="checkbox"/>
Triangle Roll-up Window with Screen	<input checked="" type="checkbox"/>

ADDITIONAL INFORMATION Structure bolt lengths: M18*80 without insulation, M 18*110 with insulation
Wrench size required: 27mm **Installation tools:** Electric hand drill / scaffolding / 25 ton crane / steel cable. Placement of windows, doors, stove jack and other add-ons specified once quote is received and confirmed. **All measurements rounded to nearest cm/inch.**

23 www.lunaglamping.com

15m Stargazer Geodesic Dome

Imagine your dream space.
What does it look and feel like?
Our accessories empower you
to convert nature's perfect
structure into an office purpose-
built for your work-from-home
life or a glamping tent where
you can't wait to spend your
weekends.

Stargazer Add-Ons

Make your Stargazer your own with custom add-ons



TWO-LAYER INSULATION



SOLAR FAN



ROOFTOP SKYLIGHT



SKYLIGHT MOTORIZED
BLIND



CURTAINS

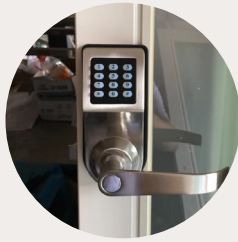

KEYLESS ENTRY (FOB)



STOVE JACK



CIRCLE PVC WINDOW



CIRCLE GLASS WINDOW



TRIANGLE ROLL-UP
MESHWINDOW



GLASS DOOR



ENGINEERING

Stargazer Add-Ons



Two-Layer Insulation

Achieve a clean, finished look that helps save money on your heating.

This two-layer insulation combines an air barrier and cotton-based canvas to increase your energy efficiency and help you warm your space on cold spring nights and cool autumn mornings. Combine our two-layer insulation with a source of heat to turn your dome into a cozy space made for year-round stargazing.

Additional Specifications: Additional Specifications: Sections can be replaced when damaged or stained. The insulation is an 18mm thick thinsulate that is water and mildew proof as well as fire retardant. The interior of the dome is covered by a thick canvas available in white, khaki or grey, with custom colours available upon request.

SAMPLE DIAGRAM
Insulation panels

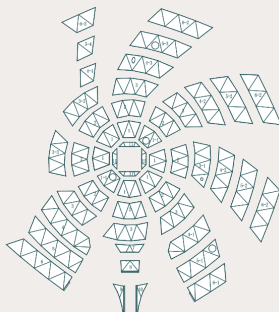



Solar Fans

The sun is blazing and the mercury rising, but it's cool inside your geodesic dome. How? Easy: through a solar-powered fan.

Powered by an 18W polycrystalline solar panel, the stylish fan with three 14" aluminum axial flow blades and galvanized steel enclosure keeps the air circulating on even the hottest summer days and removes moisture. Plus, there's a plugin included for days when the sun just won't shine.

Additional Specifications: 18V brushless DC motor, 17W 18V Polycrystalline solar panel. Available in Black or White.

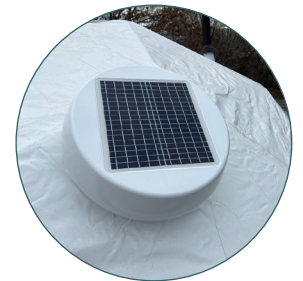
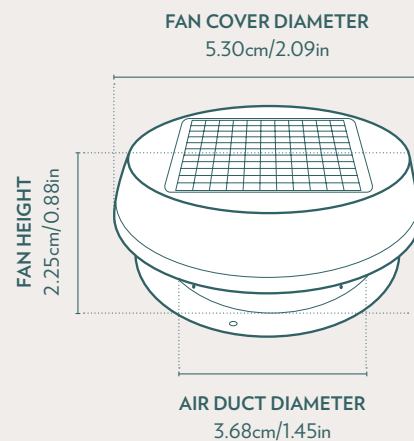



Rooftop Skylight

Stare into the stars in comfort.

Open the centre of the dome to the night with a custom-built skylight that lets natural light pour into your dome and makes staying up late to watch the stars a breeze. When paired with a motorized blind, our PVC skylight is the perfect addition to your new Stargazer.

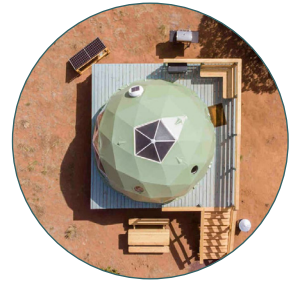



Skylight Motorized Blind

Skylights are great until the sun comes up and cancels your plans for late morning rest and relaxation.

Shield yourself from the morning sun with a motorized blind for your skylight. And, with a handy remote and wired setup, you won't even need to get out of bed.

Comes with a remote control, wires into 110V power, comes with our three color options or custom color if requested. Hangs from the bars of the dome by four wires, one in each corner for easy leveling.





Curtains

Pull back the curtains and let in the light or shut out the first light so you can sleep in on Sunday mornings with curtains custom-built for your new geodesic dome.

This curtain kit is easy to install and includes the curtain rod and hangers. With curtains that cover the full height and width of the clear PVC window, you can choose when you want to see and be seen.

Additional Specifications: Black out curtains also help with insulation. These curtains feature a curtain track that attaches to the dome frame. The curtain is available in white, khaki or grey, with custom colours available upon request.





Keyless Entry (FOB)

Leave the keys on the nightstand and your worries at the door so you can spend a carefree afternoon paddling on the water or hiking through the forest.

With a punch code and fob access, keyless entry gives you and your guests easy and secure access to your new Stargazer.



Add-ons: Stove Jack

Stove Jack

Do you dream of a pellet stove in the dining room or curling up on the sofa with a good book and the crackle of a wood stove?

Our stove jack puts the decision in your hands. Just bring your own stove and choose a location within your dome. The insulation and PVC cover will be prepared to ensure a proper fit. 5" and a 9" stove jack available. Custom sizes available upon request.

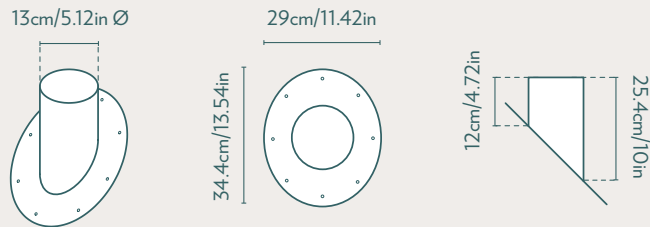

9" STOVE JACK DIMENSIONS

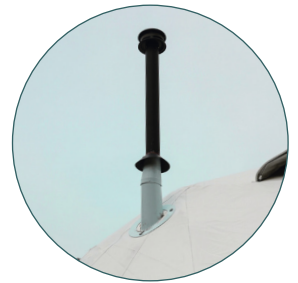
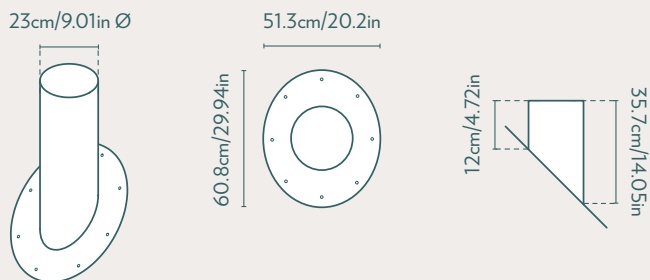



Circle PVC Window (Non-Operable)

Nothing says comfort and tranquillity like natural light. Allow even more light to shine through your dome with a circle PVC window.

As a static window that cannot be opened, the circle PVC window is often located higher in the dome to welcome light into your living space.





Circle Glass Window (Operable)

Unlock your window and welcome the great outdoors inside with 400mm circle glass windows.

Held open by a ram, this window features a turn latch and is placed at a height where it can be easily used, often in row two between four and five feet from the ground.





Triangle Roll-up Mesh Window

Breathe fresh air into your space with a roll-up triangle mesh window that perfectly fits into the piping of the dome.

Featuring a removable screen, these windows are primarily used for ventilation and can be placed anywhere in rows one and two.





Add-ons: Glass Door

Glass Door

Let nature guide you from the entrance to the panoramic bay window while you keep your Stargazer secure with a locking glass door.

Made with aluminum and tempered glass, the door is lightweight and easy to use while still providing the sense of safety and security you need, whether you're building a new office space or a year-round glamping retreat.

SINGLE DOOR FRAME

Inside 1.92m/6.3ft x 0.82m/2.69ft



DOUBLE DOOR FRAME

Inside 1.92m/6.3ft x 1.42m/4.66ft

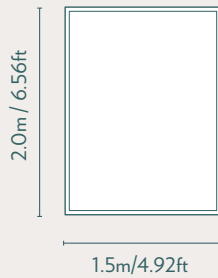



Engineering Reports

Unlock structural engineering reports that make permits for your new dome home a breeze.

Conducted by a qualified Canadian engineering firm, your included report breaks down the wind, snow, and load ratings of your chosen geodesic dome as required by municipalities and local governments. This detailed report streamlines the permit process so you can spend less time on paperwork and more time connecting with nature in your new Stargazer.

Visit our website to download your included engineering report.



The Luna Dome

The Luna Dome takes glamping to a whole new level. There is no better feeling than going to sleep while marveling at the stars and waking up to a beautiful sunrise.



3m Luna Dome

For glampers and adventurers.
Fits 1-2 people comfortably.

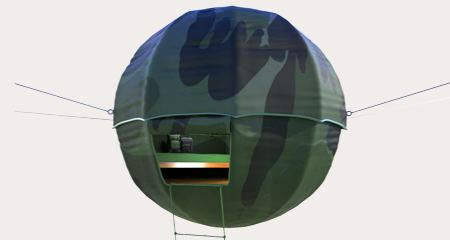

3m Luna Outdoorsman Dome

For glampers and adventurers.
Fits 1-2 people comfortably.

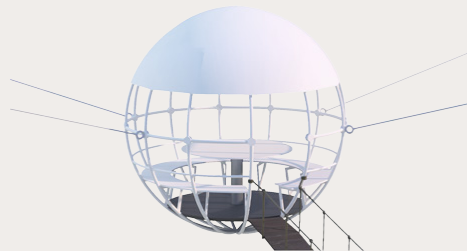

3m Luna Chillout Dome

It's all in the name, "Chillout".
Will seat 4-6 people.

3m

Luna Spherical Dome

For glampers and adventurers.

Fits one-two people comfortably.

The Luna Spherical 3m takes Glamping to a whole new level. Ideal for short overnight or weekend trips.

The built-in bed is comparable to a queen mattress. Insulation is top only.

STRUCTURE DIMENSIONS

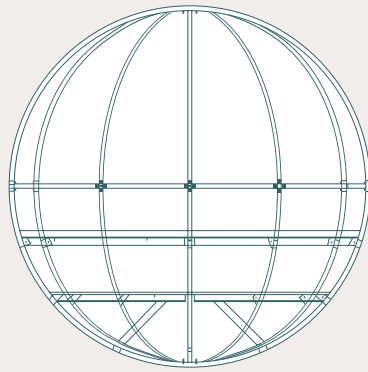

OVERHEAD DIMENSIONS

Floor Area 7sqm

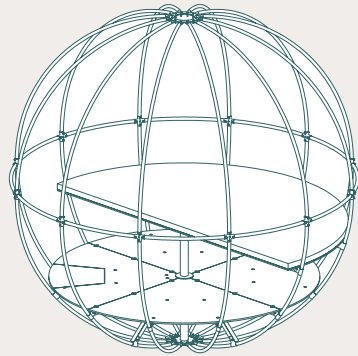

CIRCLE PVC WINDOW (Non-operable)

46cm/18.11in

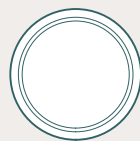

TRIANGLE ROLL-UP WINDOW (With Screen)

72cm/28.35in

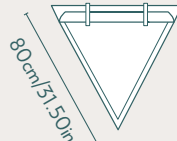

BUILT TO LAST!
LEADERS IN FRAME STRENGTH



SPECIFICATIONS

Diameter 3m / 9.8ft

Center Height 2.3m / 7.5ft

Floor Area 7sqm / 75sqft

Structure Weight 150kg / 330lbs

Exterior Colours

*Custom exterior colours available on request

FRAMEWORK

Framework is made from stainless steel with a flame and tear Resistant PVC cover, 850gsm.

Standard Framework Thickness
28mm OD x 1.4mm wall thickness

Framework Thickness Upgrade

ADD-ONS

Check out pricing online. Custom windows available on request.

Two-layer Insulation

Circle Glass Windows

Triangle Roll-up Window with Screen

6" Memory Foam Mattress

ADDITIONAL INFORMATION

Wrench size required: 17mm Installation tools: Electric hand drill / stool or 2m ladder.

3m

Outdoorsman Luna Dome

The Outdoorsman fits one-two people comfortably.

The 3m Outdoorsman is ideal for short hunting trips. The built in bed is comparable to a queen mattress. Insulation is top only.

STRUCTURE DIMENSIONS

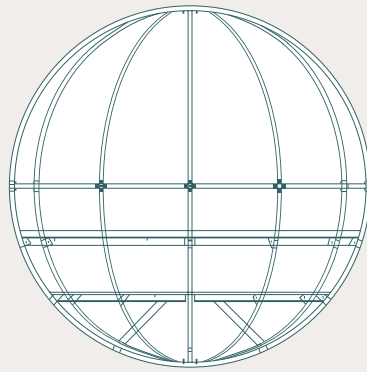

OVERHEAD DIMENSIONS

Floor Area 19.6sqm

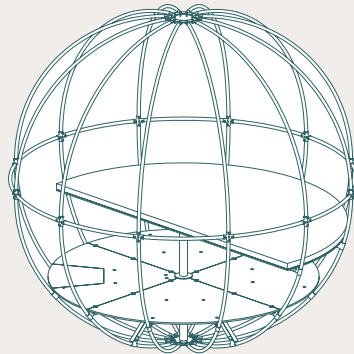

CIRCLE PVC WINDOW (Non-operable)

46cm/18.11in

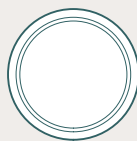

TRIANGLE ROLL-UP WINDOW (With Screen)

72cm/28.35in

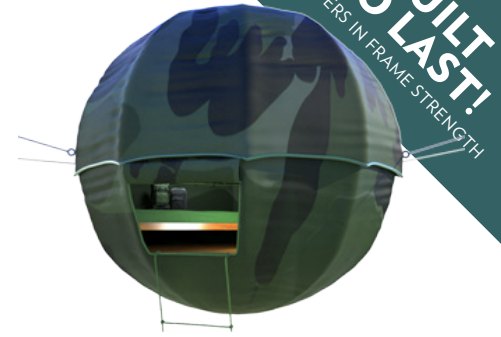
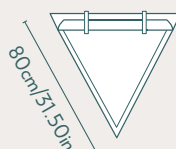

BUILT TO LAST!
LEADERS IN FRAME STRENGTH

SPECIFICATIONS

Diameter	3m / 9.8ft
Center Height	2.3m / 7.5ft
Floor Area	7sqm / 75sqft
Structure Weight	150kg / 330lbs
Exterior Colours	Green Camo

*Custom exterior colours available on request

FRAMEWORK

Framework is made from stainless steel with a flame and tear Resistant PVC cover, 850gsm.

Standard Framework Thickness
28mm OD x 1.4mm wall thickness

Framework Thickness Upgrade Contact

ADD-ONS

Check out pricing online. Custom windows available on request

Two-layer Insulation	<input type="radio"/> <input type="radio"/> <input type="radio"/>
Circle Glass Windows	<input checked="" type="checkbox"/>
Triangle Roll-up Window with Screen	<input checked="" type="checkbox"/>
6" Memory Foam Mattress	<input checked="" type="checkbox"/>

ADDITIONAL INFORMATION

Wrench size required: 17mm Installation tools: Electric hand drill / stool or 2m ladder.

3m

Chillout Luna Spherical Dome

It's all in the name: Chillout. Fits four-six people comfortably.

The 3m Chillout Luna Spherical Dome is perfect for dining, games or hangouts and seats four-six people comfortably.

STRUCTURE DIMENSIONS Floor Area 7sqm/75sqft

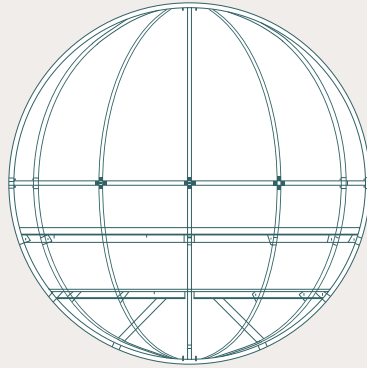

SPECIFICATIONS

Diameter 3m / 9.8ft

Center Height 2.3m / 7.5ft

Floor Area 7sqm / 75sqft

Structure Weight 150kg / 330lbs

Exterior Colours 

*Custom exterior colours available on request

FRAMEWORK

Framework is made from stainless steel with a flame and tear Resistant PVC cover, 850gsm.

Standard Framework Thickness
28mm OD x 1.4mm wall thickness

Framework Thickness Upgrade Contact

ADDITIONAL INFORMATION

Wrench size required: 17mm Installation tools: Electric hand drill / stool or 2m ladder.



Have questions? Call +1 (888) 370-1991 or email hello@lunaglamping.com.
For pricing information visit our website at www.lunaglamping.com.