

Specifications: Model VT-316F(60) Flanged Valve

Vertical - Top In Flow

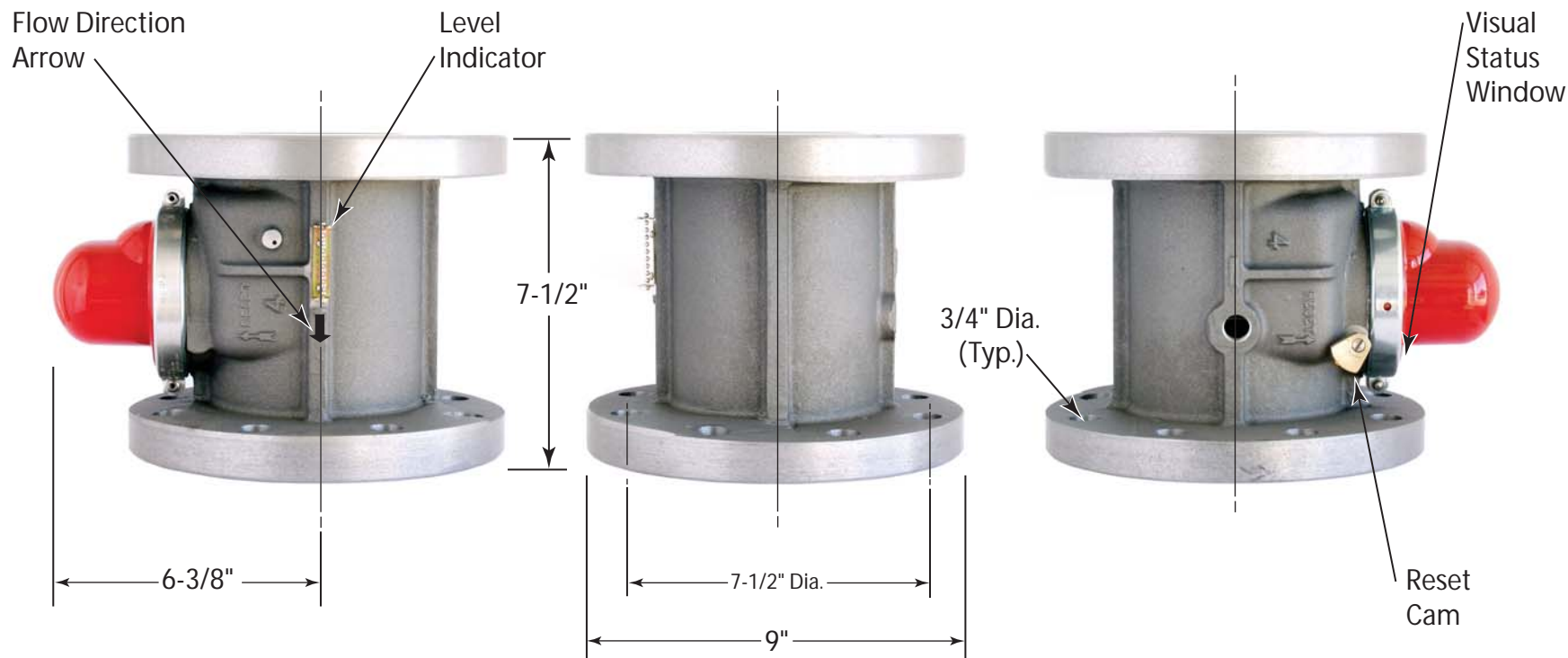

Valve Model#	CA-DSA No.	Length	Height	Diameter	Nominal Pipe Size	APPLICATION	DATA	Diameter On Center	Diameter Hole (Typ.)	Number of Holes
						Max. Pressure	Fuel			
VT-316F	60-05	6-3/8"	7-1/2"	9"	4"	60 psi	Dry Fuel Gas	7-1/2" Dia.	3/4" Dia.	8

California Seismic Valves are UL listed in the USA and Canada, Certified by the California State Architect's Office, Approved by the City of Los Angeles, and are warranted free of manufacturer's defects for 30 years. All valves meet California Standards for Earthquake Actuated Automatic Gas Shut off Systems, Standard No. 12-23-1, ANSI Z21.70, 1981 and ASCE 25-97 Standards.

Pacific Seismic Products

233 East Avenue H-8 • Lancaster, CA 93535 • USA

Tel (661) 942-4499
 Fax (661) 942-0999
 TF (800) 4-GAS-OFF
www.4GasOff.net

