

TESGO

TESGO THUNDER-M MANUAL



Welcome to the TESCO

Welcome to TESCO! Congratulations on purchasing your new E-bike. Your new E-bike is an excellent piece of personal transportation equipment that is guaranteed to provide you with good service for many years to come. Before you start using your E-bike, we want to ensure that you are aware of a few important points. Please read this section carefully.

Observe Laws Regarding the Use of Battery-Operated Bicycles

Your E-bike is designed and manufactured to meet safety requirements as a battery-operated bicycle. However, state and local laws governing the use of battery-operated bicycles on public roadways, parks, and other open areas may differ depending on the area you are living. Please check with your local authority before using your E-bike in public areas.

Observe Laws Regarding the Use of Bicycles

Note that all laws regarding the use of bicycles in public areas, such as those mandating the use of helmets and the use of infant seats, will automatically apply to E-bikes. Check with your local authority on what restrictions might apply.

The Lithium-ion Battery of Your E-bike

Your E-bike is equipped with the latest battery technology. The lithium-ion battery is much lighter than lead or nickel-based batteries that are being used in some older models.

Your First Ride

Please be VERY CAREFUL when riding your E-bike for the first time. Please take into account that E-bikes move significantly faster than a regular bikes under active power-assisted mode. Before riding your E-bike, please make sure that you are in an open area with plenty of space. To ensure your safety, we advise you to take it slow. Do not begin pedaling hard as soon as you get on the E-bike (as you normally would be with a regular bicycle), as the E-bike will accelerate

under the pedal-assist mode, and you may be unprepared for the sudden increase in speed. However, after a few times of practice, you will come to enjoy using the pedal-assisted function. Before you assemble your E-bike, we advise you to watch the full assembly video available on our website and keep the packaging for more than 30 days in case there is a need to return or exchange the product. **WE ARE HERE TO HELP!** If you have questions after reading this manual and watching the assembly video, please contact Tesgo by email. Thanks for riding!

Official Website: **www.tesgobike.com** **www.tesgobike.ca**

For Amazon/Walmart buyers: **service@tesgobike.com**

For Official Website buyers: **support@tesgobike.com**

Importance	01
Product Specification	02
Safety Checklist	04
Assembly Instructions	06
Operation	10
LCD display	14
E-bike APP	26
Care and Maintenance for Your New E-bike	33
Trouble Shooting	36
Warranty	38

When using the electric bicycle, basic safety precautions should always be followed, including the following:

1. Read all instructions.
2. To protect against fire, electric shock, and injury to persons, do not immerse the cord, plugs, or E-bike in water or other liquid.
3. Prohibit children to use it for safety.
4. Unplug from the outlet when not in charging and before cleaning.
5. Do not charge the battery or E-bike if the charger or one of its plugs or cables is damaged. Replace the charging unit.
6. Do not operate the E-bike if it malfunctions or has been damaged in any manner. Take the E-bike to the nearest Authorized service bike shop for examination, repair, or adjustment.
7. The use of accessory attachments not recommended by the E-bike manufacturer may result in fire, electric shock, or injury to persons.
8. Do waterproof when using on a rainy or snowy day.
9. Do not let the cord hang over the edge of the table or counter, or touch hot surfaces.
10. Do not place it around a hot gas or electric burner, or a heated oven.
11. Always attach the plug to the battery first, then plug the cord into the wall outlet.
12. Do not use the E-bike for other than intended use.
13. Save these instructions.

MODEL: THUNDER-M			
Frame Construction	Aluminum Alloy	Motor Power	750W
Wheelbase	1314.6mm	Battery Capacity	48V60Ah
Gear Range	7-speed type	Battery Charger Input Voltage	110/220 volt AC
Tire Size	20"*4.0" (565mm)	Battery Operational Temperature	32° to 104° Fahrenheit
Climb Grade	30 degree	Battery Life	Approximately 600 complete charge/discharge cycles
Max load	330 lb	Max Speed	30Km/h (19Mph)

The following riding range assumes a 60kg (133 lb) load (rider weight + any carry-on weight) on a flat road, with the temperature 25-30°C, at the speed 20kmph(12mph):

THUNDER-M Maximum Riding Range

- In Pedal Assist Mode: 230-260km (140-160 miles)
- In Twist Throttle Mode: 180-200km (110-120 miles)

The load, temperature, speed, and road conditions will significantly affect the endurance. Other factors such as tire pressure insufficient, brake friction, frequent braking, etc. will also affect endurance.

Product Overview

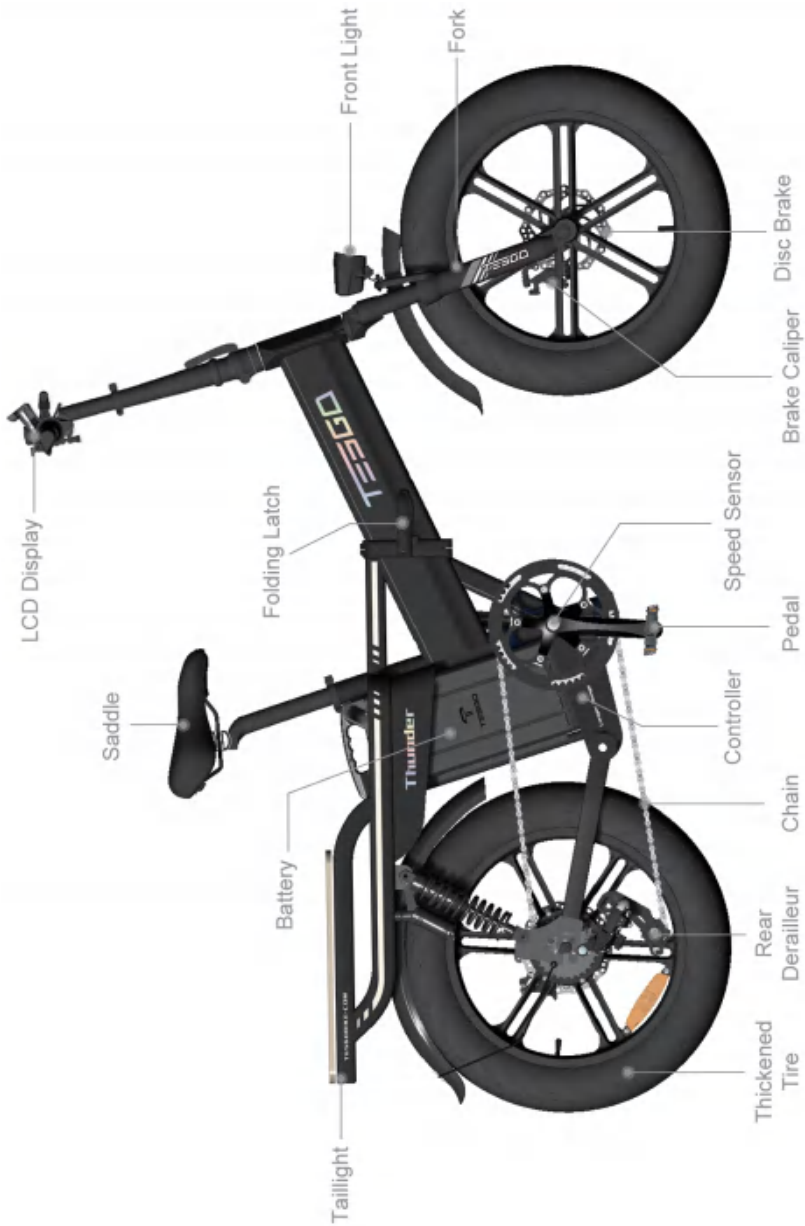

Safety check	Basic Step
Brakes	<ul style="list-style-type: none"> • Ensure front and rear brakes work properly. • Check brake pads and ensure the brake pad material isn't thinner than the backing plate it attaches to. • Ensure brake pads and brake rotors are correctly positioned. • Ensure brake levers are properly positioned and tightly secured to the handlebar.
Wheels and tires	<ul style="list-style-type: none"> • Ensure tires are inflated to the recommended PSI. The detailed tire information on the tires. • Ensure tires have tread, no bulges or excessive wear, and other damage. • Ensure rims run true and have no obvious wobbles, dents, or kinks. • Check each wheel spoke. Make sure they are not loose or broken.
Steering	<ul style="list-style-type: none"> • Ensure the handlebar and stem are correctly aligned, adjusted, and tightened for proper steering. • Perform a handlebar twist test to ensure the stem clamp bolts are secure and check handlebar grips are secure and undamaged. • Ensure the handlebar is set correctly in relation to the fork and the direction of travel.
Chain	<ul style="list-style-type: none"> • Ensure the chain is oiled, clean. • Extra care is needed in wet or dusty conditions.
Cranks and pedals	<ul style="list-style-type: none"> • Ensure pedals are securely tightened to the cranks. • Ensure the cranks are not bent and are securely tightened to the bottom bracket.

Derailleurs	<ul style="list-style-type: none">• Check that the derailleur is adjusted and functioning properly.• Ensure the shifter is attached to the handlebar securely and is shifting properly
Frame, fork, and seat	<ul style="list-style-type: none">• Check that the frame and fork are not bent or broken.• Check that the seat is adjusted properly.
Motor drive assembly	<ul style="list-style-type: none">• Ensure the hub motor is spinning smoothly and is in good working order.• Ensure the power cable running to the hub motor is secured and undamaged.
Battery Pack	<ul style="list-style-type: none">• Ensure the battery is charged.• Ensure there is no damage to the battery.

If you purchased your E-bike unassembled, please follow these instructions to assemble your E-bike under the guidance of an adult or a qualified technician. Assembly is quite easy as most of the parts are already assembled; you need only to put a few large pieces together to complete the job.

For more information, please refer to this website:

www.tesgobike.com www.tesgobike.ca

Step 1: Check that the Package is Complete and Undamaged, then remove the packaging material protecting the bicycle frame and components.

Your E-bike comes in a carton containing the following:

- The main body of the E-bike – consists of the frame, the rear wheel, the gear and chain, the rear brake, and the battery in or on the frame.
- The handlebar subassembly with the battery's keys attached to it – the handlebar subassembly is not really separate, as it is connected to the main body by the brake cables and electrical wires. The handlebar also has brake levers and gear control already assembled. Additionally, the handle also has an integrated control for the throttle power-assisted mode and a display panel.
- The Seat – the seat is attached to its pedestal stem.
- The front wheel.
- The front wheel fender with supports.
- Front light – the front light is not really separate, as it is connected to the main body by an electrical wire.
- Tools and other parts –tools, one charger, a pair of foot pedals, and this manual, are contained in a separate box.

Step 2. Unfold the ebike

- Close the latch and make sure it is fully secure unfold.

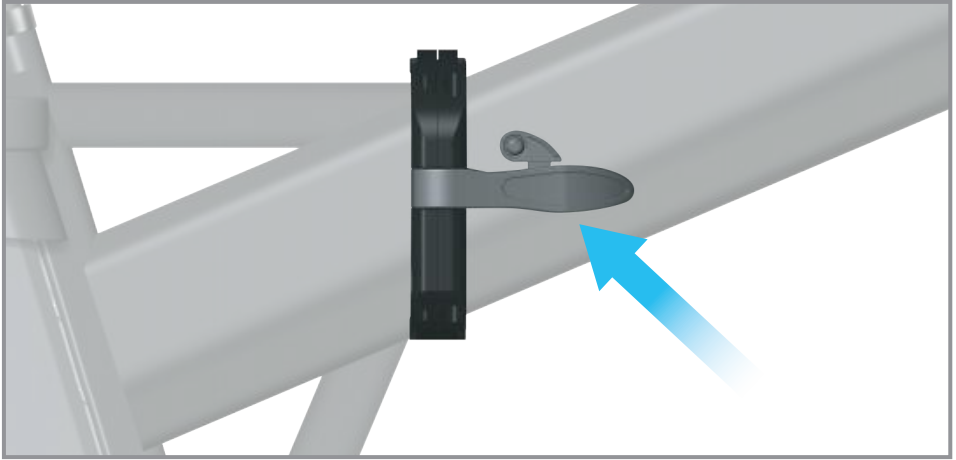
**Step 3. Install the handlebar**

- Close the quick-release lever on the stem.
- Raise or lower the stem to the desired height, rotate the handlebar left or right until it is perpendicular to the front wheel.
- Close the clamp to lock the stem in place.



Step 4. Adjust the saddle height

- Open the lever on the seatpost clamp and adjust the height and angle of the seatpost to the desired position.
- Align the saddle with the centerline of the bicycle.
- Close the seatpost clamp to lock the seatpost in place.



Step 5. Install the pedals

- The pedals have "L" and "R" markings embossed on the pedal indicating the left or right pedal.
- Using the wrench, tighten(clockwise) the right pedal in place.
- Repeat these steps for the left pedal in the left crank rotating and tightening the pedal counterclockwise.



Step 6: Pump the tires

- Pump the tires up to your desired pressure. Refer to the tire's sidewall for the pressure range.

Step 7: Charge the battery

- Take out the charger from the box, attach the plug to the battery first, then plug the cord into the wall outlet. (The charging terminal is on the side of the battery opposite to a hole on the side of the frame.)
- The battery should be turned OFF while being charged.
- When the LED on the charger turns Green, disconnect the charging cord and cover the charging terminal with the rubber cap. If a battery is installed on the E-bike and turned ON, the display panel will show the charge level of the battery when the bike is turned ON.

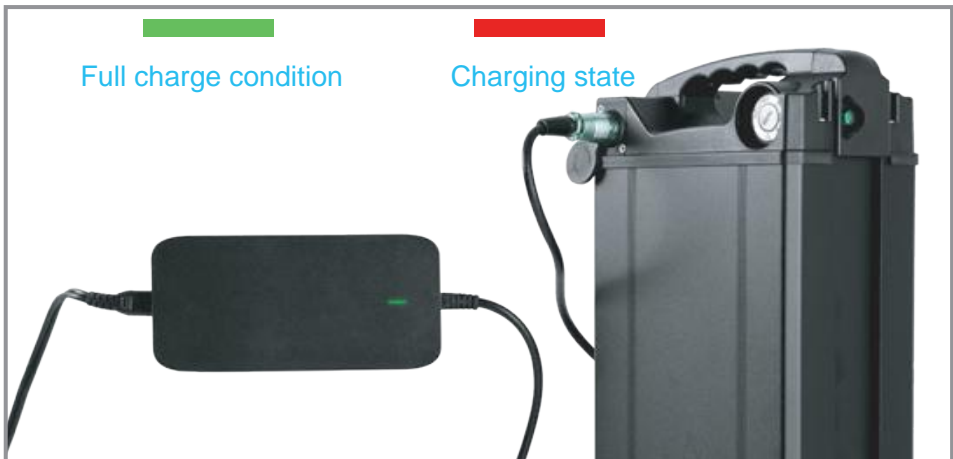

The method to turn on the bike is:

- I. Twist the key of battery lock counterclockwise to the end to turn on the battery.
- II. Press the power button on the left handlebar until the display lights on.
- III. Ride on the bike and press the throttle bar or pedal the bike, the bike will move, and you can change the power level with control buttons.

Your E-bike is driven by a motor embedded in the hub of the rear wheel. The motor is powered by a battery. The amount of power delivered to the motor and hence the accelerating force on the E-bike is controlled by you in a way according to the power-assisted mode or full power mode you choose.

You can configure the E-bike to operate in the pedal-assist-only mode or the full power mode (should check against local laws to ensure full power mode is permitted) where you can also use the thumb throttle to deliver power to the motor.

● Pedal-Assisted

You must **turn on the battery** to use the E-bike in pedal-assisted mode.

In the pedal-assisted mode, power assist is triggered when you pedal forward, and power assist stops when you stop pedaling, some time would be a delay. In other words, power assist happens as long as you pedal. You don't need to pedal hard. All you need is to apply a light force to the pedals continuously to maintain the current flow. When you apply one of the brakes, the power assist will automatically stop, allowing the E-bike to slow down and stop. Power assist will turn itself off when the E-bike has reached the maximum speed that the power level you choose.

You should use the gear shifter at the handlebar to set the gears appropriately according to road conditions and pedal, as usual, you will find that you need to exert a lot less effort and the E-bike travels faster and at a more steady speed.

- **Cruise Control**

Cruise Control will be triggered by holding the thumb throttle for 8 seconds, and it will be released by braking/pedaling or throttling.

- **Half-twist Throttle Control**

In the Half-twist throttle mode, the amount of power assist is determined by the half-twist throttle controlled by your hand. When you want to slow down, you simply release the throttle, and simultaneously apply the brakes if necessary.

You do not need to pedal the E-bike if you use the half-twist throttle.

Of course, you can pedal while commanding power assist. If you use the pedal to help the movement, you can conserve energy, and the charge in the battery will last longer.

- **Charging Your E-bike Battery**

Your E-bike battery is a lithium-ion battery. Lithium-ion battery requires specially designed chargers. You should never charge your battery with a substitute charger that is not designed for this use. The use of an unsuitable charger to charge a lithium-ion battery will result in overheating, fire, or even explosion. Ensure charger voltage is consistent with battery voltage. If your charger is lost or damaged, contact your dealer to order a replacement.

Charge your battery while the E-bike is not in use. You should turn off the battery before you charge it. You may charge your battery while it is mounted on the E-bike, or after it has been removed from the E-bike.

Do not place either the charger or the battery near flammable substances while charging is taking place. Charging should not be done in the vicinity of infants and small children. It is also prudent to remove valuable objects from the immediate vicinity of the battery while it is being charged. Don't charge in unattended condition for a long time.

In order to maintain battery life, do not charge until the battery is completely discharged, it is recommended to start charging when the power is less than 20 percent. If the battery will not be used for an extended period, charge it fully and recharge it every month. If not used for several months, the battery may be completely self-discharged and unable to charge.

The length of charging time depends on the level of charge the battery still holds. If a battery is completely discharged, it will take 6 hours to be fully recharged.

When a battery is fully charged, the LED on the charger will transition from RED to GREEN. At this point, you should disconnect the charger. Do not leave the charger connected to the battery for a very long period after charging is complete. (Leaving it connected for overnight charging is OK.)

It is normal for the charger and the battery to be slightly hot while charging is ongoing.

● **Removing the Battery from the E-bike**

The battery is an important and costly part of the E-bike. It is designed to be locked into a position with a key to prevent theft. You can take further precautions by removing the battery while the E-bike is parked unattended. You may also have a need to remove the battery from the E-bike to recharge it at a location where you cannot park your E-bike.

The method to remove the battery is:

I. Insert the key into the battery, hold pressing the key a bit until twist clockwise to the end (Note: You can't remove the battery until the lock bar withdraws into the battery completely);

II. Take out the battery, the battery is quite heavy, and you should take care not to drop it.

● Maximizing the Riding Range

Many factors affect the rate of use of electrical energy and the riding range.

- ★ You should fully charge the battery before a long journey.
- ★ Rough road conditions and hilly terrain will consume more energy.
- ★ Frequent changes in speed will consume more energy.
- ★ Carrying more weight on the E-bike will consume more energy.
- ★ Keeping the tires properly inflated and keeping the E-bike clean and well lubricated will save energy.
- ★ Making sure that both wheels move freely when brakes are not applied will save energy. You should check brake adjustments frequently.
- ★ Pedaling as you ride will consume less electrical energy and increase the riding range.
- ★ When the battery is turned off, your E-bike functions as a regular bicycle. If you embark on a very long journey, you might want to turn off the battery for long stretches where the road is level or downhill and pedal the E-bike as a regular bicycle so that you can conserve electrical energy stored in the battery.

The image shows the various features and information displayed on the display.



Power on/off

- Power on: Press and hold the power button for two seconds until the LCD turn on.
- Power off: Press and hold the power button for two seconds until the LCD turn off.

⚠ Caution: The display will automatically turn off if not used for more than 10 minutes.

PAS Level Selection

- Press the + (up) / - (down) button to select the assistance level.

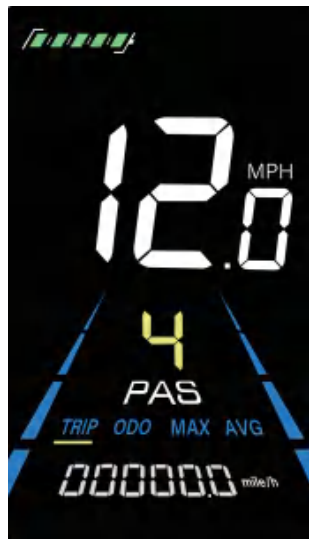
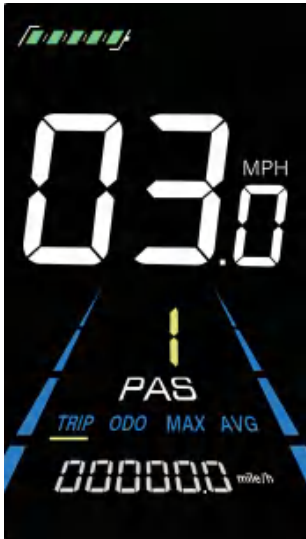

Display interface switching

- When the display is turned on, the Current Speed(km/h) and Trip Odometer(km) are displayed by default.
- Short press "i" to switch between Trip Odometer(km), Odometer(km), Top Speed(km/h), and Average Speed(km/h).

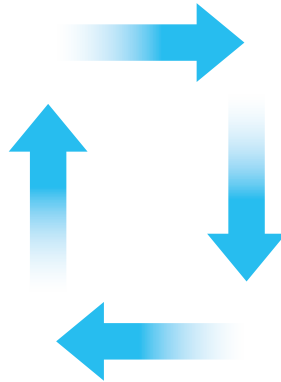
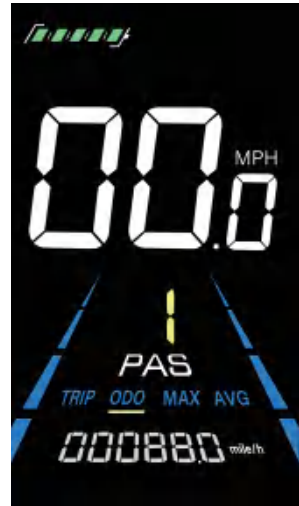



Walk Boost Mode

- Press and hold the “-”, the ebike enters the walk boost mode.
- In this mode, the ebike travels at a constant speed of 6km/h. At the same time, the screen displays “”.
- Release the “-” button and the ebike will stop the power output and return to the original state.



⚠ Caution: The walk boost mode can only be used when the users push the ebike. Do not use it when you are riding the ebike.

Turn On/Off the light

- Press the "  " button to turn on the light.
- Press the "  " button again to turn off the light.

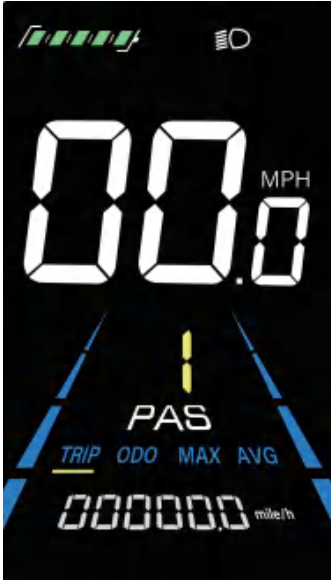

Light on

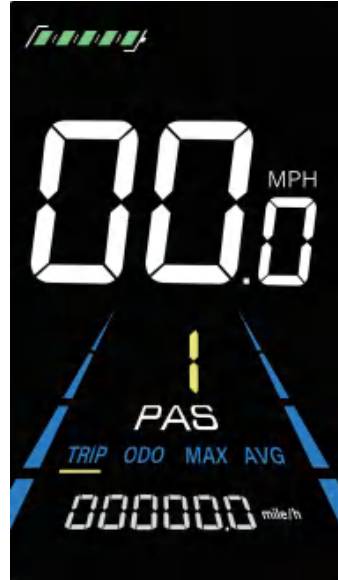

Light off

Battery indicator

- The indicator on the display of your ebike features a battery capacity gauge. It is highly suggested to charge the E-bike as soon as two bars are left on the indicator. It is also better for battery protection. Once the battery is fully depleted, the ebike will stop. 5 bars indicate full power.

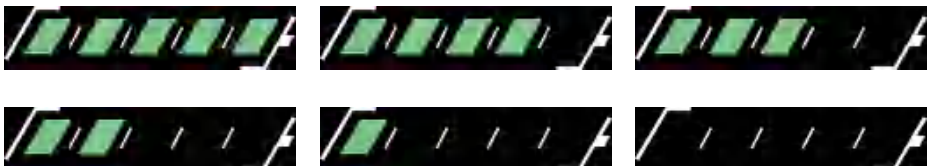

⚠ Caution: All settings need to be done when the vehicle is stationary.

- Press and hold "+" and "-" for two seconds to enter the settings mode.
- Press "+" or "-" to switch the interface. Press "i" to change the parameter.
- Press "i" to save the parameter and return to setting mode.
- Press and hold "i" to save the parameter and quit setting mode.

P01 - Mileage Units Setting

- 00: KM/H ; 01:MPH

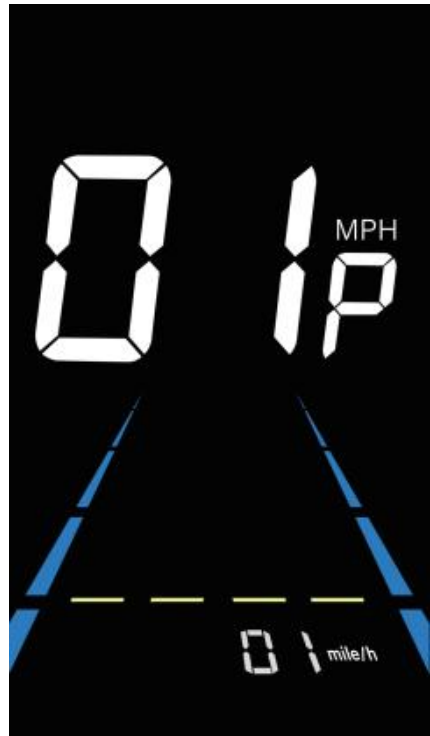

P03.1 - Pedal Assist Setting

- These 1-5 gears are factory set, but the display gears are settable. The available gears are 0-3, 1-3, 0-5, 1-5, 1-7, 0-7, 0-9, 1-9. The higher the number, the faster the speed.



P03.2 - Assist Ratio Numerical Setting

- By setting the assist ratio value, the speed of each level can be adjusted to meet the needs of different riders. The default ratio value of PAS 1 is 50%.



Default Table

Pedal Choice Pedal	0-3/1-3	0-5/1-5	0-7/1-7	0-9/1-9
1	50%	50%	40%	25%
2	74%	61%	50%	34%
3	92%	73%	60%	43%
4	-	85%	70%	52%
5	-	96%	80%	61%
6	-	-	90%	70%
7	-	-	96%	79%
8	-	-	-	88%
9	-	-	-	96%

P04 - Wheel Diameter Setting

- The adjustable wheel diameter range is 8-50 inches.

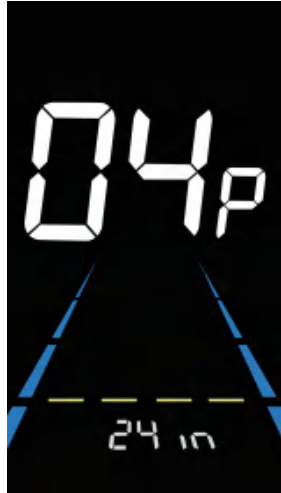

P06 - Speed Limit Setting

- The adjustable speed limit range is 1~60km/h or 1~41km/h.



P10 - Power-on Password Setting

- The power-on password is not activated by default, but users can activate it by setting it.
- The factory default password is 1212, users can set other four-digit passwords.
- PSd-y means the power-on password is activated; the PSd-n means is turned off.
- Press "i" to confirm the mode, enter the password setting status, and set the power-on password.

Note: After changing your password, please remember your password, otherwise you will not be able to use the display; If you need to replace the display due to forgetting the password for personal reasons, it is not covered by the warranty.

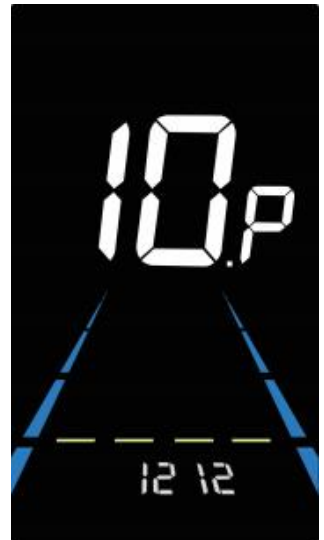

Quick Setting Restore Factory Settings

- dEF-Y is to restore default settings, and dEF-N is not to restore.
- Press "  " and "+" for two seconds to enter the interface. Press "+" or "-" to switch the interface.
- Press the "i" button to confirm, the display will show the dEF-0 for a few seconds and then automatically start to restore the factory default settings. The display will automatically exit the setting interface after the restoration.



TRIP Zero-Out

- Press and hold “-” and “i” button for 2 seconds when the speed of the interface is 0.

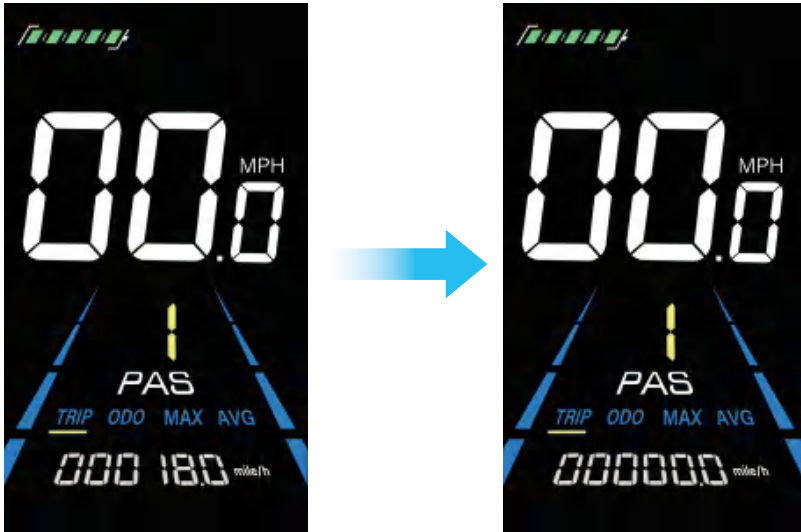

Error Code

- If the system detects an error, it shows on the display. If you receive such an error, please restart the system.
- If the error message continues to display, please your Authorized TESGO Support Team for further instructions.



Note: This App is only available for Android devices.

1. Download and Install

- Scan the QR code to download your E-bike App
- Or download it at <https://www.pgyer.com/92m4>



Note: When using the APP for the first time, you will be prompted to obtain permissions. Please allow all permissions requested by the application. Otherwise, some functions may not be available.

2. Register Account

- Open the APP and click "Create Account".

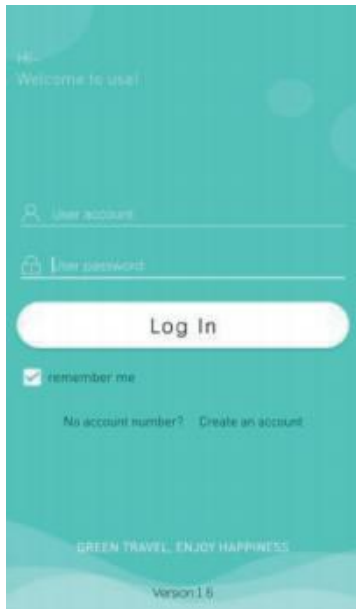

Note: You can also click "No Account Number" to directly enter the APP experience.

3. Main Interface

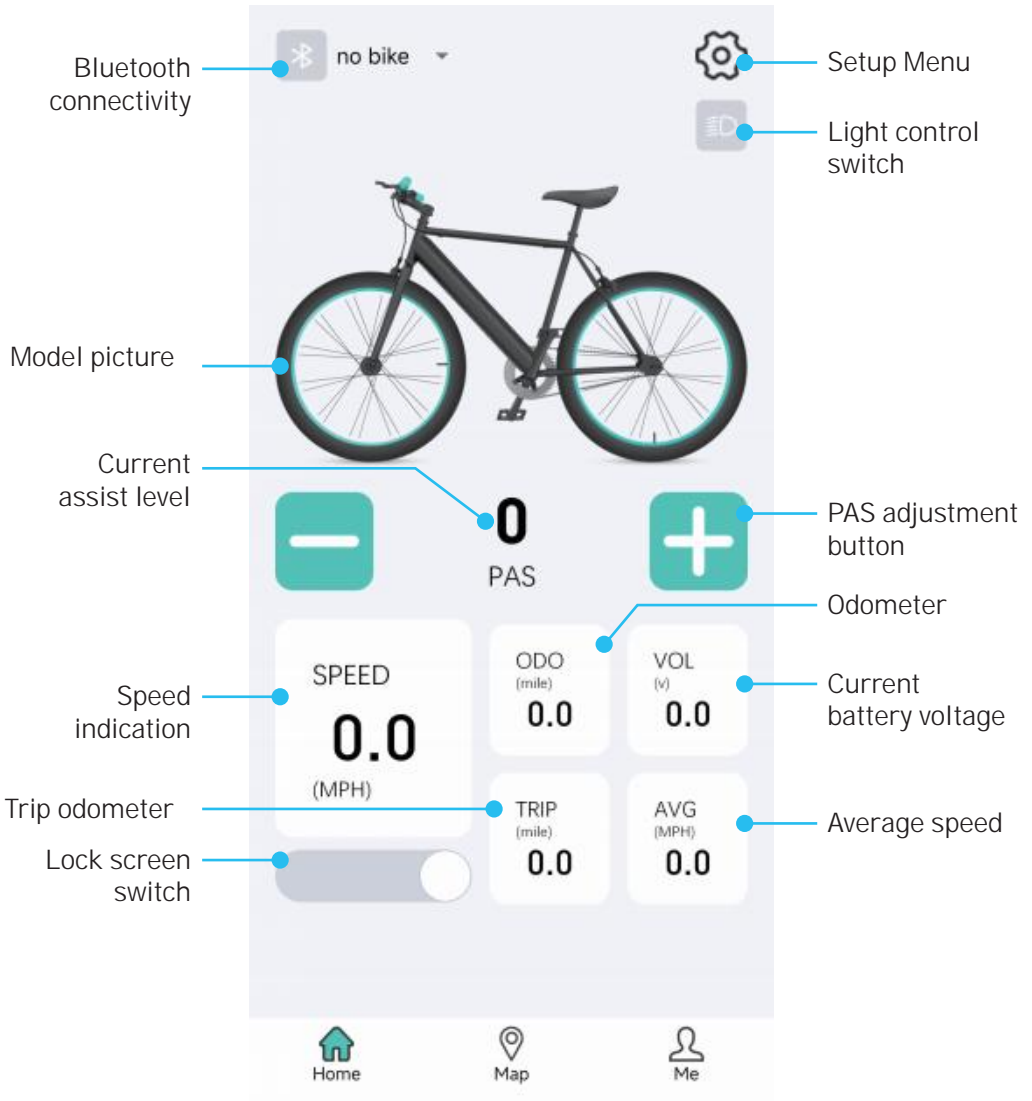

4. Connect the Bluetooth

- 4-1. Click the Bluetooth icon.
- 4-2. Click to search Bluetooth.
- 4-3. Click on the Bluetooth device information that appears on the screen to connect, and select the device with the name "Yolin" to connect.
- 4-4. After the connection is successful, the meter will display the Bluetooth icon.

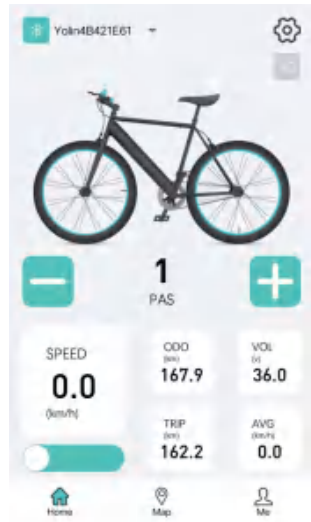
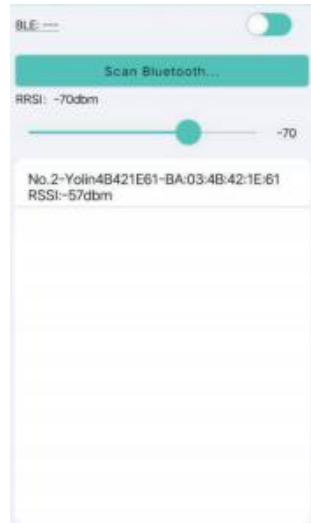
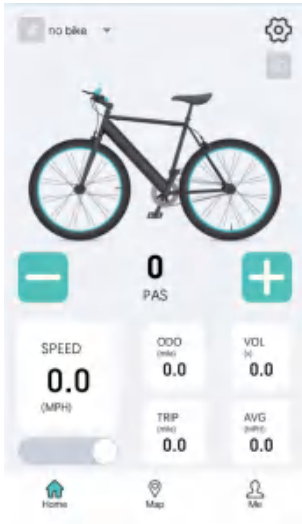

5. Setup Menu

Vehicle information
Bluetooth name, MAC address, speed limit, current limit, wheel diameter, software version and other information are involved



Display unit setting
User can quickly modify the default unit of the display

Startup mode setting
User can quickly modify the zero start mode / non-zero start mode (note: this function is only supported by some protocols)

Speed limit setting
The user can quickly modify the maximum speed limit of the vehicle

Restore factory settings
The user can quickly restore the factory settings of the display

Advanced parameter setting
Some more settings can be set. Advanced parameters need to be entered with a password. Generally not open.

Clear Trip
The user can clear the trip mileage of the display

Bind display button
Users can use this button to bind and unbind the display. After binding the display, this display can only be connected to this account

Historical faults
The user can query the historical fault of the display

The screenshot shows a control panel with the following elements:

- Unit:** Buttons for KM/H and MPH.
- Start mode:** Buttons for Zero start and Nonzero.
- Assist strength:** Buttons for -, 0, and +.
- Limit speed:** A section with ON, -, 0, and + buttons.
- Clear Trip:** A large button to clear trip mileage.
- Restore factory settings:** A button to reset settings.
- Advanced parameter settings:** A section with a right-pointing arrow.
- Device status:** A message "Device is not Connected" and a "MAC:" label.
- Control buttons:** "Unbind" and "Historical Faults" buttons.

6. Map Interface

At present, the map interface can only display the current location, current battery voltage, cycling mileage, current speed information.



You should, in general, take care of your E-bike the way you would with a regular bicycle by keeping it dry, clean and the moving parts well lubricated. You should also avoid parking your E-bike in exposed areas whenever possible.

You should check the effectiveness of the brakes before each use.

- **For your E-bike, you should also take note of the following:**

- ★ Your E-bike is designed for regular country road use for a single person. Using your E-bike for extreme maneuvers, such as extreme off-road use, jumping, or carrying an excessive load will damage the E-bike and could cause serious injury.
- ★ Do not use high-pressure water streams to clean your E-bike, as water might seep inside the motor or the wiring compartment and cause rusting of electrical parts or short circuits.
- ★ Avoid parking your E-bike outside when there is rain or snow. At the end of a trip where there was rain or snow, bring the E-bike inside and use a clean, dry towel to eliminate any wetness.
- ★ Be sure you do not lose both keys. If you lost one key, you should immediately make a copy as a back-up. If you lost both keys, you will be unable to remove the battery from the E-bike.

- **Special Care for the Battery and the Charger**

- ★ Use only the supplied charger to charge your battery. Do not use an unauthorized substitute. If your charger is lost or damaged, contact your dealer to order a replacement.
- ★ Do not open or alter the battery or the battery charger.
- ★ Do not place the battery near fire or corrosive substances.
- ★ Do not immerse in water or other liquids.
- ★ Avoid subjecting the battery to high temperatures, such as directly under the hot sun, for prolonged periods of time.
- ★ Do not connect (short circuit) the two poles of the battery.
- ★ After much use, your battery's charge holding capacity will decrease. If you find that your battery does not hold a sufficient charge even for short trips, you should

contact your dealer to order a replacement. Under normal use, the battery will undergo 500 charging and discharging cycles.

★ If the battery will not be used for an extended period of time, charge it fully and recharge it every month. Store it in a cool place.

★ Your E-bike battery is engineered with precision for high capacity and long useful life. We do not recommend that you use it to power other electrical devices. Improper use of the battery will damage the battery and shorten its useful life and may cause a fire or an explosion.

Safety

These safety precautions are provided for your benefit to protect you and those around you. Please read and follow them carefully to avoid unnecessary injury, damage to the product, or damage to other property.

Battery

CAUTION

■ Do not throw the battery into a fire. Do not overheat the battery.



■ Do not connect the battery to other appliances other than your battery.



■ Use only the specified charger to charge the battery.



■ Do not take apart or modify the battery.



Disassembly Prohibited

■ Do not connect positive and negative terminals by using metallic objects.



(Electrolyte leakage, overheating and/or rupture may result in this type of abuse.)

Battery Charger

⚠ CAUTION

- Do not take apart or modify the charger



Disassembly
Prohibited



Overheating, fire or electric shock may result

- Do not subject the charger to shocks, e.g. by dropping. Keep the charger away from water



- Do not touch the charger with your skin for long periods during charging



Burning of the skin may result, as external temperature of the charger during charging may become 40C-60C(104F-140F)

- Do not cover the charger or place objects on it



Overheating, fire or electric shock may result

- Place the charger firmly on a flat dry surface



Using the charger upside down or stretching the cable tight may result in malfunction, fire or electric shock

- Do not short-circuit the terminals by using metallic objects



Overheating, fire or electric shock may result

⚠ WARNING

- Keep the battery away from water. Pouring water on the battery may result in short-circuit, overheating or permanent damage of the battery.

- Do not submerge the battery. Soaking the battery in water may cause irreparable damage.

⚠ WARNING

- Do not apply pressure to the cable or the plug.



Placing the cable tightened between a wall and a window frame, or placing heavy objects on the cord or the plug may result in electric shock or fire.

- Be sure to insert the plug securely into a wall socket.



Electric shock and overheating may result, causing fire.

- Do not touch the plug with wet hands.



Electric shock may result.

- Keep out of reach of children or pets.



Electric shock or injury may result.

- Do not attempt to use another maker or model's charger to charge the battery.



Overheating, fire or electric shock may result.

- Do not use the charging plug and/or the power source Plug when they are dirty, wet or dusty.



Insulation failure due to moisture absorbed in the dust may result, causing fire.

Pull out the power source plug and clean it with a dry cloth.

- To remove a cable from a socket, pull the plug, not the cable.



Always pull the charging cable gently.

- Do not rotate the pedals when charging the battery while it is mounted on the bicycle.



The cord may twist around the pedal or the crank, and the damage to the plug may result, causing electric shock or fire.

- Do not apply voltage over the rated value to the charger.



Do not use sockets, correctors and other wiring devices with a power source other than standard rated voltage (AC110-240 volts) power supply.

- Overheating, fire or electric shock may result.

- Do not use damaged components such as charge case, power cord, plug etc.

Electric short, short-circuit or fire may result.

As one or more causes of failure might lead to the failure phenomenon, you should find out the true cause(s) and then take the appropriate solution(s) to rectify the problem. In case of doubt, please consult a qualified technician for service, repairs, or maintenance.

Failure Phenomena	Causes of Failure	Solutions
<ul style="list-style-type: none"> • Can not turn on the e-bike 	<ul style="list-style-type: none"> • Battery is off • The Battery is out of power • Battery aging or damaged • Poor contact with the display line • Failure of the controller • Failure of switch 	<ul style="list-style-type: none"> • Turn on the battery • Fully charge the battery • Replace the battery • Reconnect the display • Replace the controller • Replace the switch
<ul style="list-style-type: none"> • Pedal assist doesn't work • Gear doesn't work well • Brake doesn't work well • Display doesn't light on 	<ul style="list-style-type: none"> • Failure of speed sensor • Rear derailleur mismatch • Brake caliper mismatch • Brake Disc is bent • Poor contact with the display line 	<ul style="list-style-type: none"> • Replace the speed sensor • Adjust the rear derailleur • Adjust brake caliper or disc • Reconnect the display line
<ul style="list-style-type: none"> • Can not adjust the speed • Speed is less than 10km/h 	<ul style="list-style-type: none"> • Battery's voltage is too low • Throttle governing bar is damaged • Poor contact with the controlling line • Spring failure or being locked 	<ul style="list-style-type: none"> • Fully charge the battery • Replace the throttle governing bar • Replace the spring

<ul style="list-style-type: none"> • E-bike's mileage is obviously inadequate after fully charged 	<ul style="list-style-type: none"> • Inadequate tire pressure • Failure of charger • The battery cannot be fully charged • Failure of the controller • Battery aging or battery damaged • E-bike has not been well assembled • Too much upgrade road • Strong wind • Bad road • Overweight • Too many braking times • Temperature is too low 	<ul style="list-style-type: none"> • Inflate the tire with appropriate air pressure • Repair the charger • Examine and repair the controller • Replace the controller • Replace the battery • Re-adjust the E-bike • Boost the E-bike with manpower • Warm the battery above 0°C (32°F)
<ul style="list-style-type: none"> • Wheel hub stops running after switching on the power 	<ul style="list-style-type: none"> • The connection of the battery is loosened • Poor contact of controlling line • The connection of the wheel hub is loose or damaged • The protective board of the battery is broken 	<ul style="list-style-type: none"> • Re-connect the battery • Replace the connection line • Replace the battery's protective board with a new one

All Tesgo E-bikes, and their individually covered components (as defined herein), are protected against all manufacturing defects in material or workmanship for one (1) year after receipt of the E-bike by the customer (the "warranty period"). This limited warranty is only applicable to united states E-bike purchases (purchases in Canada and the European Union shall be subject to their respective warranty terms) and in accordance with the following terms:

- Only the original owner of an E-bike purchased from Tesgo's online, or physical storefront is covered by this Limited Warranty. The Warranty Period begins upon your receipt of the E-bike and shall end immediately upon the earlier of the end of the Warranty Period or any sale or transfer of the E-bike to another person, and under no circumstances shall the Limited Warranty apply to any subsequent owner or other transferee of the E-bike.
- The Limited Warranty is expressly limited to the replacement of a defective lithium-ion battery (the "Battery"), frame, forks, stem, handlebar, seat post, saddle, brakes, lights, bottom bracket, crank set, pedals, rims, wheel hub, freewheel, cassette, derailleur, shifter, motor, throttle, controller, wiring harness, LCD display, kickstand, reflectors, and hardware (each a "Covered Component").
- The Covered Components are warranted to be free of defects in materials and/or workmanship during the Warranty Period.
- If the customer modifies the product privately, there is no warranty service for the modified product.

THIS LIMITED WARRANTY DOES NOT COVER

- Normal wear and tear of any Covered Component.
- Consumables or normal wear and tear parts (including without limitation tires, tubes, brake pads, cables, housing, grips, chain, and spokes).
- Any damage or defects to Covered Components resulting from failure to follow instructions in the E-bike owner's manual, acts of God, accident, misuse, neglect, abuse, commercial use, alterations, modification, improper assembly, installation of parts or accessories not originally intended or compatible with the E-bike as sold,

operator error, water damage, extreme riding, stunt riding, or improper follow-up maintenance.

- For the avoidance of doubt, Tesgo will not be liable and/or responsible for any damage, failure, or loss caused by any unauthorized service or use of unauthorized parts.
- The Battery is not warranted from damage resulting from power surges, use of an improper charger, improper maintenance or other such misuses, normal wear, or water damage.
- Any products sold by Tesgo that are not an E-bike.
- Determining whether damage or defect to an E-bike or covered component is protected by this limited warranty shall be at the sole discretion of Tesgo.

SHIPPING DAMAGE

Damage to a Covered Component during shipping is not covered by this Limited Warranty, but Tesgo will replace such damaged Covered Components if you:

- Notify Tesgo of a Covered Component damaged in the shipping process within fourteen (14) days of your receipt of the E-bike.
- Provide Tesgo with a dated picture of the damaged Covered Component.
- Return all original packaging and paperwork included with the E-bike.
- Note any immediately recognizable damage on the shipper's Bill of Lading prior to signing off on the shipment.

Shipping damage claims are very time sensitive, and it is your responsibility to immediately inspect the E-bike for damage upon receipt.

If you choose to set up your independent shipping methods, such as the use of a freight forwarder or other similar service, Tesgo will not replace any Covered Components damaged during such shipping method.

CREDIT CARD CHARGEBACKS

If any E-bike purchase becomes subject to a credit card chargeback in any amount, and you are still in possession of the E-bike, then this Limited Warranty shall be invalidated until the credit card chargeback has been resolved.

CLAIMS PROCESS

Tesgo will not replace any covered component under this limited warranty without first seeing photos or video of the damaged covered component. In order to exercise your right to receive a replacement for a Covered Component under this Limited Warranty, you must:

contact the Tesgo Technical Support team via the after-sales email. The Technical Support team will initially work with you on the problem with your E-bike to identify potential simple fixes.

If the technical support team determines that a covered component must be replaced, they will provide you with a set of instructions for returning the defective covered component and receiving the replacement. After you receive the replacement covered component, the technical support team will also assist in determining how to replace or install the new covered component into your E-bike. You will be responsible for shipping costs associated with returning a covered component, unless Tesgo agrees in writing to pay for such shipping costs. Replacement covered components under this limited warranty shall only be shipped to the address of the original purchaser.

The remedies described above are your sole and exclusive remedies and Tesgo's entire liability for any breach of this limited warranty. Tesgo's liability shall under no circumstances exceed the actual amount paid by you for the E-bike, nor shall Tesgo under any circumstances be liable for any consequential, incidental, special, or punitive damages or losses, whether direct or indirect. Some states do not allow the exclusion or limitation of incidental or consequential damages, so the above limitation or exclusion may not apply to you. This limited warranty gives you specific legal rights and you may also have other rights, which vary from state to state. To the

extent permissible under applicable law, Tesgo disclaims all implied warranties, including without limitation the warranties of merchantability and fitness for a particular purpose for the duration of this express limited warranty. Some states do not allow limitations on how long an implied warranty lasts, so the above limitation may not apply to you.