



511 S. Harbor Blvd. #V • La Habra California • 90631

tel. 562.407.2186 • fax. 562.802.7706

www.hjchelmets.com

If you have any questions, please e-mail us at: info@hjchelmets.com



IS-33II

OWNER'S MANUAL

WARNING

For your safety, it is important that you completely read the owner's manual and all warning labels.



Although this helmet meets the DOT motorcycle standards, you can get more protection by purchasing a helmet with greater head coverage.

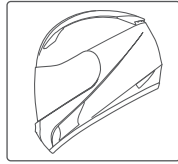

Full Face

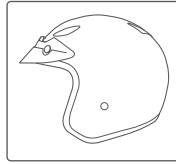

Three Quarter

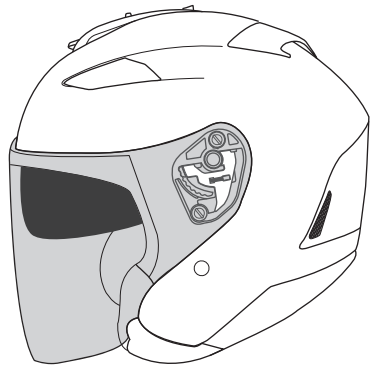

IS-33 II

- **Advanced Polycarbonate Composite Shell:** Lightweight, superior fit and comfort using advanced CAD technology.
- **One-touch Integrated SunShield:** 3-stage adjustable sun shield deploys quickly and easily.
- **UV-treated Flip-up Faceshield:** Opens easily.
- **QuickSlide™ Shield Replacement System:** Quick, secure, tool-less removal and installation.
- **“ACS” Advanced Channeling Ventilation System:** Full front to back airflow flushes heat and humidity up and out.
- **SuperCool® Interior:** Moisture-wicking and odor-free interior. Crown and cheek pads are removable and washable.

DOT Approved
SIZES: XS-2XL

※ Please visit www.hjchelmets.com for more information about HJC helmets.

Important Safety Information	3
Selecting the Right Helmet	3-4
Specifications	4
Using Your Helmet Correctly	5-6
Inspect Your Helmet	5
Fasten the Retention System	5-6
Maintaining Your Helmet Correctly	6-12
Shell Cleaning	6
Interior Cleaning	6
Vent Cleaning	6
Shield Cleaning	6
Shield Removal	7
Shield Installation	7
Cheek Pad Removal	7
Cheek Pad Installation	8
Crown Pad Removal	8
Crown Pad Installation	8
Sun Shield Operation	9
Sun Shield Removal	10
Sun Shield Installation	10
Visor Removal.....	11
Visor Installation.....	11
Replacement Parts	12
Helmet Modifications	12
Storing Your Helmet Correctly	12
Helmet Replacement	12
Warranty.....	13

⚠ Important Safety Information

⚠ WARNING

The instructions in this manual are designed to help you select the right helmet, wear it properly, take care of it, and know when to replace it. Failure to follow these instructions may increase your risk of serious injury or death in an accident.

In order to get the most protection possible from your helmet, you should always do the following:

- Wear your helmet when you ride;
- Handle your helmet carefully to avoid accidental damage; and
- Ride safely – do not take risks because you are wearing a helmet.

Although your HJC helmet is designed to reduce or prevent some injuries when worn, no helmet can protect you from all possible or foreseeable impacts. For example, your helmet cannot protect you from spinal or neck injuries. In addition, there is no guarantee that your helmet will PREVENT injuries to the area of your head that is covered. A low speed accident may even result in serious injury or death.

⚠ Selecting the Right Helmet

⚠ WARNING This helmet does not provide as much coverage or protection as a full face helmet. You can get more protection by purchasing a helmet with greater head coverage.

⚠ WARNING Never buy a used helmet or borrow someone else's helmet. Over time the protective foam in helmets will adjust to the contours of a user's head. A used or borrowed helmet may not offer as much protection as a new helmet.

⚠ WARNING Wearing the wrong size helmet can increase your risk of serious injury or death in an accident. A helmet that is too large for your head may be dislodged or knocked off in an accident. To select the right size helmet for your head, follow these instructions:

1. **Measure your head.** Wrap a tape measure around your head about one inch (2.5 cm) above your eyebrows.
2. **Use the sizing chart** to select the helmet size that corresponds most closely to your head measurement. If your head size falls between two helmet sizes, try on the larger helmet first and then the smaller size.

Size Chart

⚠ WARNING The size chart is only for reference. Always try the helmet on and follow this manual's instructions for a proper fit.

	XS	S	M	L	XL	2XL
Hat Size	6 5/8 - 6 3/4	6 7/8 - 7	7 1/8 - 7 1/4	7 3/8 - 7 1/2	7 5/8 - 7 3/4	7 7/8 - 8
Centimeter	53-54	55-56	57-58	59-60	61-62	63-64
Inch	20 7/8 - 21 1/4	21 5/8 - 22	22 1/2 - 22 7/8	23 1/4 - 23 5/8	24 - 24 3/8	24 3/4 - 25 1/4

3. **Try on the helmet** by grasping both chin straps to pull the helmet completely onto your head, ensuring that the top of your head is in contact with the top of the helmet interior.
4. **Check for a proper fit.** To make sure your helmet is the right size, check that:
 - The helmet inner lining fits snugly around your head.
 - The top pad presses firmly on your head.
 - The cheek pads contact your cheeks.
 - There is no space around your brow under the inner lining. Test this by trying to insert your fingers.

If the helmet does not fit snugly, try on a smaller size.

5. **Check your field of vision when trying on a helmet.** Some helmets may obstruct or block your vision when looking left, right, up, or down.

⚠ WARNING Always make sure you can see well enough to safely operate your motorcycle.

6. **Test the helmet fit** by placing your hands on each side of the helmet. While holding your head as motionless as possible, try rotating your helmet from left to right then up and down. If you can feel the helmet padding sliding on your head, it is too big, try a size smaller. You should feel the helmet move the skin on your head and face as you try to move the helmet.



7. **Fasten the retention system (chin strap)** as tight as possible under your jaw without causing pain. There must be no slack in the strap, and the strap must be tight up against your jaw. See page 5-6.

8. **Test the retention system (chin strap)**
 - Put your hands on the back of the helmet and try to push the helmet off by rotating it forward.
 - Put your hands on the front of the helmet above your forehead (or on the chin guard) and try to push the helmet off by rotating backward.

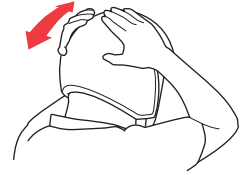

⚠ WARNING If helmet comes off or shifts over your eyes, try another size or another model or brand. You must be able to see the edge in your upper field of vision.

Repeat steps 3 through 8 until you find a helmet that fits your head snugly and securely.

▶ Specifications

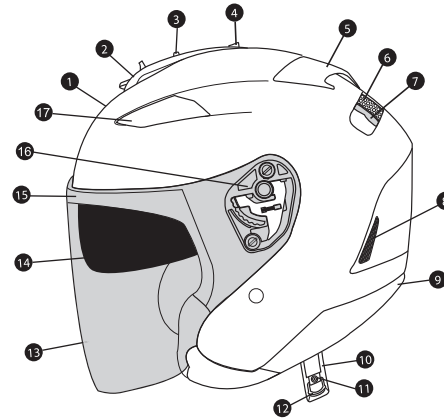

1. Outer Shell
2. Top Front Vent
3. Sun Shield Release Button
4. Sun Shield Lever
5. Rear Venturi Exhausts
6. Impact Absorbent Liner
7. Comfort Liner
8. Lower Rear Exhaust Venturi Vents
9. Rubber Edge Trim
10. Chin Strap
11. Chin Strap Snap
12. Double "D" Ring
13. Tool-less Shield
14. Sun Shield
15. Eyeport Gasket
16. Shield Ratchet
17. Top side Exhaust Vents

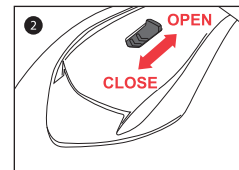

Using Your Helmet Correctly

WARNING To reduce the risk of serious injury or death and to help prevent damage to your helmet:

- **Never adjust your helmet accessories while riding** – Only make helmet adjustments when stopped.
- **Never drop your helmet** – Dropping your helmet may crack the shell or damage the protective foam. The damage may not be visible. Your helmet is only designed for ONE impact. Refer to "Helmet Replacement" (p.11) for more information on what to do after helmet has been dropped.
- **Never wear anything between your head and your helmet** – This may reduce the effectiveness of your helmet.
- **Never hang or hook your helmet on anything including mirror stalks or sissy bars** – Doing so may cause damage to the helmet protective foam or liner.
- **Never use insect repellent on or around your helmet** – Insect repellent may damage your helmet's shield, shell, protective foam, or other components.
- **Never expose helmet to gasoline or gasoline fumes** – Gasoline may damage your helmet's shield, shell, protective foam, or other components.
- **Never use a dark or tinted face shield at night or in low visibility conditions.**
 - If you have any questions on what other substances may damage your helmet, please contact us.
- **Always wear eye protection** – If you are not using a helmet with a face shield, always wear eye protection when riding. Always lock your face shield in place when you are riding.
- **Always be alert for sounds** – Your helmet may impair your hearing. However, your helmet is not a form of hearing protection.
- **Always store your helmet in its helmet bag** when not in use to help reduce accidental surface damage.

WARNING To reduce the risk of serious injury or death, always use your helmet correctly.

Inspect your helmet

To ensure that your helmet is in the best condition to maximize your protection, always inspect your helmet for damage before riding:

- **Check the shield and shield ratchet** – re-tighten shield ratchet screws if necessary. Be sure not to over-tighten any screws. Plastic base plate screws can break and plastic screws can strip the screw sleeves if over-tightened.
- **Check for helmet damage.** If your helmet is damaged or cracked, stop using it immediately. See "Helmet Replacement" (p.11) section for further information. If your helmet has been dropped, you may not be able to see the damage.
- **Check for worn or damaged parts.** Plastic components may wear out over time. If you find worn or damaged parts, replace them or purchase a new helmet. See "Replacement Parts" (p.11) for information on parts replacement.

WARNING If parts fall off while riding, your vision may be blocked which could cause an accident.

- **Check the retention system (chin strap) for damage.** If it is frayed or ripped, replace the helmet.
- **Check that the crown pad is in place.**

Check Your Face Shield

If your face shield is scratched or damaged it may reduce the visibility-replace if necessary. Always make sure you can see well enough to safely operate your motorcycle.

Fasten the Retention System

Fasten the retention system (chin strap) as tight as possible under your jaw without causing pain. There must be no slack in the strap, and the strap must be snug up against your jaw. If the retention system is not tight, your helmet may become dislodged or knocked off in an accident.

WARNING Do not rely on the snap to secure the helmet. The snap is provided only to prevent the strap from flapping in the air. Fasten the retention system only in the following manner:

Double "D" Ring

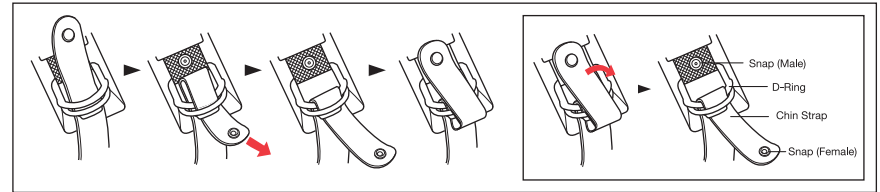

Maintaining Your Helmet Correctly

Shell Cleaning

WARNING Only use approved methods to clean the helmet. Using other unapproved chemicals or methods may damage the helmet shell or lining. A damaged helmet may increase your risk of serious injury or death in an accident.

Glossy Finish. HJC recommends cleaning your helmet with products designed for automotive cleaning and polishing. All HJC helmets are finished with an automotive type base coat/clear coat finish. Rubbing compounds can be used for deep cleaning to remove many scratches and scuffs. Follow the product's instructions diligently. Over polishing with rubbing compounds can cause light abrasions which may dull the finish of your helmet. Stickers and decals will leave adhesive residue when removed. To remove the adhesive residue, use alcohol swabs. Be certain to immediately wipe away the excess liquid and clean the area with soap and water once the adhesive residue is removed. Do not use excessive pressure while rubbing when attempting to remove the adhesive residue, instead use multiple light treatments.

Non-Glossy Finish. For our flat finish (non-glossy) helmets, we recommend using warm water and mild soap. Use multiple treatments for heavier dirt. Do not use excessive pressure or rubbing compounds while cleaning the surface as a "glossy" effect could be created, ruining the flat finish appearance.

Interior Cleaning

Although we recommend changing a helmet every 3 to 5 years, the accumulation of sweat, humidity, and dirt can deteriorate the fabric and stitching and this may cause odor. To wash HJC removable pads, HJC recommends regular machine washing and air drying. For non-removable interiors, HJC recommends using bacteria and mildew eliminating products such as "Helmet Fresh".

Vent Cleaning

Dirt and debris can find its way into the venting of your HJC helmet. Compressed air cans used for cleaning computer keyboards may be used to blow the debris from the ventilation system. It is recommended that you remove any removable pads before doing this process.

Shield Cleaning

The helmet shield is made of polycarbonate materials with a polyurethane abrasion resistance coating. It should be cleaned using a weak solution of mild soap and warm water. Never use hot water, salt water, benzene, thinner, gasoline or any other harsh agents. Treat carefully when cleaning to preserve the abrasion resistant coating. When deep scratches are visible, it is highly recommended that the helmet shield be replaced. Tinted shields are for "Day time use only" and are not suitable for use at night or in conditions of poor visibility.

Shield Removal

1. Open the shield to its maximum open position. Do not force.
2. Move the handle-locker to the open position.
3. The shield will be automatically released out of the base ratchet mechanism.

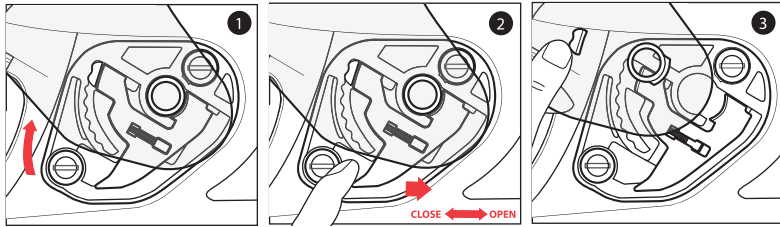

Shield Installation

1. Ensure that the handle-locker is in the open position.
2. Align and insert the top of the shield guide into the plate-gear guide.
3. With the guides properly aligned, press the lower section of the shield into the Plate-Gear mechanism. The locking tab should pop into position, locking the shield into place.

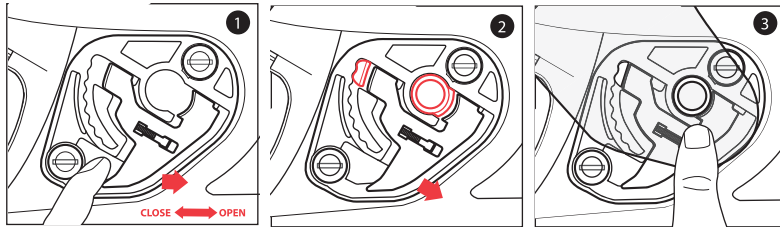

⚠ WARNING Always check to make sure helmet pads are installed before using the helmet. A helmet with missing or improperly installed pads may increase your risk of serious injury or death in an accident.

Cheek Pad Removal

There are 3 snaps holding the cheek pad in place.

1. Gently pry the cheek pad away from the interior, releasing the snaps.
2. Grasp the cheek pad near its center and gently pull it free from the chin strap.

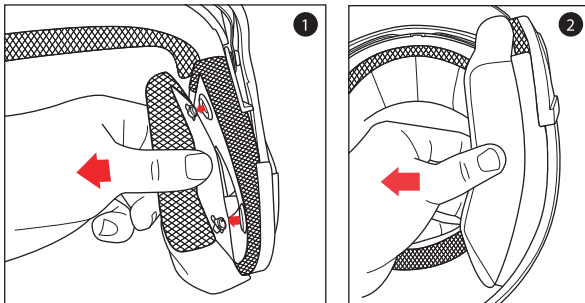

Cheek Pad Installation

1. Feed the chin strap through the opening in the cheek pad.
2. Align and fully slide the cheek pad plastic plate between shell and EPS.
3. Clip the cheek pad's 3 small male snaps to the 3 female snaps fixed on the shell interior.

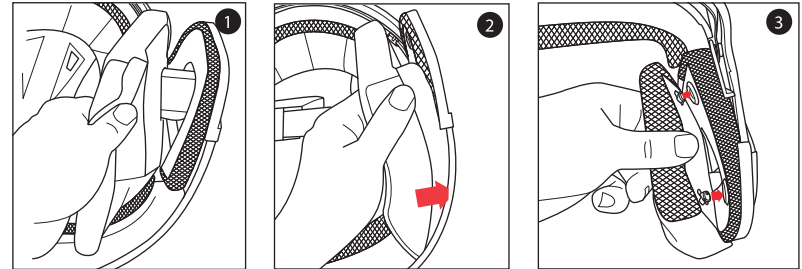

Crown Pad Removal

1. To properly remove the crown pad plastic sleeves, slightly lift the plastic shell base in the order of A, B, C and gently pull the crown pad fabric.
2. Simply pull the crown pad fabric in the rear and it will be released.

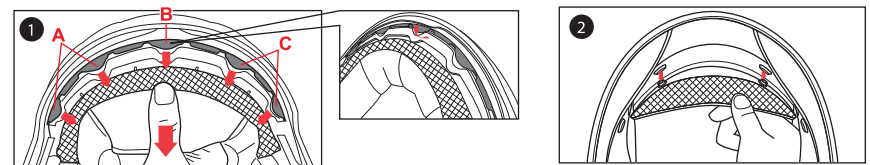

Crown Pad Installation

1. Align and insert crown pad plastic sleeves under the slot located on the crown pad's plastic base. Press the snap into place.
2. Align and snap the two rear snaps into place.

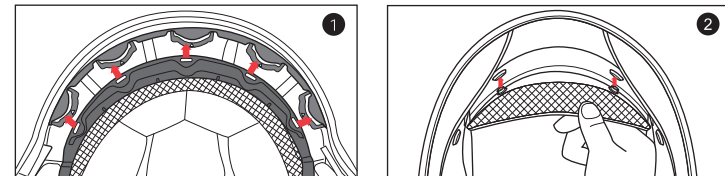



DO NOT operate the sun shield mechanism while riding as this may impair your vision and may lead to an accident.

DO NOT pull on the sun shield when it is already down. The sun shield may be ejected and this will increase the risk of serious injury or death in the event of an accident.

DO NOT attempt to adjust the sun shield with your hands. Always use the sun shield lever and the sun shield release button located at the top of the helmet.

DO NOT use sun shield at night time.

When using the sun shield, please always also use the shield in its correct lowered position.

Sun Shield Operation

There are three positions for the sun shield sliding lever.

Stage 1—Standard position: works best for leaned forward riding position-(sportbikes) and when more nose clearance is desired.

Stage 2—Lower position: works best for more upright riding position (cruisers and touring bikes).

Stage 3—Lowest position: Used primarily for sun shield removal and replacement. Release button must be held down to get to Stage 3.

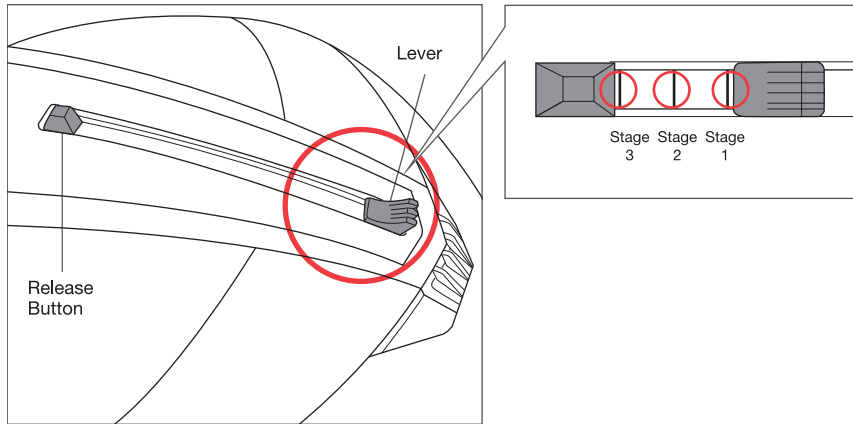

Sun shield Installation

1. While holding up the sunshield lever at the stage 3 then push down the sunshield release button. This will push out the receiver.
2. Push each side into place, aligned with the pivot tabs.
3. While holding down the sunshield release button with the sunshield lever at the stage 3, use other hand to buckle up the center portion of the sunshield.

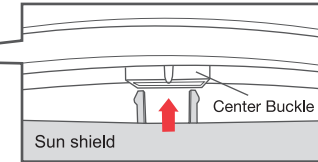
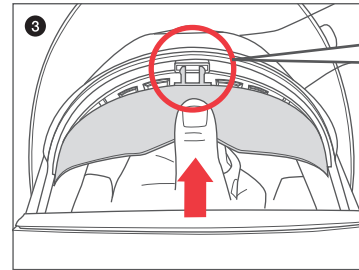
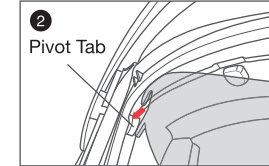
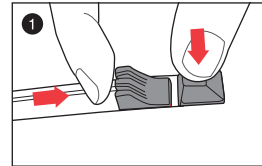

*** Make sure tabs & center buckle are secure in order for Sun shield to function properly.**

Visor Removal

1. Grab both sides of the visor and open the visor to its maximum open position.
2. Move the handle-locker to the open position and the visor will automatically release out of base ratchet mechanism. (Repeat on the other side.)

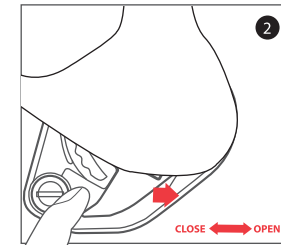
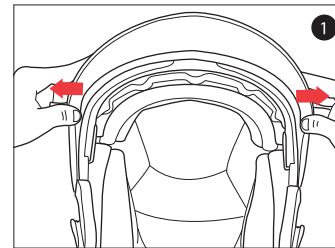

Sun Shield Removal

1. Grasp and pull the center of the sun shield by reaching inside the helmet through the bottom opening.
2. With the center portion of the sun shield released from its mount, pull the sun shield completely free from the helmet through the eye port.

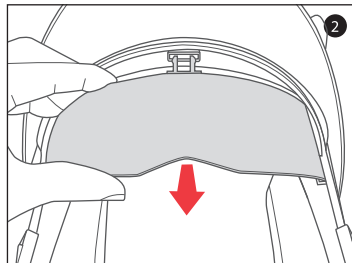
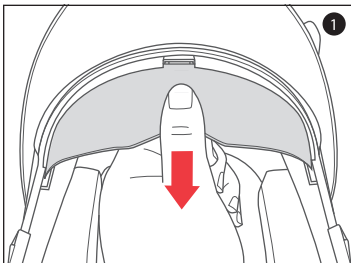

Visor Installation

1. Align the visor with the plate gear guide shown in the drawing 1.
The visor should be in open or upward position for proper alignment.
2. Press the lower section of the visor into the plate-gear mechanism.
The handle locker will lock the visor into place. (Repeat on the other side.)

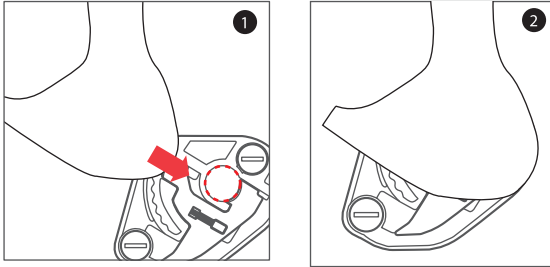

Replacement Parts

WARNING Use of replacement parts not manufactured by HJC may increase your risk of serious injury or death in an accident. Only use HJC parts that are specifically designed to work with this helmet.

Do Not Modify Your Helmet

WARNING Your HJC helmet is designed to meet DOT standards. Contact HJC America for more information about DOT standards. Modifying your helmet may increase your risk of serious injury or death in an accident. Do not modify your HJC helmet. Modifications include the following:

- drilling holes;
- cutting shell, liner, or strap;
- modifying the retention system, including adding a chin cup;
- removing parts;
- painting; and
- attaching accessories that are not manufactured by HJC for this helmet.

If you have questions about modifications, please contact HJC America, Inc. See back cover for contact information.

Storing Your Helmet Correctly

WARNING An improperly stored helmet can become damaged and may increase your risk of serious injury or death in an accident. You should:

- Store helmet in a cool and dry place,
- Keep helmet away from pets and other animals,
- Keep helmet away from heat in excess of 122°F and do not set on or near hot surfaces.
- When helmets left out in the sun for extended periods of time, it may fade overtime.

Helmet Replacement

WARNING Although your HJC Helmet is constructed with the best materials available to offer a long-lasting product, it will eventually need to be replaced. Immediately replace your helmet if:

- It has suffered an impact. Your helmet is only designed for ONE impact. An impact may fracture the outer shell or compress the impact absorbing liner. You may not be able to detect this damage. Any impact in a crash or a drop from as low as 4 feet is enough to damage your helmet.
- The shell, lining, or retention system is damaged. The helmet shell, the impact absorbing lining, and the retention system must be in good condition to provide you with the most protection.

Even if your helmet has not been damaged, it needs to be replaced every 3 to 5 years depending on how much you use it. Over time, UV rays and adhesive and component aging will damage your helmet. Wearing a damaged helmet may increase your risk of serious injury or death in an accident.

If you are unsure if you need to replace your helmet, contact HJC America before using your helmet again.

Helmet Disposal

WARNING If you buy a new helmet, destroy the old one to ensure it cannot be reused. Do not sell or give away your old helmet, even if it has not been damaged. Over time the protective foam in the helmet will adjust to the contours of your head. If someone else uses this helmet it will not provide them with as much protection.

Warranty

HJC hereby extends a limited warranty to the purchaser of a HJC helmet that the helmet is free of defects in materials and workmanship.

Coverage

This warranty is applicable to manufacturer's defects only and is good up to one year from the date of purchase. It does not apply to any problems arising out of wearer's misuse, negligence, modifications, accidents, etc.

Disclaimer

Any warranty of merchantability and any implied warranty are hereby expressly disclaimed. In addition, HJC shall not be liable for any consequential damages.

Procedure

In order to receive warranty, please take your helmet, your receipt showing the date of purchase, and a brief memo that includes a description of the problem, your name, and phone number to the authorized HJC dealer from which you purchased your helmet.