

42350

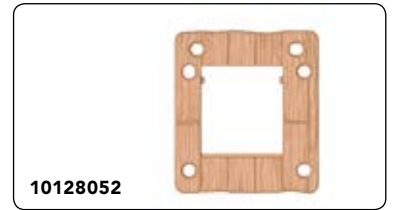

1

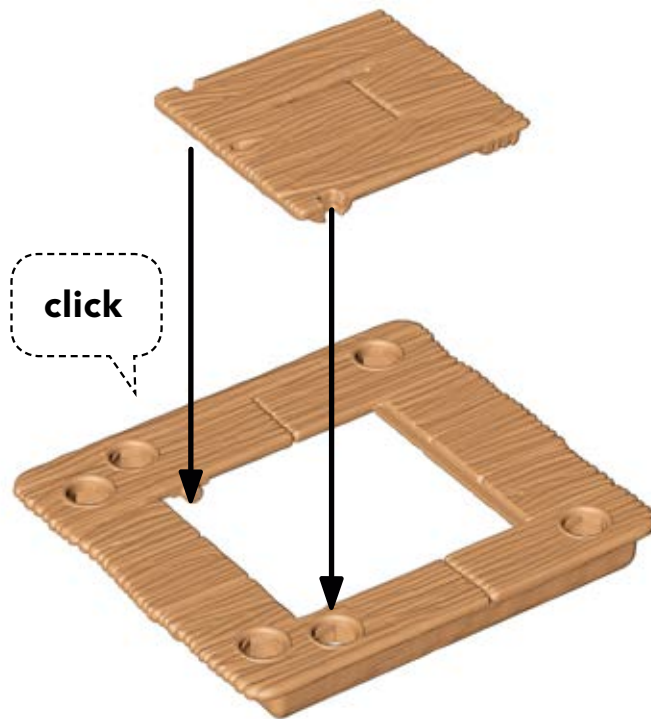

2

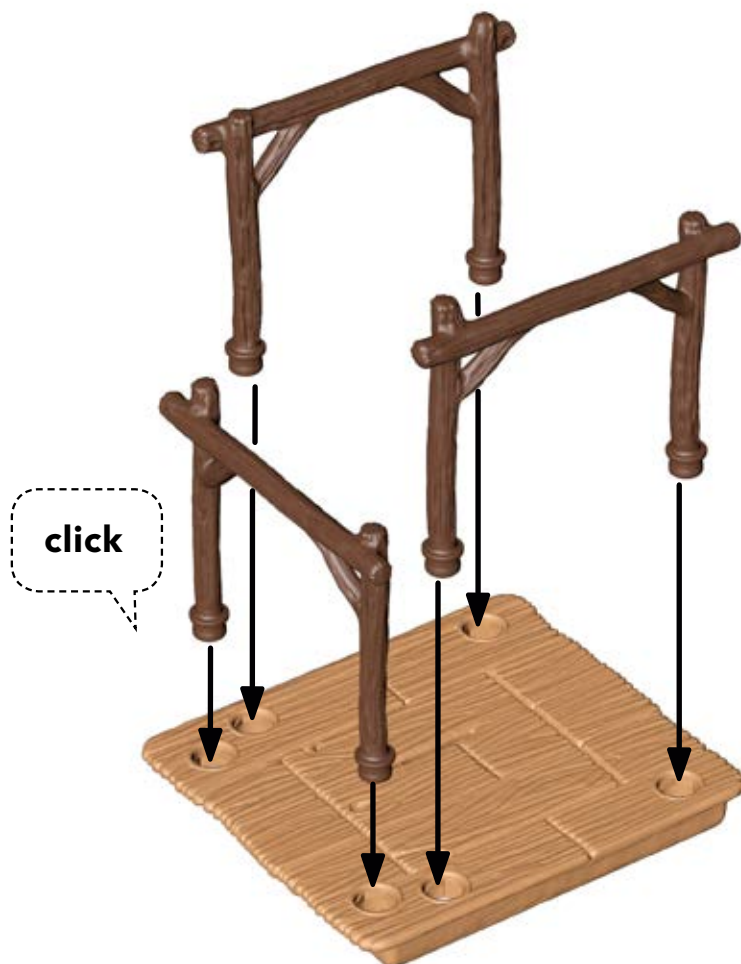

3



10128667

4

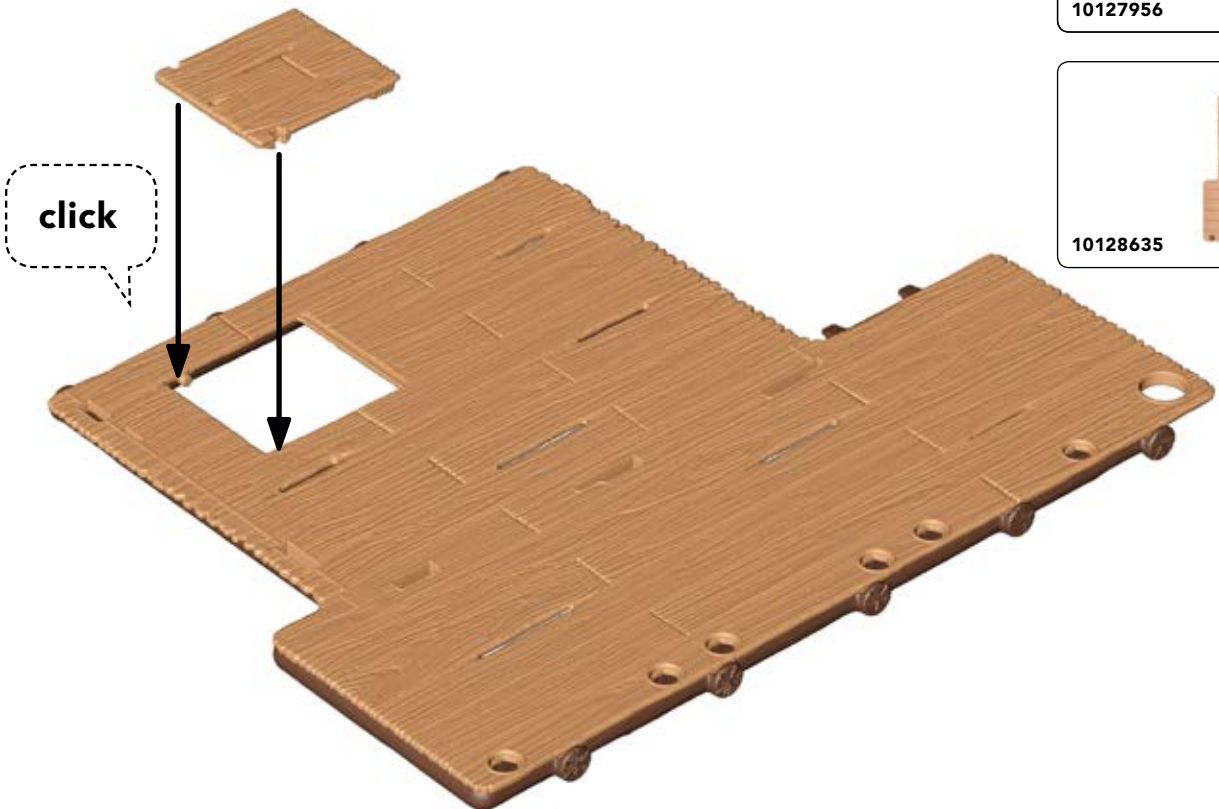

10127956



10128635

5

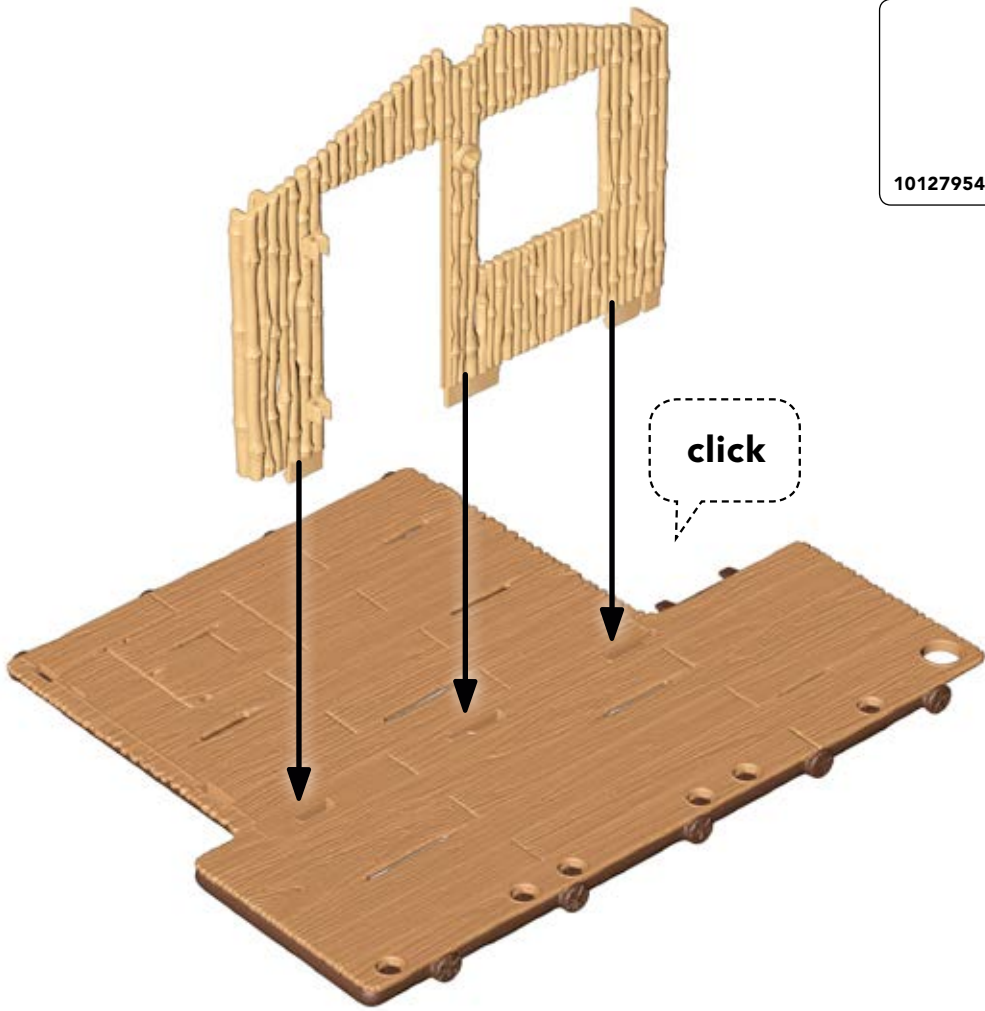

10127954

6

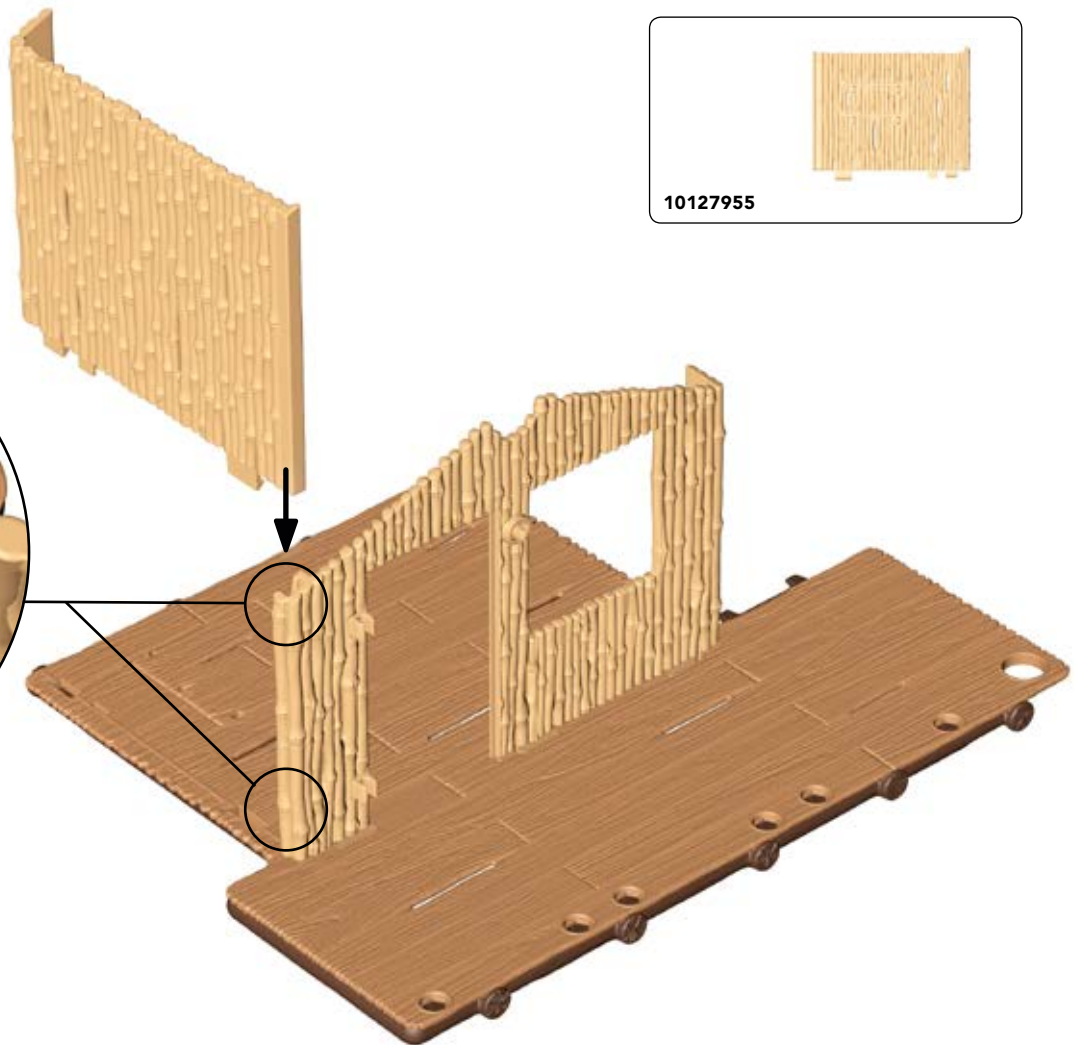

10127955

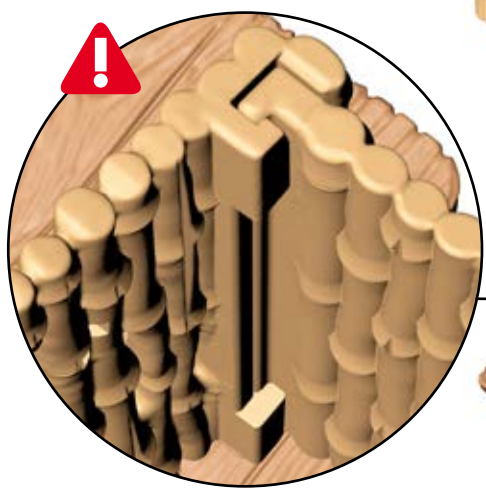

7

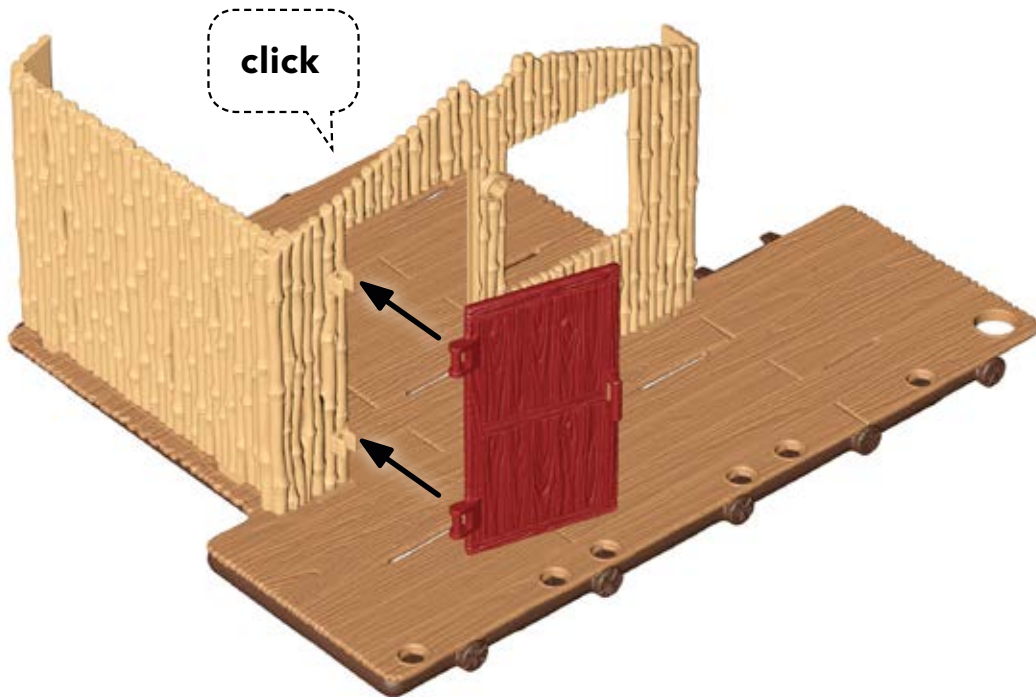

8

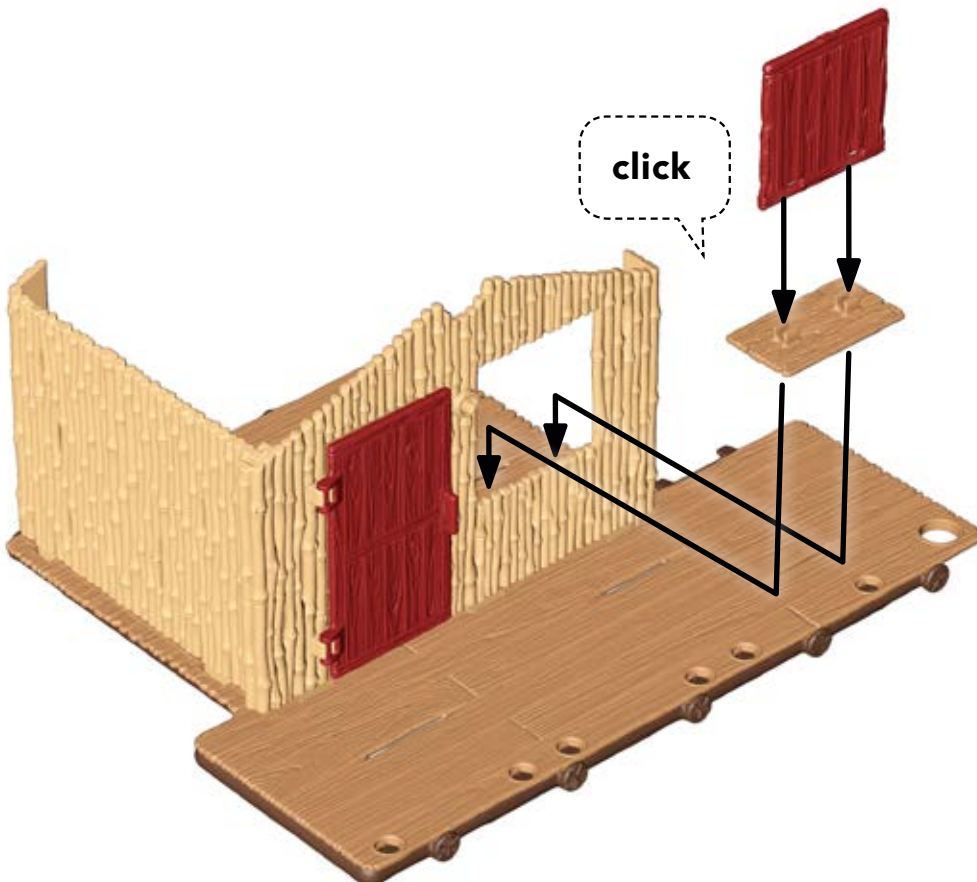

9

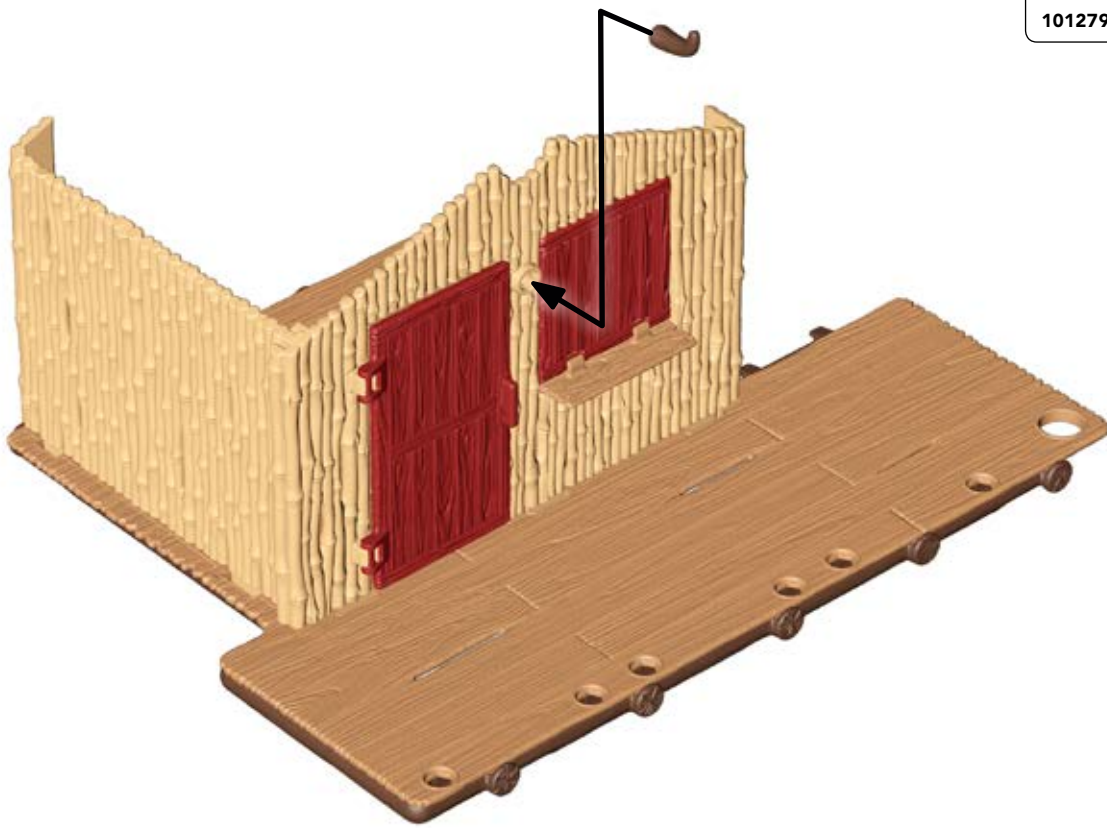
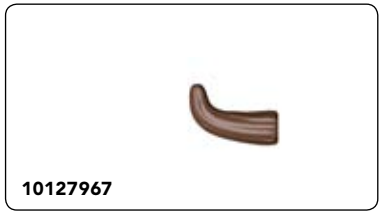

10

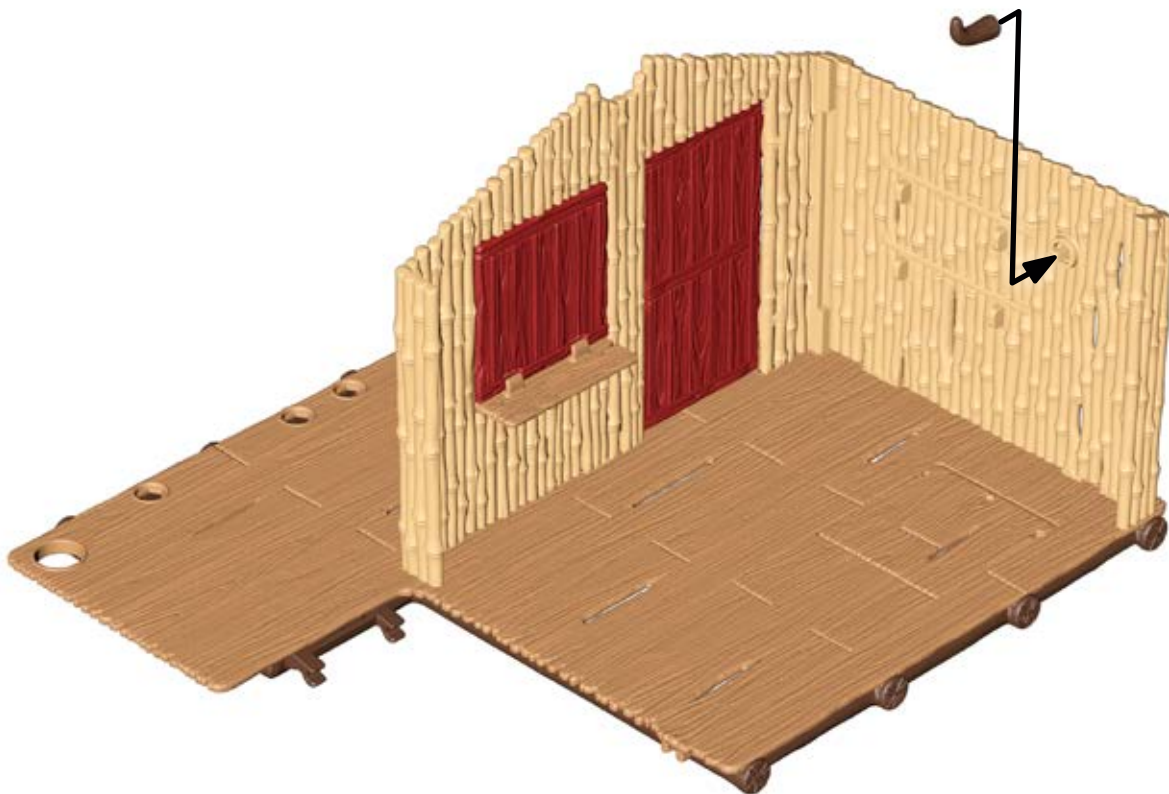

11

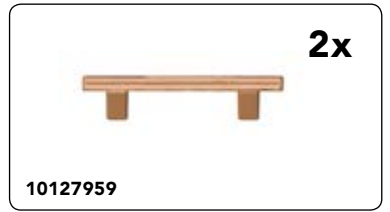
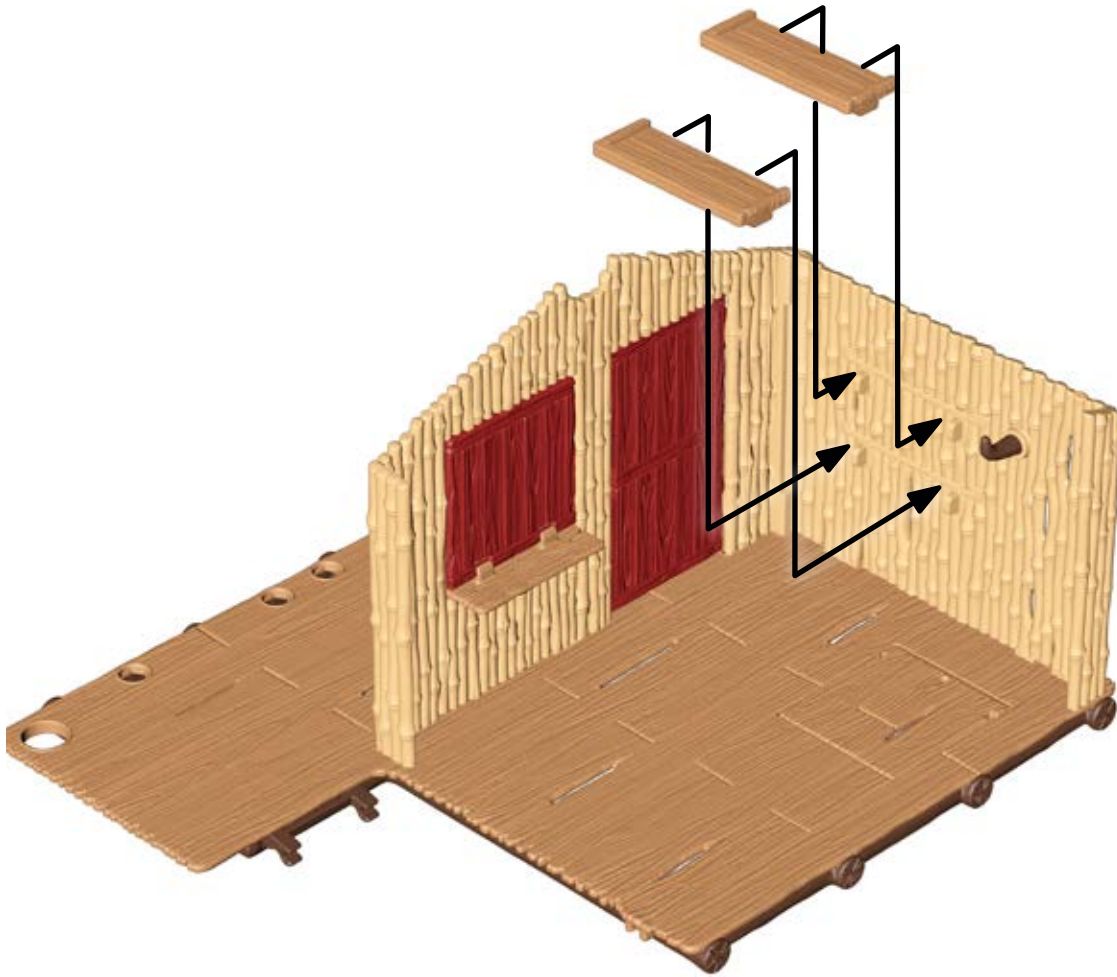

12

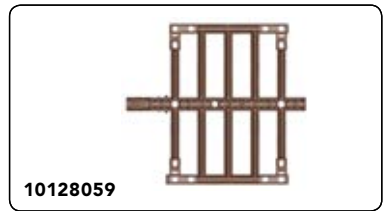

13

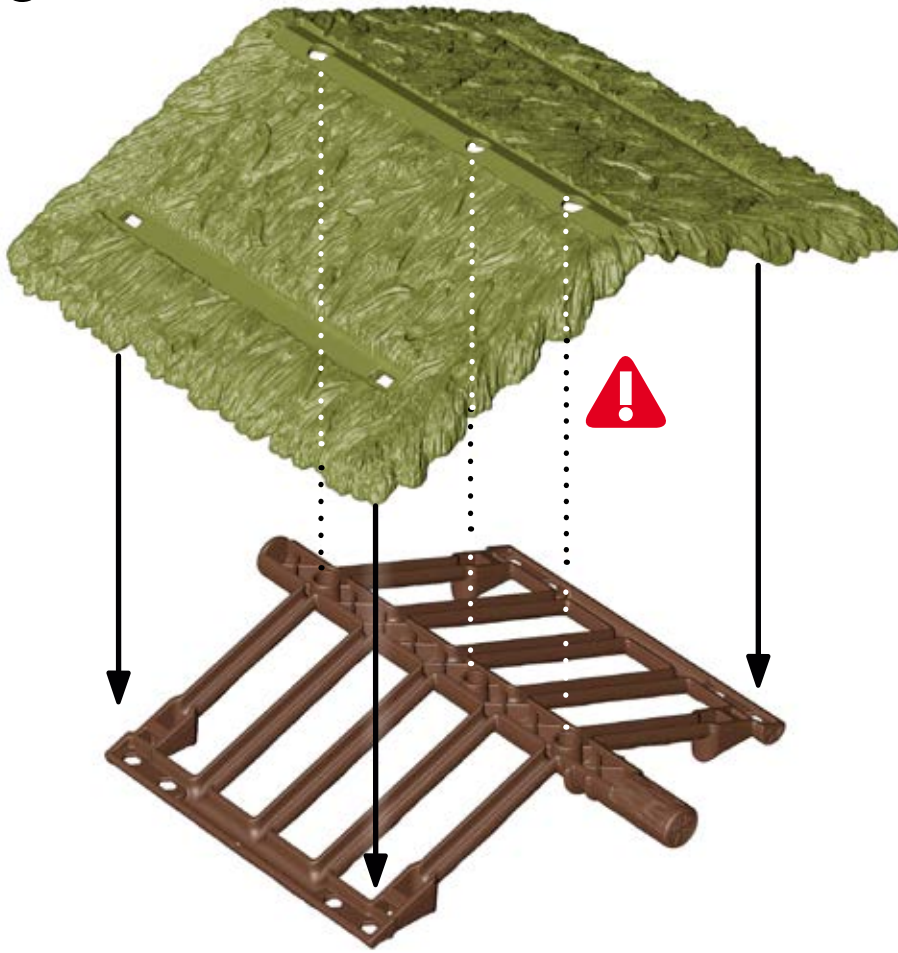

10128058



14

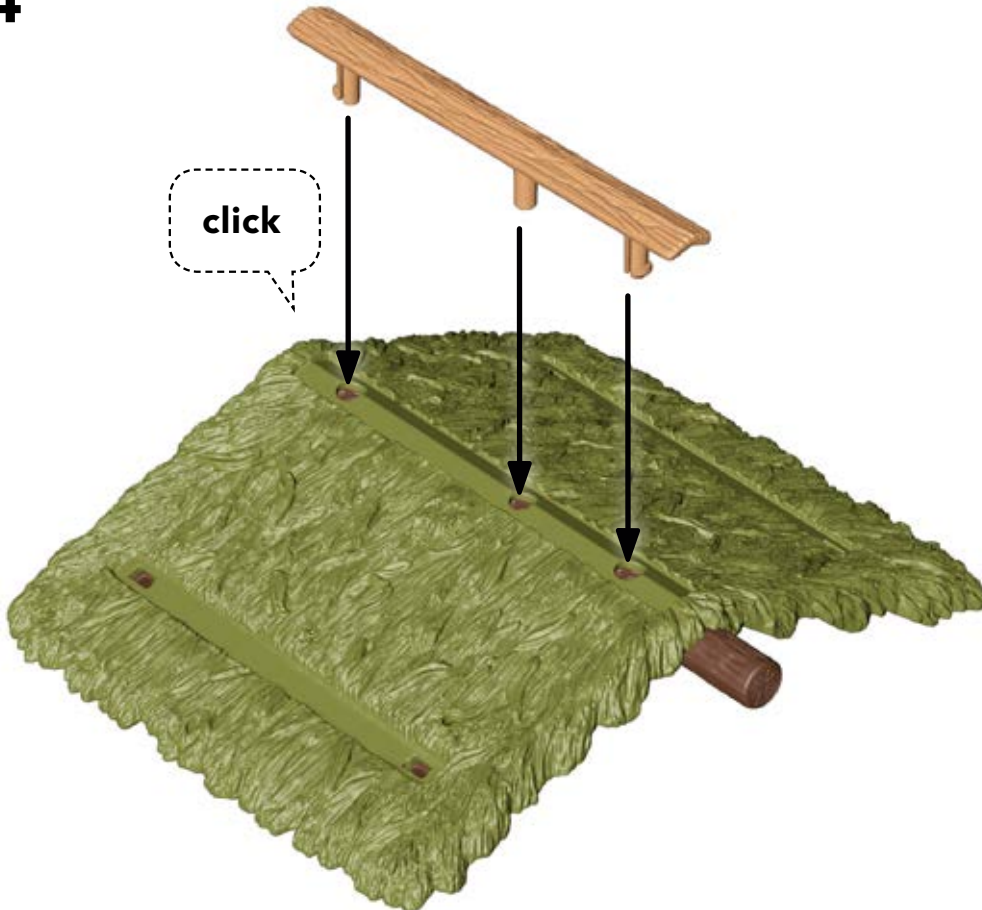

10128063



15

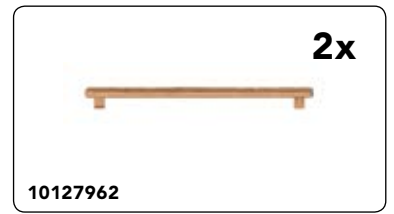
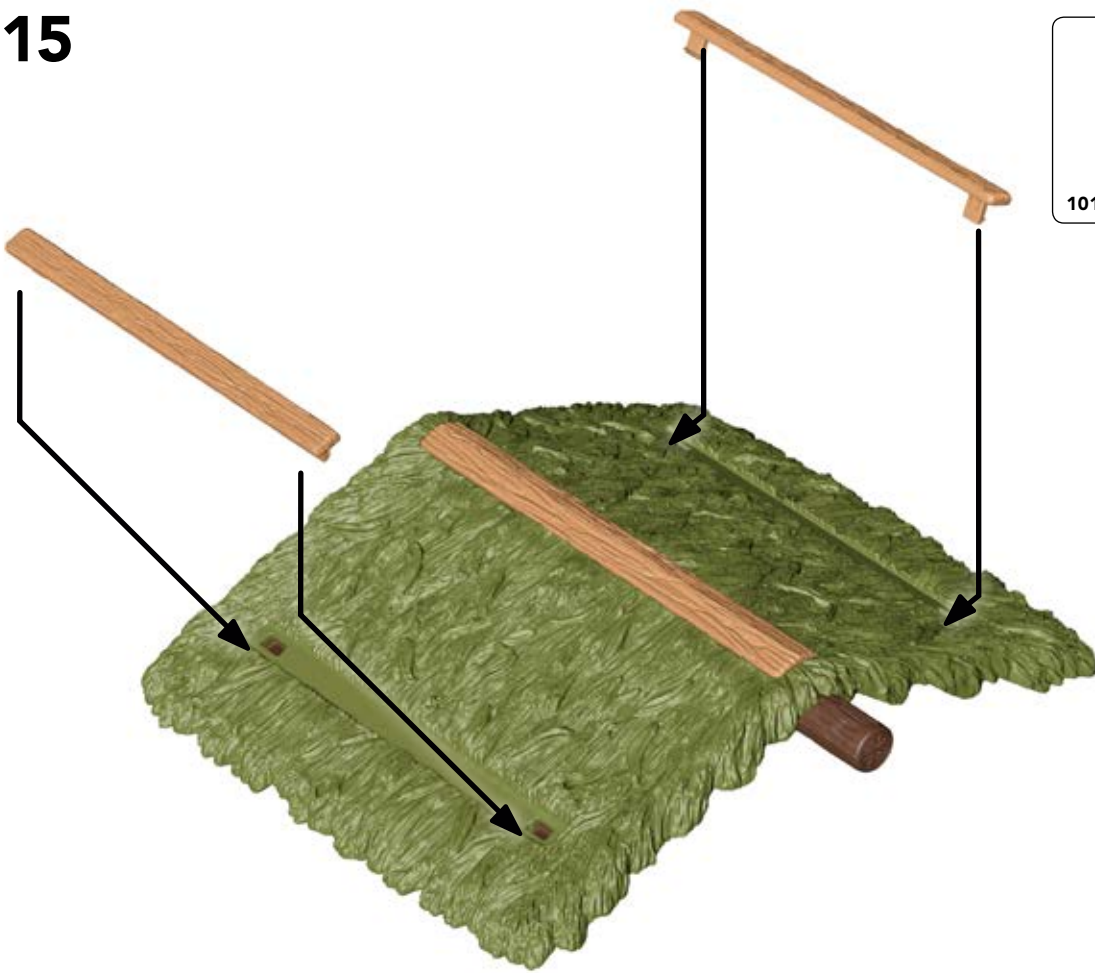

16

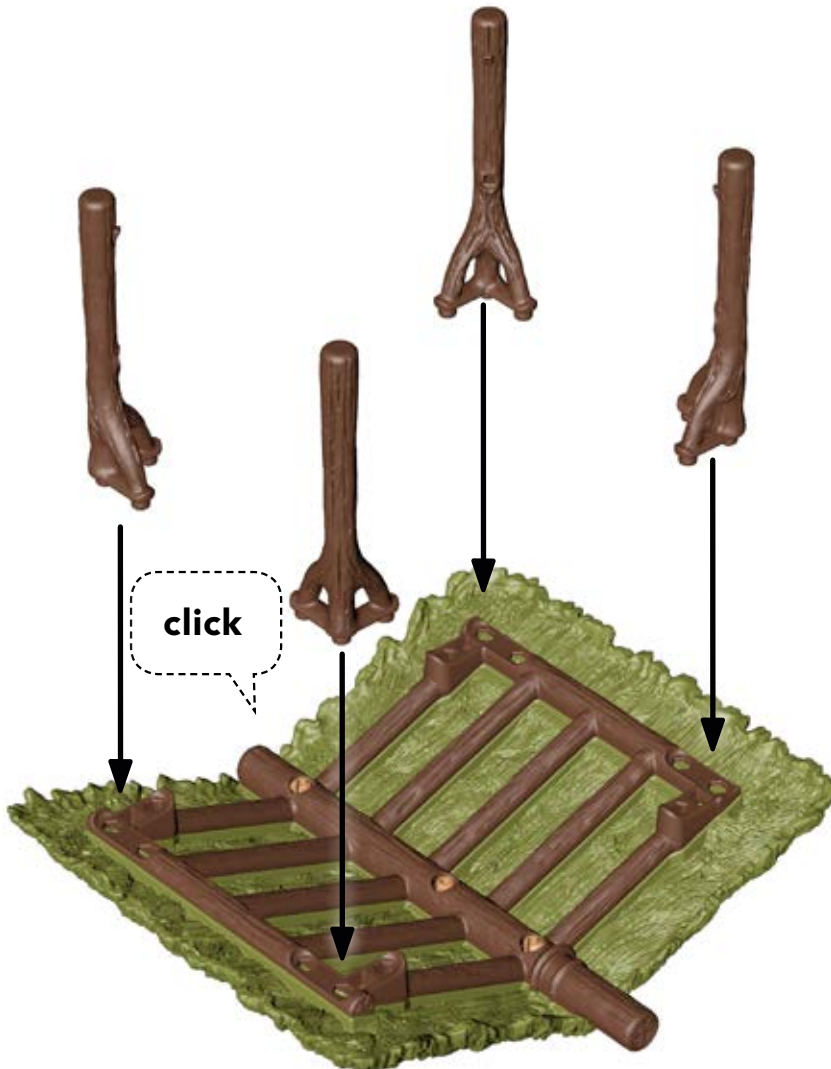

17

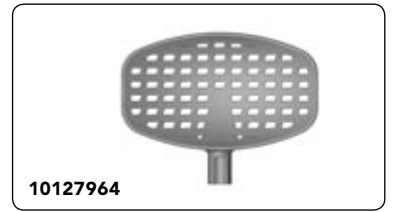

18

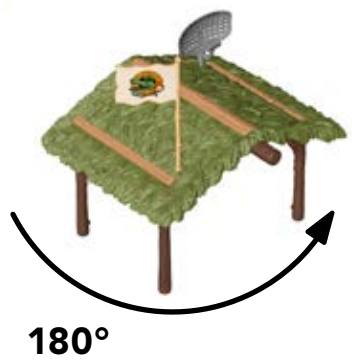

19



20

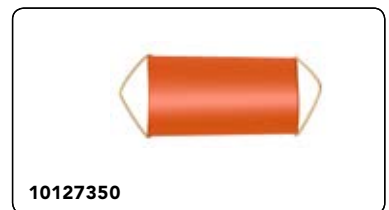

21

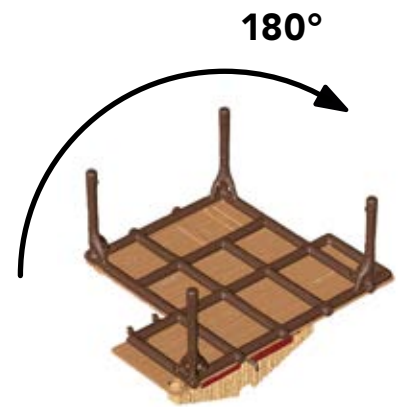
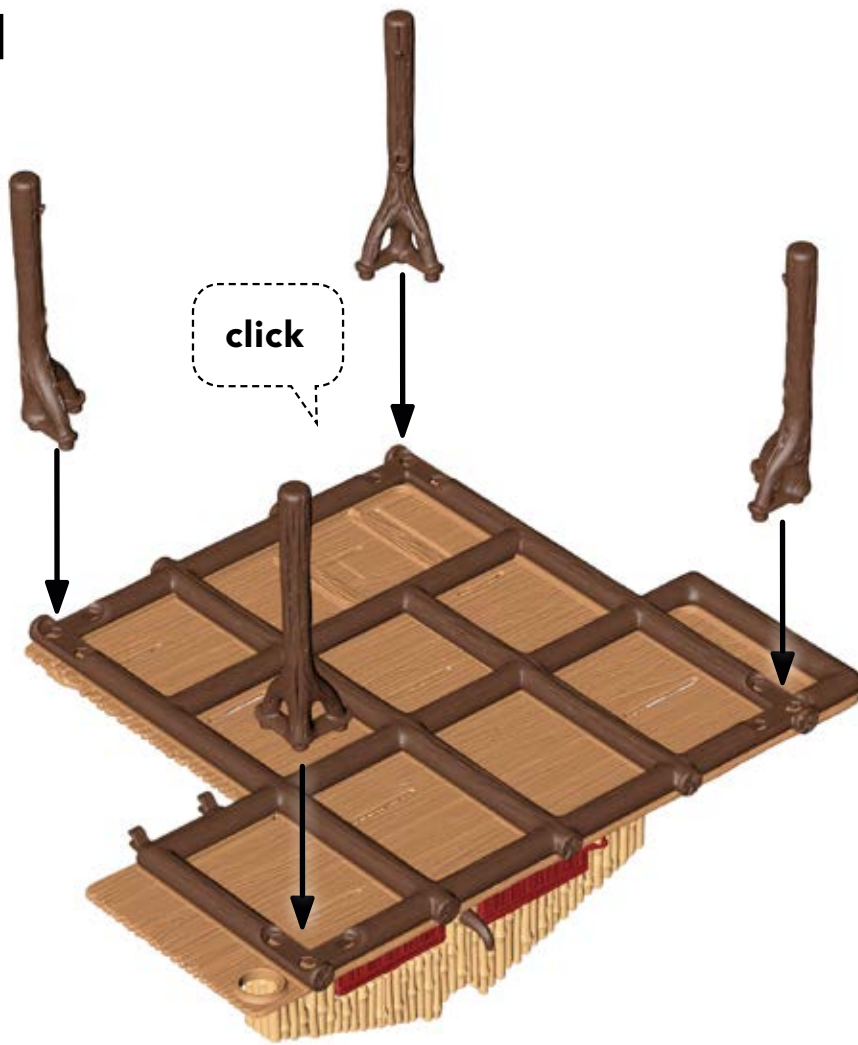

22

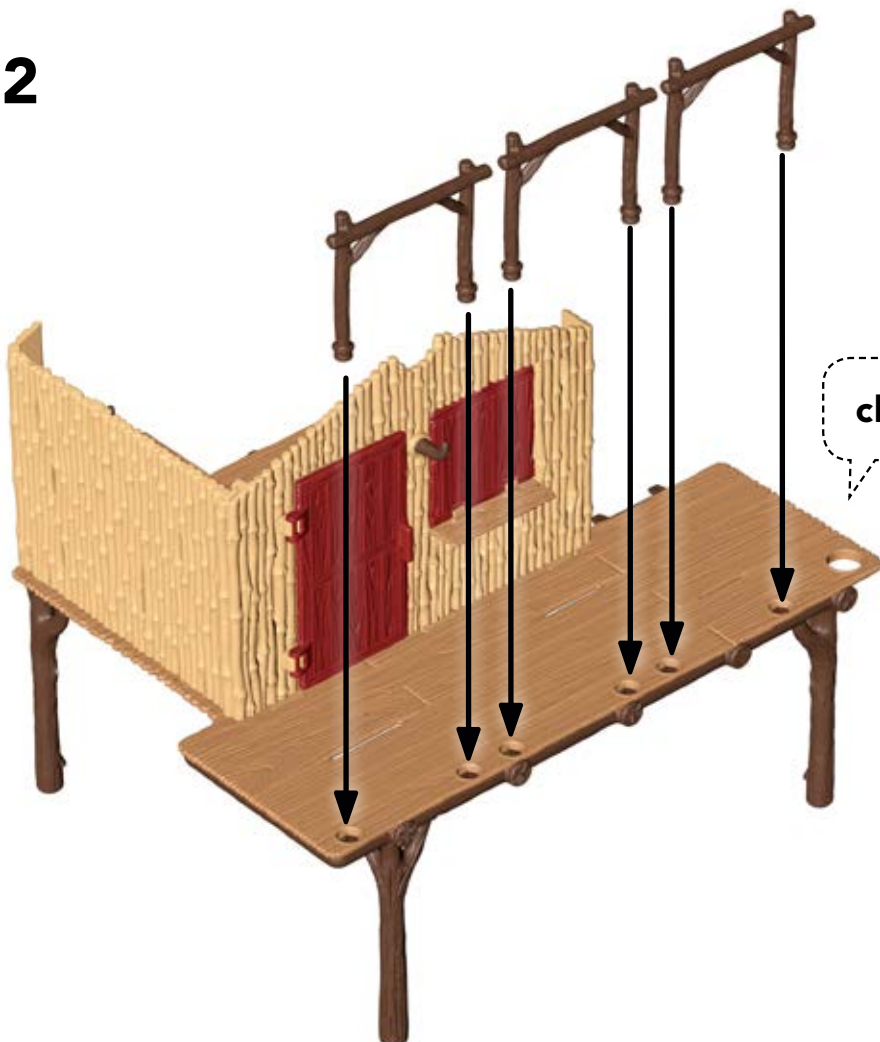

23

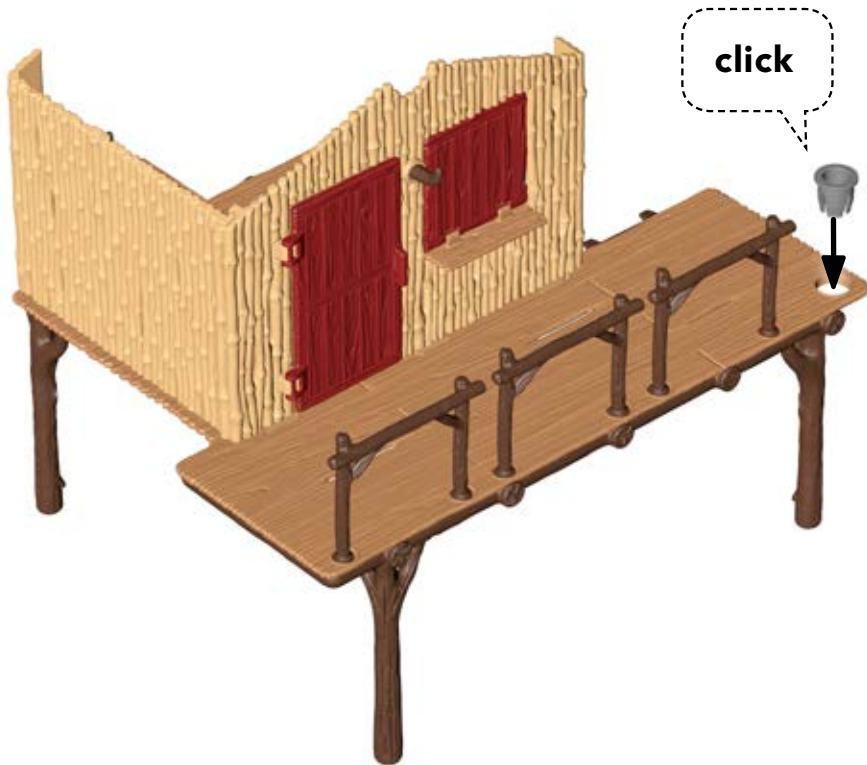

24

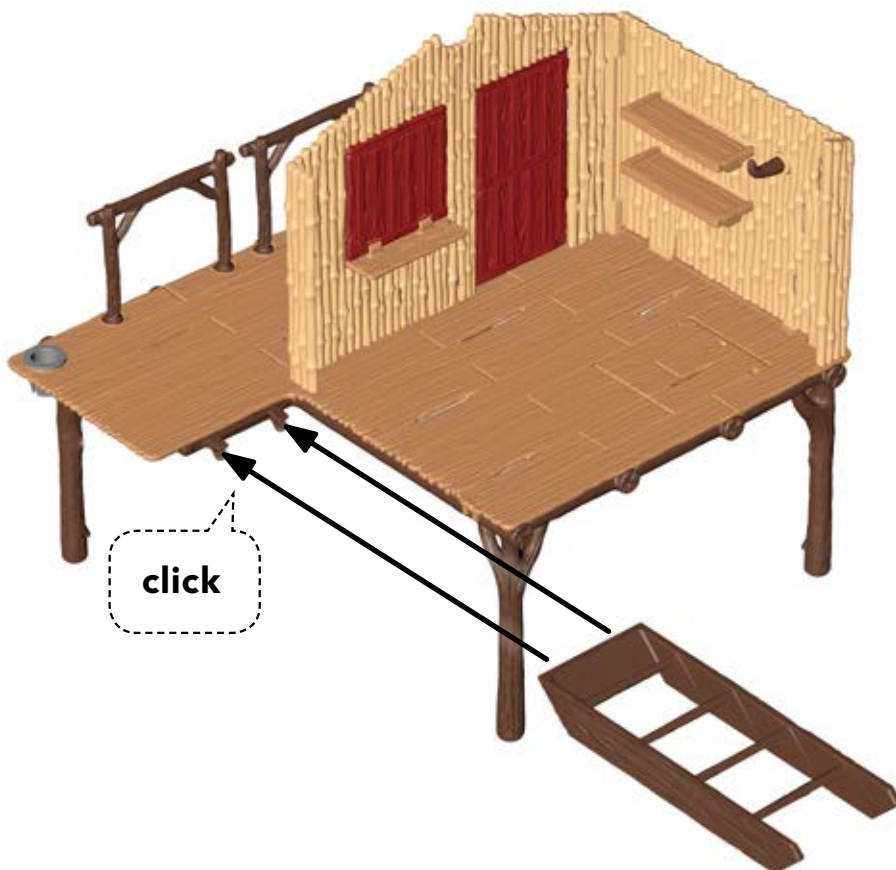

25

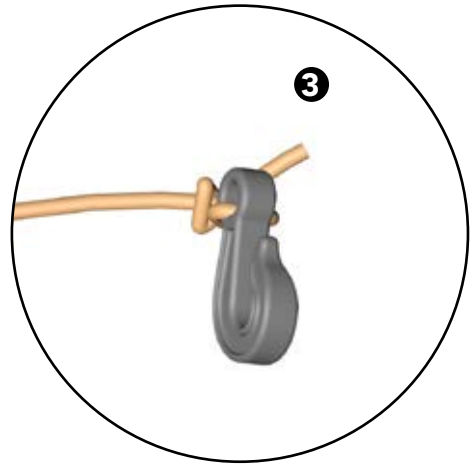
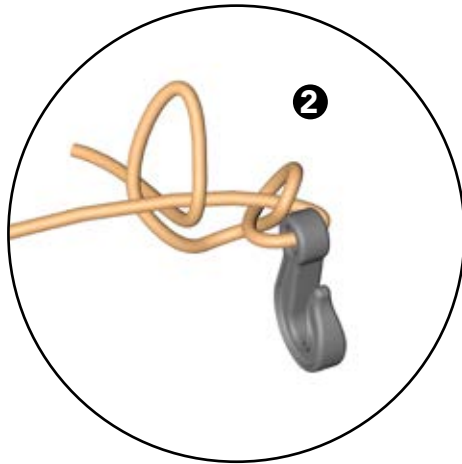
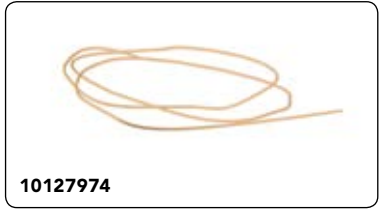
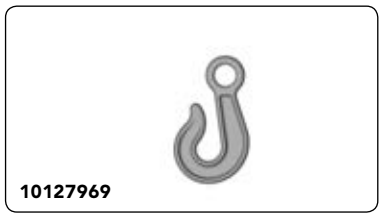

26

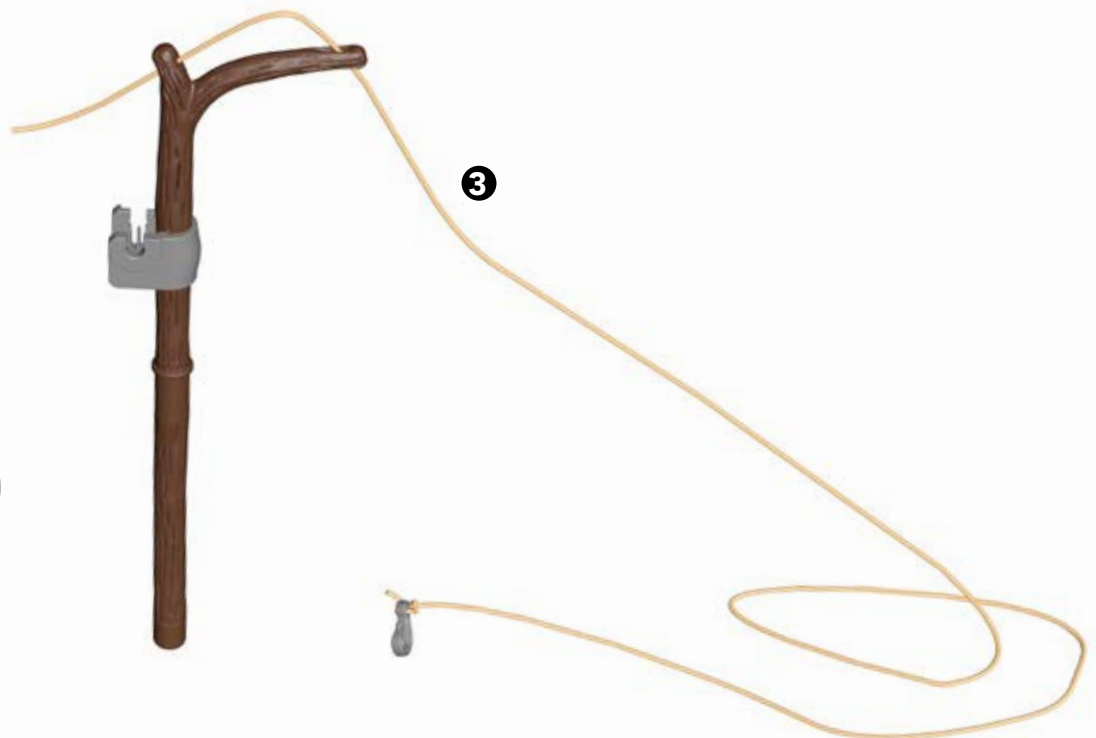
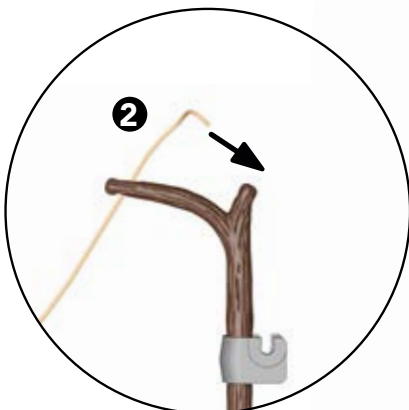
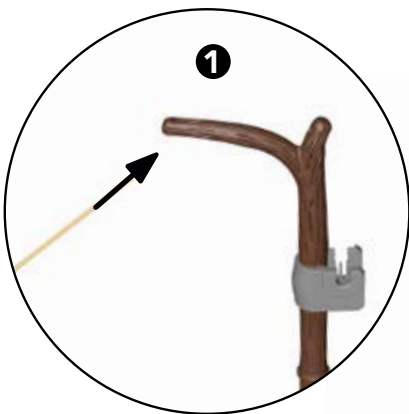

27

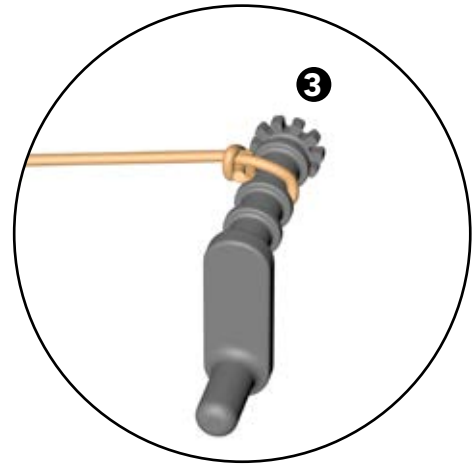
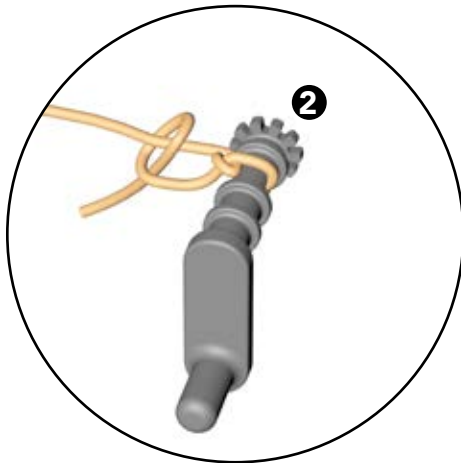
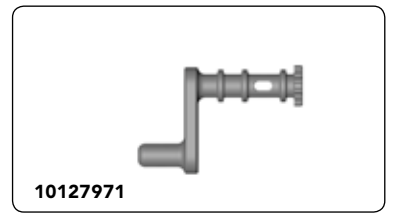
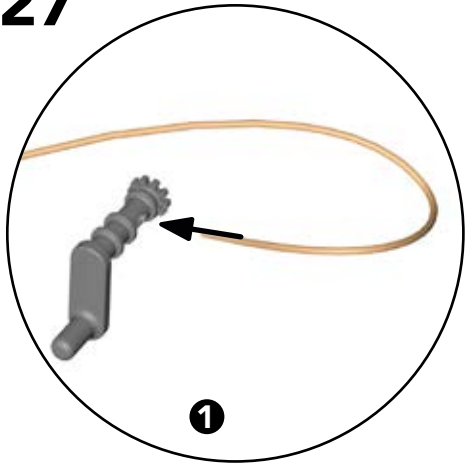

28

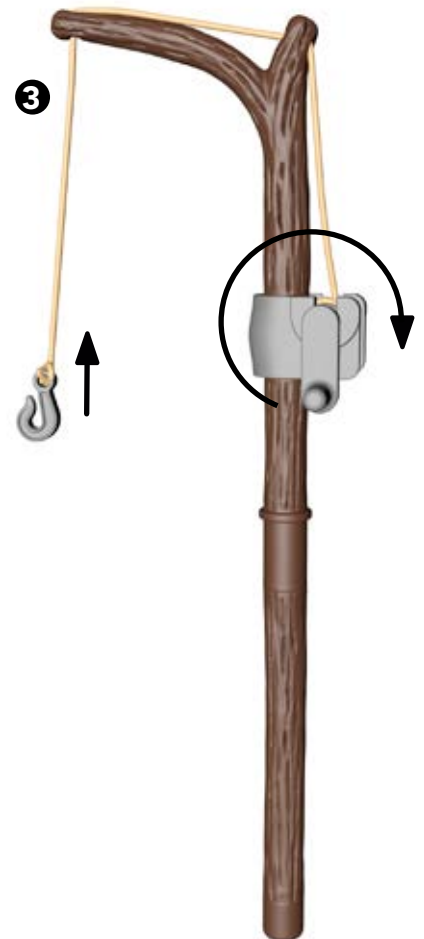
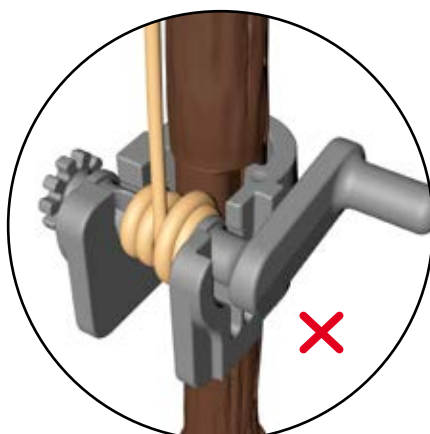
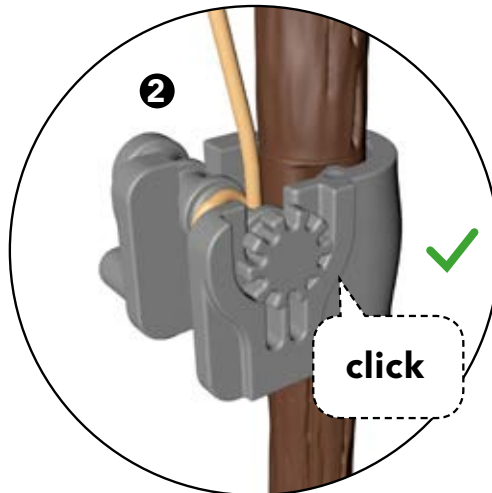
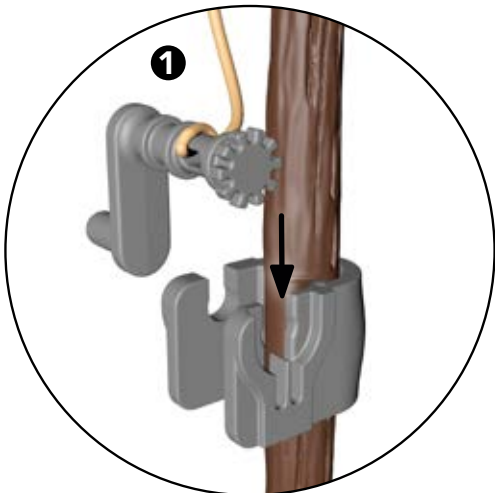

29

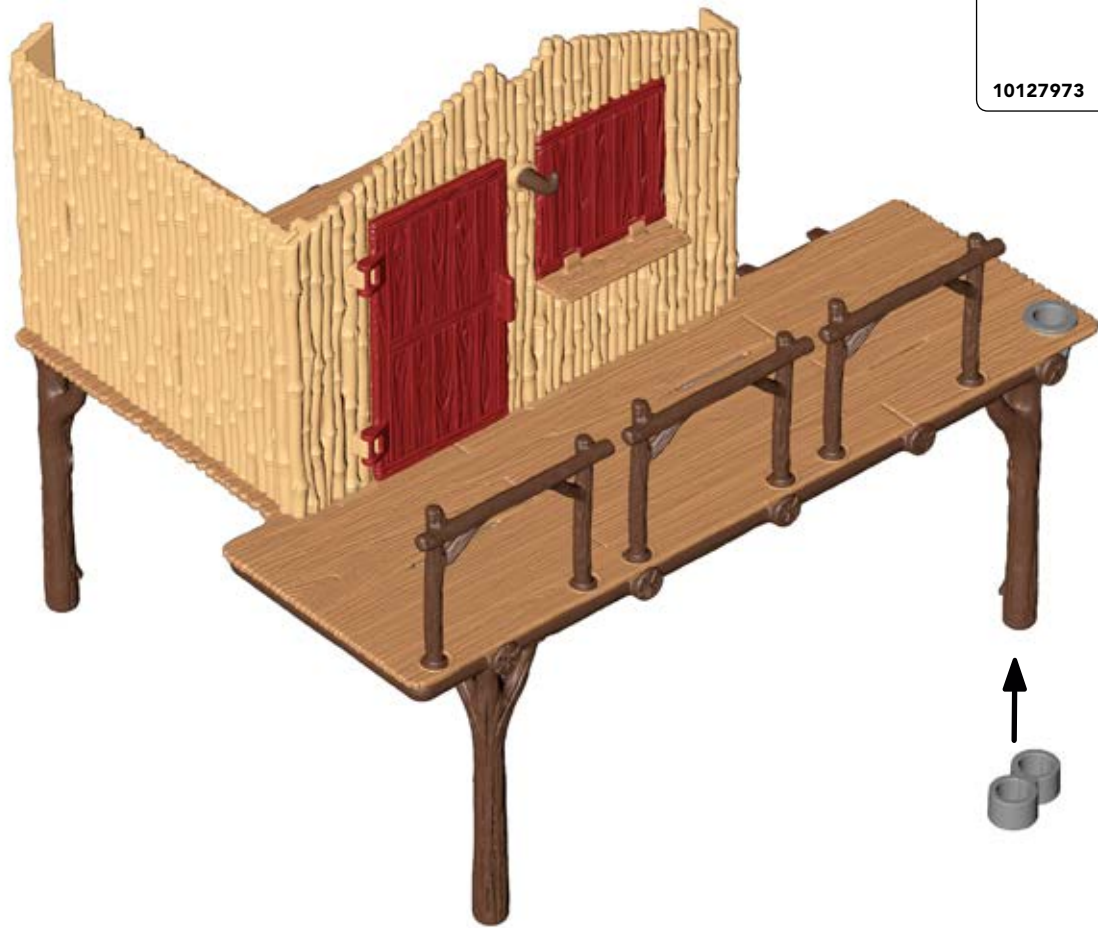

30

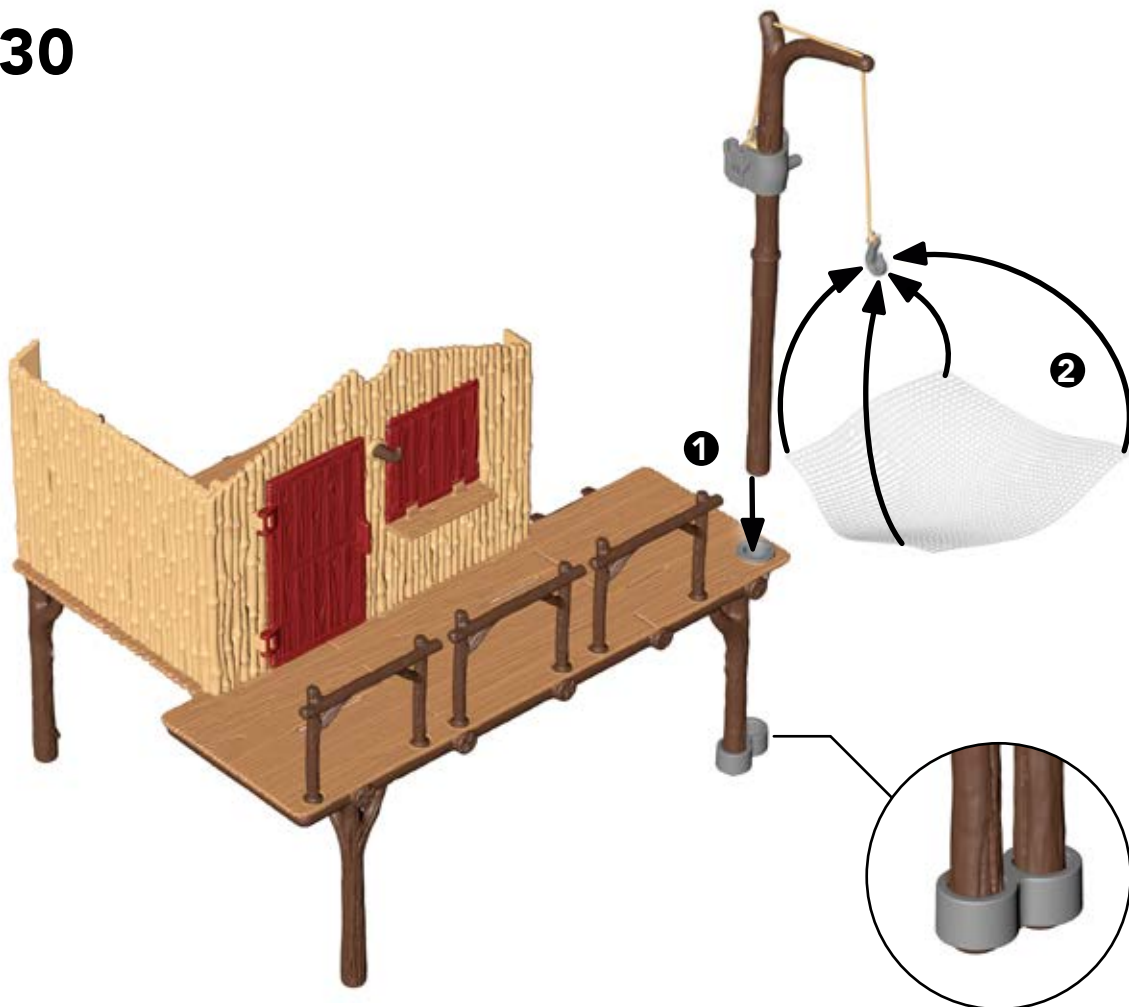

31



32

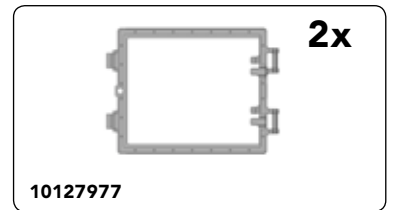
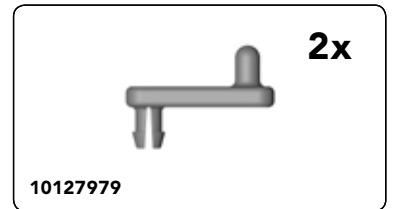
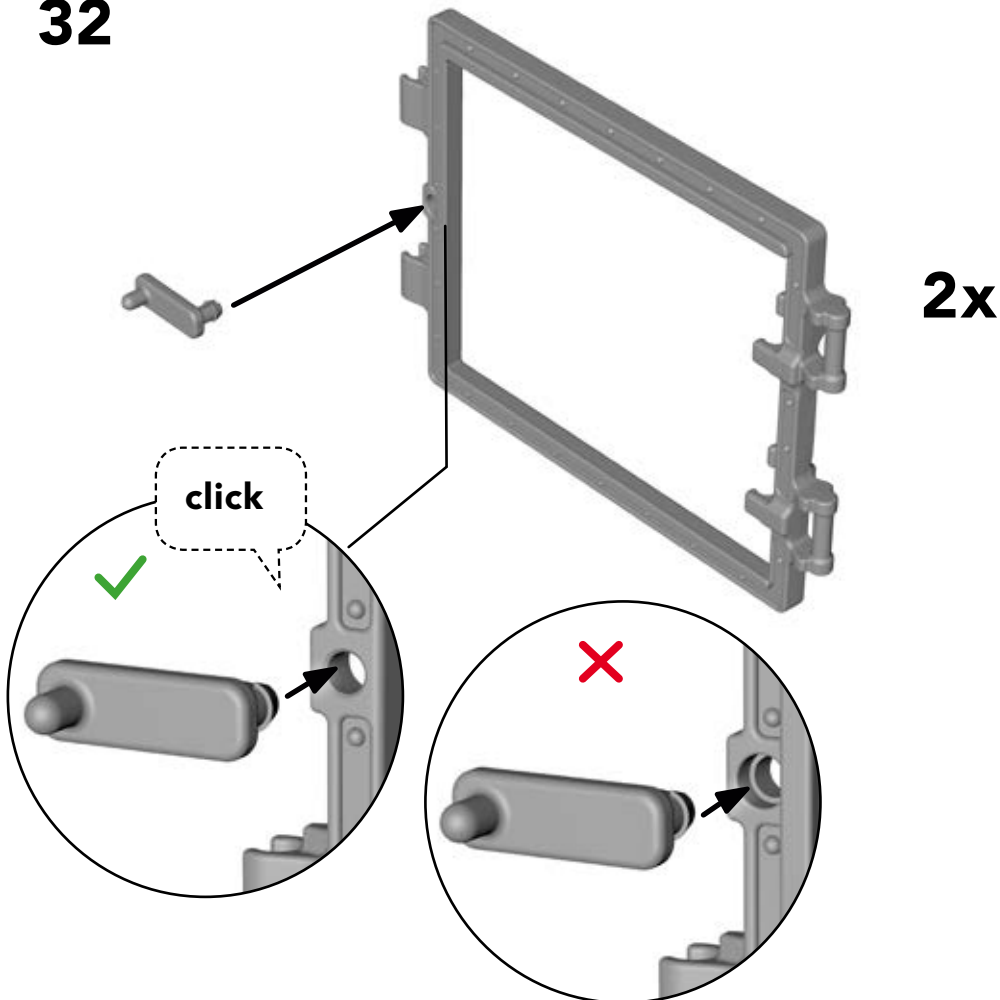

33

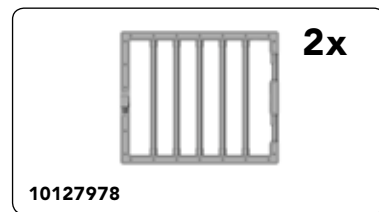

2x

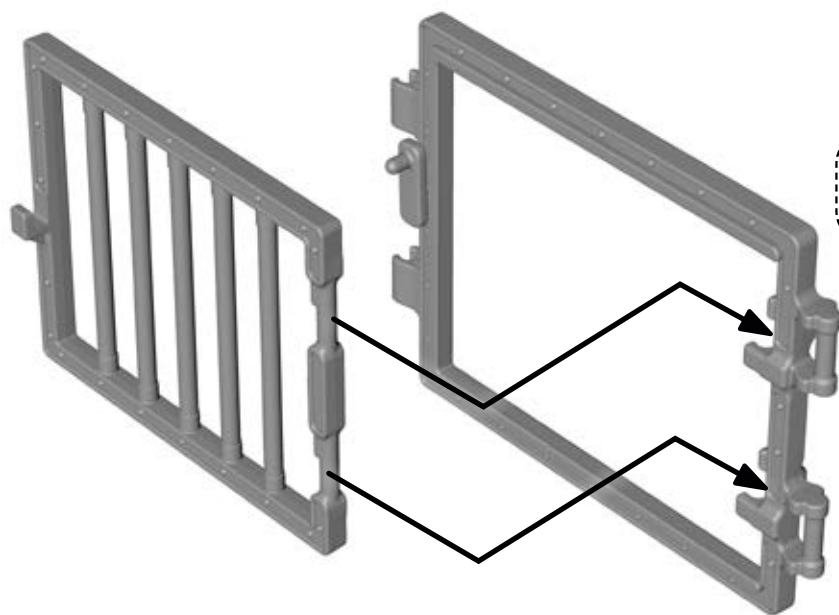

click

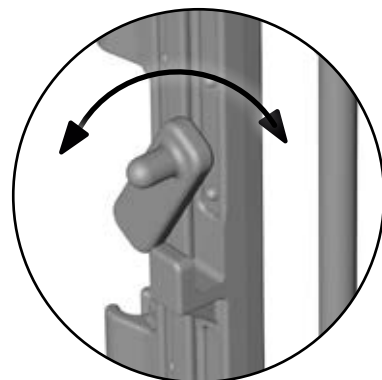

34

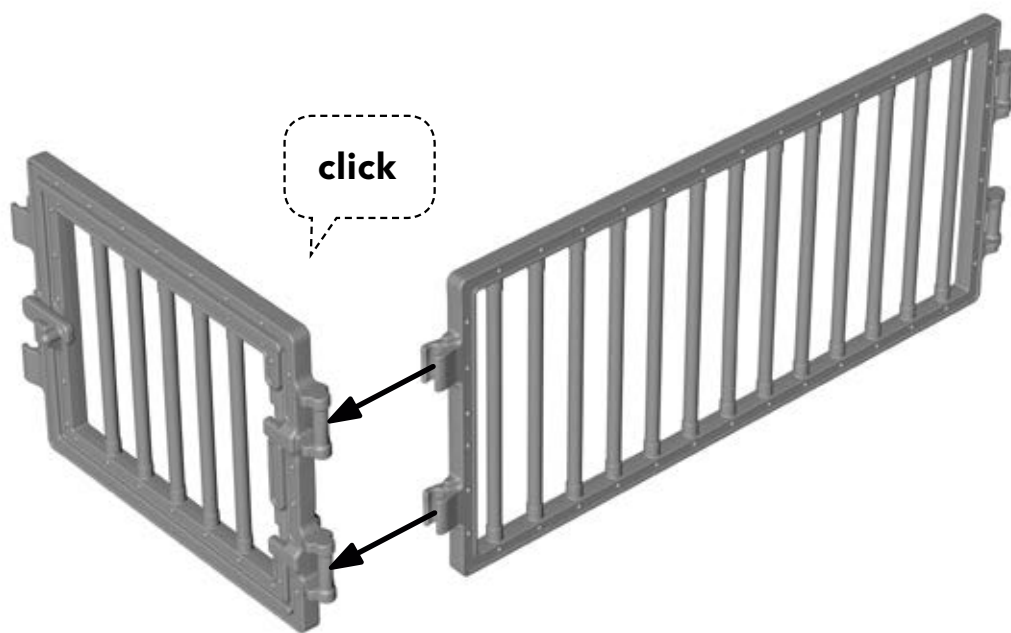
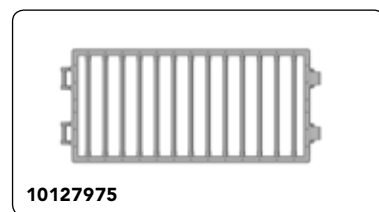

click

35

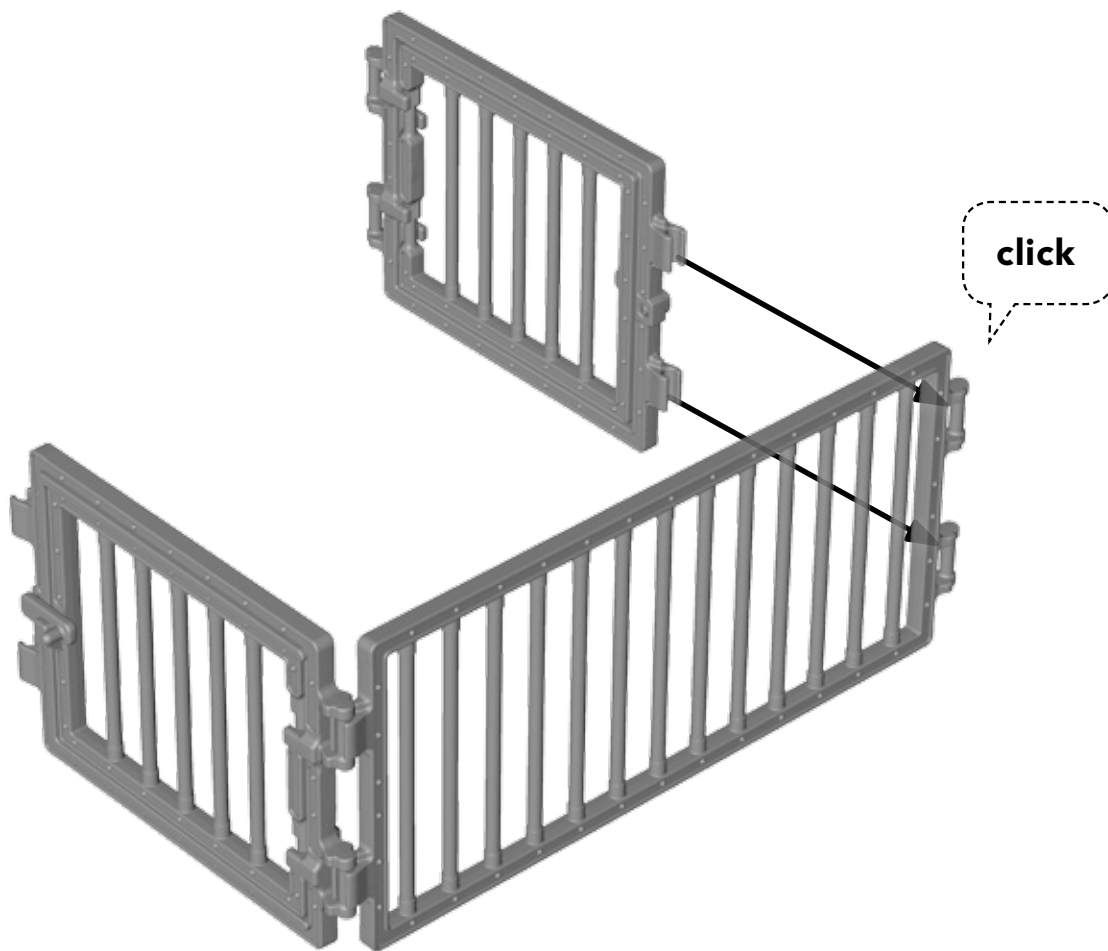

36

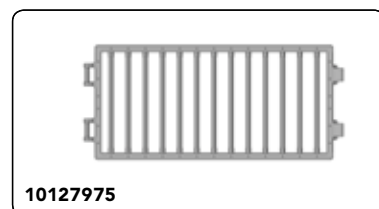
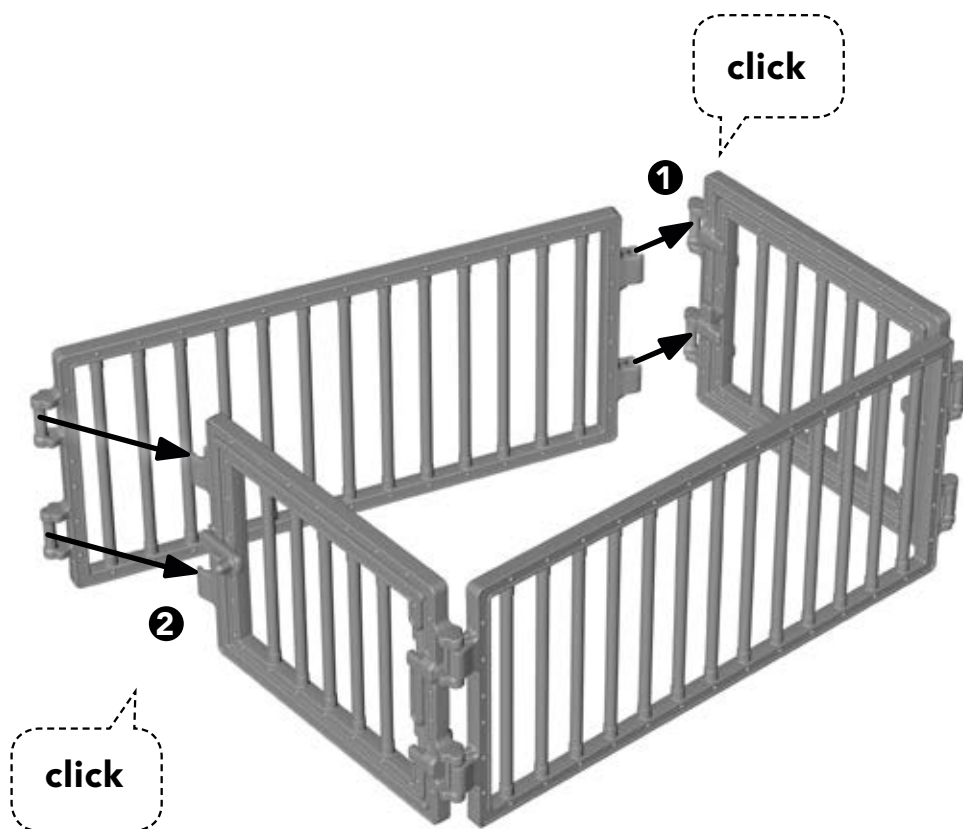

37

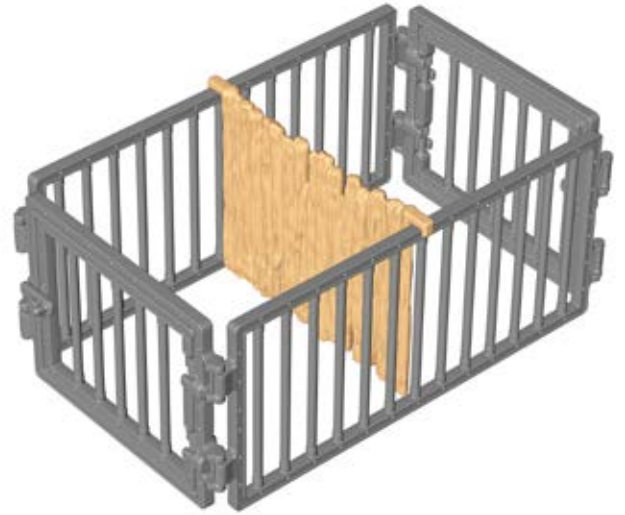
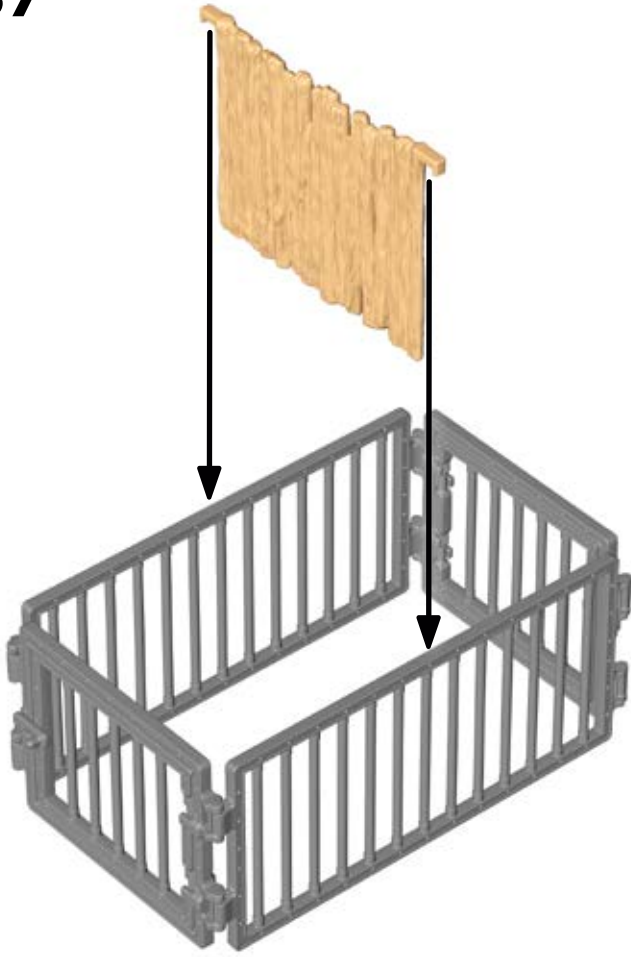

38

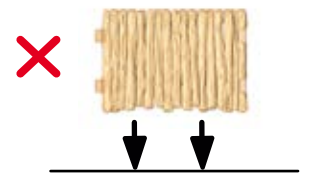
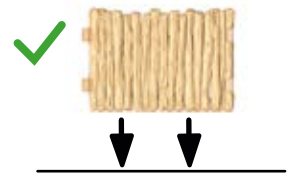
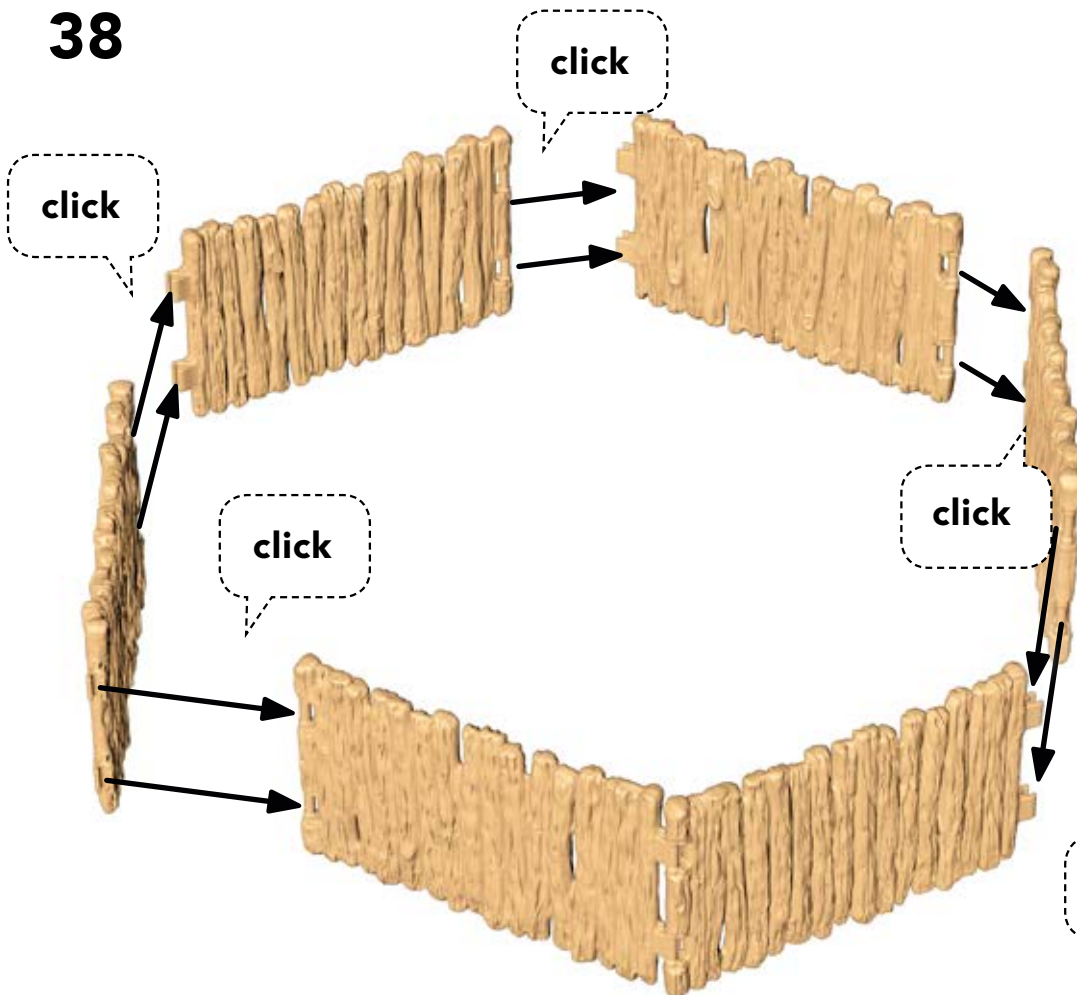

39

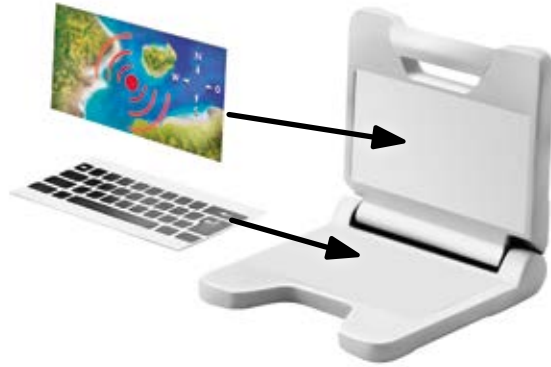
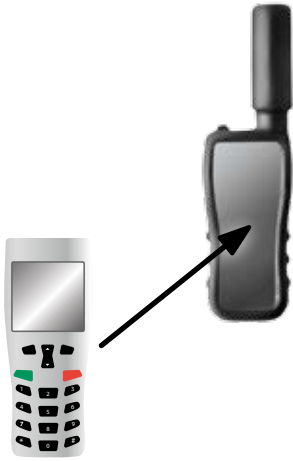

40

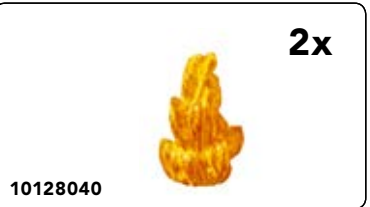
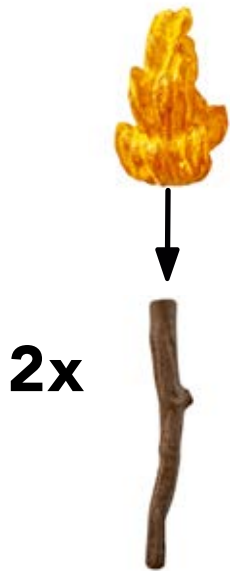

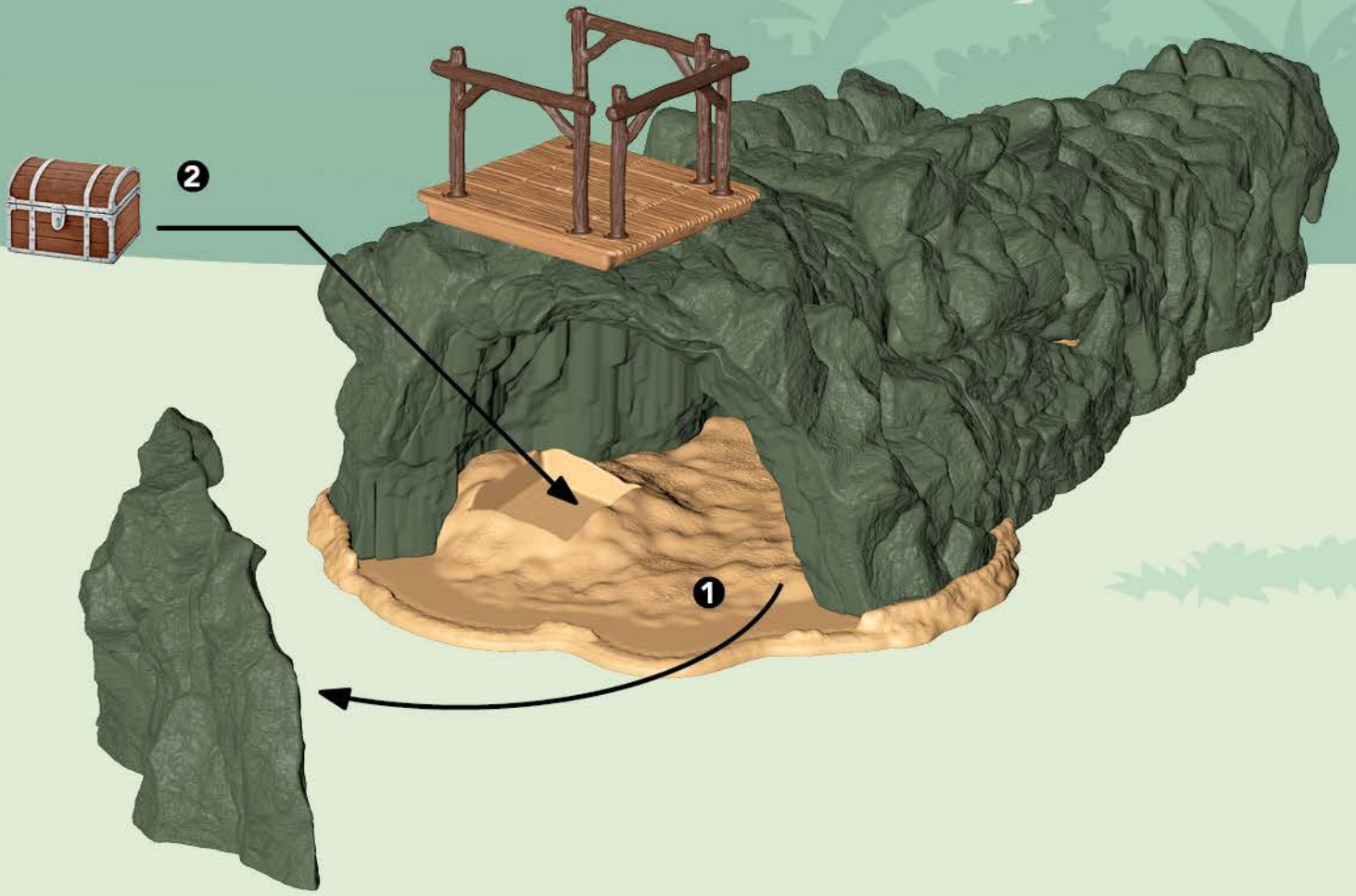

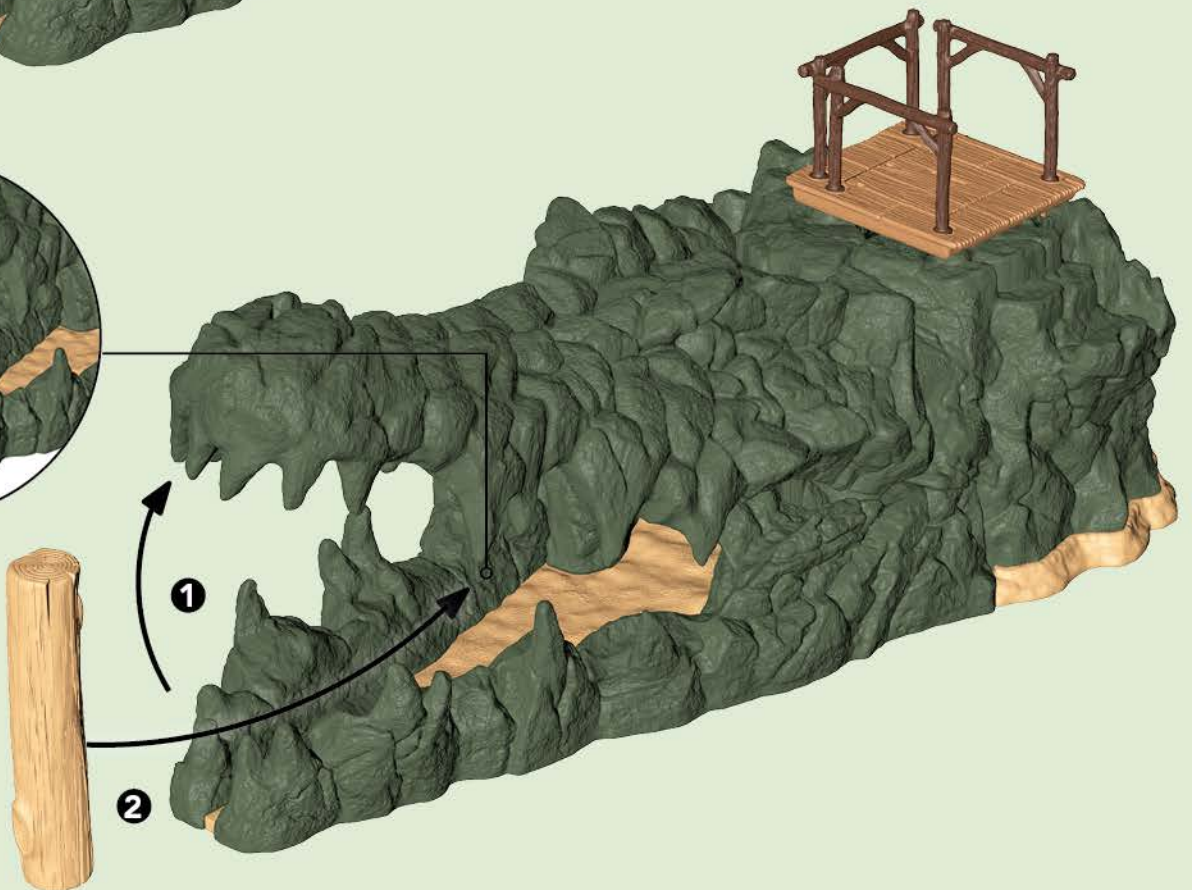

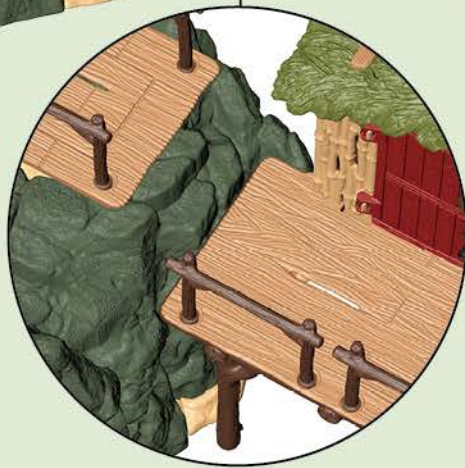

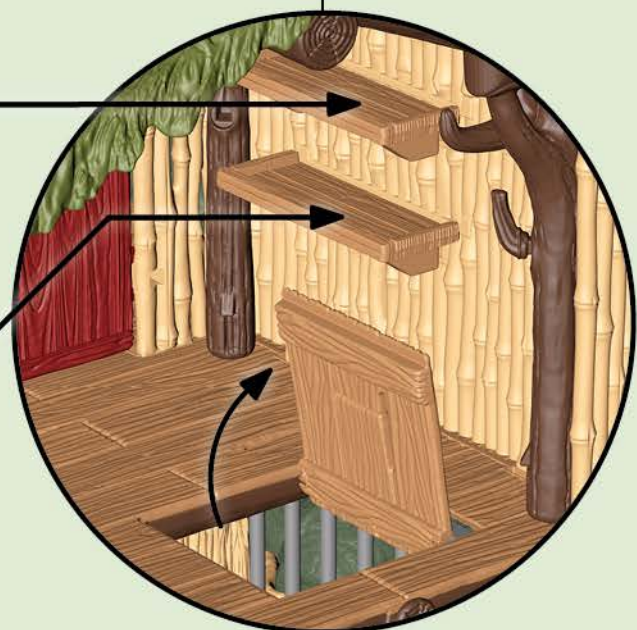



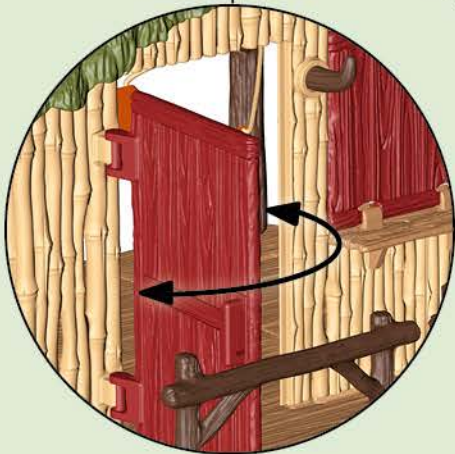
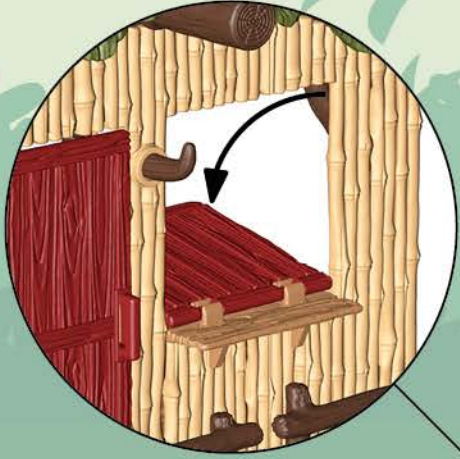

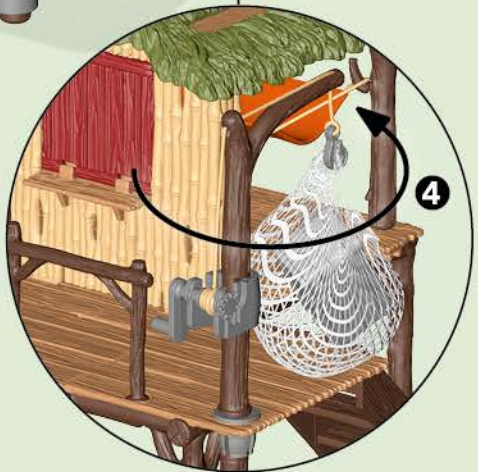
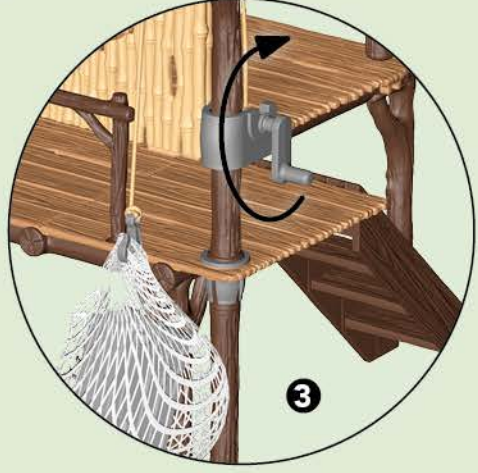
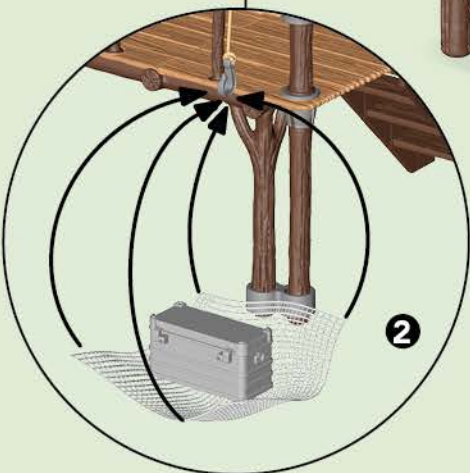
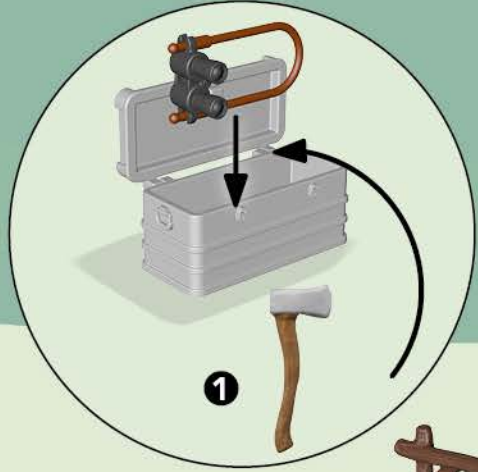



42351

42350



10128667 x 1

=

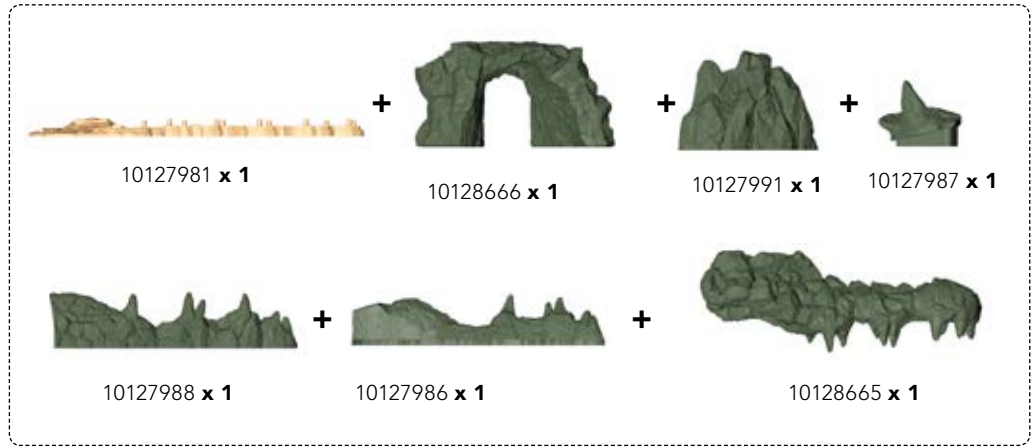

10127956 x 2



10128052 x 1



10128056 x 6



10128635 x 1



10127954 x 1



10127955 x 1



10127957 x 1



10127958 x 1



10127961 x 1



10127966 x 2



10127967 x 2



10127959 x 2



10128059 x 1



10128058 x 1



10128061 x 1



10128063 x 1



10127962 x 2



10128057 x 8



10127964 x 1



10127965 x 1



10127963 x 1



10127960 x 1



10127350 x 1



10127972 x 1



10127969 x 1



10127971 x 1



10127973 x 1



10128851 x 1

=



10127968 x 1

+



10127970 x 1



10128164 x 1



10127349 x 1



10127974 x 1



10127975 x 2



10127977 x 2



10127978 x 2



10127979 x 2



10127976 x 1



10127980 x 6



10128898 x 1



10118815 x 1



10123874 x 1



10110706 x 1



10123263 x 1



10119074 x 1



10119061 x 20



10128050 x 1



10128572 x 1



10127998 x 1



10127996 x 1



10127947 x 1



10128047 x 2



10128044 x 1



10128048 x 1



10128045 x 1



10127995 x 1



10128001 x 1



10128046 x 1



10127999 x 2



10128000 x 2



10128040 x 2



10128041 x 2



10127646 x 1

=



10127652 x 1

+



10127651 x 1

+



10127647 x 1

+



10127645 x 1

Wild Life

Schleich®



14769

14754



14753



14737

14777



14733



42350

42353



42352



42351

