

TRACKIMO

UNIVERSAL TRACKER USER GUIDE



Table of Contents

TABLE OF CONTENTS	1
1. GETTING STARTED	2
1.1. UNPACKING YOUR DEVICE.....	2
1.2. CHARGING YOUR DEVICE FOR THE FIRST TIME	2
1.3. ACTIVATING YOUR DEVICE.....	3
1.4. LOGGING IN.....	5
1.5. RESETTING YOUR PASSWORD.....	6
1.6. YOUR DEVICE LIGHTS AND SOUNDS	7
2. TRACKIMO DASHBOARD.....	9
2.1. DASHBOARD OVERVIEW.....	9
2.2. DEVICE LOCATION INFORMATION.....	11
2.3. UPDATE DEVICE LOCATION.....	12
2.4. DEVICE LOCATION FREQUENCY.....	13
2.5. DEVICE HISTORY.....	14
2.6. DEVICE ALARMS AND SETTINGS	15
2.7. GEO FENCES.....	18

December 2013

1. Getting Started

1.1. Unpacking your device

Carefully unpack your Trackimo device, your packaging should include:

- Battery
- Locking belt clip
- Adhesive Velcro
- Adhesive Magnet
- Water Resistant Sleeve
- USB Cable
- Screw Driver
- Keychain and Lanyard

This Quick Start Guide and a Safety & Warranty booklet are also included.

- Use only approved accessories.
- Accessories may vary by country or region.

1.2. Charging your device for the first time

Your battery will not be installed or charged when you first unpack your device.

Install the battery by tacking off the back cover and insert the battery.

To charge, connect one end of the data cable to the charger port at the bottom of the device, and the other end to a power USB adaptor.

Then connect the USB adaptor to a power outlet. Charge the device for 12 hours.

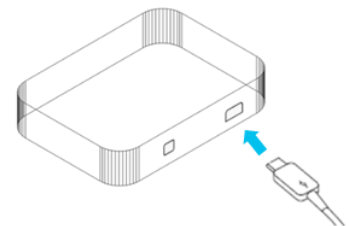

1.3. Activating your device

Press “activate device” from the Trackimo website to begin the activation process.

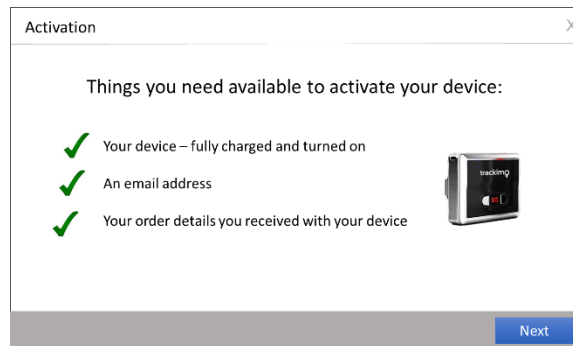

Initial screen telling you what you need available to start the activation process

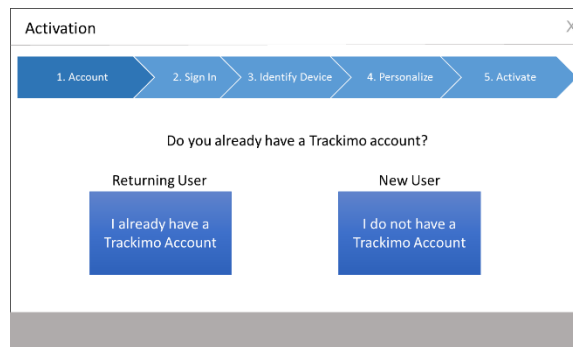

Make sure you already have an account or create an account through the activation wizard

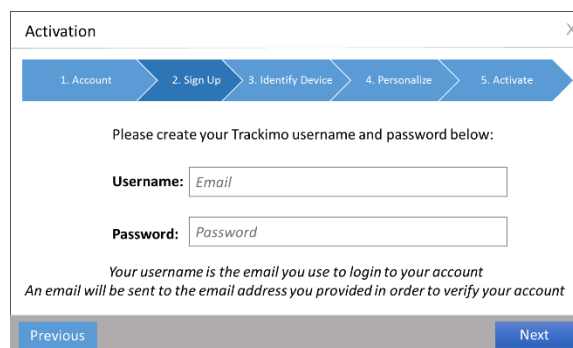

If you have not signed up for the Trackimo service you will need to enter a valid email and password, which will need to be verified before you may use the Trackimo service.

The screenshot shows the 'Activation' window with a progress bar at the top. The progress bar has five steps: 1. Account, 2. Sign In, 3. Identify Device, 4. Personalize, and 5. Activate. Step 2, 'Sign In', is currently selected and highlighted in blue. Below the progress bar, the text reads: 'Please provide your Trackimo username and password below:'. There are two input fields: 'Username:' with a placeholder 'Email' and 'Password:' with a placeholder 'Password'. Below the fields, it says 'Your username is the email you use to login to your account'. At the bottom, there are 'Previous' and 'Next' buttons.

If you do have a Trackimo account, use your credentials to sign in.

The screenshot shows the 'Activation' window with the progress bar. Step 3, 'Identify Device', is selected and highlighted in blue. The text reads: 'Please located and enter your device ID in the text box below and press NEXT to continue'. There is a 'Device ID:' input field with a placeholder 'Device ID'. Below this, there is a section titled 'Location of the Device ID' with the text 'This can also be found on the backside of your Trackimo package'. To the right of this text is an image of a Trackimo device and its packaging, with a red arrow pointing to the back of the device.

Identify your device with the Device ID located on your device or packaging

The screenshot shows the 'Activation' window with the progress bar. Step 4, 'Personalize', is selected and highlighted in blue. The text reads: 'Personalize your device by creating a Nickname for it'. There is a 'Device Nickname:' input field with a placeholder 'Device Nickname'. At the bottom, there are 'Previous' and 'Next' buttons.

Provide a nickname for your device

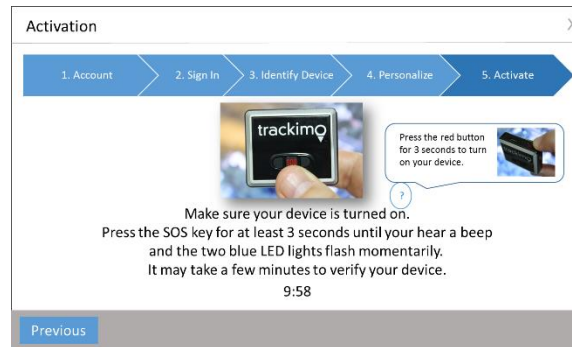

We will need to identify your device is owned by you. We do this by physically associating your device to your account. Follow the instructions and click on the SOS button to associate the device to your account.

Note: If you are a new Trackimo user, you will need to verify your email address before you can use the Trackimo service with your device.

1.4. Logging In

After activating your device for the first time, you will receive a confirmation email to validate your email address.

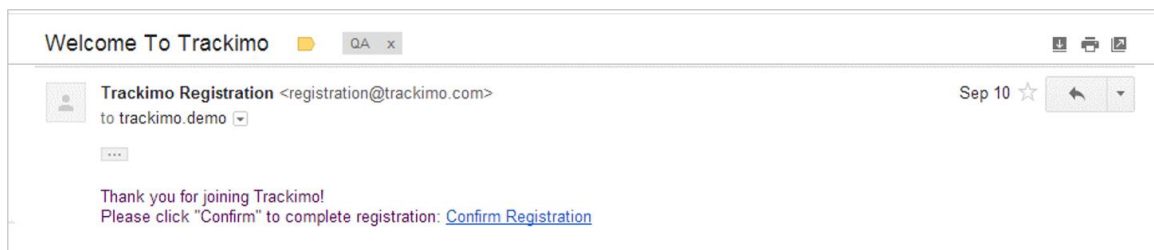

From this point on you can login through the Trackimo website to view your device location information on a visual map through an interface called the Trackimo dashboard.

1.5. Resetting your Password

In case you may have forgotten your password, you can click on the forgotten password link in the login dialog.

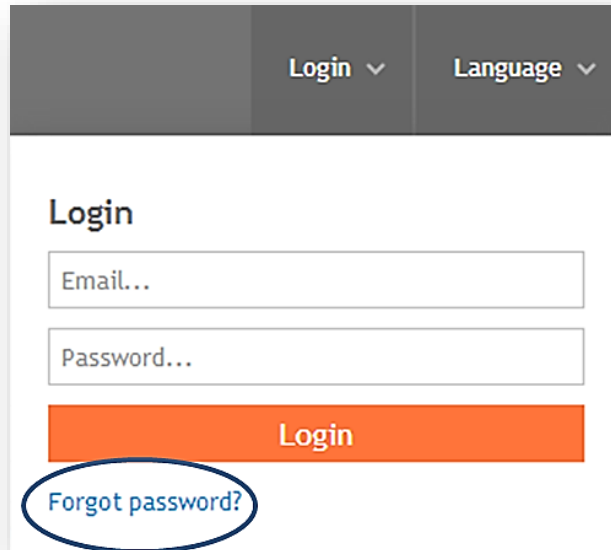

The image shows a login dialog box with a dark grey header containing 'Login' and 'Language' dropdown menus. Below the header, the word 'Login' is displayed in bold. There are two input fields: 'Email...' and 'Password...'. Below these fields is an orange 'Login' button. At the bottom left, the text 'Forgot password?' is circled in blue.

An email will be sent to you to reset your password, clicking on the link within the email will open a browser window that will allow you to set a new password.

1.6. Your Device Lights and Sounds

Your device will make sounds and lights will be displayed to provide you with better visual and sound information, for a richer experience. The picture below shows where all the buttons and lights are located on the device, the table below will show what causes lights to turn on and the device to make sounds.

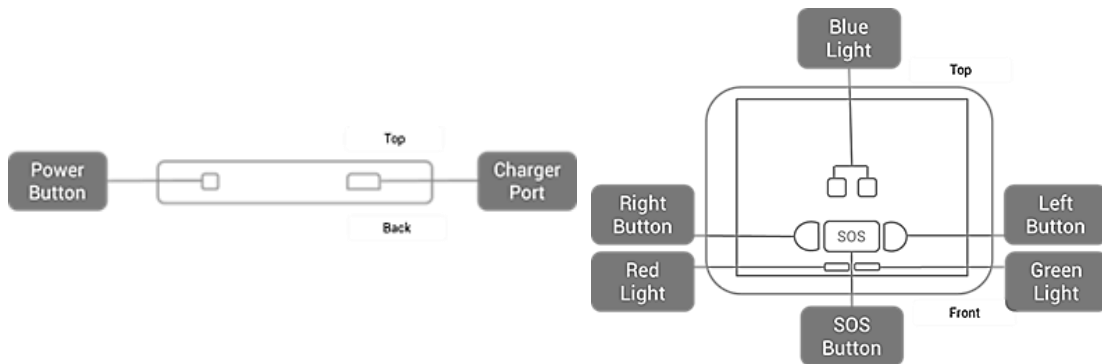

Action	Lights	Sounds
Power on the device	Green light will flash 3 times	2 short beeps
Power off the device	Red light will flash twice	Long beep
Connected to Mobile network	Left blue light on for 4 seconds	Long Beep
Any key is pressed	Green light on for 3 seconds	
SOS key pressed for 2 seconds	Both blue lights flash twice	Long Beep
Left or Right key pressed for 2 seconds	Corresponding blue led flashes twice	Long Beep

Low Battery	Red light flashing	
Charging	<i>Slow flashing red light</i>	
Plugged in and fully charged	<i>Red light</i>	
Cellular network and GPS not connected	<i>Left and right blue lights flash slow</i>	Short beep
No cellular network connection, GPS connected	<i>Right blue light on for 4 seconds</i>	Short beep
Cellular network and GPS connected	<i>Left blue light on for 4 seconds</i>	Short beep

2. Trackimo Dashboard

2.1. Dashboard Overview

After logging in to the Trackimo website with your username and password, you will reach the Trackimo dashboard. The image below provides the Trackimo dashboard with a short explanation in the table below about the key items within the dashboard.

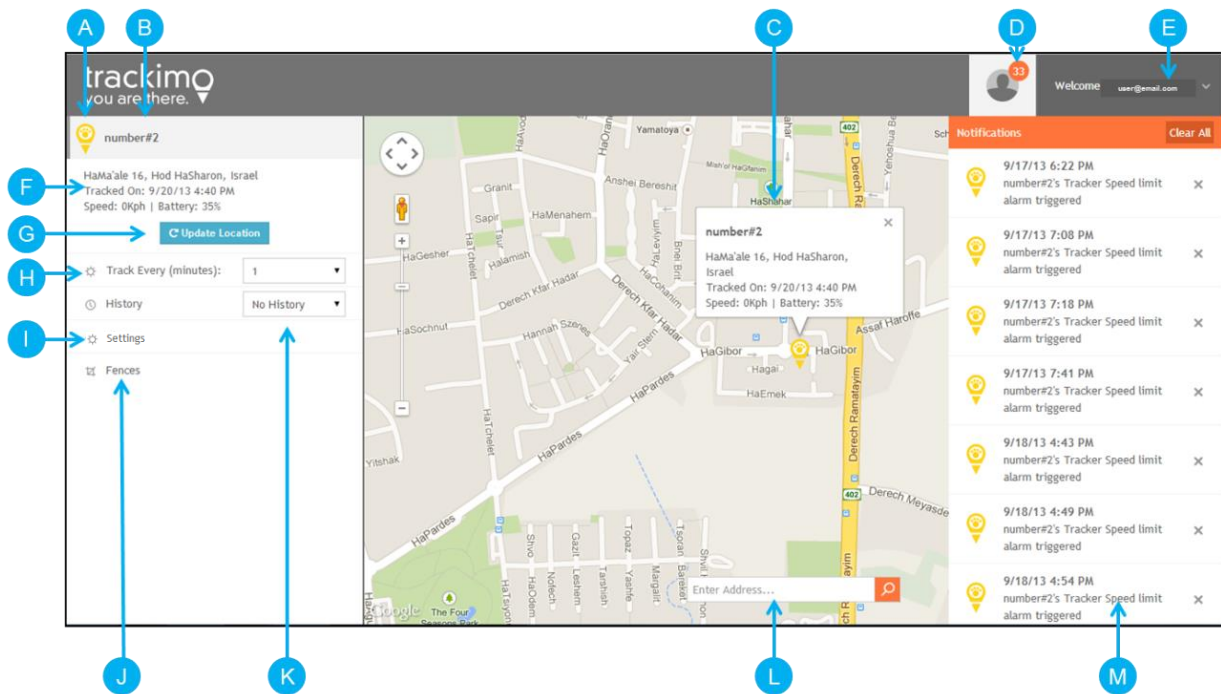

A <i>Device Marker Icon</i>	This is the icon that is associated with a device, this will be the icon representing the device on the map. (You can change your icon in the setting menu)
B <i>Device Nickname</i>	The nickname chosen for your device, this nickname will appear in emails and notifications. (You can change your device's nickname by clicking the edit icon next to it. Select a new nickname and save.)

C	<i>Device Info Pop Up</i>	Provides location and speed information about the device, and is located right above the device marker on the map.
D	<i>Notification Menu</i>	Alerts the user to the number of unread device notifications, and upon clicking the menu shows all device notifications.
E	<i>User Menu</i>	Upon clicking provides user specific options such as logging out or activating another device.
F	<i>Device Location Information</i>	Provides location, battery status and speed information about the device.
G	<i>Update Location Button</i>	Updates the device location.
H	<i>Tracking Frequency Selector</i>	Provides the option to select how frequently the device updates its location, please note, the more frequently that the device updates its location, the shorter battery life it will have.
I	<i>Settings Menu Button</i>	Upon clicking the button, the alarm menu will open allowing setting alarms and notifications.
J	<i>Fences Menu</i>	Upon clicking the button, existing fences appear, and the fences menu becomes available.
K	<i>View History Selector</i>	Selects the device history and shows it on the map.
L	<i>Search and Center Map around Location</i>	Allows entering an address and clicking on the search button to center the map on a specific address.
M	<i>Device Notifications</i>	The device notifications, upon clicking them, they will be cleared from the list.

Device Location

2.2. Device Location Information

The device information can be found in two places:

1. When clicking on the device marker icon on the map, the location information will be available inside the information pop up right above the device marker icon.
2. When clicking on the device on the left sidebar of the dashboard the location information will be right below the device name.

The location information available is the device address, time tracked, speed, battery percentage left, and the longitude and latitude location of the device.

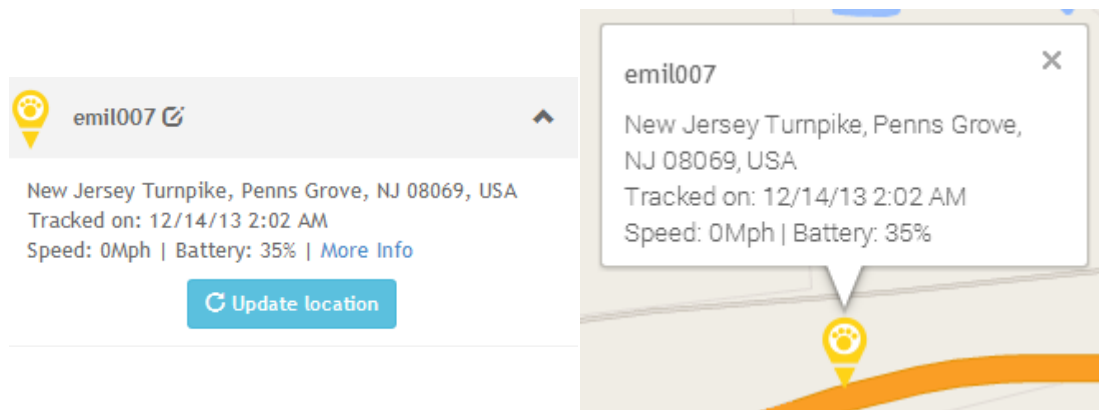

Note: The device location may be based on the cellular network signal (GSM location), this location is not accurate, but rather an approximation of the device location.

If GPS location is not available, the location will be based on GSM location and text will appear in the device location information area notifying that the location is based on the cellular network. A blue halo will also surround the tracking marker notifying you that the location is approximate, as shown in the image below.

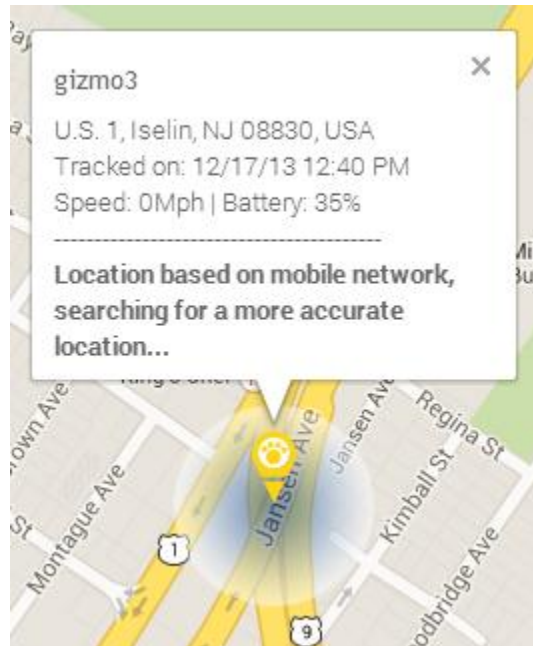

2.3. Update Device Location

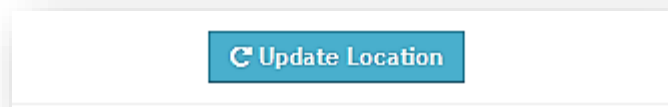

Upon clicking on the update location button, available for each device, Trackimo will attempt to contact the device through the cellular network and retrieve the devices exact location.

Trackimo will retrieve an exact GPS based location, but if GPS is unavailable at the device location, Trackimo will attempt to approximate the location using the mobile network signals to the device.

If the device is unreachable within 60 seconds from the Trackimo system, the system will notify the user with an information notification. Reasons that the device

may be unreachable may include; the device being turned off, the device is out of battery, and the device is in an area which does not have cell phone reception.

2.4. Device Location Frequency

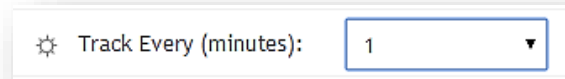

The device location frequency can be set by the user. This setting determines how often the device reports its location to you through the Trackimo system.

Manual	The device location will only update when the user clicks the update location button; this ensures the longest battery life to the device.
1 Minute	The device will update its location every 1 minute; this mode will cause the device to have the shortest battery life.
5 Minutes	The device will update its location every 5 minutes; this mode will cause the device to have a short battery life.
30 Minutes	The device will update its location every 30 minutes; this mode will cause the device to have a moderate battery life.
120 Minutes	The device will update its location every 120 minutes; this mode will cause the device to have a long battery life.

Note: When the device reaches a low battery alarm, it automatically switches to manual mode to conserve the device battery.

2.5. Device History

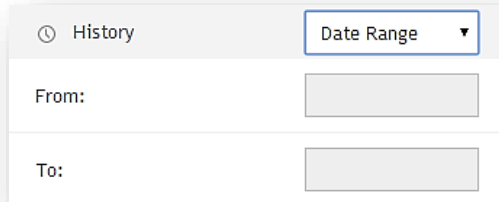
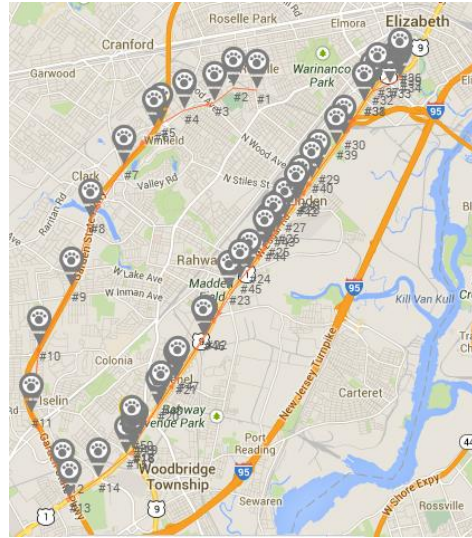
The device history can be displayed on the map by selecting the device history from the history dropdown.

The map will display history marker icons in grey on the map, will connect the markers to indicate the device tracking path, and will number the device marker icons to form a device history timeline.

The device history can be shown from the last hour, today (24 hours), the last week, and by specifying a specific date and time range (start and end).

Clicking on any device marker info from the history will show the time of the history, the location and the speed.

The map will automatically also zoom to show all the history of the device in a single view for you. You can also zoom in and out to better view the device history.

2.6. Device Alarms and Settings

Clicking on the device alarms will open a settings menu on top of the screen. This will allow you to set the device specific settings and alarm notifications.

Alarms are sent to your configured email and to the Trackimo dashboard, the notification alarms will include the device location and speed at the time the alarm is triggered.

The following alarms are available:

Speed Limit	A notification is sent when the speed limit is crossed.
Low Battery	A notification is sent when the battery level reaches 20%..

Moving Start	A notification is sent when the device starts to move.
Right Key Pressed	A notification is sent when the right key is pressed on the device.
Left Key Pressed	A notification is sent when the Left key is pressed on the device.
SOS Key Pressed	A notification is sent when the SOS key is pressed on the device.

The following settings are available:

Measurement Units	Sets whether to track the device in Miles or Kilometers
Device Marker Icons	Selects the icon for the device marker

Sending Alarms to contacts

The Trackimo service allows you to send alarms you may receive to other contacts through their email address or as an SMS alarm to their cell phone.

This can be done by clicking on the clicking on the "Add contacts for this alarm" link below each alarm.

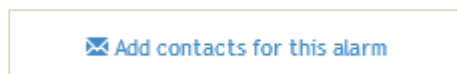

When this is done a dialog will appear as shown in the image below. Contacts that are checked on the right side will receive the alarm. You may remove a contact by clicking on the "Remove from contacts list" link per contact.

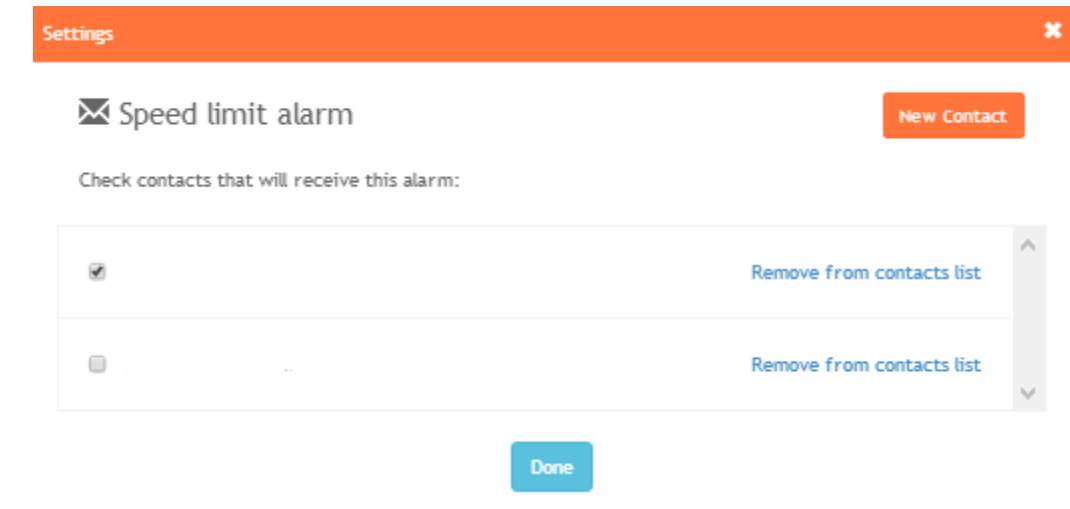

To create a new contact click on the "New Contact" button. This will open a dialog as shown below. You can either add an email or a phone number as a contact.

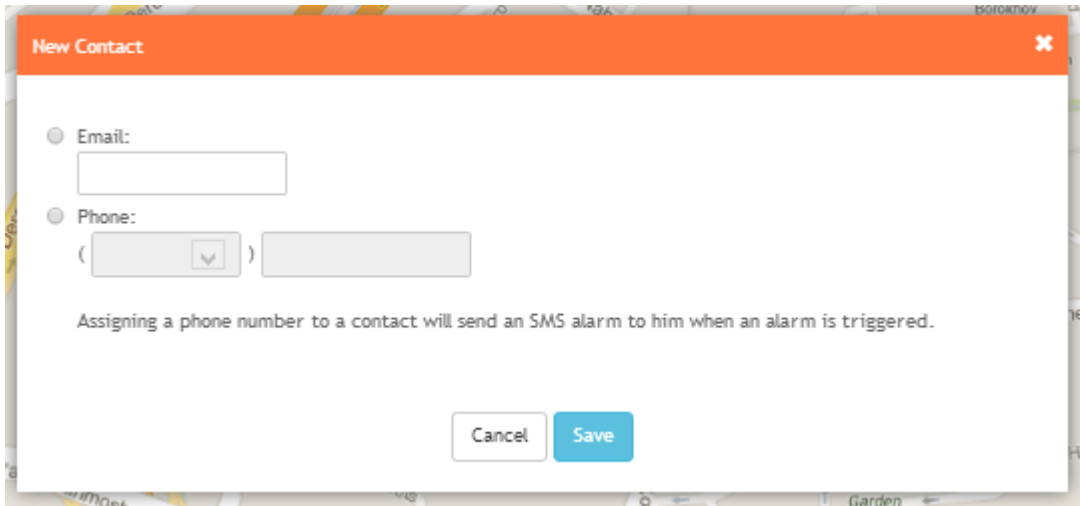

2.7. Geo Fences

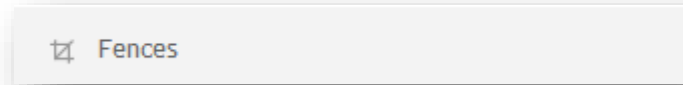

A GeoFence is a virtual fence (a square around a certain location) that you can set using the Trackimo dashboard. When the device crosses the virtual fence, you will receive an email alarm message with information of when the device has crossed the virtual fence.

Creating a GeoFence

 A screenshot of a dialog box for creating a GeoFence. It contains the following elements:

- A search prompt: "Search an address for your fence:"
- A search input field with the placeholder text "Enter Address..." and a magnifying glass icon on the right.
- A "Size:" label followed by a dropdown menu showing "..." and a downward arrow.
- A "Fence name:" label followed by an input field containing the text "My fence".
- At the bottom, two buttons: "Cancel" (white) and "Save" (green).

To setup a GeoFence:

1. Click on the Fence button in the device menu
2. Click on the "Create a new fence" button, this will open the new fence options below the button.
3. You will then have the option to search for an address for your fence and set a perimeter. A red rectangle will appear on the map representing your GeoFence. You can then move or resize your GeoFence directly on the map.

4. When done, give your fence a name in the new fence options and click on save to save your GeoFence.
 - Your fence can not be smaller than 200 meters (218 Yards).

Modifying a GeoFence

To modify a GeoFence:

1. Click on the Fence button in the device menu
2. Click on the fence name you would like to modify.
3. The map will center on the fence and the fence will be displayed as a red rectangle on the map.
4. Click on the Edit button
5. You will then have the option to search for an address for your fence and set a perimeter. A red rectangle will appear on the map representing your GeoFence. You can then move or resize your GeoFence directly on the map.
6. When done click Save.

Deleting a GeoFence

To delete a GeoFence:

1. Click on the Fence button in the device menu
2. Click on the fence name you would like to modify.
3. The map will center on the fence and the fence will be displayed as a red rectangle on the map.
4. Click on the Delete Button.
5. Your fence will be deleted