

SHAD

Urban bags for city bikers



MANUAL DE USO

Executive Bar Bag 3L



CUIDADOS Y MANTENIMIENTO



Correa bandolera recogida en circulación
(se recomienda desanclar y meter dentro).

Carga máxima permitida **(1,5KG)**.

Uso recomendado para trayectos urbanos e interurbanos.

MANTENIMIENTO Y LIMPIEZA

En el caso de que se necesite limpiar la bolsa, utilizar un trapo suave humedecido en una disolución de agua y jabón neutro.

Se recomienda verificar habitualmente el estado de los mecanismos para evitar daños.



CARACTERÍSTICAS



3L de capacidad



1,5 Kg de carga máxima



Modo manillar



Modo sling bag



Alta resistencia UV



Funda impermeable

INCLUIDO

2 cintas de sujeción



Funda impermeable

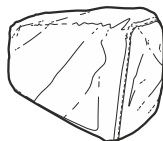

Correa bandolera

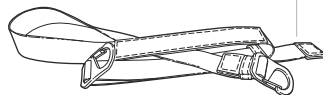

MONTAR

1

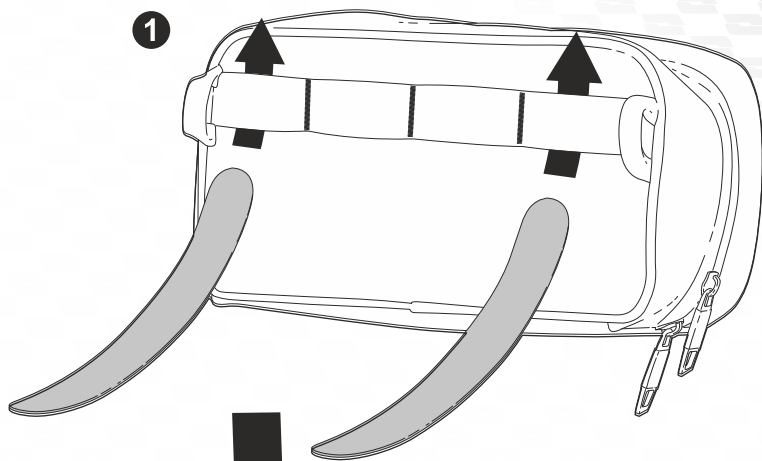

2

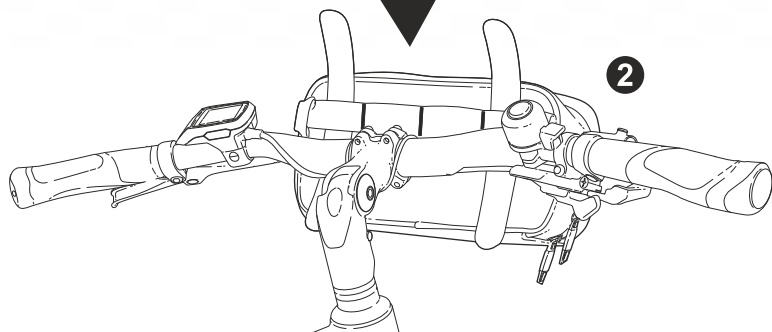

3

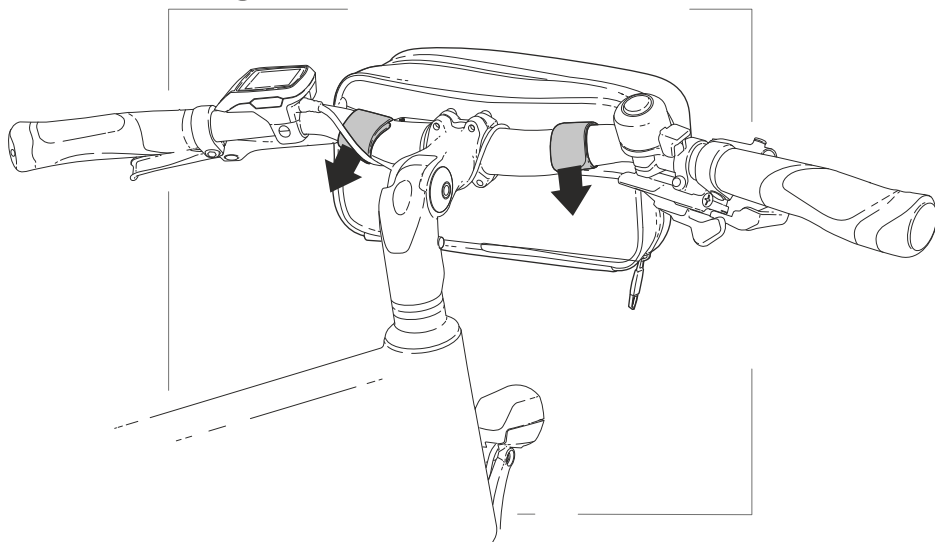

2 posiciones de montaje

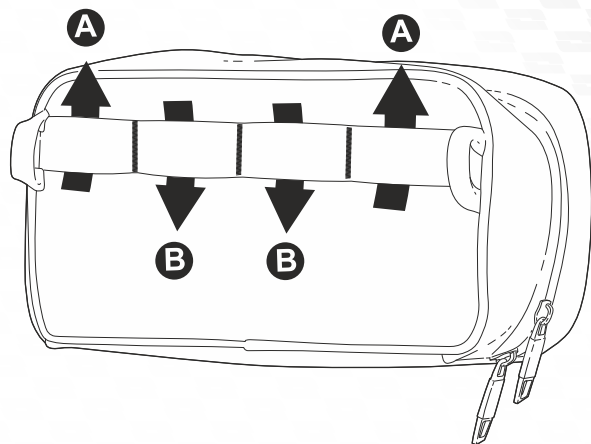

DESMONTAR

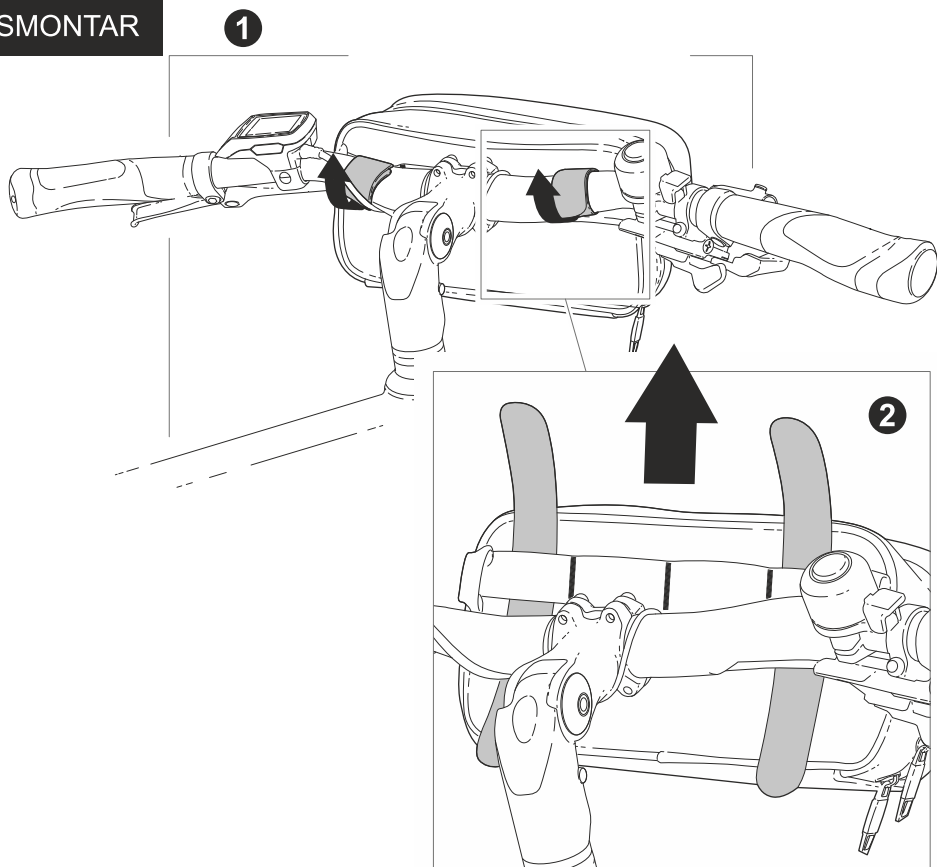

Características

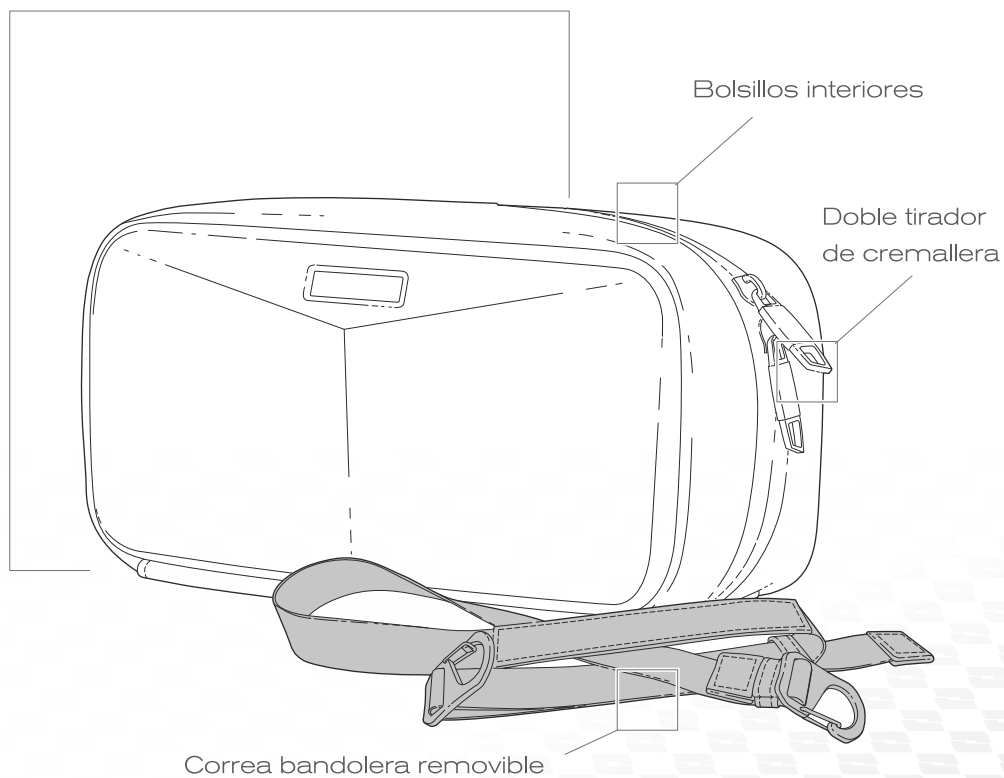

SHAD

Urban bags for city bikers



DESIGNED IN BARCELONA

Since 1973

shad-bikes.com



SHAD

Urban bags for city bikers

REDUCCIÓN DE RECURSOS
60% DE LAS FÁBRICAS SON AUTOSUFICIENTES
1500 ÁRBOLES PLANTADOS 🌲🌲🌲

 tree-nation

ISO 14001:2015



STANDARD 100
23.HCN.49451
HOHENSTEIN HTFI



shad-bikes.com

SHAD

Urban bags for city bikers



USER GUIDE

Executive Bar Bag 3L



CARE AND MAINTENANCE



It is recommended to unhook and tuck inside or cross in front the shoulder strap while moving.

Maximum allowed load **(1,5KG)**.

Recommended for urban and commuter journeys.

MAINTENANCE AND CLEANING

If cleaning of the bag is necessary, use a soft cloth dampened with a solution of water and neutral soap.

It is recommended to regularly check the condition of the mechanisms to prevent damage.



FEATURES



3L Capacity



1,5Kg capacity per bag



Handlebar mode



Sling mode



High UV Resistant



Raincover

INCLUDED

2 Straps

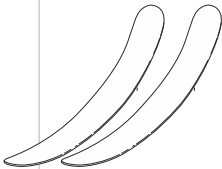

Raincover

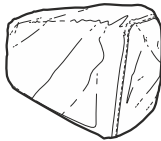

Shoulder strap

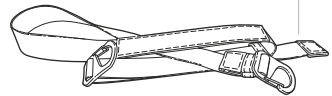

ATTACHMENT

1

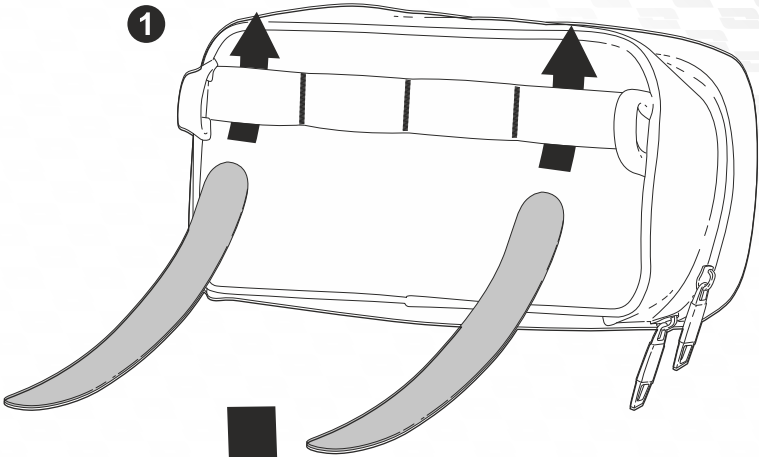

2

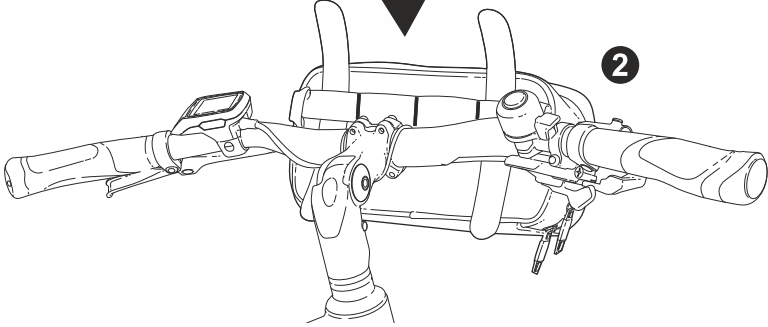

3

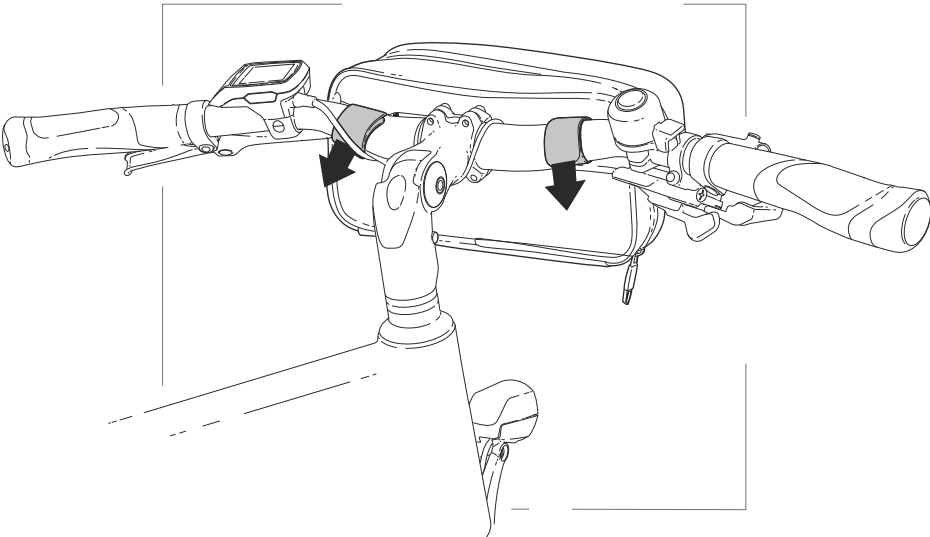

2 Assembly positions

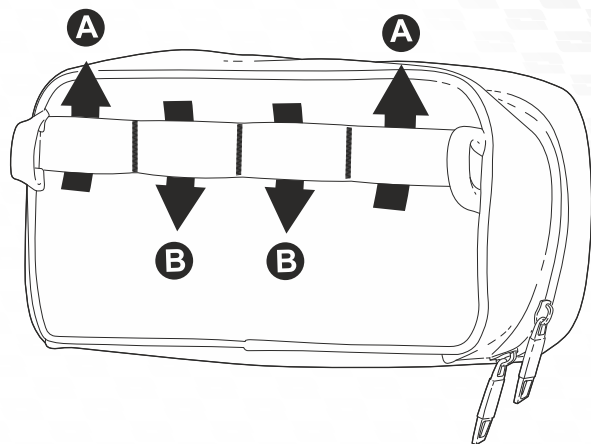

DETACHMENT

1

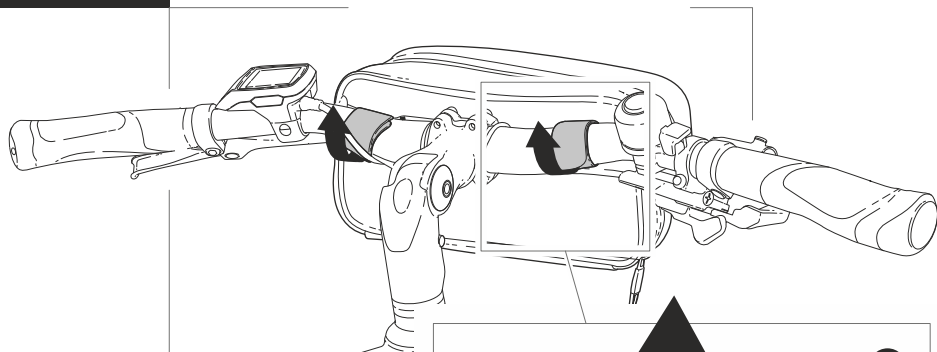

2

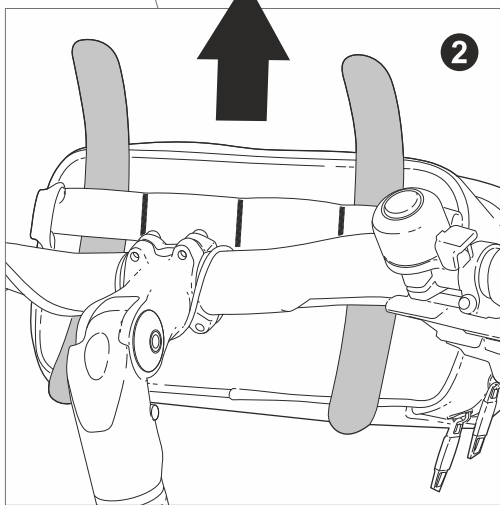

Features

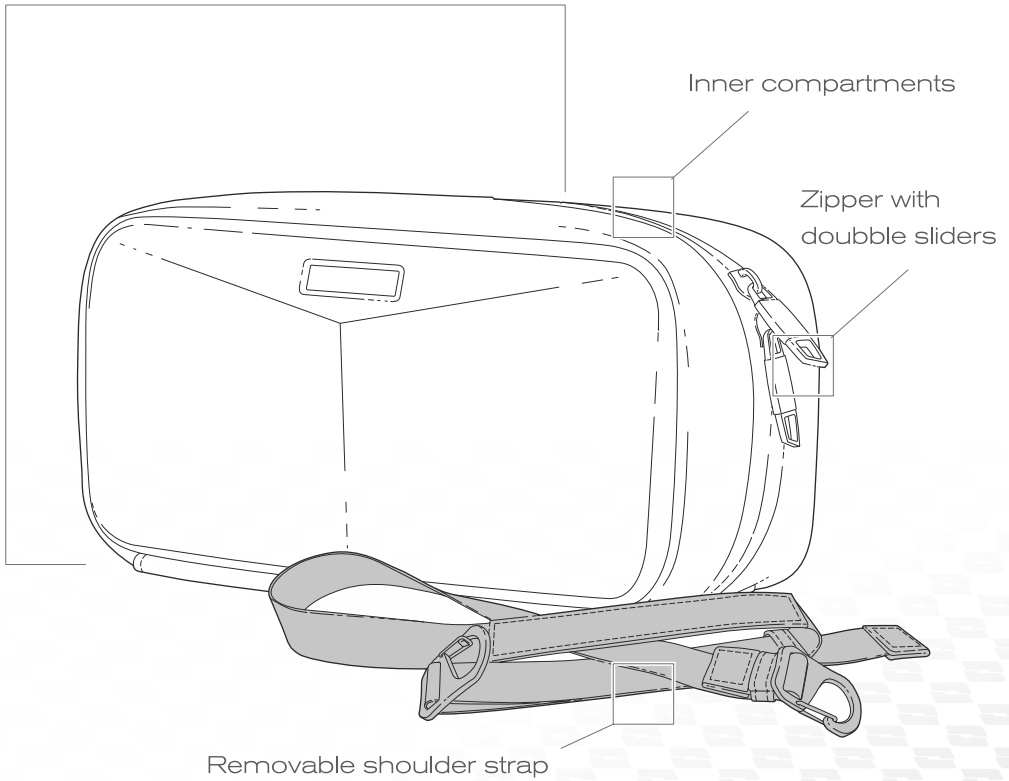

SHAD

Urban bags for city bikers



DESIGNED IN BARCELONA

Since 1973

shad-bikes.com



SHAD

Urban bags for city bikers

RESOURCE REDUCTION
60% SELF SUSTAINING FACTORIES
1500 TREES PLANTED 🌲🌲🌲



ISO 14001:2015



STANDARD 100
23.HCN.49451
HOHENSTEIN HTFI



shad-bikes.com