

SHAD

Urban bags for city bikers



MANUAL DE USO

Daily Tote Bag 16L



CUIDADOS Y MANTENIMIENTO



Correa bandolera / asas recogidas en circulación
(Cerrar con loop superior o asegurar en enganche frontal).

No se recomienda poner dispositivos electrónicos en bolsillo
duro frontal (hay bolsillo reforzado para portátil en el interior).

Asegurar que los ganchos Vario están bien ajustados al
diámetro del tubo de tu portaequipajes.

Se recomienda cerrar correctamente el compartimento
superior mientras se circula.

Carga máxima permitida **(4KG)**.

Uso recomendado para trayectos urbanos e interurbanos.

MANTENIMIENTO Y LIMPIEZA

En el caso de que se necesite limpiar la bolsa, utilizar un trapo
suave humedecido en una disolución de agua y jabón neutro.

Se recomienda verificar habitualmente el estado de los
mecanismos para evitar daños.



CARACTERÍSTICAS



16L de capacidad



4Kg de carga máxima



Bolsillo interior para portátiles 14"



Modo alforja



Modo bandolera



PET Reciclado



Funda impermeable



Tercer punto de anclaje, útil para trolley de maleta

INCLUIDO

Funda impermeable

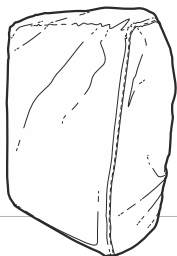

Correa bandolera

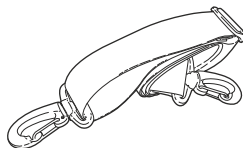

Vario Hook

KLICKfix[®]

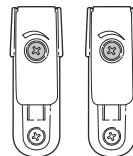

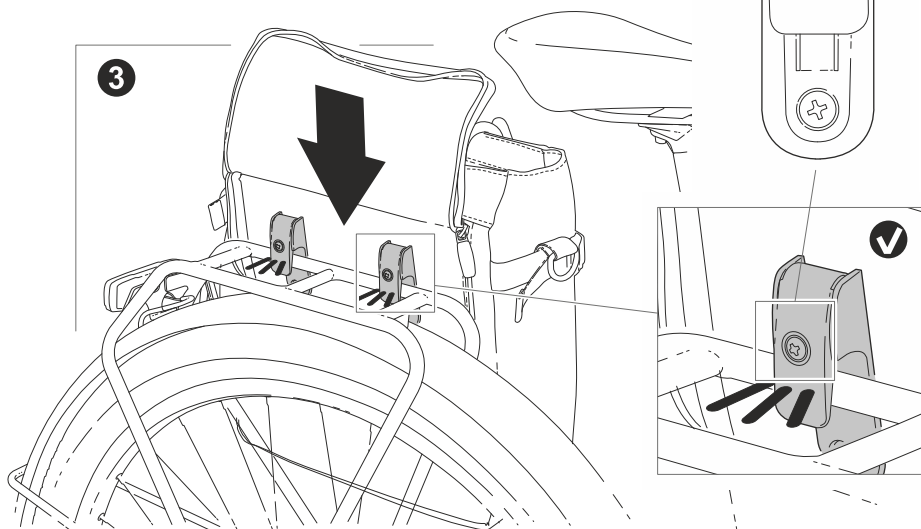
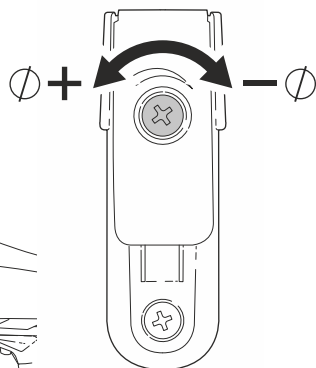
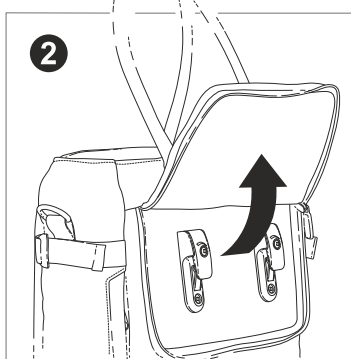
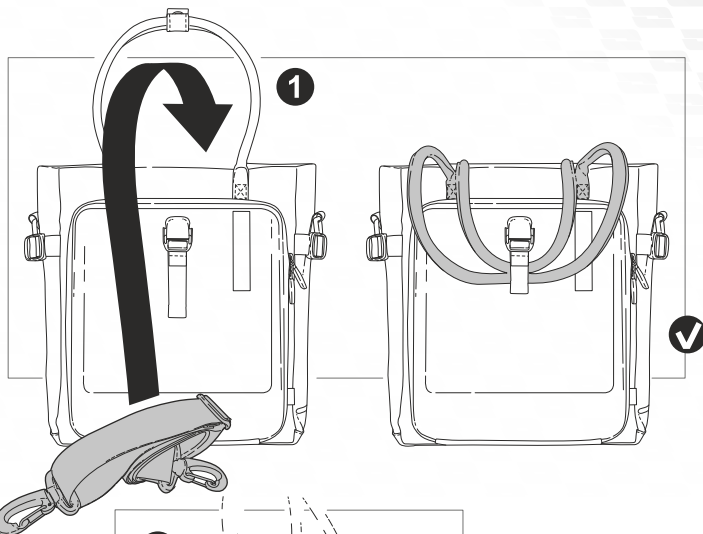

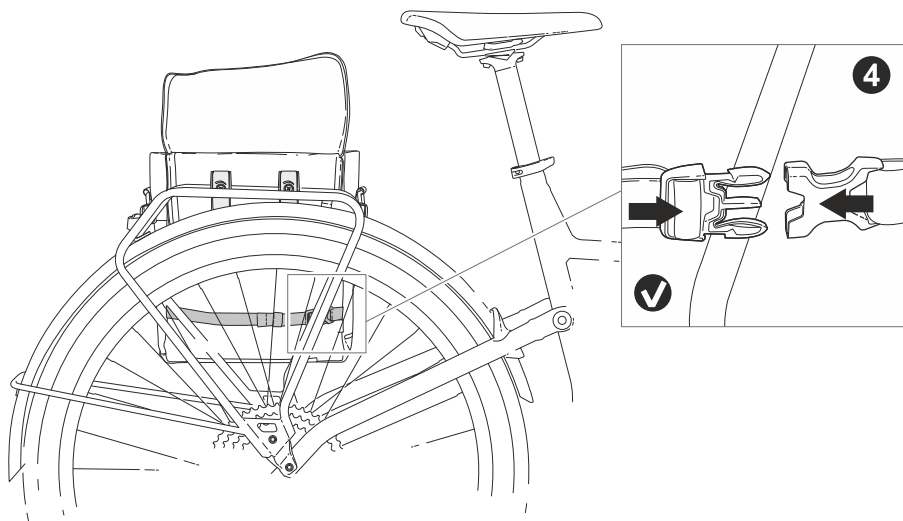

DESMONTAR

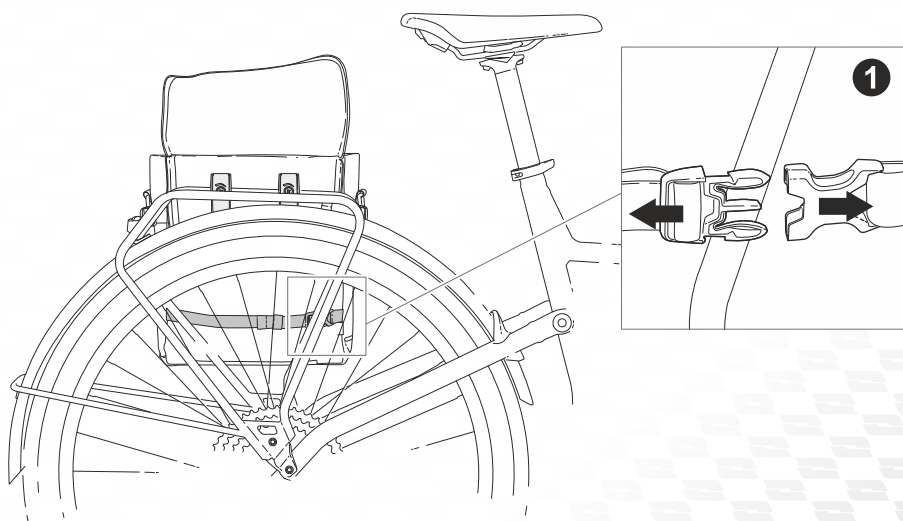

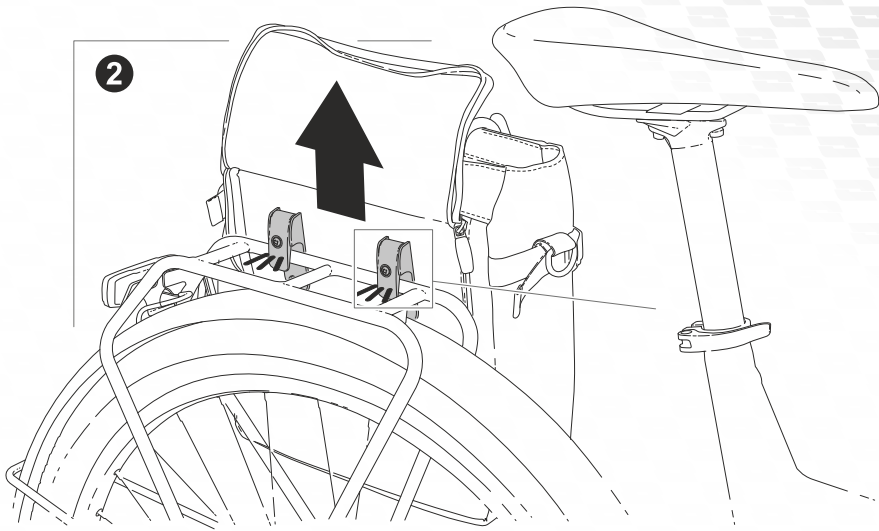

Características

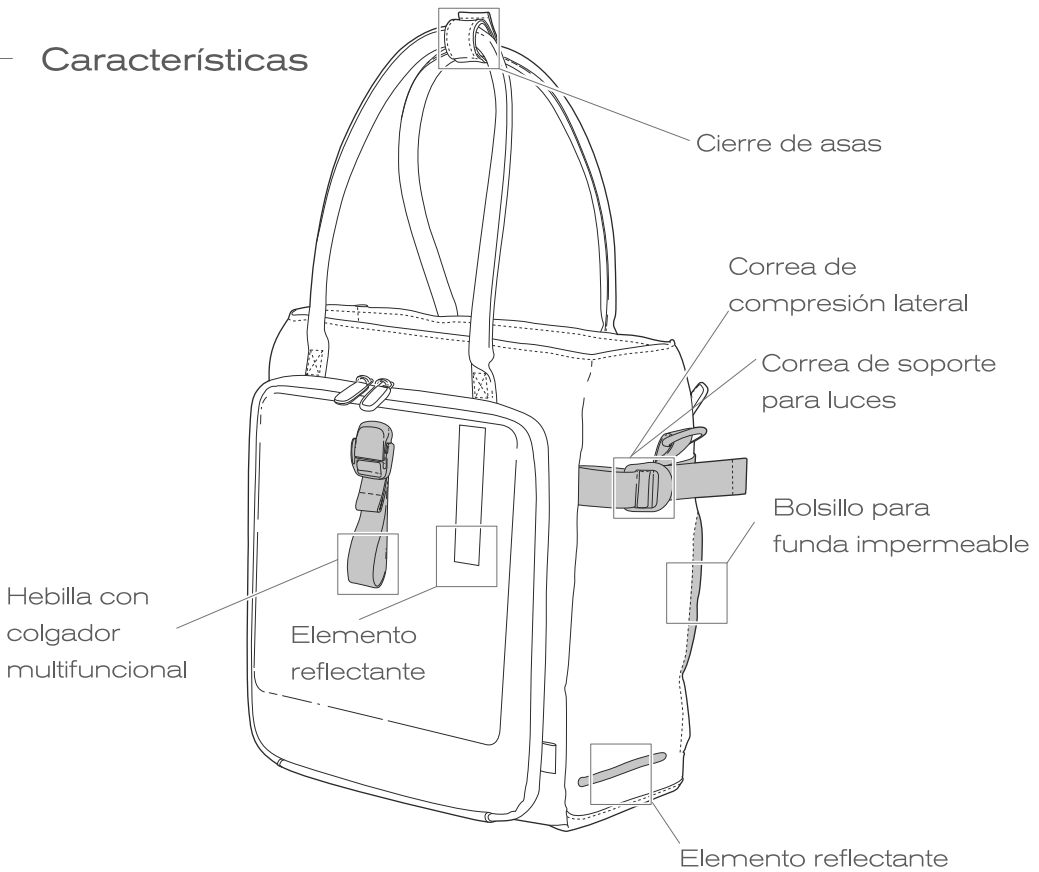

SHAD

Urban bags for city bikers



DESIGNED IN BARCELONA

Since 1973

shad-bikes.com



SHAD

Urban bags for city bikers

REDUCCIÓN DE RECURSOS
60% DE LAS FÁBRICAS SON AUTOSUFICIENTES
1500 ÁRBOLES PLANTADOS 🌲🌲🌲



75% de poliéster reciclado
Shad Bikes cert. ITS-557685-GRS-01038400

ISO 14001:2015



shad-bikes.com

SHAD

Urban bags for city bikers



USER GUIDE

Daily Tote Bag 16L



CARE AND MAINTENANCE



Shoulder Straps gathered
(Close with upper loop or fasten to front buckle).

It is not recommended to put electronic devices in the front hard pocket (there is a padded laptop pocket inside).

Ensure that the Vario hooks are properly adjusted to your bike rack tube diameter.

It is recommended to properly close the top compartment while in motion.

Maximum allowed load **(4KG)**.

Recommended for urban and commuter journeys.

MAINTENANCE AND CLEANING

If cleaning of the bag is necessary, use a soft cloth dampened with a solution of water and neutral soap.

It is recommended to regularly check the condition of the mechanisms to prevent damage.



FEATURES



16L Capacity



4Kg capacity per bag



Laptop pocket interior 14"



Bike rack mode



Carry mode



Recycled PET



Raincover



Third anchoring point, useful for trolley suitcase use

INCLUDED

Raincover

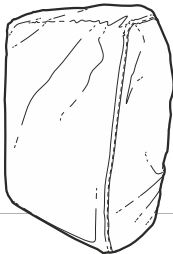

Soulder strap

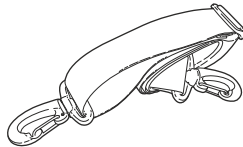

Vario Hook

KLICKfix[®]

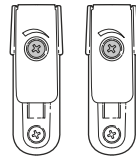

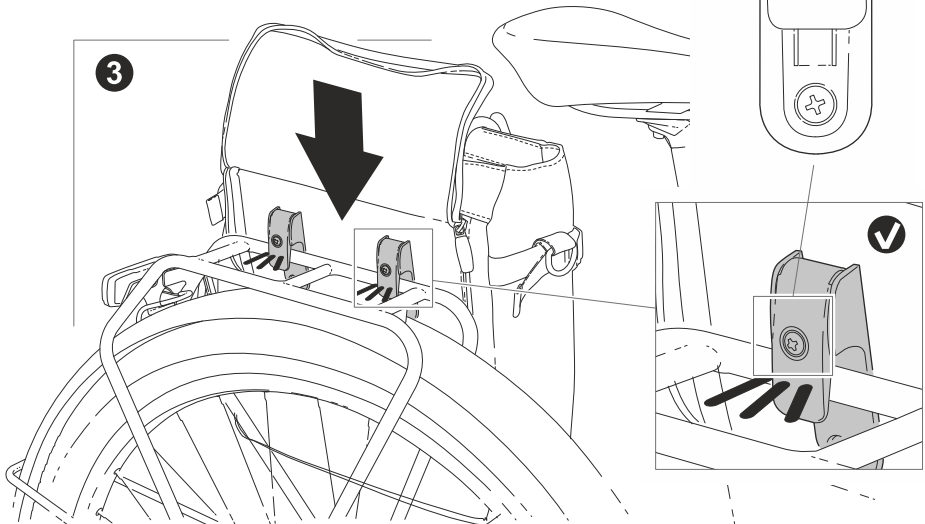
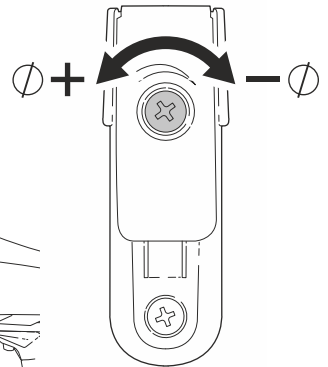
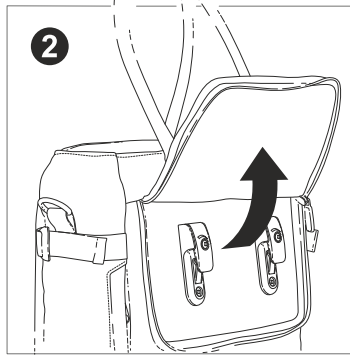
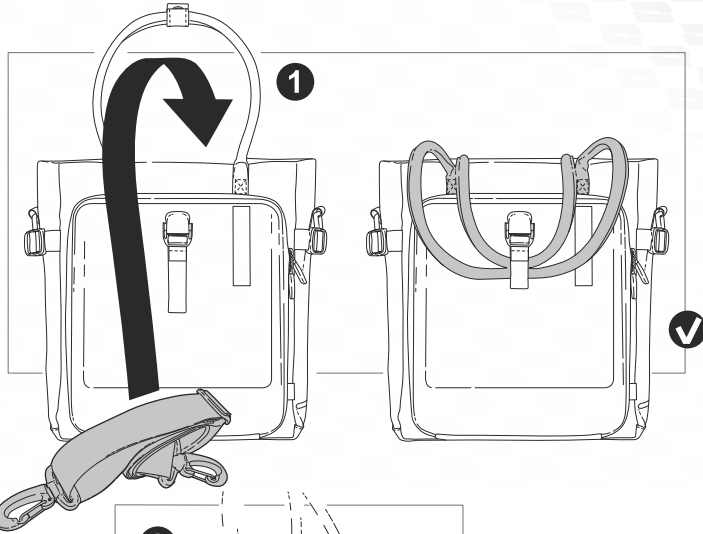

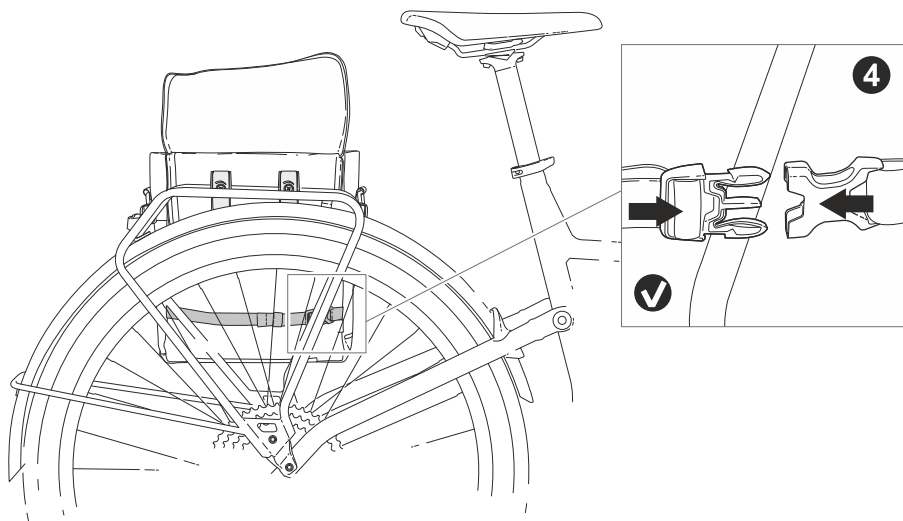

DETACHMENT

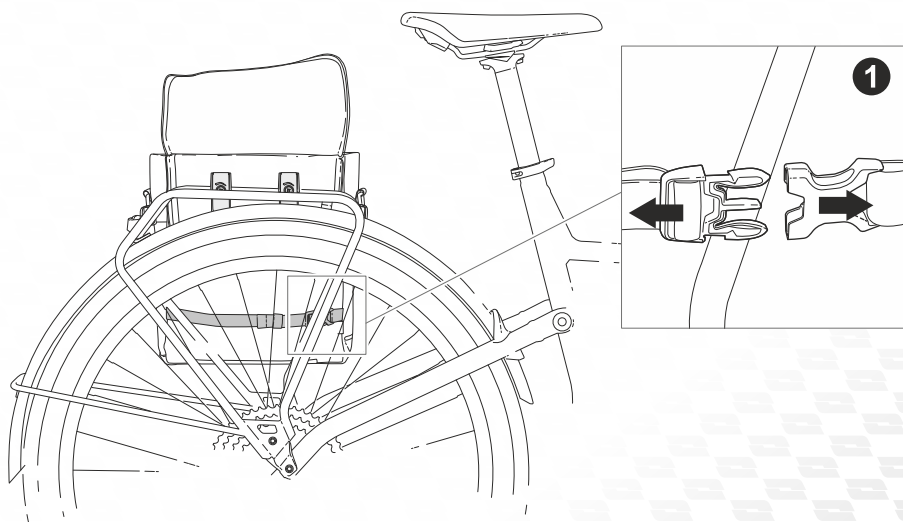

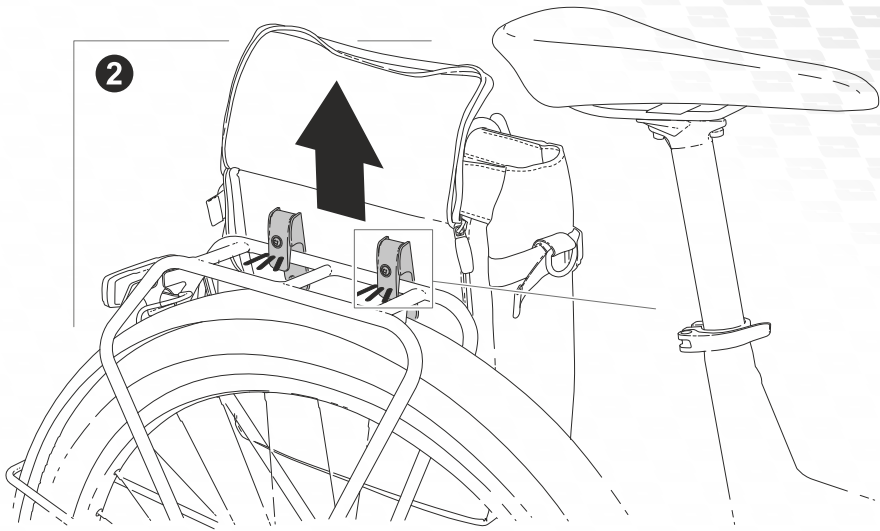

Features

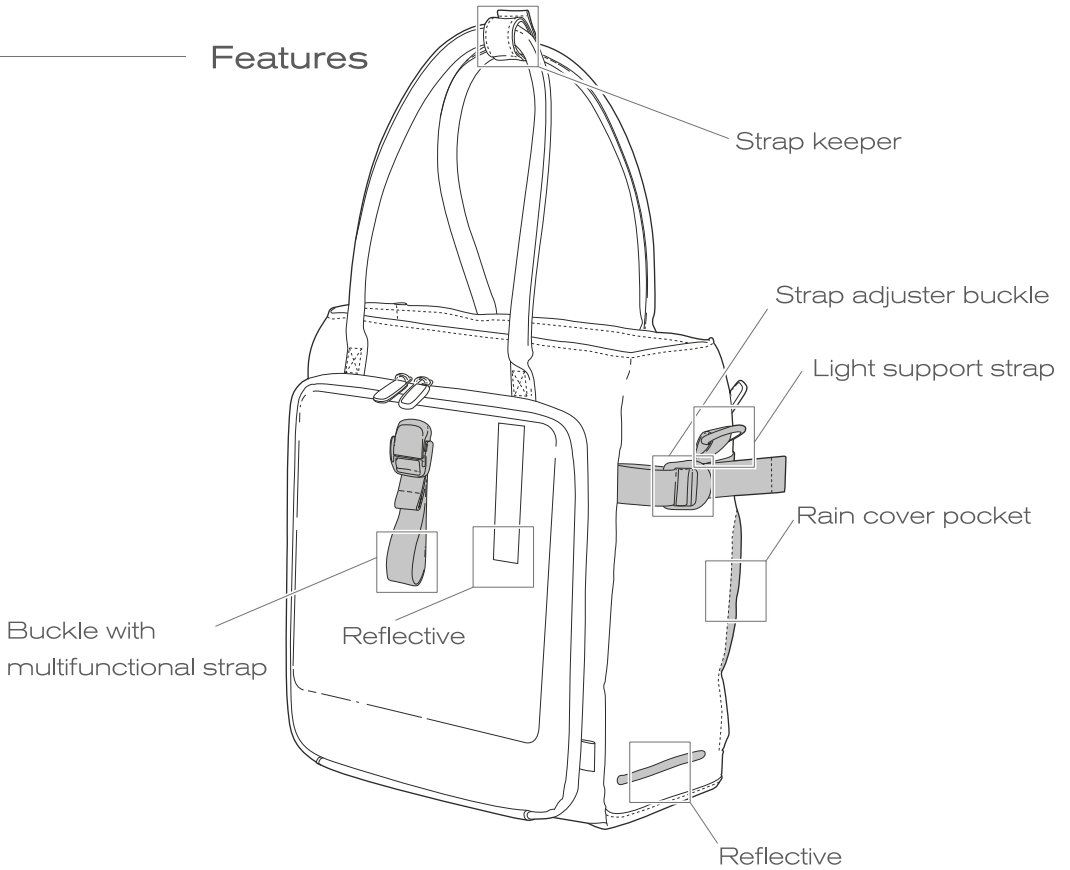

SHAD

Urban bags for city bikers



DESIGNED IN BARCELONA

Since 1973

shad-bikes.com



SHAD

Urban bags for city bikers

RESOURCE REDUCTION
60% SELF SUSTAINING FACTORIES
1500 TREES PLANTED 🌲🌲🌲



75% de poliéster reciclado
Shad Bikes cert. ITS-557685-GRS-01038400

ISO 14001:2015



shad-bikes.com