



HAIBO[®]

iPenguin GPS

**BOW MOUNT ELECTRIC MOTOR
OWNERS MANUAL**



SPECIFICATIONS

HAIBO iPenguin P65 GPS SPECIFICATIONS

MODEL	iPenguin P65 GPS
VOLTAGE (V)	12 VOLT
MAX.THRUST (LB)	65LB
MAX.RPM	1650
SPEEDS	VARIABLE
SHAFT LENGTH (IN)	53" /1370mm 72" /1830mm
SHAFT WALL	4.25mm
SHAFT DIAMETER	1.2" /30mm
AVERAGE AMP DRAW (A/H)	25 AMP
MAX AMP DRAW (A/H)	50 AMP
MAX WATTS	420 WATTS
PROP	3 BLADE-WEEDLESS (PITCH 94mm)
REMOTE CONTROL	DIGITAL FOB
FOOT CONTROL	OPTIONAL
MOUNTING	BOW MOUNT XB BRACKET
WIRE GAUGE	10AWG
REQUIRED BATTERY	12v DEEP CYCLE MARINE
MIN. RECOMMENDED BATTERY SIZE	80 - 120 AMP HOUR **
BOAT SIZE	UP TO 500KG
MOTOR WEIGHT	15KG (53") 19KG (72")

** NOTE - this is to be used as a guide only. Check with your battery supplier to confirm required size of 12 volt deep cycle marine battery that will be appropriate for your situation. Your HAIBO iPenguin motor is fitted with built in voltage protection, current protection and overheating temperature control. The use of a circuit breaker is not required.

CHECK CONTENTS

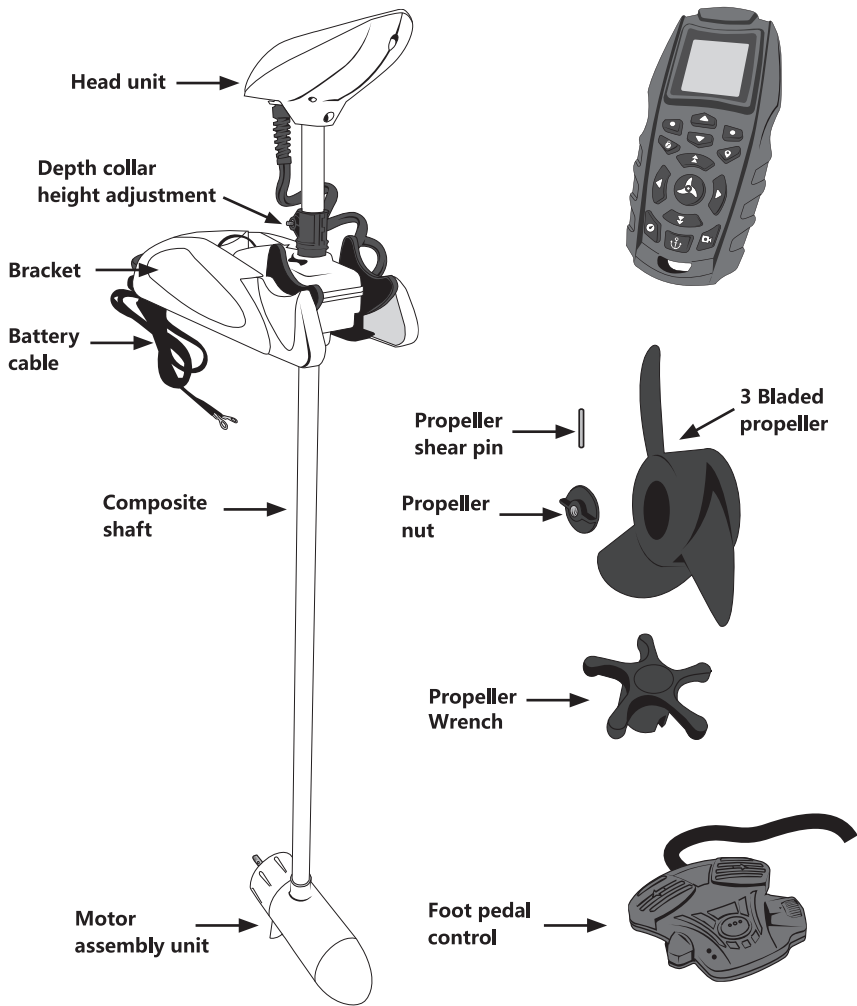

INDEX

INSTALLATION

Pre installation checklist	5
Installation direct mount	6
Installation with optional quick release brackets	8-11

PROPELLER ASSEMBLY	12
---------------------------------	-----------

DEPLOY INSTRUCTIONS	13
----------------------------------	-----------

STOWING INSTRUCTIONS	14
-----------------------------------	-----------

BATTERY AND POWER	15-16
--------------------------------	--------------

REMOTE CONTROL	17-18
-----------------------------	--------------

OPTIONAL FOOT CONTROL INSTRUCTIONS	19
-------------------------------------------------	-----------

GPS FUNCTION USER INSTRUCTIONS

Getting started	20
Initial power up	21-22
Calibrations	23
Manual mode	24
Anchor mode	25
Pilot mode	26
Cruise control	26
GPS speed	27
Course mode	27
Cruise control	27
Track recording	28
Navigate mode	29-30

MAINTENANCE	31-32
--------------------------	--------------

TROUBLE SHOOTING	33-35
-------------------------------	--------------

SERVICING	36
------------------------	-----------

SPARE PARTS AND WHERE TO ORDER THEM	37
--------------------------------------------------	-----------

SCHEMATIC AND PARTS LIST	38-43
---------------------------------------	--------------

PRE INSTALLATION

PRE INSTALLATION CHECKLIST

- Familiarise yourself with this user manual and the various parts of your HAIBO motor, labelled in the illustrations.

- Select desired mounting location on boat

- 12 v deep cycle marine battery (your HAIBO motor is not designed for use with car / truck / motorcycle type batteries) – for more information about appropriate batteries for your HAIBO motor, refer to page 15

Check battery cable length in relation to location of your 12v deep cycle marine battery. If extension to battery cable is required, refer to table on page 15

FITTING THE MOTOR TO THE BOAT

TOOLS REQUIRED

- Power drill,
- 6mm drill bit
- Phillips head screwdriver
- Hex key, 5mm (for optional quick release plate mounting)
- 10mm spanner/shifter
- Prop nut wrench (supplied)
- Marine grease



Spanner/Shifter



Drill Bit



Phillips Head Screwdriver



Hex Key



Power Drill



Marine Grease



Prop Nut Wrench

INSTALLATION

There are 2 ways to attach your motor to your boat.

Option 1 - Direct installation of the motor to your boat without a quick release bracket.

Option 2 - Installation of the motor to you boat with an optional quick release bracket.

Remove side covers to expose mounting plate.
After the Motor is Mounted replace covers.

To remove the side plates remove the head screws as shown. To re-attach the side plate place it into position and resecure screws. Do not over tighten the screws.

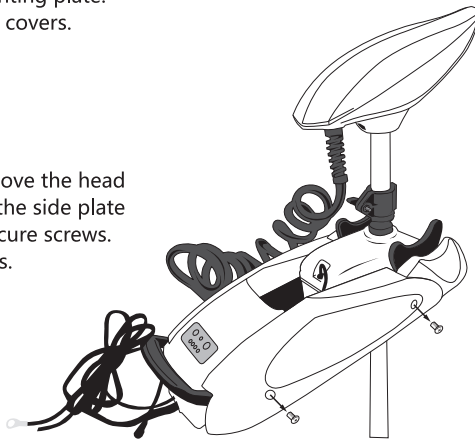

Fit bolts down through mounting plate and foredeck.

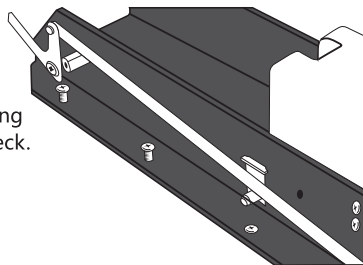

PLEASE NOTE:

HAIBO accepts no liability for personal injury or property damage caused while fitting this motor. Please wear appropriate protective clothing and eyewear/face protection. Avoid contacting and/or inhaling fiberglass dust or aluminum shavings.

INSTALLATION

OPTION 1

ATTACHING THE MOTOR TO YOUR BOAT WITHOUT THE OPTIONAL QUICK RELEASE BRACKET

Before beginning the process of attaching the motor to your boat please ensure the entire HAIBO mount assembly must be mounted in a level, horizontal position as close to the boat's centerline as possible. The HAIBO motor does not necessarily need to face directly forward.

On slightly curved decks, spacer washers or blocks must be used to ensure level mounting of the motor base. In some cases it may be necessary to fabricate a mounting plinth from alloy or fiberglass to provide a level location. If you are unsure please consult your marine technician.

Use 6mm or 1/4" bolts, washers and nylon locking nuts. All fasteners should be of 316-grade stainless steel. On aluminum boats, use thin rubber washers, gasket material or a film of neutral-cure marine silicone to limit bolt contact with alloy to reduce electrolysis.

- 1** "Dry fit" to determine the most suitable position on the boat. Choose a site that offers the least exposure to heavy spray or chance of immersion, especially of the head unit and rear of base mount assembly.
- 2** Remove side plates from the base mount to reveal the six mounting holes. At least four must be fastened to the boat deck with approved bolts, washers and nuts.
- 3** With motor in stowed position, check that no part of the entire assembly, including the shaft and head unit, is obstructed by any part of the boat, eg, rails, seats, opening hatches, etc. Check that no part of boat impedes full deployment of motor.
- 4** Check with the motor in a deployed position that the HAIBO shaft does not come into contact with any part of the hull. Allow at least 30mm clearance from boat gunwale.
- 5** Check with the motor in a deployed position that the propeller and lower unit do not contact any part of the hull through complete 360° rotation.
- 6** Mark potential mounting holes in lower deck. Check that all holes allow access below deck for protruding bolt, washers and spanner. Mark and drill holes.
- 7** Fit at least four bolts down through motor mounting plate and through foredeck. Fit the washers and nylon locking nuts from below. Do not over tighten.
- 8** Apply a light smear of marine grease to pivot points on lock/release lever and turn box pivot points. Replace the side panels.

INSTALLATION

OPTION 2 - (ALLOY QUICK RELEASE BRACKET) ATTACHING THE MOTOR TO YOUR BOAT USING THE OPTIONAL ALLOY QUICK RELEASE BRACKET

Before beginning the process of attaching the motor to your boat please ensure the entire HAIBO mount assembly, including the optional quick-release plate, must be mounted in a level, horizontal position as close to the boat's centerline as possible. The HAIBO motor and quick-release plate do not necessarily need to face directly forward. On slightly curved decks, spacer washers or blocks must be used to ensure level mounting of the motor base and/or lower quick-release plate. In some cases it may be necessary to fabricate a mounting plinth from alloy or fiberglass to provide a level location. If you are unsure please consult your marine technician.

INSTALLATION

The bracket consists of 2 plates, top and bottom. Use the 6 screws (no.3) and washers (no.5) provided to attach the top plate (no.1) to the bottom of your bow mount motor and secure with locknuts (no.4). Use the Screws (no.7) provided to fix the bottom plate to the bow section of your boat.

ATTACHING THE MOTOR TO YOUR BOAT

Rotate the handle (no.8) on the top plate counter clockwise until it stops. Place the top plate (no.1) onto bottom plate (no.6) the two plates will fit into one another. Turn the latch (no.8) clockwise until tight to lock the two plates in place. Seat the latch (no.8) over the top of the shackle (no.9). A padlock can be passed through the shackle (no.9) to secure your motor.

REMOVING THE MOTOR FROM YOUR BOAT

Rotate the latch (no.8) counter clockwise until tight. Slide the motor and lift to remove.

PLEASE NOTE:

HAIBO accepts no liability for personal injury or property damage caused while fitting this motor. Please wear appropriate protective clothing and eyewear/face protection. Avoid contacting and/or inhaling fiberglass dust or aluminum shavings.

INSTALLATION

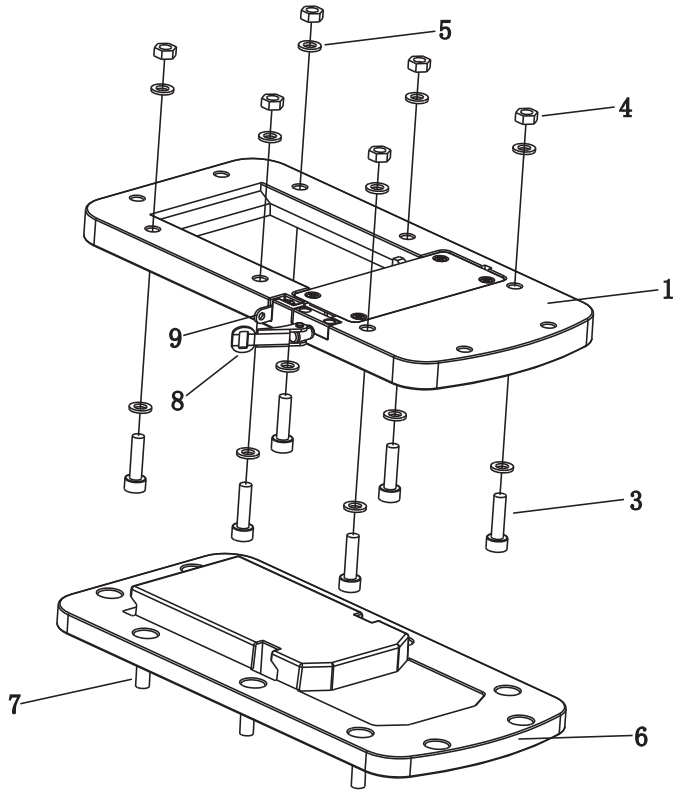

PROPELLER ASSEMBLY

ATTACHING THE PROPELLER

Before doing anything with the propeller, ensure the cables to the battery are disconnected.

1: Place shear pin in shaft as shown.

2: Align the propeller against the shear pin on the shaft (there is a groove on the back of the propeller which the shear pin needs to slot into) and then tighten the propeller nut securely using the propeller wrench. Do not over tighten; check regularly.

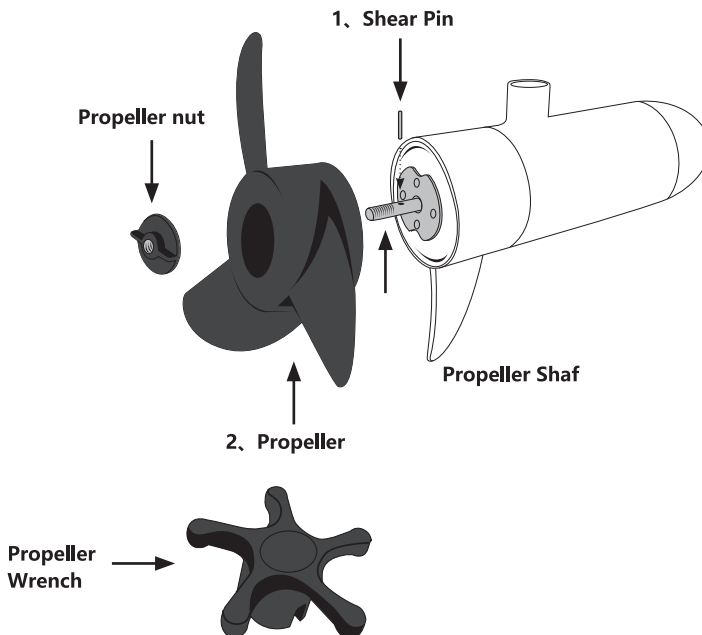

DEPLOYING INSTRUCTIONS

HOW TO DEPLOY YOUR HAIBO BOW MOUNT ELECTRIC MOTOR.

IMPORTANT PLEASE READ BEFORE USE.

Failure to deploy your HAIBO as described below may damage your unit, invalidating its warranty, and could injure you and/or other people.

NOTE – Your HAIBO motor is not designed to release from the cradle by pressing on the release lever alone.

- Slide depth collar up the shaft (towards you) and tighten in operating position.
- Depress release lever (A) to release forward locking cradle and **SIMULTANEOUSLY** slide the shaft (B) forward and down through the turnbox and pivot to lower carefully into the water until depth collar engages with collar on upper turn box.

Pinching hazard. Keep fingers clear of collars.

- Ensure locking level (A) is in the up position and turn box is locked down.
- Adjust depth collar (C) to ensure propeller is completely submerged at all times. Pinching hazard. Keep fingers clear of collars.

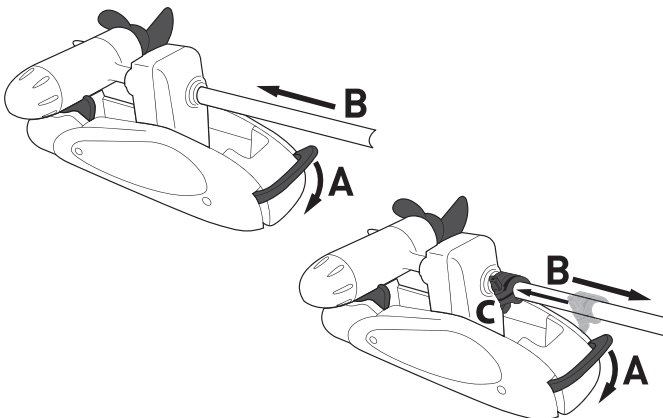

STOWING INSTRUCTIONS

HOW TO STOW YOUR HAIBO IPENGUIN BOW MOUNT ELECTRIC MOTOR.

IMPORTANT PLEASE READ BEFORE USE.

Failure to stow your HAIBO as described below may damage your unit, invalidating its warranty, and could injure you and/or other people.

- Depress and HOLD locking lever (A) and SIMULTANEOUSLY slide the shaft (B) up towards you, through the pivoting turn box. Release locking lever (A) and continue sliding until the propeller unit sits back in the opened locking cradle. There should be a click as cradle locks into Stowed position and the locking lever comes up.
- To prevent accidental deployment, slide the depth collar (C) down the shaft to the turn box and tighten.
- Ensure your motor is properly stowed and secured before high-speed travel on the water or on the road. Additional support of the head unit may be required. HAIBO accepts no liability for injury or damage caused by the incorrect deployment or stowing of this motor.

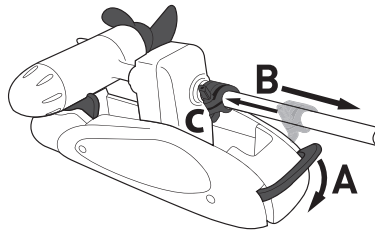

Ensure your motor is properly stowed and secured before driving and or moving your boat to avoid damage.

PLEASE NOTE:

HAIBO Distribution Pty Ltd accepts no liability for injury or damage caused by the incorrect deployment or stowing of this motor.

BATTERY AND POWER

BATTERY TYPE

The precision electronics in this product require a 12-VOLT MARINE DEEP CYCLE BATTERY, optimal size 80-120 amp hours.

Deep cycle marine batteries deliver sustained power with low current draw over extended periods. They can be drained to low levels without developing a “memory” and can be fully recharged hundreds of times over their working lives. A car or truck battery is designed to provide a pulse of “cranking power” over a short period, can develop a “memory” preventing complete recharge and can produce current surges that may damage sensitive electronic components on your HAIBO.

USE OF A NON MARINE DEEP CYCLE BATTERY MAY VOID YOUR WARRANTY.

BATTERY CHARGING

Your HAIBO motor must be disconnected from the battery before charging begins. This includes alternators or any charging systems. HAIBO recommends a “smart” charger capable of recharging a deep cycle battery on at least 8 amps before reverting to a trickle or maintenance phase to maintain complete charging.

VOLTAGE DROP

Should you require a longer cable than is supplied with your HAIBO, you must use wiring of correct gauge.

The greater the distance between battery and motor, the greater the chance of damaging voltage drop, unless the appropriate gauge of wire is used. Below is a guide only.

WIRE EXTENSION LENGTH	SUGGESTED WIRE GAUGE
1m	6 AWG / 6GA
3m	4 AWG / 4GA
6m	2 AWG / 2GA

Your marine technician or auto electrician will be able to advise on your particular setup.

BATTERY AND POWER

CONNECTING YOUR MOTOR TO THE BATTERY

All HAIBO wiring connections should conform to best marine standards. Soldered, sealed and heat-shrink protected. If you doubt your ability to produce quality waterproof connections or lack the equipment, consult a marine technician or auto electrician.

- Your HAIBO comes factory-fitted with a standard length of twin flex wiring with ring terminals to attach to the battery, circuit breaker, fuse, isolator switch or terminal posts.
- Before connecting the motor's cables to the battery terminals, ensure all switches are in the OFF position and stand clear of the propeller.
- Connect the red cable to the positive (+) terminal and the black cable to the negative (-) terminal, making sure the terminals are clean before doing so. A clean connection will minimise power wastage and give you maximum power from the battery.
- Should you require a more convenient wiring connection, HAIBO recommends its 10-gauge 12 volt Trolling Motor Connectors (female part 55506, male 55505).
- Conventional Anderson plugs, provided they are rated over 50 amps, are also popular and effective connections but must be kept clean and corrosion-free.
- When the motor is connected to the battery DO NOT connect any other charging devices to the battery. For example solar chargers or alternators.
- When not in use please make sure that the motor is disconnected from the battery.

REMOTE CONTROLLER

REMOTE CONTROL

Do not attempt to operate Remote Control while outside your floating boat. The Remote unit is splash proof but not submersible. Do not immerse.

Use the lanyard provided to ensure the Remote is at hand whenever required. Do not wipe screen if there is a layer of dried salt, grit or sand on it. Remove gently with a soft, damp cloth to prevent scratching.

Use the neck lanyard for convenience but be careful not to immerse when leaning close to the water.

- The 3 x AAA batteries installed provide up to 100 hours of operation if backlight brightness and timeout are at lowest settings. See Remote section.
- Battery condition indicator is at top right corner of home screen when power is on.
- Battery compartment is on underside and requires head screwdriver. To ensure ultimate reliability, keep spare batteries and suitable screwdriver on board.

REMOTE CONTROL OPERATIONS

BUTTON DESCRIPTION

- 1 Menu left
- 2 Menu up
- 3 Menu right, Power on/off
- 4 Heading Fix/Course Fix on/off
- 5 Menu down
- 6 Navigation function menu
- 7 Propeller acceleration
- 8 Turn left
- 9 Propeller start/stop
- 10 Turn right
- 11 Propeller deceleration
- 12 Cruise Mode start/stop
- 13 Anchor Mode on/off
- 14 Record menu



REMOTE CONTROLLER

SCREEN DISPLAYS

- 1 GPS signal strength
- 2 2.4G signal strength
- 3 12V battery voltage
- 4 remote control battery level
- 5 motor speed 0-10
- 6 propeller start and stop
- 7 Vessel speed (over bottom)
- 8 left menu
- 9 right menu

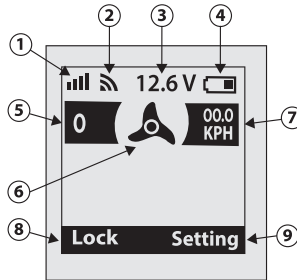

SCREEN DISPLAY ABBREVIATIONS

To Start: When recording or navigating a track the to start location is the beginning of the track.

To End : When recording or navigating a track the to end location is the end of the Track.

Distance (DIST): Distance from the boat' s current location to an Anchor Point or the boat' s location and closest point on a track.

Bearing (BRG): GPS direction from the boat' s current position to a target destination, including a spot or a track.

Heading (HDG): Direction that the motor/boat is pointing or travelling. Distance to go (DTG)When navigating to a Spot, the distance left before the destination is reached . When navigating a track, the distance to go to reach either the start or end location on the track, depending on which direction the track is being navigated.

FOOT PEDAL CONTROLLER

FOOT PEDAL CONTROL SYSTEM (OPTIONAL)

The low profile foot pedal control is used to adjust direction and speed. A variable speed dial control is located at the right side of the foot control box.

(1) Turn the motor to the left by depressing Button 1.

(2) Turn the motor to the right but depressing Button 2.

(3) Use your heel to apply power by depressing Button 3.

(4) Momentary/constant switch. Toggling this switch alternately allows the user to apply power momentarily, whenever the power pedal (3) is held down (adjacent red LED is lit), or constantly, without touching power pedal (adjacent green LED is also illuminated).

(5) Variable speed control dial.

Note: After connecting the foot controller for the first time, please debug the power output knob, and then re-plug and unplug the foot controller cable to activate the foot controller.

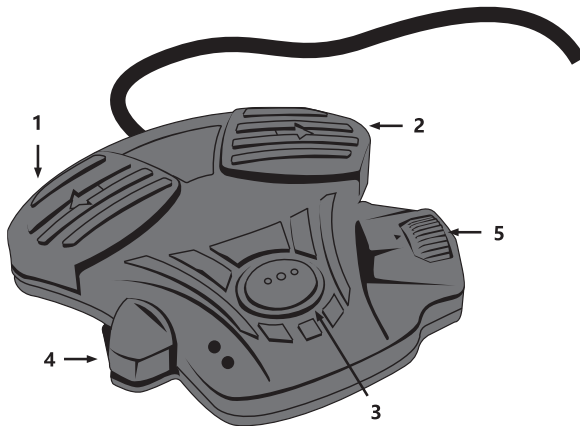

GPS USER INSTRUCTIONS

BEFORE EACH USE

- Ensure that your HAIBO GPS motor is securely attached to your boat.
 - Ensure the 12v deep cycle marine battery is fully charged. (Your HAIBO GPS motor is not designed to be used with a car/truck starting battery).
 - Check battery cable for damage or exposed wiring
 - Check terminals for corrosion or debris
 - Check Remote control has sufficient charge
- (Remote battery indicator is at top Right of active screen).

GPS USER INSTRUCTIONS

INITIAL POWER-UP

- Attach your HAIBO IPENGUIN GPS to a 12 volt marine deep cycle battery.
- Deploy the motor and ensure locking lever is in the up position.

NOTE – Your HAIBO motor is fitted with a tilt switch that prevents the motor from running unless it is in the deployed (vertical) position.

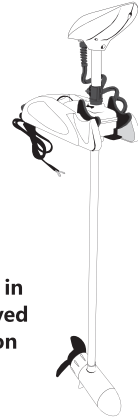

**Motor in
deployed
position**

- Hold down the right-hand button (on/off) on the fascia panel on mount assembly until all the lights illuminate.

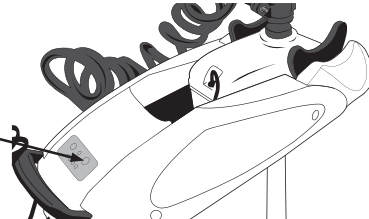

- The four lower LEDs indicate battery condition. They register as green or unlit, depending on charge remaining.

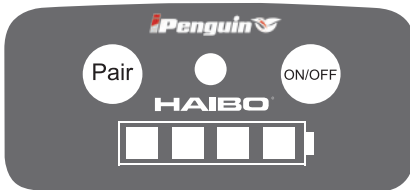

GPS USER INSTRUCTIONS

INITIAL POWER-UP (CONTINUED)

•The upper LED is the unit's Status Light. Its variable color display signals important states of your HAIBO GPS.



•When unit is turned on, Status Light glows YELLOW as unit searches for GPS signals. Superior GPS results occur outdoors, away from tall buildings, bridges etc.

•When unit establishes a GPS connection, usually within a few seconds, status LED FLASHES GREEN, THEN TURNS SOLID GREEN. Unit can be operated by the optional foot pedal only (when cable is connected) at this time.

•Power up Remote control by holding down red Key 3 for two seconds, then release and the screen illuminates. Motor unit should respond with "shave-and-a-haircut" pairing signal. Status light GREEN.

Hold on! Just a few more things..



GPS USER INSTRUCTIONS

CALIBRATIONS, PREFERENCES

•The Remote might now ask you to calibrate steering by activating the grey Turn R or L key for it to establish steering registration. It takes only 10 seconds or so.



Press that red key again to activate the main Menu. Use the adjoining blue up/down keys to scroll through the setup menus.



Using the blue arrow down key, scroll down to boat size and configure boat details. This helps your HAIBO GPS apply just the right amount of initial power to the propeller at all times.

- Small boat = under 3m
- Medium boat = 3m-4m
- Large boat = 4m+

Select boat size with red key, lock it in and get back to the settings menu, again with the left blue key.

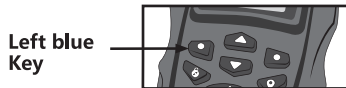

•Scroll to Units and check metric or imperial; press red key to confirm. Default is metric. Press left blue key to get back to main menu and continue scrolling down.

•In the Backlight menu, adjust Timeout and Brightness using red Confirm key. The longer and brighter the remote screen is illuminated, the shorter the Remote battery life. The brighter the day, the brighter the display; go for a dim backlight to retain night vision.

•In the Backlight menu, adjust Auto Off to select your choice of 15 minutes to 120 minutes. Auto Off acts when Remote has been idle for the stipulated time.

GPS USER INSTRUCTIONS

MANUAL MODE - SCREEN DISPLAY

In this mode, the remote function display area is blank. The base unit status light is GREEN. The motor can operate with remote control and optional foot pedal. The optional foot pedal can be switched to constant or momentary. Buttons 7, 8, 9, 10 and 11 control propeller, speed and steering.

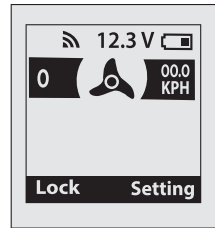

•The middle five grey keys control operation in Manual Mode. Status Light glows GREEN in Manual Mode when controlled by Remote and/or optional foot pedal.

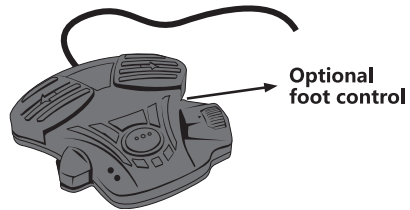
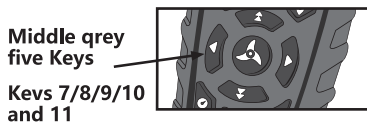

- Remote default at startup is zero power level, propeller stopped.
- Grey arrows up and down progressively increase and reduce power between zero and Level 10. Each increment change produces a short notification tone from the base unit fascia panel.
- L and R turn keys on Remote and Pedal operate as long as they are held down, to a maximum of seven seconds. For further rotation, depress and hold again
- Centre Propeller toggle button applies/halts power to propeller and produces a tone at stop/start.
- Always apply power gradually for smooth operation.
- Optional foot pedal controls also operate in conjunction with manual mode, status light GREEN.

GPS USER INSTRUCTIONS

ANCHOR MODE

Press Anchor mode (Key 13) and the motor enters Anchor mode immediately, referring to GPS position where key was activated. Motor will navigate boat back to position, nominal accuracy 2m in favorable conditions.

Status light is BLUE

Function screen displays distance from anchor point, GPS bearing back to anchor point. Menu screen displays: Exit = exit Anchor mode; Save = save current anchor point. Press Anchor mode key again to exit.

To save a current Anchor spot to memory, ensure Save appears in menu screen display and depress Key 3. Up to 16 spots can be saved.

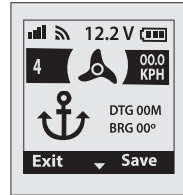

Do not rely on Anchor Mode as your vessel' s sole means of anchoring. Anchor Mode is for short-term position holding in light conditions and is not to be relied on to maintain a vessel' s position in significant current, wind, weather or tide.

A vessel in Anchor Mode is considered by the International Regulations for Preventing Collisions at Sea (Colregs) to be "under way" and should display appropriate lights and practice relevant collision avoidance. Do not use Anchor Mode in busy channels or shipping fairways.

- Anchor Mode is Key 13, at bottom centre, with anchor icon.
- Press once to activate; alert tone should sound, status light should glow steady BLUE and boat should remain within 2m of the point where you hit the Anchor key. Remote display should indicate distance to Spot. It is preferable to slow down before entering Anchor Mode to avoid overrunning the target, as your HAIBO GPS motor returns to the exact position where key was activated.
- To quit Anchor Mode and revert to Manual Mode, press Anchor key 13 again. Exit alert tone will sound, status light will glow GREEN. Power in Manual Mode will default to last power level used in Anchor Mode.
- Fine repositioning adjustments can be made in Manual Mode – then press Anchor key again to anchor at your new location.

Your HAIBO GPS can save up to 16 spots and return to them at any time if they are less than 1km away. See Remote Instructions section for details.

GPS USER INSTRUCTIONS

PILOT MODE

Pilot mode key is Key 4 (with compass icon).

- Pilot mode can be toggled between:
 - Heading mode (the direction the HAIBO IPENGUIN

GPS motor is pointed when Pilot mode key is activated.) Screen function area displays: Heading icon, target heading of motor

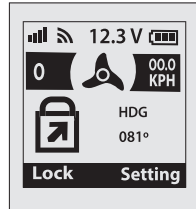

Pilot Mode key is Key 4 (with compass icon).

**Pilot mode
Key 4**



•Pilot mode can be toggled between:

- Heading Mode (the direction the HAIBO IPENGUIN GPS motor is pointed when Pilot Mode key is activated) and
- Course mode (the “true” course bearing as it would appear on a marine chart or GPS plotter screen.)

•You can choose between Heading and Course by selecting in the Fix menu, in the Settings section under the Red key.

•You can use the grey L or R steering keys on your Remote or L or R pedals on optional pedal control to adjust Heading or Course. A new heading direction or course will appear in Remote screen display.

•To quit Pilot Mode, simply press the Pilot mode key again.

•Foot pedal controls also operate in Pilot mode.

Learn how to operate Cruise control in Heading or Course mode by referring to the detailed Remote Instructions section.

GPS USER INSTRUCTIONS

GPS SPEED

The speed readings displayed on your remote indicate speed over the bottom or “speed over ground” and do not reflect the actual speed of your boat through the water. Water speeds are affected by wind, tides, current, wave action and many other variables.

COURSE MODE

(the “true” course bearing as it would appear on a marine chart.)

Screen function area displays:

Course mode icon, course bearing from boat.

- Choose between heading and course by selecting settings section under red Key 3, then fix menu.
- You can use the grey L or R keys to readjust heading or course. A new heading direction or course will appear in the remote screen.
- To quit Pilot mode, simply press the Pilot mode key again.
- Foot pedal controls also operate in Pilot mode.

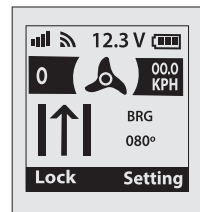

CRUISE CONTROL

Press the cruise key 12 to enter or exit this mode. In this mode, the motor will run at a selected “speed over ground”, ie, GPS speed in relation to the bottom – not the speed in relation to current, wind, tide or other effects on the boat as it travels on the water. Screen Function area displays: current target speed.

To adjust speed in cruise mode, depress grey Speed Up or Speed down keys (Keys 7 and 11). Speed over ground will increase or decrease by 0.2kmh for every keystroke.

Note: Cruise function cannot be started when propeller is not turning. Cruise function can be operated simultaneously with Navigate mode or Course/Heading mode.

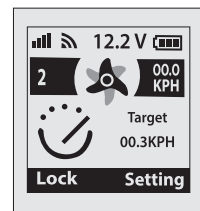

GPS USER INSTRUCTIONS

TRACK RECORDING

Your HAIBO IPENGUIN GPS can record 16 Tracks, each up to 5km long.

To record a track, press Key 14. Select Track number and Confirm Function displays: Distance recorded below Record symbol Menu display: Select Exit to abort route recording; select Finish to save the current recorded route. Remote will ask you to assign a number from 1-16 to your saved track.

To delete an existing track, assign new saved track to that number; ie, overwrite to delete. Track is recorded but speed is not saved. Status light is BLUE.

NOTE: You may record a track while your HAIBO IPENGUIN GPS is simultaneously in Cruise Mode.

NOTE: You may record a track while your HAIBO IPENGUIN GPS is simultaneously in Cruise Mode (Key 12) and Heading/Course Mode. **NOTE:** Anchor Mode and Track Record cannot operate simultaneously.

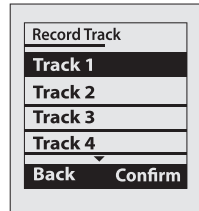

GPS USER INSTRUCTIONS

NAVIGATE MODE

When entering or resuming Navigate Mode, ensure that no hazard such as shallows, snags or rocks lie in a direct path between your vessel and the Spot or Track it is navigating to. If there is a bridge or a waterway surrounded by high buildings between your vessel and the Spot or Track, your HAIBO IPENGUIN GPS also may lose satellite signal and fail to proceed on its navigated course. Maintain a safe speed and keep a proper lookout at all times when in Navigate Mode. Navigate mode enables the user to precisely follow a saved track, turn by turn, up to 5km long. It is particularly helpful for trollers, who can use. Navigate in conjunction with Cruise mode to get 6 perfect lure speed. Lure casters might prefer to use Navigate to work a saved track along a shoreline, adjusting speed manually as they work specific areas before moving on.

Select Navigate mode, Key 6, to enable your HAIBO IPENGUIN GPS motor to navigate back to a saved Spot or Track within 1km away.



- To navigate back to a saved Spot, press Key 6 to enter Navigate mode, then use Menu keys to select the saved Spot number (within 1km away), press Confirm. Select speed, apply power and your HAIBO IPENGUIN GPS will navigate back to that spot. Once reached, it will enter Anchor mode. Function screen displays Spot #, Distance to, Bearing to. Menu screen displays: Back, Confirm.

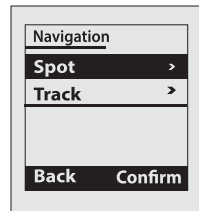

- To navigate back to a saved Track and then follow it, press Key 6 to enter Navigate mode. Then use Menu keys to select Track number, press Confirm, select which way along your chosen track to proceed (start/end), and your HAIBO IPENGUIN GPS will navigate back to the start/end of that track. Once the track end is reached, motor will enter Anchor mode. You can also select other end modes in the Settings menu.

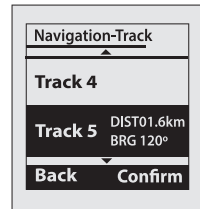

Function screen displays; Spot #, Distance to, Bearing to Menu screen displays: Back, Confirm
NOTE: You may navigate to or along a track or to a spot while your HAIBO IPENGUIN GPS is in Cruise Mode

GPS USER INSTRUCTIONS

NAVIGATE MODE (CONTINUED)

Your HAIBO IPENGUIN GPS will follow a recorded Track from either end by reversing Track Start. Remote screen function area will display length of Track remaining. Each of the 16 savable tracks can be up to 5km long.

NOTE: You may halt progress along your selected track at any time by ceasing to apply power. You may break away from your selected track by pressing the Navigate key again to quit navigate Mode and then enter Manual Mode or Anchor Mode, eg, to fight and land a fish.

To rejoin your track, press Navigate again, select your track number, Confirm, apply power and your HAIBO IPENGUIN GPS will take you back to the closest point on your track and then resume navigation.

Again, ensure no hazard lies in a direct path between your vessel and the Track you intend to resume. Maintain a safe speed and keep a proper lookout at all times.

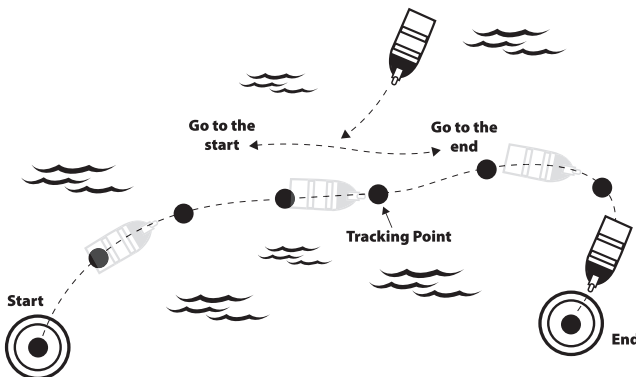

MAINTENANCE

AFTER INITIAL USE

Hulls may flex during operation in rough water and mounting nuts and bolts may take time to “bed in” to secure positions.

- Check your remote control is turned off.
- Disconnect motor from battery.
- If a nylon quick release bracket is fitted, remove locking U-wire on quick-release plate and lift off entire motor.
- For an alloy quick release plate: Remove base mount assembly side plates, check tension of nuts and bolts fastening upper plate to base mount assembly and lower plate to your boat’s foredeck or gunwale. Retighten if necessary.
- For permanent mount: Remove base mount assembly side plates, check tension of nuts and bolts fastening base mount to boat’s foredeck. Retighten if necessary.

AFTER EVERY USE

- Check your remote control is turned off.
- Disconnect motor from battery.
- Recharge battery as soon as possible.
- Rinse your HAIBO motor with a light spray of fresh water, even after freshwater use. Concentrate on areas where salt, dirt and weed fragments are likely to lodge – propeller, motor housing, composite shaft, turn box, depth collar and exposed parts of deck mount assembly.
- Wipe these areas with a cloth soaked in warm soapy water and allow to dry.
- Apply a light coating of a non-staining silicone, petroleum-based or lanolin spray to protect and lubricate exposed parts. Wipe over with a soft, dry cloth.
- Store your HAIBO motor disconnected from its battery.
- Lightly wipe over remote control with a soft, damp cloth, paying particular attention to screen and keypad. Allow to dry and store where you’ll remember it for next time.
- Lightly wipe over foot pedal with a soft, damp cloth.
- If boat is stored outdoors, remove HAIBO and store securely indoors in a cool, dry place. If HAIBO is permanently mounted to the boat outdoors, consider protecting it from harsh sunlight and the elements with a tarpaulin or other cover.

MAINTENANCE

PERIODICALLY DURING THE SEASON

- Disconnect motor from battery. Inspect battery terminals and cables for signs of corrosion. Remove buildup with a small wire brush and treat with anti-corrosion spray.
- Apply a silicone, lanolin or carnauba wax coating to the composite shaft to ensure free running through the turn box.
- Remove left and right side covers from the deck mount assembly with Phillips head screwdriver and remove any dirt, salt, mud or debris inside. Gently rinse with fresh water, allow to dry and apply marine grease to all friction points, such as the stow and deploy mechanism.
- Check for any loose screws/bolts, fasteners in deck mount assembly and upper quick release plate. Retighten as required.
- Remove motor from bottom quick-release plate and check tightness of bolts against fore-deck/gunwale of your boat. Retighten as required.
- Check condition of Remote batteries for corrosion or leakage. Replace if suspect.

END OF SEASON, LONG-TERM STORAGE

- Disconnect motor from battery.
- Inspect battery terminals and cables for signs of corrosion. Remove buildup with a wire brush and treat with anti-corrosion spray.
- Disconnect pedal control.
- Remove batteries from Remote control.
- Remove motor from boat and store in a cool, dry place away from temperature extremes. Cover your HAIBO IPENGUIN GPS motor to prevent dust and dirt buildup.

TROUBLE SHOOTING

A significant number of issues can be caused by a disruption of power supplied to your HAIBO motor. Careful inspection of your 12v deep cycle battery, wiring and set up should be completed before assuming that there is a fault with your motor.

NO POWER / REDUCED POWER

NOTE – Your HAIBO motor is fitted with a tilt switch that prevents the motor from running unless it is in the deployed (vertical) position.

- Check that battery connection has not been reversed (reversed polarity)
- Check that your 12v deep cycle battery is fully charged (+ 12v)
- Check terminals / connections are secure and not loose
- Check terminals / connections for any signs of damage, corrosion or build up of debris
- If battery lead has been extended, ensure correct gauge wire has been used (refer to table on page 15 of manual)
- Remove propeller and check for any build up of fishing line / weed or any other debris
- Check that propeller pin (shear pin) is in place
- Armature or magnet cracked or dislodged – grinding noise will come from motor (CONTACT REPAIR AGENT)

Noise or vibration coming from motor

Check that propeller is securely tightened and shear pin is in place Remove propeller and check for any build up of fishing line / weed or any other debris

- Check that your 12v deep cycle marine battery is fully charged (+ 12v)

Motor will not run at variable speeds

- Check that your 12v deep cycle battery is fully charged (+ 12v)
 - Check terminals / connections are secure and not loose
 - Check terminals / connections for any signs of damage, corrosion or build up of debris
- Ensure motor is on and remote battery has charge

TROUBLE SHOOTING

MOTOR HAS DIFFICULTY STEERING

- Check if coiled power lead from base to motor head is tangled/knotted around shaft. Stop, select Manual Mode and unravel or raise shaft from turn box collar and manually rotate to disentangle.

MOTOR WILL NOT STAY IN ANCHOR MODE

- Check Remote display for GPS signal – top left 4 bars for signal quality. Restart Base Assembly and Remote to establish connectivity and satellite reception.
- Check pairing of Remote and Base Assembly. With power on Remote and Base, press Pairing button on Base housing and await “shave and a haircut” pairing signal.
- Check Anchor mode is engaged.
- Check Anchor spot is within 1km of current position (distance should appear on Remote display).
- Check battery has sufficient power (voltage appears on top line of Remote display).
- Check coiled upper power lead for tangling.
- Check in Remote/Menu/Settings/Boat size that it conforms with your craft.
- Check current, wind, tide conditions are within operational parameters of motor. Motor is unable to hold position if wind/water conditions produce boat drift exceeding potential top speed of motor, eg, around 6kmh..

DIFFICULTY DEPLOYING OR STOWING

- Ensure you follow correct deploy/stow process (refer Stow and Deploy section in this manual. Pages 13 and 14).
- Check for obstructions within the mounting assembly.
- Lubricate shaft with spray lubricant. Concentrate spray on area where shaft runs through turn box.
- Clean any debris from the mounting bracket.
- Remove the side covers from the mounting bracket and apply marine grease to moving parts of the stow/deploy mechanism

TROUBLE SHOOTING

REMOTE CONTROL

- Blank remote screen – not operational – 3 x AAA batteries may need replacement. Phillips head screwdriver required.
- Screen message “No Connection” –
 - x Check Base Unit has powered up and status light shows GREEN x Try restarting base assembly processor and Remote control by
- powering off and restarting each.
 - x Check pairing of remote with base unit by pressing left “Pairing” button on base when remote is on. “Shave-and-a-haircut” peeps indicate pairing established.

OPTIONAL FOOT CONTROL

- Check that remote is selected for manual mode
- Check that foot control cable plug is firmly connected and locked in.
- Check for debris that may affect operation of pedal controls and cable connections.
- Check speed control dial is not set to zero
- Restart base unit and recheck.

SERVICING

SERVICING YOUR HAIBO ELECTRIC MOTOR

When it's time for your HAIBO electric motor to be serviced, it is recommended you choose to use an Authorised Service Agent.

HAIBO electric motors are precision instruments that rely on exacting alignment of numerous components; it is worth considering taking your electric motor to an Authorised Service Agent for servicing.

HAIBO ®

iPenguin GPS

PARTS LIST

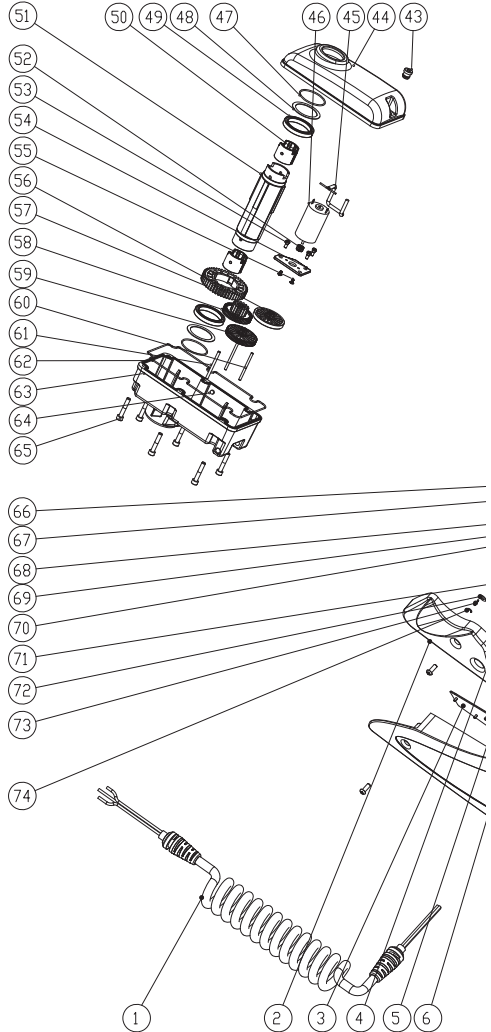

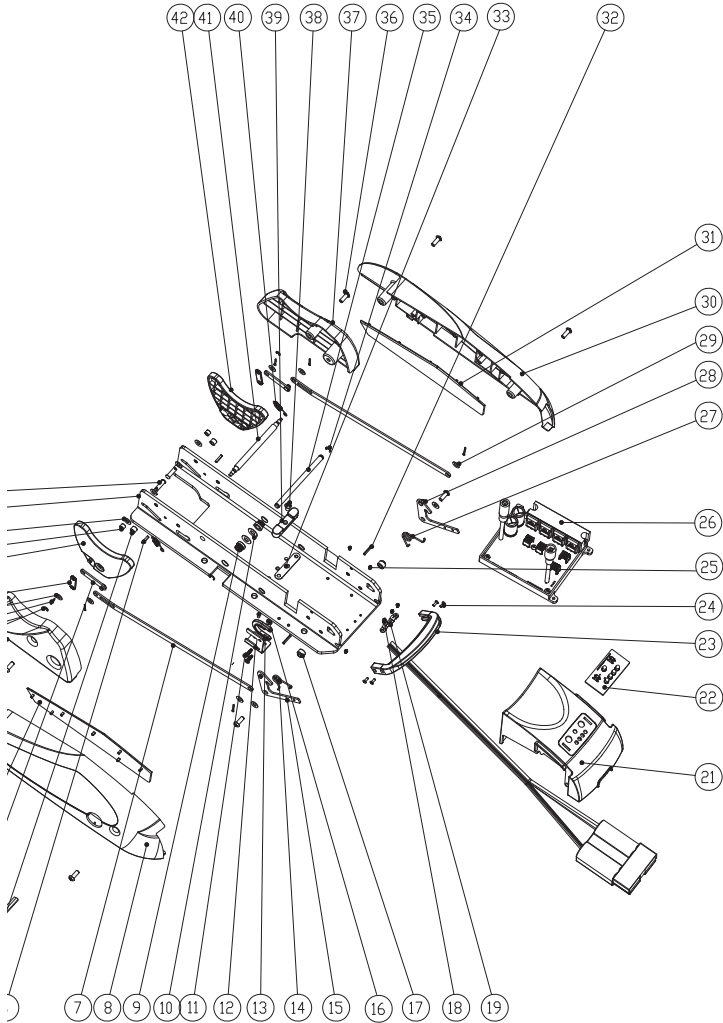

HAIBO[®]

iPenguin GPS

PARTS LIST

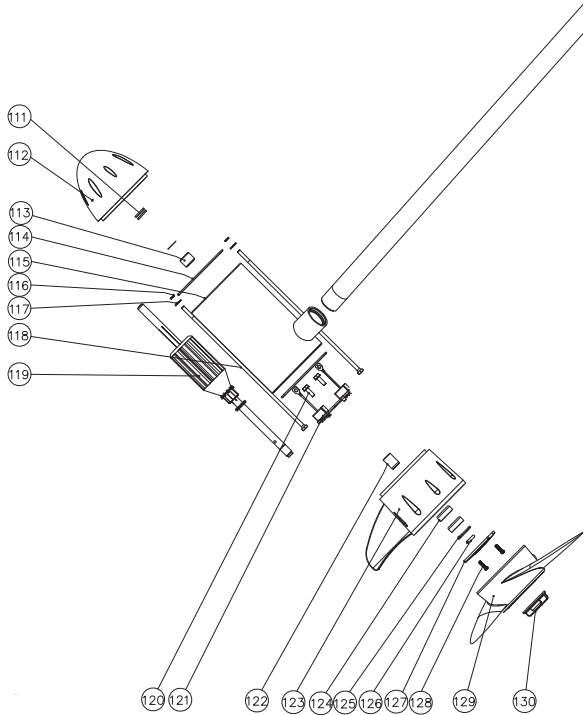
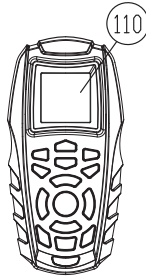

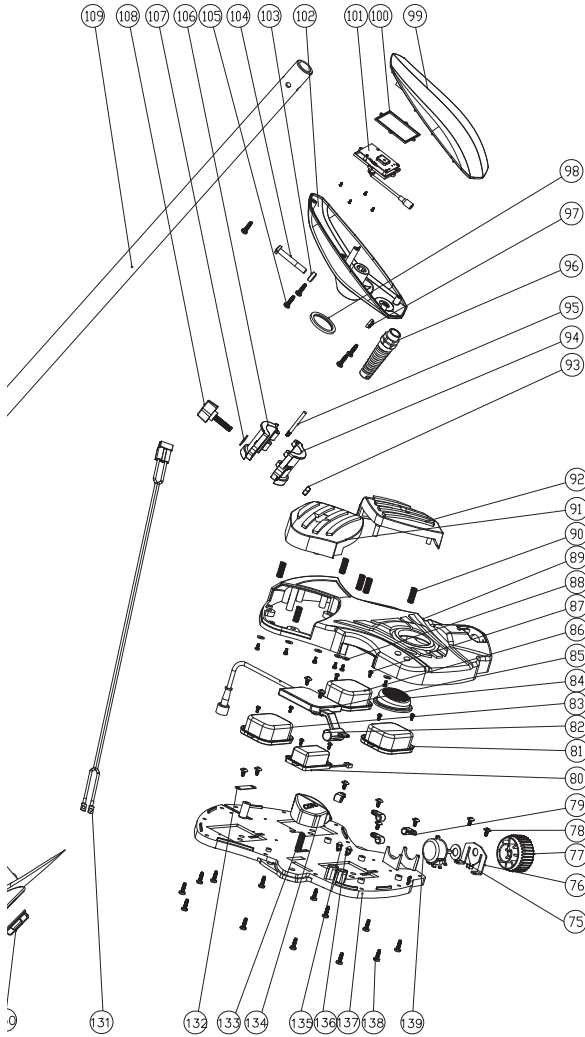

HAIBO

iPenguin GPS PARTS LIST

Key NO	Part Number	Part Description	Key NO	Part Number	Part Description
1	HP6.647.204.000	Helix Cable GPS 螺旋线组件	39	HP8.683.041.00	Bracket Cushion Block GPS 弹性垫块
2	HP8.634.075.70	Bracket Right Side Small Plate XB MKII GPS 前右侧板	40	HP8.381.033.00	Bracket Secondary Rod Tension Spring XB 拉簧
3	HP8.634.084.70	Bracket Right Side Large Plate XB MKII GPS 右面板		MKII GPS	
4	HP6.201.027.00	Bracket Secondary Rod Assembly MKII GPS 二极杆组件	41	HP8.306.071.00	Bracket Axle XB MKII GPS 轴
5	HP8.220.292.00	Bracket Cradle Locating Bush XB MKII GPS 定位套	42	HP6.154.013.00	Bracket Left Cradle Cup XB GPS 左活动板组件
6	HP8.264.160.00	Bracket Cotter Pin XB MKII GPS 开口销 $\phi 3.2 \times 16$	43	HP8.210.332.00	Turning Box Cable Bushing DR RT XB MKII GPS 线护套 5"10
7	HP8.350.013.45	Bracket Pull Spring XB GPS 拉杆	44	HP8.010.062.158	Turning Box Top Cover MKII GPS 转向盒上盖
8	HP8.634.115.70	Bracket Right Side Plate MKII GPS 右侧板	45	HP6.647.201.000	Wire Assembly GPS 二芯线组件
9	HP8.210.484.00	Bracket Connection Nest XB MKII GPS 嵌套	46	HP7.274.005.00	Turning Box Motor-XB MKII GPS 电机
10	HP8.940.375.00	Bracket Axle Washer GPS 齿轮轴华司	47	HP8.662.082.00	Turning Box Sealing Ring XB MKII GPS O型圈 $\phi 42.5 \times \phi 1.8$
11	HP8.903.059.00	Head Unit Buckle Bolt GPS 螺丝	48	HP8.940.746.00	Turning Box Plate XB MKII GPS 耐磨片
12	HP8.611.133.00	Bracket Fixed Mount MKII GPS 固定架	49	HP8.263.067.02	Turning Box Bearing XB MKII GPS 40X52X7 轴承40"52"7
13	HP8.667.036.70	Bracket Fixing Clamp GPS 固定片	50	HP8.210.450.00	Bracket Bushing Advance 70, 95, GPS 衬套
14	HP8.383.127.00	Bracket Left Side Spring XB GPS 左扭簧	51	HP8.210.449.27	Turning Box Gear Bushing XB MKII GPS 套管
15	HP6.154.009.00	Bracket Right Crank Arm MKII GPS 右曲柄组件	52	HP8.415.190.00	Turning Box Brass Gear XB MKII GPS 小齿轮
16	HP8.902.256.00	Bracket Mount Bolt XB GPS 螺钉M4*8	53	HP8.904.072.45	Turning Box Bolt XB MKII GPS 螺钉
17	HP8.210.336.00	Bracket Crank Shaft Sleeve DRXB MKII GPS 曲柄套筒	54	HP8.610.119.24	Turning Box Fixed Plate XB MKII GPS 定位板
18	HP8.902.017.00	Bracket Screw MKII GPS 线筒滴管支架螺丝	55	HP8.902.025.00	Turning Box Fixed Plate Bolt XB MKII GPS 侧盖螺丝
19	HP8.610.193.00	Bracket Pressed Plate MKII GPS 压板	56	HP6.371.016.00	Turning Box Gear XB MKII GPS 齿轮
20	HP6.647.252.000	Battery Cable GPS 电线组件	57	HP8.415.193.00	Turning Box Gear (1) XB MKII GPS 齿轮
21	HP8.010.105.070	Bracket Front Cover GPS 前盖	58	HP8.415.192.00	Turning Box Gear (2) XB MKII GPS 齿轮
22	HP6.672.113.000	Bracket Display Assembly GPS 显示板组件	59	HP8.415.191.00	Turning Box Small Gear XB MKII GPS 齿轮
23	HP8.335.001.00	Bracket Foot Lever XB GPS 踏板	60	HP8.264.412.45	Turning Box Pin XB GPS 销子
24	HP8.902.201.45	Bracket Bolt M3 x 8mm XB GPS 螺钉M3*8	61	HP8.264.412.45	Turning Box Pin GPS 销子
25	HP8.902.024.00	Bracket Screw GPS 螺丝	62	HP8.683.098.00	Turning Box Sealing Ring MKII GPS 密封圈
26	HP6.702.091.000	Module Control GPS 驱动控制器	63	HP8.010.063.158	Turning Box Bottom Cover MKII GPS 转向盒下盖
27	HP8.383.128.00	Bracket Right Side Spring XB GPS 右扭簧	64	HP8.530.046.06	Box Plate MKII GPS 磁碟
28	HP8.940.081.00	Bracket Washer GPS 华司 0.5	65	HP8.902.207.00	Box Bottom Cover Bolt-QRB Bolt XB MKII 螺栓M6*41
29	HP6.154.008.00	Bracket Left Crank Arm MKII GPS 左曲柄组件	66	HP8.264.417.45	Secondary pin 二极杆销
30	HP8.634.114.70	Bracket Left Side Plate MKII GPS 左侧板	67	HP8.601.075.27	Bracket Frame Assembly GPS 底板
31	HP8.634.083.70	Bracket Left Side Large Plate XB GPS 左面板	68	HP8.940.091.00	Bracket Rocker Arm Washer XB MKII GPS 摇臂套筒华司
32	HP8.264.162.00	Bracket Cotter Pin XB MKII GPS 开口销 $\phi 3.2 \times 19$	69	HP8.220.396.00	Bracket Bushing XB MKII GPS 衬套
33	HP8.941.178.00	Bracket gasket GPS 垫片	70	HP6.154.014.00	Bracket Right Cradle Cup XB GPS 右活动板组件
34	HP8.245.079.00	Turning Box C-Ring DR RT MKII GPS C型扣环	71	HP8.350.002.45	Bracket Push Rod XB GPS 推杆
35	HP8.303.025.45	Bracket Axle XB MKII GPS 旋转轴	72	HP8.940.056.00	Bracket Stay Rod Pin Washer GPS 华司
36	HP8.902.196.00	Bracket Crank Arm Bolt DR XB GPS 圆头十字螺钉 M6*16	73	HP8.264.569.00	Bracket Cotter Pin XB MKII GPS 开口销
37	HP8.634.074.70	Bracket Left Side Small Plate XB GPS 左前侧板	74	HP8.245.078.00	Bracket C-Ring DRWB Bracket GPS C型扣环
38	HP8.902.384.45	Bracket Block Bolt MKII GPS 螺丝	75	HP8.946.011.07	Foot Control Lock Washer DR XB GPS 锁紧华司
MKII GPS					
76	HP8.611.132.45	Foot Control Fixed Mount MKII GPS 固定架	N/L	HP6.257.011.00	Depth Collar Kit 30mm XB GPS 深度调节环组件
77	HP8.350.030.00	Foot Control Speed Control Knob MKII GPS 调速把手	93	HP8.379.073.00	Depth Collar Nut XB GPS 螺母
78	HP8.903.050.00	Foot Control Bolt RT XB MKII GPS 万向度螺丝	94	HP8.242.152.00	Depth Collar Left Side XB GPS Bow Mount 深度调节环左体
79	HP8.667.031.00	Foot Control Buckle GPS 线扣	95	HP8.264.468.00	Depth Collar Pin Bow Mount 销子
80	HP6.618.026.000	Foot Control Switch Assy GPS 切换开关组件	96	HP8.354.019.000	Head Unit Cable Connector GPS 电缆固定头
81	HP6.618.027.000	Foot Control Jog Switch Assembly GPS 点动开关组件	97	HP6.482.000.00	Head Unit Lock Nut GPS 定制1/4防松螺母
82	HP8.350.031.00	Foot Control Connecting Rod MKII GPS 连接杆	98	HP8.662.014.00	Head Unit Seal Ring GPS 密封圈
83	HP8.618.025.000	Foot Control Switch Assembly Left Turn GPS 左转开关组件	99	HP8.076.336.070	Head Unit Top Cover GPS 上盖
84	HP8.337.132.00	Foot Control Power Button MKII GPS 点动按钮	100	HP8.683.137.000	Head Unit GPS Seal Ring 密封圈
85	HP6.702.059.00	Foot Control Complete Unit GPS 脚踏控制器	101	HP6.702.092.000	Head Unit Head GPS Controller/GPS控制器
86	HP6.618.024.000	Foot Control Switch Assembly Right Turn GPS 右转开关组件	102	HP8.076.337.070	Head Unit Bottom Cover GPS 下盖
87	HP8.903.048.00	Foot Control Screw MKII GPS 螺丝	103	HP8.220.378.70	Head Unit Sleeve GPS 衬套
88	HP8.940.344.00	Foot Control Washer MKII GPS 华司	104	HP8.926.045.00	Head Unit Shaft Bolt MKII GPS 万向螺栓
89	HP8.601.073.00	Foot Control Top Cover MKII GPS 上板组件	105	HP8.903.059.00	Head Unit Screw GPS 螺丝
90	HP8.382.263.45	Foot Control Button Spring MKII GPS 弹簧	106	HP8.242.153.00	Depth Collar Right Side XB GPS Bow Mount 深度调节环右体
91	HP8.337.130.071	Foot Control Left Button MKII GPS 左按钮	107	HP8.940.313.00	Depth Collar Washer 垫圈
92	HP8.337.131.071	Foot Control Right Button MKII GPS 右按钮	108	HP6.480.014.00	Depth Collar Fastener 螺栓

HAIBO

iPenguin GPS PARTS LIST

Key NO	Part Number	Part Description
109	HP6.657.142.999	Shaft 030mm 53' White Alloy/Composite GPS 白色复合管 Φ30*1370
	HP6.657.157.999	Shaft 030mm 72' White Alloy/Composite GPS 白色复合管 Φ30*1830
110	HP6.789.006.000	Remote Controller GPS 遥控器YK-5
111	HP6.260.000.000	Lower Unit Thrust Bearing GPS 推力轴承
112	HP8.010.071.158	Lower Unit Rear Cover GPS 后盖
113	HP8.251.001.000	Lower Unit Rear Bearing GPS 含油轴承
114	HP8.662.016.000	Lower Unit O-Ring DRXB MKII GPS 80±0.3×1.8±0.05
115	HP6.652.015.020	Lower Unit Rotor Assembly GPS 定子装配件
116	HP8.662.015.000	Lower Unit Mini-O-Ring DR VB MKII GPS 4.2(+0.2)×1.5(+0.1)
117	HP8.610.049.000	Lower Unit Hex Washer RT XB MKII GPS 六角垫圈
118	HP8.926.018.000	Lower Unit Connecting Rod XB MKII GPS 连杆螺栓
119	HP6.656.022.000	Lower Unit Rotor 65 转子装配件
120	HP8.903.060.070	Lower Unit Brush Bolt 螺 丝
121	HP6.670.095.000	Lower Unit Brush Frame Assembly GPS 电刷架装配件
122	HP8.251.000.000	Lower Unit Front Bearing 含油轴承
123	HP8.010.070.158	Lower Unit Front Cover GPS 前盖
124	HP6.475.000.000	Lower Unit Sealing Ring 密封胶圈
125	HP8.683.049.450	Lower Unit Retaining Ring Hawser GPS 挡圈
126	HP8.264.157.000	Prop Shear Pin 30lb, 34lb, 44lb, 54lb, 65lb 圆柱销
127	HP7.690.001.000	Lower Unit Anode 阳极保护块
128	HP8.903.187.000	Lower Unit Anode Bolt GPS 三角牙自攻螺丝
129	HP6.393.001.000	Prop 3-Bladed 44,54,65lb - refer 55130 螺旋桨装配件
130	HP6.482.001.000	Prop Nut 34,44,54,65 螺旋桨螺母
131	HP6.647.202.000	Battery Anderson Plug Connector 主电源线组件
132	HP8.263.076.450	Foot Control Pressed Plate MKII GPS 压片
133	HP8.382.253.000	Foot Control Compression Spring MKII GPS 弹簧
134	HP8.337.133.071	Foot Control Continuous Switch MKII GPS 连续按钮
135	HP6.794.002.000	Foot Control Indicator Light Red MKII GPS 红色指示灯
136	HP6.794.003.000	Foot Control Indicator Light Green MKII GPS 绿色指示灯
137	HP8.601.074.000	Foot Control Bottom Plate MKII GPS 底板
138	HP8.903.059.000	Head Unit Buckle Bolt GPS 螺丝
139	HP6.630.022.000	Foot Control Potentiometer Assembly GPS 电位器组件