

**ERSATZTEILLISTE
FÜR FESTBRENNSTOFFHERDE
TYP K 185 F 7 kW**

ART.NR.	BEZEICHNUNG	
	RECHTS	
G001856210	K185F/A 2012, WESTM.RE, WEIß, 7KW, R.SCHWZ, BE.CHR	
G001856260	K185F/A 2012, WESTM.RE, CAPPU, 7KW, R.SCHWZ, BE.CHR	
G001856280	K185F/A 2012, WESTM.RE, ANTHR, 7KW, R.SCHWZ, BE.CHR	
G001856285	K185F/A 2012, WESTM.RE, NATURSTEIN, 7KW, BE.CHR	
G001856290	K185F/A 2012, WESTM.RE, KER.BORD, 7KW, R.SCH, BE.CHR	
G001856295	K185F/A 2012, WESTM.RE, KER.ANTIK, 7KW, R.SCH, BE.CHR	
	LINKS	
G001856310	K185F/A 2012, WESTM.LI, WEIß, 7KW, R.SCHWZ, BE.CHR	
G001856360	K185F/A 2012, WESTM.LI, CAPPU, 7KW, R.SCHWZ, BE.CHR	
G001856380	K185F/A 2012, WESTM.LI, ANTHR, 7KW, R.SCHWZ, BE.CHR	
G001856385	K185F/A 2012, WESTM.LI, NATURSTEIN, 7KW, BE.CHR	
G001856390	K185F/A 2012, WESTM.LI, KER.BORD, 7KW, R.SCH, BE.CHR	
G001856395	K185F/A 2012, WESTM.LI, KER.ANTIK, 7KW, R.SCH, BE.CHR	

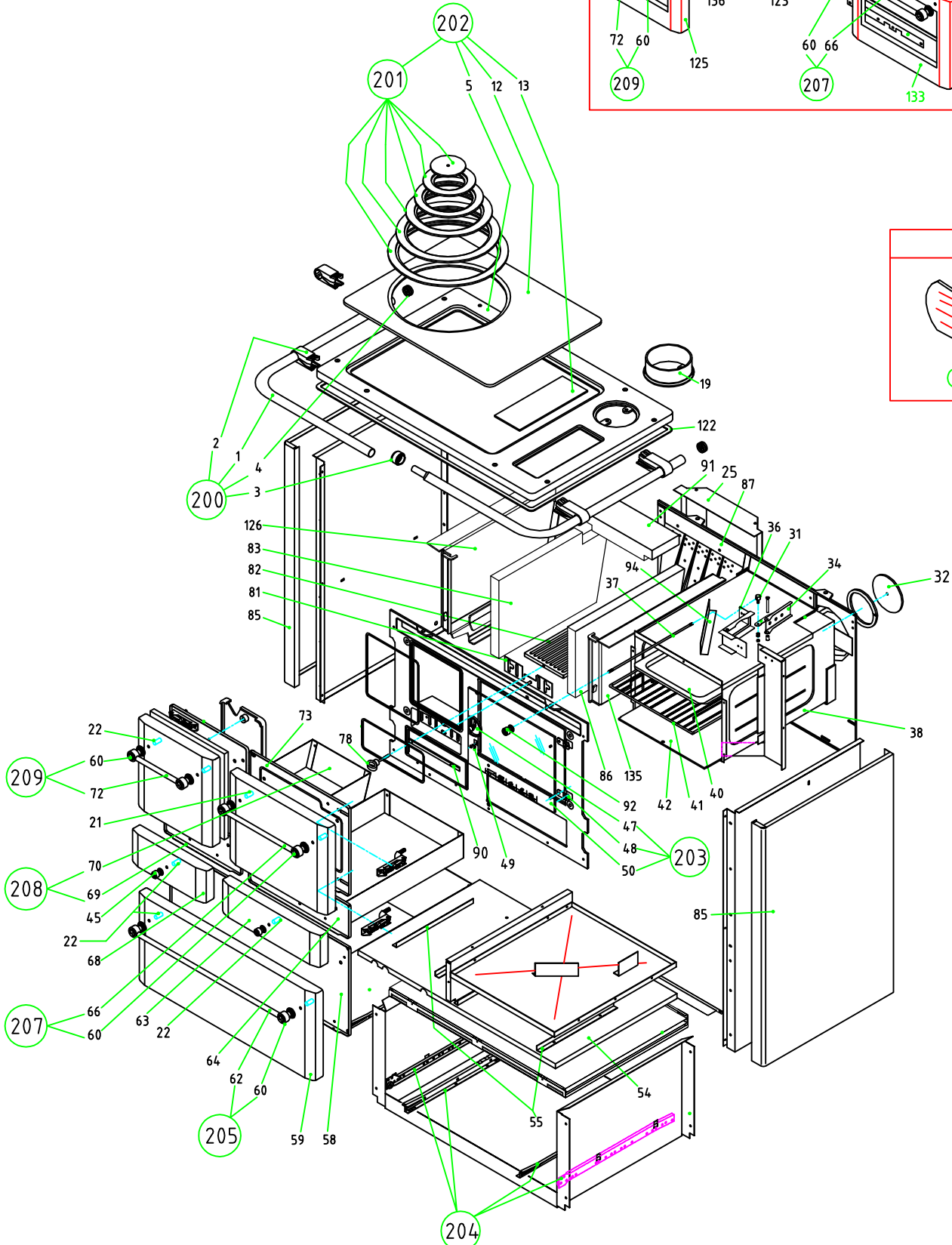
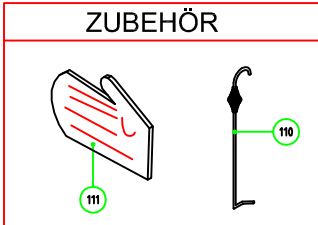
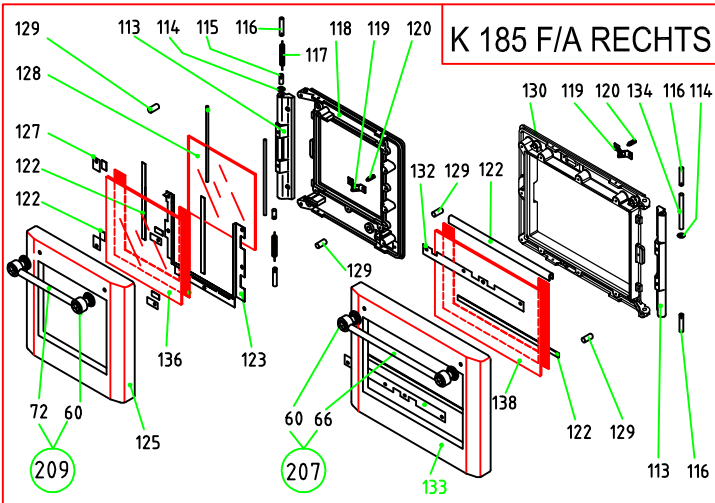

ZEICH. NR.	ART. NR.	BESCHREIBUNG K 185 F/A 7kW RECHTS	09.2015	EAN	PG	GEWICHT kg	
1	H185710001	HERDSTANGE 2-TEILIG K185F	02.077	4025144950468	XA	0,544	
2	H185710002	HERDSTANGENHALTER	37.048	4025144950475	LA	0,048	
3	H185710003	HERDSTANGE VERBINDUNGSTEIL	69.803	4025144950482	OA	0,068	
4	H185710004	HERDSTANGE ENDSTÜCK	37.047	4025144950499	EA	0,006	
5	H185710005	HERDRAHMEN RECHTS	89.007	4025144950505	HB	10,000	
12	H185710012	HERDPLATTE	91.007	4025144950512	HB	8,700	
13	H185710013	WASSERSCHIFF ABDECKPLATTE	08.007	4025144950529	OA	0,800	
19	H185710019	ABGASSTUTZEN	24.007	4025144950598	QA	0,900	
21	H185710021	DISTANZROHR I. 26 K185F		4025144950604	AA	0,002	
22	H185710022	DISTANZROHR I. 30 K185F		4025144950611	AA	0,002	
25	H185710136	STRAHLSCHUTZBL. HINTEN GESCH. K185 F/A		4025144970602	RA	0,570	
31	H185710031	STIFT F.ANHEIZKLAPPE.F.K185F		4025144950635	FA	0,008	
32	H185710032	VERSCHLUSSDECKEL ABGASANSCHLUSS	01.085	4025144950642	LA	0,510	
34	H185710034	ANHEIZKLAPPE F.K185F	401.086	4025144950666	MA	0,230	
36	H185710036	ANHEIZKLAPPENLAGER	K185 401.150	4025144950680	MA	0,350	
37	H185710037	BETÄTIGUNGSSTANGE F.ANHEIZKLAPPE	02.075	4025144950697	EA	0,064	
38	H185710038	BRATROHR SEITENTEIL K185F	630.232	4025144950703	GB	2,990	
40	H185710040	BACKBLECH K185F		4025144950727	TA	0,700	
41	H185710041	BRATROST K185F	001.024	4025144950734	QA	0,500	
42	H185710011	STAHLPLATTE F.BRATROHR	F.K185F	4025144968104	DB	5,700	
45	H185710045	GRIFF F.ASCHEN-WÄRMEFACH K185	502.068	4025144950758	JA	0,096	
47	H185710047	BRATROHR TERMOMETER K185F	08.028	4025144950772	JA	0,014	
48	H185710048	SCHARNIER F.GLAS-BRATROHRTÜR	06.011	4025144950789	FA	0,008	
49	H185710149	SPERRFEDER F.GLAS-BRATROHRTÜR	38041521	4025144994936	LA	0,005	
50	H185710050	GLAS-BRATROHRTÜR K185F	003.024 RECHTS	4025144950802	TA	1,030	
54	H185710181	BODENBLECH RECHTS K185 F/A	RECHTS	4025144970947	YA	2,450	

ZEICH. NR.	ART. NR.	BESCHREIBUNG K 185 F/A 7kW RECHTS	09.2015	EAN	PG	GEWICHT kg	
55	H185710055	WÄRMEFACH FÜHRUNGSLEISTE K185 F/A		4025144950840	HA	0,464	
58	H185710058	HOLZLAGERFACH VORDERWAND 83.900		4025144950871	WA	1,500	
59	H185710059	HOLZLAGERFACH BLENDE BLAU 10.700		4025144950888	BB	1,770	
59	H185711059	HOLZLAGERFACH BLENDE ANTHRAZIT 10.609		4025144950895	VA	1,770	
59	H185716059	HOLZLAGERFACH BLENDE WEIß		4025144995018	AB	1,770	
59	H185712059	HOLZLAGERFACH BLENDE CAPPUCCINO 10.402		4025144959959	AB	1,770	
60	H185710060	GRIFFHALTER K185F 502.067		4025144950901	MA	0,096	
62	H185710062	HOLZLAGERFACH GRIFFSTANGE 02.073		4025144950925	NA	0,200	
63	H185710063	WÄRMEFACH BLENDE BLAU 08.700		4025144950932	TA	0,430	
63	H185711063	WÄRMEFACH BLENDE ANTHRAZIT 08.609		4025144950949	RA	0,380	
63	H185716063	WÄRMEFACH BLENDE WEIß		4025144994998	SA	0,430	
63	H185712063	WÄRMEFACH BLENDE CAPPUCCINO 08.402		4025144959966	SA	0,430	
64	H185710140	WÄRMEFACH VORWAND RE K185 F/A RECHTS		4025144970633	KA	0,400	
66	H185710066	BACKFACH GRIFFSTANGE K185F 502.071		4025144950970	LA	0,100	
68	H185710068	ASCHENBEHÄLTER BLENDE BLAU K185F		4025144950987	TA	0,380	
68	H185711068	ASCHENBEHÄLTER BLENDE ANTHRAZIT K185F		4025144950994	RA	0,380	
68	H185716068	ASCHENBEHÄLTER BLENDE WEIß		4025144995001	SA	0,380	
68	H185712068	ASCHENBEHÄLTER BLENDE CAPPUCCINO 07.402		4025144959973	SA	0,380	
69	H185710141	ASCHENBEHÄLTER VORD. RE K185 F/A RECHTS		4025144970640	KA	0,280	
70	H185710070	ASCHENBEHÄLTER MANTEL 37.085		4025144951014	XA	1,080	
72	H185710072	FEUERRAUM GRIFFSTANGE K185F 502.070		4025144951021	LA	0,070	
78	H185710078	ASCHENTRÜTTLER STAB K185 401.083		4025144951045	MA	0,010	
81	H185710081	LUFTREGULIERUNGSBLECH 67.003		4025144951076	OA	0,036	
82	H185710082	ROST 01.080		4025144951083	RA	1,620	
83	H185710143	VERMIKULITPLATTE SEITENWAND K185 F/A		4025144970664	XA	1,800	
85	H185710085	SEITENWAND LINKS/RECHTS BLAU 05.700		4025144951113	FB	3,460	

ZEICH. NR.	ART. NR.	BESCHREIBUNG K 185 F/A 7kW RECHTS	09.2015	EAN	PG	GEWICHT kg	
85	H185711085	SEITENWAND LI/RE ANTHRAZIT 05.609		4025144951120	FB	3,460	
85	H185716085	SEITENWAND LI / RE WEIß		4025144994943	FB	3,460	
85	H185712085	SEITENWAND LI /RE CAPPUCCINO 05.402		4025144959980	FB	3,460	
86	H185710182	VERMIKULITPLATTE BACKRAUMSEITE K185 F/A		4025144970954	BB	2,130	
87	H185710087	FEUERRAUM RÜCKWAND RECHTSK185F 401.082		4025144951144	LB	21,400	
90	H185710144	BÜGEL FÜR VORWAND DICHTUNG K185 F/A		4025144970671	GA	0,250	
91	H185710165	VERMIKULITPLATTE OBEN K185 F/A		4025144970688	XA	0,730	
92	H185710092	ZUGKNOPF ANHEIZKLAPPE 02.186		4025144951199	JA	0,032	
94	H185710094	ABGASUMLENKUNG 90.018		4025144951212	LA	0,070	
110	H185710110	SCHÜRHAKEN 07.007		4025144951243	LA	0,700	
111	H185710111	HANDSCHUH F.K185F 004.186		4025144951250	LA	0,055	
113	H185710113	GEGENSCHARNIER HEIZTÜR K185F 401.130.007		4025144951274	QA	0,600	
114	H185710114	SCHEIBE D15X8,5X1 02.073		4025144951281	AA	0,001	
115	H185710115	SCHANIERSTIFFT D8 02.164		4025144951298	BA	0,009	
116	H185710116	SCHANIERSTIFFT SECHSKANTIG 02.163		4025144951304	BA	0,011	
117	H185710117	TORSIONSFEDER 04.030		4025144951311	JA	0,040	
118	H185710118	HEIZTÜRRAHMEN IN GUß RE. 31.007		4025144951328	BB	2,700	
119	H185710119	VERSCHLUSSFEDER HEIZTÜR 04.031		4025144951335	LA	0,008	
120	H185710120	VERSCHLUSSSTIFFT HEIZTÜR 02.165		4025144951342	CA	0,016	
122	H185710122	SELBSTKLEB.GLASFASER BAND 10X3 04.105		4025144951366	KA	0,002	
123	H185710135	GLAS BEFESTIGUNGSWINKEL KO.F.K185F RE.		4025144956057	PA	0,090	
125	H185710125	HEIZTÜR TÜRBLENDE BLAU RE. 68.700		4025144951397	XA	0,600	
125	H185711125	HEIZTÜR TÜRBLENDE ANTHRAZIT RE. 68.609		4025144951403	UA	0,600	
125	H185716125	HEIZTÜR TÜRBLENDE WEIß RE.		4025144994950	VA	0,600	
125	H185714125	HEIZTÜR TÜRBLENDE CAPPUCCINO RE. 68.402		4025144959997	VA	0,600	
126	H185710147	HEIZRAUMBLECH LINKS K185 F/A RECHTS		4025144970695	EB	5,270	

ZEICH. NR.	ART. NR.	BESCHREIBUNG K 185 F/A 7kW RECHTS	09.2015	EAN	PG	GEWICHT kg	
127	H185710127	GLAS BEFESTIGUNGSPLÄTTCHEN 688.033		4025144951427	AA	0,010	
128	H185710128	HEIZTÜR KERAMIKFENSTER 03.115		4025144951434	BB	0,400	
129	H185710129	ABSTANDSROHR F.K185 502.181		4025144951441	AA	0,100	
130	H185710130	BRATROHR GEGENTÜRE (NEU) K185F 61.007		4025144951458	CB	4,000	
133	H185710133	BRATROHR TÜRBLENDE BLAU RE. K185F		4025144951489	XA	0,600	
133	H185711133	BRATROHRTÜRBLEND.ANTHRAZIT R.658.069.609		4025144951496	VA	0,600	
133	H185716133	BRATROHR TÜRBLENDE WEIß RE.		4025144994967	VA	0,600	
133	H185714133	BRATROHR TÜRBLENDE CAPPUCCINO RE. 69.402		4025144960009	VA	0,600	
134	H185710134	BRATROHRTÜR SCHARNIERSTIFFT 02.162		4025144951502	DA	0,030	
135	H185710148	HEIZRAUMBLECH RECHTS K185 F/A RECHTS		4025144970701	FB	4,760	
136	H185710124	HEIZTÜR BOROFLOAT GLAS		4025144951380	CB	0,350	
138	H185710131	BRATROHRTÜR BOROFLOAT GLAS K185F		4025144951465	CB	0,450	
200	H185710200	HERDSTANGE KOMPLETT 00.013		4025144951519	EB	0,550	
201	H185710201	RINGSATZ HERDPLATTE D330 17.007		4025144951526	DB	4,500	
202	H185710202	HERDPLATTE KOMPLETT RE. 00.013		4025144951533	RB	24,000	
203	H185710203	GLASTÜR BRATROHR KPL.RE. K185F 000.176		4025144951540	VA	1,100	
204	H185710145	HOLZFACHSCHIENEN KOMPL.AB F.NR.1118X2011		4025144970800	XA	0,550	
205	H185710205	HOLZLAGERFACH HANDGRIFF KOMPLETT 00.154		4025144951564	OA	0,300	
207	H185710207	BRATROHR HANDGRIFF KOMPLETT K185F 000.153		4025144951588	VA	0,900	
208	H185710208	ASCHENBEHÄLTER KOMPLETT RE. K185F		4025144951595	BB	1,530	
209	H185710209	HEIZTÜR HANDGRIFF KOMPLETT 00.152		4025144951601	TA	0,750	







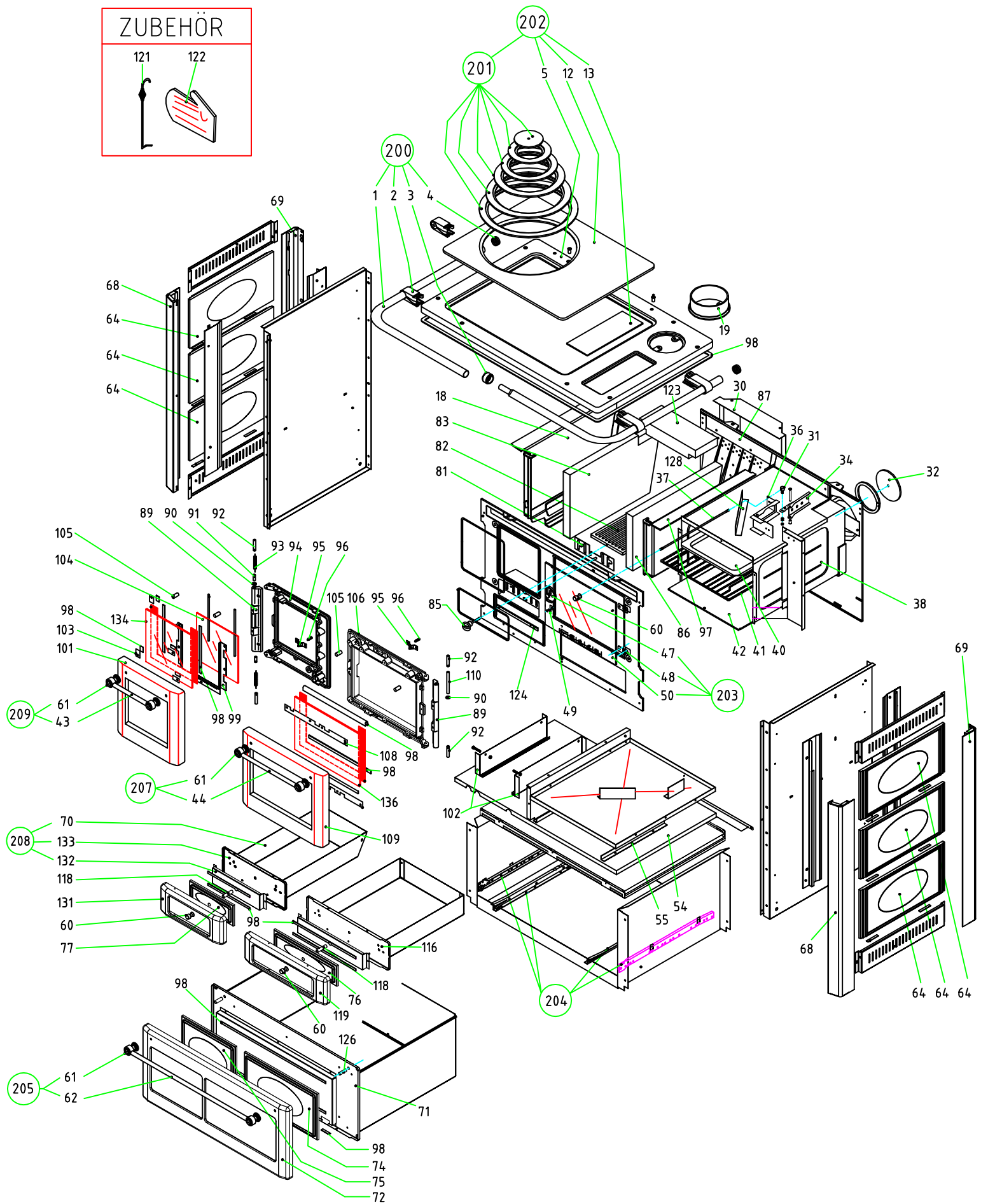
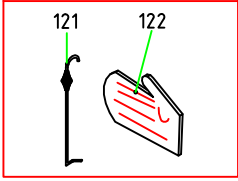







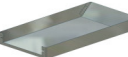

STAND 09.2015

K185 F/A RECHTS NS/KERAMIK

ZUBEHÖR



ZEICH. NR	ART. NR.	BESCHREIBUNG K 185 F/A 7kW RECHTS NS / KERAMIK	09.2015	EAN	PG	GEWICHT kg	
1	H185710001	HERDSTANGE 2-TEILIG K185F 02.077		4025144950468	XA	0,544	
2	H185710002	HERDSTANGENHALTER 37.048		4025144950475	LA	0,048	
3	H185710003	HERDSTANGE VERBINDUNGSTEIL 69.803		4025144950482	OA	0,068	
4	H185710004	HERDSTANGE ENDSTÜCK 37.047		4025144950499	EA	0,006	
5	H185710005	HERDRAHMEN RECHTS 89.007		4025144950505	HB	10,000	
12	H185710012	HERDPLATTE 91.007		4025144950512	HB	8,700	
13	H185710013	WASSERSCHIFF ABDECKPLATTE 08.007		4025144950529	OA	0,800	
18	H185710147	HEIZRAUMBLECH LINKS K185 F/A RECHTS		4025144970695	EB	5,270	
19	H185710019	ABGASSTUTZEN 24.007		4025144950598	QA	0,900	
30	H185710136	STRAHLSCHUTZBL. HINTEN GESCH. K185 F/A		4025144970602	RA	0,570	
31	H185710031	STIFT F.ANHEIZKLAPPE.F.K185F		4025144950635	FA	0,008	
32	H185710032	VERSCHLUSSDECKEL ABGASANSCHLUSS 01.085		4025144950642	LA	0,510	
34	H185710034	ANHEIZKLAPPE F.K185F 401.086		4025144950666	MA	0,230	
36	H185710036	ANHEIZKLAPPENLAGER K185 401.150		4025144950680	MA	0,350	
37	H185710037	BETÄTIGUNGSSTANGE F.ANHEIZKLAPPE 02.075		4025144950697	EA	0,064	
38	H185710038	BRATROHR SEITENTEIL K185F 630.232		4025144950703	GB	2,990	
40	H185710040	BACKBLECH K185F		4025144950727	TA	0,700	
41	H185710041	BRATROST K185F 001.024		4025144950734	QA	0,500	
42	H185710011	STAHLPLATTE F.BRATROHR F.K185F		4025144968104	DB	5,700	
43	H185710072	FEUERRAUM GRIFFSTANGE K185F 502.070		4025144951021	LA	0,070	
44	H185710066	BACKFACH GRIFFSTANGE K185F 502.071		4025144950970	LA	0,100	
47	H185710047	BRATROHR TERMOMETER K185F 08.028		4025144950772	JA	0,014	
48	H185710048	SCHARNIER F.GLAS-BRATROHRTÜR 06.011		4025144950789	FA	0,008	
49	H185710149	SPERRFEDER F.GLAS-BRATROHRTÜR 38041521		4025144994936	LA	0,005	
50	H185710050	GLAS-BRATROHRTÜR K185F 003.024 RECHTS		4025144950802	TA	1,030	
54	H185710181	BODENBLECH RECHTS K185 F/A RECHTS		4025144970947	YA	2,450	

ZEICH. NR	ART. NR.	BESCHREIBUNG K 185 F/A 7kW RECHTS NS / KERAMIK	09.2015	EAN	PG	GEWICHT kg	
55	H185710055	WÄRMEFACH FÜHRUNGSLEISTE K185 F/A		4025144950840	HA	0,464	
60	H185710092	ZUGKNOPF ANHEIZKLAPPE 02.186		4025144951199	JA	0,032	
61	H185710060	GRIFFHALTER K185F 502.067		4025144950901	MA	0,096	
62	H185710062	HOLZLAGERFACH GRIFFSTANGE 02.073		4025144950925	NA	0,200	
64	H185710100	KERAMIKPLATTE F.SEITEN BORDEAUX 90.508		4025144960078	BB	2,400	
64	H185710194	KERAMIKPLATTE F.SEITEN ANTIK		4025144978226	CB	2,208	
64	H185710105	SEITENPLATTE SERPENTINO K185 004.200.017		4025144968142	BB	3,086	
68	H185710009	VORDERECKWINKEL F.K185F-KERAMIK		4025144960085	AB	0,900	
69	H185710010	HINTERECKWINKEL F.K185F-KERAMIK		4025144960092	XA	0,700	
70	H185710070	ASCHENBEHÄLTER MANTEL 37.085		4025144951014	XA	1,080	
71	H185710158	HOLZLAGERFACH VORDERWAND 70.900		4025144960108	XA	1,510	
72	H185713059	HOLZLAGERFACH BLENDE ANTHRAZIT RECHTS KER		4025144960115	BB	1,770	
74	H185710101	KERAMIKPLATTE F.HOLZLAGERFACH RE. 94.508		4025144960139	CB	1,400	
74	H185710195	KERAMIKPLATTE F.HOLZLAGERFACH RE. ANTIK		4025144978233	CB	1,218	
74	H185710106	HOLZLAGERFACH SERPENTINO LI. 004.204.017		4025144968159	CB	2,612	
75	H185710102	KERAMIKPLATTE F.HOLZLAGERFACH LI. 93.508		4025144960146	CB	0,410	
75	H185710196	KERAMIKPLATTE F.HOLZLAGERFACH LI. ANTIK		4025144978240	YA	0,920	
75	H185710107	HOLZLAGERFACH SERPENTINO RE. 004.203.017		4025144968166	BB	1,808	
76	H185710103	KERAMIKPLATTE F.WÄRMEFACH BORDEA. 92.508		4025144960153	TA	0,710	
76	H185710197	KERAMIKPLATTE F.WÄRMEFACH ANTIK		4025144978257	YA	0,424	
76	H185710108	WÄRMEFACH SERPENTINO K185F 004.202.017		4025144968173	BB	1,000	
77	H185710104	KERAMIKPLATTE F.ASCHENFACH BORDE. 91.508		4025144960160	TA	0,350	
77	H185710109	ASCHENFACH SERPENTINO K185F 004.201.017		4025144968180	BB	0,652	
77	H185710198	KERAMIKPLATTE F.ASCHENFACH ANTIK		4025144978264	VA	0,300	
81	H185710081	LUFTREGULIERUNGSBLECH 67.003		4025144951076	OA	0,036	
82	H185710082	ROST 01.080		4025144951083	RA	1,620	

ZEICH. NR	ART. NR.	BESCHREIBUNG 09.2015 K 185 F/A 7kW RECHTS NS / KERAMIK	EAN	PG	GEWICHT kg	
83	H185710143	VERMIKULITPLATTE SEITENWAND K185 F/A	4025144970664	XA	1,800	
85	H185710078	ASCHENTRÜTTLER STAB K185 401.083	4025144951045	MA	0,010	
86	H185710182	VERMIKULITPLATTE BACKRAUMSEITE K185 F/A	4025144970954	BB	2,130	
87	H185710087	FEUERRAUM RÜCKWAND RECHTSK185F 401.082	4025144951144	LB	21,400	
89	H185710113	GEGENSCHARNIER HEIZTÜR K185F 401.130.007	4025144951274	QA	0,600	
90	H185710114	SCHEIBE D15X8,5X1 02.073	4025144951281	AA	0,001	
91	H185710115	SCHANIERSTIFFT D8 02.164	4025144951298	BA	0,009	
92	H185710116	SCHANIERSTIFFT SECHSKANTIG 02.163	4025144951304	BA	0,011	
93	H185710117	TORSIONSFEDER 04.030	4025144951311	JA	0,040	
94	H185710118	HEIZTÜRRAHMEN IN GUB RE. 31.007	4025144951328	BB	2,700	
95	H185710119	VERSCHLUSSFEDER HEIZTÜR 04.031	4025144951335	LA	0,008	
96	H185710120	VERSCHLUSSTIFFT HEIZTÜR 02.165	4025144951342	CA	0,016	
97	H185710148	HEIZRAUMBLECH RECHTS K185 F/A RECHTS	4025144970701	FB	4,760	
98	H185710122	SELBSTKLEB.GLASFASER BAND 10X3 04.105	4025144951366	KA	0,002	
99	H185710135	GLAS BEFESTIGUNGSWINKEL KO.F.K185F RE.	4025144956057	PA	0,090	
101	H185711125	HEIZTÜR TÜRBLENDE ANTHRAZIT RE. 68.609	4025144951403	UA	0,600	
102	H185710189	ASCHENFACH FÜHRUNGSLAIST: K185 F/A LINKS	4025144970985	TA	0,350	
103	H185710127	GLAS BEFESTIGUNGSPLÄTTCHEN 688.033	4025144951427	AA	0,010	
104	H185710128	HEIZTÜR KERAMIKFENSTER 03.115	4025144951434	BB	0,400	
105	H185710129	ABSTANDSROHR F.K185 502.181	4025144951441	AA	0,100	
106	H185710130	BRATROHR GEGENTÜRE (NEU) K185F 61.007	4025144951458	CB	4,000	
109	H185711133	BRATROHRTÜRBLEND.ANTHRAZIT R.658.069.609	4025144951496	VA	0,600	
110	H185710134	BRATROHRTÜR SCHARNIERSTIFFT 02.162	4025144951502	DA	0,030	
116	H185710190	HEIZRAUM BLECH RECHTS K185 F/A RECHTS	4025144970992	TA	5,270	
118	H185710229	ABSTANDSHÜLSE F. K185F 502.180	4025144960207	AA	0,002	

ZEICH. NR	ART. NR.	BESCHREIBUNG K 185 F/A 7kW RECHTS NS / KERAMIK	09.2015	EAN	PG	GEWICHT kg	
119	H185713063	WÄRMEFACH BLENDE ANTHRAZIT	36.609	4025144960214	XA	0,380	
121	H185710110	SCHÜRHAKEN	07.007	4025144951243	LA	0,700	
122	H185710111	HANDSCHUH F.K185F	004.186	4025144951250	LA	0,055	
123	H185710165	VERMIKULITPLATTE OBEN K185 F/A		4025144970688	XA	0,730	
124	H185710144	BÜGEL FÜR VORWAND DICHTUNG K185 F/A		4025144970671	GA	0,250	
126	H185710022	DISTANZROHR I. 30 K185F		4025144950611	AA	0,002	
128	H185710094	ABGASUMLENKUNG	90.018	4025144951212	LA	0,070	
131	H185713068	ASCHENBEHÄLTER BLENDE ANTHARZIT	35.609	4025144960238	XA	0,340	
132	H185710029	KERAMIKH.F.ASCHENBEHÄLT.F.K185F KERAMIK		4025144960245	LA	0,218	
133	H185710193	ASCHENBEHÄLTER K185 F/A RECHTS		4025144971029	TA	0,280	
134	H185710124	HEIZTÜR BOROFLOAT GLAS		4025144951380	CB	0,350	
136	H185710131	BRATROHRTÜR BOROFLOAT GLAS K185F		4025144951465	CB	0,450	
200	H185710200	HERDSTANGE KOMPLETT	00.013	4025144951519	EB	0,550	
201	H185710201	RINGSATZ HERDPLATTE D330	17.007	4025144951526	DB	4,500	
202	H185710202	HERDPLATTE KOMPLETT RE.	00.013	4025144951533	RB	24,000	
203	H185710203	GLASTÜR BRATROHR KPL.RE. K185F	000.176	4025144951540	VA	1,100	
204	H185710145	HOLZFACHSCHIENEN KOMPL.AB F.NR.1118X2011		4025144970800	XA	0,550	
205	H185710205	HOLZLAGERFACH HANDGRIFF KOMPLETT	00.154	4025144951564	OA	0,300	
207	H185710207	BRATROHR HANDGRIFF KOMPLETT K185F	000.153	4025144951588	VA	0,900	
208	H185712208	ASCHENBEHÄLTER KOMPLETT RE.	30.177	4025144960269	BB	1,530	
209	H185710209	HEIZTÜR HANDGRIFF KOMPLETT	00.152	4025144951601	TA	0,750	
211	H185710210	HOLZLAGERFACH AUSZUG RE.KOMPLETT	.013/A	4025144951618	MA	0,460	
212	H185710211	HOLZLAGERFACH AUSZUG LI.KOMPLETT	.013/B	4025144951625	MA	0,460	

STAND 09.2015

K185 F/A LINKS

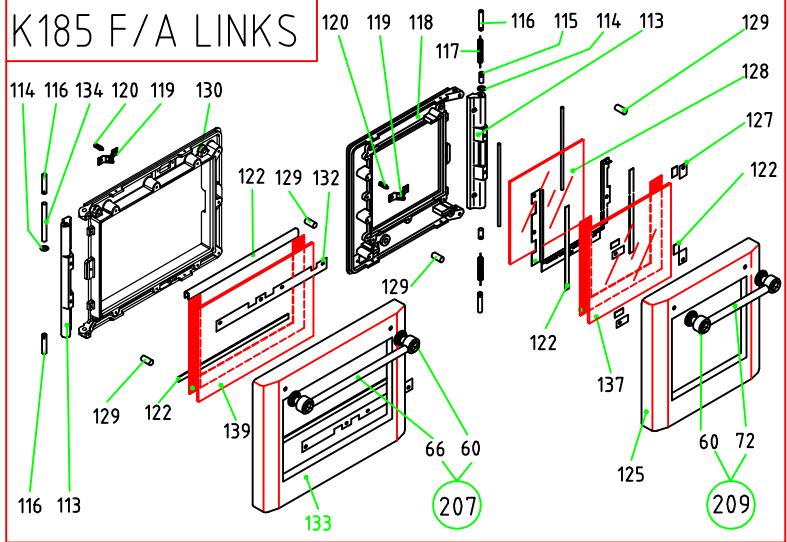

ZUBEHÖR

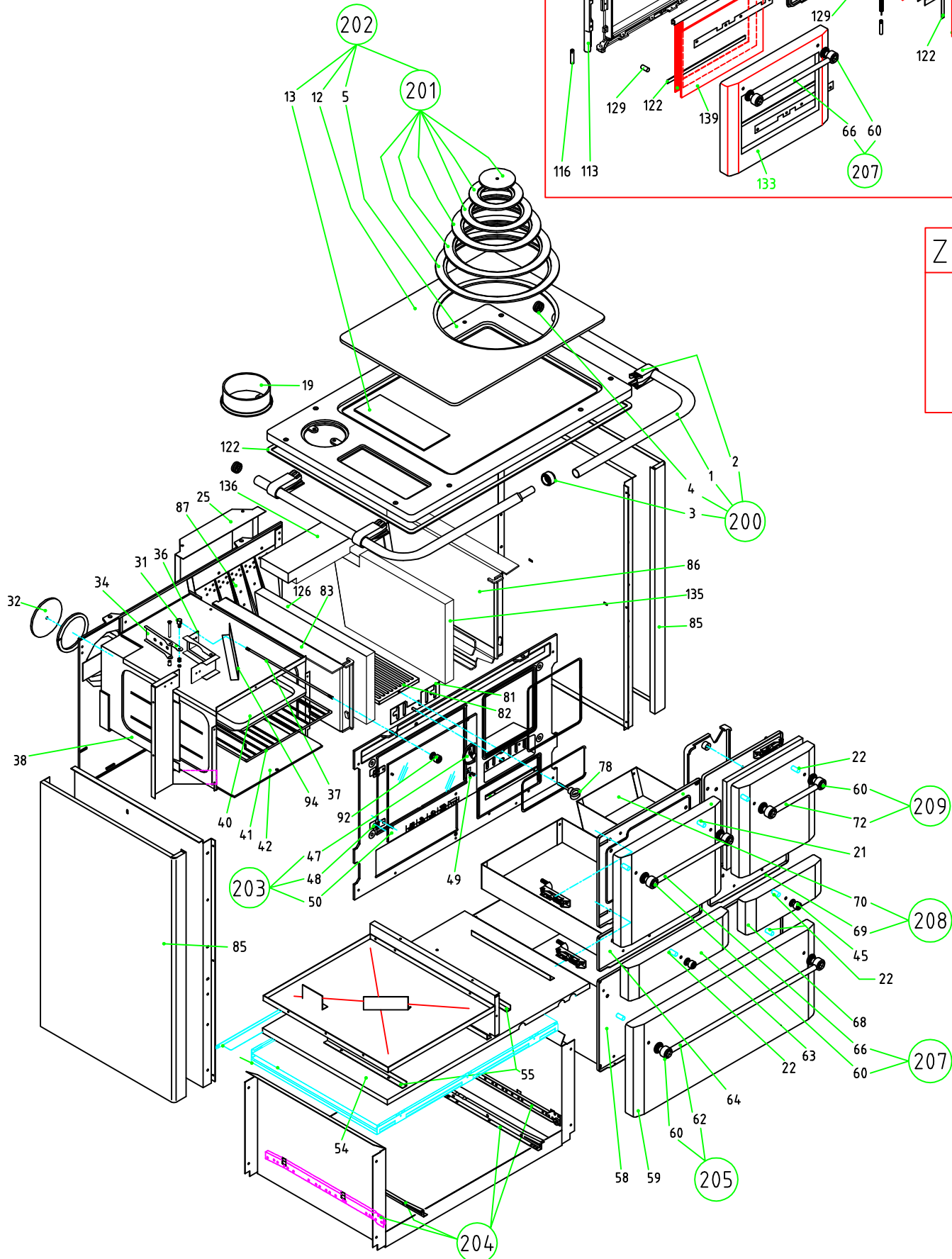
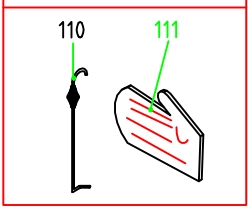

ZEICH. NR	ART. NR.	BESCHREIBUNG K 185 F/A 7kW LINKS	09.2015	EAN	PG	GEWICHT kg	
1	H185710001	HERDSTANGE 2-TEILIG K185F 02.077		4025144950468	XA	0,544	
2	H185710002	HERDSTANGENHALTER 37.048		4025144950475	LA	0,048	
3	H185710003	HERDSTANGE VERBINDUNGSTEIL 69.803		4025144950482	OA	0,068	
4	H185710004	HERDSTANGE ENDSTÜCK 37.047		4025144950499	EA	0,006	
5	H185710006	HERDRAHMEN LINKS 49.007		4025144956064	HB	10,000	
12	H185710012	HERDPLATTE 91.007		4025144950512	HB	8,700	
13	H185710013	WASSERSCHIFF ABDECKPLATTE 08.007		4025144950529	OA	0,800	
19	H185710019	ABGASSTUTZEN 24.007		4025144950598	QA	0,900	
21	H185710021	DISTANZROHR I. 26 K185F		4025144950604	AA	0,002	
22	H185710022	DISTANZROHR I. 30 K185F		4025144950611	AA	0,002	
25	H185710136	STRAHLSCHUTZBL. HINTEN GESCH. K185 F/A		4025144970602	RA	0,570	
31	H185710031	STIFT F.ANHEIZKLAPPE.F.K185F		4025144950635	FA	0,008	
32	H185710032	VERSCHLUSSDECKEL ABGASANSCHLUSS 01.085		4025144950642	LA	0,510	
34	H185710034	ANHEIZKLAPPE F.K185F 401.086		4025144950666	MA	0,230	
36	H185710036	ANHEIZKLAPPENLAGER K185 401.150		4025144950680	MA	0,350	
37	H185710037	BETÄTIGUNGSSTANGE F.ANHEIZKLAPPE 02.075		4025144950697	EA	0,064	
38	H185710038	BRATROHR SEITENTEIL K185F 630.232		4025144950703	GB	2,990	
40	H185710040	BACKBLECH K185F		4025144950727	TA	0,700	
41	H185710041	BRATROST K185F 001.024		4025144950734	QA	0,500	
42	H185710011	STAHLPLATTE F.BRATROHR F.K185F		4025144968104	DB	5,700	
45	H185710045	GRIFF F.ASCHEN-WÄRMEFACH K185 502.068		4025144950758	JA	0,096	
47	H185710047	BRATROHR TERMOMETER K185F 08.028		4025144950772	JA	0,014	
48	H185710048	SCHARNIER F.GLAS-BRATROHRTÜR 06.011		4025144950789	FA	0,008	
49	H185710149	SPERRFEDER F.GLAS-BRATROHRTÜR 38041521		4025144994936	LA	0,005	
50	H185710150	GLAS F.BRATROHRTÜR LINKS.F.K185F LI.		4025144968128	AB	1,035	
54	H185710168	BODENBLECH LINKS K185 F/A		4025144970831	YA	2,450	



















ZEICH. NR	ART. NR.	BESCHREIBUNG K 185 F/A 7kW LINKS	09.2015	EAN	PG	GEWICHT kg	
55	H185710055	WÄRMEFACH FÜHRUNGSLEISTE K185 F/A		4025144950840	HA	0,464	
58	H185710058	HOLZLAGERFACH VORDERWAND 83.900		4025144950871	WA	1,500	
59	H185710059	HOLZLAGERFACH BLENDE BLAU 10.700		4025144950888	BB	1,770	
59	H185711059	HOLZLAGERFACH BLENDE ANTHRAZIT 10.609		4025144950895	VA	1,770	
59	H185716059	HOLZLAGERFACH BLENDE WEIß		4025144995018	AB	1,770	
59	H185712059	HOLZLAGERFACH BLENDE CAPPUCCINO 10.402		4025144959959	AB	1,770	
60	H185710060	GRIFFHALTER K185F 502.067		4025144950901	MA	0,096	
62	H185710062	HOLZLAGERFACH GRIFFSTANGE 02.073		4025144950925	NA	0,200	
63	H185710063	WÄRMEFACH BLENDE BLAU 08.700		4025144950932	TA	0,430	
63	H185711063	WÄRMEFACH BLENDE ANTHRAZIT 08.609		4025144950949	RA	0,430	
63	H185716063	WÄRMEFACH BLENDE WEISS		4025144994998	SA	0,430	
63	H185712063	WÄRMEFACH BLENDE CAPPUCCINO 08.402		4025144959966	SA	0,430	
64	H185710155	WÄRMEFACH VORDERWAND LINKS K185 F/A		4025144970732	LA	0,400	
66	H185710066	BACKFACH GRIFFSTANGE K185F 502.071		4025144950970	LA	0,100	
68	H185710068	ASCHENBEHÄLTER BLENDE BLAU K185F		4025144950987	TA	0,380	
68	H185711068	ASCHENBEHÄLTER BLENDE ANTHRAZIT K185F		4025144950994	RA	0,380	
68	H185716068	ASCHENBEHÄLTER BLENDE WEISS K185F		4025144995001	SA	0,380	
68	H185712068	ASCHENBEHÄLTER BLENDE CAPPUCCINO 07.402		4025144959973	SA	0,380	
69	H185710156	ASCHENBEHAL. VORDERWAND LINKS K185 F/A		4025144970749	LA	0,280	
70	H185710070	ASCHENBEHÄLTER MANTEL 37.085		4025144951014	XA	1,080	
72	H185710072	FEUERRAUM GRIFFSTANGE K185F 502.070		4025144951021	LA	0,070	
78	H185710078	ASCHENTRÜTTLER STAB K185 401.083		4025144951045	MA	0,010	
81	H185710081	LUFTREGULIERUNGSBLECH 67.003		4025144951076	OA	0,036	
82	H185710082	ROST 01.080		4025144951083	RA	1,620	
83	H185710157	HEITZRAUMBLECH LINKS K185 F/A		4025144970756	FB	4,760	
85	H185710085	SEITENWAND LINKS/RECHTS BLAU 05.700		4025144951113	FB	3,460	

ZEICH. NR	ART. NR.	BESCHREIBUNG K 185 F/A 7kW LINKS	09.2015	EAN	PG	GEWICHT kg	
85	H185711085	SEITENWAND LINKS/RECHTS ANTHRAZIT 05.609		4025144951120	FB	3,460	
85	H185716085	SEITENWAND LI / RE WEIß		4025144994943	FB	3,460	
85	H185712085	SEITENWAND LINKS /RECHTS CAPPUCCINO 05.402		4025144959980	FB	3,460	
86	H185710170	HEITZRAUMBLECH RECHTS K185 F/A		4025144970848	FB	5,270	
87	H185710187	FEUERRAUM RÜCKWAND LINKS 01.105		4025144956170	HB	21,500	
90	H185710144	BÜGEL FÜR VORWAND DICHTUNG K185 F/A		4025144970671	GA	0,250	
91	H185710165	VERMIKULITPLATTE OBEN K185 F/A		4025144970688	XA	0,730	
92	H185710092	ZUGKNOPF ANHEIZKLAPPE 02.186		4025144951199	JA	0,032	
94	H185710094	ABGASUMLENKUNG 90.018		4025144951212	LA	0,070	
110	H185710110	SCHÜRHAKEN 07.007		4025144951243	LA	0,700	
111	H185710111	HANDSCHUH F.K185F 004.186		4025144951250	LA	0,055	
113	H185710113	GEGENSCHARNIER HEIZTÜR K185F 401.130.007		4025144951274	QA	0,600	
114	H185710114	SCHEIBE D15X8,5X1 02.073		4025144951281	AA	0,001	
115	H185710115	SCHANIERSTIFFT D8 02.164		4025144951298	BA	0,009	
116	H185710116	SCHANIERSTIFFT SECHSKANTIG 02.163		4025144951304	BA	0,011	
117	H185710117	TORSIONSFEDER 04.030		4025144951311	JA	0,040	
118	H185711118	HEIZTÜRRAHMEN IN GUß LI. 60.007		4025144956194	VA	2,750	
119	H185710119	VERSCHLUSSFEDER HEIZTÜR 04.031		4025144951335	LA	0,008	
120	H185710120	VERSCHLUSSSTIFFT HEIZTÜR 02.165		4025144951342	CA	0,016	
122	H185710122	SELBSTKLEB.GLASFASER BAND 10X3 04.105		4025144951366	KA	0,002	
123	H185711135	GLAS BEFESTIGUNGSWINKEL KOM.LI. K185F		4025144980052	PA	6,44	
125	H185712125	HEIZTÜR TÜRBLENDE BLAU LI. 70.700		4025144956217	VA	0,600	
125	H185713125	HEIZTÜR TÜRBLENDE ANTHRAXIT LI. 70.609		4025144956224	VA	0,600	
125	H185717125	HEIZTÜR TÜRBLENDE WEIß LI.		4025144994974	VA	0,600	
125	H185715125	HEIZTÜR TÜRBLENDE CAPPUCCINO LI. 70.402		4025144960016	VA	0,600	
126	H185710182	VERMIKULITPLATTE BACKRAUMSEITE K185 F/A		4025144970954	BB	2,130	

ZEICH. NR	ART. NR.	BESCHREIBUNG K 185 F/A 7kW LINKS	09.2015	EAN	PG	GEWICHT kg	
127	H185710127	GLAS BEFESTIGUNGSPLÄTTCHEN 688.033		4025144951427	AA	0,010	
128	H185710128	HEIZTÜR KERAMIKFENSTER INNEN 03.115		4025144951434	BB	0,400	
129	H185710129	ABSTANDSROHR F.K185 502.181		4025144951441	AA	0,100	
130	H185710130	BRATROHR GEGENTÜRE (NEU) K185F 61.007		4025144951458	CB	4,000	
133	H185712133	BRATROHR TÜRBLENDE BLAU LI. 71.700		4025144956231	XA	0,600	
133	H185713133	BRATROHR TÜRBLENDE ANTHRAZIT LI. 71.609		4025144956248	VA	0,600	
133	H185717133	BRATROHR TÜRBLENDE WEIß LI.		4025144994981	VA	0,600	
133	H185715133	BRATROHR TÜRBLENDE CAPPUCCINO LI. 71.402		4025144960023	VA	0,600	
134	H185710134	BRATROHRTÜR SCHARNIERSTIFFT 02.162		4025144951502	DA	0,030	
135	H185710143	VERMIKULITPLATTE SEITENWAND K185 F/A		4025144970664	XA	1,800	
136	H185710165	VERMIKULITPLATTE OBEN K185 F/A		4025144970688	XA	0,730	
137	H185710124	HEIZTÜR BOROFLOAT GLAS AUSSEN		4025144951380	CB	0,350	
139	H185710131	BRATROHRTÜR BOROFLOAT GLAS AUSSEN K185F		4025144951465	CB	0,450	
200	H185710200	HERDSTANGE KOMPLETT 00.013		4025144951519	EB	0,550	
201	H185710201	RINGSATZ HERDPLATTE D330 17.007		4025144951526	DB	4,500	
202	H185711202	HERDPLATTE KOMPLETT LI. 00.014		4025144956255	RB	24,000	
203	H185711203	GLASTÜR BRATROHR KPL. LI.K185F 000.178		4025144956262	VA	1,100	
204	H185710145	HOLZFACHSCHIENEN KOMPL.AB F.NR.1118X2011		4025144970800	XA	0,550	
205	H185710205	HOLZLAGERFACH HANDGRIFF KOMPLETT 00.154		4025144951564	OA	0,300	
207	H185710207	BRATROHR HANDGRIFF KOMPLETT K185F 000.153		4025144951588	VA	0,900	
208	H185711208	ASCHENBEHÄLTER KOMPLETT LI. K185F		4025144956286	BB	2,500	
209	H185710209	HEIZTÜR HANDGRIFF KOMPLETT 00.152		4025144951601	TA	0,750	

STAND 09.2015

ZEICH. NR	ART. NR.	BESCHREIBUNG K 185 F/A 7kW LINKS NS / KERAMIK	09.2015	EAN	PG	GEWICHT kg	
1	H185710001	HERDSTANGE 2-TEILIG K185F 02.077		4025144950468	XA	0,544	
2	H185710002	HERDSTANGENHALTER 37.048		4025144950475	LA	0,048	
3	H185710003	HERDSTANGE VERBINDUNGSTEIL 69.803		4025144950482	OA	0,068	
4	H185710004	HERDSTANGE ENDSTÜCK 37.047		4025144950499	EA	0,006	
5	H185710006	HERDRAHMEN LINKS 49.007		4025144956064	HB	10,000	
6	H185710182	VERMIKULITPLATTE BACKRAUMSEITE K185 F/A		4025144970954	BB	2,130	
12	H185710012	HERDPLATTE 91.007		4025144950512	HB	8,700	
13	H185710013	WASSERSCHIFF ABDECKPLATTE 08.007		4025144950529	OA	0,800	
19	H185710019	ABGASSTUTZEN 24.007		4025144950598	QA	0,900	
30	H185710136	STRAHLSCHUTZBL. HINTEN GESCH. K185 F/A		4025144970602	RA	0,570	
31	H185710031	STIFT F.ANHEIZKLAPPE.F.K185F		4025144950635	FA	0,008	
32	H185710032	VERSCHLUSSDECKEL ABGASANSCHLUSS 01.085		4025144950642	LA	0,510	
34	H185710034	ANHEIZKLAPPE F.K185F 401.086		4025144950666	MA	0,230	
36	H185710036	ANHEIZKLAPPENLAGER K185 401.150		4025144950680	MA	0,350	
37	H185710037	BETÄTIGUNGSSTANGE F.ANHEIZKLAPPE 02.075		4025144950697	EA	0,064	
38	H185710038	BRATROHR SEITENTEIL K185F 630.232		4025144950703	GB	2,990	
40	H185710040	BACKBLECH K185F		4025144950727	TA	0,700	
41	H185710041	BRATROST K185F 001.024		4025144950734	QA	0,500	
42	H185710011	STAHLPLATTE F.BRATROHR F.K185F		4025144968104	DB	5,700	
43	H185710072	FEUERRAUM GRIFFSTANGE K185F 502.070		4025144951021	LA	0,070	
44	H185710066	BACKFACH GRIFFSTANGE K185F 502.071		4025144950970	LA	0,100	
47	H185710047	BRATROHR TERMOMETER K185F 08.028		4025144950772	JA	0,014	
48	H185710048	SCHARNIER F.GLAS-BRATROHRTÜR 06.011		4025144950789	FA	0,008	
49	H185710149	SPERRFEDER F.GLAS-BRATROHRTÜR 38041521		4025144994936	LA	0,005	
50	H185710150	GLAS F.BRATROHRTÜR LINKS.F.K185F LI.		4025144968128	AB	1,035	
54	H185710181	BODENBLECH RECHTS K185 F/A RECHTS		4025144970947	YA	2,450	

ZEICH. NR	ART. NR.	BESCHREIBUNG 09.2015 K 185 F/A 7kW LINKS NS / KERAMIK	EAN	PG	GEWICHT kg	
55	H185710055	WÄRMEFACH FÜHRUNGSLEISTE K185 F/A	4025144950840	HA	0,464	
60	H185710092	ZUGKNOPF ANHEIZKLAPPE 02.186	4025144951199	JA	0,032	
61	H185710060	GRIFFHALTER K185F 502.067	4025144950901	MA	0,096	
62	H185710062	HOLZLAGERFACH GRIFFSTANGE 02.073	4025144950925	NA	0,200	
64	H185710100	KERAMIKPLATTE F.SEITEN BORDEAUX 90.508	4025144960078	BB	2,400	
64	H185710194	KERAMIKPLATTE F.SEITEN ANTIK	4025144978226	CB	2,208	
64	H185710105	SEITENPLATTE SERPENTINO K185 004.200.017	4025144968142	BB	3,086	
68	H185710009	VORDERECKWINKEL F.K185F-KERAMIK	4025144960085	AB	0,900	
69	H185710010	HINTERECKWINKEL F.K185F-KERAMIK	4025144960092	XA	0,700	
70	H185710070	ASCHENBEHÄLTER MANTEL 37.085	4025144951014	XA	1,080	
71	H185710158	HOLZLAGERFACH VORDERWAND 70.900	4025144960108	XA	1,510	
72	H185713059	HOLZLAGERFACH BLENDE ANTHRAZIT RECHTS KER	4025144960115	BB	1,770	
74	H185710101	KERAMIKPLATTE F.HOLZLAGERFACH RE. 94.508	4025144960139	CB	1,400	
74	H185710195	KERAMIKPLATTE F.HOLZLAGERFACH RE. ANTIK	4025144978233	CB	1,218	
74	H185710106	HOLZLAGERFACH SERPENTINO LI. 004.204.017	4025144968159	CB	2,612	
75	H185710102	KERAMIKPLATTE F.HOLZLAGERFACH LI. 93.508	4025144960146	CB	0,410	
75	H185710196	KERAMIKPLATTE F.HOLZLAGERFACH LI. ANTIK	4025144978240	YA	0,920	
75	H185710107	HOLZLAGERFACH SERPENTINO RE. 004.203.017	4025144968166	BB	1,808	
76	H185710103	KERAMIKPLATTE F.WÄRMEFACH BORDEA. 92.508	4025144960153	TA	0,710	
76	H185710197	KERAMIKPLATTE F.WÄRMEFACH ANTIK	4025144978257	YA	0,424	
76	H185710108	WÄRMEFACH SERPENTINO K185F 004.202.017	4025144968173	BB	1,000	
77	H185710104	KERAMIKPLATTE F.ASCHENFACH BORDE. 91.508	4025144960160	TA	0,350	
77	H185710109	ASCHENFACH SERPENTINO K185F 004.201.017	4025144968180	BB	0,652	
77	H185710198	KERAMIKPLATTE F.ASCHENFACH ANTIK	4025144978264	VA	0,300	
81	H185710081	LUFTREGULIERUNGSBLECH 67.003	4025144951076	OA	0,036	
82	H185710082	ROST 01.080	4025144951083	RA	1,620	

ZEICH. NR	ART. NR.	BESCHREIBUNG 09.2015 K 185 F/A 7kW LINKS NS / KERAMIK	EAN	PG	GEWICHT kg	
83	H185710170	HEITZRAUMBLECH RECHTS K185 F/A	4025144970848	FB	5,270	
85	H185710078	ASCHEINTRÜTLER STAB K185 401.083	4025144951045	MA	0,010	
86	H185710157	HEITZRAUMBLECH LINKS K185 F/A	4025144970756	FB	4,760	
87	H185710187	FEUERRAUM RÜCKWAND LINKS 01.105	4025144956170	HB	21,500	
89	H185710113	GEGENSCHARNIER HEIZTÜR K185F 401.130.007	4025144951274	QA	0,600	
90	H185710114	SCHEIBE D15X8,5X1 02.073	4025144951281	AA	0,001	
91	H185710115	SCHANIERSTIFFT D8 02.164	4025144951298	BA	0,009	
92	H185710116	SCHANIERSTIFFT SECHSKANTIG 02.163	4025144951304	BA	0,011	
93	H185710117	TORSIONSFEDER 04.030	4025144951311	JA	0,040	
94	H185711118	HEIZTÜRRAHMEN IN GUß LI. 60.007	4025144956194	VA	2,750	
95	H185710119	VERSCHLUSSFEDER HEIZTÜR 04.031	4025144951335	LA	0,008	
96	H185710120	VERSCHLUSSSTIFFT HEIZTÜR 02.165	4025144951342	CA	0,016	
97	H185710143	VERMIKULITPLATTE SEITENWAND K185 F/A	4025144970664	XA	1,800	
98	H185710122	SELBSTKLEB.GLASFASER BAND 10X3 04.105	4025144951366	KA	0,002	
99	H185711135	GLAS BEFESTIGUNGSWINKEL KOM.LI. K185F	4025144980052	PA	0,090	
101	H185713125	HEIZTÜR TÜRBLENDE ANTHRAZIT LI. 70.609	4025144956224	VA	0,600	
102	H185710189	ASCHENFACH FÜHRUNGSLEIST: K185 F/A LINKS	4025144970985	TA	0,350	
103	H185710127	GLAS BEFESTIGUNGSPLÄTTCHEN 688.033	4025144951427	AA	0,010	
104	H185710128	HEIZTÜR KERAMIKFENSTER 03.115	4025144951434	BB	0,400	
105	H185710129	ABSTANDSROHR F.K185 502.181	4025144951441	AA	0,100	
106	H185710130	BRATROHR GEGENTÜRE (NEU) K185F 61.007	4025144951458	CB	4,000	
109	H185713133	BRATROHR TÜRBLENDE ANTHRAZIT LI. 71.609	4025144956248	VA	0,600	
110	H185710134	BRATROHRTÜR SCHARNIERSTIFFT 02.162	4025144951502	DA	0,030	
116	H185710364	VORDERWAND F.WÄRMEFACH F.K185F	4025144968203	NA	0,360	
118	H185710229	ABSTANDSHÜLSE F. K185F 502.180	4025144960207	AA	0,002	
119	H185713063	WÄRMEFACH BLENDE ANTHRAZIT 36.609	4025144960214	XA	0,380	

ZEICH. NR	ART. NR.	BESCHREIBUNG K 185 F/A 7kW LINKS NS / KERAMIK	09.2015	EAN	PG	GEWICHT kg	
121	H185710110	SCHÜRHAKEN 07.007		4025144951243	LA	0,700	
122	H185710111	HANDSCHUH F.K185F 004.186		4025144951250	LA	0,055	
123	H185710165	VERMIKULITPLATTE OBEN K185 F/A		4025144970688	XA	0,730	
124	H185710144	BÜGEL FÜR VORWAND DICHUNG K185 F/A		4025144970671	GA	0,250	
126	H185710022	DISTANZROHR I. 30 K185F		4025144950611	AA	0,002	
128	H185710094	ABGASUMLENKUNG 90.018		4025144951212	LA	0,070	
131	H185713068	ASCHENBEHÄLTER BLENDE ANTHARZIT 35.609		4025144960238	XA	0,340	
132	H185710029	KERAMIKH.F.ASCHENBEHÄLT.F.K185F KERAMIK		4025144960245	LA	0,218	
133	H185710177	ASCHENBEHÄLTER VORDERWAND K185 F/A LINKS		4025144970916	TA	0,280	
134	H185710122	SELBSTKLEB.GLASFASER BAND 10X3 04.105		4025144951366	KA	0,002	
135	H185710124	HEIZTÜR BOROFLOAT GLAS		4025144951380	CB	0,350	
137	H185710131	BRATROHRTÜR BOROFLOAT GLAS K185F		4025144951465	CB	0,450	
200	H185710200	HERDSTANGE KOMPLETT 00.013		4025144951519	EB	0,550	
201	H185710201	RINGSATZ HERDPLATTE D330 17.007		4025144951526	DB	4,500	
202	H185711202	HERDPLATTE KOMPLETT LI. 00.014		4025144956255	RB	24,000	
203	H185711203	GLASTÜR BRATROHR KPL. LI.K185F 000.178		4025144956262	VA	1,100	
204	H185710145	HOLZFACHSCHIENEN KOMPL.AB F.NR.1118X2011		4025144970800	XA	0,550	
205	H185710205	HOLZLAGERFACH HANDGRIFF KOMPLETT 00.154		4025144951564	OA	0,300	
206	H185710306	WÄRMEFACH KOMPLETT LINKS K185F 630.183A		4025144968227	XA	2,300	
207	H185710207	BRATROHR HANDGRIFF KOMPLETT K185F 000.153		4025144951588	VA	0,900	
208	H185713208	ASCHENBEHÄLTER KOMPLETT LINKS F.K185F		4025144968234	BB	1,530	
209	H185710209	HEIZTÜR HANDGRIFF KOMPLETT 00.152		4025144951601	TA	0,750	

STAND 09.2015