

AVAILABLE FROM



Leading Edge Sales
1.866.313.9004
info@leadingedgesales.ca

PQube[®]

Installation & User's Manual

Firmware Rev 2.1

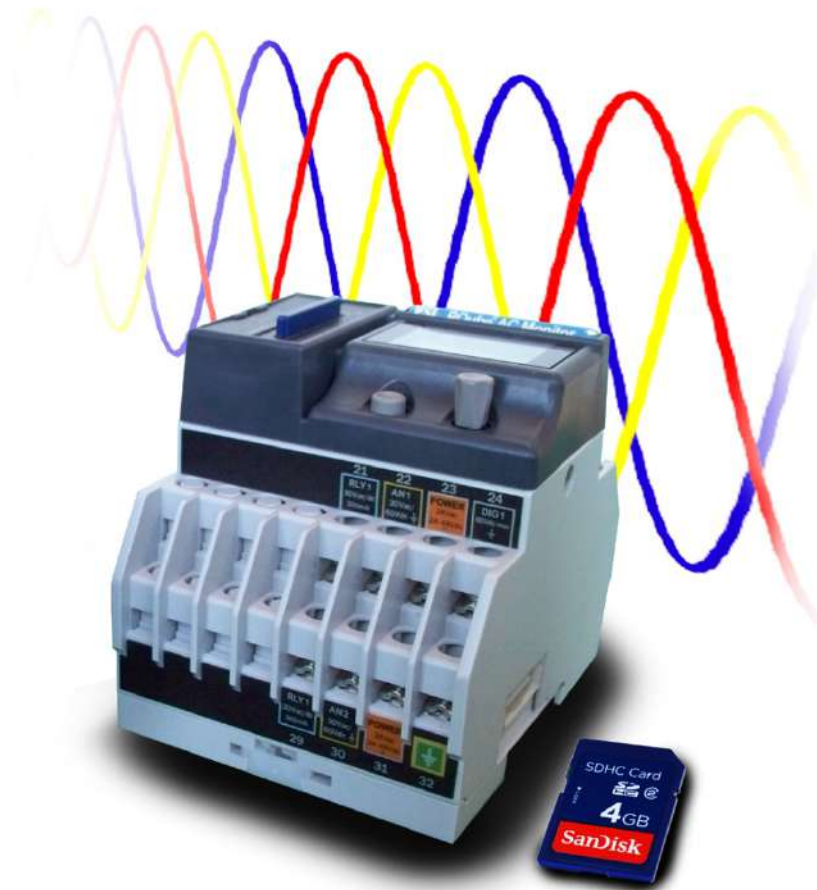

PSL

Power Standards Lab
2020 Challenger Drive #100
Alameda CA 94501 USA
www.PowerStandards.com



WARNING: Death, serious injury, or fire hazard could result from improper connection or operation of this instrument. Carefully read and understand manual before connecting this instrument.

AVERTISSEMENT: Si l'instrument est mal connecté, la mort, des blessures graves, ou un danger d'incendie peuvent s'en suivre. Lisez attentivement le manuel avant de connecter l'instrument.

WARNUNG: Der falsche Anschluß dieses Gerätes kann Tod, schwere Verletzungen oder Feuer verursachen. Bevor Sie dieses Instrument anschließen, müssen Sie die Anleitung lesen und verstanden haben.

ADVERTENCIA: Una conexión incorrecta de este instrumento puede producir la muerte, lesiones graves y riesgo de incendio. Lea y entienda el manual antes de conectar.

If this equipment is used in a manner not specified by the manufacturer, the protection provided by the equipment may be impaired. Installation, service, and maintenance of your PQube must only be done by an expert for electrical installations.







© 2008-2012 Power Standards Lab. All rights reserved. No parts of this document may be copied, reproduced, or translated to another language without the prior written consent of Power Standards Laboratory. "PQube" is a registered trademark of Power Standards Lab. "Windows" "Excel", and "PowerPoint" are registered trademarks of Microsoft Corporation.

The information contained in this document is subject to change without notice.

PSL MAKES NO WARRANTY OF ANY KIND WITH REGARD TO THIS MATERIAL, INCLUDING, BUT NOT LIMITED TO, THE IMPLIED WARRANTIES OF MERCHANTABILITY AND FITNESS FOR A PARTICULAR USE.

PSL shall not be liable for errors contained herein or for incidental or consequential damages in connection with the furnishing, performance, or use of this material. If you do not accept this limitation on liability, please return the product to PSL prior to use.

Produced in the United States of America.

Symbol	Meaning
	Caution. Consult this manual in all cases where this symbol is used.
	Caution. Risk of electric shock
	Alternating current
	Alternating current (a.c.) or direct current (d.c.)
	Double or Reinforced insulation
	Functional earth terminal <u>not</u> relied on for safety

First Release: July 2012

Table of Contents

Table of Contents	3
Introduction	6
What Can Your PQube Do?	6
How Is Your PQube Different?	7
Applications	8
Choosing Modules	8
Measure Current, Power, and Energy	9
Remote Communication	9
XCT5 and ETH1 combined into 1 module	9
Power your PQube from 100~240Vac	10
Measure Temperature and Humidity	10
DC Monitoring	10
Installation	11
Quickstart	11
General Installation	13
Mount your PQube securely	13
PQube instrument power	14
Connecting the wires	14
Using your PQube with external Potential Transformers	16
Include overcurrent protection and a disconnecting device	17
Protect the operator from the hazardous terminals	17
Protect antenna terminals from lightning	18
Installing Your ETH1 Ethernet Module	18
Installing Your PS1 or PS2 Power Supply Module	19
Installing Current Modules	19
Wiring Diagrams	21
Single-Phase L-N	21
Split-Single-Phase L-N-L	22
Single-Phase L-L	23
Delta	24
Wye/Star	25
Wye/Star (continued)	26
Overview of connections and controls	27
Disconnect mains prior to servicing	27

Calibration Information for Your PQube 27

Setting up your PQube 28

 Setting the Date and Time 28

 Setting Your Languages 28

 Check your Power Configuration 28

 Setting Your Potential Transformer Ratio 28

 Potential Transformers with Calibrated Ratios 29

Setting up Your Optional Current Module 30

 Setting Current Transformer Ratio 30

 Inverting Current Channels 30

 Calculating Current With a Missing CT 30

Fix installation errors, simply and easily 31

Setting Relays for Triggering on Events 31

Setting up Your Optional ETH1 Ethernet Module 32

 Network Setup 32

 Email Setup 32

 Web Server Setup 35

 FTP Setup 35

 Modbus Setup 35

 Simple Network Management Protocol (SNMP) 36

The Setup.ini File 37

Location.gif 37

DC Monitoring 38

 Individual Ratios for each Analog channel 38

 DC Power and Energy 38

 Swap AN1 and AN2 in software 38

 Customize your Analog channels 38

User Guide 39

Using Your PQube 39

 Your PQube’s Display and User Interface 39

Inserting and Removing Your SD Card 44

What Channels Does My PQube Measure? 44

 Standard PQube Channels 44

 Additional Channels Available With Optional Current Module 48

 Temperature and Humidity 49

PQube Recordings..... 50

- Event and Snapshot Recordings 50
- Trends and Statistics Recordings 56
- Trends and Statistics Channels 57
- Changing the configuration during a measurement interval 59
- File Formats 59
- Manually Trigger Snapshots or Daily Trends..... 61
- User Counter 61

Getting Data Into and Out of Your PQube 62

- SD Card 62
- ETH1..... 62

Maintenance..... 65

- Upgrading Your PQube’s Firmware 65
- Turning Off Your PQube..... 65
- Replacing your PQube’s battery 65
- Cleaning Instructions..... 65

PQube Specifications 66

Appendix 1: Modbus 71

- A brief introduction to Modbus..... 71
- PQube® Modbus registers 71

PQube Modbus Register Table 72

Appendix 2 – Setup File Guide 78

- PQube Setup..... 78
- Configure Event Triggering..... 87
- Network Configuration 95
- Setting up your Trends and Statistics 101

Appendix 3 – Ride-Through Curves 105

- STANDARD 105
- SEMI F47 106
- Samsung Power Vaccine 106
- ITIC 107
- CBEMA 107
- MIL-STD 704E 108
- MIL-STD 1399 108

Appendix 4 –MIB Table for SNMP 109

- PQube MIB Table 109**

Introduction

What Can Your PQube Do?

Your PQube® is an instrument for monitoring electric power systems.

It is convenient to think of it as a combination of a power disturbance monitor, a power meter, a power recorder, and a digital camera – it combines the best features of all four.

Your PQube records disturbances on the mains circuit: sags/dips, swells, interruptions, frequency variations, and disturbances on two analog input channels. It also records impulses, waveform snapshots, unbalance, flicker, and THD, and trend data (strip charts and cumulative statistics).

When equipped with an optional current sensing module, your PQube also records current waveforms, RMS amps, power and carbon. It measures watts, watt-hours, VAR's, power factor, and other power-related parameters.



You don't need any software from PSL to use your PQube. It records all data on a SD memory card, which can be read by any computer. No special software is required – just open the GIF picture files with standard image programs, or even Microsoft Word® and Microsoft PowerPoint®, or open the CSV files with any spreadsheet program such as Microsoft Excel® (or OpenOffice.org Calc if you prefer something free). Configure your PQube with our free PQube Configurator program, or by editing a text file on the SD card.



It can monitor single-phase or three-phase circuits, at up to 690 VAC phase-to-phase (400 VAC phase-to-earth), at 50 Hz, 60 Hz, and 400 Hz.

It includes channels for measuring auxiliary voltages – typically 24V AC or 48V DC.

It also has a general-purpose digital input, which you can control with switch contacts or a logic signal, and a relay contact output, which opens for at least 3 seconds whenever your PQube detects an event.

It can be directly powered from 24V AC or 24~48V DC, or it can be equipped with an optional PS1 power supply that operates from 100V ~ 240V, 50/60 Hz.

Your PQube also measures and triggers on temperature and humidity at up to two locations, using optional TH1 temperature-humidity probes.

When equipped with an optional ETH1 Ethernet module, your PQube can automatically send you e-mails whenever it detects an event. You can send your PQube a new setup file, or even update its firmware via e-mail. The Ethernet module also includes a web server, an FTP server, and MODBUS over TCP, giving you even more ways to communicate with your PQube.

How Is Your PQube Different?

There are many power quality meters, energy meters, and energy recorders available. What makes the PQube stand out from other products?

- **No software. No rental fees. Open data.** -- You don't need any software from PSL to use the PQube. Do you have a web browser? A text editor? A spreadsheet program like Microsoft Excel®? That's all you need! All the data that the PQube records are in open formats that are easy to understand. You don't have to buy or lease software from Power Standards Lab, you don't have to pay us to see your data, and the files are easy to pass on to third parties.
- **Friendly data.** – When you look at information about your electric power, you don't want to spend a lot of time learning to use software to get the view that you want. You simply want your data organized and presented to you in a format you can understand. Your PQube presents power quality events, trends, and statistics in formats you can easily use and lays the data out in a way that's understandable. Your PQube knows what's important.
- **Free firmware updates** – From time to time, we offer firmware updates to add new features to your PQube. Other instrument manufacturers charge for firmware updates, we don't.
- **Works out of the box, or configure everything to work for you** – With our patent-pending auto configuration, you can connect your PQube to the power that you want to measure and the PQube will immediately start recording data. If you don't like the default settings you can change almost any setting in the PQube Configurator program, or by editing a text file on the SD card.
- **Works with or without a network** – Do you have an Ethernet network? Use an optional ETH1 module and get emails when an event occurs, browse the recorded events and trends with your web browser, or integrate it into your Modbus system. Don't have a network? No problem, just walk up to the PQube and take the SD card. You can look at all the files on any computer (you don't need software). You don't need a sophisticated centralized data collection system to get started. Just connect a PQube and start getting data right away.
- **Store years of data on standard SD cards.** – Your PQube comes with an 8GB SD card which will store about 4 years' worth of data based on 2 gigabyte typical usage per year of data.
- **Small size** – The PQube is tiny (a little bit bigger than your fist), and that makes it easier to integrate into your product.
- **Low cost** – At Power Standards Lab, we're experts at building power sensor electronics. We know how to do it right, and we know how to do it inexpensively. The PQube costs far less than comparable instruments.
- **It's everything you need.** – Power quality data: dips, swells, frequency variation, and high-frequency impulses. Energy data: kWh, kVAh, and carbon. Trend data: daily, weekly, and monthly strip charts, cumulative probability and load duration. Why buy multiple meters when the PQube can do it all?

Applications

Your PQube is ideal for reducing your service costs on sensitive equipment, such as semiconductor manufacturing equipment and sophisticated medical scanners. By detecting and recording power disturbances, you can easily and quickly separate intermittent power problems from other intermittent problems: software bugs, user errors, supply stock problems, etc.



And your PQube is an excellent choice for monitoring the power that feeds industrial controls, such as automated machinery, robotics, and elevator/lift controls.



You can use your PQube in dozens of other applications: monitoring the power quality at key accounts, doing national surveys of power quality, safely recording power data for research projects, understanding why your wind turbine drops off line unexpectedly, and many other purposes.

Choosing Modules

Your PQube records events, trends, and statistics by monitoring your AC mains voltages. It also measures two analog input channels for additional signals (for example, the output of a power supply), a digital input channel, an output relay, and a full color display. Your PQube records all information to a standard SD memory card.

IMPORTANT: Installation, service, and maintenance of your PQube must only be done by an expert for electrical installations.¹

¹ This is a requirement for Japanese safety standard approvals.

Your PQube clicks together with several optional modules to provide extra features. To choose modules for your application, you'll need to answer four simple questions:

- Are you interested in measuring current, power, or energy?
- Do you want to power your PQube from 100~240Vac (50/60Hz)?
- Are you interested in any of the following: email, a web server, an FTP server, or Modbus over TCP?
- Do you want to record the temperature and humidity in addition to everything about the electric power?

Measure Current, Power, and Energy

Are you interested in measuring current, power, or energy? If so, you'll need a PQube current module. There are three versions; please pick the one that is best for you.

XCT4 – External CTs with current secondary outputs

If you already have CTs (Current Transformers) with current outputs, you can use an XCT4. This module accepts 1-Amp or 5-Amp CT secondaries. For more information, see the [XCT4 Current Module section \(page 19\)](#).



XCT5 - External CTs with voltage secondary outputs

If you already have CTs with voltage output, or you purchase them from Power Standards Lab, you can use an XCT5. This module accepts 0.333 Volt, 1 Volt, 5 Volt, or 10 Volt secondaries. This module comes with five current channels, allowing you to measure all three phase currents, neutral current, and earth current simultaneously!



CT4 – Current Sensing Module

If you don't want to use CTs, the CT4 current module might be right for you. This module is rated for 20 amps and has the CTs built in already. Just pass the conductors through. For more information, see the [CT4 Current Module section \(page 19\)](#).



Remote Communication

ETH1

Are you interested in any of the following: email, a web server, an FTP server, or Modbus over TCP? If you need any of these features, you need an ETH1 Ethernet module. For more information, see the [ETH1 section \(page 62\)](#).



XCT5 and ETH1 combined into 1 module

CTE1

Are you interested in having network capability and measuring current, but don't have the space for both an ETH1 module and XCT5 module? Use a CTE1 module to take advantage of the ETH1 and XCT5 functionality in a single compact module.



Power your PQube from 100~240Vac

PS1

Do you want to power your PQube from 100~240Vac (50/60Hz)? If you have 24~48Vdc or 24Vac, you can use your PQube's internal power supply (just connect to the power supply screw terminals). If you want to use 100~240Vac, you'll need an optional PS1 Power supply module.



PS2

In addition to powering your PQube from 100 ~ 240VAC (50/60Hz), you can power external accessories with the PS2's 24VDC output.



Measure Temperature and Humidity

TH1

Do you want to record the temperature and humidity in addition to everything about the electric power? You can use up to two TH1 Temperature/Humidity sensors. Measure the local environment or connect a second sensor with an extension cable and measure the temperature and humidity at two locations simultaneously. Just plug them into your PQube and it will start recording data immediately.



DC Monitoring

ATT1

Interested in High Voltage DC Monitoring? Use an ATT1 module. It is available with a full scale of 600VDC and 1200VDC, and can measure up to 1000VDC and 2000VDC, respectively. Measure 1 differential voltage, or 2 voltages relative to earth.



ATT2

Do you want to monitor both DC voltage and DC current? Use an ATT2 module, it is available with a full scale of 600VDC and can measure up to 1000VDC. The ATT2 module accepts a DC current sensor that is powered by ± 15 VDC, and has a ± 5 V nominal output.



Installation

Quickstart

- 1 Snap your PQube on to your DIN rail, then snap on and slide together any modules.



- 2 Don't have an ETH1, XCT4, XCT5, CTE1 or CT4 plug-in module? Go to step 3.
 - a) ETH1 module? Connect your Ethernet cable.
 - b) CTE1 module? Connect your Ethernet cable to the RJ45 port, and your current transformer wires to the terminal blocks.
 - c) XCT4 or XCT5 current interface module? Connect your current transformer to the screw terminals of your XCT module. Note: You can only install ONE current module (CTE1, XCT4, XCT5, or CT4) to the PQube.
 - d) CT4 current sense module? Pass your current carrying conductors through the CT openings.

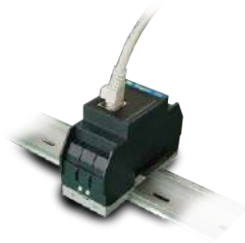

(a) (b)

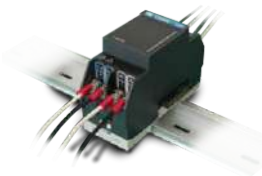

(c)

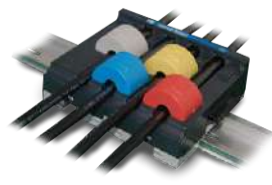

(d)

- 3 Connect Earth and Mains wires to your PQube.

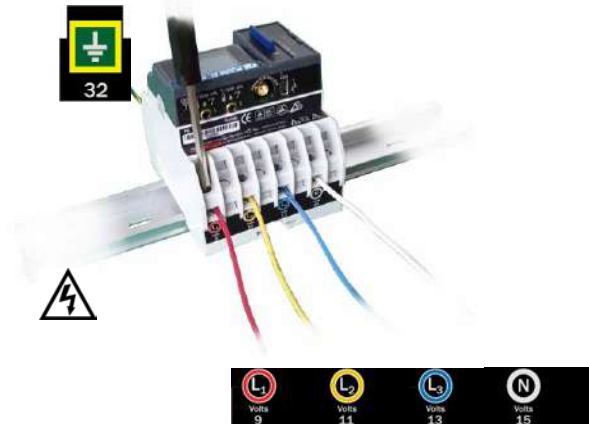

- 4 Connect 24VAC or 24-48VDC POWER to your PQube, or plug in a PS1 or PS2 Power Supply module and connect 100~240VAC to it.

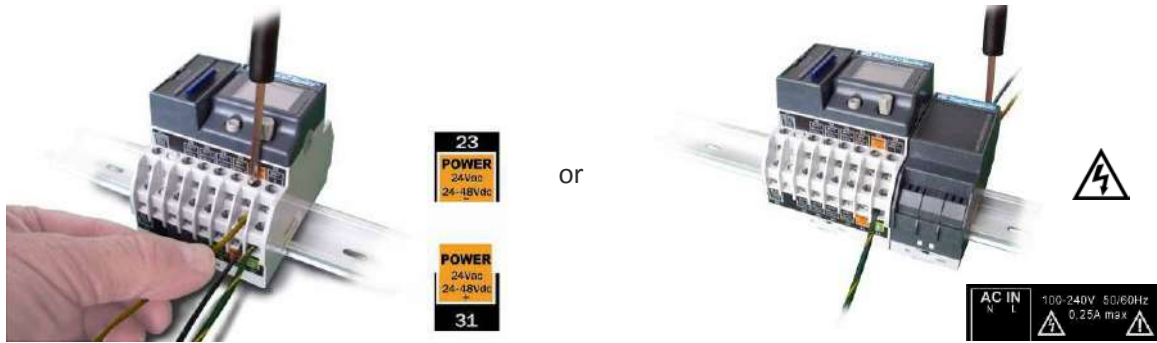

- 5 Use the joystick and pushbutton to navigate through the screens ...

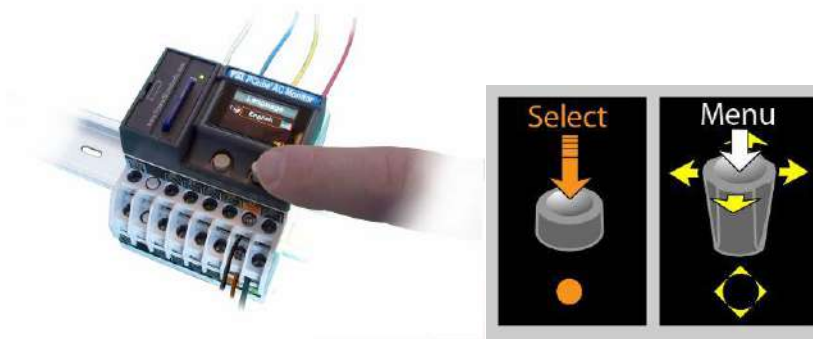

... And verify that your voltage and/or current readings are correct. If using AUTO-configuration, verify that your PQube “locks on” to the correct power configuration and nominal voltage. **Very important:** Your PQube requires a min. 30VAC to lock on and start recording data.



- 6 Your PQube is recording power quality events and trends on its SD card. If you have a current transformer module, your PQube is also measuring energy.

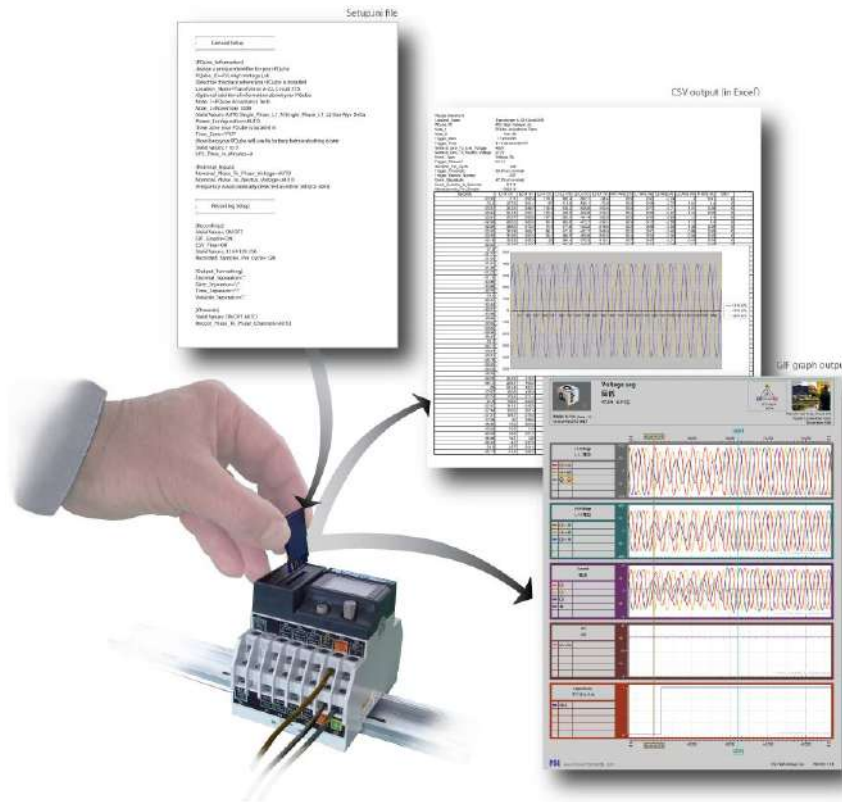

General Installation

Mount your PQube securely

Your PQube, and its optional modules, are designed to be mounted on an industry-standard 35mm DIN rail as rack- or panel-mounted equipment.

The optional PS1 Power Supply module connects to the right side of your PQube. The optional Ethernet module or current sensing modules connect to the left side of your PQube. Connect them to your PQube in any order that is convenient. Do not connect multiple current sensing modules. Only connect one current sensing module, either a CT4, XCT4, XCT5 or CTE1.

In the United States and Canada, the equipment installation shall meet ANSI/NFPA 70, NEC, with CSA C22.1, CEC, Part I or with both as appropriate. In other countries, follow all local installation requirements and regulations.

Your PQube’s “enclosure”, as defined in UL/IEC 61010-1, is provided by the installation, and must be evaluated in the end product.

IMPORTANT: Your PQube must be installed only by an expert for electrical installations². The instrument power screw terminals must be connected to no more than 24Vac +/- 20%, or 24Vdc~48Vdc +/- 20%, supplied by a certified isolating power supply.

PQube instrument power

Your PQube can take its operating power from three different sources: its Power screw terminals [23][31], its internal Lithium Polymer rechargeable battery, or an optional PS1 Power Supply module.

Power screw terminals

Your PQube's Power screw terminals [23][31] accept 24VAC nominal, or 24Vdc~48Vdc nominal. They are most commonly connected to 24Vdc, 24VAC, or -48Vdc.

Polarity does not matter. Also, your PQube provides a minimum of 150V of transformer-based isolation between these terminals and all other terminals, eliminating any problems with ground loops.

Internal Li-Polymer battery

Your PQube's internal Li-Polymer battery is automatically charged from all the other power sources. An application-specific chip manages the charging process, paying attention to voltage, current, and temperature. The battery itself is equipped with an internal high-temperature shut-down circuit.

The battery operating capability depends on the options installed in your PQube, and on the ambient temperature. In typical tests, the battery can operate your PQube for about one hour. However, you can choose the operating duration by writing a value in your **Setup.ini** file. The value can be set from 1 to 9 minutes (the default is 3 minutes). This guarantees that there will be enough charge in the battery to record several successive power interruptions.

As the battery ages, its capacity will decline. For maximum performance, it may be necessary to replace the battery in 5 years. Some normal swelling of the battery may result from high temperature operation, but this does not interfere with battery performance.

Connecting the wires

Observe the wire size specifications and limitations. All conductors must be stranded copper. All conductors and insulation systems and crimped devices must be appropriate for the application. PSL recommends crimped ferrules on stranded wire, or crimped snap-on forked lugs. Tighten the screw terminals to 0,8 newton-meters (7 inch-pounds) of torque. Observe all voltage ratings and limits.

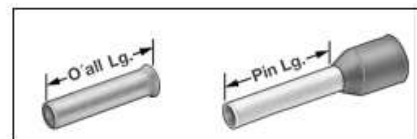

² This is a requirement for Japanese safety standard approvals.

For mains connections and current connections, PSL recommends snap-on forked terminals, such as 3M Scotchlok[®] P/N MU18-6FL or MU14-6FL, or Panduit P10-6F. For other connections, PSL recommends wire ferrules for stranded wire, such as Panduit F77 series, for example Panduit F77-6-M.





Figure 1: Your PQube meets all IEC requirements for high-frequency emissions and susceptibility, both conducted and radiated. For further protection, you can use clamp-on ferrites on signal cables to minimize radio-frequency emissions. For example, these are Panasonic KRCBC160928B and KRCBC130714B.

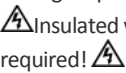

Figure 2: To minimize emissions with the optional PS1 Power Supply module, optionally use a shielded power conductor.

Conductor characteristics

Connection	Minimum wire size	Maximum wire size	Limitations and remarks
PQube terminals L1, L2, L3, N [9] [11] [13] [15]	20AWG (0,52 mm ²)	14 AWG (2.1mm ²)	Comply with all local safety and installation requirements and regulations. Min 600V UL-recognized insulation system required. These terminals require less than 0,01 amps. Connection to N (15) is optional. For single phase monitoring, connect either L1-N or L1-L2 as appropriate for the mains configuration.
PQube Earth terminal [32]	Wire size used for L1,L2,L3,N terminals	14 AWG (2.1mm ²)	Connect this terminal to a suitable earth connection. For proper PQube operation, you must connect this terminal to earth. It is used as a measurement reference, and as a reference for your PQube's low voltage circuits.
Optional PQube RLY4 terminals [25] [26]	20AWG (0,52 mm ²)	14 AWG (2.1mm ²)	Min 600V UL-recognized insulation system required. Wire size must be adequate for relay contact load. These terminals are rated at 30 VAC max, 60 Vdc max, 2 amps max.
All other PQube terminals	20AWG (0,52 mm ²)	14 AWG (2.1mm ²)	Min 600V UL-recognized insulation system required.
Optional PS1 terminals	20AWG (0,52 mm ²)	14 AWG (2.1mm ²)	Min 600V UL-recognized insulation system required. Shielded cable recommended for minimizing emissions.
Optional XCT4 terminals	20AWG (0,52 mm ²)	14 AWG (2.1mm ²)	Ring lugs or snap-on forked terminals are recommended for CT connections. Self-retaining screws in terminals may make ring lugs challenging to install. Wire size must be adequate for 1-amp or 5-amp currents. Min 600V UL-recognized insulation system required
Optional CT4 pass- through inputs	20AWG (0,52 mm ²)	Limited by physical dimension of pass- through locations: 8.5 mm (0.34") dia.	Min 600V UL-recognized insulation system required.  Insulated wire is required! 

Maximum voltages

Connection	Maximum voltage with respect to Earth	Maximum current	Limitations and remarks
PQube terminals L1, L2, L3, N [9] [11] [13] [15]	400 Vrms, CAT III up to 300Vrms, CAT IV		Corresponds to 690 Vrms phase-to-phase on centered-neutral mains systems. Corresponds to 480Vrms phase-to-phase on centered-neutral mains systems. All voltage channels must be covered after installation.
PQube Earth terminal [32]	N/A		
Optional PQube RLY4 terminals [25] [26]	30 Vrms or 60 Vdc		
All other PQube terminals	30 Vrms or 60 Vdc		
Optional PS1 terminals	240 Vrms, CAT III		AC voltage input terminal must be covered after installation.
Optional XCT4 terminals	400 Vrms, CAT III	1 amp for XCT4-1A 5 amps for XCT4-5A	Usually connected to external current transformer secondaries, which provide insulation from mains. Corresponds to 690 Vrms phase-to-phase on centered neutral mains systems.
	up to 300Vrms, CAT IV		Usually connected to external current transformer secondaries, which provide insulation from mains. Corresponds to 480Vrms phase-to-phase on centered neutral mains systems.
Optional CT4 pass-through inputs 	400 Vrms, CAT III	20 amps for CT4-20 50 amps for CT4-50	Corresponds to 480Vrms phase-to-phase on centered neutral mains systems.
	up to 300Vrms, CAT IV		Corresponds to 690 Vrms phase-to-phase on centered neutral mains systems.

Note: "CAT III" means Measurement Category III as defined in UL / IEC 61010-1: "Measurement category III is for measurements performed in the building installation.... Examples are measurements on distribution boards, circuit-breakers, wiring, including cables, bus-bars, junction boxes, switches, socket-outlets in the fixed installation, and equipment for industrial use..."

"CAT IV" means Measurement Category IV as defined in UL / IEC 61010-1: "measurements performed at the source of the low-voltage installation.... Examples are electricity meters and measurements on primary overcurrent protection devices and ripple control units."

Using your PQube with external Potential Transformers

If you want to measure nominal voltages higher than 690 volts, you can connect your PQube voltage inputs to the secondary windings (low voltage windings) of any standard Potential Transformer.

In general, the accuracy of your PQube's voltage measurements are so precise (roughly $\pm 0.1\%$) that any accuracy specification will be determined almost entirely by the potential transformer that you select. If using calibrated potential transformers, you can enter the calibration constants into your PQube to further improve your accuracy.

For information on configuring your PQube to read correct voltages when using a potential transformer, see [Setting Your Potential Transformer Ratio \(page 28\)](#).

Include overcurrent protection and a disconnecting device

An external overcurrent protection device, such as a fuse or a circuit breaker, must be installed on each mains connection. The device shall meet the relevant requirements of IEC 60947-1 and IEC 60947-3, and be suitable for the application.

The overcurrent protection device must be rated between 1 amp (minimum) and 20 amps (maximum).

Your PQube can share the overcurrent protection device with other loads.

An operator-activated disconnecting device, such as a switch or a circuit breaker, must be installed on the mains connections. This device must be clearly marked as the disconnecting device for your PQube, and must be marked to indicate the disconnection function. Do not install your PQube in such a way that it becomes difficult to operate this disconnecting device. The disconnecting device must not disconnect the earth connection. The disconnecting device should be installed near your PQube, within easy reach of the operator.

Protect the operator from the hazardous terminals

IMPORTANT: All high voltage parts must be covered, including the AC power to your PQube. Install your PQube so that all of the screw terminals are not ACCESSIBLE³ to the operator. Your PQube can also be installed without a cover if installed in a lockable IUL 508 control panel.

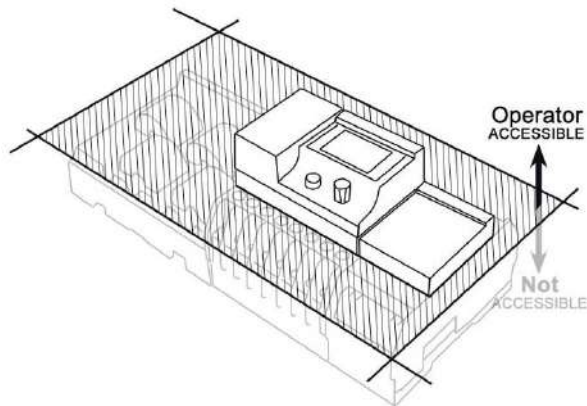

The operator must be protected from the hazardous screw terminals by a barrier. The screw terminals must be made “not ACCESSIBLE”, as defined in UL /IEC 61010-1 6.2, using an enclosure or barrier that meets the rigidity requirements of UL /IEC 61010-1 8.1 and that requires a tool to remove.

³ Accessible, as defined in UL 61010-1, means able to be touched with a standard test finger or test pin, when used as specified in UL61010-1 6.2.



If you choose to install your PQube in an enclosure, select a UL-listed enclosure that is appropriate for the purpose, such as the Altech EK series (www.AltechCorp.com). If you plan to use an enclosure of this type, you should review its mechanical compatibility with any optional features of your PQube that you plan to use: optional USB connections, optional temperature-humidity probes, etc.

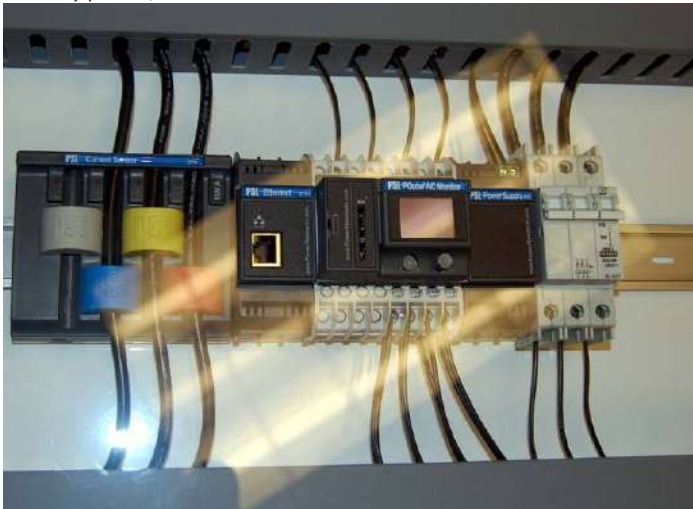

A different example of how to correctly protect your PQube operator from the screw terminals. A 6,35mm (0.25 in) clear Plexiglass sheet, which requires a tool to remove, protects the operator. A rectangular cutout in the Plexiglass gives the operator access to your PQube controls, the Ethernet connection, etc. Note the 1-amp, 3-phase circuit breaker, at far right, used both as external overcurrent protection and disconnecting device, near your PQube. The rectangular opening in the Plexiglass should be 74mm x 47mm (for your PQube alone), or 110mm x 47mm (for your PQube and the ETH1 module, or your PQube and the PS1 module), or 146mm x 47mm (for your PQube and both the ETH1 and PS1 modules).

Protect antenna terminals from lightning

If you install a PQube antenna (GPS, Zigbee, etc.) in an outdoor location where it may be exposed to lightning, you must include a properly installed UL-497C-listed lightning protection device on the antenna cable. Follow all local installation safety requirements and regulations.

Installing Your ETH1 Ethernet Module

The optional ETH1 Ethernet module connects to the left side of your PQube; just snap it in. Connect the module before supplying power to your PQube. The ETH1 Ethernet module contains a standard RJ-45 Ethernet port. The module uses 10BaseT Ethernet with built-in crossover detection. You can connect your ETH1 Ethernet module to any standard Ethernet network using a standard Ethernet cable. For information on configuring your ETH1 module see [Setting up Your Optional ETH1 Ethernet Module \(page 32\)](#).

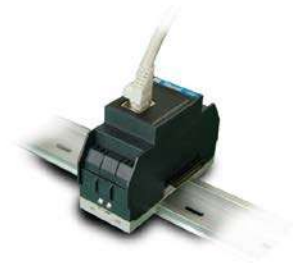

Installing Your PS1 or PS2 Power Supply Module

The optional PS1 or PS2 Power Supply Module connects to the right side of your PQube; just snap it in. It accepts any 50/60 Hz single-phase input between 100Vac and 240Vac nominal. Verify that you are connecting the line and neutral wires to the correct terminals on the module. The PS1 and PS2 Power Supply modules contain an internal fuse.

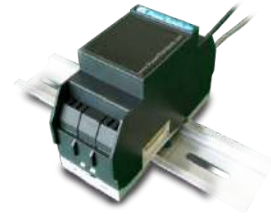

Installing Current Modules

If you want to measure current with your PQube you can install an optional module. Simply plug the module into the side of your PQube.

PQube current modules provide transformer-based electrical isolation, except for the XCT5-0.333V, XCT5-01V, XCT5-05V, and XCT5-10V, which take low-voltage inputs.

Note that your PQube makes current measurements with a Crest Factor of 3.5. This means that your PQube can measure instantaneous currents up to 350% of the nominal rated current (for example, if you have selected a 300-amp current transformer with a 5-amp secondary, your PQube will accurately measure up to ± 1050 amps instantaneous). This is a very useful feature when dealing with inrush currents, and currents with high harmonic contents.

When connecting a Current Module, it is important to match the phases to the voltage inputs and current input (connect the L1 voltage input and the L1 current sensor to the same conductor). This is important for correct power and energy calculations.

There are three main types of current module, the XCT4 with current inputs, the XCT5 with voltage inputs, and the CT4. You only need one current module to measure current, power, and energy. Pick the version that works best for you.

XCT4 Current Module – Current inputs



You can connect external current transformers to your PQube. There are two versions of the XCT4 module: each will work with a different type of CT. Make sure you carefully read all safety information provided by the manufacturer before installing CTs.

If you are using a CT with a current secondary, you can use the XCT4-1A-00 or the XCT4-5A-00 which have 1 and 5 Amp inputs, respectively.

Your PQube places almost zero burden on the current transformer (less than 0.1 VA), so you can select almost any current transformer.

XCT5 Current Module – Voltage inputs

If you are using a current sensor that has a voltage output, you can choose between the XCT5-0.333V-00, XCT5-01V-00, XCT5-05V-00, and XCT5-10V-00 which have 0.333, 1, 5, and 10 Volt inputs, respectively.

You can use either standard current transformers, or split-core current transformers. Standard current transformers are generally less expensive, and are often more accurate. Split-core transformers are much easier to install.

In general, the accuracy of your PQube's current measurements are so precise (roughly $\pm 0.1\%$) that the accuracy of your current measurements will be determined almost entirely by the current transformer that you select.

CT4 Current Module



If you don't already have CTs, but you want to measure current, you can use the optional CT4 module. It has the CTs already built in and ready to use.

The CT4 module is rated for 20A full scale. It accepts conductors up to 0.34 inches (8,6mm) in diameter. 600V, UL-recognized insulation is required.

Wiring Diagrams

Single-Phase L-N

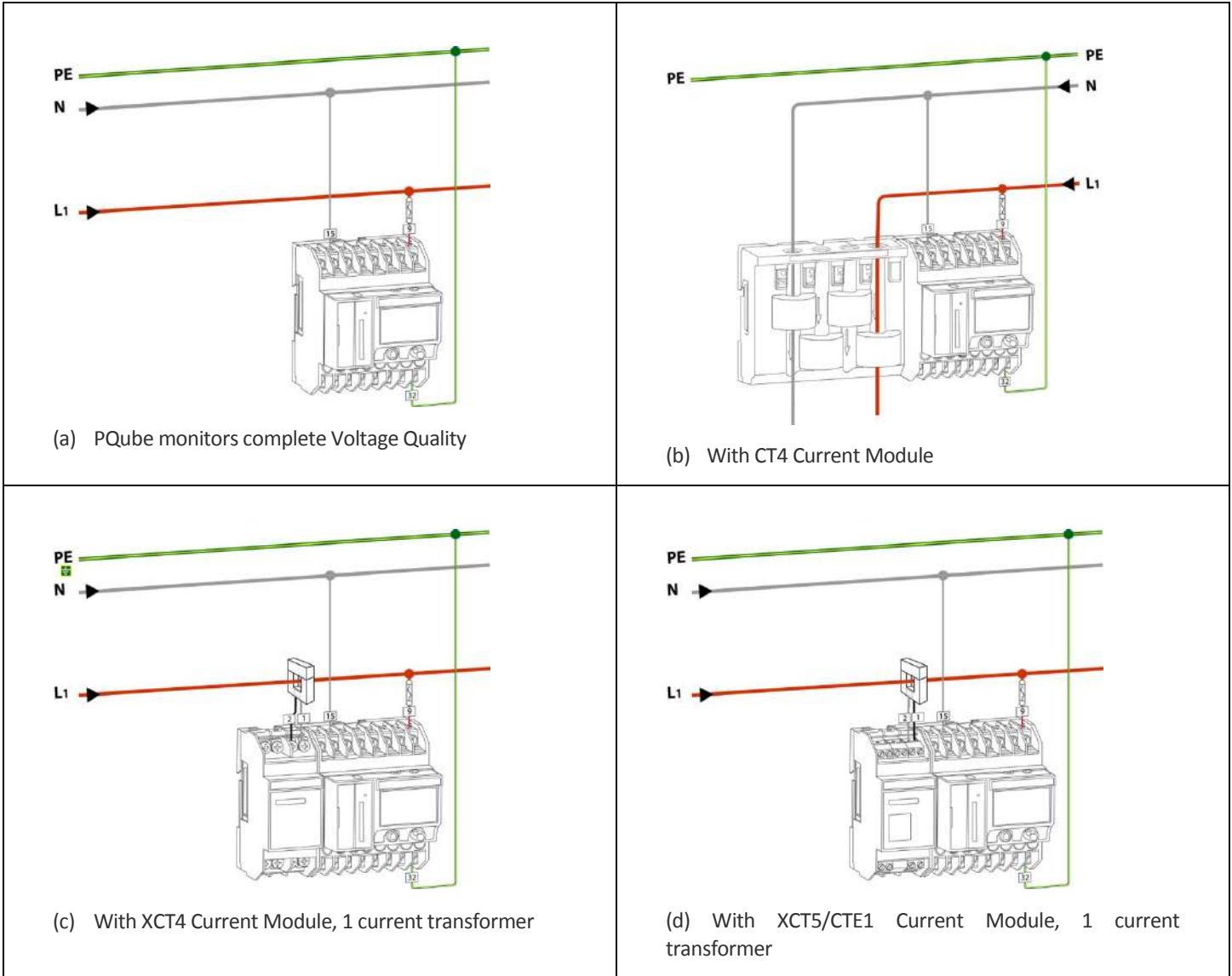

Split-Single-Phase L-N-L

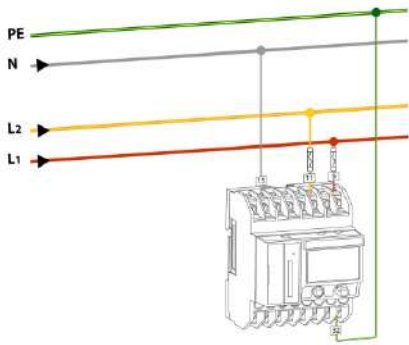

(a) PQube monitors complete Voltage Quality

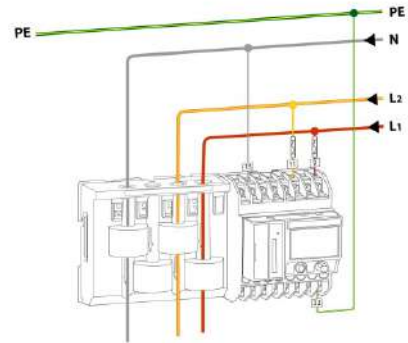

(b) With CT4 Current Module

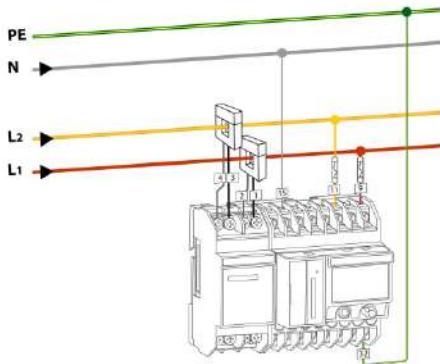

(c) With XCT4 Current Module, 2 current transformers

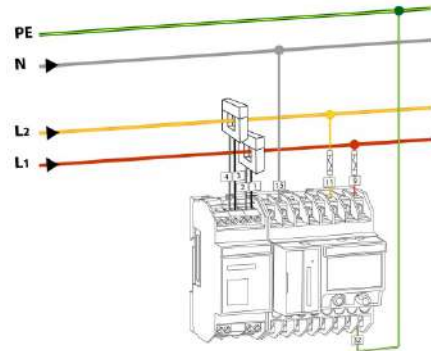

(d) With XCT5/CTE1 Current Module, 2 current transformers

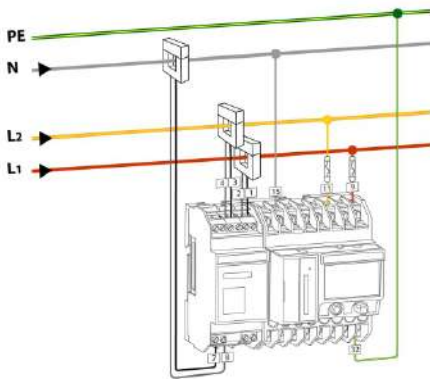

(e) With XCT4 Current Module, 3 current transformers

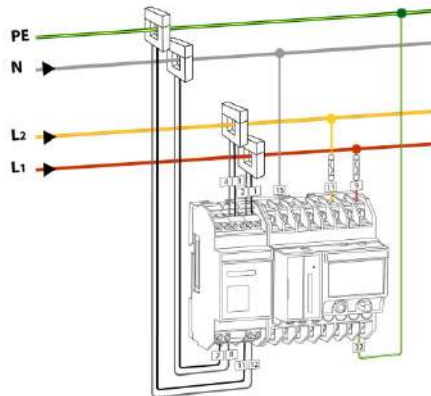

(f) With XCT5/CTE1 Current Module, 4 current transformers

Single-Phase L-L

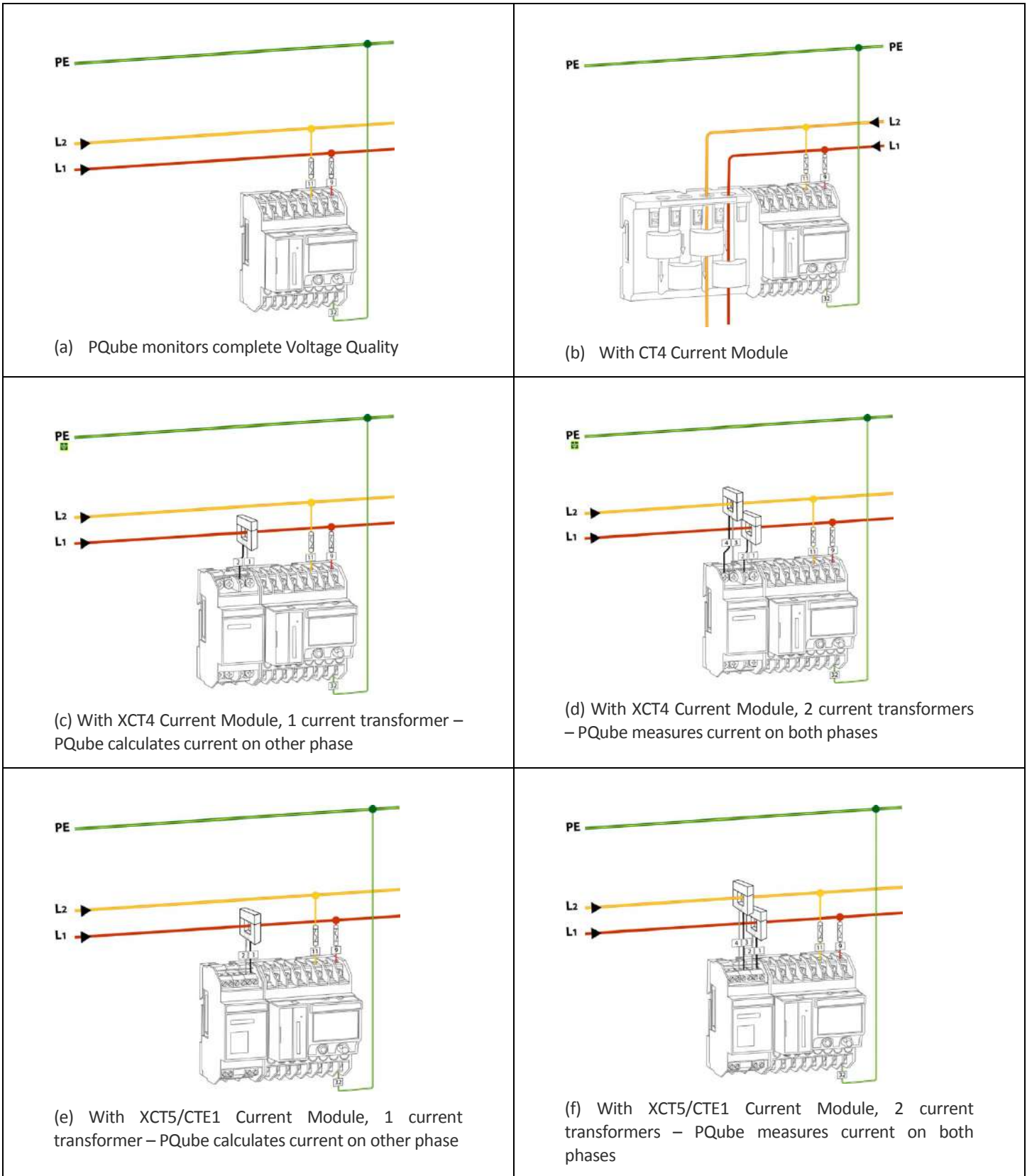

Delta

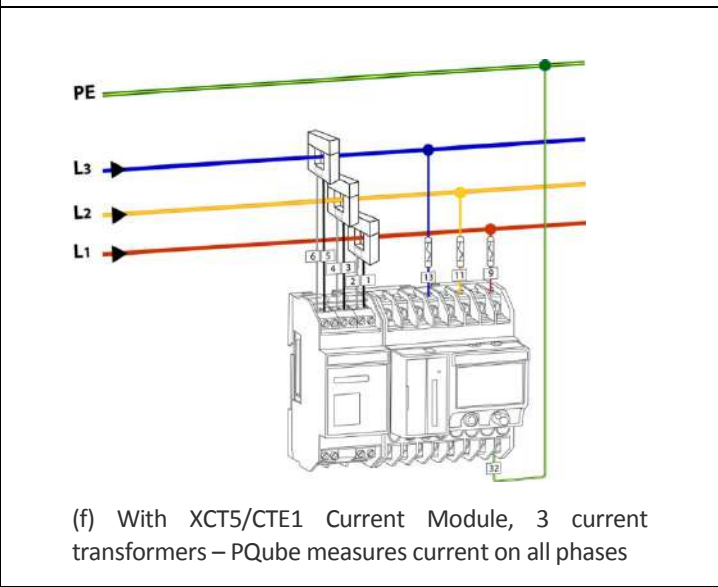
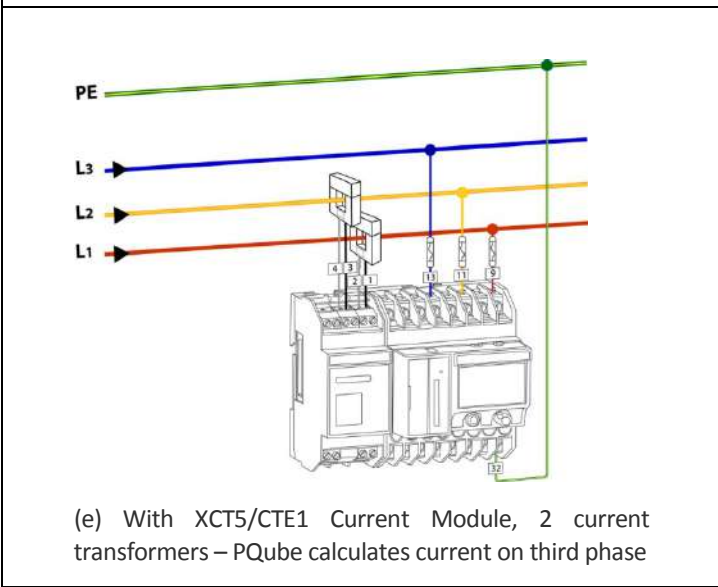
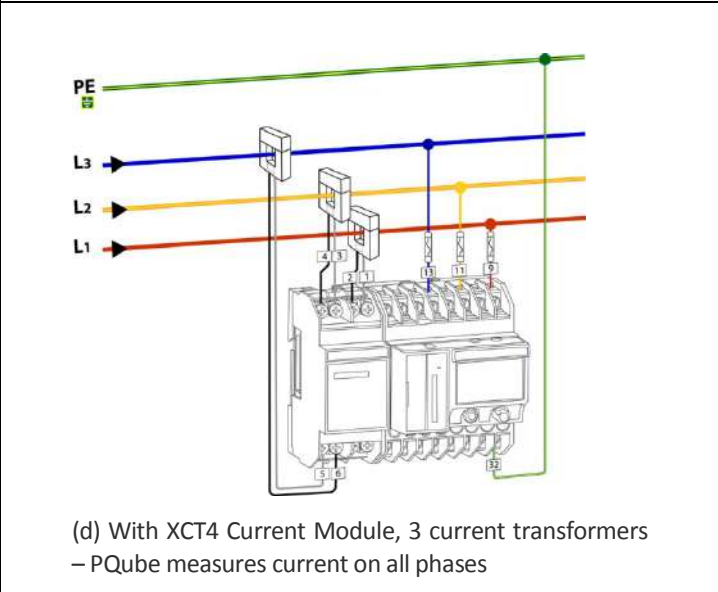
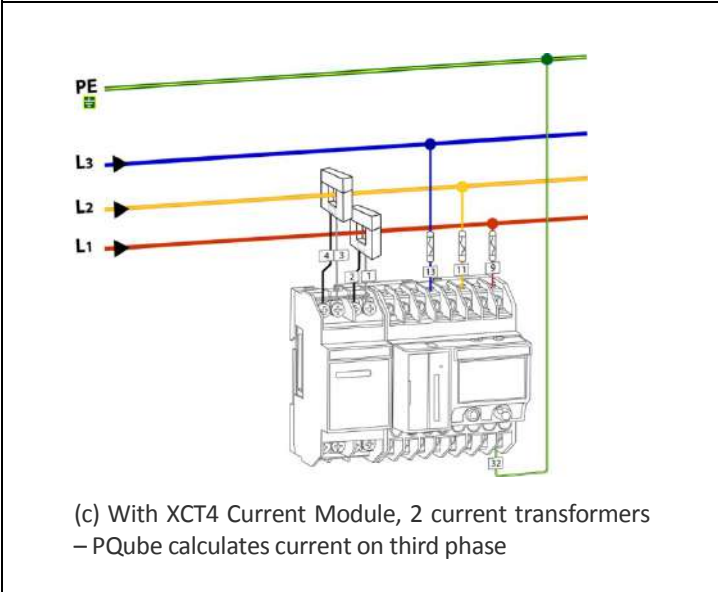
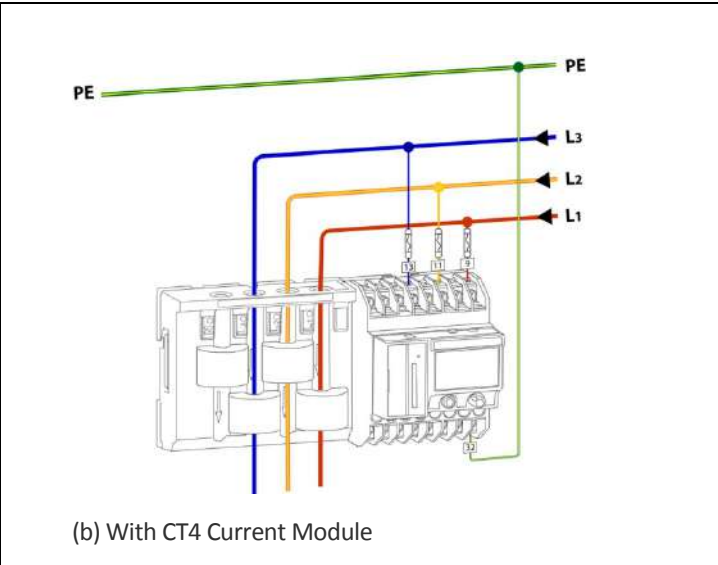
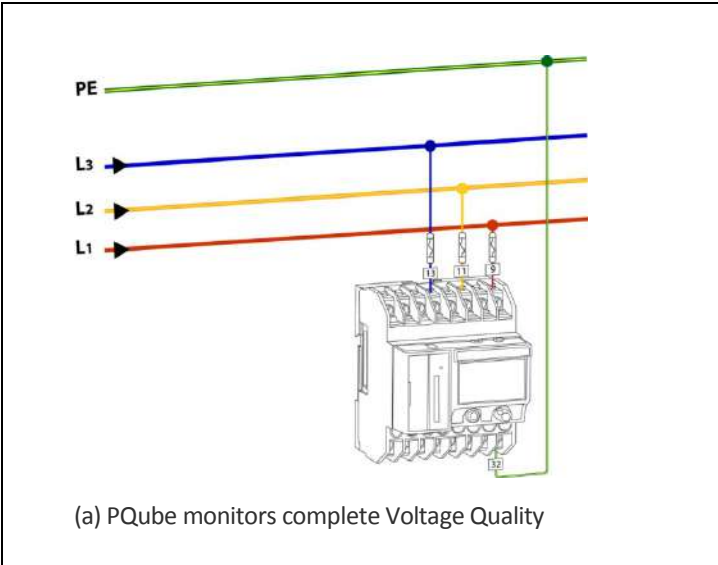

Wye/Star

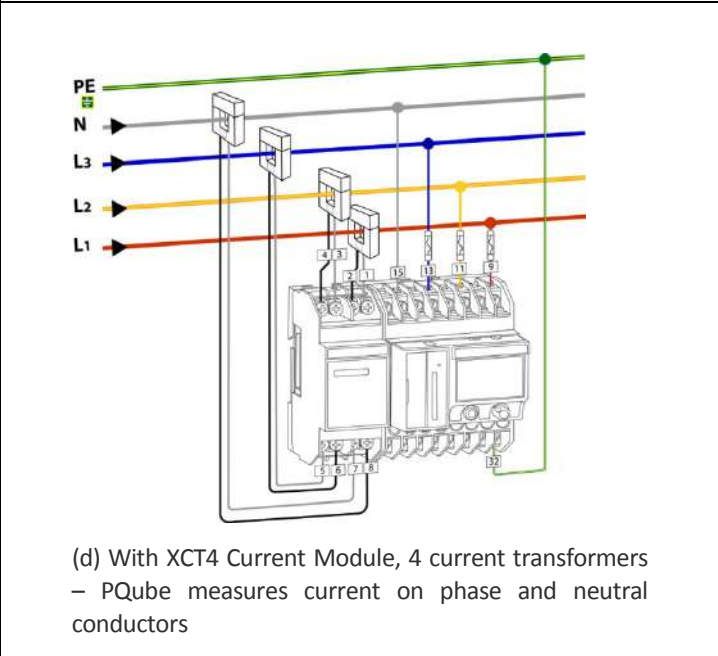
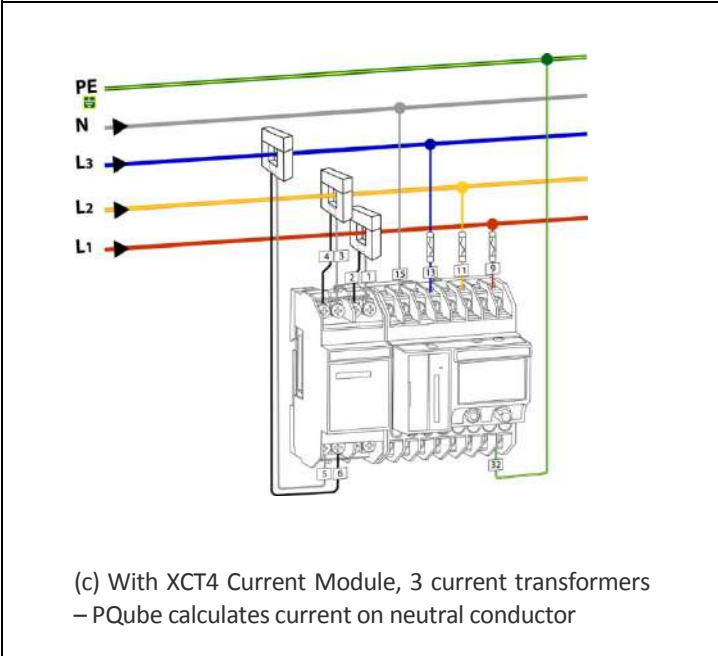
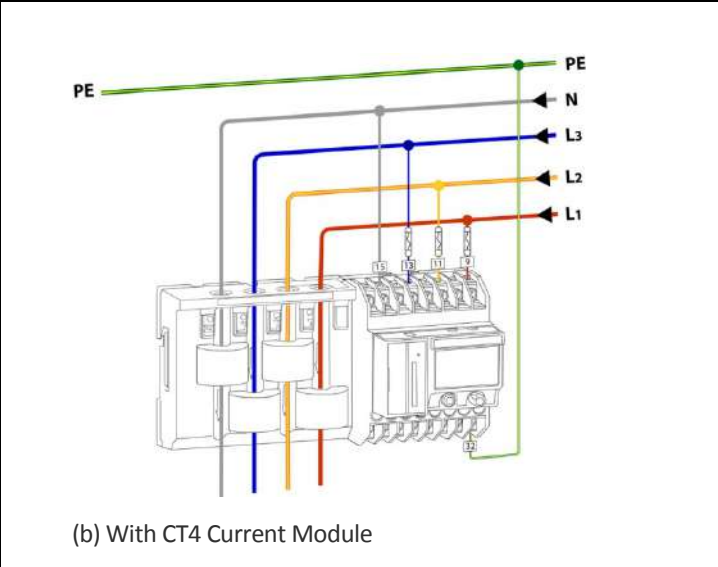
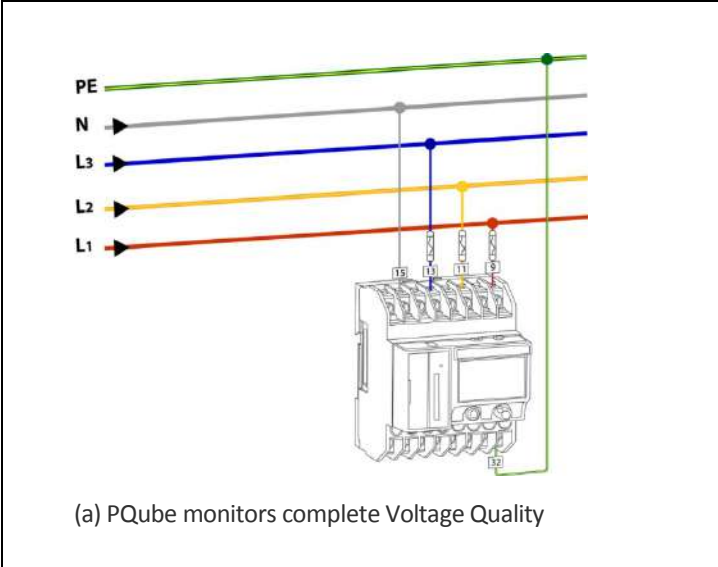

Wye/Star (continued)

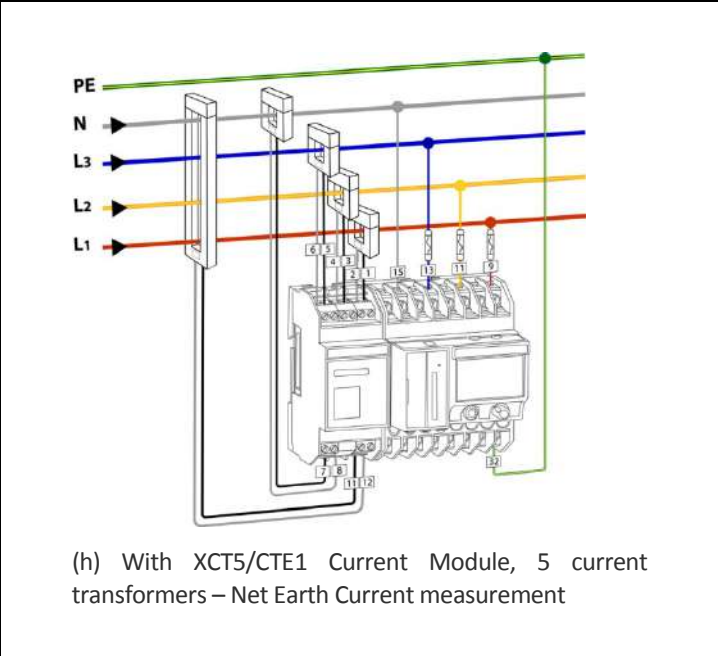
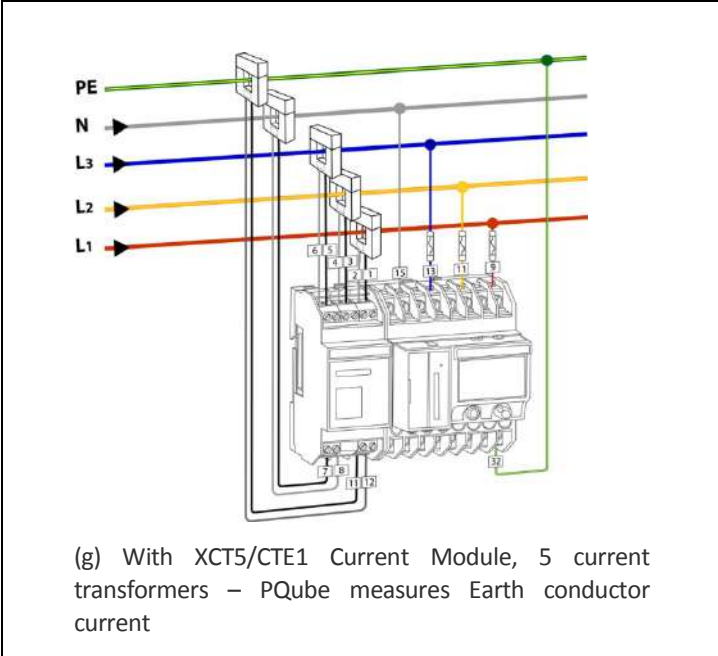
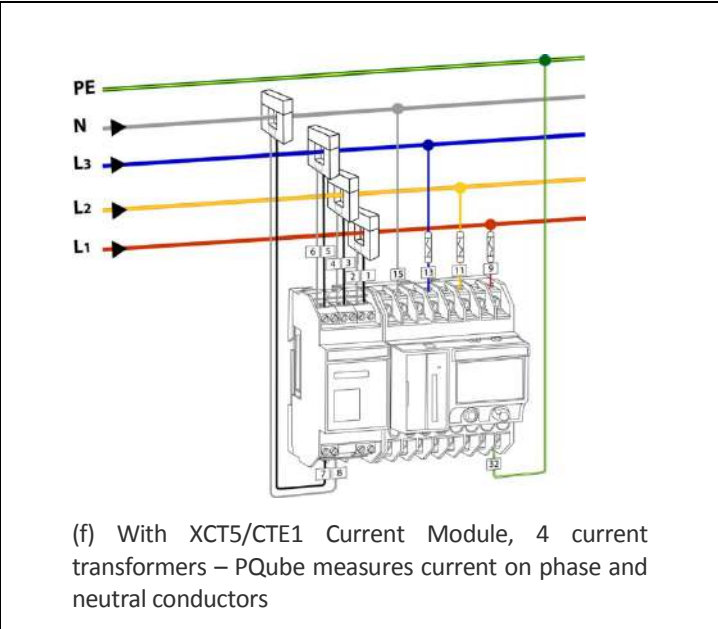
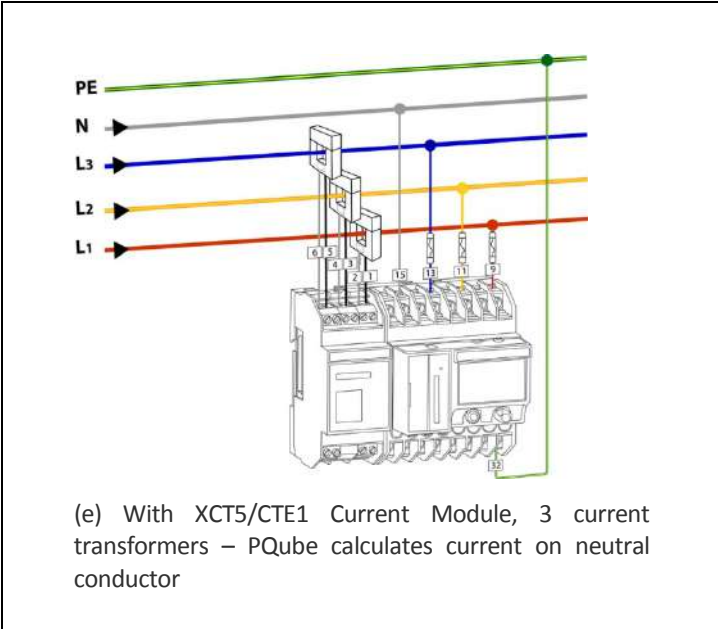

Overview of connections and controls

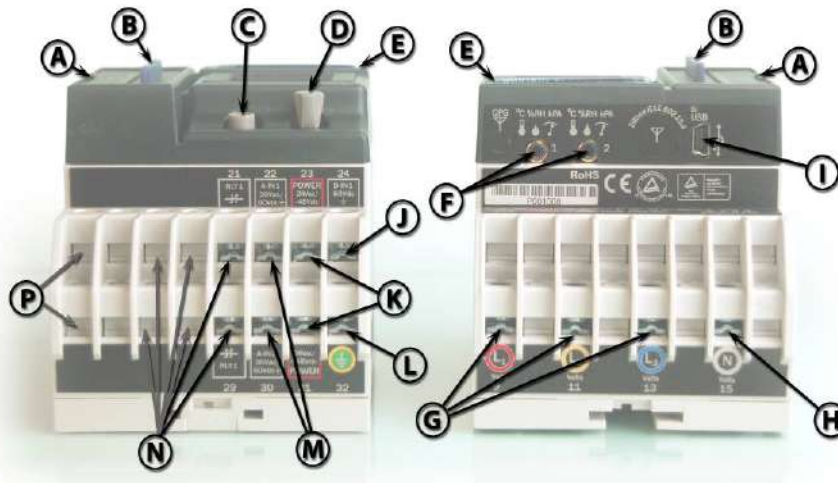

A	Battery compartment latch
B	SD memory card and adjacent LED
C	Select button
D	Joystick. Click like a button to return to main menu.
E	Heartbeat LED
F	Temperature/humidity probe inputs. Optically isolated from local earth.
G	L1, L2, L3 voltage inputs. 690Vrms max phase-to-phase (equivalent to 400Vrms phase-to-earth)
H	Neutral terminal – optional connection

I	USB port. Optically isolated from local earth. Factory use for Rev 1.2 firmware; user access in free future firmware upgrades.
J	Digital input. 60-volt tolerant. 1.5-volt threshold. Wetted with 5.4V at 3 microamps.
K	Power inputs. 24VAC, or 24VDC to 48VDC (either polarity) nominal. 15VA max.
L	Earth – functional. Used as the reference voltage.
M	Analog inputs. Maximum $\pm 60V$ to earth. Can be used as differential inputs.
N	Signal relay outputs. One is standard on all PQubes. Two more signal relay outputs are available as a factory-installed RLY option.
P	Relay contact output rated at 30VAC, 60VDC, 2 amps, - included in factory-installed RLY option.

Disconnect mains prior to servicing

Always disconnect all mains connections, and verify disconnections, prior to servicing.

Calibration Information for Your PQube

Every PQube is calibrated and traced to NIST at the factory. You can download a free NIST trace certificate that contains the specific calibration information for your PQube by entering your PQube’s serial number at www.powerstandards.com/CalibCerts.htm.

Setting up your PQube

Your PQube will work right out of the box. Simply follow the [Quickstart Guide \(page 11\)](#) and your PQube will begin recording data immediately. The default settings will work for most applications, but if you have special requirements you may need to change a few settings. Don't worry, it's an easy process.

Setting the Date and Time



You can set the time and date via your PQube's display. For information on how to use your PQube's display, see [Your PQube's Display and User Interface \(page 39\)](#). Go to the configuration menu and scroll to the Date/Time screen. Press the select button and then use the joystick to set the date and time.

Setting the date and time is important because all of the output files your PQube produces include a time stamp.

Note that if you have an ETH1 Ethernet module and you are using the SNTP feature (off by default), your PQube will override any changes you make to the date and time.

Setting Your Languages



In previous firmware versions, you set the language at the Languages screen on the PQube display.

In Firmware 1.4 and newer, you can specify up to two languages to be used in the PQube at any time in your setup file. Setting languages remotely is now possible, and the selected language(s) remain even after a firmware update.

```
PQube_Primary_Language=English-American
PQube_Secondary_Language=None
```

Check your Power Configuration



Everytime your PQube resets or starts up, make sure your PQube "locks" onto the appropriate power configuration, nominal voltage, and nominal frequency. This is important for proper event detection and data recording. Your PQube will not begin recording until it has locked onto the power configuration.

If you are using your PQube for DC monitoring only, and do not wish to record AC voltage, you can set your Power Configuration to "NONE" in your setup file.

Setting Your Potential Transformer Ratio

If you are using Potential Transformers (PT) to monitor voltages above 690Vac Phase-to-Phase (400Vac Phase-to-Earth) you can tell your PQube about the ratio to use to calculate the measured voltage. For example, to use your PQube on a 24 kilovolt distribution system, you might use a 100:1 potential transformer to reduce the 24 kilovolts to 240 volts. In your PQube's **Setup.ini** file, you would set

```
Potential_Transformer_Ratio=24000:240
```

Or, if you prefer, you could set

Potential_Transformer_Ratio=100:1

Note that, if you choose to set the nominal voltage in your PQube's **Setup.ini** file, you would set
Nominal_Phase_To_Neutral_Voltage=24000

even though the voltage at your PQube's terminals is 240 volts nominal.

Potential Transformers with Calibrated Ratios

In Firmware 2.1, you can now apply a gain correction factor for the mains voltage terminals, with a range of 0.95 to 1.05. Use with calibrated potential transformers to improve the accuracy of your measurements!

Example: Assuming a 10000:100 PT ratio, use the settings below:

PQube Configurator Settings:

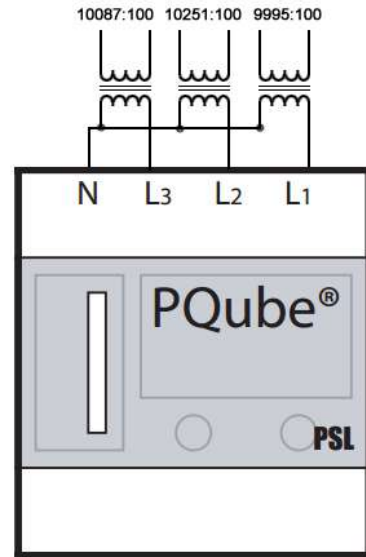
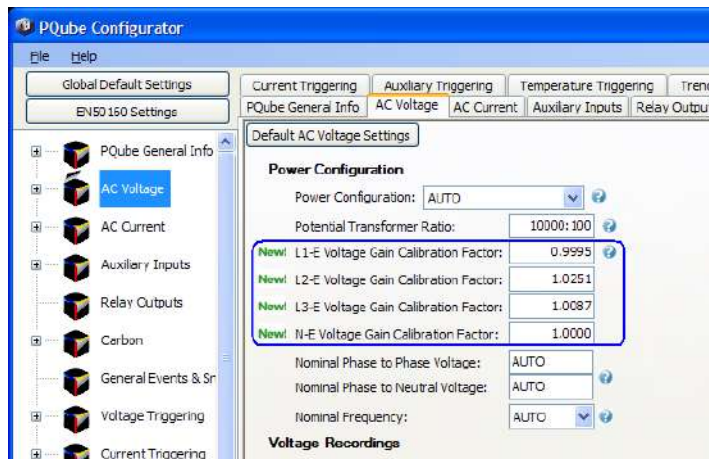

Setup.ini tags

```
; ----- Valid values: from 1:1 up to 500000:1
;         You can use fractional values such as 1250.5:120
;         If your application requires a ratio higher than 10000:1
;         please contact factory for additional information
```

```
Potential_Transformer_Ratio=10000:100
```

```
; ----- Valid values: from 0.95 up to 1.05
```

```
L1_E_Voltage_Gain_Calibration_Factor=0.9995
L2_E_Voltage_Gain_Calibration_Factor=1.0251
L3_E_Voltage_Gain_Calibration_Factor=1.0087
N_E_Voltage_Gain_Calibration_Factor=1.0000
```

Setting up Your Optional Current Module

Setting Current Transformer Ratio

If you are using a CT4 current sensing module, you don't need to set a CT ratio – your PQube will set it automatically.

If you are using an XCT4 or XCT5 current sensing module, you will need to set the CT ratio so that your PQube can correctly display the amount of current, as well as correctly calculate power and energy usage.

For example, to use your PQube on a system with 200 amps flowing in the power conductors, you might choose current transformers rated at 300 amps, with a 5-amp secondary. In your PQube's **Setup.ini** file, you would set

```
Current_Transformer_Ratio=300:5
```

If you have a current transformer with voltage output, simply enter the primary current and secondary voltage into your CT ratio. For example, if you have a current transformer rated at 300 amps, with 0.333V secondary, then you would set

```
Current_Transformer_Ratio=300:0.333
```

Inverting Current Channels

During installation, it is easy to make a mistake in your current transformer connections, either by reversing the secondary connections (when using an XCT4 or XCT5) or by feeding the main power conductor through your current transformer backwards (when using a CT4, XCT4 or XCT5).

You will know when the current transformers are installed backwards by looking at your power (watts) readings. If you are expecting positive watts values and you are getting negative watts (or vice versa), then you know your current transformers need to be inverted.

Of course, you can always correct your wiring; but an easier alternative is to use your PQube's **Setup.ini** file to invert one or more of your current channels. If you realize that you have installed your L2 current transformer backwards, you can fix this easily:

```
Invert_L1_Current_Channel=OFF  
Invert_L2_Current_Channel=ON  
Invert_L3_Current_Channel=OFF  
Invert_N_Current_Channel=OFF
```

Why Bother?

It is important to correctly connect your CTs (or use the method above to correct a wiring error). Power (watt) calculations are made by multiplying the instantaneous current by the instantaneous voltage. If one or more of your current transformers is incorrectly set up, your PQube will calculate negative power for that phase.

Calculating Current With a Missing CT

You do not need to connect CTs to all of the conductors that you want to monitor. When current flows through a system, the net current is always zero. Because of this, you can connect one fewer CT than you have conductors (for a delta system, you only need two CTs, for a wye/star system you only need 3 CTs, and you must calculate the Neutral current). Your PQube can calculate the

current in the missing CT. Note that if you calculate the current in a missing CT, your PQube will incorrectly show any earth current as flowing in the calculated phase.

If you want to use this feature, change the Calculate_Current_Channel setting in the **Setup.ini** file.

Fix installation errors, simply and easily

During installation, it is easy to make mistakes: maybe you accidentally wired your conductors to the wrong screw terminals, . Of course, you can always correct your wiring; but it's easier to use your PQube's **Setup.ini** file to swap the phase connections to the appropriate inputs. You can do this for the voltage and current inputs. For example, if you realize that L2 has been installed on the L3 input, you can fix this easily:

```
L1_Input_Connected_To=L1
L2_Input_Connected_To=L3
L3_Input_Connected_To=L2
N_Input_Connected_To=N
L1_Amps_Input_Connected_To=L1
L2_Amps_Input_Connected_To=L3
L3_Amps_Input_Connected_To=L2
N_Amps_Input_Connected_To=N
E_Amps_Input_Connected_To=E
```

NOTE: When phase swapping, remember that your PQube will not lock on and begin recording until either the L1-E or L2-E voltage exceeds 30 volts.

Setting Relays for Triggering on Events

The PQube triggers for many types of events. You can choose which of these events will open one or more relays. Each relay will remain open for 3 seconds or the event duration, whichever is longer. To change the relay settings, edit the **[Event_Relay_Trigger]** section. See Appendix 2.

Here are a few simple rules:

- You can connect any event to any relay.
- One relay may be connected to multiple events, and any event can be connected to multiple relays.
- RLY1 is standard. RLY2, RLY3, and RLY4 are included in the factory-installed RLY option.
- Enter 1, 2, 3, 4 (or any combination of those numbers) into the relay-event tags to attach that relay to that event.
- Enter OFF if you don't want that event to trigger a relay.

Example: to trigger RLY1 when a Voltage Dip or Swell occurs, set the following relay-event tags:

```
Trigger_Relay_On_Dip=1
Trigger_Relay_On_Swell=1
```

Example: to trigger RLY1 and RLY3 when an interruption occurs, set the following relay-event tags:

```
Trigger_Relay_On_Interruption=13
```

By default, all relay-event tags are set to OFF. This means no relays will be triggered on events.

Setting up Your Optional ETH1 Ethernet Module

Your ETH1 module requires some configuration before you can begin using it. To configure your ETH1 module, you need to make a few changes to the **Setup.ini** file on your SD card. Network Setup is required to use your ETH1 Ethernet Module. The other sections are optional.

Network Setup

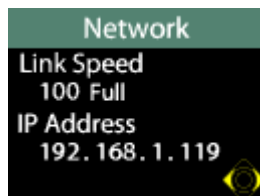

To set up your network connection, you may need to change the `IP_Address_Method` setting in the **Setup.ini** file

Your PQube supports two different methods to get network information. DHCP is the automatic method used on most modern networks and the default for your PQube. If your network supports DHCP and you use the `Use_DHCP` setting, simply plug in your PQube and it will get the network configuration automatically. If your network doesn't support DHCP, change this setting to `Use_Fixed_IP` and fill out the `[Fixed_IP]` section.

Your PQube displays its IP address when connected to a network. This allows you to easily access your PQube's Web Server without searching for your IP address elsewhere. This is useful if you are using DHCP.

Email Setup

Creating an e-mail account for your PQube

Your PQube needs its own email account in order to send email. This is because your PQube is an email client, just like your computer.

PQube.com email address

Your PQube comes with its own PQube.com email account! By default, all of the email server information is already filled out for you.

If you need to re-enter your PQube.com email information, follow these steps:

- Go to the **Email & Filter** tab in the PQube Configurator program
- Enter your PQube's serial number in the **PQube Serial Number** field.
- Click the **Generate PQube.com e-mail account** button and the program will automatically fill out your email server settings.

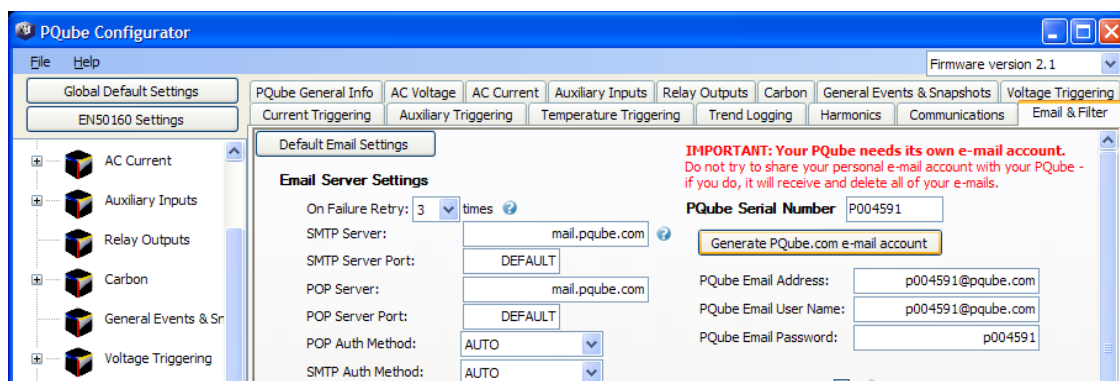

Your serial number can be found under the barcode on the rear label, or in the Logs filename.



OR

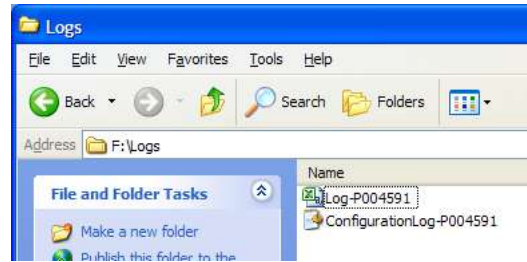

Creating an email account with your own domain

If you are unable to use the default PQube.com email account, you can create an email account for your PQube using your own domain. You will need to give your email system administrator some information, have him or her set up an account for your PQube, and then fill in the [Email_Server_Settings] section of the **Setup.ini** file on your SD card.

SMTP vs. POP

Simple Mail Transfer Protocol (SMTP) is the standard protocol for sending email while Post Office Protocol (POP) is the standard protocol for receiving email.

Setup Configuration

Please tell your System Administrator that:

- Your PQube is a standard e-mail client.
- For outgoing mail, your PQube supports plain-text authentication, Cram-MD5, or MD5-Digest login.
- For incoming mail, your PQube supports plain-text authentication, Cram-MD5, MD5-Digest, USER-PASS, or APOP login.
- Ask your System Administrator to set up an e-mail account, and get the following information from them:

SMTP Server: _____ Port: _____

POP Server: _____ Port: _____

PQube e-mail address: _____

PQube e-mail user name: _____

PQube e-mail password: _____

- Use this information to fill in your **Setup.ini** file.

WARNING

Do not assign your personal email address to your PQube. Your PQube must have its own dedicated email address that it can use to send and receive email. Power Standards Lab is not responsible for any loss of data.

Specify up to 10 email recipients

In the [Outgoing_Email] section, tell your PQube who to send emails to under the Email_To_1 field. You may enter up to 10 total email addresses to receive emails from the PQube.

Sending a test e-mail from your PQube

After you have set up your PQube to use email, it is a good idea to send a test e-mail from your PQube. Use the joystick to go to the “Send test e-mail” screen, just to the left of your “Configuration” menu, and select it. If your PQube sends an e-mail successfully, you will see a green check mark.



Click the button to send a test email



The email was sent successfully



There was an error sending the email

If your PQube could not send an e-mail, you will see an ERR number on the screen. The error number corresponds to one of the following problems:

- ERR 1: You don't have an Ethernet Module with compatible firmware, or it's not attached to your PQube properly.
- ERR 4: PQube sending e-mail: Your PQube had a problem opening the e-mail body file.
- ERR 6: PQube sending e-mail: No network connection is available. Check your Ethernet cable and router, and check your network settings in your **Setup.ini** file.
- ERR 7: PQube sending e-mail: Problem connecting to your e-mail SMTP server. Check that you have the correct SMTP server name in your **Setup.ini** file.
- ERR 8: PQube sending e-mail: Your PQube successfully connected to your e-mail SMTP server, but the authentication process failed. Check that you have the correct password, and e-mail address, and that your SMTP e-mail server supports one of the following authentication methods: plain text, CRAM MD5, MD5 Digest.
- ERR 9: PQube sending e-mail: Your PQube had a problem opening an attachment file.
- ERR 10: PQube sending e-mail: Error while receiving a reply from your e-mail SMTP server (Your PQube was expecting data from your SMTP server, but PQube never received the data.)
- ERR 11: PQube sending e-mail: E-mail rejected by your SMTP server (Your PQube transmitted the email, and the SMTP server got the email, but the SMTP server rejected the email for some reason.)
- ERR 12: PQube sending e-mail: response error while transmitting to your e-mail SMTP server (Your PQube connected to your SMTP server, but there was an error sending data to your server).
- ERR 13: Domain Name Server error (Your PQube couldn't connect to the Domain Name Server you specified, or there was an error during DNS transmission, or a bad response from DNS.)
- ERR 14: The Domain Name Server says that the domain name does not exist. Check the POP and SMTP and SNTP servers that you specified in your **Setup.ini** file.
- ERR 15: Your PQube recognizes that an ETH1 Ethernet module is connected, but it is unable to communicate with it. Your ETH1 may be starting up, and may not be ready yet – try again in a few seconds. If the problem persists, you may have a mis-match between your PQube firmware and your ETH1 firmware. Upgrade your PQube firmware.
- ERR 16: PQube sending e-mail: the “To:” field or the “From:” field is blank.
- ERR 17: PQube receiving e-mail: your POP server caused a Domain Name Server error. Check the POP server that you specified in your **Setup.ini** file.
- ERR 18: PQube receiving e-mail: Unable to connect to your POP server. Check the POP server that you specified in your **Setup.ini** file.
- ERR 19: PQube receiving e-mail: POP server authentication failed. Check the POP server that you specified in your **Setup.ini** file. Check that you have the correct password, and e-mail address, and that the e-mail server supports one of the following authentication methods: plain text, CRAM MD5, MD5 Digest.
- ERR 20: PQube receiving e-mail: Checking POP server inbox failed. Your PQube connected to your POP server, and

your POP server accepted your PQube's authentication, but for some reason refused to disclose the inbox contents.

ERR 21: PQube receiving e-mail: Error retrieving a message from your POP server inbox. Your PQube connected to your POP server, and your POP server accepted your PQube's authentication, and your POP server provide the list of inbox contents, but for some reason the transfer of a message from your POP server to your PQube failed.

ERR 254: Unknown e-mail error.

Web Server Setup

Your option ETH1 module includes a web server. When you can type the IP address of your PQube into your web browser, you will see a web site that contains all of the information that your PQube has recorded, as well as real-time meters and status information.

The web server is enabled by default and uses the default HTTP port 80. This means that you shouldn't need to change any settings to use the web server. If you need to use a different port, you can change the `Web_Server_port` setting in the `Setup.ini` file on your SD card.



For information on how to use your PQube's Web Server, see the [Web section \(page 64\)](#).

FTP Setup

Your PQube contains a FTP server that you can use to get files from your SD card. FTP (File Transfer Protocol) is a simple system used for transferring files between two computers that are connected by a network. The FTP server is enabled by default, you can enable it by changing the `FTP_Server` setting in the `Setup.ini` file to ON. You can also change the login and password for your FTP server by changing the `FTP_User_Name` and `FTP_Password` settings. For information on connecting to the FTP server see the [FTP section \(page 64\)](#).

Modbus Setup

Your ETH1 Ethernet module contains a Modbus-over-TCP slave device that you can use to read meters and determine when new event or trend recordings are available. You can set the Modbus TCP port by changing the `Modbus_TCP_port` setting in the `Setup.ini` file on the SD card of your PQube. You can also set the base address of the registers by changing the `Modbus_Register_Start_Address` setting.

Configure your Modbus client using the following settings:

Mode = TCP

"2 byte ID" disabled

Function code = 4

Minus offset = 0

Registers should be represented as 32 bit float except where noted.

NOTE: Under normal operation, your PQube will update all of its registers approximately once per second. However, you may experience delayed response times while your PQube is generating files for events and trends. These response times can range from a few seconds, up to several minutes, depending on which parameters are being recorded.

For a description of the available registers, see [*Appendix 1 \(page 71\)*](#).

Simple Network Management Protocol (SNMP)

A beta version of SNMP is included in Firmware 2.0. SNMP is a common meter reading protocol that is used in data centers worldwide. For easy SNMP installation, a PQube MIB file is included with 1.4 release files.

Use the following information to connect to your PQube:

SNMP port: 161

Get community string: pqube

Set community string: pqube

For a description of the available values in the MIB file, see [*Appendix 4 \(page 109\)*](#).

The Setup.ini File

Configure your PQube by editing the **Setup.ini** file on its SD card. This is a simple text file. You can edit it with any text editor, such as Notepad. Your PQube uses the standard INI file format. All you have to do is change the text after the equals signs (=).

When you plug an SD card into your PQube, your PQube will automatically reset itself, and then read your **Setup.ini** file. As it reads your **Setup.ini** file, your PQube will store your settings into its flash memory.

If you plug in an SD card that does not include a **Setup.ini** file, your PQube will use the Setup that it previously stored in its flash memory. So you can easily configure your PQube once, then use blank SD cards from then on. Note that you may want to copy the **Setup.ini** file and the language packs from the old SD card to make it easier to make changes to your PQube setup and make it possible to change the language settings.

For a description of the setup file tags, see [Appendix 2 \(page 78\)](#).

Location.gif

Location.gif is a photograph (usually) of where your PQube is installed. Your PQube automatically inserts it at the top right corner of your PQube's graphic output files.

- Your **Location.gif** file must be exactly 128 x 96 pixels;
- it *must* be normal row order (not interlaced);
- it *must* use the Web palette.

When you insert an SD card that contains a **Location.gif** file, your PQube will automatically reset itself, then store the **Location.gif** into its flash memory. It will permanently remember this picture until you replace it. (The storing process takes a few seconds, so you may want to delete the **Location.gif** file from your SD card after you have inserted it once.)

You can see your Location.gif on your PQube's display, one joystick click down from the bottom of the main menu.

Need help creating a Location.gif file? Send us an e-mail at Support@PowerStandards.com.

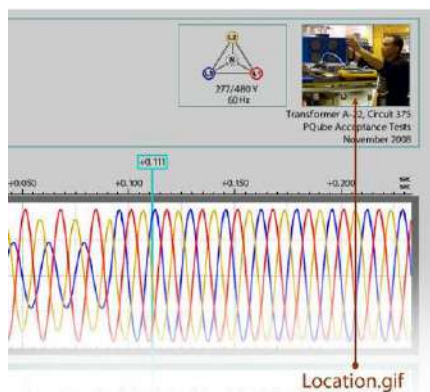

The locaton.gif picture appears in GIF graph output files.

DC Monitoring

With the new ATT2 module, you can monitor DC Current, DC Power, and DC Energy with your PQube.



Individual Ratios for each Analog channel

You can specify a separate ratio for the AN1-E channel and AN2-E channel. This is useful for measuring DC Voltage on AN1-E and DC Current on AN2-E. Edit your setup file and navigate to the [Analog_Ratios] section of your setup file. For example, if you have an ATT2-600V module with 50A:4V DC current sensor, use the following values:

```
; -- Valid values: from 1:1 up to 10000:1. You can use fractional values.
AN1-E_Channel_Ratio=100:1
AN2-E_Channel_Ratio=50:4
```

DC Power and Energy

Your PQube can multiply the AN1-E channel by the AN2-E channel to display DC Power. Connect your DC voltage source to AN1-E and the output of your DC current sensor to AN2-E, and your PQube will calculate the DC Power and Energy. Navigate to the [Analog_Ratios] section of your setup file and edit the following tag:

```
; ----- Valid Values: ON OFF
;           AN Energy Mode assumes that AN1 is voltage and AN2 is current,
;           and turns on AN power and energy measurements.
;           Turn this tag ON if using an optional ATT2 module.
AN_Energy_Mode=ON
```

Swap AN1 and AN2 in software

You can swap the AN1 and AN2 connections in your setup file, eliminating the need to physically swap the wires if they have been improperly installed.

```
; ----- Use this section to correct an installation error.
;           Valid values: ON, OFF
Swap_AN1_And_AN2_Connections=ON
```

Customize your Analog channels

You can customize the name of the AN1-E channel and AN2-E channel, and you can specify the measurement units.

```
; ----- Use this section of tags to customize the names and units of
your analog channels.
; Analog energy mode does not have to be on for this.
; Valid names can be up to 5 characters.
; Valid values for units are "V", "A", "W", "DEG", "%", "NONE"
Analog_1_Channel_Name="DCV"
Analog_1_Channel_Unit="V"
Analog_2_Channel_Name="DCA"
Analog_2_Channel_Unit="A"
```

User Guide

Using Your PQube

Your PQube's Display and User Interface

Joystick and button



Use the joystick (B) on the front of your PQube to navigate through the displays.

Gently push down on the joystick (B) like a button to return to the Main Menu. Click the button (A) to make a selection.

To force your PQube to reset, hold the button (A) down for 10 seconds.

The PQube Display

Use the joystick on the front of your PQube to navigate through these screens. Use the select button to choose an item outlined by an orange box.

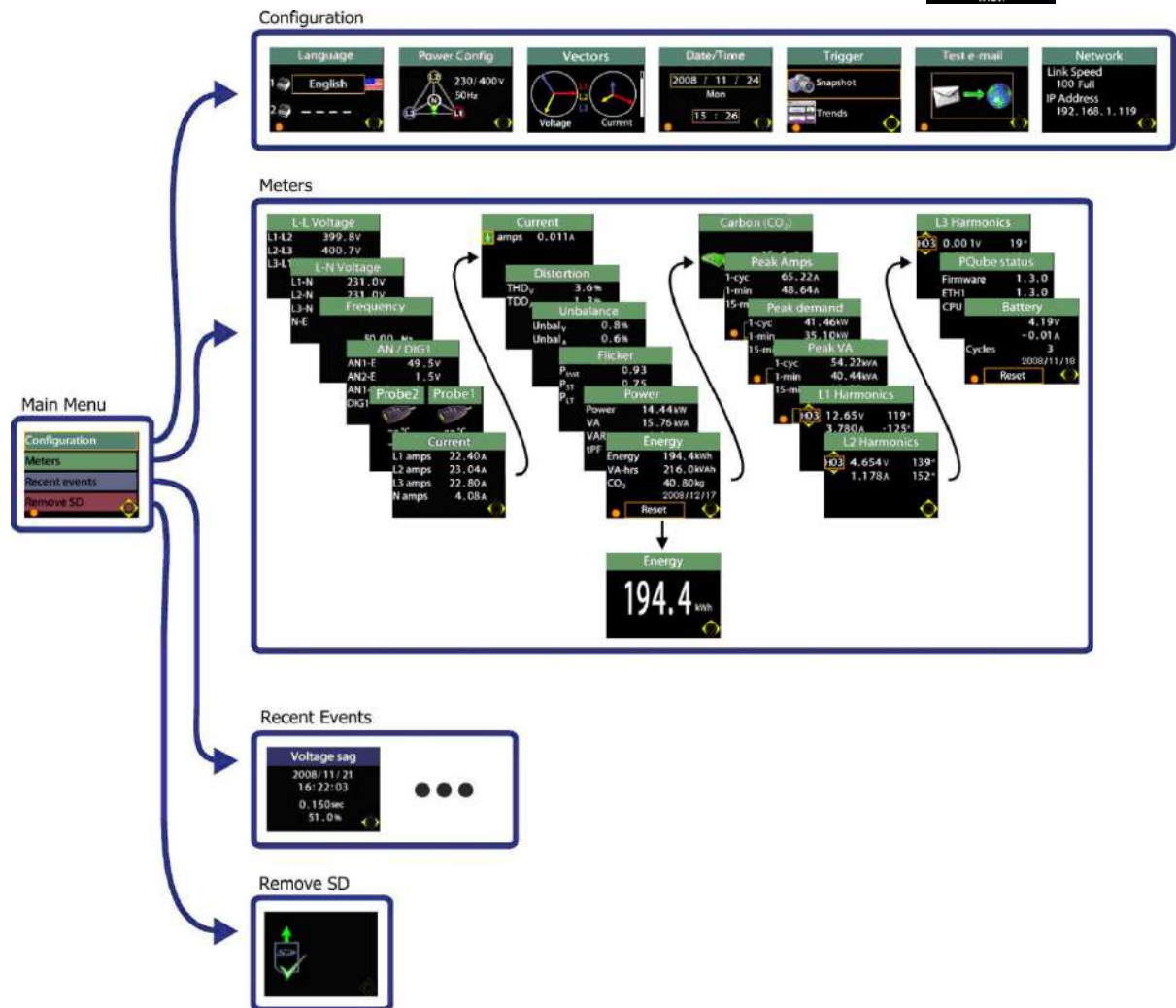

Configuration



Language: Language 1 sets your PQube’s main language, which is used for all of these screens and the GIF output graphs. Language 2, if you choose one, sets the second language on GIF output graphs. This can be useful if you expect to discuss these graphs with an engineer who reads another language.



Power configuration: This screen shows you the power configuration that your PQube is using. If your PQube is hunting for the correct power configuration, this screen will cycle through the various possible configurations until your PQube locks onto the correct configuration. Your PQube knows roughly 1,000 different possible power configurations used around the world, and can identify the correct configuration approximately 10 seconds after power has been applied to the terminals.

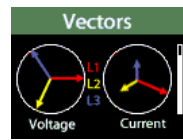

Vectors: Use this screen to verify that your voltage and current inputs are wired up correctly. Full scale voltage is determined by the nominal voltage found when the PQube locks onto the power configuration. The vertical bar on the right represents the largest phase magnitude of current. Its range is from zero amps to the value specified by the Max_Current_of_Interest_in_Amps tag in the **Setup.ini** file. (By default, it is set to the value shown on your current module, multiplied by the current transformer ratio specified in the **Setup.ini** tag Current_Transformer_Ratio).

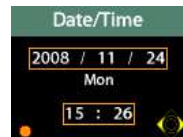

Date/time: Set your PQube’s internal clock-calendar. Your PQube will automatically set the correct day of week. If you have an ETH1 Ethernet Module, and you have enabled SNTP in your **Setup.ini** file, your PQube will automatically set its clock-calendar to UTC.



Trigger: Use this screen to trigger Snapshot files of your power, or to trigger Daily Trend and Statistics files. Use the joystick to choose, and press the Select button to begin generating the files. Snapshots will take about 5 minutes, and trends will take longer, depending on how much data you have recorded..



Test e-mail: Press the select button to send a test e-mail. If your e-mail succeeds, you will get a green check mark. If your e-mail does not go through, you will see a red X with an error message. See WARNING

Do not assign your personal email address to your PQube. Your PQube must have its own dedicated email address that it can use to send and receive email. Power Standards Lab is not responsible for any loss of data.

Specify up to 10 email recipients
In the [Outgoing_Email] section, tell your PQube who to send emails to under the Email_To_1 field. You may enter up to 10 total email addresses to receive emails from the PQube.

Sending a test e-mail from your PQube ([page 34](#)) for more information.

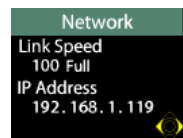

Network: Your PQube’s IP address and link speed can be found on this screen. This is useful if you have a dynamic IP address. It is also useful for troubleshooting connectivity issues.

Meters

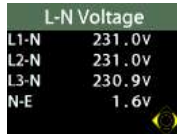

L-L voltage meters, L-N voltage meters: These are line-to-line, line-to-neutral, and neutral-to-earth true-RMS voltmeters. Different meters will show on these screens, depending on your power configuration. (For example, if the power configuration is “delta”, there will not be any L-N meters, because there is no neutral conductor.) If you have set a potential transformer ratio in your **Setup.ini** file, then these meters will use that ratio, so these meters will sometimes show their values in kilovolts or even megavolts.

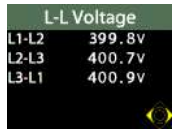

Frequency: This is a frequency meter. It is phase-locked to either L1-E or L2-E, depending on which channel has the best signal. It measures frequency by timing the zero-crossings, with a 5-pole analog low-pass filter and a 64-cycle digital low-pass filter.

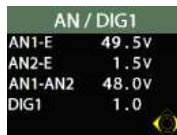

AN/DIG1: The AN meters show the RMS voltage (equivalent to DC voltage for DC signals) for the AN1 screw terminal to earth, AN2 screw terminal to earth, and AN1-to-AN2 differential voltage. The DIG1 meter shows the average value of the DIG1 digital input screw terminal with respect to earth, averaged over one cycle – useful when the DIG1 signal is changing rapidly, because it will show the duty cycle of the DIG1 signal.

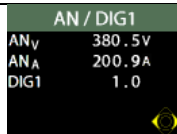

AN/DIG1 (AN_Energy_Mode only): With an ATT2 module, your PQube can monitor High Voltage DC systems. After you have enabled the AN_Energy_Mode tag in your setup file, AN1-E becomes AN_v (DC voltage) and AN2-E becomes AN_a (DC current).



A new screen also appears with DC Power and Energy. AN1-AN2 is replaced with AN-Power, which is the product of the DC voltage and DC current channels. DC Energy is also displayed here, and it can be reset from this screen.



Probe2 / Probe 1: These meters show the temperature and humidity of the two TH1 temperature-humidity probes. If one or both probes are not plugged in, the meters will show “--”.

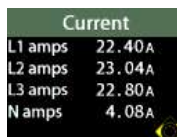

Current: These meters show the true-RMS current. They only appear if you have plugged in an optional XCT4 or XCT5 current transformer interface module, or a CT4 current sensing module. If you have set a current transformer ratio in your **Setup.ini** file, then these meters will use that ratio, so these meters will sometimes show their values in kilo-amps or even mega-amps. Different meters will show on this screen, depending on your power configuration. (For example, if the power configuration is “delta”, this screen will not show a neutral current meter, because there is no neutral conductor in delta power.)

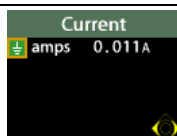

Current: This screen is a continuation of the previous screen above. It shows the true-RMS current on the earth conductor. You can choose in your **Setup.ini** file to calculate net current from phase and neutral current; or you can measure it with a CT, either on the earth conductor or with a net-current CT.



Distortion: These meters show the Total Harmonic Distortion (THD) of the voltage and Total Demand Distortion (IEEE 519 TDD) of the current (if you have an optional current sensing module installed).



Unbalance: These meters show the voltage unbalance and the current unbalance (if you have an optional current sensing module installed). You choose in your **Setup.ini** file whether your PQube calculates unbalance using the ANSI C84.1 method, or the IEC method, or the GB method.

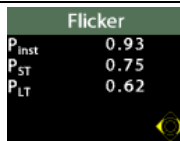

Flicker: These meters show flicker (IEC 61000-4-15). P_{inst} is the instantaneous flicker value for Incandescent Flicker in IEC 61000-4-15. P_{ST} is the short term flicker, a statistical analysis of P_{inst} after 10 minutes, synchronized to real-time clock. P_{LT} is the mean value of P_{inst} over previous 2 hours, synchronized to real-time clock.



Power: These are the true power readings, and they correctly handle harmonics (distorted voltages and distorted currents). If you have set a current transformer ratio and/or potential transformer ratio in your **Setup.ini** file, then these meters will use those ratios, so these meters can show their values in kilowatts, megawatts, or even gigawatts.

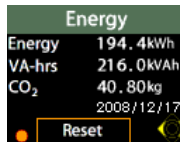

Energy: These three meters show the total energy, apparent energy, and carbon since the last reset of these meters. You can reset these meters by holding down the select button for 3 seconds. The date of the last reset will appear on the screen. You can reset these meters by holding down the select button for 3 seconds. The date of the last reset will appear on the screen.

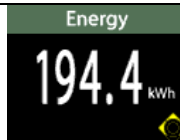

Energy: Access this screen by moving the joystick down from the Energy screen above. Here, you can view energy in large digits specified in ANSI C12.20.

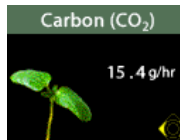

Carbon: This meter shows the intensity of carbon dioxide output, based roughly from the EPA's measurements for typical California, USA values. You may edit these values in the **Setup.ini** file as necessary.

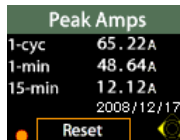

Peak amps: These three meters show the cycle-by-cycle highest RMS amps; the 1-minute interval with the highest RMS amps; and the N-minute interval with the highest RMS amps. (The highest RMS amps value is determined by looking at the highest among all of the active phase conductors. It excludes the neutral conductor.) The N-minute reading is usually set to 15 minutes, but you can set it to a value between 3 minutes and 60 minutes in your **Setup.ini** file. The 1-minute and N-minute readings are automatically synchronized to your PQube's real time clock. These readings can be useful for evaluating inrush current and circuit breaker settings, and for sizing power conditioning devices such as UPS and voltage regulating transformers. You can reset these meters by holding down the select button for 3 seconds. The date of the last reset will appear on the screen.

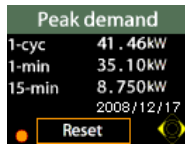

Peak demand: These three meters show the cycle-by-cycle highest kilowatt reading; the 1-minute interval with the highest RMS kilowatt reading; and the N-minute interval with the highest kilowatt reading. The N-minute reading is usually set to 15 minutes, but you can set it to a value between 3 minutes and 60 minutes in your **Setup.ini** file. The 1-minute and N-minute readings are automatically synchronized to your PQube’s real time clock. You can reset these meters by holding down the select button for 3 seconds. The date of the last reset will appear on the screen.

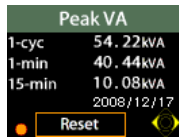

Peak VA: These three meters show the cycle-by-cycle highest volt-amp reading; the 1-minute interval with the highest RMS volt-amp reading; and the N-minute interval with the highest volt-amp reading. The N-minute reading is usually set to 15 minutes, but you can set it to a value between 3 minutes and 60 minutes in your **Setup.ini** file. The 1-minute and N-minute readings are automatically synchronized to your PQube’s real time clock. You can reset these meters by holding down the select button for 3 seconds. The date of the last reset will appear on the screen.

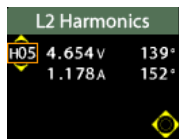
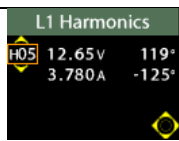

L1, L2, L3 Harmonics: Use these screens to view the magnitude and angle of every harmonic up to the 50th for both voltage and current. Select one harmonic at a time. The selected harmonic on one channel will also appear on the other channels. (Harmonic values up to the 63rd are recorded in your PQube’s CSV files.)

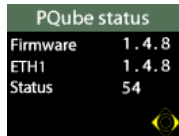
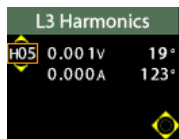

PQube Status: This screen shows you the release version of your PQube’s firmware and the release version of your ETH1 Ethernet Module’s firmware if it is installed. It also shows you the temperature of the hottest CPU inside your PQube. A temperature lower than 80°C is typical.



Battery: Your PQube’s battery voltage will typically be between 3.3V and 4.2 volts. Positive current shows that your PQube is charging its battery; negative current shows that your PQube is taking power from its battery. Cycle count shows the number of times your PQube has taken power from this battery. You can reset the cycle count by holding down the select button for 3 seconds. The date shows the last time the cycle count was reset.

Recent Events



Your PQube displays the 6 most recent events. (Your PQube stores up to 40,000 events on its SD card, depending on the size of the SD card and the type of events.)

Remove SD Card



You can safely remove the SD memory card from your PQube when you see this screen with a green check mark. Remove the SD card by pressing it down gently, then let it pop up. Your PQube will automatically reset when you re-insert a SD card.

Inserting and Removing Your SD Card



To insert the SD card, push it gently into the slot until it clicks. Your PQube will automatically reset itself.

To remove the SD card, go to the menu screen and select “Remove SD Card”. Wait until you see a green check mark, then push the SD card in gently, then release. Removing the SD card before you see the green check mark may corrupt the data on the SD card.



There is a light next to the SD card.

SD card light	Meaning
Flashing Red	SD card is missing
Green	Normal
Orange or intermittent red	PQube is writing to SD card – do not remove it. Wait until light is green.

Different brands of SD cards have substantially different speeds. Your PQube requires Sandisk® brand SD cards, purchased directly from Power Standards Lab. Your PQube supports SD cards with capacities up to 16 Gigabytes.

When your SD card becomes nearly full, your PQube will automatically delete the oldest month of data. However, if you wish to preserve your old data, you can choose to stop recording data when the SD card nears full capacity by editing the Behavior_When_SD_Card_is_Full tag in your Setup.ini file.

What Channels Does My PQube Measure?

Standard PQube Channels

Mains AC voltage measurements

Nominal voltages

All PQubes measure single-phase and three-phase voltages.

All PQubes can be connected to single-phase, split-single-phase, delta, wye or star. In addition, all PQubes can be connected to any standard earthing system: corner earth, center earth, or single-phase end earth.

All PQubes can measure power systems with the following nominal voltages: 69V, 100V, 120V, 200V, 208V, 230V, 240V, 277V, 350V, 400V, 480V, 600V, and 690V (maximum 400V with respect to Earth).

All PQubes can measure power systems with nominal frequencies of 50 Hz, 60 Hz, and 400 Hz.

Sampling and accuracy

RMS measurements are better than $\pm 0.1\%$ of nominal voltage, and sampled at 256 samples per cycle to ensure full accuracy for all measurements.

Your PQube's sampling rate is automatically locked to the frequency, and tracks the frequency as it changes at a rate of up to ± 3 Hz per second.

Frequency

Voltage frequency measurements are phase-locked to either L1-E or L2-E, depending on which channel has the best signal. It measures frequency by timing the zero-crossings, with a 5-pole analog low-pass filter and a 64-cycle digital low-pass filter.

Voltage Distortion (THD)

THD is a measurement of the amount of voltage harmonics present in the voltage waveform. Your PQube uses a Discrete Fourier Transform of phase-locked 256-samples-per cycle to calculate total harmonic distortion.

Voltage Unbalance

Voltage unbalance is a measurement of the difference in the magnitude voltages in a three-phase system. This measurement is disabled if the power system being monitored is not three-phase. Your PQube measures the unbalance of the voltage waveform using your choice of the following definitions:

ANSI/IEEE Method

Widely used in the North America, the ANSI method only considers the RMS magnitudes on each phase. Compared to the IEC method, the ANSI method is simpler, because it ignores harmonics and phase angles. For small unbalance values, these two methods provide very similar results.

IEC Method

In the IEC unbalance method, only the fundamental voltage and/or current is considered. The IEC method takes into account both the magnitude and angle of the fundamental, and produces two different unbalance measures: zero-sequence unbalance, and negative-sequence unbalance.

GB Method

Used primarily in China, the GB method is a time-smoothed variation on the IEC method.

Voltage and Current – Harmonics and Interharmonics

Voltage harmonics are available in absolute volts or percent of fundamental. Use the Voltage_Harmonics tag in the Measurement Setup section in your setup file. Total distortion for voltage is reported as THD.

Current harmonics are available in absolute amps or percent of fundamental, using the Current_Harmonics tag in your setup file. If you choose absolute amps, total distortion for current

is reported as TDD. If you choose percent of fundamental, then the total distortion for current is reported as THD.

There are three ways to retrieve harmonics from your PQube:

PQube Meter Display

On the PQube Meter display, use the joystick to choose any individual harmonic. You will see the voltage magnitude and angle for each individual phase (on three meter screens).

Snapshots

In your **Setup.ini** file, you can set your PQube to take full snapshots every 3, 6, or 24 hours. Each snapshot includes full harmonic and interharmonic spectra. The data is available in GIF images, CSV spreadsheets, and PQDIF format.

Harmonic Trends in CSV

In your **Setup.ini** file, you can set your PQube to trend harmonics every 10 or 15 minutes. Turn this feature on to create a folder called “Trend Harmonic” in your daily recordings. Inside this folder, you will find one CSV spreadsheet for each phase voltage. There are 193 columns in each CSV file: the magnitude, angle, and interharmonic magnitude of 63 harmonics. Each row in the file represents a particular time – the first column tells you the date and time for the row. (This feature creates exclusively CSV files, not GIF or PQDIF.)

Harmonic of Interest

View harmonics in real time using the Harmonic of Interest. You can change the harmonic order on the PQube display, Web Server, Email, or Modbus. Your Harmonic of Interest remains, even after your PQube resets.

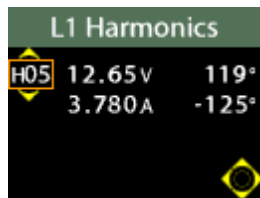

Web Server

Navigate to the Harmonic section under the Meters tab. Enter your desired harmonic (between 1 and 50) and click “Set Harmonic of Interest” to set your Harmonic of Interest.

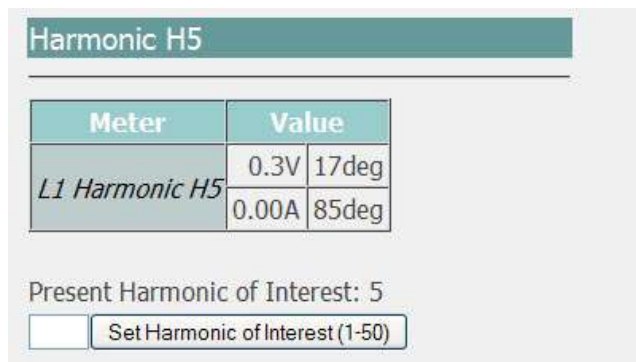

Email

The email command is “Set Harmonic of Interest to #” (case sensitive). It must be preceded by the word specified by the “Subject_Must_Begin_With” tag in your setup file. For example, if this word

is “PQube” and you wanted to monitor the 7th harmonic, then you would send your PQube an email with subject “PQube Set Harmonic Order of Interest to 7” to set your Harmonic of Interest.

Modbus

Register 166 is now writable; simply write your desired Harmonic of Interest (as integer).

Flicker

In Firmware 2.0, your PQube calculates Incandescent Flicker using methods based on IEC 61000-4-15. Flicker has three components: P_{inst} , P_{ST} , and P_{LT} . P_{inst} is instantaneous flicker. P_{ST} is the short term flicker over 10 minutes, synchronized to real-time clock. P_{LT} is the aggregate value of twelve consecutive P_{ST} measurements over 2 hours, synchronized to a real-time clock. Choose between 120V/60Hz or 230V/50Hz lamp voltage by editing the Flicker_Lamp_Voltage tag in the [Measurement_Setup] section of your Setup file.

Auxiliary Analog Measurements

Your PQube has two auxiliary analog input screw terminals labeled **AN1** and **AN2**. These channels operate in either **HIGH** range or **LOW** range. In **HIGH** range, you can monitor signals up to $\pm 100V$ with respect to your PQube’s Earth terminal. For smaller signals, you can use **LOW** range to monitor signals up to $\pm 10V$ with respect to your PQube’s Earth terminal.

Use these terminals to monitor anything with a voltage output. One common use for these screw terminals is to monitor a -48VDC system, or to monitor a 24VAC or 24VDC system. For example, you might connect these AN monitoring terminals to your PQube’s **POWER** terminals.

Your PQube can monitor the voltages between each of these terminals and the earth connection (**AN1-E** and **AN2-E**), and/or the voltage between these two terminals (**AN1-AN2**). If using an ATT2 module for measuring DC voltage and DC current, you can also monitor the product of the two channels (**AN1xAN2**) to calculate your power, and track accumulated energy (**AN1xAN2 x hours**).

It monitors these terminals for voltage dips and swells. An event on these terminals can be used to trigger a waveform recording on all channels. And events on the mains terminals can include the waveforms on these auxiliary analog measurements, too.

If you wish to use these channels, you will want to enable the channel so that it is recorded in event files. Enable the appropriate channels in the [Channels] section of the **Setup.ini** file on your PQube’s SD card.

Digital Input

Your PQube has a single digital input called DIG1. It is a voltage input with respect to your PQube’s Earth terminal.

It is rated at 60VDC or 30VAC, maximum, with respect to earth. The digital input is wetted with +5.4Vdc at 3 μ A, and has a logic threshold of approximately +1.5V with respect to your PQube’s earth terminal. The digital input can be connected to dry contacts, TTL or open-collector outputs, or logic signals that are 5Vdc, 12Vdc, 24Vdc, or any other signal less than 60Vdc or 30VAC.

There is an inherent digital-filter time constant of approximately 1 millisecond on this DIG1 input.

Recordings of events on the mains terminals include state of the digital input if you turn the channel on in the **Setup.ini** file.

You can use your PQube’s digital input to monitor the state of a switch or a logic signal.

Additional Channels Available With Optional Current Module

Mains Current Measurements

There are two optional types of current inputs into your PQube.

The optional CT4-20A current sense module allows you to measure up to 20 amps directly (limited by insulated conductor diameter). Simply pass the mains conductors through the CT4 module.

The optional XCT4-1A and XCT4-5A current transformer interface modules work with external current transformers, with 1-amp or 5-amp secondaries.

The optional XCT5-0.333V, XCT5-01V, XCT5-05V, and XCT5-10V current transformer interface modules work with external current sensors, with 0.333-volt, 1-volt, 5-volt, or 10-volt outputs.

The crest factor for all PQube current modules is 3.5 (in other words, a PQube current module that is rated at 100 amps can measure instantaneous current up to ± 350 amps).



CT4 Module (attached to a PQube)



XCT4 Module (attached to a PQube)

Full-Scale Current and Noise with Current Transformers

Your full-scale current is the CT Ratio multiplied by the full scale of your external current sensing module (XCT4 or XCT5). For example, if you are using 100A:0.333V current transformers with an XCT5-0.333V module, your full scale current would be $100/0.333$ multiplied by 0.333, or 100A. Your PQube uses this value to determine the full scale power.

With no load, you may experience small noise levels that are roughly 0.5% of full scale current. This noise is extremely small relative to full scale current. But with large CT ratios, you may see a significant noise value on the PQube display. This does not affect your power (kW) readings, since your PQube will zero out the reading if the kW reading is below 1% of full scale power.

You can choose to force the current reading to read zero on the display if the current is below a specified threshold. In the [Measurement_Setup] section of your **Setup.ini** file, find the `Minimum_Current_Display_In_Percent_Of_Rated_Current` tag. By default, this value is 0. Any nonzero number here will set the current to zero when it is less than the value specified here, as well as the corresponding VA, Power, and other current-dependent parameters. 1% is a recommended starting point if you want to use this feature.

Note that at 10% of full scale or higher, noise becomes a non-factor.

Current Distortion (TDD)

Total Demand Distortion (TDD) is a measure of the harmonic distortion of the current your PQube is monitoring. Instead of comparing the amount of harmonics to the amount of the fundamental (the method used in THD), TDD compares the amount of current harmonics to the total available current. You can change the total current used for the calculation by changing the `TDD_Available_Current_in_Amps` setting in your **Setup.ini** file on your SD card. See Standard IEEE 519 for a full explanation of TDD.

Current Unbalance

Current unbalance is a measurement of the difference in the magnitude voltages in a three-phase system. Your PQube measures the unbalance of the current waveform using the definition from ANSI C84.1. This measurement is disabled if the power system being monitored is not three-phase.

Power

Your PQube makes true power readings, correctly handling harmonics (distorted voltages and distorted currents). Your PQube measures watts, VA, and tPF. “VA” is apparent power, the product of the RMS voltage times the RMS current. Your PQube correctly calculates VA and Power for all power configurations, including delta configurations, for which it creates a digital metering neutral. “tPF” is true power factor, the ratio of watts to volt-amps. (This is different from dPF, which is the cosine of the angle between the voltage fundamental and the current fundamental.) VAR’s are calculated using the (default) Budeanu algorithm and Fundamental algorithm. Fundamental VARs are calculated based on 10/12 cycle data, and these measurements are not gapless.

Energy

Your PQube measures the amount of energy you have used (both energy - Wh, apparent energy – VAh, and accumulated VARs – VAR-h). Your PQube will accumulate energy until you reset the counter. You can reset the energy reading using the display on your PQube (go to the Energy screen in the Meter section and hold down the action button for 3 seconds).

Carbon

Your PQube uses a patent pending method to calculate the amount of CO₂ produced by the energy consumption monitored. In order to use this feature you will need to determine the amount of carbon produced by the different type of power your local utility uses, as well as the mixture of the different types. Once you have this information, you can configure the `[Carbon_Intensity]` and `[Power_Generation_Breakdown]` sections of the **Setup.ini** file on your SD card.

Temperature and Humidity

Optionally, you can plug one or two TH1 temperature-humidity probes into your PQube. The probes may be located at your PQube, or they may be extended up to 20 meters from your PQube with any 2.5mm stereo audio cable. Choose between degrees Celsius or Fahrenheit in your **Setup.ini** file.

All data flow to and from the temperature-humidity probe is digital, which reduces noise issues. The temperature-humidity probes are electrically isolated from your PQube. This arrangement eliminates ground loop issues.



PQube Recordings

Event and Snapshot Recordings

When your PQube detects an event, it records information about the event to its SD card. You can remove the SD card to look at this data, look at the recent events screen of the display, or (if you have an optional ETH1 Ethernet module) you can get emails about the event or even look at the event using your web browser. However you look at the event, the data is always the same.

Interpreting Event and Snapshot Recordings

PQube Event and Snapshot recordings contain the details of the event recorded (for example, Voltage Dip recordings include the precise start time of the event, the duration of the event, and the magnitude of the event)

Most events also include the waveforms for the beginning and end of the event, as well as the RMS measurements for the beginning and end of the event. If multiple events occur very close together (within about 30 seconds of each other) your PQube will record all events, but will only store waveform and RMS data for the first event. This is because your PQube is still clearing the space that it requires to record the information. It is important to note that, as long as your PQube is running, it is almost impossible for it to miss an event (your PQube can miss an event if more than 4 events of any one type occur within 4 seconds of each other).

During an event, your PQube will always be sampling the voltage at 256 samples per cycle. You can change the number of samples per cycle written to an event recording (256, 128, 64, or 32 samples per cycle) by changing the Recorded_Samples_Per_Cycle setting in the **Setup.ini** file on your SD card.

Why would I want fewer samples per cycle in my recordings?

Your PQube Records 1024 samples at the beginning of an event and 1024 samples at the end of an event. If your PQube is configured to record at 256 samples per cycle, it will record 4 cycles at the beginning and 4 cycles at the end of the event ($1024/256=4$). If you set the recording rate lower, you get a longer recording (with fewer points per cycle).

For example, if you choose 64 samples per cycle, your PQube will continue to sample at 256 samples per cycle, but the output recording will be written at 64 samples per cycle. Your Event recordings will have 16 cycles at the beginning and 16 cycles at the end of the event ($1024/64=16$).

Of course, you always get many cycles of RMS values: 10 seconds of data at 50Hz or 8.5 seconds of data at 60Hz, regardless of the number of samples per cycle you choose to record. The RMS is the 1-cycle average, refreshed every half cycle.

NEW for Firmware 2.0: Instead of recording 1024 samples at the beginning of event, and 1024 samples at the end of event, you can now record 2048 samples at the beginning of event in exchange for discarding the end-of-event data.

For RMS measurements, instead of measuring the 1-cycle RMS refreshed every half cycle, you can now choose to record the RMS every 1 cycle. This doubles your RMS graphs from 10 seconds to 20 seconds at 50Hz, and from 8.5 seconds to 17 seconds at 60 Hz.

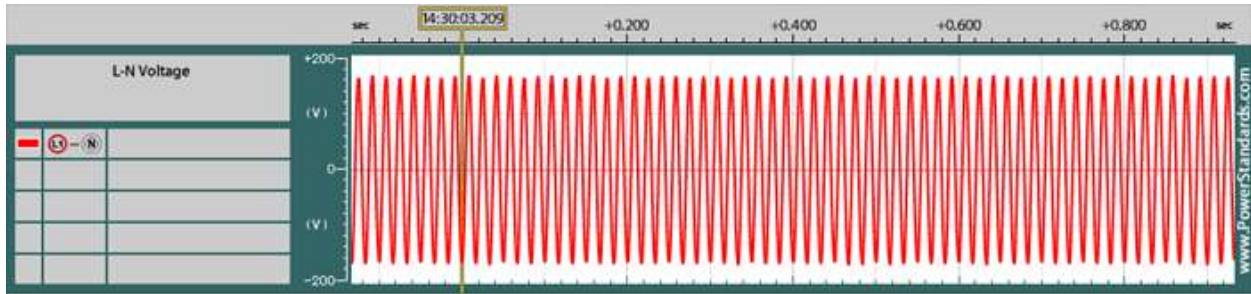

Waveform Snapshot recorded at 32 samples per cycle

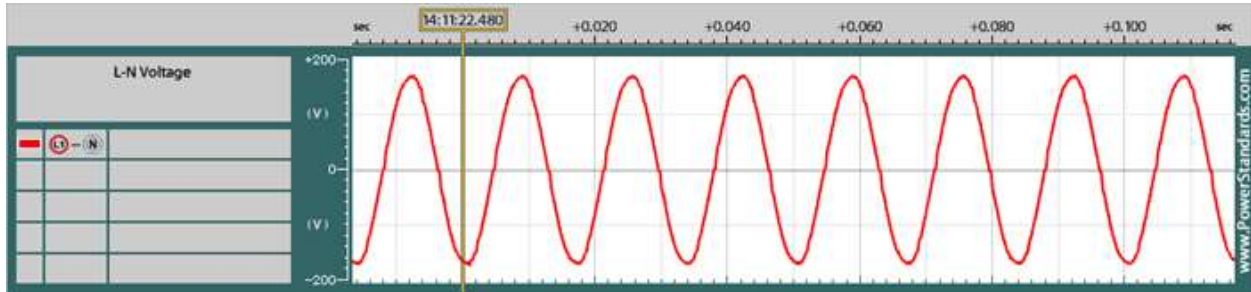

Waveform Snapshot recorded at 256 samples per cycle

Event Graph Headers

Every event graph has information in the header that tells you details about the event recorded and information about your PQube that recorded the event. This makes it easy to send a graph file to another person without having to explain the context of the recording.

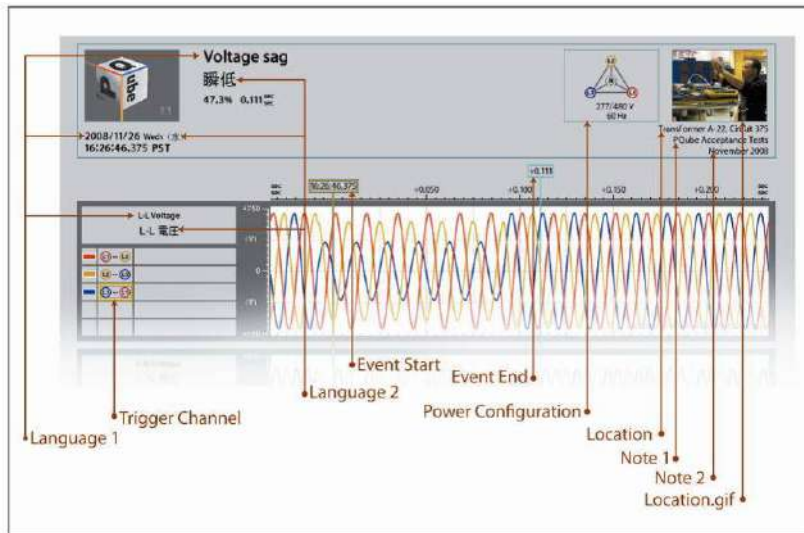

Waveform Recordings

Events that include waveform recording will include the exact same data in both a GIF graph file and a CSV spreadsheet file. Waveform recordings are useful for looking at the fine details of what happened when an event began and ended. If you prefer an overview of the event, consider using the RMS recording.

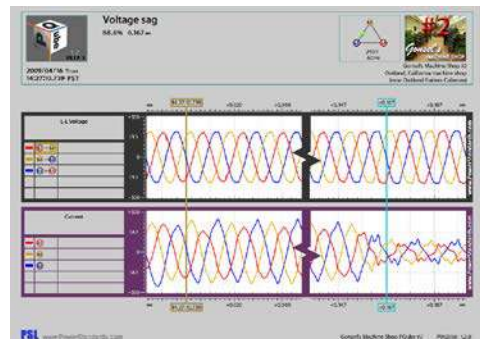

RMS Recordings

Events that include RMS recording will include the exact same data in both a GIF graph file and a CSV spreadsheet file. Voltage RMS recordings give you a good overview of what happened before, during, and after the event. RMS recordings use the $RMS_{1/2}$ reading to get the average reading over the course of a cycle. Because your PQube records the average reading per cycle, RMS recording cover more time than waveform recordings.

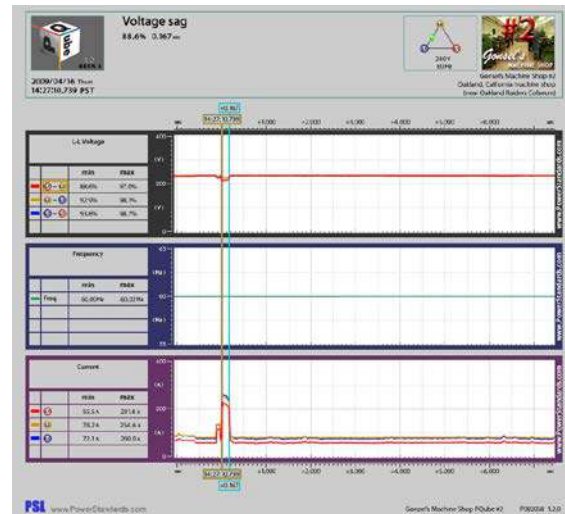

Channels available in Events and Snapshots

- L-N Voltage
- L-L Voltage
- N-E Voltage
- Frequency (RMS graphs only)
- Current
- Earth Current
- Analog Channels
- Digital Input
- Budeanu VARs and Fundamental VARs (CSV files only)

Voltage Dips

A voltage dip is a brief decrease in the line voltage. Dips are most typically caused by large loads starting nearby or by faults elsewhere on the power system. Your PQube records voltage dips according to IEC 61000-4-30 class A. A dip begins when the 1-cycle RMS of any voltage goes below the threshold (90% of nominal by default) and ends when all voltages are above the threshold, plus the hysteresis setting (90% threshold + 2% hysteresis = 92% by default). You can change the threshold for voltage swells by changing the settings in the [Phase_To_Neutral_Events] and [Phase_To_Phase_Events] sections of the **Setup.ini** file on your SD card.

Voltage Swells

A voltage swell is a brief increase in the line voltage. Your PQube records voltage swells according to IEC 61000-4-30 class A. A swell begins when the 1-cycle RMS of any voltage goes above the threshold (110% of nominal by default) and ends when all voltages are beneath the threshold,

minus the hysteresis setting (110% threshold – 2% hysteresis = 108% by default). You can change the threshold for voltage swells by changing the settings in the [Phase_To_Neutral_Events] and [Phase_To_Phase_Events] sections of the **Setup.ini** file on your SD card.

Voltage Interruptions

A voltage interruption occurs when all the line voltage goes away (such as when a breaker trips). Your PQube records voltage interruptions according to IEC 61000-4-30 class A. An interruption begins when the 1-cycle RMS of all voltage channels go below the threshold (10% of nominal by default) and ends when any voltage is above the threshold, plus the hysteresis setting (10% threshold + 2% hysteresis = 12% by default). You can change the threshold for voltage interruptions by changing the settings in the [Phase_To_Neutral_Events] and [Phase_To_Phase_Events] sections of the **Setup.ini** file on your SD card. Note that by definition, any voltage interruption is also a voltage dip, so your PQube will record each voltage interruption as two overlapping events (a dip and an interruption).

Frequency Variations

Your PQube records underfrequency and overfrequency events. Each type of event is triggered when the frequency goes under a threshold (99.5% by default) or over a threshold (100.5% by default), respectively. Underfrequency and overfrequency events end when the voltage frequency approaches the nominal again. You can change the threshold for underfrequency and overfrequency events by changing the settings in the [Frequency_Events] section of the **Setup.ini** file on your SD card.

High Frequency Impulses

Your PQube includes special hardware used to detect high frequency impulses. These sensors monitor L1-E, L2-E, L3-E and filter out everything but high frequency events. Your PQube will detect an impulse with a $\pm 450V$ (or more) peak that lasts for as little as 1 microsecond.

When your PQube detects a high frequency impulse it will make a standard event recording. Note that the sampling rate of your PQube is 256 samples per cycle, so you may not see the impulse in the recording, but the exact time of the impulse is marked and recorded.

Analog Dips and Swells

Your PQube includes two analog input channels called AN1 and AN2. You can set up a trigger to record an event when your PQube detects a dip or a swell on AN1-Earth, AN2-Earth, or AN1-AN2. You can enable these events and set the thresholds in the [AN1_E_Events], [AN2_E_Events], and [AN1_AN2_Events] sections of the **Setup.ini** file on your PQube's SD card.

If you enable these events, you will also want to enable the channel so that it is recorded in event files. Enable the appropriate channels in the [Channels] section of the **Setup.ini** file on your PQube's SD card.

If you enable these events, be sure to set the dip and swell voltages carefully. It is important that you not be "stuck" in an event, as this will prevent your PQube from writing updates about new events. For example, if you connect AN1-Earth to a 24V nominal signal, but you set the swell threshold to 20 volts, your PQube will start recording a swell immediately, but it will never finish that event.

Snapshots

Your PQube records events when it senses a problem with the electric power. This information about problems is useful, but sometimes it can also be helpful to see what your electric power looks like when there isn't a problem. Snapshots show you what your PQube is monitoring and are triggered by an internal timer in your PQube (instead of a power quality event). Snapshots record all of the same information that any other event recording includes.

To configure this feature, you can change the `Waveform_Snapshot_Interval_In_Hours` setting in the `Setup.ini` file on your PQube's SD card. Valid settings are OFF, 3, 6, or 24.

Snapshot Harmonics – Voltage and Current

Your PQube can generate voltage and current harmonic spectra up to the 50th whenever it generates snapshot files – the corresponding CSV files go up to the 63rd harmonic. Edit the tag called `Enable_Snapshot_Harmonics` in your `Setup.ini` file and set it to **ON**. Your sampling rate will be set to 128 samples per cycle to measure harmonics.

The harmonic spectrum is calculated from a 10/12 cycle sample, using IEC 61000-4-7 methods. For long term harmonic trending, please refer to the `Trend_Settings` section in your `Setup.ini` file and edit the `Trend_Harmonic_Interval_In_Minutes` tag.

Long Events

A long event is an event that is 1 minute or longer. In general, your PQube makes its reports after an event concludes: this is necessary to determine the event duration, the worst-case voltage during the event, and so on. But if an event hasn't concluded after 1 minute, your PQube will report that an event is in progress. At the conclusion of the event, the PQube will report the beginning timestamp plus the total duration. Waveform and RMS data will be available at the beginning and end of event. For example, this can be useful for long interruptions where your PQube loses instrument power.

Counter Events

Your PQube never misses an event. Sometimes many events can happen in very quick succession. If other event(s) occur while your PQube is processing recorded data, your PQube will record text events; and if it is overwhelmed by text events, your PQube will count the number of events as a last resort.

Major Dip

Your PQube supports full PQ1 Power Quality Relay emulation. In the `Setup.ini` file, locate the tag called "`Major_Dip_Threshold_Settings`" and select a threshold curve from the following standards: ITIC, CBEMA, SEMI_F47, STANDARD, SAMSUNG_POWER_VACCINE, MIL_STD_704E, MIL_STD_1399, and CUSTOM.

If a voltage dip exceeds the selected threshold, it will trigger a Major Dip event.

CUSTOM

In firmware 2.1, you may customize your own Major Dip ride through curve with up to 4 depth/duration points. To use this function, make sure the `Major_Dip_Threshold_Settings` in the `Setup.ini` file is set to **CUSTOM**, and locate the following tags:

```
Major_Dip_Threshold_Level_1_in_Percent=OFF
```

```
Major_Dip_Threshold_Level_1_Duration_in_Seconds=0
```

Waveshape Change

Your PQube triggers a Waveshape Change when the voltage waveform changes abruptly. It uses the “Floating Window” algorithm to compare each cycle to the previous cycle. It is especially useful for detecting Power Factor Correction capacitor switching. In your **Setup.ini** file, locate the following tags:

Voltage_Threshold_In_Percent_Of_Nominal=20.00

Duration_Threshold_In_Percent_Of_Cycle=10.00

If the voltage change from one cycle to the next exceeds the selected threshold, for the selected duration or longer, your PQube will trigger a Waveshape Change.

Temperature/Humidity Triggers

In Firmware 2.1, you can trigger temperature and humidity events with a TH1 probe. Each event recording is complete with magnitude, duration, and timestamp. Specify upper and lower thresholds for temperature and/or humidity.

Your PQube will send two email notifications:

1. When the temperature/humidity first exceeds the threshold, your PQube will send you a notification for an Incomplete Event. It will include the start time and the trigger threshold.
2. You will receive a second email when the temperature/humidity comes back within the threshold, plus hysteresis. It will include the timestamp, maximum or minimum value during the event, and duration.

Probe 1 Overtemperature - 2.1 New Features Guide

PQube Information

Location: 2.1 New Features Guide
 PQube ID: PQube 2.1
 Note 1: Sample Email
 Note 2: Overtemperature Event
 PQube Serial Number: P002616
 Model Number: PQube 01-0000
 Firmware Version: 2.1.0 #2831
 IP Address: 172.17.4.101

Configuration

Power Configuration: Single Phase L1-N
 Nominal Line-to-Neutral Voltage: 120V
 Nominal Frequency: 60Hz

Incomplete Event

Event Type: Probe 1 Overtemperature
 Trigger Date: 2012/08/24
 Trigger Day of Week: Friday
 Trigger Time: T 18:04:45.785 PDT
 Trigger Threshold: 60.0deg C

Data from the PSL PQube® by www.PowerStandards.com

Probe 1 Overtemperature - 2.1 New Features Guide

PQube Information

Location: 2.1 New Features Guide
 PQube ID: PQube 2.1
 Note 1: Sample Email
 Note 2: Overtemperature Event
 PQube Serial Number: P002616
 Model Number: PQube 01-0000
 Firmware Version: 2.1.0 #2831
 IP Address: 172.17.4.101

Configuration

Power Configuration: Single Phase L1-N
 Nominal Line-to-Neutral Voltage: 120V
 Nominal Frequency: 60Hz

Event

Event Type: Probe 1 Overtemperature
 Event Magnitude: 73.20deg C
 Event Duration in Seconds: 139.664
 Trigger Date: 2012/08/24
 Trigger Day of Week: Friday
 Trigger Time: T 18:04:45.785 PDT
 Trigger Threshold: 60.0deg C

Data from the PSL PQube® by www.PowerStandards.com

Current Triggering

Your PQube triggers events on the Phase Current channels, the Neutral Current channel, and the Earth Current channel. There are two ways to trigger a current event:

Overcurrent

You can set the overcurrent threshold by editing the tags called **Level_Threshold_In_Amps** and the **Level_Hysteresis_In_Amps** in your **Setup.ini** file.

Your PQube will trigger if any RMS current exceeds the level threshold.

Inrush

Inrush triggers have thresholds for magnitude and time. You can set these values by locating the tags called **Inrush_Threshold_In_Amps** and **Inrush_Threshold_In_Cycles** in your **Setup.ini** file. If the current increases by the Inrush Threshold value or more, within the specified time period or less, the PQube will trigger an inrush current event.

Trends and Statistics Recordings

Your PQube records minimum/ average/ maximum strip charts, cumulative probability statistics, and load duration statistics. By default, your PQube will record all of this information over the course of each day, week, and month.

Trends and statistics recordings give you information about what happened on the systems that your PQube is monitoring, even if there weren't any events.

These recordings include readings every minute (for daily recordings) or every 5 minutes (for weekly and monthly recordings). Your PQube contains the average reading every one or five minutes as well as the minimum and maximum updated five times a second.

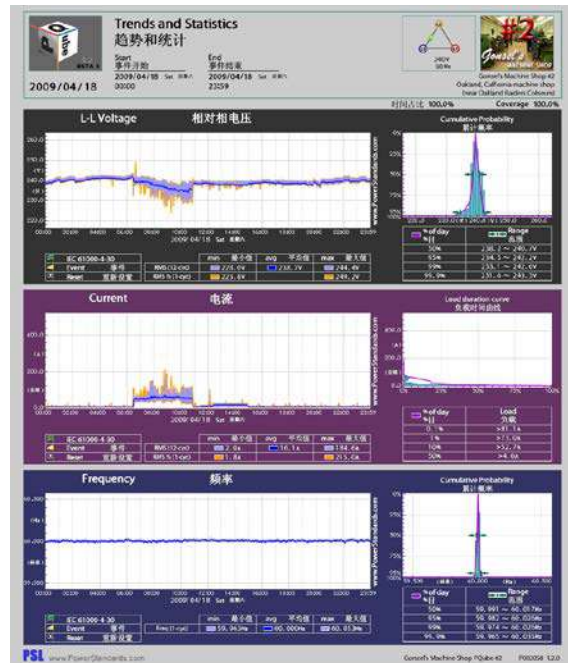

Times and Dates

Your PQube uses ISO 8601 methods for representing times and dates in Trends and Statistics Recordings.

Days begin at 00:00 Midnight, and end at 11:59pm. Days are displayed as [YYYY]/[MM]/[DD].

Weeks begin at the midnight between Sunday and Monday, and end at 11:59pm of the next Sunday. Weeks are displayed as [YYYY]-CW[WW]. (CW = Calendar Week)

Months begin at 00:00 Midnight of the 1st day of the month, and end at 11:59 of the last day of the month. Months are displayed as [YYYY]-[MM].

GIF Flags

Whenever an event occurs during a measurement, your PQube will flag the measurement at the appropriate time interval.

For GIF Trends and Statistics:



This is a voltage dip/swell/interruption as defined by IEC 61000-4-30.



This is a non-IEC 61000-4-30 event. These include frequency changes, high frequency impulses, and analog dips and swells.



This indicates that the PQube reset during the indicated time interval.

CSV Flags

For CSV Trends and Statistics:

U = PQube Start Up

D = PQube Shut Down

P = Partial Minute

F = IEC 61000-4-30 Event

O = Other Event

Trends and Statistics Channels

Voltage and Current

By default, your PQube displays voltage and current trends as single values where applicable:

The minimum value is the lowest $U_{RMS\frac{1}{2}}$ value out of all the channels.

The average value is the voltage or current of all channels averaged together over the entire measurement interval.

The maximum value is the largest $U_{RMS\frac{1}{2}}$ value out of all the channels.

To record these parameters on each individual phase, open your **Setup.ini** file and edit a tag called **Enable_Individual_Phases**. Set this to **ON** and your PQube will begin reporting the above parameters for each individual phase in both GIF and CSV formats.

Temperature and Humidity

Your PQube supports up to 2 TH1 Temperature/Humidity Probes. Temperature and Humidity data are available for both channels in the Trends and Statistics. Choose between degrees Celsius or Fahrenheit in the Measurement_Setup section of your **Setup.ini** file.

Analog and Digital Channels

Trends and Statistics are available for both analog input channels plus digital input channel.

Voltage and Current Distortion

Voltage THD and Current distortion (THD or TDD) are available in the Trends and Statistics. By default, your PQube displays THD and TDD as single values where applicable:

The minimum value is the lowest 10 or 12 cycle RMS value out of all the channels.

The average value is the voltage or current of all channels averaged together over the entire measurement interval.

The maximum value is the largest 10 or 12 cycle RMS value out of all the channels.

To record these parameters on each individual phase, open your **Setup.ini** file and edit a tag called **Enable_Individual_Phases**. Set this to **ON** and your PQube will begin reporting the above parameters for each individual phase in the CSV files.

Unbalance

For unbalance measurements, if IEC or GB methods are selected, you can view the zero-sequence ratio or negative-sequence ratio here (but not both at the same time). Unbalance is available for voltage and current.

Flicker

Flicker is available in Trends and Statistics. P_{inst} , P_{ST} , and P_{LT} values are logged Daily, Weekly, and Monthly. GIFs will show the maximum flicker values of all channels combined, while the CSV files will contain P_{inst} , P_{ST} , and P_{LT} for each channel.

Power

By default, your PQube displays power, VA, VAR, and true power factor trends as single values where applicable:

The minimum value is the lowest $U_{RMS\%}$ value out of all the channels.

The average value is the voltage or current of all channels averaged together over the entire measurement interval.

The maximum value is the largest $U_{RMS\%}$ value out of all the channels.

To record these parameters on each individual phase, open your **Setup.ini** file and edit a tag called **Enable_Individual_Phases**. Set this to **ON** and your PQube will begin reporting the above parameters for each individual phase in the CSV files.

For Fundamental VAR trends, the most negative VAR is reported as the minimum, and the most positive VAR is reported as the maximum.

Parameters reported on each individual phase

To receive voltage, current, power, VA, VAR, tPF, THD, TDD, and flicker trends for each individual phase, open your **Setup.ini** file and edit a tag called **Enable_Individual_Phases**. Set this to **ON** and your PQube will begin reporting the above parameters for each individual phase in the CSV files.

Carbon

CO2 output is available in Trends and Statistics.

Harmonics – up to the 63rd

Harmonic trends are available in CSV only. Data is available in 5 minute, 10 minute, or 15 minute intervals. At every interval, a 10/12 cycle sample is taken. Open the **Setup.ini** file and edit the tag called **Trend_Harmonic_Interval_In_Minutes** to begin recording harmonic trends. Sampling rate must be set to 128 samples per cycle.

Energy and VARh

The accumulated energy and VAR-hour values are now logged every 1 minute. These logs are available in the CSV Daily Trends file.

Changing the configuration during a measurement interval

Changing certain system settings will cause your PQube to cancel the existing recording and begin a new one, due to incompatibilities with the new settings. These settings include:

- Changing the major firmware version (from 1.3 to 1.4, from 1.4 to 2.0, etc)
- Power Configuration
- Ground point
- Nominal voltage and frequency
- PT or CT ratios
- Any settings in the Trend_Settings section of your **Setup.ini** file.

In Firmware 2.0, your PQube will automatically generate a partial recording of today's Daily Trends (if your PQube has been recording for at least 1 hour). Then it will begin a new trend recording based on the new settings.

File Formats

All filenames begin with the date and time for easy sorting. Alternatively, you can also choose to include your PQube's serial number in the filename so you can handle files from multiple PQubes without the risk of mixing up the data.

PQube data files are available in three convenient file formats.

Picture Graphs (GIF)

GIF picture files can be opened by any image program. You don't need any special software. You can also embed GIF picture files directly in Microsoft PowerPoint® presentations, Microsoft Word® reports, and so on.

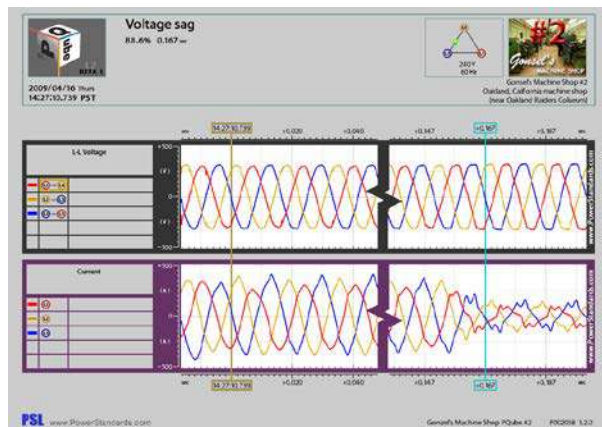

Spreadsheet (CSV)

CSV files can be opened with Excel® or almost any spreadsheet program. These files are useful if you want more detailed data, and the ability to sort individual recordings and customize your own graphs. The CSV files cover the same recording period as the GIF files, and therefore both formats contain the same information, the CSV files are more detailed, while the GIF files are easier to work with.

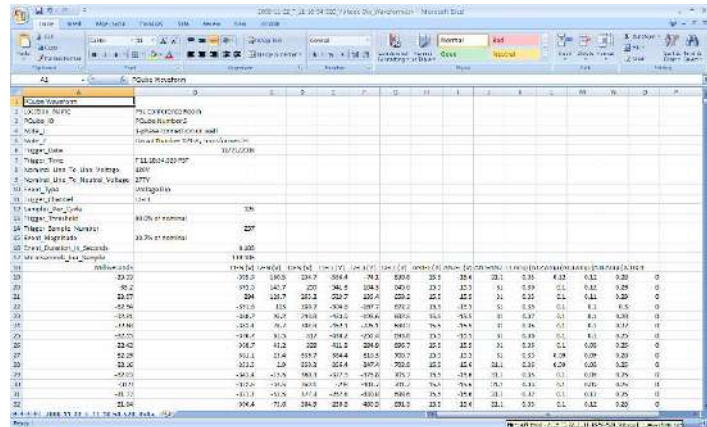

A CSV file (opened with Excel)

Web Pages (HTML)

Your PQube produces HTML files that can be opened with any web browser (such as Internet Explorer). Even if you don't have an ETH1 Ethernet module, your PQube will store HTML files on your SD card.

HTML files are useful because they are easy to read and the data is well formatted for a human to read. Use these files for preparing presentation or for sharing data with other users. If you want to write a program to extract data automatically, XML format may be a better choice. If you are having trouble changing the format you may want to use a simpler format, like text.



PQDIF (Power Quality Data Interchange Format)

Your PQube will produce PQDIF files that you can use with most PQDIF viewers. These files are useful if you use PQDIF files already or if you want to use standard files that utilities and other power quality experts understand.

PQDIF files are in beta for firmware version 1.2 and therefore are not produced by default. To enable this option, change the **PQDIF_Files** setting to **ON** in the **Setup.ini** file on your SD card.

Text

Text files are the simplest PQube output file. Almost any program can open a text file. The default Windows program is Notepad, shown here. Text files are useful when you want to make sure that everyone can read the file that you have produced. Text files are still better suited for showing to people, if you want a data format that is easy for a computer to automatically process, try XML. If you want a format that looks better, try HTML.



XML

XML format is more difficult for people to read, but there are many software packages that understand XML. If you are building a monitoring system that will automatically process data from your PQube, consider using XML as your data format. Your PQube's XML files are standard XML and can be opened with any program that understands that file format.



On most computers the default program is Internet Explorer. If you want make it eady to share your data directly with other people (and not through a computer program), consider HTML or text format files.

Manually Trigger Snapshots or Daily Trends

You do not have to wait for the PQube to generate these files during the scheduled time intervals. Navigate to the Trigger screen and select which files you would like to generate, then press the select button.



User Counter

You can configure your PQube to keep track of how many times the Analog Input or Digital Input channels have been triggered. A new "Energy per count" channel has been added. Your PQube will automatically divide the total accumulated energy by the number of counts, providing the energy per unit (energy used to fill each bottle in a beverage factory, for example).

To setup the User Counter, choose which trigger you would like to keep track of. For example, to count the number of Digital Input LOW triggers, you would enter the following in your setup file:

```

;-----
[DIG1_Events]
;-----

; ----- Valid Values: ON, OFF, USER_COUNTER
Enable_DIG1_Dip_Event=USER_COUNTER
Enable_DIG1_Swell_Event=OFF

DIG1_Dip_Threshold=0.5
DIG1_Swell_Threshold=0.5
DIG1_Event_Hysteresis=0.1

```

Every time the DIG1 value changes from 1 to 0, your PQube will increment the User Counter by 1. The Energy per Count is automatically refreshed when the User Counter is incremented.

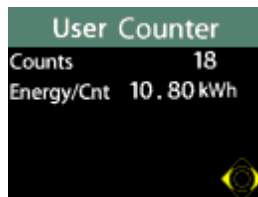

You can reset the User Counter by resetting the accumulated energy at the Energy screen.

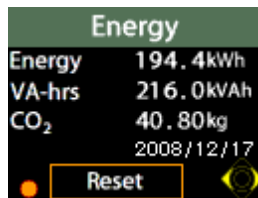

Getting Data Into and Out of Your PQube

SD Card

The SD card is the hard drive of your PQube. All of the data is recorded to the SD card. At any time you can remove the SD card by following the directions in for [*Inserting and Removing Your SD Card \(page 44\)*](#) and look at the files using any computer.

Recorded data is stored in folders that are organized by year, month, and day. Log files and other useful diagnostics are stored in the Log folder. Your PQube gets all of its setup information from the **Setup.ini** file found in the root directory of the SD card.

Your SD card stores 2 years of data under normal operating conditions. When your SD card becomes full, your PQube automatically deletes the oldest month of data.

NEW: In Firmware 2.0, you can configure your PQube to stop recording when the SD card becomes full, so you can decide which files to move off the card.

WARNING: If you choose to stop recording, you will not be notified that the SD card is full. It is important to periodically check the SD card for sufficient space; otherwise your PQube may stop recording new data for an extended period of time, until you check the SD card again.

ETH1

For information on how to set up your ETH1 Ethernet Module see [*Setting up Your Optional ETH1 Ethernet Module \(page 32\)*](#).



Receiving Email from your PQube

After you have configured your PQube to send and receive email and you have enabled the `Send_Email_On_Recording` tag in your setup file, your PQube will automatically send an email whenever it records Events, Snapshots or Trends. The email will contain all of the details about the recording and it will attach any related files (such as spreadsheets or graphs). Your PQube can send emails to up to 10 recipients.

In Firmware 2.0 you can specify up to 3 recipients to receive Summary-only emails after events. These emails contain the Event Type, Magnitude, Duration, Trigger Date, Trigger Time, Channel, and Threshold, with no HTML.

In Firmware 2.1, you can choose which types of emails to receive from your PQube. This is useful if you need to reduce network bandwidth. For example, you may want to enable emails for events so you can respond to problems more quickly, and disable emails for trend reports (which may include large attachments).

Sending Email to your PQube

Your PQube can respond to your emails. In your setup file, set `Incoming_Email=ON` to begin sending emails to your PQube. Your e-mail must meet all of the filter requirements in your **Setup.ini** file.

By default, your PQube is configured to check for new mail every 10 minutes. You can change this using the `Check_Every_N_Minutes` tag in your setup file. Whenever your PQube receives an e-mail, it will automatically respond with its present meter readings (unless the email does not match the incoming email filters, see the Ethernet Setup section of the **Setup.ini** documentation).

To perform an email command, send your PQube an email with the command in the Email Subject. To send new setup files and firmware updates, simply attach the file to the email.

All email commands must begin with the filter word specified by the Subject_Must_Begin_With tag in your setup file. By default this word is "PQube" without the quotes.

For example, to send your PQube a new setup file, write an email to your PQube with subject:

PQube New Setup File

and include the new setup file as an attachment. The subject is case sensitive.

List of Email Commands

Command (case sensitive)	Description
New Setup File	Your new setup file must be named Setup.ini , and must be attached to the e-mail. Your PQube will send you two reply e-mails: one when it receives the new setup file, and another when the new setup file has been successfully installed.
Firmware Update	Obtain a firmware update from www.PowerStandards.com and attach it to the email. It should be in the format PQube_Firmware_XX_YY_ZZ_FFFFFFFF.pqf The XX, YY, and ZZ are digits that identify the type of firmware update, and FFFFFFFF is a checksum. Do not re-name this file. If your PQube receives a valid firmware update, it will reset and perform the update.
Reset PQube	Resets PQube upon receipt of email. This is useful when loading a new setup file or firmware via FTP.
Send Logs	You can ask your PQube to send you its log files via e-mail. The log files can help diagnose PQube setup problems, and they show the complete history of your PQube. For faster technical support, please include these files when contacting our technical support department.
Send Setup	Request your PQube's existing setup file.
Generate Snapshot	Takes a snapshot of your power.
Generate Daily Stripstats	Generates the Daily Trends for today. The data ranges from Midnight to the moment the email request is received.
Reset Energy Accumulators	Resets all accumulated energy values.
Reset Peak Measurements	Resets all peak values for the Peak Amps, Peak Demand, and Peak VA meters.
Reset Analog Energy Accumulator	Resets accumulated Analog energy values.
Set Harmonic of Interest to #	Sets the Harmonic of Interest on the PQube display and Web Server. Replace # with the desired harmonic order of interest

	(1-50).
--	---------

Web

In order to access your PQube's web site, you will need set up the web server (see [Web Server Setup on page 35](#)) and determine the IP address of your PQube. If you are using fixed IP, you already know the IP address, but if you are using DHCP, you can find your IP address at the Network screen. If you are on the same local network, enter the IP address into your browser.

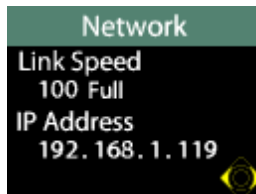

You will be able to see the present status of your PQube, real-time meters, and all event, trend, and statistics recordings stored on your PQube's SD card. To restrict access to your web server, you can specify a user name and password in your **Setup.ini** file.

You can perform the following actions under the Commands section:

- Generate Snapshot
- Generate Daily Trends
- Send Test E-mail
- Reset Energy Accumulators
- Reset Analog Energy Accumulator
- Reset Peak Measurements
- Reset PQube
- Upload new setup file
- Firmware Update

Access to these commands can be restricted by specifying an administrator username and password in your **Setup.ini** file.

Under the Meters tab, you can view the total memory usage in your SD card. This value appears as 0% full after reset, and is updated every evening.

FTP

After you set up your PQube's FTP server (see [FTP Setup on page 35](#)), you can access your PQube using any standard FTP client, with the following restrictions:

- you must restrict your client to 1 simultaneous connection (consult your client's documentation for details on how to do this)
- you may need to enable FTP keep-alive on your client (your PQube will disconnect automatically after 5 minutes of inactivity, turn on keep-alive to prevent this)
- ask your system administrator if there are firewalls or other protection systems in place that might affect your ability to connect to your PQube via FTP.

In order to access your PQubes FTP server, you will need the IP address of your PQube.

Maintenance

Upgrading Your PQube's Firmware

Power Standards Lab offers free firmware updates to add new features to your PQube and to fix bugs. You can check www.PQube.com from time to time to see if there is a new version of firmware available. Every firmware upgrade comes with a guide with detailed instructions on how to perform the update.

Turning Off Your PQube

Your PQube is designed to be a permanently installed monitor. It does not have an on/off switch because it is designed to run continuously. If you need to turn off your PQube, turn off your PQube's instrument power (either the power screw terminals on your PQube, the optional PS1 Power Supply Module, or both), once your PQube is running from battery, reset your PQube by removing and re-inserting your PQube's SD card. This will cause your PQube to reset and power down (as there is no power available). If your PQube resets and begins to start up again, you have not removed all instrument power.

Replacing your PQube's battery

The battery is PSL type "340-000080" followed by a 2-digit revision level. This part must be supplied only by the PSL or PSL agents. It contains built-in protection.

PSL recommends replacing your PQube's battery after 5 years, or 1000 uses, whichever comes first. You can find the battery installation date and the number of times the battery has been used on your PQube's battery status screen, in the Meters menu.



To replace the battery, use a small flat-blade screwdriver to open the battery compartment. Pull on the tab to slide the battery out, then slide in the new battery in the correct orientation. Seat the new battery gently, then close the battery compartment. Go to the battery status screen, and hold down the Select button for 3 seconds – this will reset the installation date and the battery use counter.

It is not necessary to remove power while replacing the battery. Follow local regulations when disposing of the used battery.

Cleaning Instructions

If necessary, wipe the accessible parts of your PQube with a cloth, slightly moistened with clear water. Do not use abrasives or chemical cleaners.

PQube Specifications

PQube Specifications Version 2.0

Reference conditions for factory tests: 19~25°C, 15%~50% RH, steady-state 10/12 cycle signals. $\pm 1/2$ display count on all accuracies

MAINS VOLTAGE MEASURING CHANNELS	
Connection	L1, L2, L3, N PQube screw terminals [9], [11], [13], [15]
Frequency Range	40 Hz ~ 70 Hz and 320 Hz ~ 560 Hz. Nominal 50 Hz, 60 Hz, or 400 Hz auto, 320-560 Hz manually selected. Specifications below apply at 50/60 Hz.
Mains Configuration	Single-phase, split-phase, delta, wye or star. User selected or auto-selected.
Range of Nominal Input Voltage	100 VAC ~ 690 VAC L-L (69 VAC ~ 400 VAC L-N). User selected or auto-selected.
Measurement Channels	Line-to-Neutral, Line-to-Line, Neutral-to-Earth.
Sampling Rate	256 samples per cycle, phase-locked to input frequency.
Measurement Range	0 VAC ~ 900 VAC L-L (520 VAC L-N)
Accuracy	$\pm 0.05\%$ rdg $\pm 0.05\%$ FS typical (10%~150% of nominal). Factory tested at better than $\pm 0.04\%$ rdg $\pm 0.04\%$ FS. Note: FS = 345 VAC or 520 VAC, selected based on nominal line-to-earth voltage.
RMS Measurement Method	True single-cycle RMS, phase-locked to each channel, updated every cycle or every 1/2 cycle. $U_{RMS\%}$ per IEC 61000-4-30 Class A. Also 10/12 cycle true-RMS per IEC 61000-4-30 Class A.
HF Impulse Detection	L1-E, L2-E, L3-E. ± 450 Vpk nominal threshold detected through 2-pole high-pass 4.8 kHz nominal filter. Every PQube factory tested with 1- μ sec 10%-to-90% impulses; trigger required at ± 650 Vpk, must not trigger at ± 250 Vpk.
Unbalance – Voltage	Measurement method: ANSI C84.1, IEC, and GB. Range: 0.0% ~ 100.0%. Accuracy equivalent to RMS voltage specification applied to measurement method. Supports ANSI, GB, IEC (positive and negative sequence*).
THD – Voltage	Measurement method: DFT of phase-locked 256 samples-per-cycle. Range: 0.0% ~ 100.0%. Accuracy: $\pm 0.2\%$ at 60-Hz test waveform having typical harmonic content (5% 5th, 2.5% 7th, 1.5% 9th, and 1% 11th)
Flicker	$\pm 5\%$ rdg at all reference points on the eye-response curve defined in IEC 61000-4-15 for $P_{ST} \geq 1$.
Harmonics and Interharmonics	Range: 0% ~ 100% of fundamental, measured up to the 63rd order (harmonics displayed up to the 50th order).
Harmonic accuracy	IEC 61000-4-7:2002 Class II, typical, up to the 50th order, for units manufactured after February 2010. (Preliminary specification, subject to further evaluation)
Isolation	PQube provides more than 7500 VDC isolation to Earth. UL/IEC 61010 reinforced insulation.
PT Input Ratio Range	1:1 to 10000
Installation Category	CAT IV UL/IEC 61010 for voltages up to 300 VAC L-N (equivalent to 480 VAC L-L), CAT III for higher voltages. Pollution degree 2.

ANALOG INPUT CHANNELS	
Connection	AN1, AN2 PQube screw terminals [22], [30]
Nominal Input	High range: 0 ~ 30 VAC or ± 60 VDC to Earth max. Low range: 0 ~ 7VAC or ± 10 VDC to Earth max.
Input impedance	800 k Ω to Earth
Full Scale	High range: 70 VAC, ± 100 VDC, Low range 7 VAC, ± 10 VDC.
Measurement Channels	Standard: AN1-Earth, AN2-Earth, AN1-AN2. DC Energy Mode: DC Power and DC Energy.
Accuracy	$\pm 0.2\%$ rdg $\pm 0.2\%$ FS typical (10% ~ 100% FS), ANx-Earth. Every PQube factory tested at better than $\pm 0.1\%$ rdg $\pm 0.1\%$ FS AC

DIGITAL INPUT	
Connection	DIG1 PQube screw terminal [24]
Rating	60 VDC to Earth
Wetting	5.4 VDC at 3 μ A
Threshold	1.5 V ± 0.2 V with respect to PQube's Earth terminal, with 0.3 V hysteresis typical.
Sampling Rate	12.8 kHz or 15.4 kHz (sampled at same rate as mains voltage measuring channels).

FREQUENCY MEASUREMENT	
Range	40 Hz to 70 Hz and 320 Hz to 560 Hz.
Accuracy	± 0.01 Hz, steady state.
Method	Cycle-by-cycle zero-crossing detection on L1-E or L2-E (auto-selected). Firmware phase-locked for frequency slew rate up to 5 Hz/sec. For 50/60 Hz, measured through a 9-pole low-pass analog filter, 3-dB frequency 76 Hz. For 400 Hz, measured through 7-pole low-pass filter, 3-dB frequency 1 kHz. Poles and 3 dB frequency are auto-selected based on nominal frequency.

OPTIONAL TEMPERATURE/HUMIDITY PROBES	
Connection	2.5 mm stereo jack. Functional electrical isolation from PQube.
Location	Optional probes plug into the PQube directly or through PSL-provided extension cable.
Scan Time	5 seconds max.
Temperature Accuracy	Typical: $\pm 0.5^{\circ}\text{C}$. Max: $\pm 2^{\circ}\text{C}$ ($-20 \sim +80^{\circ}\text{C}$).
Humidity Accuracy	Typical: $\pm 4.5\%$ RH ($20 \sim 80\%$ RH), max: $\pm 7.5\%$ ($0 \sim 100\%$ RH). Note: For optimal ambient temperature and humidity accuracy, use extension cable to avoid self-heating of probe by PQube.

OPTIONAL CURRENT MEASURING MODULES	
CT4-20A-00	
Measurement Type	Pass-through (built-in current transformers)
Nominal Input	20 amps RMS for CT4-20A
Crest Factor	3.5 (± 70 amps instantaneous)
Sampling Rate	12.8 kHz or 15.4 kHz (sampled at same rate as mains voltage measuring channels)
Accuracy	$\pm 0.2\%$ rdg $\pm 0.2\%$ FS typical ($10\% \sim 120\%$ FS). Every PQube factory tested at better than $\pm 0.15\%$ rdg $\pm 0.15\%$ FS.
Burden	less than 0.1VA
Conductors	0.34 inches (8.6 mm) max. diameter, 600 V UL-recognized insulation required
XCT4-1A-00, XCT4-5A-00	
Measurement Type	External current transformer
CT Input Ratio Range	1:1 to 10000:1
Nominal Input	1 amp RMS for XCT4-1A, 5 amps RMS for XCT4-5A
Crest Factor	3.5 (± 3.5 amps instantaneous for XCT4-1A, ± 17.5 amps instantaneous for XCT4-5A)
Sampling Rate	12.8 kHz or 15.4 kHz (measured at same rate as mains voltage measuring channels)
Accuracy - excluding external CT's	$\pm 0.2\%$ rdg $\pm 0.2\%$ FS typical ($10\% \sim 120\%$ FS). Every PQube factory tested at better than $\pm 0.15\%$ rdg $\pm 0.15\%$ FS.
Burden	Less than 0.1 VA
Wire Connection	Min. 20 AWG (0.52 mm2), max. 14AWG (2.1 mm2). 600 V UL-recognized insulation required
Max. Screw Torque	7 inch-pounds (0.8 Nm)
XCT5-0.333V-00, XCT5-1V-00, XCT5-5V-00, XCT5-10V-00, CTE1	
Measurement Type	External current transformer
CT Input Ratio Range	1:1 to 10000:1
Nominal	0.333 V RMS, 1 V RMS, 5 V RMS, or 10 V RMS
Crest Factor	3.5 (± 1.17 Vpk, ± 3.5 Vpk, ± 17.5 Vpk, or ± 35 Vpk)
Sampling Rate	12.8kHz or 15.4kHz (measured at same rate as mains voltage measuring channels)
Accuracy - excluding external CT's	$\pm 0.2\%$ rdg $\pm 0.2\%$ FS typical ($10\% \sim 120\%$ FS). Every PQube factory tested at better than $\pm 0.1\%$ rdg $\pm 0.1\%$ FS.
Wire Connection	Min. 20AWG (0,52 mm2), Max. 14AWG (2,1mm2). 600V UL- recognized insulation required
Measurement Type	External current transformer
CT Input Ratio Range	1:1 to 10000:1
Nominal	0.333 V RMS, 1 V RMS, 5 V RMS, or 10 V RMS
Max. Screw Torque	5 inch-pounds (0,6Nm)

OPTIONAL ATT1 VOLTAGE ATTENUATOR MODULES FOR ANALOG INPUT CHANNELS		
	ATT1-0600V	ATT1-1200V
Rated Full-Scale Voltage	± 600 VDC/300 VAC to Earth	± 1200 VDC/600 VAC to Earth
Nominal Measurement Range	± 1000 Vpk to Earth	± 2000 Vpk to Earth
Analog Input Channel Ratio	10:1	20:1
Test Voltage to Earth	7250 VDC	14500 VDC
Accuracy	$\pm 0.2\%$ reading typical at DC ($>10\%$ FS), plus error in analog input channels. For 50/60 Hz signals, increase the analog input channel ratio by 0.1% (ATT1-0600V) or 0.4% (ATT1-1200V) per meter of cable to approximately compensate for cable capacitance.	

OPTIONAL ATT2 MODULE FOR DC POWER AND ENERGY		
Voltage Channel	ATT2-600V	ATT2-1200V
Maximum Input Voltage	±1000 Vpk differential	±2000 Vpk differential
Rated Full-Scale Voltage	±600 VDC/300 VAC differential	±1200 VDC/600 VAC differential
Analog Input Channel Ratio	100:1	200:1
Accuracy	DC: ±0.1% rdg ±0.1% FS 50/60Hz: ±0.15% rdg ±0.15% FS At 23°C ±3°C, 10% – 100% FS, in addition to error in PQube analog channels	
Thermal drift of offset voltage	±0.005 mV/°C typical	
Thermal drift of gain	±0.01% rdg/°C typical	
Current Channel	With closed-loop sensors	With open-loop sensors
Rated Full-Scale Current	50A to 600A (depending on sensor model)	50A to 3000A (depending on sensor model)
Maximum Input Current	150% to 200% FS (depending on sensor model)	110% to 200% FS (depending on sensor model)
Accuracy at calibration current	0.15% rdg ±0.15% FS typical at DC	±0.3% rdg ±0.3% FS typical at DC
Hysteresis offset voltage error	< ±20 mV (after excursion of ±100% FS current)	< ±30 mV (after excursion of ±100% FS current)
Linearity	±0.1% rdg ±0.1% FS	±0.5% rdg ±0.5% FS
Thermal drift of offset voltage	±0.1 mV/°C typical	±1 mV/°C typical
Thermal drift of gain	±0.02% rdg/°C typical	±0.1% rdg/°C typical

INSTRUMENT POWER	
Screw Terminals	(AC or DC) PQube POWER screw terminals [23], [31]
AC Input	24VAC ± 20% 50/60 Hz
DC Input	24-48VDC ± 20% (polarity independent)
Power Required	5VA max.
Isolation	PQube provides more than 150VDC isolation to all other circuits.
Internal UPS	
Type	Lithium Polymer Battery (replacement batteries available from PSL).
Capacity	600mAH.
Backup Period	User controlled. 1 to 10 minutes, 3 minute default.
Storage & Discharge Temp.	-20°C to +60°C
Charge Temperature	0°C to +45°C
Charging Cycles	>500 full cycles.
Lifetime	Estimated 5+ years, depending on operating and environmental conditions.
Replacement Method	User-replaceable while PQube is operating (tool required).
Optional PS1 Plug-in Module	
AC Input	100~240VAC ± 10%. 50/60 Hz
Power Required	25VA max
Isolation	Module provides more than 3200VDC isolation to all other circuits

POWER MEASUREMENTS	
Definitions	
Watts (power)	Sum of true instantaneous per-phase power.
Volt-Amps (apparent power)	Sum of per-phase product of RMS voltage and RMS current, taken over the measurement interval.
Power Factor	True power factor—ratio of Watts to Volt-Amps, displacement PF—cos θ .
VARs (volt-amps reactive)	Budeanu definition or fundamental VARs—user-selectable.
Carbon (CO ₂ rate & accumulated)	Based on patent-pending algorithm using watts and user-selected proportions of generator sources, and user-supplied carbon generation rates for each source.
Current Unbalance	Measurement method ANSI C84.1.
Inputs	
Voltages	L-N or L-Nm for delta configurations. Nm defined as measurement neutral, the instantaneous average L-E voltage. All
Currents	L1, L2, L3, N, E currents. Optional user-selected calculated current on one channel for installations with N-1 current transformers. All voltages scaled up to 10000:1 for current transformers.
Measurement interval	Phase-locked, 10-cycles (50 Hz nominal) or 12-cycles (60 Hz nominal). Approximately 5 readings per second.
Accuracy excluding external CTs	
Watts (power)	±0.2% typical at unity power factor, nominal voltage, 20% ~ 100% FS current. Better than ±0.25% rdg ±0.25% FS plus error due to phase angle uncertainty (<1.5° typical) for θ fundamental < ±30°, nominal voltage, 10% ~ 120% FS current. θ fundamental=angle between fundamental voltage and fundamental current.
Volt-Amps (apparent power)	Better than ±0.25% rdg ±0.25% FS typical (10% ~ 120% FS)

Signal Relay	
Connection	RLY1 PQube screw terminals [21], [29]. RLY2 PQube screw terminals [20], [28] with factory installed RLY option. RLY3 PQube screw terminals [19], [27] with factory installed RLY option.
Rating	30 VAC/30 VDC, 300 mA max.
Function	Normally closed. Contacts open for duration of event or 3 seconds (whichever is longer).
Operate Time	20 milliseconds.
High Current Relay	
Connection	RLY4 PQube screw terminals [17], [25]
Rating	30 VAC/30 VDC, 2A max.
Function	Normally closed. Contacts open for duration of event or 3 seconds (whichever is longer).
Operate Time	20 milliseconds.

COMMUNICATIONS

USB	
Connection	Mini-B USB socket.
Future Applications	Future: USB mass storage device, and USB-based serial COM port.
Isolation	PQube provides at least 150VDC isolation to Earth (eliminates ground loops).
Optional Plug-in Ethernet Module	
Connection	Standard RJ-45 socket (wired Ethernet).
Email	Sends emails after every event with data attached; user request real-time meters via e-mail, PQube firmware upgrade via email, change PQube setup via email, incoming e-mail filters. Includes GIF graphs, CSV spreadsheet files, PQDIF, HTML and XML summaries.
Web Server	Real-time meters. All events, trends and statistics recordings. Includes GIF graphs, CSV spreadsheet files, PQDIF, HTML and XML summaries.
Modbus over TCP	Real-time meters with update rate of approximately 1 second. Event/trend-statistics counters can be used for triggering downloads via FTP or web server.
FTP Server	File Transfer Protocol. Transfers files from PQube SD card to and from any computer. Limit: one simultaneous connection.
SNTP	Simple Network Time Protocol for synchronizing PQube real-time clock to UTC. (2 second absolute - UTC referenced).

CLOCK TIMING

Internal Real-Time Clock	
Accuracy	Typical ±30 seconds/yr. Temperature compensated. ±120 seconds/yr. max drift
Optional SNTP (Requires ETH1)	
Accuracy	±2 seconds absolute, UTC time.

OPERATING ENVIRONMENT

Ambient Conditions - Operating	-20°C ~ 50°C, 5% RH ~ 95% RH non-condensing
Transient Voltages	100kHz ring wave, 6 kV pk, IEC 61180, IEC 61000-4-5. Applied to voltage measuring terminals with Performance Evaluation Class 1. (When applied to optional power supply mains terminal, supply's fuse may operate in PE Class 3 at test levels greater than 4 kV.)
EFT Burst Immunity	4 kV pk, IEC 61000-4-4, Performance Evaluation Class 1. Applied to power measuring terminals and optional PS1 power supply mains terminals.
RF Field Strength Immunity	3V / m, IEC 61000-4-3 Test Level 2.
Magnetic Field Strength Immunity	30A / m, IEC 61000-4-8 Test Level 4.
Ingress Protection Rating (IP Rating)	IP20H, IEC 60529.

PHYSICAL	
PQube	
Dimensions (L x W x H)	3.5in x 2.8in x 3.2in (90mm x 72mm x 80mm)
Weight	8.7oz (247g)
Mounting Standard	35mm DIN rail. Optional panel mounting clips available.
Screw Terminal Torque	7 inch-pounds (0,8Nm)
PS1 Power Supply	
Dimensions (L x W x H)	3.5in x 1.7in x 2.4in (90mm x 43mm x 61mm)
Weight	4.0oz (113g)
Mounting	Standard 35mm DIN rail. Optional panel mounting clips available.
Screw Terminal Torque	7inch-pounds (0,8Nm)
ETH1 Ethernet	
Dimensions (L x W x H)	3.5in x 1.7in x 2.4in (90mm x 43mm x 61mm)
Weight	2.1oz (60g)
Mounting	Standard 35mm DIN rail. Optional panel mounting clips available.
XCT4/XCT5 Current	
Dimensions (L x W x H)	3.5in x 1.7in x 2.4in (90mm x 43mm x 61mm)
Weight	3.5oz (99g)
Mounting	Standard 35mm DIN rail. Optional panel mounting clips available.
Screw Terminal Torque	7inch-pounds (0,8Nm)
CT4 Current	
Dimensions (L x W x H)	3.5in x 4.4in x 1.6in (90mm x 112mm x 41mm)
Weight	8.1oz (230g)
Mounting	Standard 35mm DIN rail. Optional panel mounting clips available.
TH1	
Dimensions (L x W x H)	0.7in x 1.8in x 0.4in (18mm x 46mm x 10mm)
Weight	0.2oz (6g)
Connection	2.5mm stereo jack
ATT1	
Dimensions (L x W x H)	2.1in x 5.2in x 1.6in (53mm x 131mm x 40mm)
Weight	13.1oz (372g)
Connection	Safety banana jack
ATT2	
Dimensions (L x W x H)	2.6in x 4.9in x 1.4in (67mm x 125mm x 35mm)
Weight	5.3oz (151g)
Connection	Safety banana jack and snap-fit wire harness

AGENCY APPROVALS AND LISTINGS	
UL	UL-recognized, cULus – File Number E220936
RoHS	Certified – PSL Construction File PQube-001
CE	Certified - PSL Construction File PQube-001, TUV CB Test Certificate US-TUVR-4368-A2
ITC	Certified – 20080102-01-CE, 20080326-01-RI
TUV Bauart-mark	Certified – TUV Report 30880881.009
ABS Shipyard	Certified – 2009 Steel Vessels Rules 1-1-4/7.7, 4-8-3/Table 2, 2008 MODU Rules: 43-3-3/Table 1

Appendix 1: Modbus

A brief introduction to Modbus

Modbus is an industry-standard protocol you can use to transfer meter readings from your PQube to a Modbus client program that runs on your computer.

Your PQube, like all Modbus-enabled meters, has a list of Modbus “registers”. Each register holds 16 bits of data. Often, the registers are used in pairs to hold a 32-bit floating point number; but sometimes, a single register holds a 16-bit integer. It depends on the type of data that makes sense for each particular meter – floating point numbers include fractions and very large values, but take up twice as much space, while integers are whole numbers and use half the space. For each PQube meter, you can find the type of data, “Float”, “Integer”, “Long Long”, etc. in the PQube Modbus Registers table below.

The registers are numbered. By Modbus convention, you pick a “base address” for your registers – 7000 is the default base address for your PQube. Then each register, or pair of registers, has a “register offset” that tells you how far from the base address it is.

For example, the PQube’s frequency meter is a 32-bit floating point number. Looking in the PQube Modbus Registers table, you see that frequency is in Modbus registers 26 and 27. (Remember that the registers are 16-bits, so two registers are required for a 32-bit number.) If you need the actual physical address of the registers, you must add the base address – the physical address of these registers is 7026 and 7027. But most Modbus client programs do this for you. Also, most Modbus client programs will allow you to refer to this as a floating-point meter located at register 7026.

Another example: the PQube’s meter reading for the month on its internal clock-calendar is an integer (1,2,3,4,5,6,7,8,9,10,11, or 12). Looking in the PQube Modbus Registers table below, you can find out that the register address is 135.

PQube® Modbus registers

The Modbus registers in the PQube, listed below, are offsets from a base address. By default, the base address is 7000. If you want, you can change the base address by modifying your PQube’s SETUP.INI text file.

The Modbus registers in your PQube are in actual units, including all multipliers for PT’s, CT’s, etc. Most other meters require you to multiply by scaling factors, but your PQube takes care of this itself.

For example, 480.0V is presented as an IEEE floating point number: 480.000 . 24kV is presented as an IEEE floating point number: 24000.000 . 59.6 kWh is presented as an IEEE floating point number: 59600.00 . 213.567 MWh is presented as an IEEE floating point number: 213567000.000 .

If no data is available, your PQube uses a float value of NaN (not a number) to indicate “no data”, and your PQube uses an integer value of 32,767 (7FFF hex) to indicate “no data”.

NOTE: Under normal conditions, your PQube updates its registers approximately once per second. However, if your PQube needs to generate files for events and trends, or send an email, then you

may experience delayed response times, ranging from a few seconds up to several minutes, depending on which parameters are being recorded.

PQube Modbus Register Table

Firmware Version 2.0

Offset	Register	Format	Units	Comments
0-1	L1-E	Float	RMS Volts	L1 to earth – $U_{rms10/12}$
2-3	L2-E	Float	RMS Volts	L2 to earth – $U_{rms10/12}$
4-5	L3-E	Float	RMS Volts	L3 to earth – $U_{rms10/12}$
6-7	N-E	Float	RMS Volts	Neutral to earth – $U_{rms10/12}$
8-9	L1-N	Float	RMS Volts	L1 to neutral – $U_{rms10/12}$
10-11	L2-N	Float	RMS Volts	L2 to neutral – $U_{rms10/12}$
12-13	L3-N	Float	RMS Volts	L3 to neutral – $U_{rms10/12}$
14-15	L1-L2	Float	RMS Volts	L1 to L2 – $U_{rms10/12}$
16-17	L2-L3	Float	RMS Volts	L2 to L3 – $U_{rms10/12}$
18-19	L3-L1	Float	RMS Volts	L3 to L1 – $U_{rms10/12}$
20-21	AN1-E	Float	RMS Volts	Analog 1 to Earth – $U_{rms10/12}$
22-23	AN2-E	Float	RMS Volts	Analog2 to Earth – $U_{rms10/12}$
24-25	AN1-AN2	Float	RMS Volts	Analog1 to Analog2 – $U_{rms10/12}$
26-27	Frequency	Float	Hertz	
28-29	L1 Current	Float	RMS Amps	$A_{rms10/12}$
30-31	L2 Current	Float	RMS Amps	$A_{rms10/12}$
32-33	L3 Current	Float	RMS Amps	$A_{rms10/12}$
34-35	N Current	Float	RMS Amps	Neutral current - $A_{rms10/12}$
36-37	Power (W)	Float	Watts	Also see 204-209
38-39	Apparent Power (VA)	Float	VA	Also see 210-215
40-41	Digital Input	Float	(none)	Usually 0 or 1; a fractional value indicates duty cycle
42-43	Peak Current (1-cycle)	Float	RMS Amps	$A_{rms10/12}$ See also registers 122-124:
44-45	Peak Current (1-minute)	Float	RMS Amps	1-minute RMS average See also registers 122-124
46-47	Peak Current (N-minute)	Float	RMS Amps	N-minute RMS average Typically N is 10 minutes or 15 minutes. See register 1024. Also, see also registers 122-124
48-49	Peak Power (1-cycle)	Float	Watts	See also registers 125-127
50-51	Peak Power (1-minute)	Float	Watts	See also registers 125-127
52-53	Peak Power (N-minute)	Float	Watts	Typically N is 10 minutes or 15 minutes. See register 1024. Also, see registers 125-127
54-55	Peak VA (1-cycle)	Float	VA	See also registers 128-130
56-57	Peak VA (1-minute)	Float	VA	See also registers 128-130
58-59	Peak VA (N-minute)	Float	VA	See registers 128-130. Typically N is 10 minutes or 15 minutes - see

				register 1024.
60-61	Energy (Wh)	Float	Wh	Also, see registers 131-133
62-63	Apparent Energy (VAh)	Float	VAh	Also, see registers 131-133
64-65	Voltage THD	Float	%	Also, see registers 192-197
66-67	Current TDD	Float	%	Also, see register 1020-1021: base current for TDD. Also, see registers 198-203.
68-69	ANSI Voltage Unbalance	Float	%	If using IEC or GB methods, see registers 174-175 and 178-179
70-71	ANSI Current Unbalance	Float	%	If using IEC or GB methods, see registers 176-177 and 180-181
72-73	L1 Flicker P _{inst}	Float	-	Instantaneous value. For L2 and L3 see 228-239.
74-75	L1 Flicker P _{5T}	Float	-	10-minute value. For L2 and L3 see 228-239.
76-77	L1 Flicker P _{1T}	Float	-	2-hour value. For L2 and L3 see 228-239.
78	New Event Recordings	Integer	-	Number of new events recorded by PQube since last time this register was polled. This register is incremented when the files are fully available for download. This register is cleared by reading it.
79	New Trend Recordings	Integer	-	Number of new trends (daily, weekly, monthly) recorded by PQube since last time this register was polled. This register is incremented when the files are fully available for download. This register is cleared by reading it.
80-81	Volt-amps reactive	Float	VAR	Also, see registers 216-221
82-83	True power factor	Float	-	Value between -1.0 and +1.0
84-85	Temperature – Probe 1	Float	°C	Modbus register is always in °C, even if user has selected °F for display
86-87	Humidity – Probe 1	Float	%RH	Relative humidity
88-89	Temperature – Probe 2	Float	°C	Modbus register is always in °C, even if user has selected °F for display
90-91	Humidity – Probe 2	Float	%RH	Relative humidity
92-93	CO ₂ rate	Float	Grams per hour	Patent-pending table-based algorithm. May be negative, indicating avoided CO ₂ .
94-95	CO ₂ accumulated	Float	Grams	Patent-pending table-based algorithm. Also, see registers 131-133: Energy accumulated since [date]
96-97	Earth current	Float	RMS Amps	A _{rms10/12}
98-99	L1-N voltage fundamental magnitude	Float	RMS Volts	For delta systems, the PQube calculates a metering Neutral for this parameter.
100-101	L1-N voltage fundamental angle	Float	degrees	Range: ±180.0°
102-103	L2-N voltage fundamental magnitude	Float	RMS Volts	For delta systems, the PQube calculates a metering Neutral for this parameter.
104-105	L2-N voltage fundamental angle	Float	degrees	Range: ±180.0°
106-107	L3-N voltage	Float	RMS	For delta systems, the PQube

	fundamental magnitude		Volts	calculates a metering Neutral for this parameter.
108-109	L3-N voltage fundamental angle	Float	degrees	Range: ±180.0°
110-111	L1 current fundamental magnitude	Float	RMS Amps	
112-113	L1 current fundamental angle	Float	degrees	Range: ±180.0°
114-115	L2 current fundamental magnitude	Float	RMS Amps	
116-117	L2 current fundamental angle	Float	degrees	Range: ±180.0°
118-119	L3 current fundamental magnitude	Float	RMS Amps	
120-121	L3 current fundamental angle	Float	degrees	Range: ±180.0°
122	Peak current – “since” date	Integer	Year	Typical values: 2009, 2010, etc.
123	Peak current – “since” date	Integer	Month	Range: 1 – 12
124	Peak current – “since” date	Integer	Day	Range: 1 – 31
125	Peak power – “since” date	Integer	Year	Typical values: 2009, 2010, etc.
126	Peak power – “since” date	Integer	Month	Range: 1 – 12
127	Peak power – “since” date	Integer	Day	Range: 1 – 31
128	Peak VA – “since” date	Integer	Year	Typical values: 2009, 2010, etc.
129	Peak VA – “since” date	Integer	Month	Range: 1 – 12
130	Peak VA – “since” date	Integer	Day	Range: 1 – 31
131	Energy (Wh) – “since” date	Integer	Year	Typical values: 2009, 2010, etc.
132	Energy (Wh) – “since” date	Integer	Month	Range: 1 – 12
133	Energy (Wh) – “since” date	Integer	Day	Range: 1 – 31
134	PQube clock-calendar	Integer	Year	Typical values: 2009, 2010, etc.
135	PQube clock-calendar	Integer	Month	Range: 1 – 12
136	PQube clock-calendar	Integer	Day	Range: 1 – 31
137	PQube clock-calendar	Integer	Hour	Range 0 – 23
138	PQube clock-calendar	Integer	Min	Range 0 – 59
139	PQube clock-calendar	Integer	Second	Range 0 – 59
140-141	PQube offset from UTC	Float	Hours	Range -12.0 - +12.0 . Set by user in Setup.ini file.
142-143	Harmonic – L1-N volts	Float	RMS Volts	Harmonic order specified in 166
144-145	Harmonic – L2-N volts	Float	RMS Volts	Harmonic order specified in 166

146-147	Harmonic – L3- N volts	Float	RMS Volts	Harmonic order specified in 166
148-149	Harmonic – L1 current	Float	RMS Amps	Harmonic order specified in 166
150-151	Harmonic – L2 current	Float	RMS Amps	Harmonic order specified in 166
152-153	Harmonic – L3 current	Float	RMS Amps	Harmonic order specified in 166
154-155	Harmonic – L1- N voltage angle	Float	degrees	Harmonic order specified in 166
156-157	Harmonic – L2- N voltage angle	Float	degrees	Harmonic order specified in 166
158-159	Harmonic – L3- N voltage angle	Float	degrees	Harmonic order specified in 166
160-161	Harmonic – L1 current angle	Float	degrees	Harmonic order specified in 166
162-163	Harmonic – L2 current angle	Float	degrees	Harmonic order specified in 166
164-165	Harmonic – L3 current angle	Float	degrees	Harmonic order specified in 166
166	Harmonic order of interest	Integer (Read/Write)	-	Range: 1-50, selected by user on PQube harmonic meters screens – defaults to 3 rd harmonic
167	GPS status	Integer	-	0 = not installed 1 = not locked 2 = locked onto satellites and operating
168-169	GPS latitude	Float	degrees	Range: ±90.0000° from equator
170-171	GPS longitude	Float	degrees	Range: ±180.0000° from prime meridian
172	GPS number of satellites	Integer	-	Count of acquired satellites
173	-	-	-	(Not used)
174-175	IEC or GB Unbalance – V-	Float	Percent	Fundamental negative-sequence voltage, as a percentage of fundamental positive-sequence voltage
176-177	IEC or GB Unbalance – A-	Float	Percent	Fundamental negative-sequence current, as a percentage of fundamental positive-sequence current
178-179	IEC or GB Unbalance – V0	Float	Percent	Fundamental zero-sequence voltage, as a percentage of fundamental positive-sequence voltage
180-181	IEC or GB Unbalance – A0	Float	Percent	Fundamental zero-sequence current, as a percentage of fundamental positive-sequence current
182-183	DC Power	Float	Watts	DC volts multiplied by DC amps
184-185	DC Energy	Float	Wh	DC energy accumulated since [date] – see registers 242-244
186-189	User counter	Long Long	counts	Number of times the Analog or Digital Input channels were triggered since [date] – shares this reset date with Energy, see registers 131-133
190	Trigger Snapshot	Write-only	-	Set this register to 1 to trigger a Snapshot with your PQube
191	Reset Peak Measurements	Write-only	-	Set this register to 1 to reset all peak measurements in your PQube
192-193	L1 Voltage THD	Float	Percent	

194-195	L2 Voltage THD	Float	Percent	
196-197	L3 Voltage THD	Float	Percent	
198-199	L1 Current TDD	Float	Percent	
200-201	L2 Current TDD	Float	Percent	
202-203	L3 Current TDD	Float	Percent	
204-205	L1 Power	Float	Watts	
206-207	L2 Power	Float	Watts	
208-209	L3 Power	Float	Watts	
210-211	L1 Apparent Power (VA)	Float	VA	
212-213	L2 Apparent Power (VA)	Float	VA	
214-215	L3 Apparent Power (VA)	Float	VA	
216-217	L1 volt-amps reactive	Float	VAR	
218-219	L2 volt-amps reactive	Float	VAR	
220-221	L3 volt-amps reactive	Float	VAR	
222-223	L1 True Power Factor	Float	-	Value between -1.0 and +1.0
224-225	L2 True Power Factor	Float	-	Value between -1.0 and +1.0
226-227	L3 True Power Factor	Float	-	Value between -1.0 and +1.0
228-229	L2 Flicker P _{inst}	Float	-	Instantaneous value. For L1 see 72-73
230-231	L3 Flicker P _{inst}	Float	-	Instantaneous value. For L1 see 72-73
232-233	L2 Flicker P _{ST}	Float	-	10-minute value. For L1 see 74-75
234-235	L3 Flicker P _{ST}	Float	-	10-minute value. For L1 see 74-75
236-237	L2 Flicker P _{LT}	Float	-	2-hour value. For L1 see 76-77
238-239	L3 Flicker P _{LT}	Float	-	2-hour value. For L1 see 76-77
240-241	VARh	Float		VAR-hours accumulated since [date] - shares this reset date with Energy, see registers 131-133
242	DC Energy– “since” date	Integer	Year	Typical values: 2009, 2010, etc.
243	DC Energy– “since” date	Integer	Month	Range: 1 – 12
244	DC Energy– “since” date	Integer	Day	Range: 1 – 31
245	Reset Energy Accumulators	Write-only	-	Set this register to 1 to reset the energy accumulators in your PQube
246	Reset Analog Energy Accumulators	Write-only	-	Set this register to 1 to reset the analog energy accumulators in your PQube



PQube Modbus – Static Information

The following registers change only when the PQube is reset:

Offset	Register	Format	Units	Comments
1000	PQube Firmware – Major rev	Integer	-	Typically formatted as “1.1.2” or similar – Major.Minor.Bugfix
1001	PQube Firmware – Minor rev	Integer	-	
1002	PQube Firmware – Bug fix rev	Integer	-	
1003	PQube Firmware build number	Integer	-	Factory use
1004-1005	Nominal L-N voltage	Float	RMS Volts	
1006-1007	Nominal L-L voltage	Float	RMS Volts	
1008-1009	Nominal frequency	Float	Hertz	
1010-1011	PT (potential transformer) ratio	Float	-	
1012-1013	CT (current transformer) ratio	Float	-	
1014-1015	PQube serial number	Float	-	PQube serial number, without leading “P” and leading zeros
1016 -1017	AN1 (Analog 1-E) multiplier	Float	-	
1018 -1019	AN2 (Analog 2-E) multiplier	Float	-	
1020 - 1021	Current basis for TDD	Float	RMS Amps	Used for calculating IEEE 519 Current TDD, and for setting the maximum current of interest.
1022	Power configuration	Integer	-	0 = single-phase L1-N 1 = single-phase L1-L2 2 = split single-phase 3 = Star / Wye 4 = Delta 5 = Split-phase Delta 255 = Not yet determined
1023	Ground Point	Integer		0 = centered between all 3 phases 1 = L1 2 = L2 3 = L3 4 = centered between L1 and L2 5 = centered between L2 and L3 6 = centered between L3 and L1
1024	N-minutes	Integer		User-defined interval for peak current, power, and apparent power measurements. 15 minutes is the default value. In the setup file, you can define N to be 3, 5, 10, 15, 20, 30, or 60 minutes.

Appendix 2 – Setup File Guide

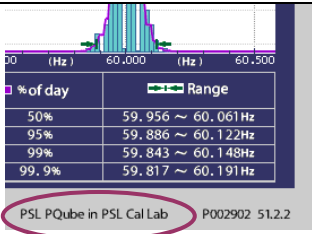
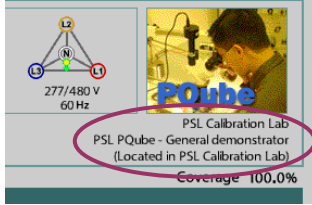
PQube Setup

Setup.ini Tags	Comments	Valid Values	Example
[PQube_Information]	General Information about your PQube		
PQube_ID="PSL PQube in PSL Cal Lab"	The unique identifier will appear on all output information. Quotation marks (") are required.	Any combination of letters, numbers, spaces and special characters up to 63 characters	
Location_Name="PSL Calibration Lab" Note_1="PSL PQube – General Demonstrator" Note_2="(Located in PSL Calibration Lab)"	Appears on all Event/Snapshot and Trends and Statistics recordings. Quotation marks (") are required.	Any combination of letters, numbers, spaces and special characters up to 63 characters	
Power_Configuration=AUTO	Set this tag to AUTO if you want your PQube to automatically choose its Power Configuration based on the voltage it finds on its input terminals when it starts up. Alternatively, you can specify exactly which power configuration you would like your PQube to lock onto.	AUTO Single_Phase_L1_N Single_Phase_L1_L2 Split_Phase Star Wye Delta	

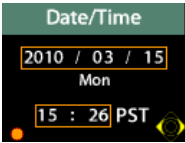
Setup.ini Tags	Comments	Valid Values	Example
Time_Zone=	Enter the time zone where your PQube is located. UTC sometimes called Greenwich Mean Time (GMT)	Any combination of 3 or 4 capital letters	
Offset_From_UTC_In_Hours=	<p>Choose the number of hours your PQube should add or subtract from UTC to calculate your local time, if you are using SNTP protocol to set your PQube's time.</p> <p>For example, the offset from UTC in Pacific Standard Time is -8.</p>	-12 to +13	Offset_From_UTC_In_Hours=-8
UPS_Time_In_Minutes=3	Specify how long your PQube stays on after losing instrument power.	1 to 9	
PQube_Primary_Language=	Sets the first language for the GIF output files	See Languages folder for list of valid languages	
PQube_Secondary_Language=	Sets the secondary language for the GIF files	See Languages folder for list of valid languages	
[Nominal_Inputs]			
<p>Nominal_Phase_To_Phase_Voltage=AUTO</p> <p>Nominal_Phase_To_Neutral_Voltage=AUTO</p>	<p>By default, your PQube will automatically detect your nominal voltage if it is one of the following:</p> <p>Phase-Neutral 69V, 120V, 230V, 277V, 350V, or 400V</p> <p>Phase-Phase 69V, 100V, 200V, 208V, 240V, 400V, 480V, 600V, or 690V</p> <p>If using Potential Transformers, you will need to enter the nominal voltage multiplied by the ratio.</p>	<p>AUTO</p> <p>Any number between 50 to 400 for Phase-Neutral</p> <p>Any number between 50 to 690 for Phase-Phase</p>	<p>Nominal_Phase_To_Phase_Voltage=110</p> <p>If using a 1000:1 Potential Transformer:</p> <p>Nominal_Phase_To_Phase_Voltage=110000</p>

Setup.ini Tags	Comments	Valid Values	Example
Nominal_Frequency=AUTO	<p>By default, your PQube will automatically detect your nominal frequency if it is 50, 60, or 400 Hz.</p> <p>You can also manually set the frequency to 50, 60, or any frequency between 320 and 560Hz.</p>	<p>AUTO</p> <p>50</p> <p>60</p> <p>Any number between 320 to 560</p>	
[Recordings]			
<p>GIF_Graphs=ON</p> <p>CSV_Files=ON</p> <p>PQDIF_Files=OFF</p>	<p>Specify which file formats to save your recordings in.</p> <p>CSV files take the shortest amount of time to process.</p> <p>GIF files take a little longer to process.</p> <p>PQDIF files take the longest time to process.</p>	<p>ON</p> <p>OFF</p>	
Recorded_Samples_Per_Cycle=128	<p>Event/Snapshot Waveform buffer contains 2048 samples. Reduce the sampling rate to increase the number of cycles, or increase the sampling rate to capture more detail.</p> <p>NOTE: If you turn on harmonic recording, your sampling rate will automatically be set to 128 samples per cycle.</p>	<p>32</p> <p>64</p> <p>128</p> <p>256</p>	
Event_RMS_Recording_Definition=Urms1/2	<p>Urms1/2 is the overlapping single-cycle RMS refreshed every half cycle, as defined in IEC 61000-4-30.</p> <p>Urms1 is the non-overlapping single-cycle RMS, which produces half as much data per second, so the total time of the RMS graphs is doubled.</p>	<p>Urms1/2</p> <p>Urms1</p>	
Capture_End_Of_Event=ON	<p>Turning this setting OFF allows you to see up to 2048 samples at the beginning of an event, in exchange for discarding the end of event data.</p>	<p>ON</p> <p>OFF</p>	
Setup.ini Tags	Comments	Valid Values	Example

Behavior_When_SD_Card_is_Full=DISCARD_OLDEST_MONTH	When the SD card becomes full, your PQube can automatically delete the oldest month of data, or you can choose to stop recording.	DISCARD_OLDEST_MONTH STOP_RECORDING	
Budeanu_VARS_Column_in_Event_CSV_Files=AUTO	Enable this option to show Budeanu VARs in event CSV files. The AUTO setting turns this value ON or OFF, depending if the Budeanu calculation method is selected or not.	AUTO ON OFF	
Fundamental_VARS_Column_in_Event_CSV_Files=OFF	Enables Fundamental VARs in event CSV files. Note that Fundamental VARs are calculated based on 10/12 cycle data, not every cycle like Budeanu VARs.	ON OFF	
[Channels]			
Record_Phase_To_Phase_Channels=AUTO Record_Phase_To_Neutral_Channels=AUTO	If your Power Configuration includes a neutral conductor, your PQube will automatically be set to record Phase-Neutral channels. If your Power Configuration includes multiple phases, it will automatically record Phase-Phase channels.	AUTO ON OFF	
Record_AN1_E_Channel=AUTO Record_AN2_E_Channel=AUTO Record_AN1_AN2_Channel=AUTO Record_DIG1_Channel=AUTO	The AUTO setting records the Analog and Digital Input channels if Events are enabled on these channels.	AUTO ON OFF	
Record_Flicker=ON Record_Voltage_THD=ON Record_Current_TDD=ON Record_Voltage_Unbalance=ON Record_Current_Unbalance=ON		ON OFF	
Setup.ini Tags	Comments	Valid Values	Example

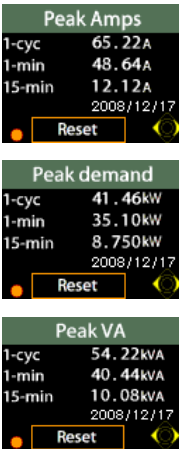
Record_Neutral_Current=ON Record_Earth_Current=ON			
[Measurement_Setup]			
Peak_Demand_Interval_In_Minutes=15	<p>There are three Peak Measurement screens in your PQube:</p> <p>Peak Amps</p> <p>Peak Demand</p> <p>Peak VA</p> <p>For each screen, three measurement intervals are provided:</p> <p>1-cycle</p> <p>1-minute</p> <p>15-minute</p> <p>The 15-minute interval is user configurable using this tag.</p>	<p>3</p> <p>5</p> <p>10</p> <p>15</p> <p>20</p> <p>30</p> <p>60</p>	
VAR_Calculations=Budeanu	Budeanu VARs are calculated every cycle, while Fundamental VARs are calculated on a 10/12 cycle basis, non-gapless. Fundamental VARs can be positive or negative.	Budeanu Fundamental	
TDD_Available_Current_In_Amps=AUTO	Set the supply current level for TDD calculation.	AUTO Any number [amps]	
Enable_10_Second_Frequency=OFF	By default, frequency is updated every 1 second. Set this tag to ON to record frequency according to the IEC 61000-4-30 standard.	ON OFF	
Unbalance_Calculation_Method=IEC	The ANSI unbalance method considers only three-phase RMS magnitudes (not angles). It includes both fundamental and harmonic voltages and currents. This method produces a single value of unbalance. It	ANSI IEC GB	

	<p>is widely used in North America.</p> <p>The IEC unbalance method considers both three-phase magnitudes and the angles between the phases. It is limited to the fundamental voltage or current only – it does not take into account any harmonic voltages or currents. This method produces two values of unbalance: zero-sequence unbalance, and negative-sequence unbalance. It is widely used throughout the world.</p> <p>The GB unbalance method is similar to the IEC unbalance method, but includes time-averaging features. It is used in China.</p>		
Analog_Range=HIGH	<p>All PQube-02 have two separate ranges for the Analog channels.</p> <p>High Range full scale: 70VAC or ±100VDC</p> <p>Low Range full scale: 7VAC or ±10VDC</p>	<p>HIGH</p> <p>LOW</p>	
Voltage_Harmonics=VOLTS_AND_THD	View voltage harmonics as absolute volts, or as percent of fundamental.	<p>VOLTS_AND_THD</p> <p>PERCENT_OF_FUNDAMENTAL_AND_THD</p>	
Current_Harmonics=AMPS_AND_TDD	View current harmonics as absolute amps and TDD, or as percent of fundamental and THD.	<p>AMPS_AND_TDD</p> <p>PERCENT_OF_FUNDAMENTAL_AND_THD</p>	
Temperature_Unit=CELSIUS	Choose between Celsius or Fahrenheit units for Temperature. Note that all Temperature settings in the Trend_Settings section and Modbus will always be in Celsius.	<p>CELSIUS</p> <p>FAHRENHEIT</p>	
Flicker_Lamp_Voltage=230	Choose between 120V/60Hz or 230V/50Hz incandescent lamp voltage for Flicker measurements according to IEC 61000-4-15.	<p>120</p> <p>230</p>	
Rotation_Convention_On_Vectors_Screen=COUNTER_CLOCKWISE	<p>The rotation convention used on the Vectors display screen.</p> <p>NOTE: This tag does not affect measurements or rotation</p>	CLOCKWISE	Counter-clockwise:

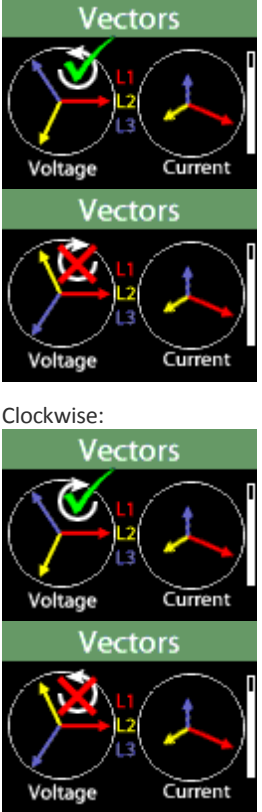
	<p>errors. To fix rotation errors, swap any two phases in the [Adjust_Phase_Connections] section.</p>	<p>COUNTER_CLOCKWISE</p>	 <p>The diagrams illustrate vector rotation for Voltage and Current. The top two diagrams show counter-clockwise rotation, indicated by a green checkmark and a circular arrow. The bottom two diagrams show clockwise rotation, indicated by a red X and a circular arrow. Each diagram includes labels for L1, L2, and L3 phases.</p>
<p>Minimum_Current_Display_In_Percent_Of_Rated_Current=0</p>	<p>A nonzero number here will cause any current reading to be set to zero when it is less than the value specified here, as well as the corresponding VA, Power, etc. for that phase. The "Rated Current" in Amps is the value written on the current module multiplied by any external CT ratio. 1% is a recommended starting point if you want to use this feature.</p>	<p>0 to 100</p>	

Setup.ini Tags	Comments	Valid Values	Example
[Potential_Transformers]			
Potential_Transformer_Ratio=1:1	You can use fractional values such as 1250.5:120	From 1:1 to 10000:1	
L1_E_Voltage_Gain_Calibration_Factor=1.0000 L2_E_Voltage_Gain_Calibration_Factor=1.0000 L3_E_Voltage_Gain_Calibration_Factor=1.0000 N_E_Voltage_Gain_Calibration_Factor=1.0000	Set gain correction factor for mains voltage terminals.	From 0.95 to 1.05	
[Current_Transformers]			
Current_Transformer_Ratio=1:1 Neutral_Current_Transformer_Ratio=1:1 Earth_Current_Transformer_Ratio=1:1	For voltage-input current modules, the second number is the voltage. You can use fractional values such as 100.35:0.333	From 1:1 to 10000:1	
Invert_L1_Current_Channel=OFF Invert_L2_Current_Channel=OFF Invert_L3_Current_Channel=OFF Invert_N_Current_Channel=OFF Invert_E_Current_Channel=OFF	If your CTs have been installed backwards, you can reverse the polarity here.	ON OFF	
Calculate_Current_Channel=OFF	If you have current transformers on all conductors except one, your PQube can calculate the remaining channel.	ON L1 L2 L3 N E	

Setup.ini Tags	Comments	Valid Values	Example
[Adjust_Phase_Connections]			
L1_Input_Connected_To=L1 L2_Input_Connected_To=L2 L3_Input_Connected_To=L3 N_Input_Connected_To=N L1_Amps_Input_Connected_To=L1 L2_Amps_Input_Connected_To=L2 L3_Amps_Input_Connected_To=L3 N_Amps_Input_Connected_To=N E_Amps_Input_Connected_To=E	Use this section to correct any installation errors during installation.	L1 L2 L3 N E	L1_Input_Connected_To=L2 (This means the L1 screw terminal is connected to the L2 conductor.)
[Analog_Ratios]			
AN_Energy_Mode=OFF	Enables AN1xAN2 channel for DC power and energy measurements. Use with ATT2 module.	ON OFF	
AN1-E_Channel_Ratio=1:1 AN2-E_Channel_Ratio=1:1	You can use fractional values.	From 1:1 to 10000:1	
Resistive_Attenuator_Correction=OFF	To increase accuracy, you should set this to ON if you are using an optional external ATT1-600V or ATT1-1200V module with your PQube's AN1 and AN2 screw terminals.	ON OFF	
Analog_Measurement_Mode=DC_RMS	Increases accuracy by applying a small adjustment factor that compensates for digital filtering.	AC_RMS DC_RMS	
Swap_AN1_And_AN2_Connections=OFF	Use this to fix an installation error on the Analog channels.	ON OFF	

Setup.ini Tags	Comments	Valid Values	Example
Analog_1_Channel_Name="AN1-E" Analog_1_Channel_Unit="V" Analog_2_Channel_Name="AN2-E" Analog_2_Channel_Unit="V"	Use these tags to customize your channel names and units.	Valid names can be up to 5 characters. Valid units are: "V", "A", "W", "DEG", "%", "NONE"	Analog_1_Channel_Name="DCV" Analog_1_Channel_Unit="V" Analog_2_Channel_Name="DCI" Analog_2_Channel_Unit="A"

Configure Event Triggering

Setup.ini Tags	Comments	Valid Values	Example
[Phase_To_Neutral_Events]			
Phase_To_Neutral_Events=AUTO	Use the AUTO setting to let your PQube decide to record Phase-Neutral events or not. If your Power Configuration includes a Neutral conductor, your PQube will record Phase-Neutral events.	AUTO ON OFF	
Dip_Threshold_In_Percent=90.00 Swell_Threshold_In_Percent=110.00 Interruption_Threshold_In_Percent=10.00 Event_Hysteresis_In_Percent=2.00	Set thresholds for Voltage Dips, Swells, and Interruptions. Percent refers to Percent remaining of nominal voltage.		
[Phase_To_Phase_Events]			
Phase_To_Phase_Events=AUTO	Use the AUTO setting to let your PQube decide to record Phase-Phase events or not. If your Power Configuration includes multiple phases, your PQube will record Phase-Phase events.	AUTO ON OFF	

Setup.ini Tags	Comments	Valid Values	Example
Dip_Threshold_In_Percent=90.00 Swell_Threshold_In_Percent=110.00 Interruption_Threshold_In_Percent=10.00 Event_Hysteresis_In_Percent=2.00	Set thresholds for Voltage Dips, Swells, and Interruptions. Percent refers to Percent remaining of nominal voltage.		
[Frequency_Events]			
Frequency_Events=ON	Trigger events for frequency.	ON OFF	
Underfrequency_Threshold_In_Percent=99.50 Overfrequency_Threshold_In_Percent=100.50 Event_Hysteresis_In_Percent=0.20	Set thresholds for frequency event detection here.		
[High_Frequency_Impulse_Events]			
HF_Impulse_Events=ON	Set this tag to ON to begin recording transients or high frequency impulses. The detection threshold is 450V peak. Your PQube can detect transients as short as 1 microsecond.	ON OFF	
[Snapshot_Events]			
Waveform_Snapshot_Interval_In_Hours=24	Your PQube is scheduled to record a Snapshot of your electric power at this interval. When the interval is 24 hours, your PQube will take a Snapshot of your power at 12 noon every day.	OFF 3 6 24	

Setup.ini Tags	Comments	Valid Values	Example
Waveform_Snapshot_At_Startup=OFF	Set this tag to ON to take a Snapshot of your electric power every time your PQube is powered on or reset.	ON OFF	
Enable_Snapshot_Harmonics=ON	Set this tag to ON to include a harmonics spectrum for voltage (and current, where applicable) when a Snapshot is generated. NOTE: Your PQube's sampling rate must be set to 128.	ON OFF	
[AN1_E_Events]			
AN1_E_Events=OFF	Set this tag to ON to enable event triggering on your Analog channel 1.	ON OFF USER_COUNTER	
Dip_Threshold_In_Volts=2.00 Swell_Threshold_In_Volts=60.00 Event_Hysteresis_In_Volts=0.5	Set event detection thresholds for Analog channel 1.		
[AN2_E_Events]			
AN2_E_Events=OFF	Set this tag to ON to enable event triggering on your Analog channel 2.	ON OFF USER_COUNTER	
Dip_Threshold_In_Volts=2.00 Swell_Threshold_In_Volts=60.00 Event_Hysteresis_In_Volts=0.5	Set event detection thresholds for Analog channel 2.		

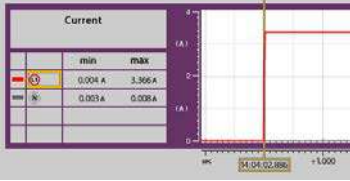
Setup.ini Tags	Comments	Valid Values	Example
[AN1_AN2_Events]			
AN1_AN2_Events=OFF	Set this tag to ON to enable event triggering using AN1 and AN2 differential voltage.	ON OFF USER_COUNTER	
Dip_Threshold_In_Volts=2.00 Swell_Threshold_In_Volts=60.00 Event_Hysteresis_In_Volts=0.5	Set event detection thresholds for AN1-AN2 voltage.		
[DIG1_Events]			
Enable_DIG1_Dip_Event=OFF Enable_DIG1_Swell_Event=OFF	Trigger events on the DIG1 channel. When configuring the DIG1 events, take care not to unintentionally get stuck in an infinite event.	ON OFF	
DIG1_Dip_Threshold=0.5 DIG1_Swell_Threshold=0.5 DIG1_Event_Hysteresis=0.1			
[Phase_Current_Events]			
Phase_Current_Events=OFF	Trigger events for current on L1, L2, and/or L3.	ON OFF	
Level_Threshold_In_Amps=AUTO Level_Hysteresis_In_Amps=AUTO	Set the level threshold here. Your PQube will record an event when the current exceeds this level.		
Inrush_Threshold_In_Amps=AUTO Inrush_Threshold_In_Cycles=2	Set the inrush threshold here. Your PQube will record an event when the current exceeds the Inrush_Threshold_In_Amps value, for a period of the Inrush_Threshold_In_Cycles or less.		
Setup.ini Tags	Comments	Valid Values	Example
[Neutral_Current_Events]			

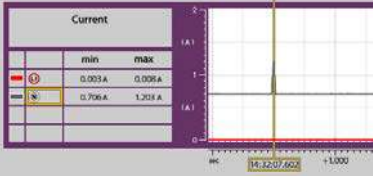
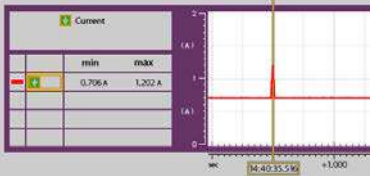
<p>Neutral_Current_Events=OFF</p>	<p>Trigger events for current on the Neutral channel.</p>	<p>ON OFF</p>	
<p>Level_Threshold_In_Amps=AUTO Level_Hysteresis_In_Amps=AUTO</p>	<p>Set the level threshold here. Your PQube will record an event when the current exceeds this level.</p>		
<p>Inrush_Threshold_In_Amps=AUTO Inrush_Threshold_In_Cycles=2</p>	<p>Set the inrush threshold here. Your PQube will record an event when the current exceeds the Inrush_Threshold_In_Amps value, for a period of the Inrush_Threshold_In_Cycles or less.</p>		
<p>[Earth_Current_Events]</p>			
<p>Earth_Current_Events=OFF</p>	<p>Trigger Earth Current events.</p>	<p>ON OFF</p>	
<p>Level_Threshold_In_Amps=AUTO Level_Hysteresis_In_Amps=AUTO</p>	<p>Set the level threshold here. Your PQube will record an event when the current exceeds this level.</p>		
<p>Inrush_Threshold_In_Amps=AUTO Inrush_Threshold_In_Cycles=2</p>	<p>Set the inrush threshold here. Your PQube will record an event when the current exceeds the Inrush_Threshold_In_Amps value, for a period of the Inrush_Threshold_In_Cycles or less.</p>		

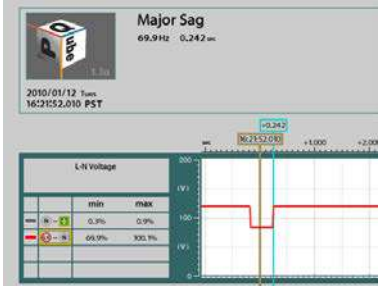
Setup.ini Tags	Comments	Valid Values	Example
[Major_Dip_Events]			
Major_Dip_Threshold_Settings=OFF	<p>Major Dips are defined by the selected depth/duration curve. This is useful for emulating PSL's PQ1 Power Quality Relay.</p> <p>When a dip exceeds the thresholds as specified by the selected standard, it will be characterized as a Major Dip.</p>	<p>OFF</p> <p>ITIC</p> <p>CBEMA</p> <p>SEMI F47</p> <p>STANDARD</p> <p>SAMSUNG_POWER_VACCINE</p> <p>MIL_STD_704E</p> <p>MIL_STD_1399</p> <p>CUSTOM</p>	
<p>Major_Dip_Threshold_Level_1_in_Percent=OFF</p> <p>Major_Dip_Threshold_Level_1_Duration_in_Seconds=0</p> <p>Major_Dip_Threshold_Level_2_in_Percent=OFF</p> <p>Major_Dip_Threshold_Level_2_Duration_in_Seconds=0</p> <p>Major_Dip_Threshold_Level_3_in_Percent=OFF</p> <p>Major_Dip_Threshold_Level_3_Duration_in_Seconds=0</p> <p>Major_Dip_Threshold_Level_4_in_Percent=OFF</p> <p>Major_Dip_Threshold_Level_4_Duration_in_Seconds=0</p>	<p>This configuration is only valid if you set the Major_Dip_Threshold_Setting to CUSTOM for the user to create their own custom threshold. Each additional threshold has to be lower than the previous, and each duration has to be shorter.</p> <p>Example of valid Usage:</p> <p>Major_Dip_Threshold_Level_1_in_Percent=80</p> <p>Major_Dip_Threshold_Level_1_Duration_in_Seconds=5</p> <p>Major_Dip_Threshold_Level_2_in_Percent=50</p> <p>Major_Dip_Threshold_Level_2_Duration_in_Seconds=0.5</p> <p>Example of invalid Usage:</p> <p>Major_Dip_Threshold_Level_1_in_Percent=70</p> <p>Major_Dip_Threshold_Level_1_Duration_in_Seconds=2</p> <p>Major_Dip_Threshold_Level_2_in_Percent=80</p> <p>Major_Dip_Threshold_Level_2_Duration_in_Seconds=1</p>		
[Waveshape_Change_Events]			

<p>Waveshape_Change_Events=ON</p>	<p>Trigger a Waveshape Change when the voltage waveform changes abruptly. This is useful for detecting power factor correction capacitor switching.</p>	<p>ON OFF</p>	
<p>Voltage_Threshold_In_Percent_Of_Nominal=20.00 Duration_Threshold_In_Percent_Of_Cycle=10.00</p>	<p>If the voltage change from one cycle to the next exceeds the selected threshold, for the selected duration or longer, a Waveshape Change will be triggered.</p>		
<p>[External_Probe_Events]</p>			
<p>Probe_1_Overtemperature_Events=ON Probe_1_Undertemperature_Events=OFF Probe_1_Undertemperature_Threshold_in_Deg_C=0 Probe_1_Overtemperature_Threshold_in_Deg_C=60 Probe_1_Temperature_Event_Hysteresis_in_Deg_C=2 Probe_1_High_Humidity_Events=OFF Probe_1_Low_Humidity_Events=OFF Probe_1_Low_Humidity_Threshold_in_Percent_RH=0 Probe_1_High_Humidity_Threshold_in_Percent_RH=100 Probe_1_Humidity_Event_Hysteresis_in_Percent_RH=2 Probe_2_Overtemperature_Events=OFF Probe_2_Undertemperature_Events=OFF Probe_2_Undertemperature_Threshold_in_Deg_C=0 Probe_2_Overtemperature_Threshold_in_Deg_C=50 Probe_2_Temperature_Event_Hysteresis_in_Deg_C=2 Probe_2_High_Humidity_Events=OFF</p>	<p>Show pop ups, recent event screens, and event depth duration based on temperature/humidity thresholds from either channel.</p>		

<p>Probe_2_Low_Humidity_Events="OFF"</p> <p>Probe_2_Low_Humidity_Threshold_in_Percent_RH=0</p> <p>Probe_2_High_Humidity_Threshold_in_Percent_RH=100</p> <p>Probe_2_Humidity_Event_Hysteresis_in_Percent_RH=2</p>			
<p>[Event_Relay_Trigger]</p>			
<p>Trigger_Relay_On_Dip=OFF</p> <p>Trigger_Relay_On_Major_Dip=OFF</p> <p>Trigger_Relay_On_Swell= OFF</p> <p>Trigger_Relay_On_Interruption= OFF</p> <p>Trigger_Relay_On_AN1_Dip= OFF</p> <p>Trigger_Relay_On_AN1_Swell= OFF</p> <p>Trigger_Relay_On_AN2_Dip= OFF</p> <p>Trigger_Relay_On_AN2_Swell= OFF</p> <p>Trigger_Relay_On_AN1_AN2_Dip= OFF</p> <p>Trigger_Relay_On_AN1_AN2_Swell= OFF</p> <p>Trigger_Relay_On_DIG1_Dip= OFF</p> <p>Trigger_Relay_On_DIG1_Swell= OFF</p> <p>Trigger_Relay_On_Underfrequency= OFF</p> <p>Trigger_Relay_On_Overfrequency= OFF</p> <p>Trigger_Relay_On_Impulse= OFF</p> <p>Trigger_Relay_On_Snapshot= OFF</p> <p>Trigger_Relay_On_Waveshape_Change= OFF</p> <p>Trigger_Relay_On_Phase_Current= OFF</p>	<p>Your PQube triggers for many types of events. You can choose which of these events will open one or more relays. Each relay will remain open for 3 seconds or the event duration, whichever is longer.</p> <p>Here are a few simple rules:</p> <ul style="list-style-type: none"> You can connect any event to any relay. One relay may be connected to multiple events, and any event can be connected to multiple relays. RLY1 is standard. RLY2, RLY3, and RLY4 are included in the factory-installed RLY option. Enter 1, 2, 3, 4 (or any combination of those numbers) into the relay-eventtags to attach that relay to that event. Enter OFF if you don't want that event to trigger a relay. 	<p>OFF</p> <p>1</p> <p>2</p> <p>3</p> <p>4</p>	<p>Trigger_Relay_On_Dip=1</p> <p>Trigger_Relay_On_Major_Dip=3</p> <p>Trigger_Relay_On_Swell=24</p> <p>Trigger_Relay_On_Interruption=1234</p>

Trigger_Relay_On_Neutral_Current= OFF Trigger_Relay_On_Earth_Current= OFF Trigger_Relay_On_Probe_1_Undertemperature=OFF Trigger_Relay_On_Probe_1_Overtemperature=OFF Trigger_Relay_On_Probe_1_Low_Humidity=OFF Trigger_Relay_On_Probe_1_High_Humidity=OFF Trigger_Relay_On_Probe_2_Undertemperature=OFF Trigger_Relay_On_Probe_2_Overtemperature=OFF Trigger_Relay_On_Probe_2_Low_Humidity=OFF Trigger_Relay_On_Probe_2_High_Humidity=OFF			
--	--	--	--

Network Configuration

Setup.ini Tags	Comments	Valid Values	Example
[Network_Setup]			
IP_Address_Method=Use_DHCP	If you are automatically assigned an IP address by your network, use DHCP. If you are using a static IP, use Fixed IP.	Use_DHCP Use_Fixed_IP	
Publish_IP_Address=ON	Specify whether you want your PQube's emails to include the IP address or not.	ON OFF	
Ethernet_Link_Speed_Duplex=AUTO		AUTO 10HALF 10FULL 100HALF 100FULL	
GARP_Interval_In_Minutes=0			

[Fixed_IP]			
IP_Address= IP_Mask= IP_Gateway= IP_DNS1= IP_DNS2=	Enter your IP address information here. This information is ignored if DHCP is selected.		

Setup.ini Tags	Comments	Valid Values	Example
[Email_Server_Settings]			
SMTP_Server= SMTP_Server_Port=DEFAULT POP_Server= POP_Server_Port=DEFAULT	Enter your email server settings here. Outgoing mail typically goes through SMTP servers, and incoming mail typically comes through the POP server.		
PQube_Email_Address= PQube_Email_User_Name= PQube_Email_Password=	IMPORTANT: Your PQube needs its own e-mail account. Do not try to share your personal e-mail account with your PQube – if you do, it will try very hard to receive all of your e-mails. You can get a free, temporary PQube e-mail account from PSL. Contact support@powerstandards.com		
On_Failure_Retry_N_Times=3	Set how many times your PQube should try to reconnect to your email server.	Any number	
POP_Auth_Method=AUTO		AUTO USER-PASS PLAIN LOGIN DIGEST-MD5 CRAM-MD5 APOP	
SMTP_Auth_Method=AUTO		AUTO	

		NONE PLAIN LOGIN DIGEST-MD5 CRAM-MD5	
--	--	--	--

Setup.ini Tags	Comments	Valid Values	Example
[Incoming_Email]			
Incoming_Email=OFF	Allow your PQube to receive incoming email.	ON OFF	
Check_Every_N_Minutes=10	Set how often your PQube will check for incoming mail.		
[Incoming_Email_Filter]			
Subject_Must_Begin_With=PQube	Your PQube will only accept incoming emails when the Subject begins with this keyword. This is another layer of security for your PQube.		Subject: PQube Firmware Update Subject: PQube Send Logs Subject: PQube Reset PQube
Email_Must_Be_From_1= Email_Must_Be_From_2= Email_Must_Be_From_3= Email_Must_Be_From_4= Email_Must_Be_From_5=	If this list is left blank, then your PQube will accept emails from anyone. If any email addresses are added to this list, then your PQube will only accept emails from recipients on this list.		
[Outgoing_Email]			
Enable_Event_Summary_Email=OFF	Summary emails are short, plain-text notifications with Event Type, Magnitude, Duration, Trigger Date, Trigger Time, Channel, and Threshold.	ON OFF	
Event_Summary_Email_To_1=	These are the recipients of the Event Summary emails.		

Event_Summary_Email_To_2= Event_Summary_Email_To_3=			
Send_Email_On_Recording=OFF	Receive an email notification whenever your PQube resets, records an Event or Snapshot, or generates Trends and Statistics.	ON OFF	
Send_Reset_Emails=OFF Send_Events_Emails=OFF Send_Trends_Emails=OFF	Choose which types of emails you want from your PQube. Useful for reducing your data usage by receiving only the types of emails that you need.	ON OFF	
Setup.ini Tags	Comments	Valid Values	Example
Email_Subject_Begins_With=PQube	All emails sent from your PQube will have a Subject beginning with this keyword.		
Email_Body_Type=Human_Readable_HTML	Select the format of the email body.	Human_Readable_HTML Human_Readable_Text Machine_Readable_XML	
Email_To_1= Email_To_2= Email_To_3= Email_To_4= Email_To_5= Email_CC_1= Email_CC_2= Email_CC_3= Email_CC_4= Email_CC_5=	Your PQube will send emails to the recipients on this list.		
Allow_Plain_Text_Authentication=ON		ON	

		OFF	
[FTP_Settings]			
FTP_Server=ON	Enable FTP access to your PQube	ON OFF	
FTP_User_Name=PQube FTP_Password=PQube			
FTP_Control_port=DEFAULT FTP_Data_port=DEFAULT			
Setup.ini Tags	Comments	Valid Values	Example
[Web_Server_Settings]			
Web_Server=ON	Enable your PQube's HTTP Web Server	ON OFF	
Web_Server_port=DEFAULT			
Require_HTTP_Authorization=OFF HTTP_User_Name= HTTP_Password=	Restrict general access to your PQube's Web Server		
Require_HTTP_Admin_Authorization=ON HTTP_Admin_User_Name=admin HTTP_Admin_Password=admin	Restrict access to the Commands section of your PQube's Web Server.		
[Modbus]			
Modbus_Slave_Device_Address=1			
Modbus_TCP_port=502			
Modbus_Register_Start_Address=7000			
Byte_Order=BIG_ENDIAN	Big Endian byte order stores the most significant number in the first byte.	BIG_ENDIAN LITTLE_ENDIAN	

	Little Endian byte order stores the least significant number in the first byte.		
[Output_Formatting]			
Decimal_Separator="." Date_Separator="/" Time_Separator=":" CSV_Separator=","	Set the Decimal, Date, Time, and CSV separator characters here. These affect the PQube display, the meters on the web interface, emails, and output files. NOTE: You must still use a decimal point for all numbers that you enter in the Setup.ini file.		

Setup.ini Tags	Comments	Valid Values	Example
[SNTP_Settings]			
Enable_Sntp=OFF	Synchronize your PQube’s time clock using SNTP	ON OFF	
SNTP_Server=pool.ntp.org			
SNTP_Update_Interval_In_Hours=24		1 to 24	

Setting up your Trends and Statistics

Setup.ini Tags	Comments	Valid Values	Example
[Carbon_Footprint]			
CO2_Emissions=Generated	Typically, you choose “generated” if you are measuring a load, like a building; and you choose “avoided” if you are measuring a green source of electricity like a wind turbine or photovoltaic array.	Generated Avoided	
[Carbon_Intensity]			
Solar_CO2_in_G_Per_KWh=0 Wind_CO2_in_G_Per_KWh=0 Coal_CO2_in_G_Per_KWh=970 Natural_Gas_CO2_in_G_Per_KWh=490 Hydro_CO2_in_G_Per_KWh=0 Diesel_CO2_in_G_Per_KWh=1050 Nuclear_CO2_in_G_Per_KWh=0 Custom_CO2_in_G_Per_KWh=930	These values are based roughly off EPA’s measurements for typical California, USA values. Expressed in grams of CO2 per kilowatt-hour		
Setup.ini Tags	Comments	Valid Values	Example
[Power_Generation_Breakdown]			

<p>Solar_Power_Generation_In_Percent=1.00 Wind_Power_Generation_In_Percent=9.00 Coal_Power_Generation_In_Percent=0.00 Natural_Gas_Power_Generation_In_Percent=64.00 Hydro_Power_Generation_In_Percent=17.00 Diesel_Power_Generation_In_Percent=1.00 Nuclear_Power_Generation_In_Percent=8.00 Custom_Power_Generation_In_Percent=0.00</p>	<p>These values typical for California. Check with your electricity provider to find typical values where your PQube is installed.</p>		
<p>[Trend_Settings]</p>			
<p>Enable_Daily_Trends=ON Enable_Weekly_Trends=ON Enable_Monthly_Trends=ON</p>	<p>Daily Trends and Statistics are recorded every midnight. Weekly Trends and Statistics are recorded every midnight between Sunday and Monday using ISO 8601 methods. Monthly Trends and Statistics are recorded every midnight after the last day of the month.</p>	<p>ON OFF</p>	
<p>Trend_Individual_Phases=ON</p>	<p>If OFF, your PQube records worst-case and average of all phases. If ON, your PQube also records the values of individual phases. This data is available for Voltage, Current, and Power.</p>	<p>ON OFF</p>	
<p>Omit_Flagged_Mains_Voltages_From_Stats=OFF</p>	<p>Disturbances on your power line can skew your statistics, so you may opt to omit these values when your PQube is processing statistics data.</p>	<p>ON OFF</p>	
<p>Unbalance_Component_To_Trend=NEGATIVE</p>	<p>Choose which unbalance component to trend. Only applies if IEC or GB unbalance method is selected.</p>	<p>NEGATIVE ZERO</p>	

Setup.ini Tags	Comments	Valid Values	Example
Trend_Harmonic_Interval_In_Minutes=OFF	<p>Specify the recording interval for harmonics trending. Your PQube will take a 10/12 cycle sample of data every 10 or 15 minutes.</p> <p>NOTE: Your PQube automatically adjusts the sampling rate to 128 samples per cycle if you turn this on.</p>	<p>OFF</p> <p>10</p> <p>15</p>	
Power_Polarity_of_Interest=Positive	<p>Set to Positive for power consumption, set to negative for power generation, or set to BOTH if you are monitoring consumption and generation.</p>	<p>POSITIVE</p> <p>NEGATIVE</p> <p>BOTH</p>	
<p>Min_Volts_of_Interest_in_Percent_of_Nominal=AUTO</p> <p>Max_Volts_of_Interest_in_Percent_of_Nominal=AUTO</p>	<p>Set the minimum and maximum voltage for viewing in Trends and Statistics recordings if the AUTO setting does not provide a suitable graph.</p> <p>The AUTO setting is determined by the Voltage Dip and Swell thresholds.</p> <p>Your PQube intentionally does not auto-scale the Trends and Statistics graphs. This makes it easy to visually compare trends recorded at different times.</p> <p>With auto-scaling, it is difficult to compare two graphs.</p>	<p>AUTO</p> <p>Any number [percent]</p>	
<p>Min_Current_of_Interest_in_Amps=AUTO</p> <p>Max_Current_of_Interest_in_Amps=AUTO</p>	<p>Set the minimum and maximum current for viewing in Trends and Statistics recordings if the AUTO setting does not provide a suitable graph.</p> <p>The AUTO setting is determined by your CT ratio and nominal current rating of your current sensing module.</p>	<p>AUTO</p> <p>Any number [amps]</p>	
<p>Min_Earth_Current_of_Interest_in_Amps=AUTO</p> <p>Max_Earth_Current_of_Interest_in_Amps=AUTO</p>	<p>If your PQube is calculating the Earth Current, AUTO sets the Max_Earth_Current_of_Interest_in_Amps to 5% of the Max_Current_of_Interest_in_Amps value.</p> <p>If measuring the Earth Current with a current transformer, the AUTO setting is determined by your CT ratio and the nominal current rating of your current sensing module.</p>	<p>AUTO</p> <p>Any number [amps]</p>	

Setup.ini Tags	Comments	Valid Values	Example
Min_Frequency_of_Interest_in_Percent_of_Nominal=AUTO Max_Frequency_of_Interest_in_Percent_of_Nominal=AUTO	The AUTO values are determined by the Underfrequency and Overfrequency thresholds.	AUTO Any number [Hz]	
Min_AN1_E_of_Interest_in_RMS_volts=AUTO Max_AN1_E_of_Interest_in_RMS_volts=AUTO	The AUTO values are determined by the Dip and Swell thresholds on Analog Channel 1.	AUTO Any number [volts]	
Min_AN2_E_of_Interest_in_RMS_volts=AUTO Max_AN2_E_of_Interest_in_RMS_volts=AUTO	The AUTO values are determined by the Dip and Swell thresholds on Analog Channel 2.	AUTO Any number [volts]	
Min_AN1_AN2_of_Interest_in_RMS_volts=AUTO Max_AN1_AN2_of_Interest_in_RMS_volts=AUTO	The AUTO values are determined by the AN1-AN2 Dip and Swell thresholds.	AUTO Any number [volts]	
Min_Temperature_of_Interest_in_Degrees_C=0 Max_Temperature_of_Interest_in_Degrees_C=50	Set the minimum and maximum temperature for viewing in Trends and Statistics recordings if the AUTO setting does not provide a suitable graph.	Any number [degrees °C]	
Min_Humidity_of_Interest_in_%_RH=0 Max_Humidity_of_Interest_in_%_RH=100	Set the minimum and maximum relative humidity in % for viewing in Trends and Statistics recordings.	Any number [%RH]	
Max_Voltage_Unbalance_of_Interest_in_Percent=10%	Set the full scale Voltage Unbalance in Trends and Statistics recordings.	Any number [%]	
Max_Current_Unbalance_of_Interest_in_Percent=99%	Set the full scale Current Unbalance in Trends and Statistics recordings.	Any number [%]	
Max_Voltage_THD_of_Interest_in_Percent=10%	Set the full scale THD voltage in Trends and Statistics recordings.	Any number [%]	
Max_Current_TDD_of_Interest_in_Percent=25%	Set the full scale TDD current in Trends and Statistics recordings.	Any number [%]	
Max_Flicker_of_Interest=4	Set the full scale RMS Flicker in Trends and Statistics recordings.	Any number	

Appendix 3 – Ride-Through Curves

Your PQube supports the following world-wide standards: STANDARD (IEC 61000-4-34), SEMI F47, Samsung Power Vaccine, ITIC, CBEMA, MIL-STD 704E, and MIL-STD 1399. These standards define ride-through curves based on the depth and duration of voltage dips. When the voltage dips below the ride-through curve, your PQube will trigger a Major Dip event. You can specify which standard to use in your **Setup.ini** file.

This is especially useful for electrical systems manufacturers, who must design their equipment to withstand voltage sags that do not dip below the ride-through curve.

STANDARD

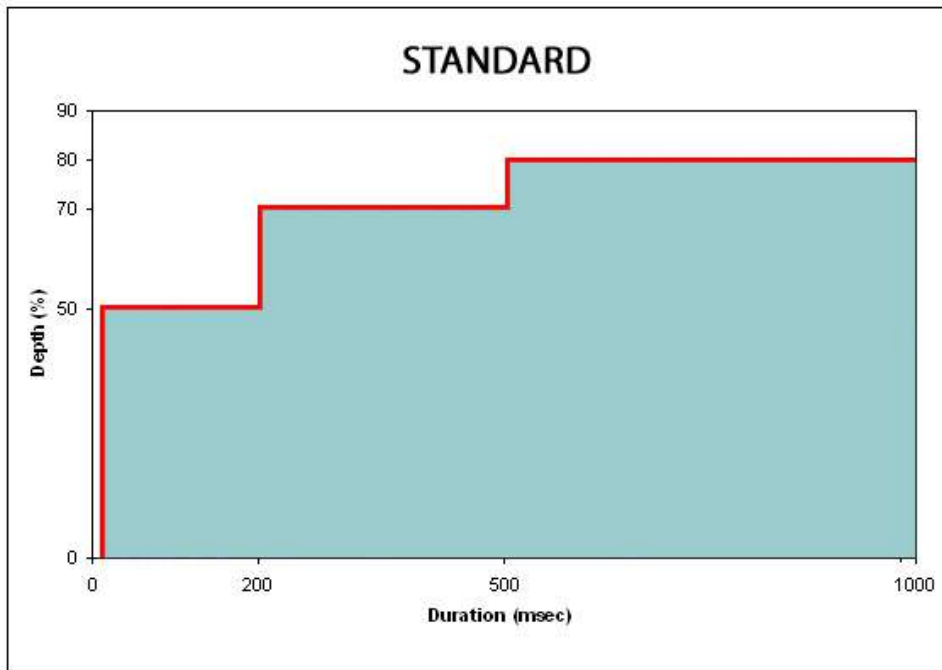

NOTE: Use this curve to detect only events that lie outside the SEMI F47 boundary.

SEMI F47

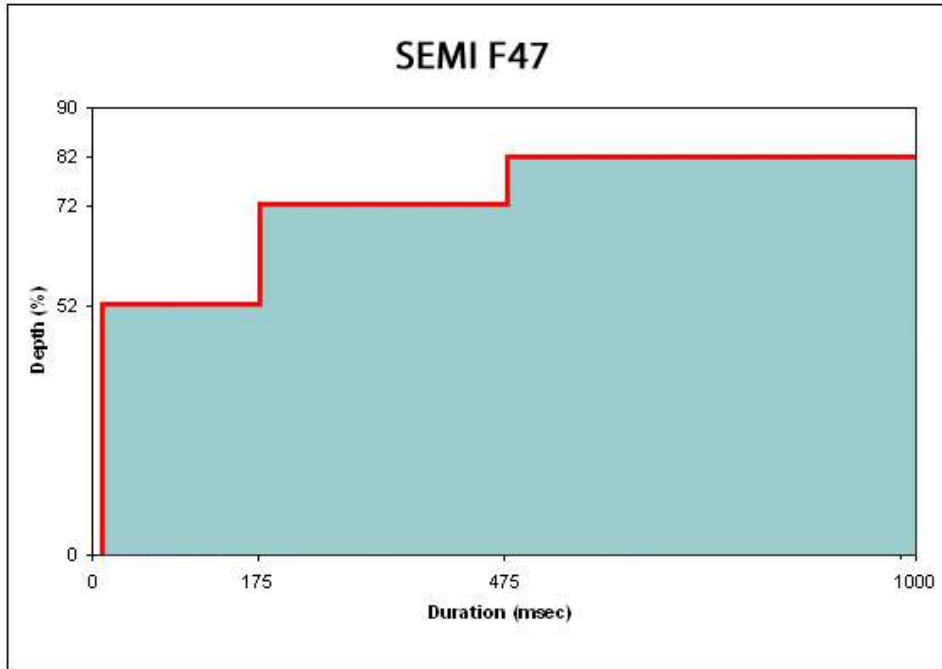

NOTE: Use this curve to guarantee that a Major Dip is detected for events that lie directly on the SEMI F47 boundary.

Samsung Power Vaccine

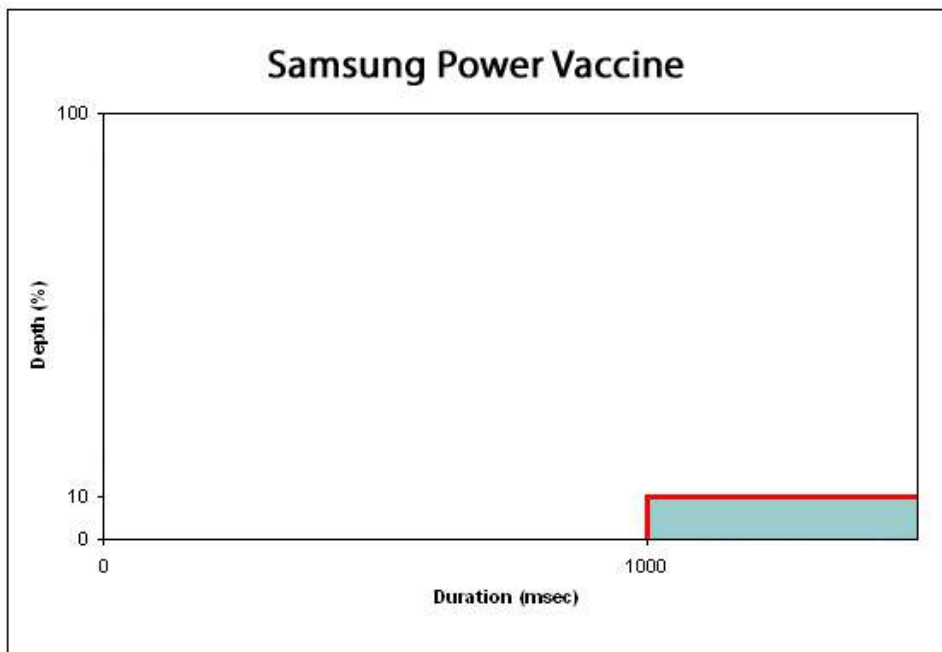

ITIC

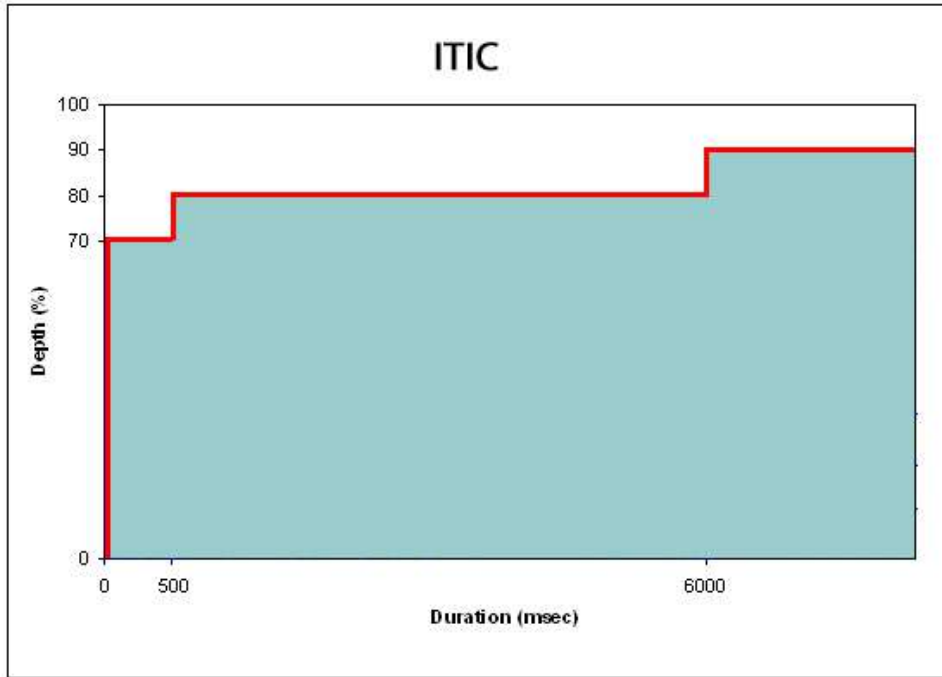

CBEMA

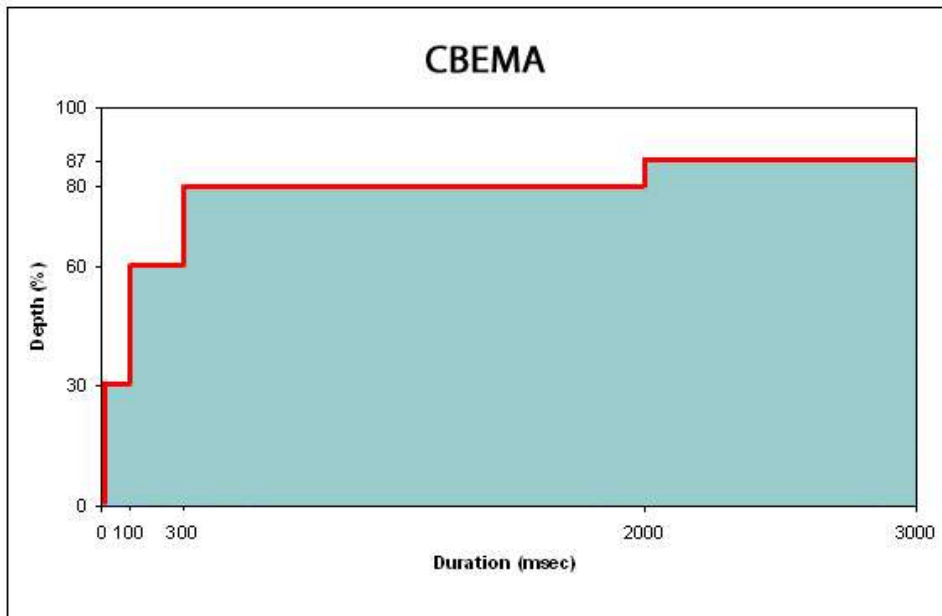

MIL-STD 704E

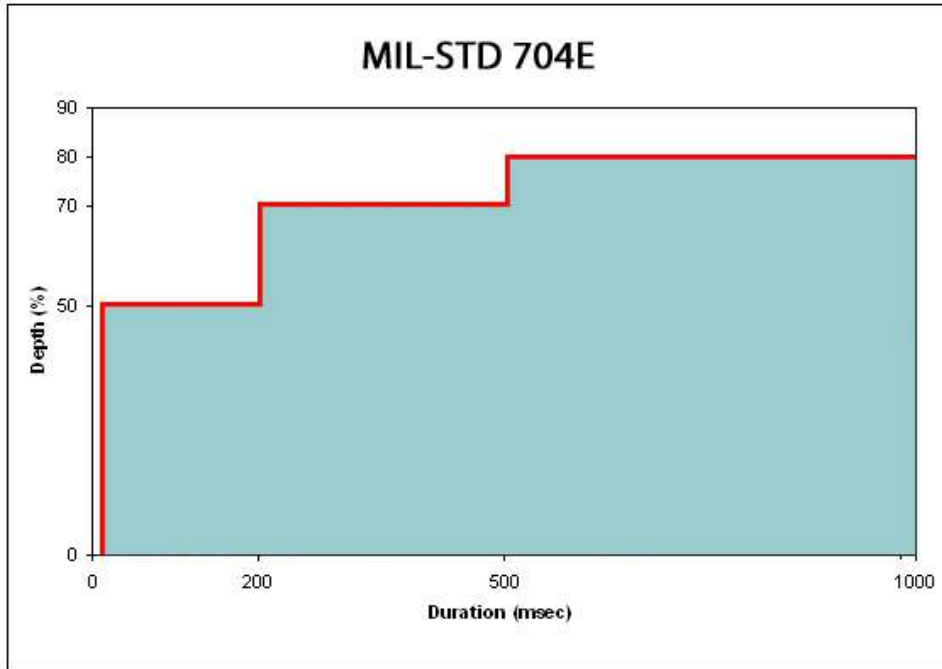

MIL-STD 1399

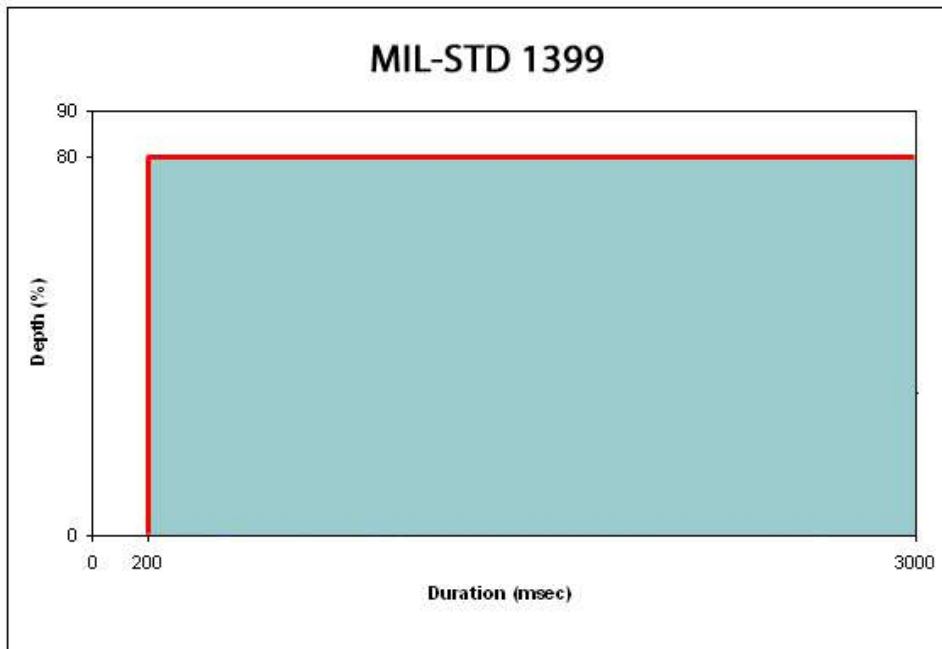

Appendix 4 –MIB Table for SNMP

A beta version of SNMP support is included. SNMP is a common meter reading protocol that is used in data centers worldwide. For easy SNMP installation, a PQube MIB file is available for download from <http://www.PowerStandards.com/PQube> .

Use the following information to connect to your PQube via SNMP:

- SNMP port: 161
- Get community string: pqube
- Set community string: pqube

PQube MIB Table

Offset	Register	Format	Units	Comments
1	L1-E	Float	RMS Volts	L1 to earth – $U_{rms10/12}$
2	L2-E	Float	RMS Volts	L2 to earth – $U_{rms10/12}$
3	L3-E	Float	RMS Volts	L3 to earth – $U_{rms10/12}$
4	N-E	Float	RMS Volts	Neutral to earth – $U_{rms10/12}$
5	L1-N	Float	RMS Volts	L1 to neutral – $U_{rms10/12}$
6	L2-N	Float	RMS Volts	L2 to neutral – $U_{rms10/12}$
7	L3-N	Float	RMS Volts	L3 to neutral – $U_{rms10/12}$
8	L1-L2	Float	RMS Volts	L1 to L2 – $U_{rms10/12}$
9	L2-L3	Float	RMS Volts	L2 to L3 – $U_{rms10/12}$
10	L3-L1	Float	RMS Volts	L3 to L1 – $U_{rms10/12}$
11	AN1-E	Float	RMS Volts	Analog 1 to Earth – $U_{rms10/12}$
12	AN2-E	Float	RMS Volts	Analog2 to Earth – $U_{rms10/12}$
13	AN1-AN2	Float	RMS Volts	Analog1 to Analog2 – $U_{rms10/12}$
14	Frequency	Float	Hertz	
15	L1 Current	Float	RMS Amps	$A_{rms10/12}$
16	L2 Current	Float	RMS Amps	$A_{rms10/12}$
17	L3 Current	Float	RMS Amps	$A_{rms10/12}$
18	N Current	Float	RMS Amps	Neutral current - $A_{rms10/12}$
19	Power (W)	Float	Watts	
20	Apparent Power (VA)	Float	VA	
21	Digital Input	Float	(none)	Usually 0 or 1; a fractional value indicates duty cycle
22	Peak Current (1-cycle)	Float	RMS Amps	$A_{rms10/12}$ See register 63: Peak current since [date]
23	Peak Current (1-minute)	Float	RMS Amps	1-minute RMS average See register 63: Peak current since [date]

24	Peak Current (N-minute)	Float	RMS Amps	N-minute RMS average Typically N is 10 minutes or 15 minutes. See register 110. Also, see register 63: Peak current since [date]
25	Peak Power (1-cycle)	Float	Watts	See register 64: Peak power since [date]
26	Peak Power (1-minute)	Float	Watts	See register 64: Peak power since [date]
27	Peak Power (N-minute)	Float	Watts	Typically N is 10 minutes or 15 minutes. See register 110. Also, see register 64: Peak power since [date]
28	Peak VA (1-cycle)	Float	VA	See register 65: Peak apparent power since [date]
29	Peak VA (1-minute)	Float	VA	See register 65: Peak apparent power since [date]
30	Peak VA (N-minute)	Float	VA	See register 65: Peak apparent power since [date]. Typically N is 10 minutes or 15 minutes. Also, see register 110.
31	Energy (Wh)	Float	Wh	Also, see register 66: Energy accumulated since [date]
32	Apparent Energy (VAh)	Float	VAh	Also, see register 66: Energy accumulated since [date]
33	Voltage THD	Float	%	
34	Current TDD	Float	%	Also, see register 107: base current for TDD
35	ANSI Voltage Unbalance	Float	%	If using IEC or GB methods, see registers 88 and 90
36	ANSI Current Unbalance	Float	%	If using IEC or GB methods, see registers 89 and 91
37	Flicker P(inst)	Float	P _{inst}	Instantaneous value
38	Flicker P(ST)	Float	P _{ST}	10-minute value
39	Flicker P(LT)	Float	P _{LT}	2-hour value
40	New Event Recordings	Integer	-	Number of new events recorded by PQube since last time this register was polled. This register is incremented when the files are fully available for download. This register is cleared by reading it.
41	New Trend Recordings	Integer	-	Number of new trends (daily, weekly, monthly) recorded by PQube since last time this register was polled. This register is incremented when the files are fully available for download. This register is cleared by reading it.
42	Volt-amps reactive	Float	VAR	
43	True power factor	Float	-	Value between -1.0 and +1.0
44	Temperature – Probe 1	Float	°C	
45	Humidity – Probe 1	Float	%RH	Relative humidity
46	Temperature – Probe 2	Float	°C	
47	Humidity – Probe 2	Float	%RH	Relative humidity
48	CO ₂ rate	Float	Grams per hour	Patent-pending table-based algorithm. May be negative, indicating avoided CO ₂ .
49	CO ₂ accumulated	Float	Grams	Patent-pending table-based algorithm. Also, see register 66: Energy accumulated since [date]

50	Earth current	Float	RMS Amps	$A_{rms10/12}$
51	L1-N voltage fundamental magnitude	Float	RMS Volts	For delta systems, the PQube calculates a metering Neutral for this parameter.
52	L1-N voltage fundamental angle	Float	degrees	Range: $\pm 180.0^\circ$
53	L2-N voltage fundamental magnitude	Float	RMS Volts	For delta systems, the PQube calculates a metering Neutral for this parameter.
54	L2-N voltage fundamental angle	Float	degrees	Range: $\pm 180.0^\circ$
55	L3-N voltage fundamental magnitude	Float	RMS Volts	For delta systems, the PQube calculates a metering Neutral for this parameter.
56	L3-N voltage fundamental angle	Float	degrees	Range: $\pm 180.0^\circ$
57	L1 current fundamental magnitude	Float	RMS Amps	
58	L1 current fundamental angle	Float	degrees	Range: $\pm 180.0^\circ$
59	L2 current fundamental magnitude	Float	RMS Amps	
60	L2 current fundamental angle	Float	degrees	Range: $\pm 180.0^\circ$
61	L3 current fundamental magnitude	Float	RMS Amps	
62	L3 current fundamental angle	Float	degrees	Range: $\pm 180.0^\circ$
63	Peak current – “since” date	Integer		
64	Peak power – “since” date	Integer		
65	Peak VA – “since” date	Integer		
66	Energy (Wh) – “since” date	Integer		
67	Battery installed date	Integer		
68	Analog Energy (Wh) – “since” date	Integer		
69	PQube offset from UTC	Float	Hours	Range -12.0 - +12.0 . Set by user in Setup.ini file.
70	Harmonic – L1-N volts	Float	RMS Volts	Harmonic order specified in 166
71	Harmonic – L2-N volts	Float	RMS Volts	Harmonic order specified in 166
72	Harmonic – L3-N volts	Float	RMS Volts	Harmonic order specified in 166
73	Harmonic – L1 current	Float	RMS Amps	Harmonic order specified in 166
74	Harmonic – L2 current	Float	RMS Amps	Harmonic order specified in 166
75	Harmonic – L3 current	Float	RMS Amps	Harmonic order specified in 166

76	Harmonic – L1-N voltage angle	Float	degrees	Harmonic order specified in 166
77	Harmonic – L2-N voltage angle	Float	degrees	Harmonic order specified in 166
78	Harmonic – L3-N voltage angle	Float	degrees	Harmonic order specified in 166
79	Harmonic – L1 current angle	Float	degrees	Harmonic order specified in 166
80	Harmonic – L2 current angle	Float	degrees	Harmonic order specified in 166
81	Harmonic – L3 current angle	Float	degrees	Harmonic order specified in 166
82	Harmonic order of interest	Integer		Range: 1-50, selected by user on PQube harmonic meters screens – defaults to 3 rd harmonic
83	GPS status	Integer		0 = not installed 1 = not locked 2 = locked onto satellites and operating
84	GPS latitude	Float	degrees	Range: ±90.0000° from equator
85	GPS longitude	Float	degrees	Range: ±180.0000° from prime meridian
86	GPS number of satellites	Integer		Count of acquired satellites
87				(Not used)
88	IEC or GB Unbalance – V-	Float	Percent	Fundamental negative-sequence voltage, as a percentage of fundamental positive-sequence voltage
89	IEC or GB Unbalance – A-	Float	Percent	Fundamental negative-sequence current, as a percentage of fundamental positive-sequence current
90	IEC or GB Unbalance – V0	Float	Percent	Fundamental zero-sequence voltage, as a percentage of fundamental positive-sequence voltage
91	IEC or GB Unbalance – A0	Float	Percent	Fundamental zero-sequence current, as a percentage of fundamental positive-sequence current
92	DC Power	Float	Watts	DC volts multiplied by DC amps
93	DC Energy	Float	Wh	DC energy accumulated since [date]
94	User counter counts	Long Long	(none)	Number of times the Analog or Digital Input channels were triggered since [date]

Static Information

Offset	Register	Format	Units	Comments
95	PQube Firmware – Major rev	Integer	-	Typically formatted as “1.1.2” or similar – Major.Minor.Bugfix
96	PQube Firmware – Minor rev	Integer	-	
97	PQube Firmware – Bug fix rev	Integer	-	
98	PQube Firmware build number	Integer	-	Factory use
99	Nominal L-N voltage	Float	RMS Volts	
100	Nominal L-L voltage	Float	RMS Volts	
101	Nominal frequency	Float	Hertz	
102	PT (potential transformer) ratio	Float	-	

103	CT (current transformer) ratio	Float	-	
104	PQube serial number	Float	-	PQube serial number, without leading "P" and leading zeros
105	AN1 (Analog 1-E) multiplier	Float	-	
106	AN2 (Analog 2-E) multiplier	Float	-	
107	Current basis for TDD	Float	RMS Amps	Used for calculating IEEE 519 Current TDD, and for setting the maximum current of interest.
108	Power configuration	Integer	-	0 = single-phase L1-N 1 = single-phase L1-L2 2 = split single-phase 3 = Star / Wye 4 = Delta 5 = Split-phase Delta 255 = Not yet determined
109	Ground Point	Integer		0 = centered between all 3 phases 1 = L1 2 = L2 3 = L3 4 = centered between L1 and L2 5 = centered between L2 and L3 6 = centered between L3 and L1
110	N-minutes	Integer		User-defined interval for peak current, power, and apparent power measurements. 15 minutes is the default value. In the setup file, you can define N to be 3, 5, 10, 15, 20, 30, or 60 minutes.