

INVERSINE™ Advanced Universal Sine-wave Filter



Key Features

- Low insertion loss and voltage drop (<2.5% of rated voltage)
- No damping resistors required
- Power delivered to motor >96%
- Efficiency >99%
- Improves Power Factor of the motor to near unity
- Provides reactive power compensation to motor
- Prevents transient overvoltages at motor terminals
- Reduces motor noise
- Filters out IGBT switching frequency currents
- Reliable and proven performance

Inversine Applications

- When Motor does not have adequate insulation for ASD duty
- Using a number of parallel motors
- Long Motor cable length
- When Step-up/Step-down transformer is used between ASD and motor
- Specific requirements for peak voltage level and dV/dt rise time
- Motor noise needs to be reduced
- Maximum safety and reliability is needed in hazardous environments
- Submersible pumps with long motor cables used in the oil & gas industry or irrigation systems

Problems Associated with PWM Inverter Operation

The Pulse Width Modulated (PWM) output voltage waveform of inverter equipped Adjustable Speed Drive (ASD) systems can greatly stress a standard induction motor. This is primarily due to the rapid change in voltage (high dV/dt) produced by the inverter's switching action.

High dV/dt combined with a mismatch between cable and motor surge impedance can result in reflective wave phenomenon back at the motor terminals. Voltages can increase by as much as 2 to 3 times nominal peak levels possibly exceeding the insulation rating of the feeder cables and motor magnetic wire leading to insulation stress, partial discharges and eventual failure. This problem can result with short cable runs but becomes magnified with long cable runs.

Typical problems experienced can include motor and winding failure, motor noise, cable insulation degradation, premature ASD failure, common-mode and reflected wave phenomenon and high EMI/RFI.

INVERSINE Differential Mode

The Inversine Advanced Universal Sine-wave Filter (AUSF) is designed to address the problems resulting from pulse width modulation. It is a low pass filter with cutoff frequency well below the switching frequency of the inverter.

The AUSF is much more than a simple dV/dt filter and will:

- substantially reduce voltage rise time (dV/dt)
- convert output voltage to near sinusoidal waveform (<3%)
- prevent transient overvoltages at motor terminals
- lower harmonic losses in the motor
- reduce motor noise
- reduce motor and cable insulation stress
- extend life of the motor and ASD

INVERSINE Common-mode Option

Common-mode is the phase-to-ground voltage that appears as a result of the instantaneous sum of the 3-phase voltages of the PWM inverter not being zero even when the sum of the average 3-phase voltages is zero. Common-mode voltages will induce common-mode currents to flow through parasitic capacitance in the motor and motor feeder cable. High frequency capacitive coupling exists across the motor bearings and between the feeder conductor or motor winding and ground. Common-mode currents can lead to premature motor bearing failure.

The Inversine Common-mode Filter option will:

- Reduce shaft voltage and bearing currents
- Reduce cable leakage currents
- Reduce common-mode voltages throughout power system

Voltage Distortion



Typical PWM Variable Speed Drive (VSD) Output Voltage Waveform



Output VSD Voltage Waveform with Inversine ($V_{THD} < 3\%$ Typical)

Current Distortion

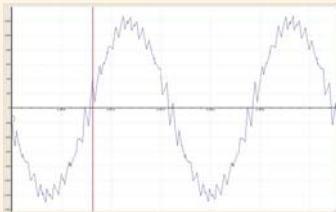

Typical VSD Output Current Waveform

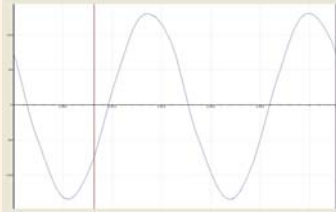

Output VSD Current Waveform with Inversine $I_{THD} < 8\%$ Typical

* Near Unity Power Factor at Inverter

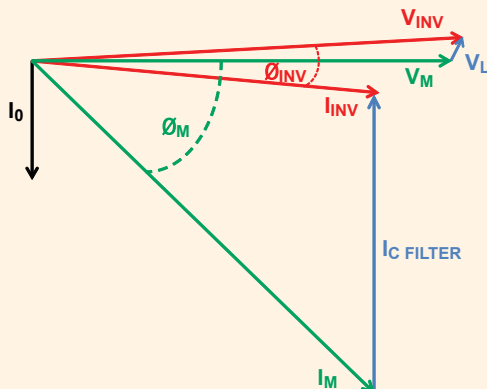

- V_{INV} = Voltage at Inverter output
- V_M = Voltage at motor
- V_L = Voltage drop across filter and cables
- I_{INV} = Current at Inverter output
- I_M = Current at motor
- I_{C_FILTER} = Capacitive current of Inversine Filter

The Inversine Advantage

Highest level of filtering performance (<3% V_{THD})

The Inversine filter converts the voltage on the output of a variable speed drive from the PWM waveform to a sinusoidal waveform with less than 3% V_{THD} . Other competitor sine-wave filters will still produce V_{THD} of 5-10% or even higher.

Voltage drop lower than with an output line reactor (<2.5%)

Voltage drop should be considered when sizing motors and drives. The inverter needs to provide an increased voltage to compensate for the voltage drop of the filter (<2.5% for Inversine filter). Other competitor sine-wave filters typically introduce a voltage drop in the range of 10%, which can reduce the power delivered to the motor to as much as 81% of nominal.

Lower kVA requirement of the inverter

(Improves the power factor to 0.97-1.00)* (see 'Near Unity Power Factor at Inverter' diagram below)

The capacitor bank design of the Inversine filter improves the motor PF as seen at the inverter output to near unity. This reduces the actual RMS current that the inverter must provide for the motor, significantly offloading the inverter.

Highest efficiency (>99%)

Inherently damped design not requiring damping resistors, and low-loss reactor design, gives the Inversine higher efficiency than other sine-wave filters.

Widest Acceptable Carrier Frequency Range (1-8kHz)

Competitor filters require minimum carrier frequencies of 2kHz or 4kHz depending on the drive size. Operating a sine-wave filter below the minimum threshold risks resonance and filter overheating.

Application Examples:

Long cable length between drive and motor

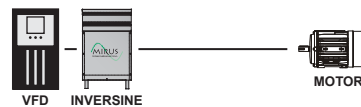

Long cable lengths combined with a high dV/dt PWM waveform cause motor terminal overvoltage spikes due to reflective wave phenomenon. This occurs due to the impedance mismatch between the cables and the characteristic motor impedance.

Without a sinewave filter, overvoltage spikes can result in more than 2x the maximum DC bus rated voltage. The Inversine filter can be used in applications with cable lengths up to 15,000ft (4,572m) depending on the motor size.

Drive feeding multiple motors in parallel

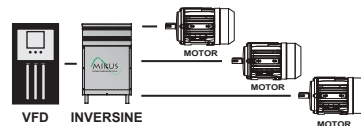

A sinewave filter is recommended to reduce the capacitive leakage currents between the cables to ground, and also the motors to ground. Sinewave filter with common mode option is recommended.

Step-up or Step-down transformer between drive and motor



To avoid installation stress and overheating of the transformer, a sine-wave filter should be installed between the drive and the transformer to feed the transformer with a sinusoidal waveform.

Motor noise needs to be reduced

Sinewave filters reduce motor noise, vibration and heat caused by drive switching frequency. This extends the life of motors by reducing bearing and insulation stress. Add common mode option if motor bearing failure is a concern.

Retrofit drive installation

Sinewave filters are recommended when installing variable speed drives on older motors not intended for use with inverter PWM output waveforms (not rated to Mg1 Part 31). Without a sinewave filter, the motor's insulation may not be adequate, even in applications with shorter cable runs. Additional common-mode option can increase motor life even further.

General Specifications:

AUSF Rating Table [60Hz]						
Motor Size		Output Amps [A] 3Ph/60Hz			Case*	Weight**
HP	kW	480V	600V	690V	Style	lbs [kg]
5	3.75	7.6	6.1	5.5	SU1	36 [16]
7.5	5.5	11	9	7.6	SU1	43 [20]
10	7.5	14	11	10	SU1	50 [23]
15	11	21	17	15	SU1	64 [29]
20	15	27	22	19	SU2	77 [35]
25	18.5	34	27	24	SU2	90 [41]
30	22	40	32	28	SU2	103 [47]
40	30	52	41	36	SU3	128 [58]
50	37.5	65	52	45	SU3	151 [68]
60	45	77	62	54	MT2	173 [78]
75	55	96	77	67	MT2	205 [93]
100	75	124	99	86	MT3	253 [115]
125	90	156	125	109	MT3	296 [134]
150	110	183	146	128	MT3	335 [152]
200	150	244	195	171	MT3	405 [184]
250	185	302	242	212	MT4	468 [212]
300	200	361	289	254	MT4	526 [239]
350	250	416	337	296	MT4	581 [264]
400	315	488	395	360	MT4	634 [288]
500	400	617	499	452	MT4	728 [330]
600	450	694	562	493	LT1	1278 [580]
700	500	805	644	575	LT1	1409 [639]
800	560	920	736	653	LT1	1523 [691]
900	630	1035	828	735	LT1	1624 [737]
1000	710	1137	920	817	LT2	1713 [777]
1100	800	1250	1012	898	LT2	1795 [814]
1200	900	1371	1110	985	LT2	1869 [848]
1300	970	1478	1182	1050	LT3	1937 [879]
1400	1000	1591	1273	1130	LT3	2000 [907]
1500	1120	1706	1365	1212	LT3	2059 [934]
1600	1200	1828	1463	1299	LT3	2114 [959]

* Case style may vary one size up or down depending on voltage model/frequency of filter
 ** Estimated values.

Voltage

Standard voltage up to 690V, 3-phase, 60 or 50Hz models

Overload Capability

Suitable for overload of 150% for 60 seconds every 60 minutes

Switching Frequency

[1kHz to 8kHz] or [8kHz to 16kHz]

Motor Frequency

0Hz to 90Hz
 *Contact factory for higher motor frequency, up to 400Hz

Voltage Distortion (THD)

3% typical (Max. 5%)
 (at full load and at rated frequency)

Input Current Distortion

<8% at full load

Efficiency

3 to 15HP: >99%
 20 to 700HP: >99.3%
 800 to 1600HP: >99.5%

Winding Material

Copper

Operating Ambient Temperature

-20°C to +40°C (-4°F to 104°F)

Elevation

≤ 1000m (3300ft) above sea level
 *for higher elevation, please contact factory for -ED model

Ventilation

Convection air cooled

Enclosure

Type: Nema-3R, ventilated
 Paint: Polyester powder coated
 Colour: ANSI 61 Grey
 Wall Mtg. Capability: 5 to 75HP

Options

Nema-3R Enhanced Outdoor Ventilated

Typical INVERSINE™ Configuration

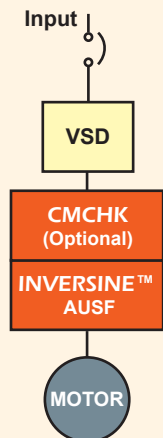

Selection / Sizing

- The AUSF filter size should be selected such that the filter rated current is equal to or greater than the nominal motor current. Alternately, the filter may be selected by motor HP/kW rating, as long as the motor amps are equal to or lower than the NEC motor ratings table.
- With regards to the voltage and frequency, choose filter ratings as per the motor rating.
- In applications where the filter feeds an isolation transformer, size the filter so the filter amps rating is equal to or greater than the transformer primary rated current.
- In applications where a single filter feeds multiple motors, size the filter so the filter amps rating is equal to or greater than the combined nominal motor currents.

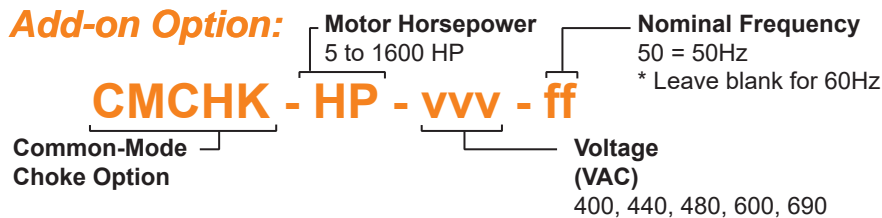
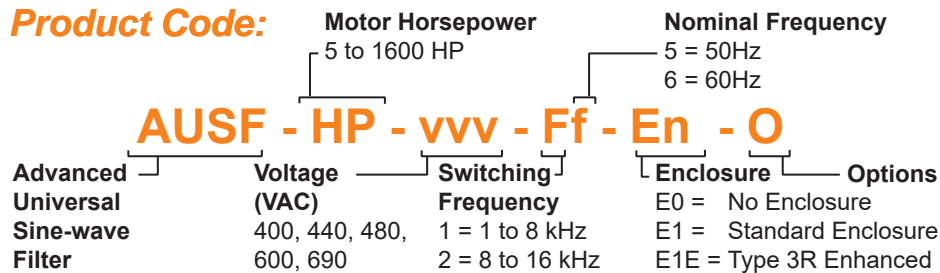

Expect better. Call us.

To discuss how MIRUS can help you meet your power quality challenges, contact us at our head office:

MIRUS International Inc.
31 Sun Pac Blvd.
Brampton, Ontario
Canada L6S 5P6

Tel: (905) 494-1120
Fax: (905) 494-1140
Toll-Free: 1-888-TO MIRUS (888-866-4787)

www.mirusinternational.com

MIRUS Electromagnetic Equipment (Suzhou) Co., Ltd
No.5 Building, EPZ Sub-Industry Park, SND, No.666 Jianlin Road
Suzhou, Jiangsu
China, 215011

Tel: : (86) 0512-62696858
Fax : (86) 0512-62696266
www.cn.mirusinternational.com



Harmonic and Energy Solutions

Real-world performance for real-world loads.

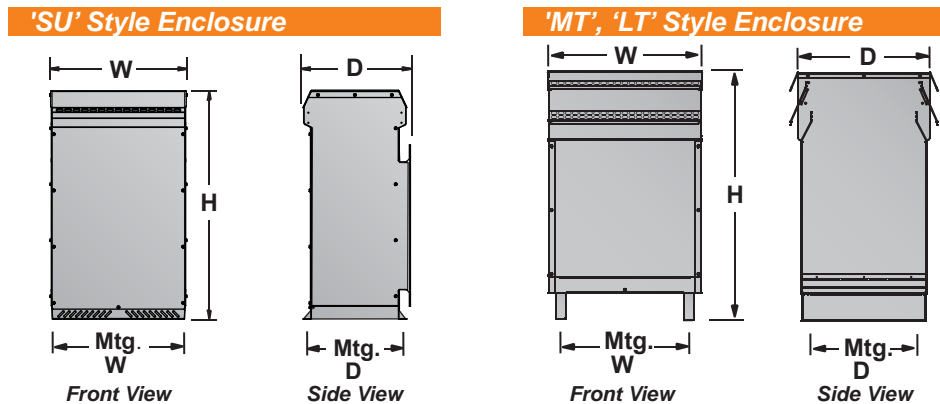

Dimensions

Case Style	H (Height) inches [mm]	W (Width) inches [mm]	D (Depth) inches [mm]	Mtg. Center W inches [mm]	Mtg. Center D inches [mm]
SU1	23.50 [597]	11.25 [286]	11.25 [286]	9.00 [229]	9.50 [241]
SU2	30.00 [762]	13.25 [336]	12.75 [324]	11.00 [279]	11.25 [286]
SU3	34.00 [864]	20.25 [514]	16.00 [406]	18.00 [457]	14.25 [362]
MT2	38.00 [965]	21.50 [546]	19.50 [495]	17.00 [432]	17.50 [445]
MT3	45.00 [1143]	26.00 [661]	21.00 [534]	21.50 [546]	19.00 [483]
MT4	51.50 [1308]	32.00 [813]	25.50 [648]	23.50 [597]	23.50 [597]
LT1	59.00 [1499]	39.50 [1003]	30.00 [762]	24.00 [610]	32.00 [813]
LT2	66.00 [1677]	44.00 [1118]	34.00 [864]	26.00 [660]	36.00 [915]
LT3	75.00 [1905]	48.50 [1232]	39.00 [991]	27.50 [699]	41.00 [1041]