



Broggi 1818

Buffet 2020



Sommario

New	4
Nature	10
Jambee	32
Aqva	36
Gennaro	42
Zeta	44
Ginco	58
Manhattan	60
Iseo	74
Classica	86
Italo	94



Alzata torta in noce bassa

Cake stand, walnut
Présentoir à gâteaux en bois de noyer
Presentación tarta en madera de nogal
Tortenplatte Walnussholz

Noce - Walnut

	ø Cm	ø In	h. Cm	h. In
305 54 42 673 (small)	28	11	14	5,5
305 54 42 674 (medium)	33	12,9	14	5,5
305 54 42 675 (large)	37	14,5	14	5,5



Alzata torta in noce alta

Cake stand, walnut
Présentoir à gâteaux en bois de noyer
Presentación tarta en madera de nogal
Tortenplatte Walnussholz

Noce - Walnut

	ø Cm	ø In	h. Cm	h. In
305 54 42 676 (small)	28	11	21	8,2
305 54 42 677 (medium)	33	12,9	21	8,2
305 54 42 678 (large)	37	14,5	21	8,2



**Coperchio a bascula
 adatto per alzate ø37cm
 suitable for stands ø37cm**

Transparent round rolltop cover
Cloche basculante ronde transparente
Rolltophaube - rund
Campana redonda transparente

SAN

	ø Cm	ø In
V76 12 15 T01	34	13,3/8



**Cupola in vetro
 adatto per alzate ø28cm
 suitable for stands ø28cm**

Dome cover, glass
Cloche en verre
Campana de vidrio
Cloche aus Glas

Vetro - Glass

	ø Cm	ø In
404 10 42 610	25	9,8



**Cupola in policarbonato
 adatto per alzate ø28cm
 suitable for stands ø28cm**

Dome cover, acrylic
Cloche en acrylique
Campana de acrilico
Cloche aus Polycarbonat

Polycarbonato - Polycarbonat

	ø Cm	ø In
305 12 53 625	26	10,2



Alzata pasticceria

Petit fours stand
 Plat à petits fours sur pied
 Petit Four Stand
 Soporte pasteles

Noce - Walnut

	h. Cm	h. In
305 54 42 670 (3 posti)	43x41,5	12
305 54 42 671 (2 posti)	23,5x24,4	12



Piattino rettangolare

Rectangular plate - Plato rectangular
 Plat rectangulaire - Rechteckige Teeller

Porcellana - Porcelain

	Cm	In
264 00 42 669	18x11	7x4,3



Piattino quadrato porcellana

Square saucer - Platillo cuadrado
 Soucoupe carrée - Quadratische teller

Porcellana - Porcelain

	Cm	In
322 21 22 691	10x10	3,9x3,9



Ciotolina a goccia

Bowl - Bol
 Bol - Schüssel

Porcellana - Porcelain

	Cm	In
V87 21 42 001	8x7x4	3,1x1,5



Coppetta rotonda

Round bowl - Bol redonda
 Bol rond - Runde Schüssel

Porcellana - Porcelain

	ø Cm	ø In
V87 21 42 005 7	7	2,7



Tagliere pane in noce

Cutting board with dustbuster box, walnut wood
 Planche à découper avec ramasse poussière
 Brotschneidebrett Walnussholz mit Staubsauger
 Tabla de cortar con recipiente aspirador

Noce - Walnut

	h. Cm	h. In
305 54 54 617	52.5x35	20,6x13,7



Distributore Aqva con base in marmo di Carrara

Aqva dispenser with Carrara marble stand
 Distributeur Aqva avec support en Carrara marbre
 Dispensador Aqva con soporte en Carrara mármol
 Getränkespender Aqva mit Ständer aus Carrara Marmor

Marmo di Carrara e vetro - Carrara Marble and glass

	h. Cm	h. In
305 54 52 729	63	24.8

Distributore Aqva con base in noce

Aqva dispenser with walnut wood stand
 Distributeur Aqva avec support en bois de noyer
 Dispensador Aqva con soporte en madera de nogal
 Getränkespender Aqva mit Ständer aus Walnussholz

Noce e vetro - Walnut and glass

	h. Cm	h. In
305 54 52 728	63	24.8





BAKERY



Piano in noce massello

Solid walnut wood top
 Dessus en bois massif noyer
 Tabla de madera maciza de nogal
 Top Walnuss massiv

	Cm	In
305 54 42 629	30x30	11,3/4x11,3/4
305 54 42 630	70x30	27,1/2x11,3/4
305 54 42 631	100x30	39,3/8x11,3/4



Vassoio per alzate rettangolare

Tray for podia, rectangular
 Plateau pour supports rectangulaire
 Bandeja rectangular para soportes
 Tablett Walnuss, rechtekig

	Cm	H	In	H
305 54 23 854	35x52,5	4,5	13,3/4x20,5/8	1,3/4



Vassoio per alzate rettangolare

Tray for podia, rectangular
 Plateau pour supports rectangulaire
 Bandeja rectangular para soportes
 Tablett Walnuss, rechtekig

	Cm	H	In	H
305 54 23 855	35x52,5	8	13,3/4x20,5/8	3,1/8



Piano in ardesia

Slate top
 Dessus en ardoise
 Tabla de pizarra
 Top Schiefer

	Cm	In
V87 09 42 Q01	30x30	11,3/4x11,3/4
V87 09 42 R01	70x30	27,1/2x11,3/4
V87 09 42 R02	100x30	39,3/8x11,3/4



Vassoio per alzate rettangolare

Tray for podia, rectangular
 Plateau pour supports rectangulaire
 Bandeja rectangular para soportes
 Tablett Walnuss, rechtekig

	Cm	H	In	H
305 54 23 853	17,5x52,5	4,5	6,7/8x20,5/8	1,3/4



Piano in pietra lavica

Lava top
 Dessus en pierre de lave
 Tabla de piedra lávica
 Top Lavastein

	Cm	In
305 60 42 633	30x30	11,3/4x11,3/4
305 60 42 634	70x30	27,1/2x11,3/4
305 60 42 635	100x30	39,3/8x11,3/4



Base inclinata per vassoio

Inclined base for rectangular trays
 Base inclinée pour plateaux rectangulair
 Base inclinada para bandejas
 Basistablett mit Kante rechteckig

	Cm	H	In	H
305 54 23 856	35x52,5	6,7	13,3/4x20,5/8	2,1/2



Alzata quadrata nera opaca

Square podium
Support carré
Soporte cuadrado
Podest quadratisch

NERA OPACA - matte black

	Cm	H	In	H
305 44 42 621	18x18	20	7x7	7,7/8
305 44 42 622	18x18	25	7x7	9,7/8
305 44 42 623	18x18	30	7x7	11,3/4

CROMATA - cromed

	Cm	H	In	H
305 05 42 621	18x18	20	7x7	7,7/8
305 05 42 622	18x18	25	7x7	9,7/8
305 05 42 623	18x18	30	7x7	11,3/4



Alzata rettangolare

Rectangular podium
Support rectangulaire
Soporte rectangular
Podest rechteckig

NERA OPACA - matte black

	Cm	H	In	H
305 44 42 625	17,5x52,5	13,5	6,7/8x20,5/8	5,3/4
305 44 42 626	17,5x52,5	20	6,7/8x20,5/8	7,7/8

CROMATA - cromed

	Cm	H	In	H
305 05 42 625	17,5x52,5	13,5	6,7/8x20,5/8	5,3/4
305 05 42 626	17,5x52,5	20	6,7/8x20,5/8	7,7/8

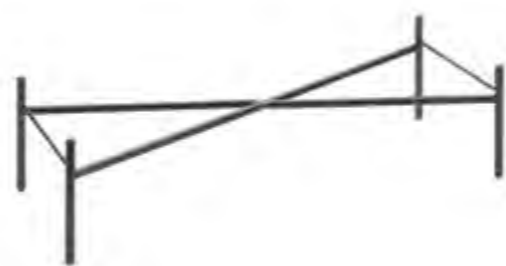

Alzata rettangolare

Rectangular podium
Support rectangulaire
Soporte rectangular
Podest rechteckig

NERA OPACA - matte black

	Cm	H	In	H
305 44 42 627	35x52,5	13,5	13,3/4x20,5/8	5,3/4
305 44 42 628	35x52,5	20	13,3/4x20,5/8	7,7/8

CROMATA - cromed

	Cm	H	In	H
305 05 42 627	35x52,5	13,5	13,3/4x20,5/8	5,3/4
305 05 42 628	35x52,5	20	13,3/4x20,5/8	7,7/8

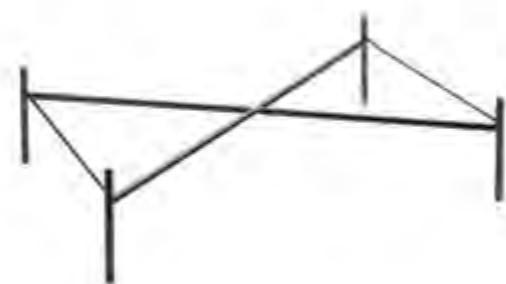

Alzata rettangolare per porcellane

Rectangular podium for porcelain items
Support rectangulaire pour articles en porcelaine
Soporte rectangular para artículos de porcelana
Podest rechteckig für Artikel aus Porzellan

NERA OPACA - matte black

	Cm	H	In	H
305 44 42 624	12x40	13,5	4,3/4x15,3/4	5,3/4
305 44 42 632	12x40	20	4,3/4x15,3/4	7,7/8

CROMATA - cromed

	Cm	H	In	H
305 05 42 624	12x40	13,5	4,3/4x15,3/4	5,3/4
305 05 42 632	12x40	20	4,3/4x15,3/4	7,7/8

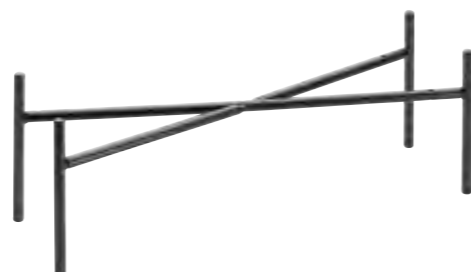

Cestino pane per alzata quadrata

Bread basket for square podium
Corbeille à pain pour support carré
Cesta para pan para soporte cuadrado
Brotkorb für Podium quadratisch

Misto lino - Linen blend

	Cm	H	In	H
305 29 24 588	18x18	20	7x7	7,7/8



Alzata quadrata nera opaca

Matte black square podium
Support carré noir
Soporte cuadrado negro mate
Podest quadratisch Schwarz

	Cm	H	In	H
305 44 42 621	18x18	20	7x7	7,7/8
305 44 42 622	18x18	25	7x7	9,7/8
305 44 42 623	18x18	30	7x7	11,3/4



Cestino pane per alzata rettangolare

Bread basket for rectangular podium
Corbeille à pain pour support rectangulaire
Cesta para pan para soporte rectangular
Brotkorb für Podium rechteckig cm

Misto lino - Linen blend

	Cm	H	In	H
305 29 24 589	17,5x52,5	13,5	6,7/8x20,5/8	5,3/4
305 29 24 590	17,5x52,5	20	6,7/8x20,5/8	7,7/8



Alzata rettangolare nera opaca

Matte black rectangular podium
Support rectangulaire noir
Soporte rectangular negro mate
Podest rechteckig Schwarz

	Cm	H	In	H
305 44 42 625	17,5x52,5	13,5	6,7/8x20,5/8	5,3/4
305 44 42 626	17,5x52,5	20	6,7/8x20,5/8	7,7/8

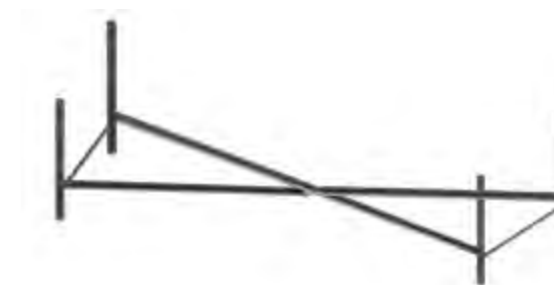



Base in legno con 3 fori

Wood base with 3 holes
 Base en bois avec 3 trous
 Base de madera con 3 agujeros
 Holzbasis mit 3 runden Ausschnitten

Noce - Walnut

	Cm	H	In	H
305 54 54 609	17,5x52,5	2,5	6,7/8x20,5/8	1



Vaso in vetro con coperchio

Glass jar with lid
 Pot en verre avec couvercle
 Jarrón de vidrio con tapa
 Glasdose mit Deckel

Vetro - Glass

	ø Cm	H	In	H
404 10 31 304	14	19	5,1/2	7,1/2



Base legno per 3 ciotole in porcellana

Wood base fitting 3 porcelain bowls
 Base en bois pour 3 bols en porcelaine
 Base de madera para 3 boles de porcelana
 Holzbasis für 3 Porzellan Bols

Noce - Walnut

	Cm	H	In	H
305 54 54 608	17,5x52,5	2,5	6,7/8x20,5/8	1



Coppetta affinity

Affinity bowl
 Bol Affinity
 Bol Affinity
 Affinity Bol

Porcellana - Porcelain

	ø Cm	ø In
264 00 43 800	15	6



Ciotola Artesano

Artesano bowl
 Bol Artesano
 Bol Artesano
 Artesano bol

Porcellana - Porcelain

	Lt	Oz
264 02 51 900	0,6	21



Coperchio per coppetta in vetro

Lid for glass bowl
 Couvercle pour bol en verre
 Tapa para bol de vidrio
 Deckel für Glasschale

Inox 18/10 - St. Steel

	ø Cm	ø In
B01 12 52 640	15	6



Ciotola Urban

Urban bowl
 Bol Urban
 Bol Urban
 Urban bol

Porcellana - Porcelain

	Lt	Oz
263 45 21 900	0,6	21



Coppetta in vetro

Glass bowl
 Bol en verre
 Bol de vidrio
 Glasschale

Vetro - Glass

	ø Cm	ø In
V76 08 52 004	15	6





FRESH BREAK

Piatto ovale Artesano

Artesano oval bowl
Coupe ovale Artesano
Plato oval Artesano
Artesano Schale oval

Porcellana - Porcelain

	Cm	In
264 02 53 844	55x17	21,5/8x6,3/4



Piatto servire BBQ

BBQ platter
Plat à servir BBQ
Fuente para servir BBQ
BBQ Platte

Porcellana - Porcelain

	Cm	In
264 18 92 906	55x22	21,5/8x6,3/4



Insalatiera Artesano

Artesano salad bowl
Saladier Artesano
Ensaladera Artesano
Artesano Schüssel rund

Porcellana - Porcelain

	ø Cm	ø In
264 02 53 170	28	11



Piatto presentazione Artesano

Artesano presentation bowl
Coupe présentation Artesano
Plato presentación Artesano
Artesano Präsentationsschale rund

Porcellana - Porcelain

	ø Cm	ø In
264 02 53 760	37	14,1/2



Alzata rettangolare per porcellane

Rectangular podium for porcelain items
Support rectangulaire pour articles en porcelaine
Soporte rectangular para artículos de porcelana
Podest rechteckig für Artikel aus Porzellan

Nero opaco - Matte black

	Cm	H	In	H
305 44 42 624	12x40	13,5	4,3/4x15,3/4	5,3/4
305 44 42 632	12x40	20	4,3/4x15,3/4	7,7/8

Cromato - Chromed

	Cm	H	In	H
305 05 42 624	12x40	13,5	4,3/4x15,3/4	5,3/4
305 05 42 632	12x40	20	4,3/4x15,3/4	7,7/8



Alzata quadrata

Square podium
Support carré
Soporte cuadrado
Podest quadratisch

Nero opaco - Matte black

	Cm	H	In	H
305 44 42 621	18x18	20	7x7	7,7/8
305 44 42 622	18x18	25	7x7	9,7/8
305 44 42 623	18x18	30	7x7	11,3/4

Cromato - Chromed

	Cm	H	In	H
305 05 42 621	18x18	20	7x7	7,7/8
305 05 42 622	18x18	25	7x7	9,7/8
305 05 42 623	18x18	30	7x7	11,3/4





BEVERAGE



Secchio champagne

Champagne bucket
Seau à champagne
Cubo champàn
Champagnerkühler

Tiglio - Lime wood

	ø Cm	ø In
305 54 43 628	20	7,7/8



Coppa punch

Punch bucket
Bol à punch
Champañera
Punch Bol mit Einsatz

Tiglio - Lime wood

	ø Cm	ø In
305 54 43 629	40	15,3/4



Distributore Aqva con alzata Nature

Aqva dispenser with Nature stand
Distributeur Aqva avec support Nature
Dispensador Aqva con soporte Nature
Aqua Getränkespender mit Ständer Nature

	Cm	H cm	In	H in
305 44 52 711 nero/black	26x26	38	10,1/4x10,1/4	31,1/2
305 05 52 711 cromato/chromed	26x26	38	10,1/4x10,1/4	31,1/2



Tagliere con cinghia acciaio

Cutting board with st. steel belt
Planche à découper
Tabla de cortar con cinturón de acero
Schneidbrett mit Edelstahlband

Noce - Walnut

	ø Cm	ø In
305 04 71 980	40	15,3/4





Set piastra con alzata

Hot buffet set with podium
Buffet chaud avec support
Set plancha con soporte
Hot Buffet Set mit Podest

Nero opaco - Matte black

	Cm	H	In	H
305 44 54 614	17,5x52,5	13,5	6,7/8x20,5/8	5,3/4

Cromato - Chromed

	Cm	H	In	H
305 05 54 614	17,5x52,5	13,5	6,7/8x20,5/8	5,3/4

Piastra teflonata

Non-stick baking tray
Plateau antiadhésif
Plancha teflonada
Anti-haft Aufsatz

Alluminio - Aluminum

	Cm	In
305 05 72 764	16x52,5	6,1/4x20,5/8

Cornice per piastra teflonata

Frame for non-stick baking tray
Cadre pour plateau antiadhésif
Marco para plancha teflonada
Rahmen für Anti-haft Aufsatz

Noce - Walnut

	Cm	In
305 54 54 610	17,5x52,5	6,7/8x20,5/8

Supporto per portalumini

Stand for candle holders
Support pour portes-bougies
Soporte para portavelas
Gestell für Teelichthalter

Acciaio inox 18/10 - St. Steel

305 05 20 671

Portalumini

Candle holder
Porte-bougies
Portavelas
Teelichthalter

Acciaio inox 18/10 - St. Steel

305 05 52 614

Alzata rettangolare

Rectangular podium
Support rectangulaire
Soporte rectangular
Podest rechteckig

Nero opaco - Matte black

	Cm	H	In	H
305 44 42 625	17,5x52,5	13,5	6,7/8x20,5/8	5,3/4

Cromato - Chromed

	Cm	H	In	H
305 05 42 625	17,5x52,5	13,5	6,7/8x20,5/8	5,3/4



Cavalletto portaetichetta per buffet

Buffet easel for tags
Chevalet porte-nom pour buffet
Soporte caballete para etiqueta para buffet
Aufsteller Produktinfo

Acciaio inox 18/10 - St. Steel

	Cm	H	In	H
V01 05 19 001	7x7	15	2,3/4x2,3/4	6

Tavoletta nera per cavalletto

Black tag for easel
Plaque noire pour chevalet
Etiqueta negra para soporte caballete
Schild für Produktinfo

Plexiglass

	Cm	In
V01 12 19 001	10x7,5	4x3



Distributore succhi Zeta

Thermal juice dispenser
 Distributeur de jus réfrigéré
 Dispensador de zumo refrigerado
 Thermo-Saftspender

Noce - Walnut

	Lt	Oz	Cm	H	In	H
305 54 52 644	3,5	122,5	23x32	48	9x12,5/8	19
305 54 52 633	7	245	28x35,5	53	11x14	20,7/8

**Rinfrescaraffe 4 comparti Zeta**

Thermal pitcher, 4-pc set
 Rafrâchisseur à 4 carafes
 Enfriador para 4 jarras
 Thermo-Karaffehalter 4 Stck.

Noce - Walnut

	Cm	H	In	H
305 54 24 586	28x28	9	11x11	3,1/2

**Distributore caffè Zeta**

Coffee urn
 Distributeur de café
 Dispensador de café
 Kaffeespender

Noce - Walnut

	Lt	Oz	Cm	H	In	H
305 54 52 631	7	245	28x35,5	54	11x14	21,1/4
305 54 52 632	10	350	28x35,5	62	11x14	24,3/8

**Caraffa vetro con coperchio basculante**

Water glass pitcher with smart lid
 Carafe en verre avec couvercle basculant
 Jarra de vidrio con tapa basculante
 Wasser Karaffe mit Kippen Kappe

	Lt	Oz
305 05 08 548	1	35

**Rinfrescaraffe 2 comparti Zeta**

Double thermal pitcher
 Rafrâchisseur à 2 carafes
 Enfriador para 2 jarras
 Thermo-Karaffenthaler 2 Stck.

Noce - Walnut

	Cm	In
305 54 52 634	21,5x38,5	8,1/2x15,1/8

**Distributore cereali Zeta**

Cereal dispenser
 Distributeur céréales
 Dispensador cereales
 Cerealienspender 1-fach

Noce - Walnut

	Lt	Oz	Cm	H	In	H
305 54 52 636	4	122,5	23x32	56	9x12,5	22

**Caraffa succhi con coperchio**

Juice pitcher with lid
 Carafe à jus avec couvercle
 Jarra zumo con tapa
 Saftkrug mit Deckel

	Lt	Oz
305 05 08 539	1,5	53



Vassoio formaggi refrigerato Zeta

Thermal cheese/cold cuts tray
 Plateau à fromage/charcuterie réfrigéré
 Bandeja quesos/embutidos refrigerada
 Thermo-Aufschnittplatte

Noce - Walnut

	Cm	H	In	H
305 54 54 577	55x34,5	21,5	21,5/8x13,5/8	8,1/2

**Vassoio refrigerato Zeta**

Thermal tray, ice packs on demand
 Plateau réfrigéré, blocs réfrigérants sur demande
 Bandeja refrigerada, acumuladores de frío disponibles
 Thermo-Platte, Kühlelemente auf Anfrage

Noce - Walnut

	Cm	H	In	H
305 54 52 699	55x34,5	4,5	21,5/8x13,5/8	1,3/4

**Vassoio yogurt Zeta refrigerato con ghiaccio**

Zeta ice thermal yogurt tray
 Plateau à yaourts réfrigéré à glace Zeta
 Bandeja yogures refrigerable con hielo Zeta
 Joghurtablett Zeta, mit Eis kühlbar

Noce - Walnut

	Cm	H	In	H
305 54 52 638	55x34,5	4,5	21,5/8x13,5/8	1,3/4

**Coppa macedonia Zeta**

Thermal fruit salad bowl
 Rafrâchisseur salade de fruits
 Bol macedonia de frutas refrigerado
 Thermo-Fruchtsalatschale

Noce - Walnut

	Cm	In
305 54 52 641	28x28	11x11

**Set 2 coppe yogurt Zeta**

Thermal yogurt set, 2-bowl
 Set 2 bols yaourt réfrigérés
 Set 2 boles yogur refrigerados
 Thermo-Schalen 2 Stck.

Noce - Walnut

	Cm	In
305 54 52 640	21,5x38,5	8,1/2x15,1/8

**Jambee distributore marmellata/miele con base in legno**

Jambee jam/honey dispenser with wood base
 Distributeur confiture/miel Jambee avec base en bois
 Jambee distribuidor de mermelada/miel con base de madera
 Jambee Konfitür/honigspender mit Holzbasis

Noce - Walnut

	Lt	Oz	Cm	In
305 05 52 701	0,7	24	12,5x34,5	5x13,5/8
			H Min 41,5	H Min 16,3/8
			H Max 52,5	H Max 20,5/8
305 05 52 722	1	35	12,5x34,5	5x13,5/8
			H Min 48	H Min 18,3/4
			H Max 71,5	H Max 28,1/8





Un oggetto **elegante e contemporaneo**, adatto a ogni tipo di buffet: grazie al design unico e innovativo. I materiali usati sono di **alto livello qualitativo** - acciaio Inox 18/10 e metacrilato - e rendono il distributore un oggetto pregiato.

MADE IN ITALY

La **tecnologia semplice**, ma al tempo stesso funzionale, permette di erogare dosi da 8gr (0.28 oz) di prodotto, riducendo gli sprechi ed eliminando le monoporzioni da 25gr (0.88 oz).

Questo consente un risparmio di prodotto e la riduzione dei rifiuti nel

rispetto dell'ambiente. Inoltre è ideale per servire miele e marmellate di produzione artigianale, per fornire un prodotto di alto livello e che soddisfi anche i clienti più esigenti.

Un ottimo modo per arricchire l'esperienza della colazione, mantenendo **ordinato e pulito** il buffet.

Utilizzabile con prodotti erogabili semisolidi, come confetture, marmellate - pure con piccoli frammenti di frutta - e creme, ma anche con miele, sciroppi e salse di analoga consistenza.

Jambee è l'ideale per **ogni struttura ricettiva**: alberghi, pasticcerie, bar e ristoranti.

An **elegant and modern** object for all buffets, thanks to its unique and innovative design.

The materials used are **high quality** - 18/10 stainless steel and methacrylate - which makes the dispenser a fine object.

MADE IN ITALY

Its **simple technology**, though functional, allows to dispense 8 gr (0.28 oz) product doses, to reduce waste and get rid of 25 gr (0.88 oz) single dose jars.

That allows, as well, to save on product and reduce waste, respecting

the environment. Moreover, it is the ideal to dispense honey and homemade jams, in order to supply for a high-end product, capable of meeting even the most demanding customers' needs.

The best way to make the most of the breakfast experience, keeping the buffet **tidy and clean**.

It can be used with dispensable semisolid products like preserves, marmalades - even with small fruit pieces in them - , creams and honey, syrups and sauces as well, which have the same consistency.

Jambee is the ideal for **any accommodation facility**: hotels, pastry shops, bars and restaurants.

Pistone con coperchio

Piston with lid
Piston avec couvercle
Kolben mit Deckel
Pistón con tapa

Inox 18/10, Metacrilato e PP - St. Steel, Methacrylate and PP

	Lt
Z77 9852 DMA	0,7
Z77 9852 DMA1	1

Contentitore

Container
Conteneur
Behälter
Contenedor

Metacrilato - Methacrylate

	Lt
Z77 2052 DMA	0,7
Z77 2052 DMA1	1

Tappo

Cap
Capsule
Stöpsel
Tapón

Metacrilato - Methacrylate

Z77 1352 DMA

Contentitore completo

Complete container
Conteneur complet
Komplett Behälter
Contenedor completo

Metacrilato - Methacrylate

	Lt
Z77 9952 DMA	0,7
Z77 9952 DMA1	1

Targhetta porta etichetta

Label plate
Plaque porte-étiquette
Schild Etikettenhalter
Placa porta etiqueta

Metacrilato - Methacrylate

Z77 5752 DMA

Targhetta porta etichetta

Label plate
Plaque porte-étiquette
Schild Etikettenhalter
Placa porta etiqueta

Metacrilato - Methacrylate

Z77 5752 DMA1



Jambee

Jambee
Jambee
Jambee
Jambee

Acciaio Inox 18/10 - St. Steel

	Lt	Oz	Cm	In
V77 0552 DMB	0,7	24	12,5x34,5 H Min 44,5 H Max 58	5x13,5/8 H Min 17,1/2 H Max 22,7/8
V77 0552 DMC	1	35	12,5x34,5 H Min 48 H Max 71,5	5x13,5/8 H Min 18,3/4 H Max 28,1/8



Erogatore a siringa

Syringe nozzle
Embout seringue
Ausgieberspritze
Boquilla jeringa

Inox 18/10 - St. Steel

Z77 4652 DMA



Erogatore standard

Standard nozzle
Embout standard
Standard AusgieBer
Boquilla estandar

Inox 18/10 - St. Steel

Z77 4552 DMA





SPA



Distributore bevande riscaldato

Heated beverage dispenser
Distributeur de boissons chauffé
Dispensador de bebidas calentado
Getränkespender, aufgewärmt

	Lt	Oz	H. Cm.	H. In.
305 05 52 708	5	169	80	31,1/2

Samovar riscaldato

Heated Samovar
Samovar chauffé
Samovar calentado
Samovar aufgewärmt

	Lt	Oz
305 05 52 707	5 + 1	169 + 35

Teiera in vetro / Glass teapot
 305 08 02 580 1 35

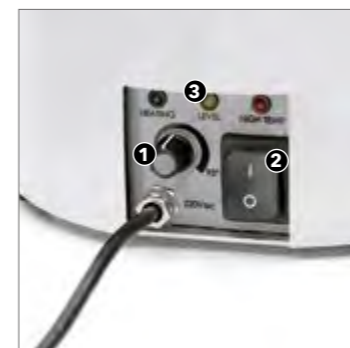

1 Regolatore di temperatura (dai 45°C ai 95°C)
Temperature regulator (from 45°C to 95°C)

2 Tasto ON - OFF
ON-OFF button

- 3** Spie luminose/Spie luminose:
- temperatura resistenza >80°C
temperature of the resistance is > di 80°
 - il livello del liquido è sotto al minimo
level of liquid is below minimum
 - lampeggiante - il liquido è in fase di riscaldamento
flashing: the liquid heating up
 - fisso - il liquido ha raggiunto la temperatura desiderata
fixed: it has reached the temperature set on the control knob

Distributore bevande caldo/freddo

Hot and cold beverage dispenser
 Distributeur de boissons chaud/froid
 Dispensador de bebidas caliente/frío
 Getränkespender warm/kalt

	Lt	Oz	H. Cm.	H. In.
305 05 52 709	5	169	80	31,1/2

Il nostro **AQVA** è innovativo, per il suo design elegante ed originale e perché permette, grazie alla doppia parete, di avere una lentissima dispersione della temperatura del liquido interno.

Our **AQVA** is innovative for having an elegant and original design and because it allows, thanks to the double wall, to have an extremely low temperature dispersion of the inside liquid.



Distributore Aqva con alzata Classica

Aqva dispenser with Classica stand
 Distributeur Aqva avec support Classica
 Dispensador Aqva con soporte Classica
 Aqua Getränkespender mit Ständer Classica

	ø Cm	H cm	ø In	H in
305 55 52 712	27	80	10,5/8	31,1/2

cromato/chromed

305 07 52 712	27	80	10,5/8	31,1/2
---------------	----	----	--------	--------

acciaio argentato/electro-plated stainless steel (EPSS)



Distributore Aqva con alzata Nature

Aqva dispenser with Nature stand
 Distributeur Aqva avec support Nature
 Dispensador Aqva con soporte Nature
 Aqua Getränkespender mit Ständer Nature

	Cm	H cm	In	H in
305 44 52 711	26x26	38	10,1/4x10,1/4	31,1/2

nero/black

305 05 52 711	26x26	38	10,1/4x10,1/4	31,1/2
---------------	-------	----	---------------	--------

cromato/chromed



Distributore Aqva con base in marmo di Carrara

Aqva dispenser with Carrara marble stand
 Distributeur Aqva avec support en Carrara marbre
 Dispensador Aqva con soporte en Carrara mármol
 Getränkespender Aqva mit Ständer aus Carrara Marmor

Marmo di Carrara e vetro - Carrara Marble and glass

	h. Cm	h. In
305 54 52 729	63	24.8



FREDDO

Mantenimento della temperatura delle bevande per 5/6 ore senza bisogno di fonti refrigeranti. Test effettuati ad una temperatura ambiente di 20°C (68°F)

COLD

Maintenance of drinks temperature for 5/6 hours without cooling element. Test carried out at 20°C (68°F) room temperature.

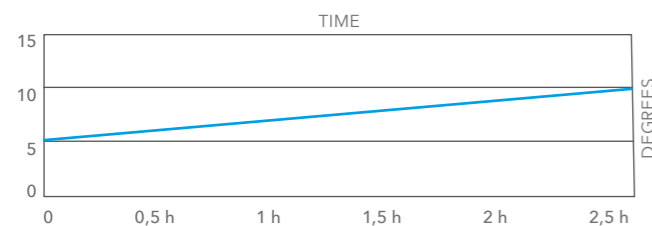

CALDO

Mantenimento della temperatura della bevanda per 4/5 ore senza bisogno di fonti di calore

HOT

Maintenance of drinks temperature for 4/5 hours without heating element.

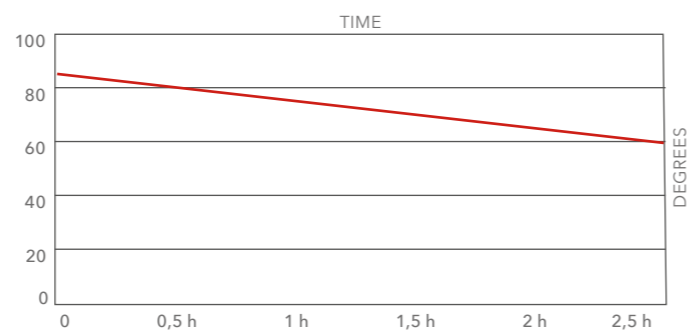

Distributore Aqva con base in noce

Aqva dispenser with walnut wood stand
 Distributeur Aqva avec support en bois de noyer
 Dispensador Aqva con soporte en madera de nogal
 Getränkespender Aqva mit Ständer aus Walnussholz

Noce e vetro - Walnut and glass

	h. Cm	h. In
305 54 52 728	63	24.8



Espositore piccola pasticceria

Petits fours display
 Présentoir à petits fours
 Soporte para pasteles
 Ständer für kleine Gebäcke

	ø mm	H mm	ø In	H In	Fori/holes
607 N0 71 933	490	423	19,1/4	16,1/2	60
607 P0 68 115	340	300	13,3/8	11,3/4	32
607 P0 68 117	165	145	6,1/2	6,1/2	9





BREAKFAST

Distributore caffè

Coffee urn
 Distributeur de café
 Dispensador de café
 Kaffeenspender

	Lt	Cm	H Cm
305 05 52 631 ■	7	25 x 35	54
305 45 52 631 □			
305 05 52 632 ■	10	25 x 35	62
305 45 52 632 □			



Distributore cereali

Cereal dispenser
 Distributeur céréales
 Dispensador cereales
 Cerealienspender 1-fach

	Kg	Cm	H Cm
305 05 52 636 ■	1,5	15 x 24	58
305 45 52 636 □			



Distributore succhi refrigerato

Thermal juice dispenser
 Distributeur de jus réfrigéré
 Dispensador de zumo refrigerado
 Thermo-Saftspender

	Lt	Cm	H Cm
305 05 52 633 ■	7	25 x 35	53
305 45 52 633 □			
305 05 52 644 ■	3,5	18 x 30	48
305 45 52 644 □			



Distributore cereali 2 compart

Double cereal dispenser
 Distributeur céréales double
 Dispensador cereales doble
 Cerealienspender 2-Fach

	Kg	Cm	H Cm
305 05 52 635 ■	2 x 1,5	25 x 32	58
305 45 52 635 □			





Rinfrescacaraffe 2 comparti

Double thermal pitcher
 Rafrâchisseur à 2 carafes
 Enfriador para 2 jarras
 Thermo-Karaffenhalter 2 Stck.

	Cm	H. Cm	Lt
305 05 52 634 ■	42 x 24	22	1,5
305 45 52 634 □			



Rinfrescabottiglie termico 3 posti

3-bottle cooler
 Rafrâchisseur à 3 bouteilles
 Enfriador para 3 botellas
 Flaschenkühler 3-Fach

	Cm	H. Cm
305 05 52 646 ■	42 x 24	23,5
305 45 52 646 □		



Rinfrescacaraffe 4 comparti acciaio inox

Thermal pitcher 4-pc set
 Rafrâchisseur à 4 carafes
 Enfriador para 4 jarras
 Thermo-Karaffehalter 4 Stck.

	H. Cm	H. In
305 05 24 586 ■	63	24,8
305 45 24 586 □		

* caraffe incluse / included pitcher



Set 2 coppe yogurt refrigerate

Thermal yogurt set, 2-bowl
 Set 2 bols yaourt réfrigérés
 Set 2 boles yogur refrigerados
 Thermo-Schalen 2 Stck.

305 05 52 640 ■
 305 45 52 640 □

Cm 42 x 24 x H. 13,5 ø 15 Cm Lt 0,5

**Set 2 coppe macedonia refrigerate**

Thermal fruit-salad set, 2-bowl
 Set 2 bols salade de fruits réfrigérés
 Set 2 boles macedonia de frutas refrigerados
 Thermo-Fruchtsalatschale 2 Stck. schwarz

305 05 52 637 ■
 305 45 52 637 □

Cm 55 x 34,5 x H 16 ø 23 Cm Lt 1,8

**Coppa macedonia refrigerata**

Thermal fruit salad bowl
 Rafrâchisseur salade de fruits
 Bol macedonia de frutas refrigerado
 Thermo-Fruchtsalatschale

305 05 52 641 ■
 305 45 52 641 □

Cm 30 x 30 x H 16 ø 23 Cm Lt 1,8

**Supporto alto per 3 coppette**

3-bowl podium, tall
 Support haut à 3 coupelles
 Soporte alto para 3 boles
 Buffetständer 3 Bowlst

	Cm	H. Cm	ø Cm	Lt.
305 05 54 580 ■	42,5	15	19	12
305 45 54 580 □				0,25

Supporto basso per 3 coppette

Podium 3-bowl, short
 Support bas à 3 coupelles
 Soporte bajo para 3 boles
 Buffetständer 3 Bowlst

	Cm	H. Cm	ø Cm	Lt.
305 05 54 579 ■	42,5	15	11,5	12
305 45 54 579 □				0,25

**Supporto alto per 2 coppe cereali con coperchio**

2-bowl podium with lids, tall
 Support haut à 2 coupes avec couvercles
 Soporte alto para 2 boles con tapas
 Buffetständer 2 Bowlst mit Deckel

	Cm	H. Cm	ø Cm	Lt
305 05 54 607 ■	62	28	30	23
305 45 54 607 □				1,8

Supporto basso per 2 coppe cereali con coperchio

2 bowl podium with lids, short
 Support bas à 2 coupes avec couvercles
 Soporte bajo para 2 boles con tapas
 Buffetständer 2 Bowlst mit Deckel

	Cm	H. Cm	Lt
305 05 54 606 ■	55	28	10
305 45 54 606 □			1,8



B&B

Vassoio formaggi ed affettati refrigerato

Thermal cheese/cold cuts tray
 Plateau à fromage/charcuterie réfrigéré
 Bandeja quesos/embutidos refrigerada
 Thermo-Aufschnittplatte

	Cm	H. Cm
305 05 54 577 ■	55 x 34,5	20
305 45 54 577 □		

**Cestino pane acciaio inox**

Bread basket with roll-top cover
 Corbeille à pain avec couvercle roll-top
 Cesta pan con tapa roll-top
 Brotkorb mit Rolltop

	Cm	H. Cm
305 05 52 650 ■	55 x 34,5	25
305 45 52 650 □		

**Vassoio refrigerato, eutettici a richiesta**

Thermal tray, ice packs on demand
 Plateau réfrigéré, blocs réfrigérants sur demande
 Bandeja refrigerada, acumuladores de frío disponibles
 Thermo-Platte, Kühlelemente auf Anfrage

	Cm	H. Cm
305 05 52 699 ■	55 x 34,5	4
305 45 52 699 □		

**Cestino portapane con cloche**

Bread basket with roll-top cover
 Corbeille à pain avec couvercle roll-top
 Cesta pan con tapa roll-top
 Rattan Brotkorb mit Rolltop

	Cm	H. Cm
305 05 52 642 ■	55 x 34,5	30
305 45 52 642 □		

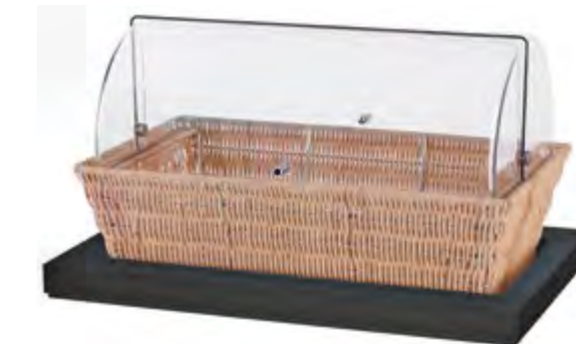
**Vassoio yogurt Zeta refrigerato con ghiaccio**

Zeta ice thermal yogurt tray
 Plateau à yaourts réfrigéré à glace Zeta
 Bandeja yogures refrigerable con hielo Zeta
 Joghurtablett Zeta, mit Eis kühlbar

	Cm	H. Cm
305 05 52 638 ■	55 x 34,5	4
305 45 52 638 □		

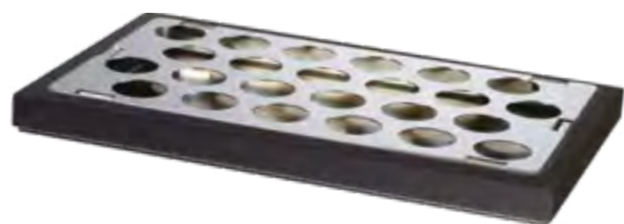
**Tagliere pane con base**

Bread cutting board with base
 Planche à pain avec plateau
 Tabla de cortar con base
 Brotschneidebrett

	Cm	H. Cm
305 05 54 578 ■	55 x 34,5	6
305 45 54 578 □		



Scaldabrioche

Croissant warmer
 Chauffe-croissants
 Calienta croissants
 Croissantwärmer



Cm H. Cm
 55 x 34,5 24,3

305 05 52 651 ■
 305 45 52 651 □



Alzata filo per basi GN 1/1

Wire stand for GN 1/1
 Support en fil pour GN 1/1
 Soporte en hilo para GN 1/1
 Buffetständer mit GN 1/1 Einsatz

Cm H. Cm
 305 05 42 597 57,5 x 35,8 27,6



Supporto con schermo igienico GN 1/1

Stand with hygienic shield
 Ecran hygiénique
 Pantalla higiénica
 Buffetständer mit Hygieneplatte

Cm
 305 12 53 609 59 x 34,4



Alzata torta con cloche

Cake stand with roll-top cover
 Présentoir à gâteaux avec couvercle roll-/top
 Presentación tarta con tapa roll-top
 Tortenplatte mit Rolltop

305 05 42 600 ■
 305 45 42 600 □

piatto/dish ø Cm Base Cm H. Cm
 base/base 38 18 x 18 37,2



Coppa punch

Punch bowl
 Bol à punch
 Champañera
 Punch Bowl

305 05 43 613 ■
 305 45 43 613 □

ø Cm Base Cm H. Cm
 40 18 x 18 33



Vassoio multifunzione acciaio inox

Multipurpose tray
 Plateau multi-usage
 Bandeja multiuso
 Multifunktionstablett

305 05 52 652 ■
 305 45 52 652 □

Cm H. Cm
 55 x 34,5 4



Vassoio multifunzione

Multipurpose tray
 Plateau multi-usage
 Bandeja multiuso
 Multifunktionstablett

305 05 52 654 ■
 305 45 52 654 □

Cm H. Cm
 30 x 30 4



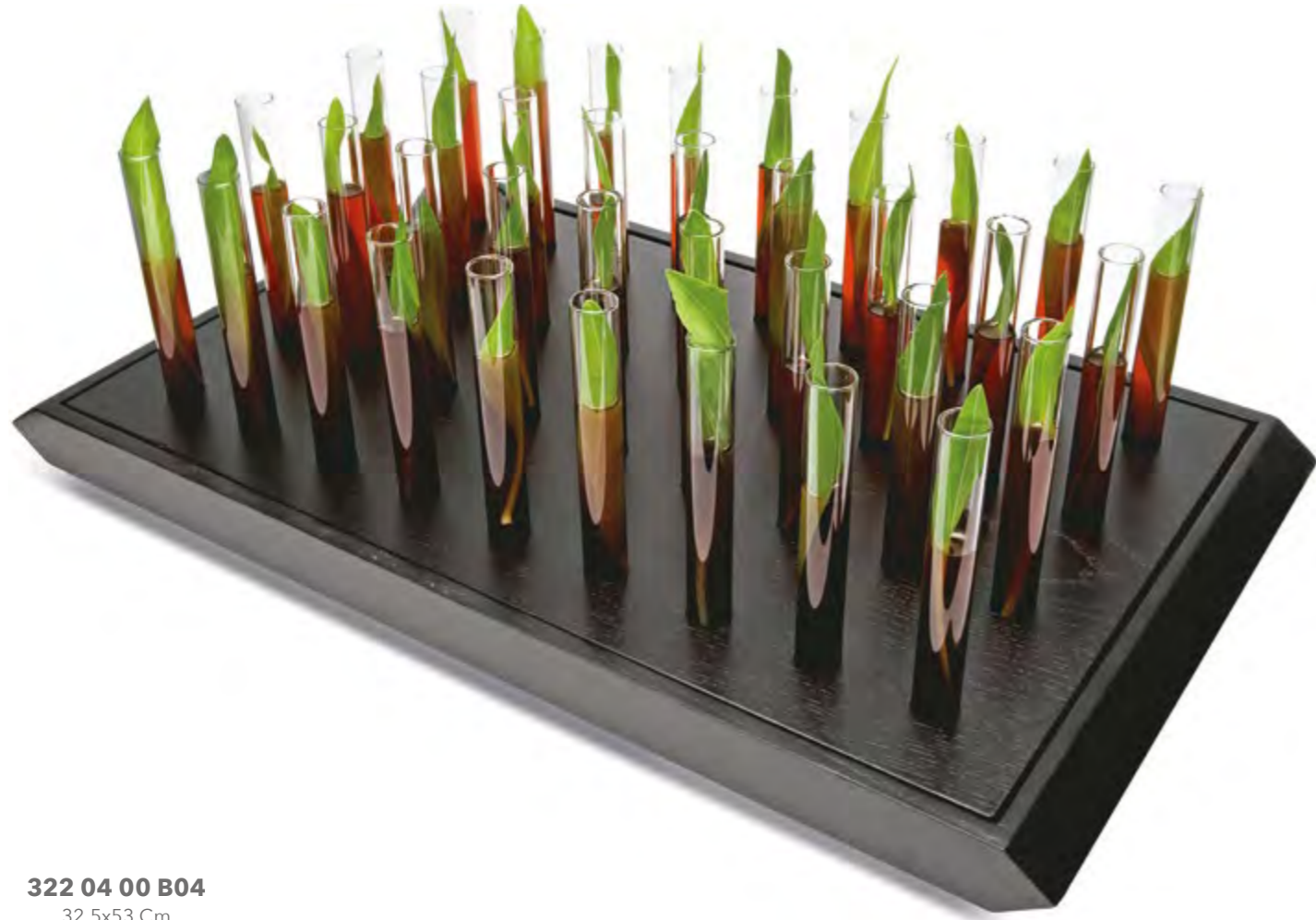

322 04 00 B04
32,5x53 Cm



322 04 00 B01
32,5x53 Cm



322 04 00 B06
32,5x53 Cm



322 04 00 B05
32,5x53 Cm



322 04 00 B02
32,5x53 Cm



322 04 00 B07
32,5x53 Cm



322 04 00 B03
32,5x53 Cm



BRUNCH

SET 1

Manhattan Tower
Tower Manhattan
Tower Manhattan
Manhattan Tower

	Cm	H Cm
305 05 52 A01	140 x 42	65



SET 2

Manhattan Tower
Tower Manhattan
Tower Manhattan
Manhattan Tower

	Cm	H Cm
305 05 52 A02	140 x 42	50



SET 3

Manhattan Tower
Tower Manhattan
Tower Manhattan
Manhattan Tower

	Cm	H Cm
305 05 52 A03	150 x 145	65



SET 4

Manhattan Tower
Tower Manhattan
Tower Manhattan
Manhattan Tower

	Cm
305 05 52 A04	260 x 42



Tower

Tower
Tower
Tower
Tower

	Cm	H. Cm
305 05 42 604	20 x 20	10
305 05 42 605	20 x 20	22
305 05 42 606	20 x 20	34
305 05 42 607	20 x 20	58



Modulo a croce

Cross-shaped extension unit
Croix
Módulo con forma de cruz
Verbindungskreuz

	H. Cm
305 05 42 608	9,5

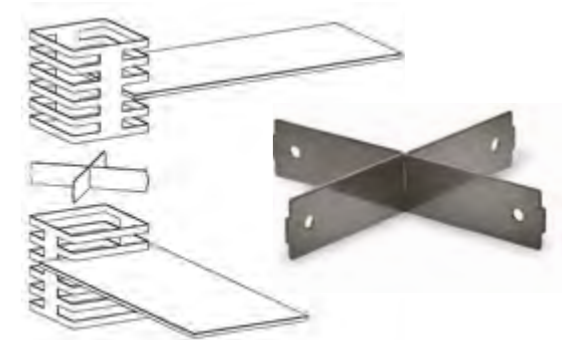

Scala angolare 4 ripiani

4-shelf corner ladder
Etagère angulaire 4 étages
Escalera angular 4 estantes
Eck-Leiter (4 Stufen) Plexiglas

V87 12 42 SA2



Coppa quadrata in plexiglass fumé

Smoky plexiglass salad bowl, square
Bol plexiglass fumé carré
Ensaladera acrílica fumé cuadrada
Salatschale Plexiglas viereckig Smoky

	Cm	H. Cm
V87 12 42 C01	34 x 34	11
V87 12 42 C02	34 x 34	19



Piatto quadrato plexiglass fumé

Smoky plexiglass buffet plate, square
Plat plexiglass fumé carré
Plato acrílico fumé cuadrado
Buffetplatte Plexiglas viereckig Smoky

	Cm
V87 12 42 P01	30 x 30



Manhattan

Piano in vetro fumé

Smoky glass top
 Dessus en verre fumé
 Tablero de cristal fumé
 Glasplatte Smoky

	Cm
V87 08 42 Q01	30 x 30
V87 08 42 Q02	42 x 42
V87 08 42 R01	30 x 70
V87 08 42 R02	30 x 100
V87 08 42 R03	42 x 70
V87 08 42 R04	42 x 100

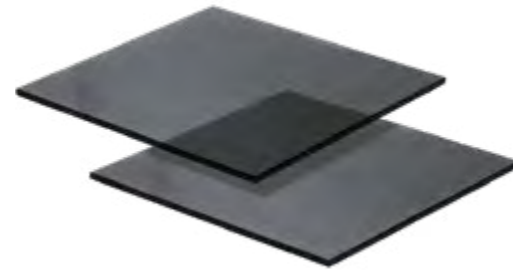

Piano in ardesia

Slate top
 Dessus en ardoise
 Tablero de pizarra
 Schieferplatte

	Cm
V87 09 42 Q01	30 x 30
V87 09 42 Q02	42 x 42
V87 09 42 R01	30 x 70
V87 09 42 R02	30 x 100
V87 09 42 R03	42 x 70
V87 09 42 R04	42 x 100



Piano in mdf

Mdf top
 Dessus en mdf
 Tablero de mdf
 Mdf Platte

	Cm
V87 04 42 Q01	30 x 30
V87 04 42 Q02	42 x 42
V87 04 42 R01	30 x 70
V87 04 42 R02	30 x 100
V87 04 42 R03	42 x 70
V87 04 42 R04	42 x 100



Totem

Totem
 Totem
 Totem
 Totem

	Cm	H. Cm
305 05 42 609	24 x 24	14
305 05 42 610	24 x 24	22
305 05 42 611	32,5 x 32,5	14
305 05 42 612	32,5 x 32,5	22

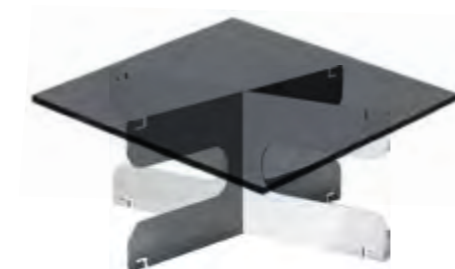

Caratteristiche tecniche

- A** Asportabilità del coperchio a 90° con estrema facilità.
- B** Coperchio leggero e facilmente maneggiabile.
- C** Blocco automatico dell'estrazione del coperchio in fase di lavoro (da 0° a 89°).
- D** Chiusura e apertura frenata del coperchio. Sistema di cerniere brevettate Abert
- E** Superati i 70° il coperchio si apre completamente lasciandolo andare.
- F** La cerniera è un meccanismo a molla, inalterabile nel tempo, non necessita di regolazione e di manutenzione in quanto non ha frizione.
- G** Tutti i meccanismi sono costruiti in pregiati materiali inossidabili, quindi resistenti alla corrosione, agli ambienti umidi e adatti al contatto con gli alimenti. Lo scaldavivande è progettato per raccogliere la condensa in modo da lasciare il piano di appoggio completamente asciutto.
- H** Può essere utilizzato sia con riscaldamento elettrico sia con fornelli a combustibile solido.

Technical characteristics

- A** Easily removable cover, at 90°.
- B** Light and easy-to-handle cover.
- C** Automatic block of cover pull out when in operation (from 0° to 89°).
- D** Closing and opening slowed by cover. Abert patented system.
- E** Over 70° the cover opens fully when released.
- F** The hinge is a spring mechanism, inalterable in time, it does not need regulation and maintenance as it has no clutch.
- G** All the machineries are built in refined stainless materials, thus resistant to corrosion, humid environment and suitable for food contact.
- H** The chafing dish is designed to collect condensation, in order to keep the support base completely dry.
- I** Both electric warming and solid-fuelburners can be used.



Piastra elettrica Gn 2/3

Electric plate for ø Cm 30-40 round chafing dish
Élément électrique pour chafing-dish rond ø Cm 30-40
Elemento eléctrica para chafing dish redondo ø Cm 30-40
Elektroelement für runden Chafing Dish ø Cm 30-40
 305 05 52 546
 305 05 52 611 con regolatore - with regulator

Piastra elettrica Gn 1/1

Electric hot plate
Plaque électrique
Placa eléctrica
Elektrische Platte
 305 05 52 547
 305 05 52 610 con regolatore - with regulator

Fornelletto per scaldavivande

Chafing-dish burner
Porte brûleur pour chafing dish
Contenedor de combustible para chafing dish
Brennstoffhalter für Chafing Dish
 305 05 52 536

Combustibile per scaldavivande

Solid fuel for chafing dish burner
Combustible pour chafing dish
Combustible para chafing dish
Brennstoff für Chafing Dish
 305 05 72 519



Scaldavivande con gambe e coperchio in acciaio inox

Chafing dish with St. Steel stand and cover
Chafing dish avec support et couvercle en acier inox
Chafing dish con soporte y tapa en acero inox
Chafing Dish mit Beinen und Edelstahldeckel

	Cm	H Cm
GN 1/1		
305 05 52 670	63 x 42	31
GN 2/3		
305 05 52 675	46 x 42	32

Completo di due fornelli a combustibile solido e predisposto per piastra elettrica.
 Portavivande GN 1/1 in acciaio incluso

With 1/1 Gastronorm food pan and two solid fuel burners.
Electric heating element available.



Scaldavivande con gambe e coperchio acciaio inox/vetro

Chafing dish with St. Steel/glass stand and cover
Chafing dish avec support et couvercle en acier inox / verre
Chafing dish con soporte y tapa en acero inox / vidrio
Chafing Dish mit Beinen und Edelstahl / Glass deckel

	Cm	H Cm
GN 1/1		
305 05 52 679	63 x 43	33
GN 2/3		
305 05 52 683	46 x 42	32

Completo di due fornelli a combustibile solido e predisposto per piastra elettrica.
 Portavivande GN 1/1 in acciaio incluso

With 1/1 Gastronorm food pan and two solid fuel burners.
Electric heating element available.



Scaldavivande da incasso con coperchio in acciaio inox / vetro

Built-in chafing dish with St. Steel / glass cover
 Chafing dish encastrable avec couvercle en acier inox / verre
 Chafing dish para empotrar con tapa en acero inox / vidrio
 Chafing Dish zum Einbauen mit Edelstahl / Glass Deckel

	Cm	H Cm
GN 1/1		
305 05 52 692	60,5 x 40	39,5
GN 2/3		
305 05 52 694	43 x 40	21

Refrigerato / Thermal

GN 1/1		
305 05 52 705	60,5 x 40	39,5

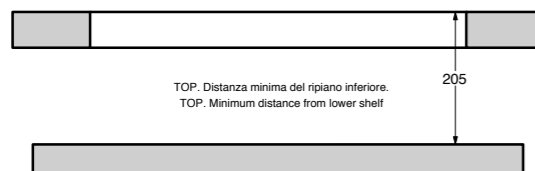
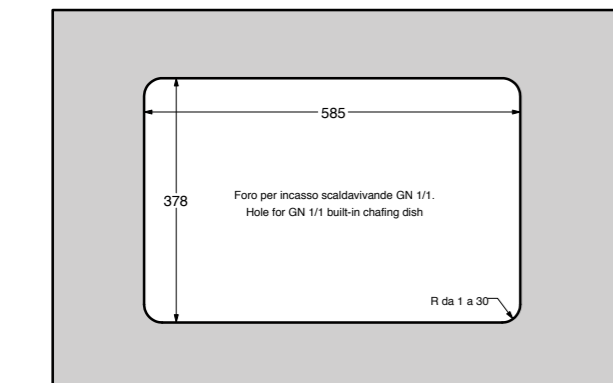
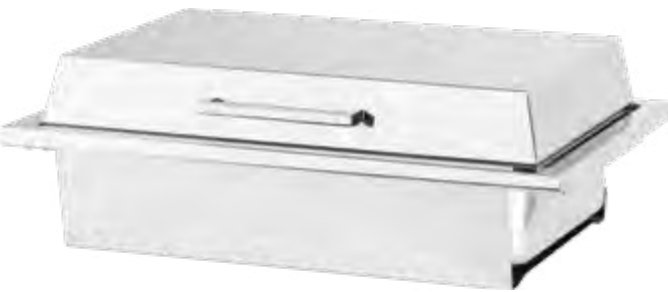

Scaldavivande da incasso con coperchio in acciaio inox

Built-in chafing dish with St. Steel cover
 Chafing dish encastrable avec couvercle en acier inox
 Chafing dish para empotrar con tapa en acero inox
 Chafing Dish zum Einbauen mit Edelstahl Deckel

	Cm	H Cm
GN 1/1		
305 05 52 693	60,5 x 40,5	39,5
GN 2/3		
305 05 52 695	43 x 40	21

Refrigerato / Thermal

GN 1/1		
305 05 52 706	60,5 x 40,5	39,5

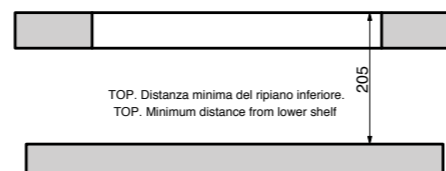
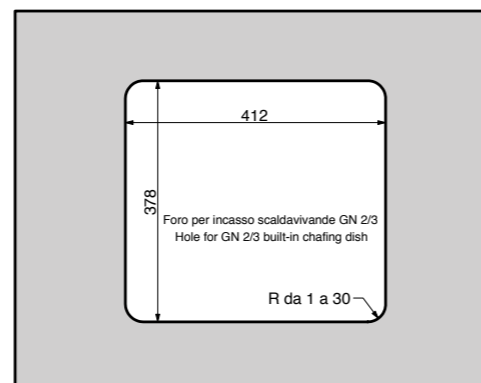

Scaldavivande a incastro GN 1/1

GN 1/1 built-in chafing dish
 Chafing dish encastrable GN 1/1
 Chafing dish empotrable GN 1/1
 Eingebautes Chafing Dish GN 1/1

305 05 52 665
 Con coperchio in acciaio inox
 With Stainless steel cover

305 05 52 678
 Con coperchio in vetro
 With glass cover

Completo di due fornelli a combustibile solido e predisposto per piastra elettrica. Portavivande GN 1/1 in acciaio incluso. Supporti Manhattan esclusi

With 1/1 Gastronorm food pan and two solid fuel burners. Electric heating element available. Manhattan stand excluded



Set refrigerato a incastro GN 1/1

GN 1/1 built-in thermal set
 Set réfrigéré encastrable GN 1/1
 Set refrigerado empotrable GN 1/1
 Eingebautes Thermo-Einsatz GN 1/1

305 05 52 698
 Con coperchio in vetro
 With glass cover

Set refrigerato GN 1/1 H.7,2 Cm completo di bacinella in acciaio inox, griglia in acciaio inox, eutettici, vassoio GN 1/1 H.Cm 2 in acciaio inox. Supporti Manhattan esclusi

Thermal set GN 1/1 H. 7,2 Cm with St. Steel pan, St. Steel grid, ice packs, St. Steel tray GN 1/1 H. Cm 2. Manhattan stand excluded

Coperchio GN 1/1 in acciaio inox

GN 1/1 stainless steel cover
Couvercle en acier inox GN 1/1
Tapa de acero inox GN 1/1
Edelstahldeckel GN 1/1

G03 05 52 665 H 7,2 Cm



Coperchio GN 1/1 in vetro

GN 1/1 glass cover
Couverche en verre GN 1/1
Tapa de vidrio GN 1/1
Glasdeckel GN 1/1

G03 05 52 670 H 7,2 Cm



Griglia

Grid
Grille
Reja
Gittereinsatz

B4 705 52 668 H 2 Cm

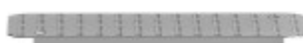

Eutettico

Ice pack
Bloc réfrigérant
Acumulador de frío
Kühlakku

V77 12 95 G00



Portavivande GN 1/1 acciaio inox

Food pan
Bac
Cubeta
Einsatz

305 05 72 511 H 6,5 Cm - acciaio Inox



Bacinella GN 1/1 acciaio inox

Pan
Bassine
Cubeta
Einsatz tief

305 05 52 666

305 05 52 671



Supporto per set refrigerato

Stand for thermal set
Support pour set réfrigéré
Soporte para set refrigerado
Ständer für Thermo-Einsatz

G25 05 52 670



Inserto GN 1/1 in acciaio inox

Food pan, GN 1/1 18/10, stainless steel

V01 05 72 G11B H. 6,5 Cm



Vassoio GN 1/1 in acciaio inox

Tray, Gn 1/1, stainless steel

V01 05 72 G11 H. 2 Cm



Inserto GN 2/3 in acciaio inox

Food pan, GN 2/3 18/10, stainless steel

V01 05 72 G23B H. 6,5 Cm



Inserto GN 1/3 in acciaio inox

Food pan, GN 1/3 18/10, stainless steel

V01 05 72 G13B H. 6,5 Cm



Inserto GN 1/2 in acciaio inox

Food pan, GN 1/2 18/10, stainless steel

V01 05 72 G12B H. 6,5 Cm



Inserto GN 1/1 in porcellana

Food pan, GN 1/1, porcelain

305 21 52 557 H. 6,5 Cm



Inserto GN 1/1 in porcellana

Food pan, GN 1/1, porcelain

3052152672 H. 2 Cm



Inserto GN 2/3 in porcellana

Food pan, GN 2/3, porcelain

305 21 52 583 H. 6,5 Cm



Inserto GN 1/2 in porcellana

Food pan, GN 1/2, porcelain

305 21 52 581 H. 6,5 Cm



Inserto GN 1/3 in porcellana

Food pan, GN 1/3, porcelain

305 21 52 582 H. 6,5 Cm



Piatto piano quadrato in porcellana

Square flat plate, porcelain

263 33 42 649 22x22 Cm



Piatto fondo quadrato in porcellana

Square deep plate, porcelain

263 33 42 130 22x22 Cm





MEET TIME

COD. 305 07..... acciaio argentato - electro-plated stainless steel (EPSS)
 COD. 305 03..... acciaio argentato e ottone - electro-plated stainless steel (EPSS) and brass
 COD. 305 05..... acciaio e ottone - stainless steel and brass
 COD. 305 55..... acciaio inossidabile - stainless steel

Distributore caffè linea Iseo

Iseo coffee urn
 Distributeur de café Iseo
 Dispensador de café Iseo
 Kaffeedispenser Iseo

	Cm	Lt
305 55 52 553	25 x 32 x 51	7
305 55 52 584	25 x 32 x 61	10

Con cloche rotante (180°) a scomparsa, fornito di portavivande 1/1 Gastronorm e due bruciatori a combustibile solido.
 Predisposto per piastra elettrica.

With revolving foldaway dome opening at 180°, 1/1 Gastronorm food pan and two solid fuel burners. Electric heating element available.



Distributore succhi linea Iseo

Iseo juice dispenser
 Distributeur de jus Iseo
 Dispensador de zumo Iseo
 Saftspender Iseo

	Cm	Lt
305 55 52 590	25 x 34 x 65	8

COD. 305 07..... acciaio argentato - electro-plated stainless steel (EPSS)
 COD. 305 03..... acciaio argentato e ottone - electro-plated stainless steel (EPSS) and brass
 COD. 305 05..... acciaio e ottone - stainless steel and brass
 COD. 305 55..... acciaio inossidabile - stainless steel



COD. 305 07..... acciaio argentato - electro-plated stainless steel (EPSS)
 COD. 305 03..... acciaio argentato e ottone - electro-plated stainless steel (EPSS) and brass
 COD. 305 05..... acciaio e ottone - stainless steel and brass
 COD. 305 55..... acciaio inossidabile - stainless steel

Scaldavivande rettangolare linea Iseo

Iseo rectangular chafing dish
 Chafing dish rectangulaire Iseo
 Chafing dish rectangular Iseo
 Chafing Dish Iseo, rechteckig

	Cm	In.	Cm	H Cm
305 .. 52 615	1/1	1/1	68 x 51	45

Scaldacaffè a combustibile solido, predisposto per piastra elettrica

Coffee urn solid fuel burner, electric heating element available as optional.



Scaldavivande tondo linea Iseo

Iseo round chafing dish
 Chafing dish rond Iseo
 Chafing dish redondo Iseo
 Chafing Dish Iseo, rund

	ø Cm	ø In.	Cm	H Cm
305 .. 52 616	30	11,3/4	43 x 43	38
305 .. 52 617	40	15,3/4	52 x 52	46

Con cloche rotante (180°) a scomparsa, fornito di portavivande Gastronorm e due bruciatori a combustibile solido.
 Predisposto per piastra elettrica.

With revolving foldaway dome opening at 180°, Gastronorm food pan and two solid fuel burners. Electric heating element available.



Caraffa vetro acqua frizzante con coperchio basculante

Sparkling water glass pitcher with smart lid
Carafe en verre à eau gazeuse avec couvercle basculant
Jarra de vidrio agua con gas con tapa basculante
Wasser Karaffe (Kohlen säüve) mit Kippen Kappe

	Lt	Oz
305 05 08 549	1	35



Caraffa vetro con coperchio basculante

Water glass pitcher with smart lid
Carafe en verre avec couvercle basculant
Jarra de vidrio con tapa basculante
Wasser Karaffe mit Kippen Kappe

	Lt	Oz
305 05 08 548	1	35



Caraffa termica

Insulated beverage server
Pot isotherme
Jarra térmica
Termische Karaffe

	Lt	Oz
305 05 08 540	0,60	21
305 05 08 541	1,00	35
305 05 08 542	1,50	53



Caraffa termica conica

Insulated beverage server
Pot isotherme
Jarra térmica
Termische Karaffe

	Lt	Oz
305 05 08 557	0,30	10
305 05 08 558	0,60	21
305 05 08 559	1,00	35
305 05 08 560	1,50	53



Caraffa succhi con coperchio

Juice pitcher with lid
Carafe à jus avec couvercle
Jarra zumo con tapa
Saftkrug mit Deckel

	Lt	Oz
305 05 08 539	1,5	53



Caraffa succhi

Juice pitcher
Carafe à jus
Jarra zumo
Saftkrug
 (Argentata - silver plated)

	Lt	Oz
310 07 08 546	2,0	70



Caraffa termica cilindrica

Thermal beverage server
Pot isotherme
Jarra térmica
Termische Karaffe

Acciaio inossidabile - St. Steel

	Lt	Oz
305 05 08 540	0,60	21
305 05 08 541	1,00	35
305 05 08 542	1,50	53

coperchio black - black lid

305 42 08 ...

coperchio copper - copper lid

305 40 08 ...

coperchio gold - gold lid

305 41 08 ...



Caraffa termica conica

Thermal beverage server
Pot isotherme
Jarra térmica
Termische Karaffe

Acciaio inossidabile - St. Steel

	Lt	Oz
305 05 08 557	0,30	10
305 05 08 558	0,60	21
305 05 08 559	1,00	35
305 05 08 560	1,50	53

coperchio black - black lid

305 42 08 ...

coperchio copper - copper lid

305 40 08 ...

coperchio gold - gold lid

305 41 08 ...



Portacereali girevole con 3 comparti

Rotating cereal stand, 3 - dish
Distributeur à céréales pivotant à 3 compartiments
Dispensador de cereales giratorio 3 sectores
Büffet-Ständer - drehbar mit drei Glasschalen

	ø Cm	H. Cm	ø In.	H. In.
V77 05 52 CV3	42	43	16,1/2	17

Con coppe in vetro - With glass bowls

	ø Cm	H. Cm	ø In.	H. In.
V77 05 52 CC3	42	43	16,1/2	17

Con coppe in vetro e coperchi in metacrilato
With glass bowls and acrylic lids

**Distributore cereali girevole a 3 comparti con base in acciaio inossidabile**

Rotating cereal dispenser with stainless steel base, triple
Distributeur à céréales pivotant à 3 compartiments avec base en acier inoxydable
Dispensador de cereales giratorio 3 sectores con base de acero inoxidable
3-Müesli-Dispenser-drehbar, mit Edelstahlfuß

	ø Cm	H. Cm	Lt
V77 05 52 CD6	42	60	3 (x3)

	ø In.	H. In.	Oz
	16,1/2	23,5/8	106 (x3)

**Portacereali girevole con 6 comparti**

Rotating cereal stand 6 - dish
Distributeur à céréales pivotant à 6 compartiments
Dispensador de cereales giratorio 6 sectores
Büffet-Ständer - drehbar mit sechs Glasschalen

	ø Cm	H. Cm	ø In.	H. In.
V77 05 52 CV6	42	73	16,1/2	28,3/4

Con coppe in vetro - With glass bowls

	ø Cm	H. Cm	ø In.	H. In.
V77 05 52 CC6	42	73	16,1/2	28,3/4

Con coppe in vetro e coperchi in metacrilato
With glass bowls and acrylic lids

**Distributore cereali con base in acciaio inossidabile**

Cereal dispenser with stainless steel base
Distributeur céréales avec base en acier inoxydable
Dispensador de cereales con base de acero inoxidable
Müesli-Dispenser mit Stahlbochen

	Cm	H. Cm	Lt
V77 05 52 CD4 - Singolo - Single	31 x 21	56	3

	In.	H. In.	Oz
	12,1/4 x 8,1/4	22	106

	Cm	H. Cm	Lt
V77 05 52 CD5 - 2 comparti - Double	37,5 x 24,5	57	3 (x2)

	In.	H. In.	Oz
	14,3/4 x 9,5/8	22,1/2	106 (x2)



Portaformaggi / affettati rettangolare non refrigerato - piano in polietilene

Rectangular cheese / cold cuts dish, non-thermal - Polyethylene board
 Plateau fromage / charcuterie rectangulaire non réfrigéré - Planche en polyéthylène
 Quesera rectangular no refrigerante - Tabla de polietileno
 Käse/Wurstwarenplatte - rechteckig, nicht gekühlt, Platte aus Acryl

	Cm	In.
V77 05 54 G11	53 x 32,5	20,7/8 x 12,3/4

**Portaformaggi / affettati tondo non refrigerato - piano in polietilene**

Round cheese / cold cuts dish, non-thermal - Polyethylene board
 Plateau fromage / charcuterie rond non réfrigéré - Planche en polyéthylène
 Quesera redonda no refrigerante - Tabla de polietileno
 Käse/Wurstwarenplatte - rund, nicht gekühlt, Platte aus Acryl

	ø Cm	ø In.
V77 05 54 T46	46	18,1/8

**Portaformaggi / affettati rettangolare refrigerato - piano in polietilene**

Rectangular cheese / cold cuts dish, thermal - Polyethylene board
 Plateau fromage / charcuterie rectangulaire réfrigérant - Planche en polyéthylène
 Quesera rectangular refrigerante - Tabla de polietileno
 Käse/Wurstwarenplatte - rechteckig, gekühlt, Platte aus Acryl

	Cm	In.
V77 05 54 G11 R	53 x 32,5	20,7/8 x 12,3/4

**Portaformaggi / affettati tondo refrigerato - piano in polietilene**

Round cheese / cold cuts dish, thermal - Polyethylene board
 Plateau fromage / charcuterie rond réfrigérant - Planche en polyéthylène
 Quesera redonda refrigerante - Tabla de polietileno
 Käse/Wurstwarenplatte - rund, gekühlt, Platte aus Acryl

	ø Cm	ø In.
V77 05 54 T46 R	46	18,1/8

**Portaburro tondo**

Butter cooler, round
 Beurrier rond
 Mantequera redonda
 Butterkühler, rund

	ø Cm	H. Cm	ø In.	H. In.
V77 05 09 T46	46	5	18,1/8	2
V77 05 09 T32	32	6	12,5/8	2,3/8

**Portayogurt tondo**

Yogurt dish, round
 Plateau porte-yogourt rond
 Bandeja yogurt redonda
 Joghurtplatte, rund

	ø Cm	H. Cm	ø In.	H. In.
V77 05 52 T46	46	5	18,1/8	2

**Rinfresca yogurt / macedonia**

Yogurt / fruit salad cooler
 Rafrâchisseur à yogourt / salade de fruits
 Bol yogur / macedonia refrigerado
 Obstsalat / Joghurtschale, gekühlt

	ø Cm	ø In.
305 05 43 601	28	11,1/8
310 12 15 790		

Coperchio metacrilato - Acrylic lid
 310 08 42 527

Coppa in vetro - Glass bowl

**Coperchio in metacrilato con pomolo in metallo per rinfresca yogurt/macedonia**

Acrylic lid with metal knob for fruit/salad cooler
 Couvercle acrylique avec pommeau en métal pour rafraîchisseur
 Tapa acrílica con pomo en metal para el macedonia/yogurt refrigerado
 Deckel aus Metakryl mit Metalknopf für joghurt/fruchtsalat kühltschale

	ø Cm	ø In.
310 12 15 790	23	9



Portaprosciutto con base in marmoHam holder with marble base
Porte-jambon avec base en marbre
Jamonero con base de mármol
Schinkenbasis aus Marmor

	Cm	In.
305 05 91 657	22 x 58 x 18	8,5/8 x 22,7/8 x 7

**Piatta salmone (argentato / legno)**Salmon cutting board (electro-plated stainless steel and wood)
Planche à saumon (acier argenté et bois)
Fuente salmón (acero plateado y madera)
Lachsplatte, versilbert mit Holz

	Cm	In.
305 07 22 656	87 x 19	34,1/4 x 7,1/2

**Cestino portabrioche tondo**Croissant basket, round
Corbeille ronde à viennoiseries
Cesta de buffet redonda
Büffetkorb, rund

	ø Cm	ø In.
V77 04 52 T44	44	17,3/8

**Cestino portabrioche rettangolare**Croissant basket, rectangular
Corbeille rectangulaire à viennoiseries
Cesta de buffet rectangular
Büffetkorb, rechteckig

	Cm	In.
V77 04 52 R50	50 x 29,5	19,3/4 x 11,5/8

**Supporto refrigerato con caraffe succhi (4 pz.) Con alzata**Thermal stand with juice pitchers (4 - pc) with plate
Présentoir réfrigéré avec carafes à jus (4 - pcs) avec étagère
Expositor refrigerante con jarras de zumo (4 pzs) con plato
Saftkaraffenständer, gekühlt mit gläserständer

	H. Cm	H. In.
V77 05 52 SCA	70	27,1/2
	ø 41,5 base	ø 16,3/8 base
	ø 38,5 alzata	ø 15,1/8 plate
	ø 16,4 Sede caraffa	ø 6,1/2 pitcher seat
	Lt	Oz
400 04 79 300 Brocca acqua - Water pitcher	1,5	53

**Supporto refrigerato con caraffe succhi (4 pz.)**Thermal stand with juice pitchers (4 - pc)
Présentoir réfrigéré avec carafes à jus (4 - pcs)
Expositor refrigerante con jarras de zumo (4 pzs)
Saftkaraffenständer, gekühlt

	H. Cm	H. In.
V77 05 52 SCA 1	36	14,1/8
	ø 41,5 base	ø 16,3/8 base
	ø 16,4 Sede caraffa	ø 6,1/2 pitcher seat
400 04 79 300 Brocca acqua - Water pitcher	1,5	53



Vassoio torta con bascula

Cake tray with rolltop cover
 Plateau à gateaux avec couvercle
 Bandeja tarta con tapa
 Orntablett mit speseglocke

	ø Cm	ø In.
305 05 42 602	37	14,1/2

**Alzata torta con bascula**

Cake stand with rolltop cover
 Presentoir à gateaux avec couvercle
 Soporte tarta con tapa
 Tortenplatte

	ø Cm	ø In.
305 05 42 601	37	14,1/2

**Alzata torta**

Cake stand
 Presentoir à gateaux
 Soporte tarta
 Tortenplatte

	ø Cm	ø In.
305 05 42 516	22	8,5/8
305 05 42 517	32	12,5/8
305 05 42 518	42	16,1/2

**Alzata frutta 3 piani**

Fruit stand, 3 - tier
 Plat à fruits sur pied, 3 étages
 Frutero, 3 pisos
 Obstständler, 3 stufig

	ø Cm	H. Cm
305 05 42 523	22 - 29 - 36,5	50
	ø In.	H. In.
	8,5/8 - 11,1/2 - 14,3/8	19,3/4

**Alzata torta nuziale**

Wedding cake stand
 Presentoir à gâteaux de mariage
 Soporte tarta nupcial
 Hochzeitstortenplatte

	ø Cm	H. Cm
305 05 42 519	22 - 32 - 42	54
	ø In.	H. In.
	8,5/8 - 12,5/8 - 16,1/2	21,1/4



COD. 303 07..... acciaio argentato - electro-plated stainless steel (EPSS)
 COD. 303 03..... acciaio argentato e ottone - electro-plated stainless steel (EPSS) and brass
 COD. 303 05..... acciaio e ottone - stainless steel and brass
 COD. 303 55..... acciaio inossidabile - stainless steel

COD. 303 07..... acciaio argentato - electro-plated stainless steel (EPSS)
 COD. 303 03..... acciaio argentato e ottone - electro-plated stainless steel (EPSS) and brass
 COD. 303 05..... acciaio e ottone - stainless steel and brass
 COD. 303 55..... acciaio inossidabile - stainless steel

Distributore caffè linea classica

Classica coffee urn
 Distributeur de café Classica
 Dispensador de café Classica
 Kaffeedispenser Classica

	Lt	Oz	Cm	H. Cm
303 ... 52 549	7	245	32 x 25	53
303 ... 52 550	10	350	24 x 32	52



Distributore succhi linea classica

Classica juice dispenser
 Distributeur de jus Classica
 Dispensador de zumo Classica
 Saftspender Classica

	Lt	Oz	Cm	H. Cm
303 ... 52 603	8	280	25 x 36	72



Scaldavivande tondo linea Classica

Classica round chafing dish
 Chafing dish rond Classica
 Chafing dish redondo Classica
 Chafing Dish Classica, rund

	ø Cm	ø In.
303 .. 52 613	30	11,3/4
303 .. 52 614	40	15,3/4

Con cloche rotante (180°) a scomparsa, fornito di portavivande Gastronorm e due bruciatori a combustibile solido. Predisposto per piastra elettrica.

With revolving foldaway dome opening at 180°, Gastronorm food pan and two solid fuel burners. Electric heating element available.



Scaldavivande rettangolare linea Classica

Classica rectangular chafing dish
 Chafing dish rectangulaire Classica
 Chafing dish rectangular Classica
 Chafing Disch Classica, rechteckig

	GN	In.	Cm	H. Cm
303 .. 52 612	1/1	1/1	67 x 43	45

Con cloche rotante (180°) a scomparsa, fornito di portavivande 1/1 Gastronorm e due bruciatori a combustibile solido. Predisposto per piastra elettrica.

With revolving foldaway dome opening at 180°, 1/1 Gastronorm food pan and two solid fuel burners. Electric heating element available.



Piastra elettrica per distributore caffè



Piastra elettrica rettangolare per scaldavivande GN 1/1



Piastra elettrica per scaldavivande tondo ø Cm 30-40



Fornelletto per scaldavivande



COD. 303 07..... acciaio argentato - electro-plated stainless steel (EPSS)
 COD. 303 03..... acciaio argentato e ottone - electro-plated stainless steel (EPSS) and brass
 COD. 303 05..... acciaio e ottone - stainless steel and brass
 COD. 303 55..... acciaio inossidabile - stainless steel

COD. 303 07..... acciaio argentato - electro-plated stainless steel (EPSS)
 COD. 303 03..... acciaio argentato e ottone - electro-plated stainless steel (EPSS) and brass
 COD. 303 05..... acciaio e ottone - stainless steel and brass
 COD. 303 55..... acciaio inossidabile - stainless steel

Alzata rettangolare linea Classica

Classica rectangular stand
Présentoir rectangulaire Classica
Soporte rectangular Classica
Rechteckiger Ständer, Classica

	Cm	In.	H. Cm.	H. In.
303 .. 52 702	28 x 49	11x19,1/4	21	8,1/4

Vassoio refrigerato - Thermal tray

305 .. 54 611	GN 1/1
---------------	--------



Distributore Aqva con alzata Classica

Aqva dispenser with Classica stand
Distributeur Aqva avec support Classica
Dispensador Aqva con soporte Classica
Aqua Getränkespender mit Ständer Classica

	ø Cm	H cm	ø In	H in
305 55 52 712	27	80	10,5/8	31,1/2

cromato/chromed

305 07 52 712	27	80	10,5/8	31,1/2
---------------	----	----	--------	--------

acciaio argentato/electro-plated stainless steel (EPSS)



Alzata tonda linea Classica

Classica round stand
Présentoir rond Classica
Soporte redondo Classica
Runder Ständer, Classica

	ø Cm	ø In.	H. Cm.	H. In.
303 .. 52 703	22	8,5/8	21	8,1/4

Ciotola in porcellana - porcelain bowl

264 02 53 170	28	11
---------------	----	----



Coppa punch con manici Rubans

Punch bowl with Rubans handles
Bol à punch avec poignées Rubans
Champañera con asas Rubans
Punchschale mit Griff Rubans

	ø Cm	Lt	ø In.	Oz
310 00 43 602	50	20	19,3/4	700





Alzata frutta 2-3-4 piani

Fruit stand, 2-3-4-tier
 Plat à fruits sur pied, 2-3-4 étages
 Frutero, 2-3-4 pisos
 Obststände, 2-3-4 stufig

		ø Cm	H. Cm	ø In.	H. In.
310 00 42 564	(2 piani / 2 tier)	30/25	49	11,3/4-9,7/8	19,5/16
310 00 42 565	(3 piani / 3 tier)	40/30/25	69	15,3/4-11,3/4-9,7/8	27
310 00 42 577	(3 piani / 3 tier)	54/40/30	69	21,1/4-15,3/4-11,3/4	27
310 00 42 571	(4 piani / 4 tier)	54/40/30/25	90	21,1/4-15,3/4-11,3/4-9,7/8	35,3/8

Alzata frutta

Fruit stand
 Plat à fruits sur pied
 Frutero
 Obststände

	ø Cm	ø In.
310 00 42 574	30	11,3/4
310 00 42 539	40	15,3/4
310 00 42 549	54	21,1/4



Alzata frutta

Fruit stand
 Plat à fruits sur pied
 Frutero
 Obststände

	ø Cm	ø In.
310 00 42 535	30	11,3/4



Alzata torta

Cake stand
 Presentoir à gâteaux
 Soporte pastel
 Tortenplatte

	ø Cm	ø In.
310 00 42 526	32	12,5/8



Inserto GN 1/1 in acciaio inox

Food pan, GN 1/1 18/10, stainless steel

V01 05 72 G11B H. 6,5 Cm

Vassoio GN 1/1 in acciaio inox

Tray, Gn 1/1, stainless steel

V01 05 72 G11B H. 2 Cm

Inserto GN 2/3 in acciaio inox

Food pan, GN 2/3 18/10, stainless steel

V01 05 72 G23B H. 6,5 Cm

Inserto GN 1/3 in acciaio inox

Food pan, GN 1/3 18/10, stainless steel

V01 05 72 G13B H. 6,5 Cm

Inserto GN 1/2 in acciaio inox

Food pan, GN 1/2 18/10, stainless steel

V01 05 72 G12B H. 6,5 Cm

Inserto GN 1/1 in porcellana

Food pan, GN 1/1, porcelain

305 21 52 557 H. 6,5 Cm

Inserto GN 1/1 in porcellana

Food pan, GN 1/1, porcelain

3052152672 H. 2 Cm

Inserto GN 2/3 in porcellana

Food pan, GN 2/3, porcelain

305 21 52 583 H. 6,5 Cm

Inserto GN 1/2 in porcellana

Food pan, GN 1/2, porcelain

305 21 52 581 H. 6,5 Cm

Inserto GN 1/3 in porcellana

Food pan, GN 1/3, porcelain

305 21 52 582 H. 6,5 Cm

Set minestre per scaldavivande rettangolare

Soup tureen set for rectangular chafing dish
 Set de soupières pour chafing dish rectangulaire
 Set de soperas para chafing dish rectangular
 Suppenchüsselset für Chafing Dish rechteckig

		Cm	In.
305 05 52 626	Adattatore - Adapter	1/1	1/1
		Lt	Oz
305 05 15 796	Zuppiera - Soup tureen	4,2	142



Portavivande tondo in acciaio inossidabile

Round food pan, stainless steel
 Bac rond en acier inoxydable
 Cubeta redonda en acero inoxidable
 Behälter rund, edelstahl rostfrei

	ø Cm	ø In.
305 05 72 516	30	11,3/4
305 05 72 517	40	15,3/4



Portavivande tondo in porcellana

Round food pan, porcelain
 Bac rond en porcelaine
 Cubeta redonda en porcelana
 Porzellanbehälter, rund

	ø Cm	ø In.
305 21 72 756	30	11,3/4
305 21 52 559	40	15,3/4



Inserto scaldavivande tondo in porcellana

Food pan half round chafing dish, porcelain with divider
 Bac double en porcelaine pour chafing dish rond
 Cubeta en porcelana para chafing dish redondo
 Porzellaninsatz, 2tlg für chafing dish rund

	ø Cm	ø In.
305 21 71 951 (1 Pz.)	40	15,3/4



Portauovo per scaldavivande tondo in porcellana

Egg holder for round chafing dish, porcelain
 Porte-oeufs en porcelaine pour chafing dish rond
 Porta huevos en porcelana para chafing dish redondo
 Porzellanereinsatz für chafing dish rund

	Cm	ø In.
305 21 71 950	40	15,3/4

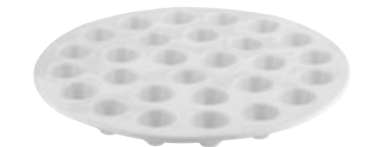

Set zuppiere per scaldavivande tondo Cm 40

Soup tureen set for Cm 40 round chafing dish
 Set de soupières pour chafing dish rond Cm 40
 Set de soperas para chafing dish redondo Cm 40
 Suppenchüsselset für Chafing Dish rund ø Cm 40

	ø Cm	ø In.
305 05 52 627	Adattatore - Adapter	40 15,3/4
		Lt Oz
305 05 15 796	Zuppiera - Souptureen	4,2 142





ITALIO

Cottura - Cooking



Mantenimento del calore - Heat-keeping



Display





Piano in vetroceramica per mantenimento calore

Vitrocereamic top, heat keeping
 Plaque en vitroc eramique pour conserver la chaleur
 Placa de vitrocer mica para el mantenimiento de calor
 Ebene aus Glaskeramik fuer W rmeerhaltung

	Cm	In.
305 05 52 726	60x38,5	23,5/8x15,1/8

Piano a induzione con supporto in acciaio

Induction cooktop with steel countertop
 Plaque   induction avec table de travail en acier
 Placa de inducci n con encimera en acero
 Induktionskochplatte mit Arbeitsplatte Edelstahl

	Cm	In.
305 05 52 725	30x38,5	23,5/8x15,1/8

Compenso in acciaio

Steel countertop
 Table de travail en acier
 Encimera en acero
 Arbeitsplatte Edelstahl

	Cm	In.
305 05 52 727	30x38,5	11,3/4x15,1/8

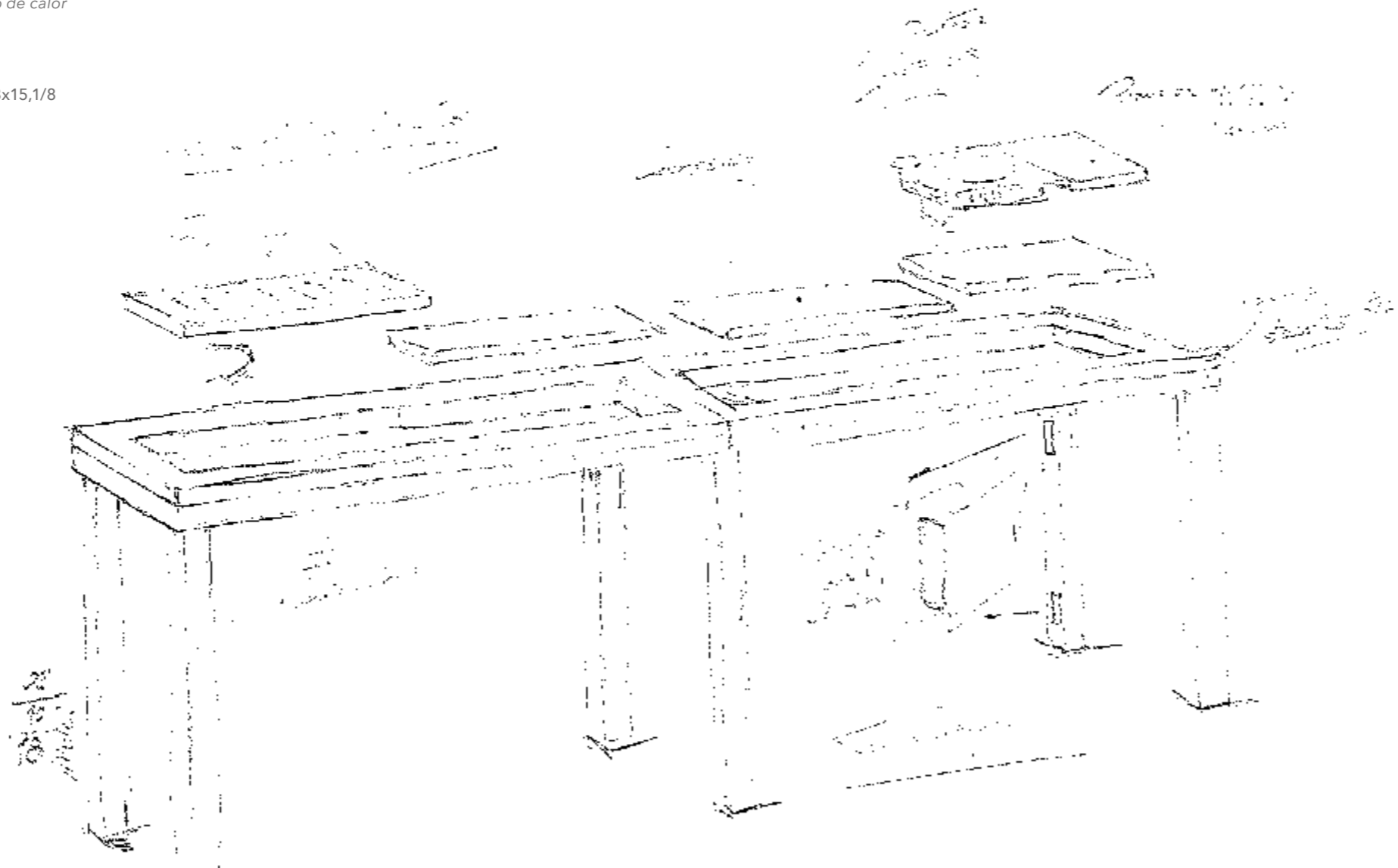

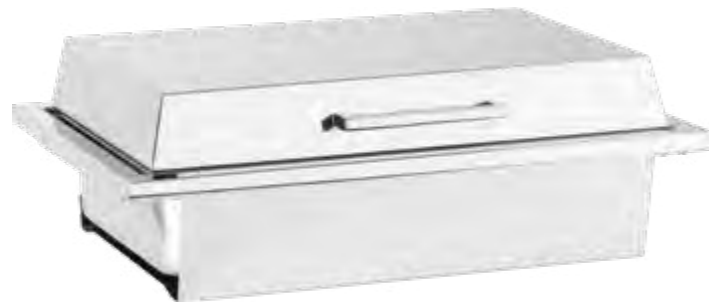

Scaldavivande da incasso con coperchio in acciaio inox

Built-in chafing dish with St. Steel cover
 Chafing dish encastrable avec couvercle en acier inox
 Chafing dish para empotrar con tapa en acero inox
 Chafing Dish zum Einbauen mit Edelstahl Deckel

	Cm	H Cm
GN 1/1		
305 05 52 693	60,5 x 40,5	39,5

Refrigerato / Thermal
 GN 1/1

305 05 52 706	60,5 x 40,5	39,5
---------------	-------------	------

Scaldavivande da incasso con coperchio in acciaio inox /vetro

Built-in chafing dish with St. Steel / glass cover
 Chafing dish encastrable avec couvercle en acier inox / verre
 Chafing dish para empotrar con tapa en acero inox / vidrio
 Chafing Dish zum Einbauen mit Edelstahl / Glass Deckel

	Cm	H Cm
GN 1/1		
305 05 52 692	60,5 x 40	39,5

Refrigerato / Thermal
 GN 1/1

305 05 52 705	60,5 x 40	39,5
---------------	-----------	------



Scaldavivande da incasso con coperchio in acciaio inox

Built-in chafing dish with St. Steel cover
 Chafing dish encastrable avec couvercle en acier inox
 Chafing dish para empotrar con tapa en acero inox
 Chafing Dish zum Einbauen mit Edelstahl Deckel

	Cm	H Cm
GN 2/3		
305 05 52 695	43 x 40	21

Scaldavivande da incasso con coperchio in acciaio inox /vetro

Built-in chafing dish with St. Steel / glass cover
 Chafing dish encastrable avec couvercle en acier inox / verre
 Chafing dish para empotrar con tapa en acero inox / vidrio
 Chafing Dish zum Einbauen mit Edelstahl / Glass Deckel

	Cm	H Cm
GN 2/3		
305 05 52 694	43 x 40	21

Compenso GN 1/3 in laminato

GN 1/3 countertop laminate
 Table de travail GN 1/3 en melamine
 Encimera GN 1/3 en laminado
 Arbeitsplatte GN 1/3

	Cm	In.
305 04 51 709	17,6 x 32,5	6,7/8 x 12,3/4
305 51 51 709	17,6 x 32,5	6,7/8 x 12,3/4





Caratterizzato da un design pulito

e funzionale che lo rende simile a un mobile contemporaneo, il carrello Italo può essere utilizzato come comodo sostegno e mezzo di trasporto per i tavoli opportunamente piegati.

It stands out with a simple design;

trolley Italo can be used as a useful support, as well as a carriage of the tables properly folded.

Carrello

Trolley
Chariot
Carro
Wagen

	Cm	In.
■ 305 51 52 647	115 x 59 H. 89	6,7/8 x 12,3/4

Il carrello è dotato di 3 scaffali

nei quali riporre i prodotti che successivamente verranno disposti sul tavolo. Una volta svuotato, può essere trasformato in un mobile nel quale collocare ordinatamente le stoviglie; può inoltre essere utilizzato come piano di appoggio aggiuntivo al tavolo. Composto da materiali pregiati: acciaio e legno. È in oltre dotato di 4 ruote in acciaio pivotanti e con freno.

Misure: 115 x 59 x H 89 Cm

The trolley contains accommodations and

sections where one can store the products which, after that, will be placed on the table. Once empty, taking off the dividers, it can be transformed in a piece of furniture in which it is possible to store tableware tidily; also, it can be used as an additional countertop besides the table. Made of high-quality materials: steel and wood.

Size: 115 x 59 x H 89 Cm



Carrello

Trolley
Chariot
Carro
Wagen

	Cm	In.
■ 305 04 52 647	115 x 59 H. 89	6,7/8 x 12,3/4



Tavolo 1

Table 1
 Table 1
 Mesa 1
 Tisch 1

Cm 132 x 65
 H Cm 89

- 305 04 51 651
- 305 51 51 651



Tavolo 2+1

Table 2+1
 Table 2+1
 Mesa 2+1
 Tisch 2+1

Chiuso - Closed 132 x 65 H Cm 89
 Aperto - Open 396 x 65 H Cm 89

- 305 04 51 653
- 305 51 51 653



Tavolo 2

Table 2
 Table 2
 Mesa 2
 Tisch 2

Cm 264 x 65
 H Cm 89

- 305 04 51 652
- 305 51 51 652

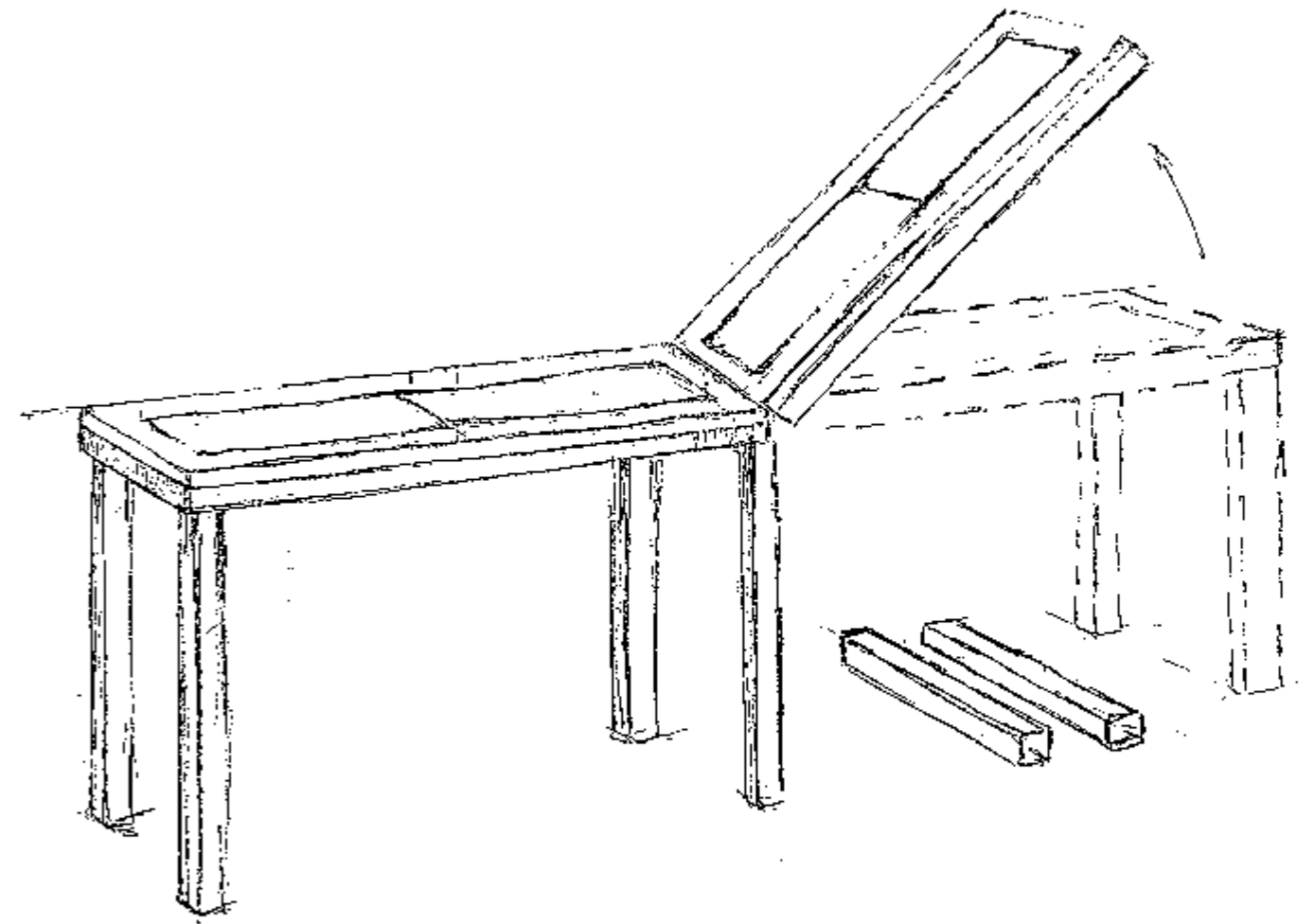

Ogni tavolo e' dotato di due compensi in legno removibili, ciascuno dei quali misura 60x38,5cm, in modo da poter allocare all'interno dei tavoli i seguenti accessori:

- Cahafing dish gn 2/3 + compenso legno
- Cahafing dish gn 1/1
- Piano ad induzione
- Piano per il mantenimento del calore

Each table has two removable wood countertops, whose size is 60x38,5 cm, so that inside the tables the following accessories can be fitted:

- GN 2/3 chafing dish+ wood countertop*
- GN 1/1 chafing dish*
- Induction cooktop*
- Top, heat-keeping*



Possibilita' di avere una o piu' gambe del tavolo adatte a nascondere i cavi elettrici. Tutte le gambe dei tavoli hanno un aggancio semplificato (attraverso due perni facilmente avvitabili senza alcun utensile).

Possibility of having one or more table legs, suitable for hiding the electric cables. All the table legs have a simple coupling (by two pivots, easily screwable by hand).



Gamba elettrificata su richiesta

- Electric leg
- Jambe électrique
- Pata eléctrica
- Elektrische Beine

B35 05 51 652



www.broggi.com